

OWNER HANDBOOK

Giulietta



WHY CHOOSING GENUINE PARTS

We really know your car because we invented, designed and built it: we really know every single detail.

At **Alfa Romeo Service authorised workshops** you can find technicians directly trained by us, offering quality and professionalism for all service operations.

Alfa Romeo workshops are always close to you for the regular servicing operations, season checks and practical recommendations by our experts.

With Alfa Romeo Genuine Parts you keep the reliability, comfort and performance features of your new car unchanged in time: that's why you bought it for.

Always ask for Genuine Parts for the components used on our cars; we recommend them because they come from our steady commitment in research and development of highly innovative technologies.

For all these reasons: **rely on Genuine Parts, because they are the only ones designed by Alfa Romeo for your car.**

SAFETY:
BRAKING SYSTEM

ENVIRONMENT: PARTICULATE FILTERS,
CLIMATE CONTROL MAINTENANCE

COMFORT: SUSPENSION
AND WINDSCREEN WIPERS

PERFORMANCE: SPARK PLUGS,
INJECTORS AND BATTERIES

LINEACCESSORI
ROOF RACK BARS, WHEEL RIMS

**CHOOSING GENUINE PARTS IS
THE MOST NATURAL CHOICE**



PERFORMANCE

GENUINE PARTS

COMFORT

GENUINE PARTS

SAFETY

GENUINE PARTS

AMBIENT

GENUINE PARTS

ACCESSORIES

GENUINE PARTS

VALUES

GENUINE PARTS

HOW TO RECOGNISE GENUINE PARTS

To recognise a **Genuine Part**, check that the component bears our brands, always clearly visible on Genuine Parts, from the braking system to windscreen wipers, from shock absorbers to pollen filter.

All **Genuine Parts** undergo **strict controls**, both during design and manufacturing stages, by specialists using **vanguard materials**, to **test the component reliability**.

This to guarantee **performance** and **safety** for you and your passengers on board, for a long time.

Always ask for and make sure a **Genuine Part** has been used.

Genuine
Parts



Pollen filter

Genuine
Parts

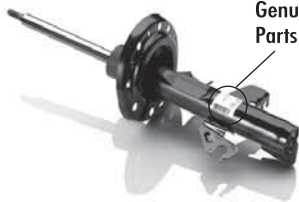

Shock absorber

Genuine
Parts

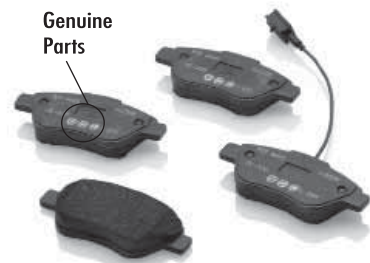

Brake pads

Dear Customer,

We would like to congratulate and thank you for choosing an Alfa Romeo. We have written this handbook to help you get to know all the features of your car and use it in the best possible way. You should read it right through before taking to the road for the first time.

Here you will find information, advice and important warnings regarding use of your car and how to achieve the best performance from the technological features of your Alfa Romeo. It also provides a description of special features and essential information for the care and maintenance of your Alfa Romeo over time as well as for safe driving.

We urge you to read the warnings and indications found throughout the text with care, marked with the following symbols:



personal safety;



car safety;



environmental protection.

NOTE These symbols, when necessary, are indicated at the end of each paragraph and are followed by a number. This number recalls the corresponding warning at the end of the relevant section.

In the attached Warranty Booklet you will also find a description of the Services that Alfa Romeo offers to its customers, the Warranty Certificate and the detail of the terms and conditions for maintaining its validity.

We are sure that these will help you to get in touch with and appreciate your new car and the service provided by the people at Alfa Romeo.

Enjoy reading and happy motoring!

This Owner Handbook describes all versions of the Alfa Giulietta; please consider only the information relevant to your car's trim level, engine and version. All data contained in this publication is purely indicative. FCA Italy S.p.A. can modify the specifications of the vehicle model described in this publication at any time, for technical or marketing purposes. For further information, contact an Alfa Romeo Dealership.

VERY IMPORTANT



REFUELLING



Petrol engines: only refuel with unleaded petrol with octane rating (RON) not less than 95 in compliance with the European specification EN228. **Diesel engines:** refuel only with diesel fuel conforming to the European specification EN590. The use of other products or mixtures may damage the engine beyond repair and consequently invalidate the warranty, due to the damage caused.

STARTING THE ENGINE



Petrol engines: make sure that the handbrake is engaged; set the gear lever to neutral; fully depress the clutch pedal without pressing the accelerator, then turn the ignition key to AVV and release it as soon as the engine has started. **Diesel engines:** turn the ignition key to MAR-ON and wait for the  and  warning lights to switch off. Then turn the ignition key to AVV and release it as soon as the engine has started.

PARKING ON FLAMMABLE MATERIAL



The catalytic converter develops high temperatures during operation. Do not park the car on grass, dry leaves, pine needles or other flammable material: fire hazard.

RESPECTING THE ENVIRONMENT



The car is fitted with a system that carries out a continuous diagnosis of the emission-related components in order to help protect the environment.

ELECTRICAL ACCESSORIES



If, after buying the car, you decide to add electrical accessories (with the risk of gradually draining the battery), contact an Alfa Romeo Dealership. They will calculate the overall electrical requirement and check that the car's electrical system can support the required load.

CODE Card (for versions/markets, where provided)



Keep it in a safe place, not in the car. Always carry the electronic code provided on the CODE card with you, in the case you need to perform an emergency start.

SCHEDULED SERVICING



Correct maintenance of the car is essential for ensuring that it maintains its performance and its safety features, its environmental friendliness and low running costs for a long time to come.

THE OWNER MANUAL CONTAINS...



...important information, advice and warnings for correct use, driving safety and maintenance of the car over time. Special attention must be paid to the symbols provided  (personal safety)  (environmental protection)  (car integrity).

GRAPHICAL INDEX



GETTING TO KNOW YOUR CAR



KNOWING THE INSTRUMENT PANEL



SAFETY



STARTING AND DRIVING



IN AN EMERGENCY



SERVICING AND MAINTENANCE



TECHNICAL SPECIFICATIONS



INDEX



This page is intentionally left blank

GRAPHICAL INDEX



1 HEADLIGHTS

- Bulb types176
- External lights 35
- Bulb replacement173

2 WHEELS

- Rims and tyres236
- Tyre pressure239

- Wheel repair165

3 DOOR MIRRORS

- Adjustment 20
- Folding 21

4 DOORS

- Central opening/closing 51

5 BONNET

- Opening/closing 59

6 WINDSCREEN WIPERS

- Blade replacement213

AOK0620





2

A0K0621

1 REAR LIGHTS

- Bulb types176
- Bulb replacement178

2 LUGGAGE COMPARTMENT

- Opening/closing 56

3 REAR WINDOW WIPER

- Blade replacement214



1 AIR VENTS

- Climate control system 22

2 LEFT STALK

- External lights

3 INSTRUMENT PANEL

- Control panel and on-board instruments 94
- Warning lights 99

4 RIGHT STALK

- Window cleaning 39

5 UConnect Radio/UConnect Radio Nav (for versions/markets, where provided)

6 PASSENGER SIDE AIRBAG

- Operation140

7 GLOVE COMPARTMENT

- Opening 46

8 HEATER/CLIMATE CONTROL SYSTEM

- Climate comfort 23
- Manual climate control system 24
- Automatic dual-zone climate control system 28

9 CONTROL BUTTONS

- Door locking 45
- Fog lights 44
- Rear fog lights 44
- iTPMS system (for versions/markets where provided)..... 72

10

STEERING WHEEL

- Adjustment 19
- Driver side front airbag140

11

CRUISE CONTROL LEVER (for versions/markets, where provided)

- Operation 40



4

A0K0662

1 SEATS

Adjustments 17

2 ALFA DNA SYSTEM

Operation 66

3 MANUAL GEARBOX

Using the gearbox/transmission150

4 HAZARD WARNING LIGHTS

Operation 44

5 HANDBRAKE

Activation149

GETTING TO KNOW YOUR CAR

In-depth knowledge of your new car starts here.

The booklet that you are reading simply and directly explains how it is made and how it works.

That's why we advise you to read it seated comfortably on board, so that you can see what is described here for yourself.

SYMBOLS	10	ESC SYSTEM	62
ALFA ROMEO CODE SYSTEM	10	“ALFA DNA” SYSTEM (CAR DYNAMIC CONTROL SYSTEM)	66
THE KEYS	11	START&STOP SYSTEM	69
ALARM	14	ITPMS (INDIRECT TYRE PRESSURE MONITORING SYSTEM)	72
IGNITION DEVICE	15	EOBD SYSTEM (EUROPEAN ON BOARD DIAGNOSIS)	74
SEATS	17	DUAL PINION ACTIVE STEERING... ..	74
HEAD RESTRAINTS.....	18	WIRING FOR RADIO SYSTEM	75
STEERING WHEEL	19	ACCESSORIES PURCHASED BY THE OWNER	76
REAR VIEW MIRRORS.....	20	PARKING SENSORS.....	77
CLIMATE CONTROL	22	REFUELLING THE CAR	80
CLIMATIC COMFORT	23	PROTECTING THE ENVIRONMENT	81
MANUAL CLIMATE CONTROL.....	24		
AUTOMATIC DUAL ZONE CLIMATE CONTROL	28		
EXTERNAL LIGHTS.....	35		
WINDOW CLEANING.....	38		
CRUISE CONTROL.....	40		
ROOF LIGHTS	42		
CONTROLS	44		
INTERIOR FITTINGS	46		
ELECTRIC SUN ROOF.....	49		
DOORS.....	51		
ELECTRIC WINDOWS	53		
LUGGAGE COMPARTMENT	56		
BONNET	59		
ROOF RACK/SKI RACK.....	60		
HEADLIGHTS.....	61		



SYMBOLS

Some car components have coloured labels whose symbols indicate precautions to be observed when using this component. Under the bonnet there is also a label that summarises all the symbols.

ALFA ROMEO CODE SYSTEM

IN BRIEF

This is an electronic engine locking system which increases protection against attempted thefts of the car. It is automatically activated when the ignition key is removed.

There is an electronic device in each key which can identify the signal emitted, when the engine is started, from an aerial built into the ignition switch. The signal, which changes each time the engine is started, is the "password" by means of which the control unit recognises the key and enables starting. (A 1)

Operation

Each time the car is started by turning the ignition key to MAR-ON, the Alfa Romeo CODE system control unit sends an acknowledgement code to the engine management control unit to deactivate the inhibitor.

The code is sent only if the Alfa Romeo CODE system control unit has recognised the code transmitted by the key.



Each time the ignition key is turned to STOP, the Alfa Romeo CODE system deactivates the functions of the engine management control unit.

Irregular operation

If, during starting, the code is not correctly recognised, the  warning light (on some versions a message together with a symbol is shown on the display) switches on in the instrument panel.

In this case, turn the key to STOP and then to MAR-ON; if it is still locked, try again with the other keys that come with the car. If it is still not possible to start the engine, contact an Alfa Romeo Dealership.

Activation of warning light while driving

- If the  warning light (or symbol on the display) switches on, this means that the system is running self-diagnosis (caused, for example, by a voltage drop).
- If the  warning light (or symbol on the display) stays on, contact an Alfa Romeo Dealership.



IMPORTANT

1) *The electronic components inside the key may be damaged if the key is subjected to sharp knocks. In order to ensure complete efficiency of the electronic devices inside the key, it should never be exposed to direct sunlight.*

THE KEYS

CODE CARD

(for versions/markets, where provided)

The CODE Card fig. 5 is provided with the keys and bears the following:



5

A0K0544

- A - electronic code;
- B - mechanical code.

Keep the codes in a safe place, not in the car.

KEY WITHOUT REMOTE CONTROL

Operation

The metal insert A fig. 6 operates:

- the ignition switch;
- the door lock.

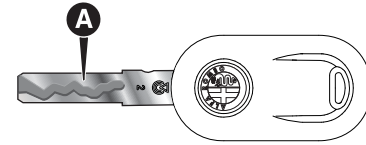

6

A0K0545

KEY WITH REMOTE CONTROL

(for versions/markets, where provided)

Operation

The metal insert A operates:

- the ignition switch;
- the door lock.

Press button B to open/close the metal insert. 1)

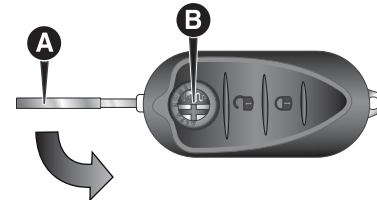

7

A0K0546



Door and luggage compartment lock release

Briefly press button  : unlocking of doors, timed switching on of internal roof lights and double flashing of direction indicators (for versions/markets, where provided).

The doors are unlocked automatically if the fuel cut-off system intervenes.

Once the doors are locked, if one or more doors or the luggage compartment are not closed correctly, the LED and direction indicators start flashing quickly.

Door and luggage compartment locking

Briefly press button  : locking of doors, switching off of internal roof lights and single flashing of direction indicators (for versions/markets, where provided).

If one or more door are open, the doors will not be locked. This is indicated by a rapid flashing of the direction indicators (for versions/markets, where provided). The doors will be locked if the tailgate is open however.

When a speed of over 20 km/h is reached, the doors are automatically locked if this specific function has been set (only on versions with "Multi-function reconfigurable display").

When the doors are locked from outside the car (using the remote control), LED A fig. 8 will switch on for a few seconds and then start flashing (deterrent function).

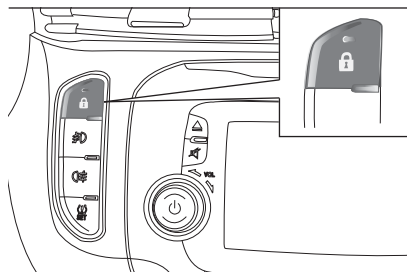

8

AOK0588

When the doors are locked from inside the car (by pressing the  button on the dashboard) the LED will remain on constantly.

Opening the luggage compartment

Press the  button to open the luggage compartment remotely. The direction indicators will flash twice to indicate that the luggage compartment has been opened.

REQUESTING ADDITIONAL REMOTE CONTROLS

The system can recognise up to 8 keys with incorporated remote control. If you need to request a new remote control, contact an Alfa Romeo Dealership, taking the CODE Card (for versions/markets, where provided), an identity document and documents proving ownership of the car with you.

REPLACING THE BATTERY IN THE KEY WITH REMOTE CONTROL

Procedure



- 1) press button A fig. 9 and move the metal insert B to opening position; turn screw C to  using a fine bit screwdriver;

- remove battery compartment D and replace battery E, respecting the polarity; reinsert compartment D in the key and secure it by turning screw C to .

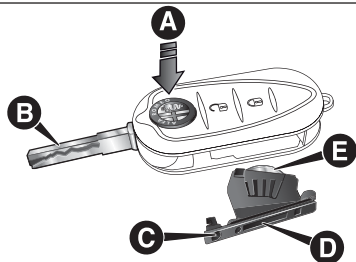

9

A0K0547

SAFE LOCK DEVICE

(for versions/markets, where provided)

This safety device inhibits the operation of the interior door handles and the door locking/unlocking button. We recommend that you activate this device each time you park the car.

Switching the device on

The device is enabled on all the doors by pressing the  button on the key twice quickly. Device activation is indicated by 3 flashes of the direction indicators and a flash of the LED on the button fig. 8. The device does not come on if one or more doors is not properly shut.

Deactivating the device

The device disengages automatically by:

- the key insert is turned to opening position in the driver side door;
- press button  on the key;
- by turning the ignition key to the MAR-ON position.

IMPORTANT Once the safe lock system is engaged, it is impossible to open the doors from inside the car. Therefore, before getting out of the car check that there is no one left on board. If the remote control battery is flat, the device can only be deactivated by using the metal insert in one of the door locks.



WARNING

- 1) **Press button B fig. 7 only with the key away from your body, especially your eyes and from objects which could get damaged (e.g. your clothes). Do not leave the key unattended, to prevent people, especially children, from inadvertently pressing the button.**



IMPORTANT

- 1) **Used batteries may be harmful to the environment if not disposed of correctly. They must be disposed of as specified by law in the special containers or taken to an Alfa Romeo Dealership, which will take care of their disposal.**



ALARM

(for versions/markets, where provided)

ALARM ACTIVATION

The alarm activates in the following cases:

- wrongful opening of a door/bonnet/ luggage compartment (perimeter protection);
- wrongful operation of the ignition switch (ignition key turned to MAR-ON);
- cutting of the battery cables;
- movement inside the passenger compartment (volumetric protection);
- anomalous lifting/tilting of the car (for versions/markets, where provided).

Operation of the alarm is indicated by an acoustic and visual signal (flashing of the direction indicators for several seconds). The alarm activation modes may vary according to the market.

There is a maximum number of acoustic/visual cycles. When this is reached the system returns to normal operation.

IMPORTANT The engine locking function is guaranteed by the Alfa Romeo CODE, which is automatically activated when the ignition key is extracted from the ignition switch.



IMPORTANT The alarm is adapted to meet requirements in various countries.

SWITCHING ON THE ALARM

With the doors, bonnet and tailgate closed and the ignition key either turned to STOP or removed, point the key with remote control towards the car and press and release the  button.

Except for specific markets, the system emits a visual and acoustic signal and enables door locking.

A self-diagnosis stage precedes the switching on of the alarm: in the event of faults, the system will generate a further acoustic and/or visual signal through the LED on the dashboard.

If after the alarm is switched on, a second acoustic signal is emitted and/or a visual signal via the LED on the dashboard, wait about 4 seconds and switch off the alarm by pressing the  button, check that the doors, bonnet and luggage compartment are closed correctly and then reactivate the system by pressing the  button.

If the alarm emits an acoustic signal even when the doors, bonnet and luggage compartment are correctly closed, a fault has occurred in system operation: in this case, contact an Alfa Romeo Dealership.

ALARM SELF-ACTIVATION (for versions/markets, where provided)

If the alarm has not been activated using the remote control, once about 30 seconds have elapsed from when the ignition key was turned to STOP and a door or the tailgate was last opened and then closed, the alarm activates automatically.

This is indicated by the LED on the button A fig. 10 lighting up intermittently and the indications of activation described previously.

To deactivate the alarm, press the  button on the remote control.

The alarm also activates when the doors are closed by turning the metal insert of the key in the driver side door latch. If the system self-activates, the doors are not locked.

SWITCHING OFF THE ALARM

Press the  button. The following operations are performed (excluding some markets):

- the direction indicators flash briefly twice;
- there are two brief acoustic signals;
- unlocking of the doors.

IMPORTANT The alarm does not switch off when the central opening is activated using the metal insert in the key.

VOLUMETRIC/ANTI-LIFT PROTECTION

To guarantee the correct operation of the protection, close the side windows and any sun roof completely (for versions/markets, where provided).

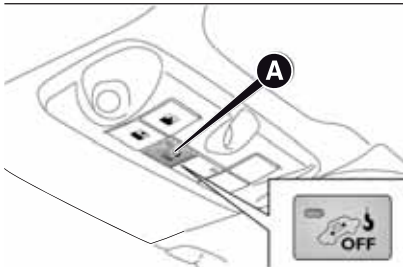
To disable the function, press button A  before activating the alarm. When the function is disabled, this is indicated by the LED on the button flashing for several seconds.

Any disabling of the volumetric/anti-lift protection must be repeated each time the instrument panel is switched off.

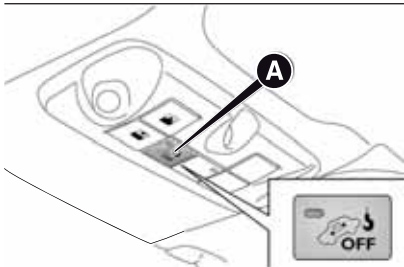

10

A0K0548

DISABLING THE ALARM

To completely deactivate the alarm (e.g. during a lengthy period of car inactivity), close the doors by turning the metal insert of the key with remote control in the door lock.

IMPORTANT If the batteries of the key with the remote control run out or the system fails, the alarm can be switched off by placing the key in the ignition switch and then turning it to MAR-ON.

IGNITION DEVICE

The key can be turned to three different positions :

- STOP: engine off, key can be removed, steering column locked. Some electrical devices (e.g. car radio, central door locking system, alarm, etc.) are enabled;
- MAR: driving position. All electrical devices are enabled;
- AVV: engine start-up.

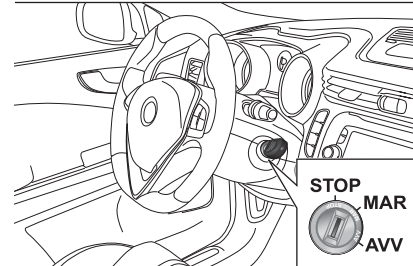

11

A0K0362

The ignition switch is fitted with a safety system that requires the ignition key to be turned back to STOP if the engine does not start, before the starting operation can be repeated.  2) 3)



STEERING LOCK

Engagement

When the key is at STOP, remove the key and turn the steering wheel until it locks.

Disengagement

Move the steering wheel slightly and turn the ignition key to MAR-ON.  4) 5)



WARNING

- 2) *If the ignition device has been tampered with (e.g. an attempted theft), have it checked over by a Alfa Romeo Dealership as soon as possible.*
- 3) *When getting out of the car, always remove the key to prevent someone from accidentally activating the controls. Remember to engage the handbrake. Engage 1st gear if the car is parked uphill or reverse if the car is parked downhill. Never leave children unattended in the car.*

4) *It is absolutely forbidden to carry out any after-market operation involving steering system or steering column modifications (e.g.: installation of anti-theft device). This could badly affect performance and safety, invalidate the warranty and also result in the non-compliance of the car with approval requirements.*

5) *Never remove the key while the car is moving. The steering wheel will lock as soon as it is turned. This holds true for cars being towed as well.*

SEATS

FRONT SEATS

Lengthwise adjustment

Lift lever A fig. 12 and push the seat forwards or backwards: in the driving position your arms should rest on the rim of the steering wheel.

 6) 7)

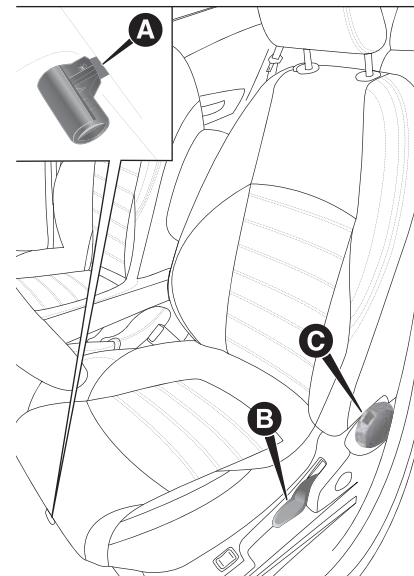

12

A0K0366

Height adjustment

(for versions/markets, where provided)

Move lever B fig. 12 up or down until the required height is reached.

IMPORTANT Carry out the adjustment whilst seated in the driver's seat.

Backrest angle adjustment

Turn knob C fig. 12 until the required position is reached.



Electric seat heating

(for versions/markets, where provided)

With the key turned to MAR-ON, press button A fig. 13 to switch the function on/off.

When the function is enabled, the LED on the button switches on.

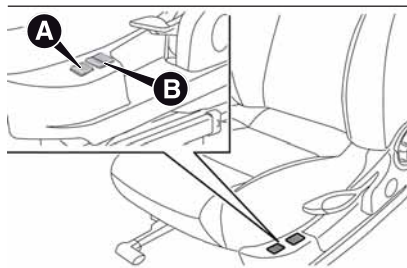

13

A0K0213

Electric lumbar adjustment

(for versions/markets, where provided)

With the key turned to MAR-ON, press button B fig. 13 to switch the function on/off.

When the function is enabled, the LED on the button switches on.

FRONT SEATS WITH ELECTRIC ADJUSTMENT

(for versions/markets, where provided)

The controls for seat adjustment are fig. 14:

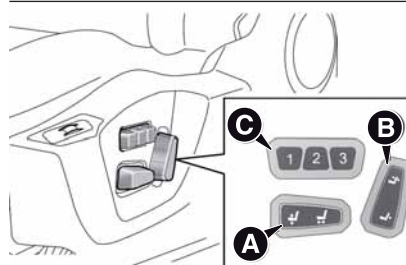

14

A0K0214

Multifunction control A:

seat height adjustment (vertical seat movement);

lengthwise seat movement;

B: Backrest angle and lumbar adjustment;

C: Driver's side seat position memory buttons.

IMPORTANT Electric adjustment is only possible with the ignition key turned to MAR-ON and for approximately 1 minute after turning it to STOP. The seat can be moved after opening the door for about 3 minutes, or until the door is closed.

Memorising driver's seat positions

Buttons C allow three different driver's seat positions to be memorised and recalled.

Memorisation and recall are possible with the ignition key in MAR-ON position and for 3 minutes after opening the driver's side door or until the door is closed, even when the ignition key is to the STOP position.

The performed position memorisation is confirmed by a beep.

To memorise a seat position, adjust it with the various controls, then press the button where you want to memorise the position for several seconds.

When a new seat position is memorised, the previously memorised position on the same button is automatically overwritten.



Recalling a memorised position is also possible for about 3 minutes after the doors are opened and about 1 minute after the ignition key is turned to the STOP position.

To recall a memorised position, press the relevant button briefly.

SEAT HEATING

(for versions/markets, where provided)

With the ignition key at MAR-ON, turn ring nut A fig. 15 to switch the function on/off.

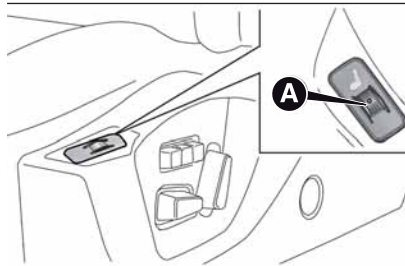

15

A0K0215

Heating can be set to 3 different levels (0 = seat heating off).



WARNING

- 6) **All adjustments must be made solely with the car stationary.**
- 7) **After releasing the adjustment lever, always check that the seat is locked on the guides by trying to move it back and forth. Failure to lock the seat in place could result in its unexpected movement and the driver losing control of the car.**
- 8) **For maximum protection keep the backrest upright, lean back into it and make sure that the seat belt fits closely across the chest and pelvis.**

HEAD RESTRAINTS

FRONT

These are height-adjustable and lock into the desired position automatically.

For the height adjustments proceed as follows:  9)

- upwards adjustment: raise the head restraint until it clicks into place;
- downwards adjustment: press button A fig. 16 and lower the head restraint.

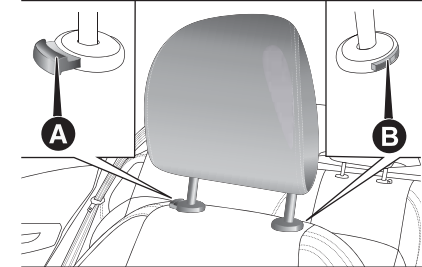

16

A0K0624

Proceed as follows to remove the head restraints:

- raise the head restraints to their maximum height;
- press buttons A and B fig. 16, then remove the head restraints by pulling them upwards.

“Anti-Whiplash” device

The head restraints are equipped with an “Anti-Whiplash” device, which reduces the distance between head and head restraint in the event of a rear impact, thus mitigating the “whiplash” effect.

The head restraint may move when the backrest is pressed by the occupant's torso or hand: this behaviour is caused by the system and should not be considered a malfunction.

REAR

Two height-adjustable head restraints are provided for the back seats (for the adjustment see the previous paragraph).

On some versions a head restraint is also provided for the central seat.

Proceed as follows to remove the head restraints:

- raise the head restraints to their maximum height;
- press buttons A and B fig. 17, then remove the head restraints by pulling them upwards.

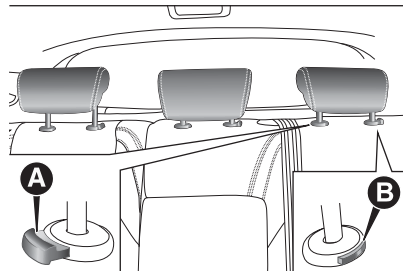

17

A0K0625



WARNING

9) The head restraints must be adjusted so that the head, rather than the neck, rests on them. Only in this case they can protect your head correctly.

STEERING WHEEL

It can be adjusted axially and vertically.

To adjust, release the lever by pushing it forwards (position 1 fig. 18) and adjust the steering wheel. Having made the adjustment, lock lever A by pulling it towards the steering wheel (position 2).  10) 11)

NOTE The "Quadrifoglio Verde" versions are equipped with sports configuration steering wheel.

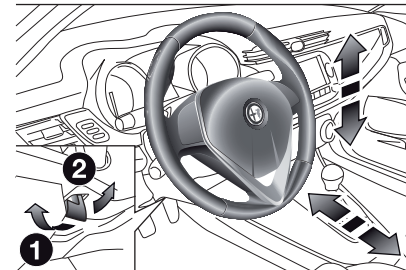

18

A0K0700

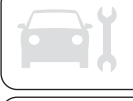



WARNING

- 10) Any adjustment of the steering wheel position must be carried out only with the car stationary and the engine turned off.**
- 11) It is absolutely forbidden to carry out any after-market operation involving steering system or steering column modifications (e.g. installation of anti-theft device) that could adversely affect performance and safety, invalidate the warranty and also result in the car not meeting type-approval requirements.**

REAR VIEW MIRRORS

INTERNAL MIRROR

The rear view mirror has two different positions: normal or anti-glare.

Adjustment

The mirror must be adjusted starting from the normal position, with the lever A fig. 19 towards the windscreen (daytime use).

To prevent dazzling effects due to following cars, the mirror can be moved into the anti-glare position by moving the lever A towards the back of the car.



19

A0K0549

Electrochromic interior mirror

(for versions/markets, where provided)

The electrochromic rear view mirror fig. 20 comes with an adjustment device to automatically prevent dazzling effects due to following cars. This function is set as default.



20

A0K0550

When reverse gear is engaged, the mirror is automatically set for daytime use.

When reverse gear is engaged, the mirror is automatically set for daytime use.

DOOR MIRRORS

Electric adjustment

The mirrors can only be adjusted/folded with the ignition in the MAR position.

Select the desired mirror using device A fig. 21  12):

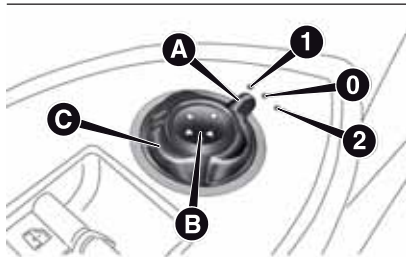

21

A0K0551

- device in position 1: left mirror selected
- device in position 2: right mirror selected.

To adjust the selected mirror, press button B in the four directions shown by the arrows.

IMPORTANT Once adjustment is complete, rotate device A to position 0 to prevent accidental movements.

Electric mirror folding

(for versions/markets, where provided)

To fold the mirrors, press button C fig. 21. Press the button again to restore the mirrors to the driving position.

Mirror manual folding

If necessary, fold the mirrors, moving them from position 1 to position 2 fig. 22.

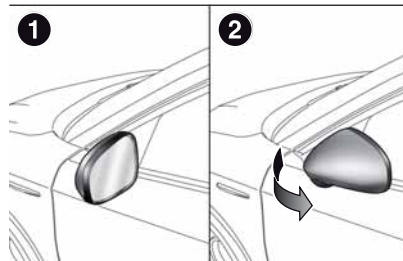

22

A0K0552

IMPORTANT When driving the mirrors must always be in position 1.



WARNING

12) As the driver's door mirror is curved, it may slightly alter the perception of distance.



CLIMATE CONTROL

SIDE AIR DIFFUSERS

A fig. 23 - Adjustable and directable side air diffusers:

- use device B to adjust the diffuser to the desired position;
- turn wheel C left to adjust the air flow.

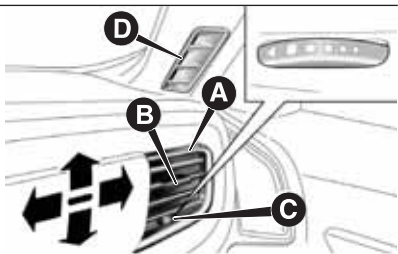

23

A0K0603

D - Fixed side air diffuser.

CENTRAL AIR DIFFUSERS

Use device A fig. 24 to adjust the diffusers to the desired position.

Turn wheels B downwards to adjust the air flow.

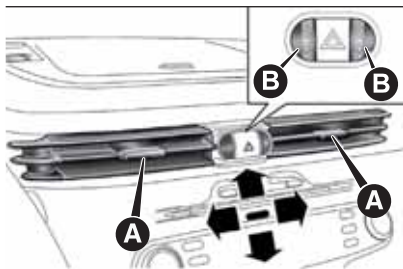

24

A0K0604

UPPER AIR DIFFUSERS

A fig. 25 - Upper adjustable air diffusers. Turn wheels B to the right to adjust the air flow.

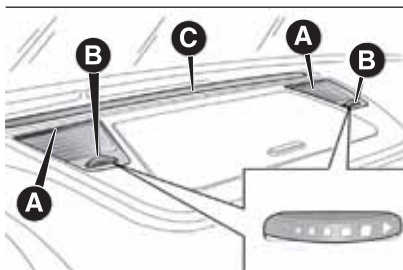

25

A0K0605

C - Fixed upper air diffuser.

REAR AIR DIFFUSER

(for versions/markets, where provided)

Use device A fig. 26 to adjust the diffuser to the desired position.

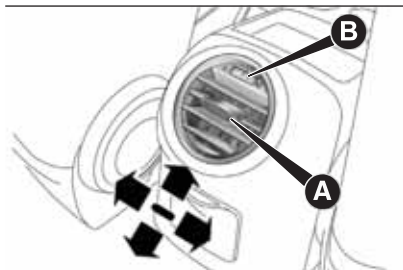

26

A0K0606

Turn wheel B to the right to adjust the air flow:

- = Completely closed
- = Completely open

CLIMATIC COMFORT

DIFFUSERS

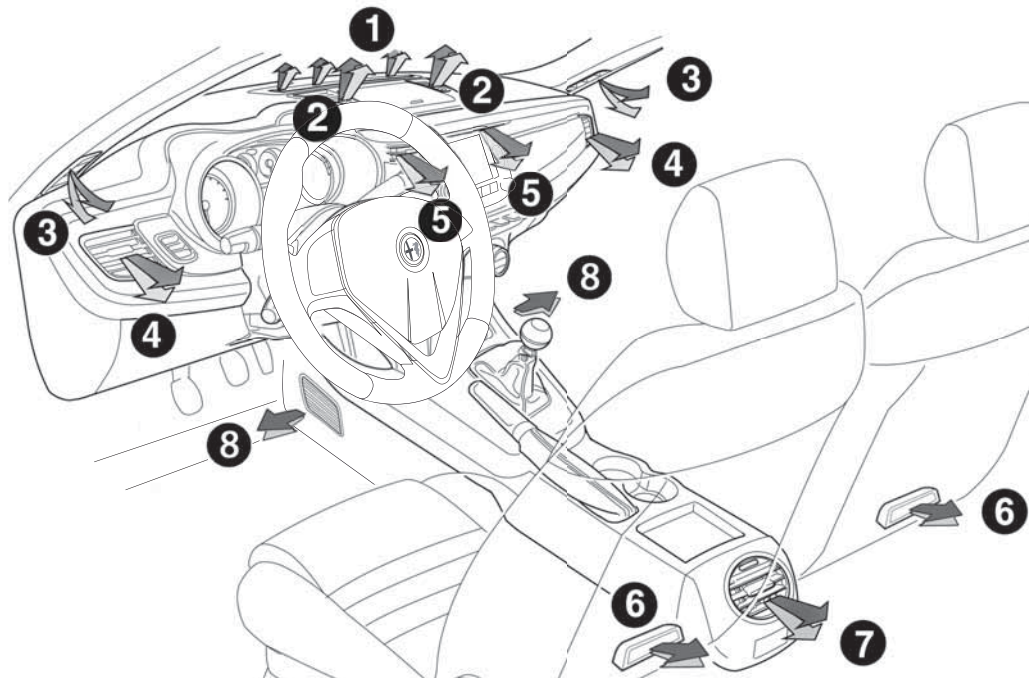

27

A0K0602

1. Fixed upper diffuser – 2. Fixed upper diffusers – 3. Fixed side vents – 4. Adjustable side vents – 5. Adjustable centre vents – 6. Lower diffusers for rear seats – 7. Adjustable vent for rear seats (for versions/markets, where provided) – 8. Lower diffusers for front seats



MANUAL CLIMATE CONTROL

CONTROLS

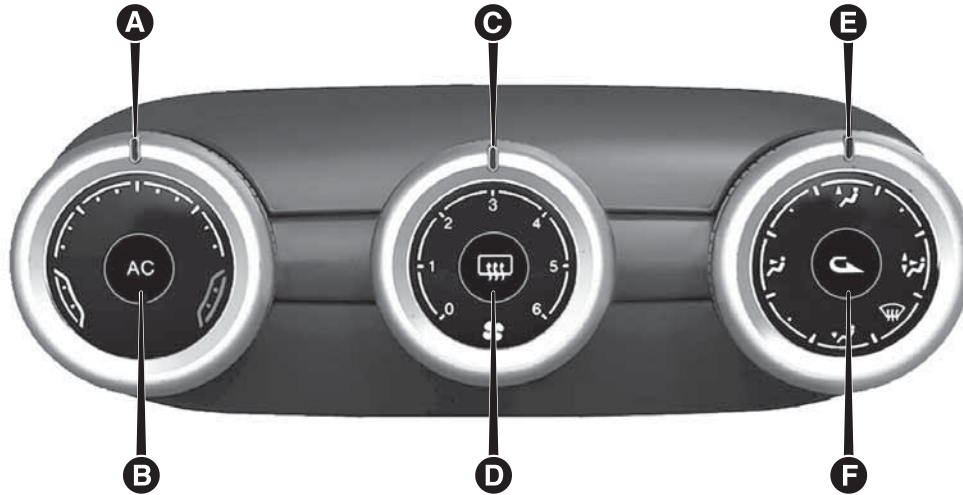

28

A - Air temperature adjustment knob:

- blue section = cold air
- red section = hot air

B - climate control compressor on/off button;

C - fan activation/adjustment knob:

- 0 = fan off
- 1-2-3-4-5-6 = fan speed

D - heated rear window on/off button;

E - air distribution knob:

various selections are possible

- quick demisting of windscreen and side windows

F - air recirculation on/off button

A0K0553

CLIMATE CONTROL (cooling)

To cool, proceed as follows:

- turn knob A to the blue section;
- press button F to turn internal air recirculation on (circular LED around the button on);
- turn knob E to  ;
- press button B to turn the climate control system on and turn knob C to at least 1 (1st speed); for faster action, turn knob C to 6 (maximum fan speed).

Adjusting cooling

Proceed as follows:

- turn knob A to the right to increase the temperature;
- press button F to turn internal air recirculation off (circular LED around the button off);
- turn knob C to reduce the fan speed.

PASSENGER COMPARTMENT HEATING

For rapid heating, proceed as follows:

- turn knob A to the red section;
- press button F to turn on the internal air recirculation system;

- turn knob E to  ;
- turn knob C to 6 (maximum fan speed).

Then use the controls to maintain the desired comfort conditions and press button F to turn internal air recirculation off (circular LED around the button off) and prevent misting.

IMPORTANT When the engine is cold, it takes a few minutes to obtain fast heating.

AUTOMATIC DEMISTING/DEFROSTING (MAX-DEF function)

This function activates automatic demisting/defrosting of: front windows (windscreen and side windows), heated nozzles, heated exterior rear view mirrors.

To activate the function, turn knob E to the “Defrosting” symbol identified by the  symbol.

The manual climate control system will automatically set itself to the following configuration:

- the demisting symbol  will turn from red to orange (to indicate that the function has been activated);

- the heated rear window (and all defrosting devices in the car) will be turned on. The circular LED around the  button will light up to indicate that the function has been activated;
- the air flow will go to maximum speed (6th);
- air circulation will be opened, if it was closed (the circular LED around the corresponding button will be off);
- air mixing will go to “maximum heat”;
- the additional electric heater (for versions/markets, where provided) will be turned on;
- the compressor will be activated (the circular LED will switch on to indicate that the AC function is on).



Window demisting

The climate control system is very useful in preventing the windows from misting up in the event of high levels of humidity.

In the event of considerable outside moisture and/or rain and/or considerable differences in temperature inside and outside the passenger compartment, proceed as follows to demist the windows:

- turn knob A to the red section;



- ❑ press button F to turn internal air recirculation off (circular LED around the button off);
- ❑ turn knob E to  with the possibility of moving it to position  (B) if demisting does not occur;
- ❑ turn knob C to the 2nd speed.

HEATED REAR WINDOW DEMISTING/DEFROSTING

Press button D () to activate/deactivate the function. The function is automatically deactivated after 20 minutes.

For versions/markets where provided, press the  button to activate demisting/defrosting of exterior rear view mirrors and heated nozzles (for versions/markets, where provided).

IMPORTANT Do not affix stickers to the inside of the heated rear window over the heating filaments, to avoid damage that might cause them to stop working properly.

INTERNAL AIR RECIRCULATION

Press button F () so that the LED around the button turns on. It is advisable to switch internal air recirculation on while standing in traffic or in tunnels to prevent the introduction of polluted air.



Do not use the function for a long time, particularly if there are many passengers on board, to prevent the windows from misting up.

IMPORTANT Internal air recirculation makes it possible to reach the required heating or cooling conditions more quickly depending on the mode selected. Do not use the air recirculation function on rainy/cold days as it would considerably increase the possibility of the windows misting.

SETTING THE AIR DISTRIBUTION

Turn knob E to manually select one of the four possible air distribution settings in the passenger compartment:

-  Air flow to the windscreen and front side window diffusers to demist/defrost them.

-  Air flow to the front/rear footwell diffusers. This air distribution allows the passenger compartment to be warmed up quickly.
-  Air flow distribution between front and rear diffusers, centre/side dashboard diffusers, rear diffuser and windscreen and front side window demisting/defrosting diffusers.
-  Air flow distribution to centre/side dashboard diffusers (passenger's body).

There are also another 4 positions (see diagram below fig. 29):

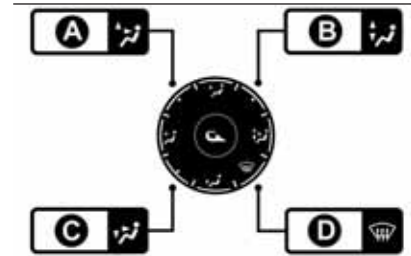

 **Position A:** Air flow distribution between centre/side dashboard vents, rear diffuser and windscreen and front side window demisting/defrosting diffusers. This distribution setting ventilates the passenger compartment well and prevents the windows from misting up.

 **Position B:** Air flow distributed between footwell diffusers and windscreen and front side window defrosting/demisting diffusers. This distribution setting allows the passenger compartment to warm up efficiently and prevents the windows from misting up.

 **Position C:** Air flow distribution between footwell diffusers (hotter air) and centre/side dashboard diffusers and rear diffuser (cooler air).

 **Position D:** Automatic demisting/defrosting activation (see description in previous pages).

START&STOP

Manual climate control

If the Start&Stop function is activated (engine off when the car speed is 0 km/h), the system keeps the air flow selected by the user.

In these conditions, the compartment cooling and heating cannot be guaranteed, as the compressor stops with the engine coolant pump.

The Start&Stop function can be deactivated to enhance the operation of the climate control system by pressing the dedicated button on the dashboard.

SERVICING MAINTENANCE

In winter, the climate control system must be turned on at least once a month for about 10 minutes.

Have the system inspected at an Alfa Romeo Dealership before the summer.



AUTOMATIC DUAL ZONE CLIMATE CONTROL

(for versions/markets, where provided)

CONTROLS

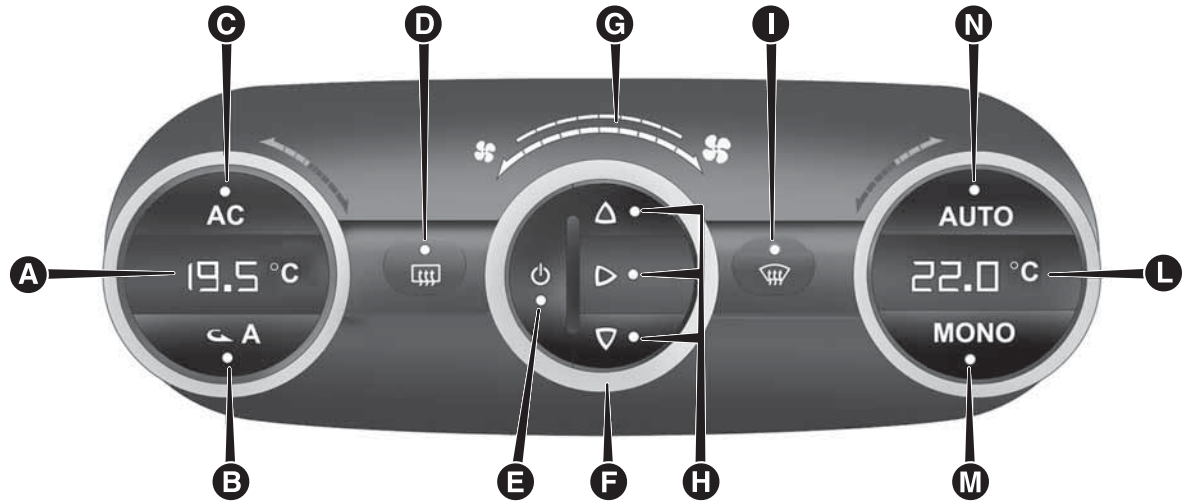

30

A - driver side temperature adjustment knob;

B - internal air recirculation on/off button;

C - climate control system compressor on/off button;

D - heated rear window on/off button;

E - climate control on/off button;

F - fan speed adjustment knob;

G - Fan speed indicator LED;

H - air distribution selection buttons;

A0K0555

I - MAX-DEF function (rapid defrosting/ demisting of front windows), heated rear window and heated exterior mirrors (for versions/markets, where provided) activation button;

L - passenger side temperature adjustment knob;

M - MONO function activation button (alignment of set temperatures) driver/passenger side;

N - AUTO function activation button (automatic operation).

DESCRIPTION

The automatic dual zone climate control system regulates the air temperatures in the passenger compartment in two areas: driver side and passenger side.

The system maintains comfort inside the passenger compartment and compensates for possible variations in external climate conditions.

Note The reference temperature is 22°C for optimal comfort management.

The automatically controlled parameters and functions are:

- air temperature at the driver's/front passenger side vents;
- air distribution at the driver's/front passenger side vents;

- fan speed (continuous variation of the air flow);
- compressor engagement (for cooling/dehumidifying the air);
- air recirculation.

All these functions can be adjusted manually by operating the system and selecting one or more functions and modifying their parameters. Automatic control of the manually changed functions will be suspended: the system will only override the settings for safety reasons.

Manual selections always have higher priority than automatic settings and are stored until the AUTO button is pressed, except for cases in which the system intervenes for safety reasons.

You can adjust one function manually without affecting the automatic control of the others. The amount of air introduced into the passenger compartment is not affected by vehicle speed; it is electronically controlled by a fan.

The temperature of the air sent is always automatically controlled according to the temperature set on the display (except for when the system is off or in certain conditions when the compressor is not running).  2)

The system allows the following to be set or adjusted manually:

- driver's/passenger side air temperature;
- fan speed (continuous variation);
- air distribution pattern with 7 positions;
- compressor enabling;
- rapid defrosting/demisting function;
- air recirculation;
- heated rear window;
- system deactivation.

CLIMATE CONTROL SYSTEM OPERATING MODES

The climate control system can be activated in different ways: it is advisable to press the AUTO button and turn the knobs to set the desired temperatures.

In this way the system operates completely automatically to adjust the temperature, quantity and distribution of the air introduced into the passenger compartment. It also manages the air recirculation system and the activation of the air conditioning compressor.



During automatic operation, you can change the set temperatures, air distribution and fan speed at any time by using the relevant buttons or knobs: the system will automatically change the settings to adjust to the new requirements.

During fully automatic operation (AUTO), the word AUTO will disappear if the air distribution and/or flow rate and/or engagement of the compressor and/or recirculation settings are changed.

During fully automatic operation (FULL AUTO), the word FULL will disappear if the air distribution and/or flow rate and/or activation of the compressor and/or recirculation settings are changed.

In this way the climate control system will continue to automatically manage all functions except for those that have been manually adjusted. The fan speed is the same in all the zones of the passenger compartment.

ADJUSTING THE AIR TEMPERATURE

Turn knob A or L to the right or left to adjust the air temperature: knob A for the front left area, knob L for the front right area of the passenger compartment. The set temperatures are shown on the displays.

Press the MONO button to align the air temperature between the two areas.

Turn knob L to return to the separate management of air temperatures in the two areas.

Turn the knobs fully right or left to engage HI (maximum heating) or LO (maximum cooling) respectively. To deactivate these functions, turn the temperature knob to the desired temperature.

SETTING THE AIR DISTRIBUTION

By pressing the buttons (\triangle / ∇ / \triangleright), it is possible to set one of the 7 possible air distributions manually:

- \triangle Air flow to the windscreen and front side window diffusers to demist/defrost them.
- \triangleright Air flow at central and side dashboard vents to ventilate the chest and the face during the hot season.

- ∇ Air flow to the front and rear footwell diffusers. This air distribution setting heats the passenger compartment most quickly, giving a prompt sensation of warmth.
- \triangleright ∇ Air flow distributed between footwell vents (hotter air) and central and side dashboard vents (cooler air). This distribution setting is useful in spring and autumn on sunny days.
- \triangle ∇ Air flow distributed between footwell diffusers and windscreen and front side window defrosting/demisting diffusers. This distribution setting allows the passenger compartment to warm up efficiently and prevents the windows from misting up.
- \triangle \triangleright Air flow distribution between windscreen demisting/defrosting diffusers and side and central dashboard vents. This allows air to be sent to the windscreen in conditions of strong sunlight.
- \triangle \triangleright ∇ Air flow distribution to all vents on the car.

In AUTO mode, the climate control system automatically manages air distribution (the LEDs on buttons H are off). When set manually, the air distribution is shown by the LEDs on the selected buttons.

In combined function mode the relevant function is enabled simultaneously with those already set by pressing the corresponding button. If a button whose function is already active is pressed, its operation is cancelled and the corresponding LED switches off. To restore automatic control of the air distribution after a manual selection, press the AUTO button.

ADJUSTING THE FAN SPEED

Turn knob F to increase/decrease the fan speed. The speed is indicated by the LEDs G on knob F switching on.

- maximum fan speed = all LEDs lit;
- minimum fan speed = one LED lit.

The fan can only be excluded if the climate control compressor has been switched off by pressing button C.

IMPORTANT To restore automatic control of the fan speed after a manual adjustment, press the AUTO button.

AUTO BUTTON

By pressing the AUTO button (LED on button lit) the climate control system automatically adjusts the following settings in the corresponding zones:

- quantity and distribution of the air introduced into the passenger compartment;
- climate control compressor;
- air recirculation
- cancelling any previous manual settings.

This is indicated by the LED on the AUTO button switching on.

By manually adjusting at least one of the functions automatically managed by the system (air recirculation, air distribution, fan speed or switching off the air conditioner compressor), the LED will switch off, indicating that the climate control system is no longer automatically controlling all the functions.

IMPORTANT Should the system no longer be able to guarantee the required temperature set in various passenger compartment zones, the set temperature value will flash for a few seconds.

To restore automatic system control after one or more manual adjustments, press the AUTO button.

MONO BUTTON

Press the MONO button (LED on button lit) to align the passenger side air temperature with that of the driver side.

This function makes temperature regulation easier when the driver is travelling alone.

Turn knob L to set the passenger side temperature and return to separate air temperature management.

AIR RECIRCULATION AND ENABLEMENT OF AQS FUNCTION (Air Quality System)

(for versions/markets, where provided)

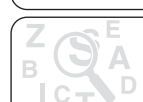
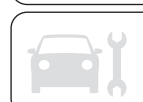

The air recirculation is managed according to the following operating logics:

- automatic activation: text A on button B lit;
- forced activation (inside air recirculation always on): indicated by the LED on button  and text A off;



forced deactivation (air recirculation always off, air drawn in from the outside): indicated by the LED on buttons  switching off and text A on button B off.

Forced activation/deactivation can be selected by pressing button .

When the  button is pressed (button E off), the climate control system automatically activates internal air recirculation (LED on  button A on). It is still possible to activate outside air recirculation (LED on the button off) and vice versa, by pressing button .

The AQS (Air Quality System) function (for versions/markets, where provided) cannot be activated when the  button is pressed (LED on button E off).

AQS (Air Quality System) function activation

(for versions/markets, where provided)

The AQS function automatically activates internal air recirculation when the outside air is polluted (e.g. in traffic queues and tunnels).

IMPORTANT With the AQS function active, after a preset time interval of the internal air recirculation system functioning, the climate control system enables the intake of outside air for approximately one minute to change the air in the passenger compartment. This takes place regardless of the pollution level of the outside air.

IMPORTANT The engagement of the recirculation system makes it possible to reach the required heating/cooling conditions faster. It is, however, inadvisable to use it on rainy/cold days as it would considerably increase the possibility of the windows misting up inside (especially if the climate control system is off). When the outside temperature is low, recirculation is forced off (air drawn in from the outside) to prevent the windows from misting up.

In automatic operation, recirculation is managed automatically by the system according to outside environmental conditions.

IMPORTANT It is advisable not to use the air recirculation function when the outside temperature is low to prevent the windows from rapidly misting up.

CLIMATE CONTROL COMPRESSOR

Press button C to activate/deactivate the compressor (activation is indicated by the lit LED on the button). The system remembers that the compressor has been switched off, even after the engine has stopped.

When the compressor is switched off the system deactivates air recirculation to prevent the windows from misting up and deactivates the AQS function (for versions/markets, where provided).

In this case, although the climate control system is capable of maintaining the required temperature, the AUTO LED switches off. The temperatures will flash for a few seconds if the required temperature cannot be maintained.

To restore automatic control of compressor engagement, press again button C or the AUTO button.

With compressor off:

- if the outside temperature is higher than the set one, the system will not be able to satisfy the request. The temperature values will then flash on the display for a few seconds to indicate this;
- the fan speed can be reset manually.

With the compressor on and the engine running, manual ventilation cannot be lower than the minimum speed (only one LED lit).

IMPORTANT With the compressor off, air cannot be introduced to the passenger compartment with a temperature lower than the outside temperature. Moreover, under certain environmental conditions, windows could mist up rapidly since the air is not dehumidified.

RAPID WINDOW DEMISTING/DEFROSTING (MAX-DEF function)

Press the  button to activate (LED on button on) the windscreen and side windows demisting/defrosting function.

The climate control system carries out the following operations:

- switches on the air conditioning compressor when climatic conditions are suitable;
- deactivates air recirculation;
- sets maximum air temperature (HI) in both zones;
- sets fan speed according to the engine coolant temperature;
- directs air flow to windscreen and front side windows diffusers;

activates the heated rear window.

displays the fan speed (LED G lit).

IMPORTANT The MAX-DEF function remains on for about 3 minutes from when the engine coolant reaches the appropriate temperature.

When the function is activated, the LED on the AUTO button switches off. With the function activated the only possible manual adjustments are adjusting the fan speed and turning the heated rear window off.

When the B, C,  or AUTO buttons are pressed, the climate control system will turn the MAX-DEF off.

HEATED REAR WINDOW DEMISTING/DEFROSTING

Press the  button to activate (LED on button on) heated rear window demisting/defrosting.

This function switches off automatically after about 20 minutes or when the engine is turned off. It is not switched on automatically the next time the engine is started.

For versions/markets where provided, press the  button to activate demisting/defrosting of exterior rear view mirrors and heated nozzles (for versions/markets, where provided).

IMPORTANT Do not affix stickers to the inside of the heated rear window over the heating filaments, to avoid damage that might cause them to stop working properly.

Thermal comfort windscreen

(for versions/markets, where provided)

Some versions feature a thermal comfort windscreen which, with the car exposed to the sun, reduces the temperature in the passenger compartment relative to the outside temperature, thus ensuring greater comfort.

Humidity sensor

(for versions/markets, where provided)

The humidity sensor helps to prevent the windows from misting up. For full functionality, it is advisable to activate the AUTO function (LED N on).

When the outside temperature is low, the system could automatically turn the compressor on and turn air recirculation off for safer driving.

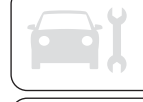

SWITCHING OFF/ON THE CLIMATE CONTROL SYSTEM

Switching off the climate control system

Press the  button (LED on button off).

With climate control off:

- air recirculation is on, thus isolating the passenger compartment from the outside;
- the compressor is off;
- the fan is off;
- the heated rear window can be switched on or off;
- the AQS (Air Quality System) function (for versions/markets, where provided) cannot be activated.

IMPORTANT The climate control system control unit stores the temperatures set before the system was switched off and restores them when any button of the system is pressed (except for button D).

Switching on the climate control system

To switch on the climate control system in fully automatic mode press the AUTO button.

START&STOP

Automatic Climate Control

The dual zone automatic climate control manages the Start&Stop function (engine off when the car speed is zero) to guarantee a suitable comfort inside the car.

Specifically, the Start&Stop function is turned off when the weather is particularly hot or cold to guarantee an adequate level of comfort inside the passenger compartment; therefore, the engine will not be stopped during these transient conditions, even if the speed is zero.

When the Start&Stop function is active (engine off at zero car speed), the climate control system will request restarting of the engine if the inside temperature conditions rapidly deteriorate (or if the user requests maximum cooling – LO – or quick demisting – MAX DEF).

With the Start&Stop function on (engine off at zero speed), air flow is reduced to the minimum to maintain comfort conditions inside the passenger compartment as long as possible when the system is in AUTO mode (LED N on).

The climate control system control unit attempts to manage the discomfort caused by the engine stopping (compressor and engine coolant pump off) but operation of the climate control system can be enhanced by turning the Start&Stop off by pressing the dedicated button on the dashboard.

Note In particularly severe climate conditions it is recommended to limit the use of the Start&Stop function to prevent the compressor from continuously switching on and off, with consequent rapid misting of the windows and accumulation of humidity with unpleasant smells in the passenger compartment.

Note When the Start&Stop function is on (engine off and vehicle speed zero), the automatic recirculation management is turned off always taking air in from outside, to reduce the probability of window misting up (as the compressor is off).

ADDITIONAL HEATER

(for versions/markets, where provided)

This allows the passenger compartment to be heated more quickly in cold weather conditions. The additional heater turns off automatically after the required comfort conditions are achieved.

Automatic dual zone climate control system

(for versions/markets, where provided)

The additional heater activates automatically depending on the environmental conditions and with engine started.

Manual climate control system

The additional heater activates automatically when knob A is turned to the end of the red section and the fan is set to at least 1st speed.

IMPORTANT The heater only works if the outside temperature and engine coolant temperature are low. The heater will not activate if the battery voltage is too low.



IMPORTANT

- 2) *The climate control system detects the passenger compartment temperature with a mean radiant temperature sensor fitted in a cover under the internal rear view mirror. Obstructing the field of view of this sensor with any object could cause the climate control system to operate with less than optimal efficiency*

EXTERNAL LIGHTS

IN BRIEF

The left stalk fig. 31 operates most of the external lights. The external lights can only be switched on when the ignition key is at MAR-ON.

The instrument panel and the dashboard and central tunnel controls will light up together with the external lights.



31

A0K0556

DAYTIME RUNNING LIGHTS (DRL) “Daytime Running Lights”

With the ignition key at MAR-ON and ring nut A fig. 31 turned to , the daytime running lights switch on. The other lights and interior lighting stay off.



IMPORTANT The daytime running lights are an alternative to the dipped beam headlights for driving during the daytime in countries where it is compulsory to have lights on during the day; where it is not compulsory, the use of daytime running lights is permitted.



IMPORTANT Daytime running lights cannot replace dipped beam headlights when driving at night or through tunnels. The use of daytime running lights is governed by the Highway Code of the country in which you are driving. Comply with legal requirements.

SIDE LIGHTS/DIPPED BEAM HEADLIGHTS

With the ignition key turned to MAR-ON, turn ring nut A fig. 31 to .

The daytime running lights are switched off and the side lights and dipped beam headlights are switched on. The  warning light switches on in the instrument panel.

PARKING LIGHTS

These lights can only be switched on with ignition key at STOP or removed, by moving ring nut A fig. 31 first to position  and then to position .

The  warning light switches on in the instrument panel.

AUTOMATIC LIGHTING CONTROL (AUTOLIGHT) (Dusk sensor)

(for versions/markets, where provided)

This infrared LED sensor, combined with the rain sensor and located on the windscreen, detects the variations in outside brightness depending on the light sensitivity set with the Setup Menu: the greater the sensitivity, the less external light is required to activate the external lights.

Activation

The dusk sensor activates when ring nut A fig. 31 is turned to . In this way the side lights and dipped beam headlights are activated automatically according to the external lighting conditions.

IMPORTANT The sensor is unable to detect the presence of fog. Therefore under these circumstances, these lights must be turned on manually.

When the lights are turned on by the sensor, the fog lights (for versions/markets, where provided) and the rear fog lights may be turned on.

When the lights are automatically switched off, the front and rear fog lights (if activated) are also switched off. The next time the lights are switched on automatically, the fog lights must be reactivated manually (if required).



With the sensor active, it is possible to flash the headlights but the main beam headlights cannot be switched on. To activate these lights, turn the ring nut A to  and activate the fixed dipped beam headlights.

When the lights have been activated automatically and are then switched off by the sensor, the dipped beam headlights are switched off first, followed by the side lights a few seconds later.

If the sensor is activated but is malfunctioning, the side lights and dipped beam headlights are switched on irrespective of the outside light level and the sensor failure is indicated on the display.

It is also possible to deactivate the sensor and switch on the side lights and dipped beam headlights.

MAIN BEAM HEADLIGHTS

To activate the main beam headlights, with ring nut A fig. 31 at , pull the stalk towards the steering wheel beyond the end of travel position. The  warning light switches on in the instrument panel.

When the stalk is pulled towards the steering wheel again, beyond the end of travel position, the main beam headlights deactivate, the dipped beam headlights reactivate and the  warning light switches off.

It is not possible to switch on the main beam headlights constantly if automatic light control is active.

FLASHING

To do this, pull the stalk towards the steering wheel (unstable position) regardless of the position of ring nut A fig. 31. The  warning light switches on in the instrument panel.



REAR FOG LIGHTS

For the activation and deactivation of the rear fog lights, refer to the "Controls" section.

DIRECTION INDICATORS

Bring the stalk to the (stable) position:

- upwards: activates right direction indicator;
- downwards: activates left direction indicator.

Warning light  or  will blink on the instrument panel.

The direction indicators are switched off automatically when the steering wheel is straightened.

"Lane change" function

If you wish to signal a lane change, place the left stalk in the unstable position for less than half a second. The direction indicator on the side selected will flash five times and then switch off automatically.

"FOLLOW ME HOME" DEVICE

This device allows you to illuminate the area in front of the car for a certain amount of time.

Activation

With the key turned to STOP or removed, pull stalk A towards the steering wheel within 2 minutes from when the engine is turned off.

Each time the stalk is moved, the lights stay on for an extra 30 seconds up to a maximum of 210 seconds; then the lights are switched off automatically.

Also, each time the stalk is operated, the  warning light on the instrument panel switches on. The display shows the time set for the function and the corresponding graphics.

The warning light comes on when the lever is operated and stays on until the function is automatically deactivated. Each movement of the stalk only increases the amount of time the lights stay on.

Deactivation

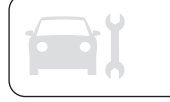

Keep the stalk pulled towards the steering wheel for more than 2 seconds.



EXTERNAL COURTESY LIGHTS

These light up the car and the space in front of it when the doors are unlocked.

Activation

When the car is parked and the doors are unlocked by pressing the  button on the remote control (or the luggage compartment is unlocked by pressing ) , the dipped beam headlights, rear side lights and number plate lights are activated.

The lights stay on for approximately 25 seconds unless the doors and luggage compartment are locked again with the remote control or the doors (or luggage compartment) are opened and reclosed. In these cases they switch off after 5 seconds.

The external courtesy lights can be enabled/disabled using the Setup Menu (see the “Menu Items” paragraph in this chapter).

AFS ADAPTIVE LIGHTS (Adaptive Frontlight System)

(for versions/markets, where provided)

This is a system combined with Xenon headlamps which directs the main light beam and adapts it to the driving conditions round bends/when cornering, continuously and automatically.

The system directs the light beam to light up the road in the best way, taking into account the speed of the car, the bend/corner angle and the speed of steering.

The adaptive lights are automatically activated when the car is started.

To activate/deactivate the lights use the Setup Menu (see paragraph “Menu Items” in the “Knowing the instrument panel” section).

WINDOW CLEANING

IN BRIEF

The right stalk controls screen wiper/washer operation.

This operates only with the ignition key turned to MAR.

WINDSCREEN WASHER/WIPER



Operation 13) 14)

Ring nut A fig. 32 has the following positions:





32

A0K0557

-  windscreen wipers off;
-  intermittent operation (low speed);

AUTO rain sensor activation (for versions/markets, where provided) (the windscreen wipers adapt the operating speed automatically to suit the intensity of the rain)

- OID** intermittent operation;
-  continuous slow operation;
-  continuous fast operation.

Move the stalk upwards (unstable position) to limit operation to the time for which the stalk is held in this position. When released, the stalk will return to its default position and the wiper will be automatically stopped.

"Smart washing" function

Pull the lever towards the steering wheel (unstable position) to operate the windscreen washer. Keep the stalk pulled for more than half a second to operate the windscreen washer jet and wiper automatically with a single movement.

The wiper stops working three strokes after the stalk is released. A further stroke after approximately 6 seconds completes the cycle.

RAIN SENSOR

(for versions/markets, where provided)

This is an infrared LED sensor fitted on the car windscreen fig. 33.

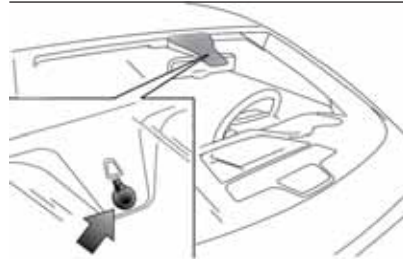

33

A0K0558

It is able to detect the presence of rain and consequently manage windscreen wiping in accordance with the amount of water on the windscreen.

Activation

The sensor is activated when ring nut A fig. 32 is turned to "automatic" position ("AUTO" control): the windscreen wiper stroke frequency is thus adjusted in accordance with the amount of water on the windscreen.

This frequency can vary from no stroke (no rain - windscreen dry) up to the 2nd constant speed operation (heavy rain - windscreen wet).

The sensitivity of the rain sensor can be adjusted through the Setup menu (see paragraph "Menu Items" in the "Knowing the instrument panel" section).

If the engine is stopped with the lever in "automatic" position, when it is next started no wiping cycle will take place even if it is raining. This prevents accidental activation of the rain sensor when the engine is started (e.g. when the windscreen is being washed by hand or the wipers are stuck to the windscreen when there is ice).

To restore automatic operation of the rain sensor, turn the ring nut on the right stalk A fig. 32 from automatic position (AUTO) to **O** position and then turn A ring nut back to the AUTO position.

When the rain sensor is reactivated using any of the manoeuvres described above, reactivation is indicated by a single stroke of the windscreen wipers, regardless of the condition of the windscreen.

If the sensitivity is changed whilst the rain sensor is operating, a windscreen wiper stroke is carried out to confirm the change.



In the event of malfunction of the rain sensor whilst it is active, the windscreen wiper operates intermittently at a speed consistent with the sensitivity setting of the rain sensor, regardless of whether there is rain on the glass (sensor failure is indicated on the display).

The sensor continues to operate and it is possible to set the windscreen wiper to continuous mode (1st or 2nd speed). The failure indication remains for as long as the sensor is active.

REAR WINDOW WASHER/WIPER

(for versions/markets, where provided)

Activation

This operates only with the ignition key turned to MAR.

Turn ring nut B fig. 32 from position **O** to position  to operate the rear window wiper as follows:

- in intermittent mode when the windscreen wiper is not operating;
- in synchronous mode (at half the speed of the windscreen wiper) when the windscreen wiper is operating;
- in continuous mode with reverse gear engaged and the control active.

With reverse gear engaged and windscreen wiper on, the rear window wiper is activated in continuous mode. Pushing the stalk towards the dashboard (unstable position) will activate the rear window washer jet.

Keep the stalk pushed for more than half a second to activate the rear window wiper as well. Releasing the stalk will activate the smart washing function, as described for the windscreen wiper.



WARNING

13) Do not use the screen wiper to remove layers of snow or ice from the windscreen. In such conditions, the windscreen wiper may be subjected to excessive stress and the motor cut-out switch, which prevents operation for a few seconds, may intervene. If operation is not restored (even after restarting that car with the key), contact an Alfa Romeo Dealership.

14) Do not operate the windscreen wiper with the blades lifted from the windscreen.

CRUISE CONTROL

(for versions/markets, where provided)

IN BRIEF

This is an electronically controlled driving assistance device that allows the desired car speed to be maintained, without having to press the accelerator pedal. This device can be used at a speed above 30 km/h on long stretches of dry, straight roads with few variations (e.g. motorways).

The use of this device on extra-urban roads with traffic is not therefore recommended. Do not use it in town.

TURNING THE DEVICE ON

Turn ring nut A fig. 34 to ON.



The device cannot be engaged in 1st or reverse gear: it is advisable to engage it in 5th gear or higher.

When travelling downhill with the device engaged, the car may slightly exceed the stored speed.

The  warning light and, for versions/markets, where provided, message on the display are switched on to indicate activation.

STORING THE CAR SPEED

Proceed as follows:

- turn ring nut A fig. 34 to ON and press the accelerator to reach the required speed;
- move the stalk upwards (+) for at least 1 second, then release it: the car speed is now stored and you can therefore release the accelerator.

If needed (when overtaking for instance), you can accelerate simply by pressing the accelerator; when you release the pedal, the car goes back to the speed stored previously.

RESTORING THE MEMORISED SPEED

If the device has been disengaged by pressing the brake or clutch pedal, the stored speed can be reset as follows:

- accelerate gradually until a speed approaching the one stored is reached;
- engage the gear selected at the time that the speed was stored;
- press the RES button (B fig. 34).

INCREASING THE MEMORISED SPEED

This can be done in two ways:

- by pressing the accelerator and storing the new speed reached
- or
- by moving the stalk upwards (+) until the new speed, which will be stored automatically, is reached.

Each movement of the stalk corresponds to an increase in speed of about 1 km/h, while keeping the stalk held upwards will continuously increase the speed.

REDUCING THE MEMORISED SPEED

This can be done in two ways:

- by deactivating the device and then storing the new speed
- or
- by moving the stalk downwards (-) until the new speed, which will be stored automatically, is reached.

Each movement of the lever corresponds to a slight reduction in speed of about 1 km/h, while keeping the stalk held downwards will decrease the speed continuously.

TURNING THE DEVICE OFF

The device can be deactivated in the following ways:

- by turning ring nut A fig. 34 to the OFF position
- by switching off the engine;



- by pressing the brake pedal, the clutch or the accelerator; in this last case the system is not effectively deactivated but the system gives priority to the acceleration request. The device still remains active, without the need to press the RES button to return to the previous conditions once acceleration is concluded.

Automatic deactivation

The device deactivates automatically in the following cases:

- if the ABS or ESC systems intervene;
- with the car speed below the set limit;
- in the event of system failure.

 15) 16)



WARNING

15) When travelling with the device active, do not move the gear lever to neutral.

16) In the event of device faults or failures, turn the ring nut A to OFF and contact an Alfa Romeo Dealership.

ROOF LIGHTS

FRONT ROOF LIGHT

Switch A fig. 35 switches the roof lights on/off.

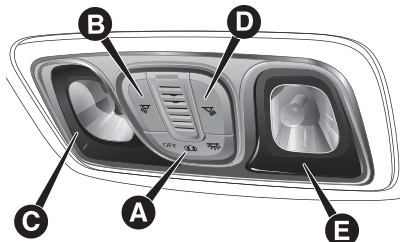

A switch positions:

- *central position*: lights C and E switch on/off when the doors are opened/closed;
- *pressed to the left* (position OFF): lights C and E are always switched off;
- *pressed to the right* (position ): lights C and E are always switched on.

Lights switch on/off progressively.

Switch B switches light C on/off.

Switch D switches light E on/off.

IMPORTANT Before getting out of the car, make sure that both switches are in the central position: when the doors are closed the lights will switch off to avoid draining the battery.

In any case, if the switch is left inadvertently in the permanently on position, the roof light will turn off automatically 15 minutes after the engine stopping.

ROOF LIGHT TIMING

On certain versions, to facilitate getting in/out of the car at night or in poorly-lit areas, two timed modes have been provided.

Timing when getting into the car

The roof lights switch on according to the following modes:

- for about 10 seconds when the doors are unlocked;
- for about 3 minutes when one of the doors is opened;
- for about 10 seconds when the doors are closed.

The timed period is interrupted when the ignition key is turned to MAR.

Timing when getting out of the car

After removing the key from the ignition switch, the roof lights switch on as follows:

- ❑ within 2 minutes of the engine being switched off for a period of around 10 seconds;
- ❑ for about 3 minutes when one of the doors is opened;
- ❑ for about 10 seconds when one of the doors is closed.

The timing stops automatically when the doors are locked.

REAR ROOF LIGHT

Press the cover A fig. 36 to switch the light on/off.

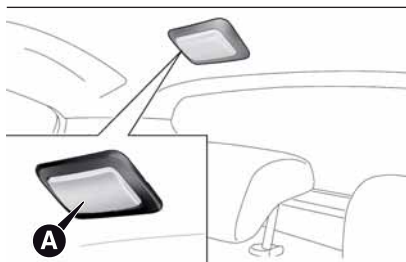

36

A0K0561

The light will stay on for a few seconds after the doors are closed and will then switch off automatically. The light switches off in any case when the ignition key is turned to MAR.

IMPORTANT The light switches off automatically after a few minutes if a door is left open. To switch it on again, open another door or close and reopen the same door.

COURTESY LIGHTS

(for versions/markets, where provided)

Two courtesy roof lights B fig. 37 are present behind the sun visors.

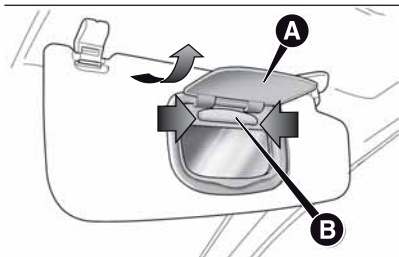

37

A0K0562

Lift cover A to turn the lights on.

LUGGAGE COMPARTMENT ROOF LIGHT

This is located on the left side of the luggage compartment fig. 38.

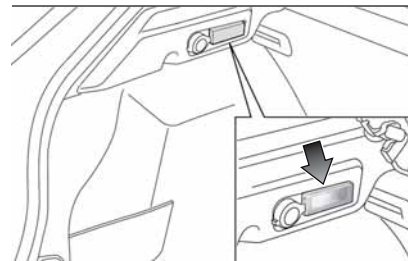

38

A0K0563

This switches on automatically when the luggage compartment is opened and switches off when it is closed.

The light switches on/off regardless of the ignition key position.

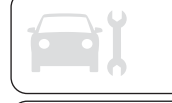

GLOVE COMPARTMENT LIGHT

This light comes on automatically when the glove compartment is opened and switches off when it is closed.

The light switches on/off regardless of the ignition key position.

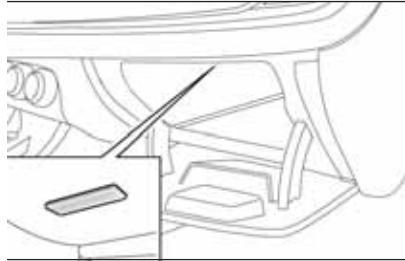

39

A0K0564

CONTROLS

HAZARD WARNING LIGHTS

Operation

Press switch A fig. 40 to switch the lights on/off.

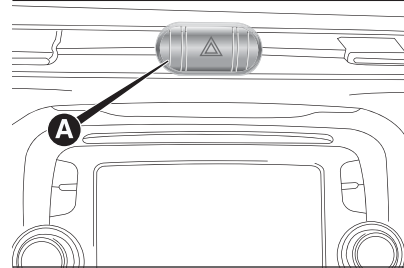

40

A0K0622

Warning lights \leftarrow and \rightarrow on the instrument panel switch on and switch A flashes when the lights are on.

Emergency braking

In the event of emergency braking the hazard warning lights are lit up automatically as well as the \leftarrow and \rightarrow warning lights in the panel.

The lights switch off automatically when emergency braking ceases.



17)

FOG LIGHTS

(for versions/markets, where provided)

Operation

Press button ☰ fig. 41 to switch the lights on/off.

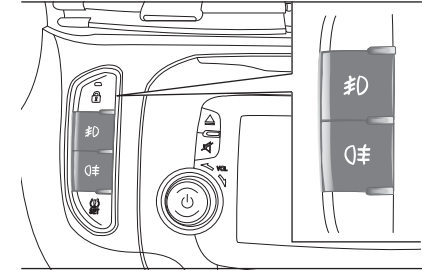

41

A0K0609

With the lights on, warning light ☰ in the instrument panel switches on.

REAR FOG LIGHTS

Operation

Press button ☷ fig. 41 to switch the lights on/off.

The rear fog lights are only switched on with the dipped headlights or front fog lights on.

Press the button again to switch the lights off, or switch off the dipped headlights or the front fog lights (for versions/markets, where provided).

With the lights on, warning light ☷ in the instrument panel switches on.

CENTRAL LOCKING

Operation

Press the  fig. 42 button to lock all doors at the same time.

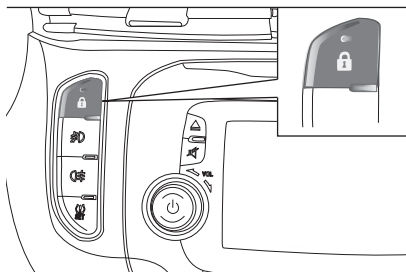

42

A0K0588

Locking takes place irrespective of the position of the ignition key.

FUEL CUT-OFF SYSTEM

Operation

This intervenes in the case of an impact causing:

- the interruption of the fuel supply with the engine consequently cutting out;
- the automatic unlocking of the doors;
- the interior lights being switched on.

The intervention of the system is indicated by a message shown on the display.

Carefully check the car for fuel leaks, for instance in the engine compartment, under the car or near the tank area.



After a collision, turn the ignition key to STOP to prevent the battery from running down.

To restore the correct operation of the car, proceed as follows:

- turn the ignition key to the MAR-ON position;
- activate the right direction indicator;
- deactivate the right direction indicator;
- activate the left direction indicator;
- deactivate the left direction indicator;
- activate the right direction indicator;
- deactivate the right direction indicator;
- activate the left direction indicator;
- deactivate the left direction indicator;
- turn the ignition key to the STOP position;
- turn the ignition key to the MAR-ON position.



WARNING

17) The use of hazard warning lights is governed by the Highway Code of the country you are driving in: comply with legal requirements.

18) If, after an impact, you smell fuel or notice leaks from the fuel system, do not reactivate the system to avoid the risk of fire.



INTERIOR FITTINGS

STORAGE COMPARTMENTS



Upper compartment

Operate in the point shown by the arrow to open the compartment A fig. 43.

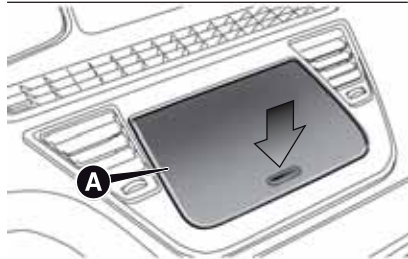

43

AOK0565

Passenger side glove compartment

Operate handle A fig. 44 to open the compartment.

When the compartment is opened, a courtesy light switches on.

There is a document holder inside the compartment and an eyewear holder on the rear of the flap.

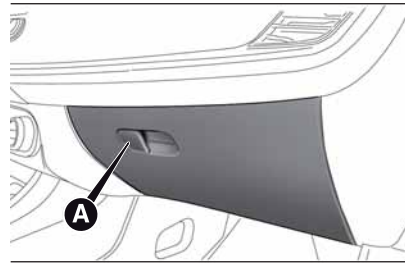

44

AOK0566

On some versions the compartments may be heated/cooled by an air vent connected to the climate control system (operate wheel A fig. 45 to adjust the air flow rate in the lower compartment).

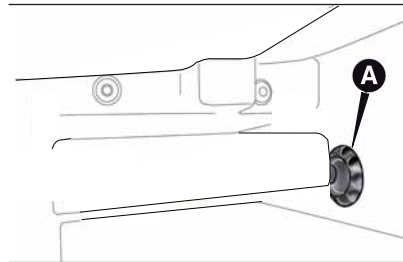

45

AOK0567

In versions with dual-zone automatic climate control system, the glove compartment is set to the same temperature as the passenger's side.

FRONT ARMREST

(for versions/markets, where provided)

This is located between the front seats. To bring it to its standard use position, push it downwards.

The front armrest is equipped with an inner storage compartment.

To access the compartment, position the armrest in the standard use configuration (fully down) and then lift the cover with lining A fig. 46.

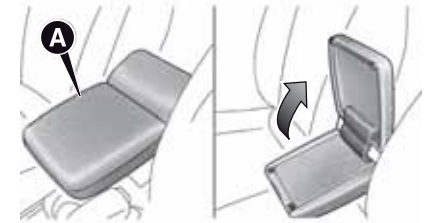

46

AOK0568

For correct use of the armrest specific measures must be followed for the opening of the cover:

- it must be opened only with armrest completely lowered;
- to prevent content of the armrest from falling, the opening of the cover is inhibited in positions other than "completely lowered".

NOTE During the armrest tilting stage (complete tilting upwards or downwards), make sure the cover with lining is always closed correctly.

REAR ARMREST

(for versions/markets, where provided)

To use armrest A fig. 47, lower it as shown in the figure.

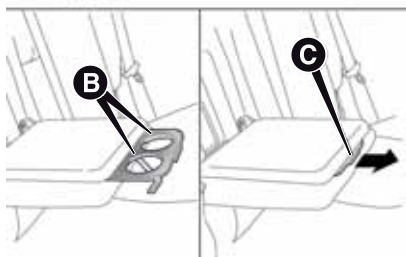
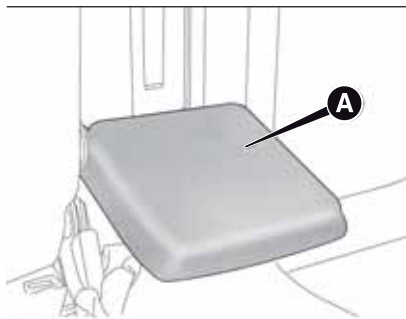

47

A0K0569

Two B cup or can holders are obtained in the armrest. To use these, pull tab C in the direction shown by the arrow.

A storage compartment is available inside the armrest; this can be accessed by raising the flap.

SKI COMPARTMENT

(for versions/markets, where provided)

The compartment may be used for carrying long loads.

To access the compartment, lower the rear armrest and then press device A fig. 48 to lower flap B.

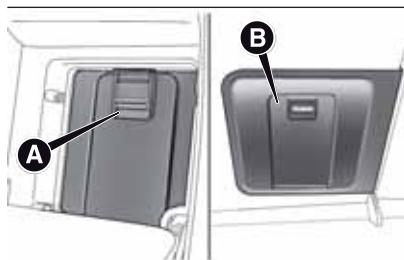

48

A0K0570

POWER SOCKETS

These are located on the central tunnel fig. 49 and on the left side of the luggage compartment fig. 50 (for versions/markets, where provided). They only operate with the ignition key at MAR-ON.

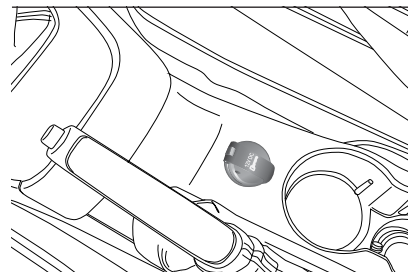

49

A0K0670

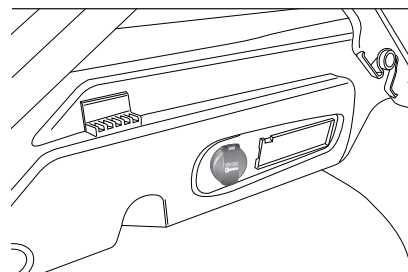

50

A0K0571

If you request the smokers' kit, the socket on the central tunnel is replaced with a cigar lighter (see following paragraph).



IMPORTANT Do not connect devices with power higher than 180 W to the socket. Do not damage the socket by using unsuitable adaptors.

CIGAR LIGHTER

This is located on the central tunnel. Press button A fig. 51 to activate the cigar lighter.

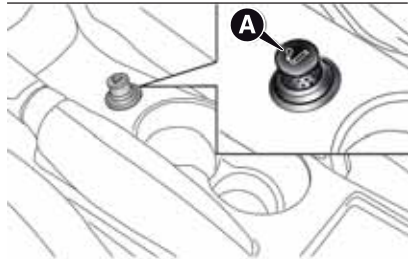

51

A0K0572

After a few seconds the button goes back to its initial position and the cigar lighter is ready for use. ⚠ 20)

IMPORTANT Always check that the cigar lighter has switched off.

IMPORTANT Do not connect devices with power higher than 180 W to the socket. Do not damage the socket by using unsuitable adaptors.

ASHTRAY

The ashtray is a removable spring-loaded plastic box that can be fitted into the glass/can holder on the central tunnel fig. 52. ⚠ 21)



52

A0K0573

MONEY HOLDER

(for versions/markets, where provided)

On some versions a money holder is present on the central tunnel fig. 53.

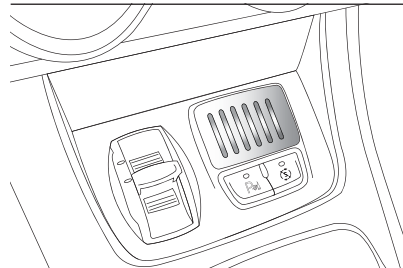

53

A0K0808

SUN VISORS

These are located at the sides of the interior rear view mirror. They can be adjusted forwards and sideways.

A courtesy mirror with light is fitted behind the visors. The light allows to use the mirror in poor visibility conditions.

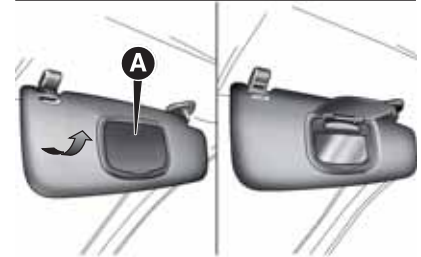

54

A0K0574

Lift cover A fig. 54 to access the mirror.

IMPORTANT On both sides of the passenger side sun visor there is a label remembering that it is compulsory to deactivate the airbags if a rearward facing child restraint system is fitted. Always comply with the instructions on the sun visor (see the "Front airbag" paragraph in chapter "Safety").

EXTINGUISHER

(for versions/markets, where provided)

This is located under the front passenger seat fig. 55.



55

A0K0575

NOTE On some versions, the extinguisher is located on the right side of the luggage compartment inside a suitable container.



WARNING

19) Do not travel with the storage compartments open: they may injure the front seat occupants in the event of an accident.

20) The cigar lighter reaches high temperatures Handle it carefully and make sure that children do not use it: risk of fire and/or burns.

21) Do not use the ashtray as a waste paper basket: it may catch fire in contact with cigarette stubs.

ELECTRIC SUN ROOF

(for versions/markets, where provided)

The sun roof comprises two glass panels; the front one is mobile and the rear one fixed. These feature two sun blinds (front and rear) that can be moved manually.

With the roof closed, the blinds can be placed in any position.

OPERATION

The sun roof can be operated only with the ignition key turned to MAR-ON.

Controls A and B fig. 56 on the panel next to the front roof light control sun roof opening/closing.

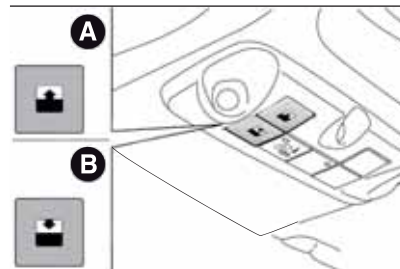

56

A0K0576



Roof opening

Press and hold down button A fig. 56: the front glass panel will move into the spoiler position. Press button A again and keep it pressed for more than half a second to automatically move the sun roof to an intermediate position ("Comfort" position).

If button A fig. 56 is pressed again for more than half a second, the roof will automatically continue until it reaches end of travel position. The front glass panel can be stopped in an intermediate position by pressing the button again.



Closing the sun roof

With the roof in the fully open position, press button B fig. 56: if the button is operated for more than half a second, the front roof glass will automatically assume the intermediate position ("Comfort" position).

If the button is operated again for about half a second the roof will assume the spoiler position. Lastly, if closing button B is pressed again, the roof will move to completely closed position.

ANTI-PINCH SAFETY DEVICE

The sun roof has an anti-pinch safety system capable of detecting the presence of an obstacle whilst the roof is closing; when this happens, the system stops and the movement of the front glass is immediately reversed.

SUN BLINDS

To open the blinds, grip handle A fig. 57, following the direction indicated by the arrow until the desired position is reached.

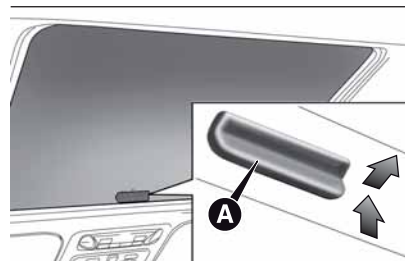

57

AOK0577

To close them, carry out the procedure in reverse.

INITIALISATION PROCEDURE

After the battery has been disconnected or a fuse has blown, the operation of the sun roof must be initialised again.

Proceed as follows:

- press button B fig. 56 until the roof is completely closed. Then release the button;
- press button B and hold it down for at least 10 seconds and/or until the glass panel clicks forwards. Release the button at this point;
- within 5 seconds of the previous operation, press button B and hold it down: the front glass panel will complete a full opening and closing cycle. Only release the button at the end of this cycle.

MAINTENANCE/ EMERGENCY

In the event of emergency or maintenance, the roof can be moved manually when there is no power supply (opening/closing of the front glass panel) by carrying out the following operations:

- remove the protective cap A fig. 58 located on the internal lining, between the two sun blinds;

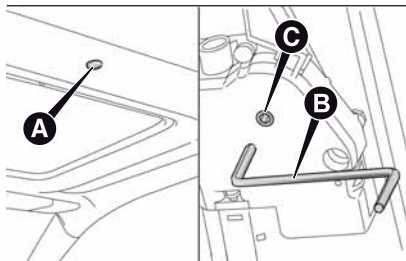

58

A0K0578

- take the Allen key B supplied, which is located in the on-board documentation container or in the tool container in the luggage compartment;
- introduce the key into housing C and turn it clockwise to open the roof or anticlockwise to close the roof.



IMPORTANT

3) Do not open the sun roof if there is snow or ice on it: you may damage it.



WARNING

22) When leaving the car, always remove the key from the ignition to avoid the risk of injury due to accidental operation of the sunroof. Improper use of the roof can be dangerous. Before and during operation, always check that no one is exposed to the risk of being injured by the moving sun roof or by objects getting caught or hit by it.

DOORS

DOOR CENTRAL LOCKING/UNLOCKING

Locking from the outside

With the doors closed, press the  button on the key (or on the dashboard fig. 59) or fit and then turn the metal insert (located inside the key) in the driver side door lock.

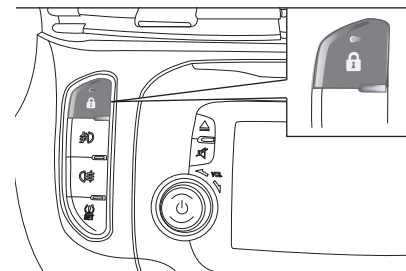

59

A0K0588

The door locking function is operated:

- with all the doors closed;
- with all the doors closed and the luggage compartment open:



Door unlocking from the outside

Press the  button on the key or turn the metal insert (located inside the key) in the driver side door lock.

Door locking/unlocking from the inside

Press button  fig. 59 on the dashboard.

IMPORTANT With central locking active, pulling the internal opening lever of the passenger side door unlocks the door itself. Pulling the internal opening lever of the driver side door activates central unlocking.

IMPORTANT The rear doors cannot be opened from the inside when the child lock device is engaged.

In the absence of electrical power supply (e.g. blown fuse, battery disconnected, etc.) it is still possible to lock the doors manually.

CHILD SAFETY DEVICE

This prevents the rear doors from being opened from the inside.

Device A fig. 60 can only be engaged with the doors open:

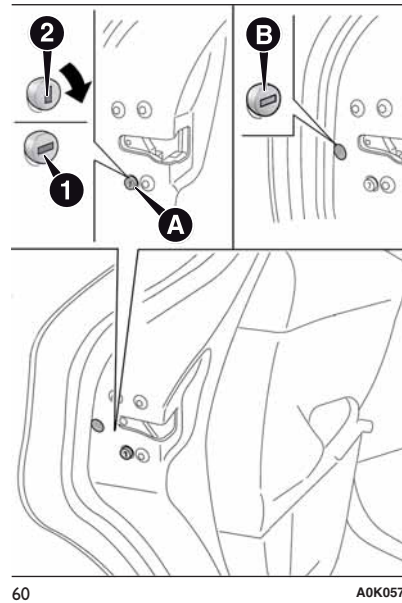

60

A0K0579

- position 1 - device engaged (door locked);
- position 2 - device not engaged (door may be opened from the inside).

The device remains engaged even if the doors are unlocked remotely.  4) 5)

IMPORTANT The rear doors cannot be opened from the inside when the child lock device is engaged.

EMERGENCY DOOR LOCKING DEVICE

Front passenger side door

The front passenger side door has a device to lock it when there is no current.

To lock it, fit the metal insert of the ignition key in the housing A fig. 61 and move it upwards.

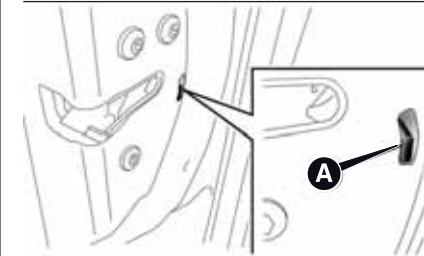

61

A0K0580



Rear doors

The rear doors are fitted with an emergency device that allows the doors to be locked when there is no current.

In this case, proceed as described below:

- fit the metal insert of the ignition key into housing B;
- turn the key anticlockwise and then remove it from housing B.

The door lock knob can be realigned (only when the battery charge has been restored) as follows:





- press button  on the key;
- press the  locking/unlocking button on the dashboard;
- opening the door by inserting the key in the front door pawl;
- operate the internal door handle.



6)

Opening/closing mechanism initialisation

If the battery is disconnected or the protection fuse blows, the door opening/closing mechanism must be initialised as follows:

- close all the doors;
- press the  button on the key or the  button on the dashboard;
- press the  button on the key or the  button on the dashboard.



IMPORTANT

- 4) **Always use this device when carrying children.**
- 5) **After engaging the device on both rear doors, check for proper engagement by trying to open a rear door with the internal handle.**
- 6) **If the child lock was engaged and the previously described locking procedure carried out, operating the internal opening handle will not open the door, just the realignment of the lock knob. To open the door, pull the external handle. The door central locking/unlocking button  is not disabled by the engagement of the emergency lock.**

ELECTRIC WINDOWS

These operate when the ignition key is turned to MAR-ON and for about 3 minutes after turning the key to STOP or removing it if one of the front doors is open.

The buttons are located in the door panel trim fig. 62 (the driver side door panel can be used to operate all the windows).

An anti-pinch device operates when the front and rear windows are raised.



23)

CONTROLS

Driver side front door fig. 62

- A: front left window opening/closing; “continuous automatic” operation during window opening/closing stage;
- B: front right window opening/closing; “continuous automatic” operation during window opening/closing stage;
- C: enabling/disabling of rear door electric window controls;



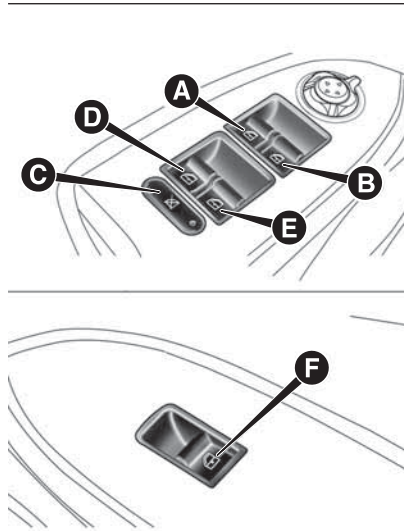

62

A0K0581

- D: rear left window opening/closing (for versions/markets where provided); “continuous automatic” operation during window opening/closing stage
- E: rear right window opening/closing (for versions/markets, where provided); “continuous automatic” operation during window opening/closing stage.

Window opening

Push the buttons to open the desired window.

When one of the two buttons is pressed briefly, the window moves in "stages"; if the button is held down, "continuous automatic" operation is activated.

If the control button is pressed again, the window will stop in the desired position. If the button is held down for several seconds, the window raises or lowers automatically (only with ignition key in MAR position).

Window closing

Lift the buttons to close the desired window.

The window closing stage occurs following the same logics described for the opening stage.

Front and rear passenger doors

(for versions/markets, where provided)

On the passenger side front door control panel, and on some versions also on the rear doors, buttons F fig. 62 are provided to control the associated windows.

Anti-crush safety device

The car is equipped with an anti-crush function for the raising of the front and rear windows.



This safety system detects the presence of an obstacle during the window closing travel and intervenes by stopping and reversing the window travel, depending on its position. This device is also useful if the windows are activated accidentally by children on board the car.

The anti-crush safety function is active both during the manual and the automatic operation of the window. When the anti-crush system is activated, the window travel is immediately interrupted and then reversed. The window cannot be operated in any way during this time.

IMPORTANT If the anti-crush protection intervenes 5 consecutive times within a minute or is faulty, the automatic closing operation of the window is inhibited, only allowing it in steps of half a second with the button released for the subsequent manoeuvre.

In order to restore the correct operation of the system, the relevant window must be lowered.

IMPORTANT With ignition key at STOP or removed, the electric windows remain active for about 3 minutes and are deactivated when a door is opened.

IMPORTANT With the anti-crush system, when the  button on the remote control is pressed for longer than 2 seconds the windows will open, whilst if the  button is pressed for longer than 2 seconds the windows will close.



IMPORTANT

7) *The system conforms to the 2000/4/EC standard concerning the safety of passengers leaning out of the passenger compartment.*



WARNING

23) *Incorrect use of the electric windows may be dangerous. Before and during their operation, ensure that any passengers are not at risk from the moving glass either by personal objects getting caught in the mechanism or by being hit by it directly. When leaving the car, always remove the key from the ignition to prevent accidental operation of the electric windows from being a hazard for those still on board.*

Electric window system initialisation

The system must be re-initialised after disconnecting the battery or if the relevant protection fuse is blown.

Initialisation procedure:

- fully close the window to initialise manually;
- after the window has reached the upper end of travel, hold the up button pressed for at least one second.

For versions/markets where provided, after there has been no power supply for the control units (battery replaced or disconnected or protection fuses for the electric window control units replaced), the automatic operation of the windows must be restored.

The restoration procedure must be performed as described below with the doors closed:

- completely open the driver's door window keeping the operating button pressed for at least three seconds after the (lower) end of travel position is reached;
- completely raise the driver side window and hold the button down for at least 3 seconds once the (upper) end of travel position has been reached;
- proceed in the same way as described in points 1 and 2 for the passenger side door;
- make sure that the initialisation is correct by checking that the windows work automatically.



LUGGAGE COMPARTMENT

The luggage compartment unlocking is electrically operated and is deactivated when the car is in motion.

OPENING

When unlocked, the luggage compartment can be opened from outside the car by pressing the electric logo fig. 63 until a click, which indicates unlocking, is heard or by pressing the  button on the key.



63

AOK0068

The direction indicators will blink twice and an internal light will switch on when the luggage compartment is opened: the light will go out automatically when the luggage compartment is closed. The light switches off automatically after a few minutes if the luggage compartment is left open.

Emergency opening from the inside

To carry out the emergency opening from the inside of the car, remove the rear seat head restraints, completely fold down the rear seats (see paragraph “Extending the luggage compartment”), then press on lever A fig. 64.

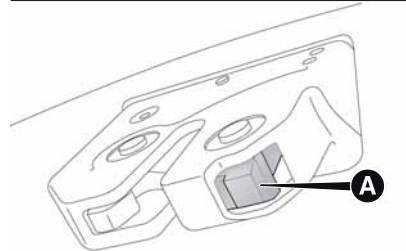

64

AOK0583

CLOSING

Lower the tailgate, pressing near the lock until you hear it click into place.

There are handles A fig. 65 inside the tailgate to allow it to be closed more easily.

IMPORTANT Before closing the luggage compartment make sure that you have the keys since the luggage compartment is automatically locked.

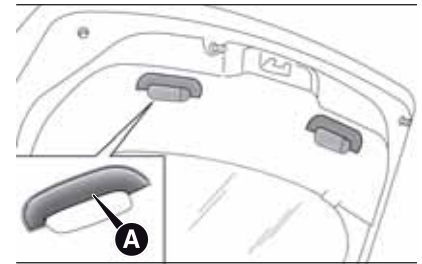



65

AOK0584

LUGGAGE COMPARTMENT INITIALISATION

IMPORTANT If the battery is disconnected or the protection fuse blows, the luggage compartment opening/closing mechanism must be initialised as follows:

- close all the doors and the luggage compartment;
- Press button  on the key;
- Press button  on the key.

EXTENDING THE LUGGAGE COMPARTMENT

The luggage compartment can be partially (1/3 or 2/3) or totally extended by splitting the rear seat.

See the descriptions in “Removing the parcel shelf” and “Folding back the seats” paragraphs for how to expand the luggage compartment.

Removing the parcel shelf

Proceed as follows:

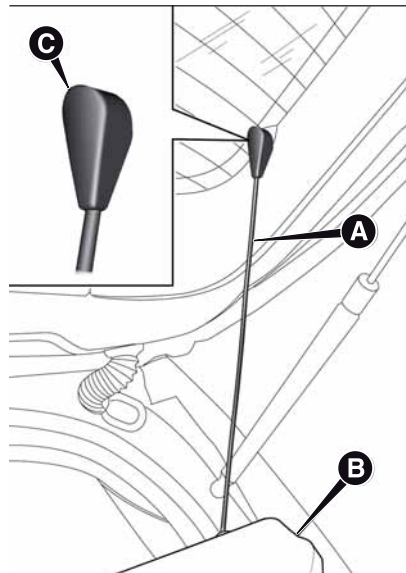

66

A0K0586

- free the ends of the two parcel shelf B mounting links A fig. 66 by removing the eyelets C from the mounting pins;
- free the pins A fig. 67 outside the shelf then remove the parcel shelf B sliding it outwards.

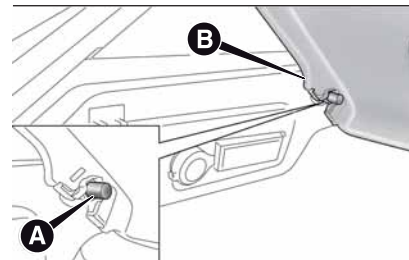

67

A0K0585

- after removal, the parcel shelf can be loaded sideways into the luggage compartment or placed between the front seat backrests and the folded-back rear seat cushions (with the luggage compartment completely expanded).

Folding the seats

Proceed as follows:

- raise the headrests to the maximum height, press both buttons A and B fig. 68 to the side of the two supports, then remove the head restraints by sliding them upwards;
- move the seat belts to the side, making sure that they are correctly extended and not twisted;

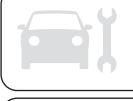

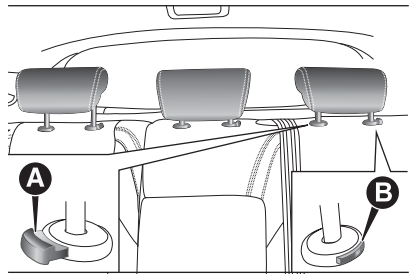

68

A0K0625

- raise lever A fig. 69 to fold the left or right side of the backrest and then guide the backrest onto the cushion (when lever A is raised, you will see a “red band” B).

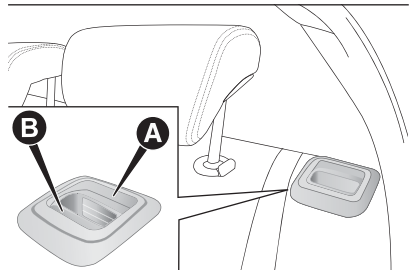

69

A0K0628

Repositioning the rear seat

Move the seat belts to the side, making sure that they are correctly extended and not twisted.

Raise the previously folded backrest until you hear the click of the locking mechanism, visually checking that the “red band” on lever A fig. 69 has disappeared. The “red band” indicates that the backrest is not secured.

Finally, reposition the head restraints, inserting them correctly into their housings.

SECURING YOUR LOAD

The luggage compartment contains two attachments A fig. 70 (for versions/markets, where provided) for the cables that secure the load transported and another two attachments are located on the rear crossmember B.

⚠ 24) 25)

IMPORTANT Every attachment has a maximum load capacity of 100 kg.

BAG HOOKS

There are also bag hooks inside the luggage compartment.

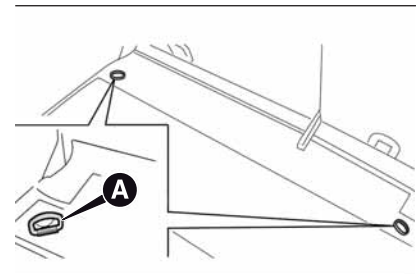

70

A0K0589

LUGGAGE RETAINING NET

(for versions/markets, where provided)

This is useful for correctly arranging the load and/or for transporting light materials. The luggage retaining net is available from Lineaccessori Alfa Romeo.



WARNING

24) A heavy load that has not been secured may cause serious injuries to passengers in the event of an accident.

25) If you are travelling in an area with limited opportunities for refuelling and you wish to bring petrol with you in a petrol can, you must do so in compliance with current regulations and using an approved can, appropriately secured to the load securing attachments. However, the risks of fire in case of collision increase anyway.

BONNET

OPENING

Proceed as follows:

- pull lever A fig. 71 in the direction indicated by the arrow;
- operate lever B, in the direction indicated by the arrow, and raise the bonnet.

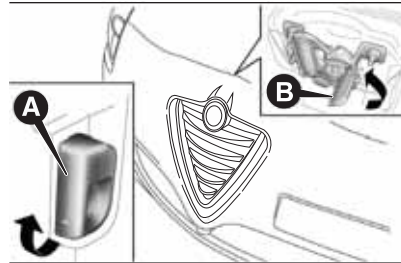

71

A0K0607

IMPORTANT Two side gas shock absorbers are provided to assist in opening the bonnet. Do not tamper with the shock absorber and accompany the bonnet while lifting it.

IMPORTANT Before raising the bonnet, make sure that the arms of the wipers are not raised from the windscreen and that the wiper is not operational.

CLOSING

Lower the bonnet to approximately 20 centimetres from the engine compartment then let it drop. Make sure that the bonnet is completely closed and not only fastened by the locking device by trying to open it. If it is not perfectly closed, do not try to press the bonnet down but open it and repeat the procedure.  26) 27)

IMPORTANT Always check that the bonnet is closed correctly to prevent it from opening while the car is travelling.

The following plate is applied inside the engine compartment fig. 72:



72

A0K2012



**WARNING**

26) For safety reasons, the bonnet must always be properly closed while driving. Therefore, make sure that the bonnet is properly closed and that the lock is engaged. If you discover that the bonnet is not perfectly closed during travel, stop immediately and close the bonnet in the correct manner.

27) Perform these operations only when the car is stationary.

ROOF RACK/SKI RACK

The attachments A are located in the areas illustrated in the figure and can only be accessed with the doors open.

 28) 29)

 8) 9)

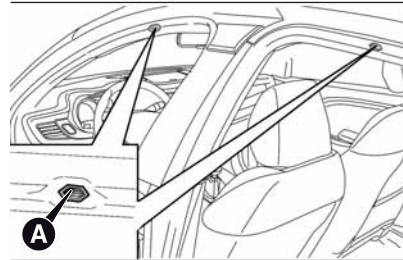

73

A0K0590

Lineaccessori Alfa Romeo includes a dedicated roof rack/ski rack for this car.

**WARNING**

28) After travelling for a few kilometres, check to ensure that the fixing screws for the attachments are well tightened.

29) Evenly distribute the load and take into account, when driving, the increased responsiveness of the car to side wind.

**IMPORTANT**

8) Never exceed the maximum permitted loads (see “Technical specifications” section).

9) The size of the loads you transport must strictly comply with currently applicable regulations.

HEADLIGHTS

LIGHT BEAM DIRECTION

The correct orientation of the headlights is important for the driver's comfort and safety as well as for all other road users. This is also covered by a specific rule of the highway code.

The headlights must be correctly directed to ensure the best visibility conditions for all drivers. Contact a Alfa Romeo Dealership to have the headlights checked and adjusted, if necessary.

HEADLIGHT ALIGNMENT CORRECTOR

This device works with the ignition key in the MAR position and the dipped headlights on.

Headlight alignment adjustment

To adjust, press the  and  fig. 74 buttons. The adjustment position is shown on the display.

Position 0 : one or two occupants in the front seats.

Position 1 : 4 people.

Position 2 : 4 people + load in luggage compartment.

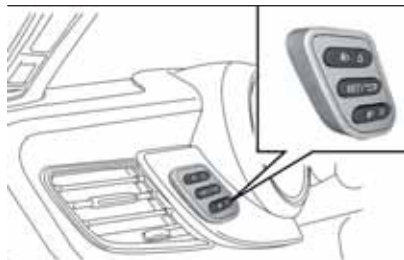



74

AOK0541

Position 3 : driver + maximum permitted load stowed in the luggage compartment.

IMPORTANT Check the alignment every time that the load carried changes.

IMPORTANT If the car is equipped with Bixenon headlights, the headlight alignment is controlled electronically, as a consequence the  and  buttons are not present.

FOG LIGHT ALIGNMENT

(for versions/markets, where provided)

Contact a Alfa Romeo Dealership to have the headlights checked and adjusted, if necessary.

ADJUSTING THE HEADLIGHTS ABROAD

The dipped headlights are aligned to comply with the regulations of the country of purchase. When travelling in countries with opposite driving direction, to avoid dazzling the drivers on the other side of the road, you need to cover areas of the headlight according to the Highway code of the country you are travelling in.

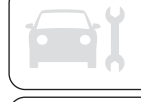

ESC SYSTEM

IN BRIEF

The ESC system improves the directional control and stability of the car in various driving conditions.

The ESC system corrects the car's understeer and oversteer, distributing the brake force on the appropriate wheels. The torque supplied by the engine can also be reduced in order to maintain control of the car.

 30) 31) 32) 33) 34)

The ESC system uses sensors installed on the car to determine the trajectory that the driver intends to follow and compares it with the car's effective trajectory. When the real trajectory deviates from the desired trajectory, the ESC system intervenes to counter the car's understeer or oversteer.

- Oversteer*: occurs when the car is turning more than it should according to the angle of the steering wheel.
- Understeer*: occurs when the car is turning less than it should according to the angle of the steering wheel.

The ESC system also includes the following systems:

- EBD
- ABS
- CBC
- ASR
- HILL HOLDER
- HBA
- MSR
- DST
- "ELECTRONIC Q2" ("E-Q2")
- "PRE-FILL" (RAB - Ready Alert Brake)

SYSTEM ACTIVATION

The ESC system switches on automatically when the engine is started and cannot be switched off.

SYSTEM INTERVENTION

This is indicated by the flashing of the  warning light on the instrument panel, to inform the driver that the car is in critical stability and grip conditions.

EBD SYSTEM

The EBD system is an integral part of the ESC system and intervenes during braking, distributing the brake force optimally between front and rear wheels.

This guarantees greater braking stability for the car, preventing sudden locking of the rear wheels and the consequent instability of the car.

ABS

This system, which is an integral part of the braking system, prevents one or more wheels from locking and slipping in all road surface conditions, irrespective of the intensity of the braking action, ensuring that the car can be controlled even during emergency braking and optimising stopping distances.

The system intervenes when braking and the wheels are about to lock, typically in emergency braking or low-grip conditions, when locking may be more frequent.

The system also improves control and stability of the car when braking on a surface where the grip of the left and right wheels varies, or on corners.

System intervention

A slight pulsing of the brake pedal and noise indicates the intervention of the ABS: this is completely normal when the system intervenes.

 35) 36) 37) 38) 39) 40) 41)

CBC (Cornering Brake Control) SYSTEM

The system acts when braking on corners, optimising the distribution of brake pressure on the four wheels: the system prevents the wheels on the inside of the corner (less affected by the weight of the car) from locking, ensuring better stability and direction for the car.

ASR (Anti-Slip Regulation) SYSTEM

 42) 43) 44)

This is an integral part of the ESC system and automatically operates in the event of one or both drive wheels slipping, loss of grip on wet roads (aquaplaning) and acceleration on slippery, snowy or icy roads, etc.

Depending on the slipping conditions, two different control systems are activated:

- if the slipping involves both drive wheels, the ASR system intervenes, reducing the power transmitted by the engine;
- if the slipping only involves one of the drive wheels, it also intervenes automatically, braking the wheel that is slipping.

System intervention

This is indicated by the flashing of the  warning light on the instrument panel, to inform the driver that the car is in critical stability and grip conditions.

HILL HOLDER SYSTEM

This is an integral part of the ESC system and facilitates starting on slopes, activating automatically in the following cases:

- uphill: car stationary on a road with a gradient higher than 5%, engine running, brake pressed and gearbox in neutral or gear (other than reverse) engaged;
- downhill: car stationary on a road with a gradient higher than 5%, engine running, brake pressed and reverse gear engaged.

When setting off, the ESC system control unit maintains the braking pressure on the wheels until the engine torque necessary for starting is reached, or in any case for a maximum of 2 seconds, allowing your right foot to be moved easily from the brake pedal to the accelerator.

When two seconds have elapsed, without starting, the system is automatically deactivated, gradually releasing the braking pressure. During this release stage it is possible to hear a typical mechanical brake release noise, indicating the imminent movement of the car.

IMPORTANT The Hill Holder system is not a parking brake; therefore, never leave the car without having engaged the handbrake, turned the engine off and engaged first gear, so that it is parked in safe conditions (for further information read the "Parking" paragraph in the "Starting and driving" chapter).



IMPORTANT There may be situations on small gradients (less than 8%), with car laden, in which the Hill Holder system may not activate, causing a slight reversing motion and increasing the risk of collision with another vehicle or object. The driver is, in any case, responsible for safe driving.

HBA (Hydraulic Brake Assist) SYSTEM



The HBA system is designed to improve the car's braking capacity during emergency braking. The system detects emergency braking by monitoring the speed and force with which the brake pedal is pressed, and consequently applies the optimal brake pressure. This can reduce the braking distance: the HBA system therefore completes the ABS.

Maximum assistance from the HBA system is obtained by pressing the brake pedal very quickly. In addition, the brake pedal should be pressed continuously during braking, avoiding intermittent presses, to get the most out of the system.

Do not reduce pressure on the brake pedal until braking is not necessary anymore.

The HBA system is deactivated when the brake pedal is released.

MSR (Motor Schlepplmoment Regelung) SYSTEM

This system is an integral part of the ABS, that intervenes, if there is a sudden downshifting, restoring torque to the engine, thereby preventing excessive drive at the drive wheels which, especially in poor grip conditions, could lead to a loss in stability of the car.

DST SYSTEM (Dynamic Steering Torque)

This function integrates Dual Pinion active steering into the operation of ESC. For particular manoeuvres, the ESC system controls the steering to actuate a steering torque and assist the driver in the best possible way.

The system operates the brakes and steering in a coordinated manner to increase the suspension and safety level of the car as a whole. The steering provides additional torque on the steering wheel.

"ELECTRONIC Q2" SYSTEM ("E-Q2")

The "Electronic Q2" system intervenes during acceleration on corners, braking the inner drive wheel and thus increasing the traction of the outer wheel (which bears more of the car's weight): the torque is thus distributed optimally between the drive wheels in accordance with the driving conditions and road surface, permitting particularly effective, sporty driving.

"PRE-FILL" SYSTEM (RAB - Ready Alert Brake)

(only with "Dynamic" mode activated)

This function activates automatically if the accelerator pedal is released rapidly, reducing the brake pad travel (both at front and back), with the aim of preparing the braking system and enhancing its responsiveness, thus reducing the stopping distance in the event of subsequent braking.



WARNING

- 30) The ESC system can't alter the natural laws of physics, and can't increase grip which depends on the condition of the road.
- 31) The ESC system cannot prevent accidents, including those due to excessive speed on corners, driving on low-grip surfaces or aquaplaning.
- 32) The capability of the ESC system must never be tested irresponsibly and dangerously, in such a way as to compromise personal safety and the safety of others.
- 33) For the correct operation of the ASR system, the tyres must of necessity be the same make and type on all wheels, in perfect condition and, above all, of the prescribed type and dimensions.
- 34) The performance of the ESC and ASR systems must not encourage the driver to take unnecessary risks. Your driving style must always be suited to the road conditions, visibility and traffic. The driver is always responsible for road safety.
- 35) When the ABS intervenes and you feel the brake pedal pulsating, do not reduce the pressure, but hold it down firmly and confidently; in doing so you will brake in the shortest distance possible, depending on the current road conditions.
- 36) For maximum efficiency of the braking system, a bedding-in period of about 500 km is required: during this period it is advisable to avoid sharp, repeated and prolonged braking.
- 37) If the ABS intervenes, this indicates that the grip of the tyres on the road is nearing its limit: you must slow down to a speed compatible with the available grip.
- 38) The ABS can't overrule the natural laws of physics, and can't increase the grip available according to the condition of the road.
- 39) The ABS cannot prevent accidents, including those due to excessive speed on corners, driving on low-grip surfaces or aquaplaning.
- 40) The capability of the ABS must never be tested irresponsibly and dangerously, in such a way as to compromise personal safety and the safety of others.
- 41) For the correct operation of the ABS, the tyres must of necessity be the same make and type on all wheels, in perfect condition and, above all, of the prescribed type and dimensions.
- 42) The ASR system can't overrule the natural laws of physics, and can't increase the grip available according to the condition of the road.
- 43) The ASR system cannot prevent accidents, including those due to excessive speed on corners, driving on low-grip surfaces or aquaplaning.
- 44) The capability of the ASR system must never be tested irresponsibly and dangerously, in such a way as to compromise personal safety and the safety of others.
- 45) The HBA system can't alter the natural laws of physics, and can't increase grip which depends on the condition of the road.
- 46) The HBA system cannot prevent accidents, including those due to excessive speed on corners, driving on low-grip surfaces or aquaplaning.



47) *The capability of the HBA system must never be tested irresponsibly and dangerously, in such a way as to compromise the safety of the driver, the other occupants of the car or any other road user.*

“Alfa DNA” SYSTEM (Car dynamic control system)

This device allows, using lever A fig. 75 (on the central tunnel), three car response modes to be selected according to driving style and road conditions:

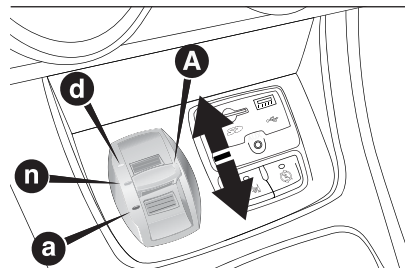

75

A0K0612

- d = **Dynamic** (sports driving mode);
- n = **Natural** (mode for driving in normal conditions);
- a = **All Weather** (mode for driving in poor grip conditions, such as rain and snow).

The device also acts on the dynamic car control systems (engine, steering, VDC system, instrument panel).

When lever A fig. 75 is moved to “d” position, the activation of “Dynamic” mode is confirmed by a temporary variation in the brightness (flashing) of the instrument panel.

DRIVING MODES

Lever A is monostable type. In other words, it always remains in a central position.

The selected driving mode is indicated by the corresponding LED coming on in the panel and by an indication on the reconfigurable multifunction display, as illustrated below:

- Dynamic mode** fig. 76 (display image available for versions/markets, where provided)



76

A0K0591

- All Weather Mode** fig. 77



77

A0K0592

“Natural” mode

When “Natural” mode is selected, no messages or symbols are shown on the display.

ESC and ASR systems: intervention thresholds aimed at comfort and safety in normal grip and driving conditions.

“ELECTRONIC Q2” system: the system is calibrated to ensure the best driving comfort.

Steering wheel tuning: functions aimed at comfort in normal conditions of use.

DST: braking standard control coordinated with ABS/ESC. Standard control over lateral acceleration. Oversteer compensation: a slight pulse on the steering wheel encourages the driver to carry out the most appropriate manoeuvre.

Engine: standard response.

ENGAGEMENT/ DISENGAGEMENT OF “Dynamic” MODE

IMPORTANT For versions/markets, where provided, switching to “Dynamic” mode is automatically disabled in the first kilometres in order to guarantee correct settling of the mechanical components. If an attempt to activate the system is made before this limit, the display will show a dedicated message to remind the driver that this request cannot be fulfilled.

Engagement

Move lever A fig. 75 upwards (next to the letter “d”) and hold in this position for 0.5 seconds until the corresponding LED lights up or the word “Dynamic” appears on the display (see fig. 78).



78

A0K1510

Upon release, lever A returns to the central position.

ESC and ASR: intervention thresholds that allow more enjoyable, sportier driving whilst guaranteeing stability of the vehicle.

“ELECTRONIC Q2” system: the system is calibrated to increase traction whilst accelerating on bends, improving the vehicle agility

Steering wheel tuning: uses the sports mode function.

DST: braking standard control coordinated with ABS/ESC. Standard control over lateral acceleration. Oversteering compensation depending on the ESC/ASR intervention thresholds: a slight movement on the steering wheel encourages the driver to carry out the most appropriate manoeuvre.

Engine: prompter response + Overboost to maximise torque (for versions/markets, where provided).

RAB: by pre-positioning of the brake pads (front and rear) following a rapid release of the accelerator pedal to reduce braking times, shorten stopping distances and improve the brake pedal feeling.



The activation of the Dynamic mode is also shown by the change in the instrument panel lighting that, after decreasing, reaches the highest luminosity and then returns to the previously set values.

Disengagement

To deactivate "Dynamic" mode and return to "Natural", repeat the same movement of the lever within the same times. In this case, the LED corresponding to "Natural" mode will light up and the words "Natural on" will appear on the display (see fig. 79).



79

AOK1059

ENGAGEMENT/ DISENGAGEMENT OF "All Weather" MODE

Engagement

Move lever A fig. 75 downwards (to the letter "a") and hold in this position for 0.5 seconds until the corresponding LED lights up or the word "All Weather" appears on the display (see fig. 80).

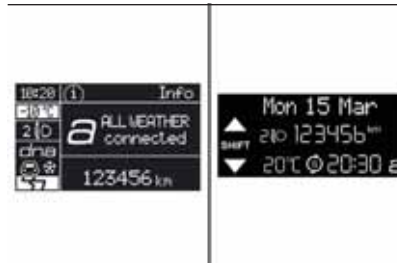

80

AOK1511

ESC and ASR systems: intervention thresholds aimed at guaranteeing the maximum safety in low grip driving conditions. It is recommended to activate the "All Weather" mode when fitting snow chains.

"ELECTRONIC Q2" system: the system is deactivated.

Steering wheel tuning: maximum comfort.

DST: higher braking control coordinated with ABS/ESC. Standard control over lateral acceleration. Oversteering compensation depending on the ESC/ASR intervention thresholds: a slight movement on the steering wheel encourages the driver to carry out the most appropriate manoeuvre.

Engine: standard response.

Disengagement

To deactivate "All Weather" mode and return to "Natural", carry out the same procedure described for "Dynamic" mode, but move lever A fig. 75 to "a".

IMPORTANT

- It is not possible to switch directly from "Dynamic" mode to "All Weather" mode and vice versa. You must always first go back to "Natural" mode and then select the other mode.
- The driving mode engaged before the engine stops is maintained when it is next started.
- In the event of system failure or a fault with lever A, no driving modes can be selected. The display will show a warning message.

START&STOP SYSTEM

(for versions/markets, where provided)

IN BRIEF

The Start&Stop system automatically stops the engine each time the car is stationary and starts it again when the driver wants to move off.

In this way, the efficiency of the car is increased, by reducing consumption, emissions of harmful gases and noise pollution.

OPERATING MODES

Engine stopping mode

With the car stopped, the engine stops with gearbox in neutral and clutch pedal released.

NOTE The engine can only be stopped automatically after exceeding about 10 km/h, to prevent the engine from being repeatedly stopped when driving at walking pace.

The  fig. 81 symbol appears on the display when the engine stops.



81

A0K0163

Restarting the engine

Press the clutch pedal to restart the engine.

SYSTEM MANUAL ACTIVATION/DEACTIVATION

To activate/deactivate the system manually, press the  button located on the central tunnel fig. 82.

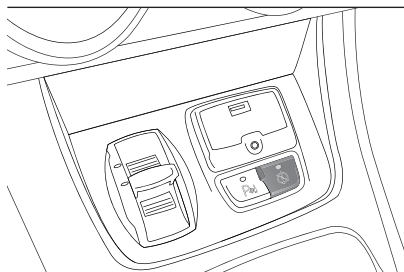

82

A0K0613

Start&Stop system activation

A message will be displayed when the Start&Stop system is activated. In this condition, the LED on the button  is off.

Turning the Start&Stop off

- Versions with multifunction display: a message is displayed when the Start&Stop system is deactivated.
- Versions with reconfigurable multifunction display: the  symbol is displayed + a message when the Start&Stop system is deactivated.

The LED on the button  switches on when the system is deactivated.

ENGINE STOPPING FAILURE CONDITIONS

When the system is active, due to comfort, emission control and safety reasons, the engine does not stop in some conditions, among which  10):

- engine still cold;
- especially cold outside temperature;
- battery not sufficiently charged;
- particulate filter regeneration (DPF) in progress (diesel engines only);



- driver's door not shut;
- driver's seat belt not fastened;
- reverse gear engaged (for example, for parking manoeuvres);
- for versions equipped with dual zone automatic climate control (for versions/markets, where provided), if an adequate level of thermal comfort has not been reached or with MAX-DEF function activation;
- during the first period of use, to initialise the system.

ENGINE RESTARTING CONDITIONS

Due to comfort, emission control and safety reasons, the engine can restart automatically without any action by the driver, under special conditions, such as:

- battery not sufficiently charged;
- reduced braking system vacuum (e.g. if the brake pedal is pressed repeatedly);
- car moving (e.g. when driving on roads with a gradient);
- engine stopping by Start&Stop system for over 3 minutes;

- for versions equipped with dual zone automatic climate control system (for versions/markets, where provided), if an adequate level of thermal comfort has not been reached or MAX-DEF function activation.

With gear engaged, automatic engine restarting is possible only by fully depressing the clutch pedal. The driver is informed by the displaying of a message on the display and - for versions/markets, where provided - by the flashing of the symbol .

Notes

If the clutch is not pressed, about 3 minutes after the engine stops, the engine can be restarted only using the ignition key.

In cases when the engine stops and this is not desired, due for example to the clutch pedal being released sharply with a gear engaged, if the Start&Stop system is activated, the engine can be restarted by fully depressing the clutch pedal or by placing the gear lever in neutral.

SAFETY FUNCTIONS

When the engine is stopped by the Start&Stop system, if the driver releases his/her seat belt and opens the driver's or passenger's door, the engine can be restarted only using the ignition key.

The driver is informed by a buzzer and by the flashing of the symbol  on the display; on some versions, a message is displayed as well.

"ENERGY SAVING" FUNCTION



(for versions/markets, where provided)

If, following automatic engine restarting, the driver does not carry out any action on the car for over 3 minutes, the Start&Stop system stops the engine once and for all, to prevent fuel consumption. In these cases, the engine can be restarted only using the ignition key.

NOTE In any case, it is possible to keep the engine running by deactivating the Start&Stop system.

IRREGULAR OPERATION

In the event of malfunction, the Start&Stop system is deactivated.

The driver is informed of the fault by the flashing  symbol (versions with multifunction display) or  symbol (versions with reconfigurable multifunction display). For versions/markets where provided, a message is also displayed.

In this case, contact an Alfa Romeo Dealership.

CAR INACTIVITY

In the event of car inactivity (or if the battery is replaced), special attention must be paid to the disconnection of the battery power supply.

Proceed as follows: detach connector A fig. 83 (by pressing button B) from sensor C for monitoring the status of the battery installed on the negative battery pole D. This sensor should never be disconnected from the pole except if the battery is replaced.  48)

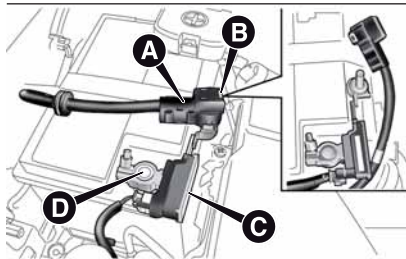

83

A0K0594

IMPORTANT After turning the ignition key to STOP and having closed the driver's side door, wait at least one minute before disconnecting and then reconnecting the battery electrical supply.

JUMP STARTING

When jump starting, never connect the negative lead (-) of the auxiliary battery to the negative pole A fig. 84 of the car battery, but rather to an engine/gearbox earth point.  49)

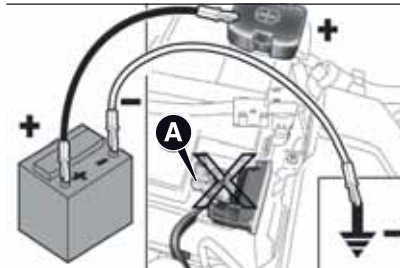

84

A0K0755

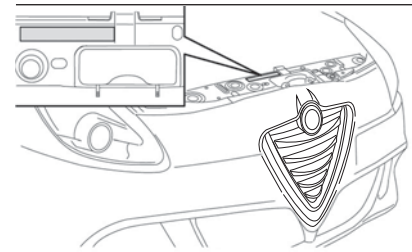

85

A0K0614



IMPORTANT

10) If you wish to run the air conditioning system, you may deactivate the Start&Stop system to allow continuous operation of the air conditioning system.





WARNING

48) When replacing the battery, always contact an Alfa Romeo Dealership. The replacement battery should be of the same type (HEAVY DUTY) and should have the same characteristics.

49) Before opening the bonnet, make sure that the engine is off and that the ignition key is in the STOP position. Follow the instructions on the dedicated label on the front crossmember (fig. 85). We recommend that you remove the key from the ignition if other people remain in the car. The car should always be left after the key has been removed or turned to the STOP position. During refuelling, make sure that the engine is off (and that the ignition key is in the STOP position).

iTPMS (indirect Tyre Pressure Monitoring System)

(for versions/markets, where provided)

DESCRIPTION

The car can be equipped with the iTPMS (indirect Tyre Pressure Monitoring System) which monitors the tyre inflation status thanks to wheel speed sensors.

The system warns the driver if one or more tyres are flat by the dedicated warning light (!) continuously on and a warning message on the display.

If one tyre only is flat, the system can indicate its position: it is anyway recommended to check the pressure on all four tyres.

This indication is displayed also when turning the engine off and on again until the RESET procedure is carried out.

RESET PROCEDURE

The iTPMS system needs an initial "self-learning" phase (with length depending on the driving style and road conditions: optimal conditions being driving on a straight road at 80 km/h for at least 20 minutes) which starts when the RESET procedure is carried out.

The Reset procedure must be carried out:

- whenever the tyre pressure is modified;
- when even only one tyre is changed;
- when tyres are rotated/inverted;
- when the space-saver wheel is fitted.

Before carrying out the RESET, inflate the tyres to the rated pressure values specified in the inflation pressure table (see "Wheels" paragraph in the "Technical specifications" section).

If the RESET is not carried out, in all above cases, the warning light (!) may give false indications on one or more tyres.

To carry out the RESET, with the car stopped and the ignition key at MAR-ON, press the button (!) fig. 86 on the dashboard for 2 seconds; after the RESET, the display shows a dedicated message, indicating that the "self-learning" has started.

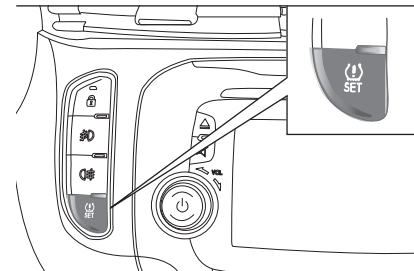

OPERATING CONDITIONS

 50) 51) 52) 53) 54) 55)

The system is active for speeds above 15 km/h.

In a few situations such as sporty driving, particular conditions of the road surface (e.g. icy, snowy, unsurfaced roads) the signalling may be delayed or partial in detecting the contemporary deflation of more than one tyre.

Under special conditions (e.g. car loaded asymmetrically on one side, towing a trailer, damaged or worn tyre, fitting the space-saver wheel, use of the "Fix&Go Automatic" kit, fitting snow chains, fitting different tyres on the axles) the system may give false indications or be temporarily deactivated.

If the system is temporarily deactivated the  warning light flashes for about 75 seconds and then is continuously on; at the same time, the display shows a dedicated message.

This indication is displayed also after the engine has been switched off and then on again if the correct operating conditions are not restored.

IMPORTANT INFORMATION



WARNING

50) If the system signals a pressure decrease on a specific tyre, it is recommended to check the pressure on all four tyres.

51) iTPMS does not relieve the driver from the obligation to check the tyre pressure every month; it is not even to be considered a replacing system for maintenance or a safety system.

52) Tyre pressure must be checked with tyres cold. Should it become necessary for whatever reason to check pressure with warm tyres, do not reduce pressure even though it is higher than the prescribed value, but repeat the check when tyres are cold.

53) The iTPMS cannot indicate sudden tyre pressure drops (for example when a tyre bursts). In this case, stop the car, braking with caution and avoiding abrupt steering.

54) The system only warns that the tyre pressure is low: it is not able to inflate them.

55) An insufficient tyre inflation increases fuel consumption, reduces the tread duration and may affect the capacity of driving safely.

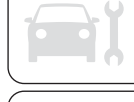

EOBD SYSTEM (European On Board Diagnosis)

(for versions/markets, where provided)

Operation

The EOBD system (European On Board Diagnosis) carries out a continuous diagnosis of the components of the car related to emissions.

It also alerts the driver, by switching on the  warning light on the instrument panel, together with a message on the display, when these components are no longer in peak condition (see "Warning lights and messages" paragraph in the "Knowing the instrument panel" chapter).

The aim of the EOBD system (European On Board Diagnosis) is to:

- monitor the system efficiency;
- indicate an increase in emissions;
- indicate the need to replace damaged components.

The car also has a connector, which can interface with appropriate tools, that makes it possible to read the error codes stored in the electronic control units together with a series of specific parameters for engine operation and diagnosis. This check can also be carried out by the traffic control authorities.

IMPORTANT After eliminating a fault, to check the system completely, the Alfa Romeo Dealership is obliged to run tests and, if necessary, road tests which may also require a long journey.

DUAL PINION ACTIVE STEERING

Operation

This only operates with the key turned to MAR-ON and the engine started. The steering allows the force required at the steering wheel to be adjusted to suit driving conditions. The different power assistance modes can be selected via the d, n, a positions of the "Alfa DNA System" lever (see paragraph entitled "Alfa DNA System").  56)

IMPORTANT After the battery is disconnected, the steering must be initialised. The warning light switches on to indicate this. To carry out this procedure, simply turn the steering wheel all the way from one end to the other or drive in a straight line for about a hundred metres.



WARNING

56) It is absolutely forbidden to carry out any after-market operation involving steering system or steering column modifications (e.g. installation of anti-theft device) that could adversely affect performance and safety, invalidate the warranty and also result in non-compliance of the car with type-approval requirements.

WIRING FOR RADIO SYSTEM

(for versions/markets, where provided)

If no **Uconnect™** 5" Radio or **Uconnect™** 6.5" Radio Nav was requested with the car, it is provided with a dual storage compartment in the dashboard fig. 87.

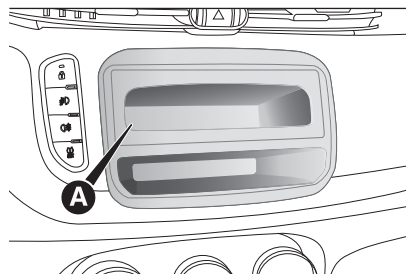

87

A0K0665

The radio setup system is composed of:

- car radio power supply cables, front and rear speakers and an aerial;
- radio housing;
- aerial on car roof.

The radio must be fitted in the special compartment A fig. 87, which can be removed by pressing the two retaining tabs in the compartment itself; the power supply cables are located in this area.  57)



WARNING

57) When connecting a radio to the radio system setup, contact an Alfa Romeo Dealership to prevent any faults from occurring that might compromise the safety of the car.



ACCESSORIES PURCHASED BY THE OWNER

If after purchasing the car, you decide to install electrical accessories that require a permanent electric supply (radio, satellite anti-theft system, etc.) or accessories that in any case burden the electric supply, contact an Alfa Romeo Dealership, whose qualified personnel, besides suggesting the most suitable devices from Lineaccessori Alfa Romeo, will also check whether the car's electrical system is able to withstand the load required, or whether it needs to be integrated with a more powerful battery.



58)

INSTALLING ELECTRICAL/ ELECTRONIC DEVICES

Electrical and electronic devices installed after buying the car in the context of after-sales service must carry the following label: fig. 88



88

DISPOSITIVI-ELETRONICI

Fiat Group Automobiles S.p.A. authorises the installation of transceiver devices on condition that such installations are carried out in a workmanlike fashion, following the manufacturer's instructions, at a specialised centre.

IMPORTANT Traffic police may not allow the car on the road if devices have been installed which modify the features of the car. This may also cause invalidation of warranty in relation to faults caused by the change either directly or indirectly related to it.

Fiat Group Automobiles S.p.A. shall not be liable for damage caused by the installation of accessories either not supplied or recommended by Fiat Group Automobiles S.p.A. and/or not installed in compliance with the provided instructions.

RADIO TRANSMITTERS AND MOBILE PHONES

Radio transmitter equipment (vehicle mobile phones, CB radios, amateur radio etc.) cannot be used inside the car unless a separate aerial is mounted on the roof.

IMPORTANT The use of these devices inside the passenger compartment (without a separate aerial) may cause the vehicle's electronic systems to malfunction. This could compromise safety in addition to constituting a potential hazard for passengers' health.

As far as the use of EC-approved mobile phones is concerned (GSM, GPRS, UMTS), follow the usage instructions provided by the mobile phone manufacturer.



WARNING

58) Take care when fitting additional spoilers or non-standard alloy wheels: they could reduce the ventilation of the brakes and affect efficiency in sharp, repeated braking or on long descents. Make sure that nothing obstructs the pedal stroke (mats, etc.).

PARKING SENSORS

(for versions/markets, where provided)

These are located in the car's front bumper fig. 89 and rear bumper fig. 90 and their function is to inform the driver, through an intermittent acoustic signal, about the presence of obstacles in front of and behind the car.

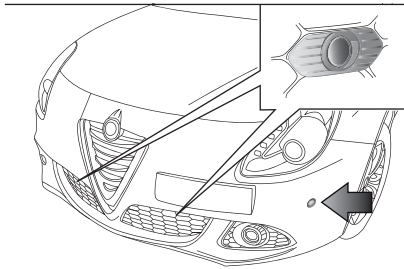

89

A0K0360

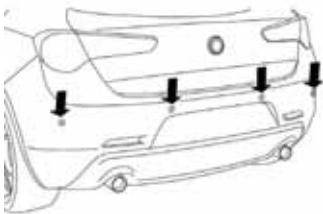

90

A0K0360

ACTIVATION

Version with rear sensors

On the versions with rear sensors, the system is activated when the reverse gear is engaged.

Version with front and rear sensors

On the versions with front sensors and rear sensors, the system is activated when the reverse gear is engaged or by pressing the button **P**  fig. 91.

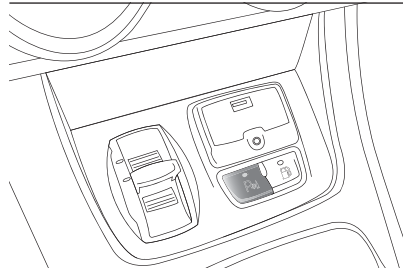



91

A0K0361

When reverse gear is released, the front and rear sensors remain activated until a speed of around 15 km/h is exceeded to allow the parking manoeuvre to be completed.

The system can also be activated by pressing the button **P**  in the central tunnel: a LED in the button switches on when the system is activated.

Every time the ignition key is turned to MAR-ON the LED on the button **P**  flashes briefly to indicate that the system is running a diagnosis. The LED activation should not be understood as a fault.

The sensors are deactivated by pressing the button **P**  again or when a speed of 15 km/h is exceeded: the LED in the button is off when the system is not active.

INDICATIONS ON DISPLAY

(for versions/markets, where provided)

Versions with rear sensors

When the sensor is activated, the "Reconfigurable multifunction display" (for versions/markets, where provided) shows the screen illustrated in fig. 92.

Versions with front and rear sensors

When the sensors are activated, the screen in fig. 93 appears on the "Reconfigurable multifunction display".





92

AOK0059

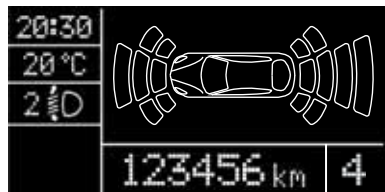

93

AOK0814

Obstacle presence and distance information is therefore provided both by the buzzer (volume of the acoustic warning cannot be adjusted) and the indication on the display.

If there are several obstacles, the closest one is displayed. On the version with front and rear sensors, the closest obstacle in the front area and in the rear area is displayed.

ACOUSTIC SIGNAL

The information concerning the presence and distance of an obstacle from the car is transmitted to the driver by means of acoustic signals from buzzers installed in the passenger compartment:

- in the versions with rear sensors*, a buzzer in the front dashboard area warns of the presence of obstacles at rear. The volume of the acoustic signal can be adjusted through the option "Warning volume" of the Setup menu (see "Menu items" paragraph in the "Knowing the instrument panel" section).
- in the versions with front and rear sensors*, a front buzzer warns of the presence of obstacles at the front and a buzzer located at the rear warns of the presence of obstacles at the rear. This permits the driver to perceive the direction (front/rear) of the obstacles.

Depending on the position of the obstacle (in front or at the rear) the sound is emitted by the corresponding buzzers (front or rear). The obstacle closest to the car is signalled.

When reverse gear is engaged an acoustic signal is automatically activated if there is an obstacle within the range of operation.

The acoustic signal:

- increases* as distance between the car and the obstacle decreases;
- becomes continuous* when the distance between the car and the obstacle is less than 30 cm and stops immediately if the distance increases;
- is constant* if the distance is unvaried; if this situation occurs for the side sensors, the signal will stop after about 3 seconds to avoid, for example, indications in the event of manoeuvres alongside walls.

OPERATION WITH TRAILER

Parking sensor operation is deactivated automatically when the trailer electric cable plug is fitted into the car tow hook socket.  11)

The sensors are automatically reactivated when the trailer's cable plug is removed.  59) 60)

GENERAL WARNINGS

During parking manoeuvres, pay the utmost attention to any obstacles that could be located above or below the sensors.

Objects located near the rear of the car are not detected under certain circumstances and could therefore cause damage to the car or be damaged.

The following conditions may influence the performance of the parking sensor system:

- ❑ reduced sensor sensitivity and a reduction in the parking assistance system performance could be due to the presence on the surface of the sensor of: ice, snow, mud, thick paint
- ❑ the sensors may detect a non-existent obstacle (echo interference) due to mechanical interference, for example when washing the car, in rain (strong wind), hail;
- ❑ The signals sent by the sensors can also be altered by the presence of ultrasonic systems (e.g. pneumatic brake systems or pneumatic drills) near the vehicle.

❑ sensor performance can also be influenced by the position of the sensors. For example by a change in the ride setting (caused by the wear of the shock absorbers, suspension), overloading the vehicle and carrying out specific tuning operations that require the vehicle to be lowered;

❑ The detection of obstacles at the top part of the car may not be guaranteed because the system detects obstacles that could cause an impact with the car in the bottom part.



IMPORTANT

11) The sensors must be clean of mud, dirt, snow and ice in order for the system to work. Be careful not to scratch or damage the sensors while cleaning them. Avoid using dry, rough or hard cloths. The sensors must be washed using clean water, with the addition of car shampoo if necessary. When using special washing equipment such as high pressure jets or steam cleaning, clean the sensors very quickly keeping the jet more than 10 cm away.



WARNING

59) Only have the bumpers repainted or any retouches to the paintwork in the area of the sensors carried out by an Alfa Romeo Dealership. Incorrect paint application could affect the operation of the parking sensors.



60) Parking and other dangerous manoeuvres are, however, always the driver's responsibility. While carrying out these manoeuvres, always make sure that no people (especially children) or animals are in the area concerned. The parking sensors are an aid for the driver, but the driver must never allow their attention to lapse during potentially dangerous manoeuvres, even those executed at low speeds.

REFUELLING THE CAR

Stop the engine before refuelling.

PETROL ENGINES

Only use unleaded petrol 95 R.O.N. compliant with the European specification EN228. The petrol octane rating (R.O.N.) must not be lower than 95. In order to prevent damage to the catalytic converter never introduce even the smallest amount of leaded petrol, even in the event of an emergency.

DIESEL ENGINES

Use only diesel fuel compliant with European specification EN590. The use of other products or mixtures may damage the engine beyond repair and consequently invalidate the warranty, due to the damage caused.

Operation at low temperatures

If the outside temperature is very low, the diesel thickens due to the formation of paraffin clots with consequent defective operation of the fuel supply system.

In order to avoid these problems, different types of diesel are distributed according to the season: summer type, winter type and arctic type (cold, mountain areas).

If refuelling with diesel whose specifications are not suitable for the usage temperature, it is advisable to mix TUTELA DIESEL ART additive in the proportions shown on the container with the fuel. Pour the additive into the tank before the fuel.

When using or parking the car for a long time in the mountains or cold areas, it is advisable to refuel using locally available fuel. In this case, it is also advisable to keep the tank over 50% full.

FILLING THE TANK

To fill the tank completely, top-up twice after the first click of the fuel supply gun. Further top-ups could cause faults in the fuel feeding system.

FUEL TANK CAP

The fuel flap is unlocked when the central locking system is released and automatically locked when the central locking system is applied.

Opening

Press flap A fig. 94 to release it and access fuel tank cap B. Then press cap B and turn it anticlockwise. ⚠ 61)

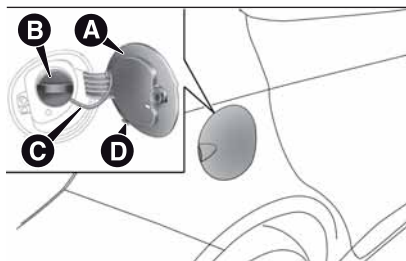

94

A0K0598

The cap is provided with a loss prevention device C which attaches it to the flap and prevents it from being lost. Attach the cap to device D during refuelling.

Emergency flap opening

In case of emergency, pull the cord A fig. 95 on the right-hand side of the boot to open the fuel flap.

Pulling the cord will unlock the flap: it will then be necessary to press on the flap to open it.

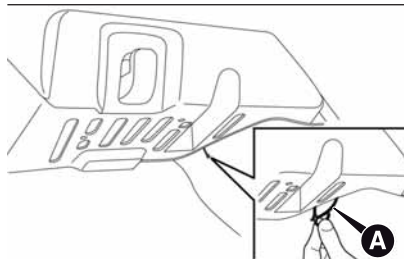

95

A0K0599

Closure

Release cap B from device D and insert it in its housing. Then tighten the cap clockwise until one or more clicks are heard. Finally, close flap A checking that it is correctly locked.

The sealing may cause a slight pressure increase in the tank. A little breathing off, while slackening the cap is absolutely normal.



WARNING

61) Keep naked flames or lit cigarettes away from the fuel tank filler: fire risk. Avoid bringing your face close to the filler, in order not to breathe in harmful vapours.

PROTECTING THE ENVIRONMENT

The following devices are used for reducing petrol fuel engine emissions: catalytic converter, oxygen sensors and evaporation control system

The following devices are used for reducing diesel fuel engine emissions: oxidising catalytic converter, exhaust gas recirculation system (EGR) and particulate filter (DPF).

⚠ 62)

DIESEL PARTICULATE FILTER (DPF)

(Diesel Particulate Filter)
(for versions/markets, where provided)

The Diesel Particulate Filter is a mechanical filter, integral to the exhaust system, that physically traps carbon particles present in the exhaust gases of diesel engines.

The diesel particulate filter is needed to eliminate almost all carbon particle emissions in compliance with current/future regulations and standards.



During standard use of the vehicle, the engine control unit records a set of data (e.g.: travel time, type of route, temperatures, etc.) and it will then calculate how much particulate has been trapped by the filter.

Since this filter physically traps particulate, it should be periodically regenerated (cleaned) at regular intervals by burning carbon particles.

The regeneration procedure is controlled automatically by the engine management control unit according to the filter conditions and vehicle use conditions.

During the regeneration there may be a limited increase in the engine idle speed, fan activation, a limited increase in fumes and high temperatures at the exhaust.

These are not faults; they do not impair normal car performance or damage the environment. If the dedicated message is displayed, see contents of "Warning lights and messages" paragraph, in chapter "Knowing the instrument panel".

**WARNING**

62) *The catalytic converter and particulate filter (DPF) reach very high temperatures during operation. Therefore do not park the car on flammable materials (e.g. grass, dry leaves, pine needles, etc.): fire hazard.*

KNOWING THE INSTRUMENT PANEL

This section of the booklet gives you all the information you need to understand, interpret and use the instrument panel correctly.

DISPLAY	84	- WATER IN DIESEL FILTER (diesel versions)	114
MENU ITEMS	87	- DPF CLEANING (particulate trap) in progress (diesel versions with DPF only)	116
CONTROL PANEL AND INSTRUMENTS	94	- iTPMS SYSTEM	117
TRIP COMPUTER	96	- ELECTRONIC STABILITY CONTROL (ESC) SYSTEM	119
WARNING LIGHTS AND MESSAGES	99	- ELECTRONIC STABILITY CONTROL (ESC) SYSTEM	120
- LOW BRAKE FLUID/HANDBRAKE ENGAGED	99	- CRUISE CONTROL (for versions/markets, where provided)	121
- EBD FAILURE	100	- SIDE LIGHTS	121
- AIRBAG FAILURE	100	- FOLLOW ME HOME	121
- SEAT BELTS NOT FASTENED	100	- DIPPED BEAM HEADLIGHTS	121
- ALTERNATOR FAILURE	101	- FOG LIGHTS	121
- LOW ENGINE OIL PRESSURE	102	- LEFT-HAND DIRECTION INDICATOR	122
- DEGRADED ENGINE OIL (for versions/markets, where provided)	103	- RIGHT-HAND DIRECTION INDICATOR	122
- ENGINE COOLANT TEMPERATURE TOO HIGH	105	- MAIN BEAM HEADLIGHTS	122
- ALFA TCT FAILURE	106	- FUEL CUT-OFF SYSTEM	123
- INCOMPLETE DOOR LOCKING	106	- POSSIBLE ICE ON ROAD	123
- SPEED LIMIT EXCEEDED	106	- BRAKE LIGHT FAILURE	123
- DUAL PINION ACTIVE STEERING FAILURE	107	- DUSK SENSOR FAILURE	123
- ALFA ROMEO CODE SYSTEM FAILURE/ALARM FAILURE	107	- RAIN SENSOR FAILURE	124
- FUEL RESERVE/LIMITED RANGE	108	- PARKING SENSOR FAILURE	124
- GENERAL FAILURE	109	- START&STOP SYSTEM ACTIVATION/DEACTIVATION (for versions/markets, where provided)	125
- GENERAL FAILURE	110	- START&STOP FAILURE	125
- REAR FOG LIGHTS	111	- DISPLAY OF SELECTED DRIVING MODE ("Alfa DNA" system)	126
- ABS FAILURE	112		
- BRAKE PAD WEAR	112		
- PASSENGER SIDE AIRBAG DEACTIVATED	112		
- INJECTION/EOBD SYSTEM FAILURE	113		
- GLOW PLUG HEATING/GLOW PLUG HEATING FAILURE (diesel versions)	114		



DISPLAY

The car may be provided with a multifunction or reconfigurable multifunction display that shows useful information to the driver, according to the previous settings, when driving.

With the ignition key removed, the display lights up and shows the time and total odometer reading (in km or miles) for a few seconds when a door is opened/closed.

MULTIFUNCTION DISPLAY "STANDARD" SCREEN

The following information appears on the display fig. 96:

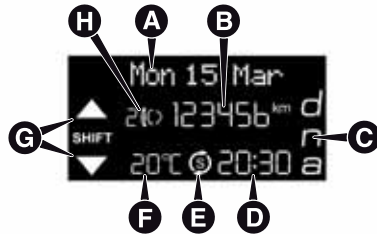

96

A0K2010

A Date

B Milometer (distance covered in km or miles)

C Driving mode selected via "Alfa DNA" (dynamic car control system) (for versions/markets, where provided): d = Dynamic; n = Natural; a = All Weather

D Time (always displayed, even with key removed and doors closed)

E Start&Stop function indicator (for versions/markets where provided)

F Outside temperature

G Gear Shift Indicator (for versions/markets, where provided)

H Headlamp alignment position (only with dipped headlamps on)

RECONFIGURABLE MULTIFUNCTION DISPLAY "STANDARD" SCREEN

The following information appears on the display fig. 97:

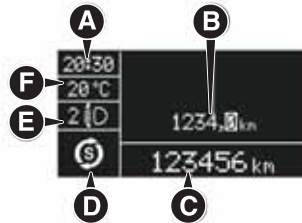

97

A0K0600

A Time

B Trip mileage (in km or miles)

C Milometer (distance covered in km or miles)

D Car status indications (e.g. doors open, possible ice on road, etc.)/Start&Stop function indication (for versions/markets, where provided)/Gear Shift Indicator (for versions/markets, where provided)

E Headlamp alignment position (only with dipped headlamps on)

F Outside temperature

On some versions, selecting "DYNAMIC" driving mode (see "Alfa DNA system" paragraph in this section) causes the display to show the turbine pressure fig. 98.



98

A0K0539

GEAR SHIFT INDICATOR

The "GSI" (Gear Shift Indicator) system advises the driver to change gear through a special indication on the display fig. 99.

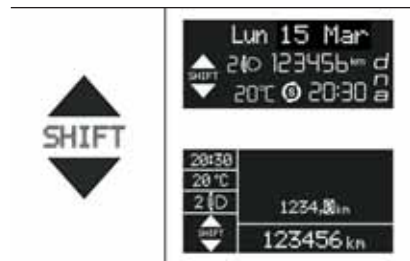

99

A0K0540

Through the GSI, the driver is notified that changing gear will allow a reduction in fuel consumption.

Therefore, for driving oriented towards reducing fuel consumption, it is recommended to stick to "Natural" or "All Weather" mode and to follow the suggestions of the Gear Shift Indicator, where the traffic conditions allow it.

When the SHIFT UP icon (▲ SHIFT) is shown on the display, the GSI is advising the driver to engage a higher gear, when the SHIFT DOWN (▼ SHIFT) icon is displayed, it advises the driver to engage a lower gear.

Note The indication in the instrument panel remains on until the driver shifts gear or the driving conditions go back to a situation where gearshifting is not required to improve consumption.

WELCOME MOVEMENT

On some versions, when the key is turned to MAR-ON, the following occurs:

- quick movement (up and down) of the speedometer and rpm gauge;
- lighting of graphic symbols/display;
- displaying of an animated graphic representation of the vehicle profile.

Gauge movement

- If the key is removed from the ignition switch whilst the gauges are moving, they immediately go back to their initial position.
- Once they have reached the full scale values, the gauges rest on the value indicated by the vehicle.
- The movement of the gauges stops when the engine is started.

Lighting of graphic symbols/display

A few seconds after the key is inserted, the gauges, graphic symbols and display light up in sequence.

Display of graphic animation

When the key is removed from the ignition switch (with the doors closed), the display remains lit up and shows a graphic animation.

The display lighting is then dimmed gradually until it goes out completely.

CONTROL BUTTONS

▲ fig. 100: to scroll up through the displayed screen and the related options or to increase the displayed value.

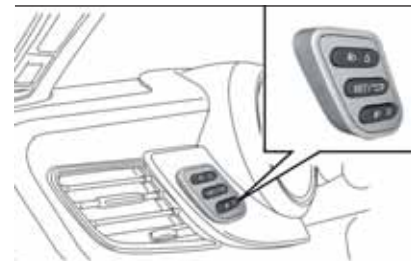

100

A0K0541

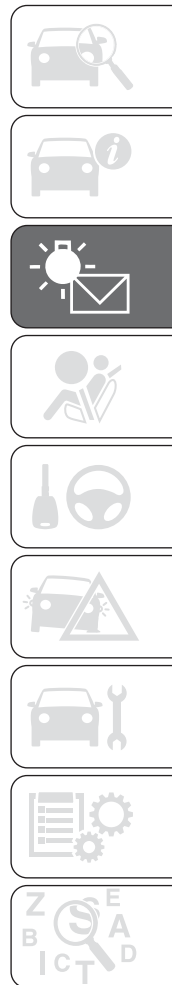

SET/↵ : press briefly to access the menu and/or go to next screen or confirm the selection. Hold down to go back to the standard screen.

↵▼ : to scroll down through the displayed menu and the related options or to decrease the value displayed.

IMPORTANT The ↵▲ and ↵▼ buttons activate different functions according to the following situations:

- within the menu, they allow you to scroll up and down through the options;
- during settings operations, they increase or decrease values.

SETUP MENU

The menu comprises a series of options which can be selected using the ↵▲ and ↵▼ buttons to access the different selection and setting (Setup) operations indicated below.

Some options have a submenu. The menu can be activated by briefly pressing the SET/↵ button.

The menu comprises the following options:

- MENU
- LIGHTING

- SPEED BEEP
- LIGHT SENSOR (for versions/markets where provided)
- RAIN SENSOR (for versions/markets, where provided)
- TRIP B ACTIVATION/DATA
- SET TIME
- SET DATE
- FIRST PAGE (for versions/markets where provided)
- AUTOCLOSE
- MEASUREMENT UNIT
- LANGUAGE
- BUZZER VOLUME
- SEAT BELT BEEP/BUZZ
- SERVICE
- AIRBAG/PASSENGER BAG
- DAYTIME RUNNING LIGHTS
- ADAPTIVE LIGHTS (for versions/markets, where provided)
- COURTESY LIGHTS
- MENU EXIT

Note On cars equipped with radio navigator systems (for versions/markets, where provided), some menu items are shown on the navigator display.

Selecting an option from the main menu without a submenu:

- press the SET/↵ button briefly to select the main menu setting you wish to change;
- press buttons ↵▲ or ↵▼ (with single presses) to select the new setting;
- press the SET/↵ button briefly to save the new setting and go back to the previous main menu option.

Selecting an option from the main menu with a submenu:



- briefly press the SET/↵ button to display the first submenu option;
- press buttons ↵▲ or ↵▼ (with single presses) to scroll through all the submenu options;
- briefly press the SET/↵ button to select the displayed submenu option and to open the relevant settings menu;
- press buttons ↵▲ or ↵▼ (with single presses) to select the new setting for this submenu option;
- press the SET/↵ button briefly to save the new setting and go back to the previous submenu option.

MENU ITEMS

IMPORTANT With **Uconnect™** 5" radio system (for versions/markets where provided), or **Uconnect™** 6.5" Radio Nav system (for versions/markets, where provided), some Menu items are displayed and managed through the system and not through the instrument panel (refer to the dedicated supplements).

Menu



This item allows you to access the Setup Menu.

Press the   button to select the various Menu options. Hold down the SET/↵ button to return to the standard screen.

Lighting (Car interior lighting adjustment) (only with side lights on)

This function is used to set the brightness of the instrument panel, **Uconnect™** system controls (for versions/markets where provided) and automatic climate control system controls (for versions/markets where provided) to 8 levels.

Proceed as follows to adjust the light intensity:



- press button SET/↵ briefly. The level set previously flashes on the display;
- press button   to set the required brightness level;
- briefly press the SET/↵ button to go back to the menu screen or hold the button down to go back to the standard screen without saving.





Note On versions with reconfigurable multifunction display, adjustment can be made both with lights off ("Daytime" mode brightness level) and with lights on ("Nighttime" mode brightness level).









Speed Beep (Speed limit)

With this function it is possible to set the car speed limit (km/h or mph); when this limit is exceeded the driver is alerted.

To set the desired speed limit, proceed as follows:

- briefly press the SET/↵ button: the display will show the wording "Speed Beep";
- press button   to select speed limit activation ("On") or deactivation ("Off");

- if the function is on, press   or   to select the desired speed limit and then press SET/↵ to confirm.

IMPORTANT Setting is possible between 30 and 200 km/h, or 20 and 125 mph, according to the previously set unit. See the "Unit of Measurement" paragraph described below. The setting will increase/decrease by five units each time button   /   is pressed. Hold down the   /   button to automatically increase/decrease the setting rapidly. Complete the adjustment with single presses of the button when you approach the desired value.

Briefly press the SET/↵ button to go back to the menu screen or hold the button down to go back to the standard screen without saving.

To cancel the setting, proceed as follows:

- briefly press the SET/↵ button, "On" will flash in the display;
- press button , "Off" will flash on the display;
- briefly press the SET/↵ button to go back to the menu screen or hold the button down to go back to the standard screen without saving.

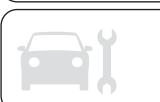

Headlight sensor (Automatic headlight/dusk sensor sensitivity adjustment) (for versions/markets, where provided)

This function enables the headlights to come on or go off depending on external lighting conditions.

The dusk sensor sensitivity can be adjusted according to 3 levels (level 1=minimum sensitivity, level 2=average sensitivity, level 3=maximum sensitivity).

The higher the sensitivity set, the lesser is the external light variation needed to switch the lights on (e.g. with a setting on level 3 at sunset the headlights come on in advance in relation to levels 1 and 2).

Proceed as follows to set the desired adjustment:

- press the SET/↵ button briefly to make the display flash the previously set level;
- press ▲ or ▼ to make your choice;
- briefly press the SET/↵ button to go back to the menu screen or hold the button down to go back to the standard screen without saving.

Rain sensor (Rain sensor sensitivity adjustment) (for versions/markets, where provided)

This function allows you to adjust the rain sensor sensitivity to 4 levels.

To set the required sensitivity level proceed as follows:

- briefly press the SET/↵ button, the previously set sensitivity level will flash on the display;
- press the ▲ or ▼ button to make the adjustment;
- briefly press the SET/↵ button to go back to the menu screen or hold the button down to go back to the standard screen without saving.

Activation/Trip B data (Trip B enablement)

This function may be used to activate (On) or deactivate (Off) the Trip B (partial trip). For further information see "Trip computer".

Proceed as follows to switch the function on and off:

- press the SET/↵ button briefly to make the display flash "On" or "Off" according to what was previously set;
- press ▲ or ▼ to make your choice;

- briefly press the SET/↵ button to go back to the menu screen or hold the button down to go back to the standard screen without saving.

Time adjustment (Clock adjustment)

This function enables to set the clock through two submenus: "Time" and "Format".

To carry out the adjustment, proceed as follows:

- briefly press the SET/↵ button and two submenus ("Time" and "Format") will be displayed;
- press the ▲ or ▼ button to switch between the two submenus;
- once you have selected a sub-menu to be modified, press SET/↵ briefly;
- when the "Time" submenu is entered, by briefly pressing SET/↵ the hours flash on the display;
- press the ▲ or ▼ button to make the adjustment;
- briefly press the SET/↵ button, which makes the display flash the "minutes";
- press the button ▲ or ▼ to make the adjustment.

IMPORTANT The setting will increase or decrease by one unit each time the button or is pressed. Hold down the button to increase/decrease the setting rapidly and automatically. Complete the adjustment with single presses of the button when you approach the desired value.

- When you select "Format": briefly pressing the SET/↔ button makes the display mode flash on the display;
- press button or to select "24h" or "12h".

When you have made the required settings, briefly press the SET/↔ button to go back to the submenu screen or hold the button down to go back to the main menu screen without saving the new settings.

Hold the SET/↔ button down again to return to the standard screen or to the main menu according to where you are in the menu.

Set date (Setting the date)

Using this function it is possible to change the date (day – month – year).

Proceed as follows to start the update:

- briefly press the SET/↔ button: the "year" starts flashing on the display;

- press the or button to make the adjustment;

- briefly press the SET/↔ button: the "month" will flash on the display;

- press the or button to make the adjustment;

- briefly press the SET/↔ button: the "day" will flash on the display;

- press the button or to make the adjustment.

IMPORTANT The setting will increase or decrease by one unit each time the button or is pressed. Hold the button down to increase/decrease the setting rapidly and automatically. Complete the adjustment with single presses of the button when you approach the desired value.

Briefly press the SET/↔ button to go back to the menu screen or hold the button down to go back to the standard screen without saving.

First page (Display of information on the main screen)

(for versions/markets, where provided)

This function allows you to choose the information you would like to see on the main screen. You can view the date or the trip distance.

To make your choice, proceed as follows:

- briefly press the SET/↔ button: "Initial page" will be displayed;

- press the SET/↔ button again briefly to display the "date" and "engine info" options;

- press or to select the information you wish to see on the main page of the display;

- briefly press the SET/↔ button to go back to the menu screen or hold the button down to go back to the standard screen without saving.

When the key is turned to MAR-ON and the initial check stage is over, the display will show the information selected via the "First page" menu function.

Autoclose (Automatic door lock operation with car running)

When activated (On), this function locks the doors automatically when the vehicle speed exceeds 20 km/h.

Proceed as follows to activate or deactivate this function:

- press the SET/↔ button briefly to display a submenu;



- press the SET/↵ button briefly to make the display flash "On" or "Off" according to what was previously set;
- press ▲ or ▼ to make your choice;
- press the SET/↵ button briefly to return to the submenu screen or hold the button down to return to the main menu screen without saving;
- hold the SET/↵ button down again to return to the standard screen or to the main menu according to where you are in the menu.

Unit of measurement (Setting the unit of measurement)

With this function it is possible to set the measurement units through three sub-menus: "Distance", "Consumption" and "Temperature".

To set the desired measurement unit, proceed as follows:

- briefly press the SET/↵ button to display the three sub-menus;
- press button ▲ or ▼ to navigate through the three submenus;

- once the submenu to be modified has been selected, briefly press the SET/↵ button;
- when the "Distance" submenu is entered: briefly pressing SET/↵ displays "km" or "mi" depending on the previous setting;
- press ▲ or ▼ to make your choice;
- when the "Consumption" submenu is entered, pressing SET/↵ displays km/l, l/100 km or mpg depending on the previous setting;

If the set distance unit is "km", the fuel consumption unit will be displayed in km/l or l/100 km.

If the distance unit set is "mi" the fuel consumption unit will be displayed in "mpg".

- press ▲ or ▼ to make your choice;
- when the "Temperature" submenu is entered, pressing SET/↵ displays "°C" or "°F" depending on the previous setting;
- press ▲ or ▼ to make your choice;

When you have made the required settings, briefly press the SET/↵ button to go back to the submenu screen or hold the button down to go back to the main menu screen without saving the new settings.

Hold the SET/↵ button down again to return to the standard screen or to the main menu according to where you are in the menu.

Language (Language selection)

Display messages can be shown in different languages: Italian, English, German, Portuguese, Spanish, French, Dutch, Turkish and Brazilian.



To set the desired language proceed as follows:

- briefly press the SET/↵ button: the previously set "language" starts flashing on the display;
- press ▲ or ▼ to make your choice;
- briefly press the SET/↵ button to go back to the menu screen or hold the button down to go back to the standard screen without saving.

Warnings volume (Adjusting the alert/warning acoustic signal volume)

With this function it is possible to adjust (to eight levels) the volume of the acoustic signal which sounds in the event of alerts and warning.

To set the desired volume proceed as follows:



- press the SET/↵ button briefly, making the display flash the previously set volume "level";
- press the  ▲ or  ▼ button to make the adjustment;
- briefly press the SET/↵ button to go back to the menu screen or hold the button down to go back to the standard screen without saving.

Belt reminder (Reactivation of SBR buzzer)

(for versions/markets, where provided)

This function can be displayed only after an Alfa Romeo Dealership has deactivated the SBR system (see paragraph "SBR system" in the "Safety" chapter).

To reactivate this function, proceed as follows:

- press the SET/↵ button briefly, the display shows "OFF" flashing. Press the  ▲ or  ▼ button and "On" will appear;
- briefly press the SET/↵ button to go back to the previous screen or hold the button down to go back to the standard screen without saving.

Service (Scheduled servicing)

This function allows you to display the information about km/mileage intervals or, for versions/markets, where provided, time intervals for car servicing.

To consult this information, proceed as follows:

- briefly press the SET/↵ button: the display shows when servicing is due in km/mi or days (where provided) or mi or days (where provided) according to the previous setting (see paragraph "Units of measurement");
- briefly press the SET/↵ button to go back to the menu screen or hold the button down to go back to the standard screen.

IMPORTANT The "Scheduled Servicing Plan" includes car maintenance at fixed intervals (refer to the "Maintenance and care" chapter). This is displayed automatically, with ignition key at MAR-ON, 2000 km (or equivalent value in miles) before servicing or, where provided, 30 days before servicing. It is also displayed each time the key is turned to MAR-ON or, for versions/markets, where provided, every 200 km (or equivalent value in miles). Below this threshold servicing indications are more frequent. The display will be in km or miles according to the unit of measurement set. When the next scheduled service is approaching, the word "Service" will appear on the display, followed by the number of kilometres/miles or days (where provided) left, when the key is turned to MAR-ON. Go to an Alfa Romeo Dealership, where the "Scheduled Servicing Plan" operations will be performed and the message will be reset.

When the service interval is reached and for about 1000 km/600 mi or 30 days, a service due message is displayed.



Passenger airbag/side bag (front passenger side airbag and side bag for pelvis, chest and shoulder protection - Side bag - activation/deactivation)

This function is used to activate/deactivate the passenger side air bag.

Proceed as follows:

- press the SET/↵ button and, after the message (Bag pass: Off) (to deactivate) or (Bag pass: On) (to activate) is displayed by pressing buttons "⏸▲" or "⏸▼", press the SET/↵ button again;
- a confirmation request message will appear on the display;
- by pressing the ⏸▲ or ⏸▼ buttons select "Yes" (to confirm activation/deactivation) or "No" (to cancel);
- press the SET/↵ button briefly, a message confirming the selection will be displayed and you will return to the menu screen or, pressing the button for longer, you will return to the standard screen without memorising.

Daytime running lights (DRL)

With this function is possible to turn the daytime running lights on and off.

Proceed as follows to activate or deactivate this function:

- press the SET/↵ button briefly to display a submenu;
- press the SET/↵ button briefly to make the display flash "On" or "Off" according to what was previously set;
- press ⏸▲ or ⏸▼ to make your choice;
- press the SET/↵ button briefly to return to the submenu screen or hold the button down to return to the main menu screen without saving;
- hold the SET/↵ button down again to return to the standard screen or to the main menu according to where you are in the menu.

AFS adaptive lights (Adaptive Frontlight System)

(for versions/markets, where provided)

This function allows the AFS (Adaptive Frontlight System) to be activated/deactivated.

Proceed as follows to activate or deactivate this function:

- press the SET/↵ button briefly to display a submenu;
- press the SET/↵ button briefly to make the display flash "On" or "Off" according to what was previously set;
- press ▲ or ▼ to make your choice;
- press the SET/↵ button briefly to return to the submenu screen or hold the button down to return to the main menu screen without saving;
- hold the SET/↵ button down again to return to the standard screen or to the main menu according to where you are in the menu.

Courtesy lights (Activation/deactivation of “Greeting lights”)

(for versions/markets, where provided)

With this function it is possible to turn on the side lights, the number plate lights and the ceiling lights for approximately 25 seconds when the doors or boot are opened using the remote control, with the following exceptions:

- interruption after 5 seconds from when the door closes
- interruption after locking using the remote control
- interruption after a lock or other action using the remote control

Proceed as follows to activate or deactivate this function:

- press the SET/↔ button briefly to make the display flash "On" or "Off" according to what was previously set;
- press Ⓜ▲ or Ⓜ▼ to make your choice;
- briefly press the SET/↔ button to go back to the menu screen or hold the button down to go back to the standard screen without saving.

Menu exit

This is the last function that closes the cycle of settings listed in the menu screen.

Pressing the SET/↔ button briefly will return the display to the standard screen without saving.

Press the Ⓜ▼ button to return to the first menu option.



CONTROL PANEL AND INSTRUMENTS

VERSIONS WITH MULTIFUNCTION DISPLAY

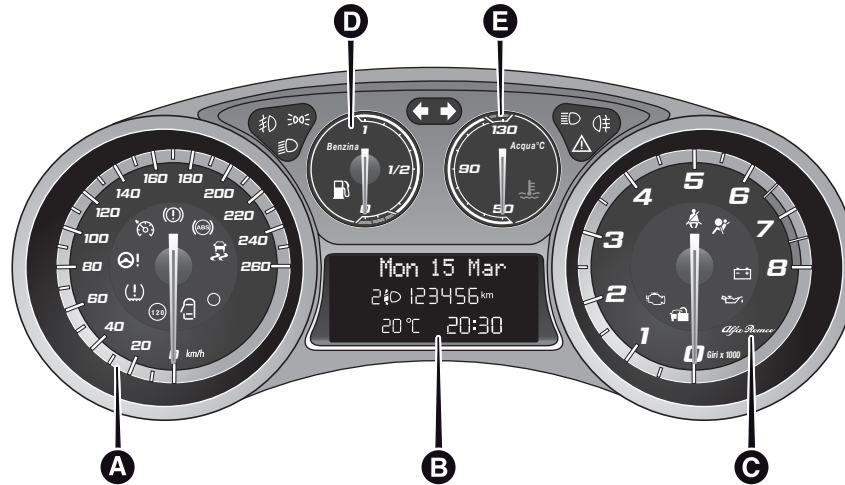

101

A0K2300

A. Speedometer (speed indicator) – B. Multifunction display – C. Rev counter – D. Fuel level gauge with reserve warning light – E. Engine coolant temperature indicator with overheating warning light

 Warning lights supplied on diesel versions only. On diesel versions, the end of scale for the rev counter is 6000 rpm

IMPORTANT The illumination of the instrument panel graphics may vary according to version.

VERSIONS WITH RECONFIGURABLE MULTIFUNCTION DISPLAY

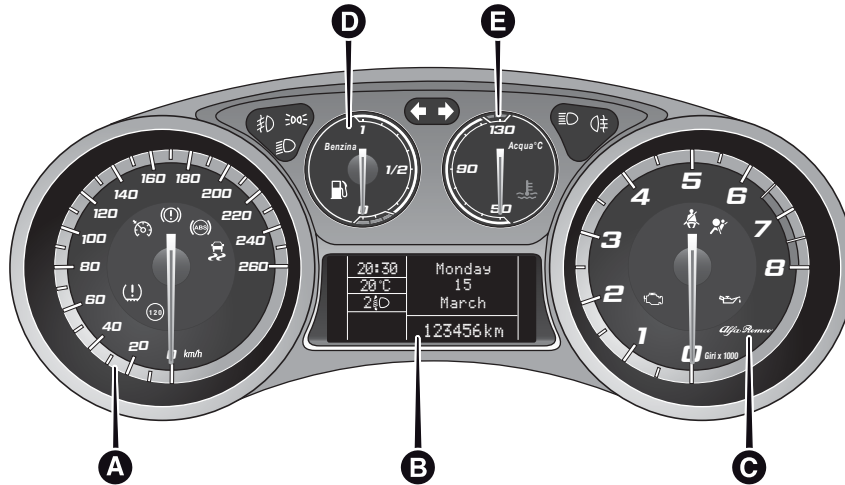

102

A0K2301

A. Speedometer (speed indicator) – B. Reconfigurable multifunction display – C. Rev counter – D. Fuel level gauge with reserve warning light – E. Engine coolant temperature indicator with overheating warning light

 Warning lights supplied on diesel versions only. On diesel versions, the end of scale for the rev counter is 6000 rpm

IMPORTANT The illumination of the instrument panel graphics may vary according to version.



SPEEDOMETER (SPEED INDICATOR)

This shows the speed of the car.

REV COUNTER

This indicates the engine rpm.

FUEL LEVEL GAUGE

This shows the amount of fuel left in the fuel tank.

The warning light in the gauge lights up when there are only 8 to 10 litres of fuel remaining in the tank; if this happens, refuel as soon as possible.

Do not travel with the fuel tank almost empty: any gaps in fuel delivery could damage the catalytic converter.

ENGINE COOLANT TEMPERATURE INDICATOR

The needle shows the temperature of the engine coolant and starts supplying indications when the fluid temperature exceeds approx. 50°C.

Under normal conditions, the needle assumes different positions within the scale depending on the usage conditions.

The warning light turns on to indicate an overheating of the engine coolant. In this case, stop the engine and contact an Alfa Romeo Dealership.

TRIP COMPUTER**IN BRIEF**

The Trip computer is used to display information on car operation when the key is turned to MAR.

This function is characterised by two separate memories, called "Trip A" and "Trip B", where the car's "complete missions" (journeys) are recorded in a reciprocally independent manner.

Both memories can be reset: i.e. start of a new journey.

"Trip A" is used to display the figures relating to:

- Range
- Distance travelled
- Average fuel consumption
- Instant fuel consumption
- Average speed
- Trip time (driving time).

"Trip B" may be used to display the figures relating to:

- Distance travelled B
- Average consumption B

Average speed B

Trip time B (driving time).

The "Trip B" function may be disabled (see "Activating Trip B"). "Range" and "Instant consumption" parameters cannot be reset.

VALUES DISPLAYED

Range

This indicates the indicative distance that may be travelled with the fuel in the tank, assuming that driving conditions do not change.

The display will show the reading '-----' when the following events take place:

- range value lower than 50 km (or 30 mi)
- car parked with engine running for a long period.

IMPORTANT The range can be affected by several factors: driving style (see "Driving style" paragraph in the "Starting and driving" chapter), type of route (motorway, towns and cities, mountain roads, etc.), conditions of use (load, tyre pressures, etc.). Trip planning must therefore take the above into account.

Distance covered

Shows the distance covered since the start of the new journey.

Average consumption

Shows the approximate average fuel consumption since the start of the new journey.

Instantaneous consumption

This indicates the fuel consumption. The value is constantly updated. The display will show "-----" if the car is parked with the engine running.

Average speed

This shows the average car speed as a function of the overall time elapsed since the start of the new journey.

Trip time

The time elapsed since the start of a new journey.

INDICATIONS ON THE DISPLAY

Each time a value is displayed, the following information is shown:

- animated icon in the upper part fig. 103;

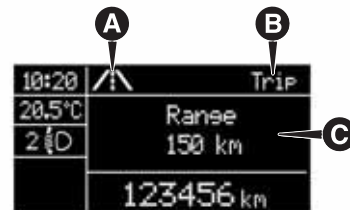

103

A0K2011

- the word "Trip" (or "Trip A" or "Trip B") (B);
- the name, value and unit of measurement of the selected parameter (e.g. "Range 1500 km") (C).

After a few seconds the name and value of the selected parameter are replaced by an icon fig. 104.



104

A0K0007



The icons relating to the various parameters are the following:

- "Range";
- A "Average consumption A" (if Trip A is active, or "B" if Trip B is active);
- A "Distance" (if Trip A is active, or "B" if Trip B is active);
- "Instantaneous consumption";
- A "Average speed A" (if Trip A is active, or "B" if Trip B is active);
- A "Trip time" (if Trip A is active, or "B" if Trip B is active);

TRIP BUTTON 0.00

The TRIP 0.00 button is located on the right hand stalkfig. 105. With the ignition key turned to MAR-ON, this button allows you to view the previously described values and also set them to zero to begin a new mission:

- short press: display various values;
- long press: values reset and start of a new mission.

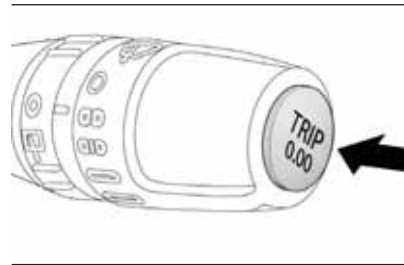

105

AOK0096

New mission

This begins after a reset:

- "manual" resetting by the user, by pressing the relevant button;
- "automatic" resetting, when the "trip distance" reaches 99999.9 km or when the "Travel time" reaches 999:59 (999 hours and 59 minutes);
- after disconnection/reconnection of the battery.

IMPORTANT The reset operation when "Trip A" details are being displayed only resets the information associated with this function.

IMPORTANT The reset operation when "Trip B" details are being displayed resets only the information associated with this function.

Start of journey procedure

With the ignition key at MAR-ON, reset by pressing the TRIP 0.00 button and holding it down for more than 2 seconds.

Trip Exit

You can automatically exit the Trip function once all the values have been displayed or by holding the SET/ button down for more than 1 second.

WARNING LIGHTS AND MESSAGES





IMPORTANT The warning light switches on together with a dedicated message and/or acoustic signal when applicable. These indications are indicative and precautionary and as such must not be considered as exhaustive and/or alternative to the information contained in the Owner Handbook, which you are advised to read carefully in all cases. Always refer to the information in this section in the event of a failure indication.

IMPORTANT Failure indications displayed are divided into two categories: very serious and less serious failures. Serious faults are indicated by a repeated and prolonged warning "cycle". Less serious faults are indicated by a warning "cycle" with a shorter duration. The display cycle of both categories can be interrupted. The instrument panel warning light will stay on until the cause of the malfunction is eliminated.

WARNING LIGHTS IN INSTRUMENT PANEL

Warning lights on panel	What it means	What to do
 red	<p>LOW BRAKE FLUID/HANDBRAKE ENGAGED</p> <p>The warning light switches on when the key is turned to MAR-ON, but it should switch off after a few seconds.</p>	
	<p>Low brake fluid level</p> <p>The warning light (or symbol on the display) switches on when the level of the brake fluid in the reservoir falls below the minimum level, possibly due to leaks in the circuit.</p> <p>The display shows the dedicated message.</p>	<p>Restore the brake fluid level, then check that the warning light has switched off.</p> <p>If the warning light stays on, contact an Alfa Romeo Dealership.</p>
	<p>Handbrake applied</p> <p>The warning light (or symbol on the display) switches on when the handbrake is engaged. If the car is moving an acoustic signal is also emitted.</p>	<p>Release the handbrake, then check that the warning light has switched off.</p> <p>If the warning light (or symbol on the display) stays on, contact an Alfa Romeo Dealership.</p>







Warning lights on panel	What it means	What to do
 <p>red</p>  <p>amber</p>	<p>EBD FAILURE</p> <p>The simultaneous switching on of the (ⓘ) (red) and (ABS) (amber) warning lights with the engine on, indicates either a fault of the EBD system or that the system is not available. In this case, the rear wheels may suddenly lock and the vehicle may swerve when braking sharply. The display shows the dedicated message.</p>	<p>Drive very carefully to the nearest Alfa Romeo Dealership to have the system inspected immediately.</p>
 <p>red</p>	<p>AIRBAG FAILURE</p> <p>When the key is turned to MAR-ON, the warning light switches on but should switch off after a few seconds. If the warning light switches on constantly, this indicates a fault in the airbag system. The display shows the dedicated message.</p>	 63) 64)
 <p>red</p>	<p>SEAT BELTS NOT FASTENED (for versions/markets, where provided)</p> <p>The warning light switches on constantly with the car stationary and the driver's seat belt not fastened. The warning light flashes and a buzzer sounds if the car is in motion and the front seat belts are not correctly fastened.</p>	<p>For permanent deactivation of the SBR (Seat Belt Reminder) system buzzer, contact an Alfa Romeo Dealership. The system can be reactivated using the Setup Menu.</p>



Warning lights on panel	What it means	What to do
 <p>red</p>	<p>ALTERNATOR FAILURE</p> <p>The warning light switches on when the ignition key is turned to MAR-ON, but it should switch off as soon as the engine has started (with the engine idling a brief delay before switching off is acceptable).</p>	<p>If the warning light (or symbol on the display) stays on constantly or flashing, contact an Alfa Romeo Dealership as soon as possible.</p>



WARNING

- 63) *If the  warning light does not switch on when the key is turned to MAR-ON or if it stays on when driving (together with the message on the display), there may be a fault in the restraint systems; in this case, the airbags or pretensioners may not deploy in the event of an accident or, in a lower number of cases, they could deploy erroneously. Before proceeding, contact an Alfa Romeo Dealership to have the system checked immediately.*
- 64) *Failure of the  warning light is signalled by the flashing for longer than the usual 4 seconds of the  warning light (located in the trim above the internal rear view mirror). In addition, the airbag system automatically disables the passenger side airbag. In this case, the  warning light may not indicate a fault in the restraint systems. Before proceeding, contact an Alfa Romeo Dealership to have the system checked immediately.*





Warning lights on panel	What it means	What to do
 <p data-bbox="284 250 320 269">red</p>	<p data-bbox="443 116 783 138">LOW ENGINE OIL PRESSURE</p> <p data-bbox="443 146 1149 199">When the key is turned to MAR-ON the warning light comes on, but should go out as soon as the engine is started.</p> <p data-bbox="443 204 1198 288">The warning light switches on constantly together with a message on the display (for versions/markets, where provided) when the system detects that engine oil pressure is low.</p>	 12)



IMPORTANT

12) If the  warning light switches on when driving, stop the engine immediately and contact an Alfa Romeo Dealership.

Warning lights on panel	What it means	What to do
 <p data-bbox="188 468 225 490">red</p>	<p data-bbox="344 118 1078 141">DEGRADED ENGINE OIL (for versions/markets, where provided)</p> <p data-bbox="344 148 1098 199">The warning light will turn on flashing together with a dedicated message on the display (for versions/markets where provided).</p> <p data-bbox="344 207 1038 255">Depending on the versions, the warning light flashing modes are as follows:</p> <ul data-bbox="344 263 1082 344" style="list-style-type: none"> - for 1 minute every two hours; - for 3 minute cycles with the warning light off for intervals of 5 seconds until oil is changed. <p data-bbox="344 352 1106 549">After the initial warning, each time the engine is started up, the warning light will continue to flash in the same mode, until the oil is changed. A specific message will appear on the display (for versions/markets, where provided) in addition to the warning light. If the warning light flashes, this does not mean that there is a fault, but simply informs that it is now necessary to change the oil as a result of regular use of the car. Engine oil deterioration is accelerated by:</p> <ul data-bbox="344 557 1106 725" style="list-style-type: none"> - mainly town use of the car which makes the DPF regeneration process more frequent; - use of the vehicle for short drives, in which the engine does not have time to reach its regular operating temperature; - repeated interruptions of the regeneration process, signalled by the DPF warning light switching on. 	<p data-bbox="1129 367 1374 449">Contact an Alfa Romeo Dealership as soon as possible.</p> <p data-bbox="1129 456 1214 479"> 65) 66)</p>







**WARNING**

- 65) *Deteriorated engine oil should be replaced as soon as possible after the warning light comes on, and never more than 500 km after it first switches on. Failure to observe the above indications may result in severe damage to the engine and invalidate the warranty. Remember that when this warning light comes on, it does not mean that the level of engine oil is low, so if it flashes you must not top up the engine oil.***
- 66) *If the warning light flashes with the car in motion, contact an Alfa Romeo Dealership.***

Warning lights on panel	What it means	What to do
 <p data-bbox="188 468 225 490">red</p>	<p data-bbox="344 322 810 374">ENGINE COOLANT TEMPERATURE TOO HIGH</p> <p data-bbox="344 381 855 521">When the key is turned to MAR-ON, the warning light switches on but should switch off after a few seconds. The warning light turns on when the engine is overheated. The display shows the dedicated message.</p>	<p data-bbox="888 118 1402 404"><i>When driving normally:</i> stop the car, switch off the engine and check that the water level in the reservoir is not below the MIN mark. If it is, wait for the engine to cool down, then slowly and carefully open the cap, top up with coolant and check that the level is between the MIN and MAX marks on the reservoir. Also check visually for any fluid leaks. Should the warning light turn on again at the next start-up, contact an Alfa Romeo Dealership.</p> <p data-bbox="888 412 1402 725"><i>If the car is used under demanding conditions (e.g. in high-performance driving):</i> slow down and, if the warning light stays on, stop the car. Wait for 2 or 3 minutes with the engine running and slightly accelerated to further favour the coolant circulation. Then stop the engine. Check the correct coolant level as described above. IMPORTANT Over demanding routes, it is advisable to keep the engine on and slightly accelerated for a few minutes before switching it off.</p>





Warning lights on panel	What it means	What to do
 <p data-bbox="284 338 322 360">red</p>	<p data-bbox="443 120 667 143">ALFA TCT FAILURE</p> <p data-bbox="443 150 842 172">(for versions/markets, where provided)</p> <p data-bbox="443 179 954 259">When the key is turned to MAR-ON, the warning light switches on but should switch off after a few seconds.</p> <p data-bbox="443 266 954 347">The warning light flashes (together with a message in the display and an acoustic signal) to indicate that the transmission is faulty.</p> <p data-bbox="443 353 954 463">The warning light can switch on even in case of transmission overheating, after a particularly demanding use. In this case an engine performance limitation is carried out.</p>	<p data-bbox="986 208 1471 259">Contact an Alfa Romeo Dealership as soon as possible.</p> <p data-bbox="986 266 1503 376">If it is necessary to start the engine with a transmission failure, follow the procedure described in the "Alfa TCT" paragraph, in chapter "Starting and driving".</p>
 <p data-bbox="284 663 322 685">red</p>	<p data-bbox="443 488 801 510">INCOMPLETE DOOR LOCKING</p> <p data-bbox="443 517 842 539">(for versions/markets, where provided)</p> <p data-bbox="443 546 960 656">The warning light (or symbol on the display) lights up when one or more doors or the tailgate are not closed correctly. An acoustic signal is activated with the doors open and the car moving.</p> <p data-bbox="443 663 960 743">On some versions the warning light (or symbol on the display) also lights up when the bonnet is not closed correctly.</p>	
 <p data-bbox="284 927 322 949">red</p>	<p data-bbox="443 768 737 790">SPEED LIMIT EXCEEDED</p> <p data-bbox="443 797 842 819">(for versions/markets, where provided)</p> <p data-bbox="443 826 922 907">The warning light switches on when the car exceeds the speed limit value set in the Setup Menu (e.g. 120 km/h).</p> <p data-bbox="443 913 922 994">On some versions a message is shown along with a symbol on the display, and an acoustic signal is emitted.</p>	

Warning lights on panel	What it means	What to do
 <p data-bbox="188 322 225 344">red</p>	<p data-bbox="344 117 836 140">DUAL PINION ACTIVE STEERING FAILURE (for versions/markets, where provided)</p> <p data-bbox="344 176 855 255">When the key is turned to MAR-ON, the warning light switches on but should switch off after a few seconds.</p> <p data-bbox="344 266 863 406">If the warning light (or symbol on the display) remains on, you may not have steering assistance and the effort required to operate the steering wheel could be notably increased; steering is, however, possible.</p> <p data-bbox="344 412 791 434">The display shows the dedicated message.</p>	<p data-bbox="887 154 1366 204">Contact an Alfa Romeo Dealership as soon as possible.</p> <p data-bbox="887 232 1394 400">IMPORTANT After the battery is disconnected, the steering must be initialised. The warning light switches on to indicate this. To carry out this procedure, simply turn the steering wheel all the way from one end to the other or drive in a straight line for about 100 metres.</p>

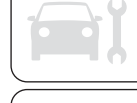
Warning lights on panel	What it means	What to do
 <p data-bbox="172 787 236 809">amber</p>	<p data-bbox="344 561 807 611">ALFA ROMEO CODE SYSTEM FAILURE/ ALARM FAILURE (for versions/markets, where provided)</p> <p data-bbox="344 647 842 787">The warning light (or symbol on the display) will come on (on some versions, with a message on the display) to indicate an Alfa Romeo CODE system or alarm failure (for versions/markets, where provided).</p> <p data-bbox="344 815 539 837">Break-in attempt</p> <p data-bbox="344 843 863 921">If this warning light flashes or, on some versions, if the symbol appears in the display (together with a message) this indicates a break-in attempt.</p>	<p data-bbox="887 647 1366 697">Contact an Alfa Romeo Dealership as soon as possible.</p> <p data-bbox="887 843 1366 893">Contact an Alfa Romeo Dealership as soon as possible.</p>



Warning lights on panel	What it means	What to do
 amber	<p>FUEL RESERVE/LIMITED RANGE</p> <p>The warning light turns on when about 8 - 10 litres of fuel are left in the tank.</p> <p>When the remaining range is lower than approx. 50 km (or equivalent value in miles), on some versions the display will show a warning message.</p>	 67)





WARNING

67) If the warning light flashes with the car in motion, contact an Alfa Romeo Dealership.







Warning lights on panel	What it means	What to do
 <p data-bbox="169 493 240 512">amber</p>	<p>GENERAL FAILURE (for versions/markets, where provided) The warning light switches on in the circumstances indicated below.</p>	<p>In these cases contact an Alfa Romeo Dealership to have the fault fixed as soon as possible.</p>
	<p>Fuel cut-off The warning light switches on when the fuel cut-off system intervenes. The display shows the dedicated message.</p>	
	<p>Start&Stop system failure (for versions/markets, where provided) The warning light comes on when a fault is detected in the Start&Stop system.</p>	
	<p>Rain sensor failure (for versions/markets, where provided) The warning light switches on when a rain sensor fault is detected.</p>	
	<p>Parking sensor failure (for versions/markets, where provided) See the following description for "Parking sensor failure".</p>	





Warning lights on panel	What it means	What to do
 <p>amber</p>	<p>GENERAL FAILURE (for versions/markets, where provided) The warning light switches on in the circumstances indicated below.</p>	<p>In these cases contact an Alfa Romeo Dealership to have the fault fixed as soon as possible.</p>
	<p>Dusk sensor failure (for versions/markets, where provided) This warning light comes on when a dusk sensor fault is detected.</p>	
	<p>Engine oil pressure sensor failure The warning light comes on when the engine oil pressure sensor is faulty. The display shows the dedicated message.</p>	
	<p>AFS adaptive lights failure (for versions/markets, where provided) The warning light switches on when a fault is detected with the AFS adaptive lights (see the "AFS adaptive lights" paragraph in the "Knowing your vehicle" section). The display shows the dedicated message.</p>	
	<p>Anti-pinch system failure The warning light comes on when a fault is detected in the electric window anti-pinch system. The display shows the dedicated message.</p>	



Warning lights on panel	What it means	What to do
 <p>amber</p>	<p>Exterior lights failure</p> <p>The warning light switches on when a fault is detected on one of the following lights:</p> <ul style="list-style-type: none"> <input type="checkbox"/> daytime running lights (DRL) <input type="checkbox"/> side lights <input type="checkbox"/> direction indicators <input type="checkbox"/> rear fog lights <input type="checkbox"/> number plate lights <p>The fault relating to these lights may be caused by: one or more blown fuses, one or more blown bulbs or a broken electrical connection.</p>	<p>Check, and if necessary replace the fuses involved, in accordance with the "Fuse replacement" paragraph, in chapter "In an emergency". If this does not resolve the fault, check, and if necessary replace, the bulbs involved, in accordance with the "External bulb replacement" paragraph, in chapter "In an emergency".</p> <p>Should this operation also fail to resolve the fault, contact an Alfa Romeo Dealership, for a comprehensive check of the electrical system.</p>
 <p>amber</p>	<p>REAR FOG LIGHTS</p> <p>This warning light comes on when the rear fog lights are switched on.</p>	



Warning lights on panel	What it means	What to do
 <p>amber</p>	<p>ABS FAILURE</p> <p>When the key is turned to MAR-ON, the warning light switches on but should switch off after a few seconds.</p> <p>The warning light (or symbol on the display) switches on when the system is inefficient. In this case the braking system will work as normal, but without the extra performance offered by the ABS.</p> <p>The display shows the dedicated message.</p>	<p>Drive carefully and contact an Alfa Romeo Dealership as soon as possible.</p>
 <p>amber</p>	<p>BRAKE PAD WEAR</p> <p>(for versions/markets, where provided)</p> <p>The warning light (or symbol on the display) switches on when the front and rear brake pads are worn.</p> <p>The display shows the dedicated message.</p>	<p>Have them replaced as soon as possible.</p>
 <p>amber</p>	<p>PASSENGER SIDE AIRBAG DEACTIVATED</p> <p>The warning light (located in the trim above the internal rear view mirror) switches on deactivating the front passenger side airbag.</p> <p>With front passenger airbag on, when the ignition key is turned to MAR-ON, the warning light switches on constantly for several seconds and then it should switch off.</p> <p>If the  warning light flashes, this indicates a fault in the  warning light.</p>	<p> 68)</p>

Warning lights on panel	What it means	What to do
 <p data-bbox="167 509 239 532">amber</p>	<p data-bbox="343 117 774 140">INJECTION/EObd SYSTEM FAILURE</p> <p data-bbox="343 145 938 319">In normal conditions, when the ignition key is turned on MAR-ON the warning light switches on, but it should switch off as soon as the engine is started. The operation of  warning light may be checked by the traffic police using specific devices. Comply with the laws and regulations of the country where you are driving.</p> <hr/> <p data-bbox="343 336 938 593">If the warning light remains on or switches on whilst driving, it means that the injection system is not working properly. The warning light on constantly signals a malfunction in the supply/ignition system which could cause high exhaust emissions, a possible loss of performance, poor driveability and high consumption. On some versions, the display shows the dedicated message. The warning light goes out after the fault disappears: the indication is stored in the system.</p>	<p data-bbox="962 201 1021 229"> 13)</p> <p data-bbox="962 352 1401 582">Under these conditions, you may continue travelling at a moderate speed without demanding excessive effort from the engine. Prolonged use of the car with the warning light on constantly may cause damage. Contact an Alfa Romeo Dealership as soon as possible.</p>
	<p data-bbox="343 677 566 700">Petrol engines only</p> <p data-bbox="343 705 938 756">If the warning light flashes, it means that the catalytic converter may be damaged.</p>	<p data-bbox="962 616 1401 817">In this case, release the accelerator pedal to lower the speed of the engine until the warning light stops flashing. Continue the journey at moderate speed, trying to avoid driving conditions that may cause further flashing and contact an Alfa Romeo Dealership as soon as possible.</p>



Warning lights on panel	What it means	What to do
 <p>amber</p>	<p>GLOW PLUG HEATING/GLOW PLUG HEATING FAILURE (diesel versions) This warning light switches on when the key is turned to MAR-ON. It will switch off as soon as the heater plugs have reached a preset temperature. The engine can be started as soon as the warning light switches off. IMPORTANT In mild or high temperature conditions, the warning light comes on for a very short time only.</p> <hr/> <p>Glow plug preheating failure The warning light will flash (a message will appear on the display, on some versions) to indicate a fault in the glow plugs preheating system.</p>	<p>Contact an Alfa Romeo Dealership as soon as possible.</p>
 <p>amber</p>	<p>WATER IN DIESEL FILTER (diesel versions) The warning light remains on constantly when driving (together with a message in the display), to indicate the presence of water in the diesel filter.</p>	



WARNING

68) Failure of the  warning light is indicated by the  warning light switching on. In addition, the airbag system automatically disables the passenger side airbag. Before proceeding, contact an Alfa Romeo Dealership to have the system checked immediately.



IMPORTANT



13) If, turning the ignition key to MAR-ON, the  warning light does not turn on or if it turns on steadily or flashing when travelling (on certain versions together with the message on the display), contact an Alfa Romeo Dealership as soon as possible.



IMPORTANT

14) The presence of water in the fuel supply system circuit may cause severe damage to the injection system and irregular engine operation. If the  warning light comes on in the instrument panel (together with a message in the display) contact an Alfa Romeo Dealership as soon as possible to bleed the system. If the above indications come on immediately after refuelling, water has probably been poured into the tank: turn the engine off immediately and contact an Alfa Romeo Dealership.



Warning lights on panel	What it means	What to do
 <p data-bbox="268 481 335 504">amber</p>	<p data-bbox="443 117 960 173">DPF CLEANING (particulate trap) in progress (diesel versions with DPF only)</p> <p data-bbox="443 173 960 347">When the key is turned to MAR-ON, the warning light switches on but it should switch off after a few seconds. The warning light switches on constantly to indicate that the DPF system needs to eliminate the trapped pollutants (particulate) through the regeneration process.</p> <p data-bbox="443 347 960 492">The warning light does not come on during every DPF regeneration, but only when driving conditions require that the driver is notified. To turn off the warning light, keep the car in motion until the regeneration process is over.</p> <p data-bbox="443 492 960 610">On average, the process lasts 15 minutes. Optimal conditions for completing the process are achieved by travelling at 60 km/h with engine speed above 2000 rpm.</p> <p data-bbox="443 610 960 756">When this warning light switches on, it does not indicate a car failure and thus it should not be taken to a workshop. On some versions, together with the warning light switching on, the display shows a dedicated message.</p>	 69)





WARNING

69) Always drive at a speed appropriate to the traffic conditions, the weather and traffic regulations. The engine can be stopped even if the DPF warning light is on: however, repeated interruptions of the regeneration process could cause premature deterioration of the engine oil. For this reason, always wait until the warning light switches off before stopping the engine as described above. It is not advisable to complete DPF regeneration with the car stationary.



Warning lights on panel	What it means	What to do
 <p data-bbox="169 437 240 456">amber</p>	<p data-bbox="344 180 528 202">iTPMS SYSTEM</p> <p data-bbox="344 210 855 292">When the key is turned to MAR-ON, the warning light switches on but should switch off after a few seconds.</p> <hr/> <p data-bbox="344 372 863 395">iTPMS failure/iTPMS temporarily deactivated</p> <p data-bbox="344 403 874 540">The warning light flashes for about 75 seconds and then stays on constantly (together with a message on the display) (see "Operating conditions" paragraph) to indicate that the system is temporarily deactivated or faulty.</p> <p data-bbox="344 548 866 658">The system goes back to normal operation when the operating conditions allow it. If this is not the case, carry out the Reset procedure after restoring the normal operating conditions.</p>	<p data-bbox="903 120 1406 350">IMPORTANT Do not continue driving with one or more flat tyres as handling may be compromised. Stop the car, avoiding sharp braking and steering. Repair immediately using the dedicated kit (see the "Replacing a wheel" paragraph in the "In an emergency" section) and contact an Alfa Romeo Dealership as soon as possible.</p> <hr/> <p data-bbox="903 490 1382 540">If the malfunction warning persists, contact an Alfa Romeo Dealership as soon as possible.</p>



















Warning lights on panel	What it means	What to do
 <p data-bbox="268 351 338 374">amber</p>	<p data-bbox="443 118 651 141">Low tyre pressure</p> <p data-bbox="443 150 959 286">The warning light switches on constantly to indicate that the tyre pressure is lower than the recommended value, in order to guarantee long tyre life and low fuel consumption, or to indicate a slow loss of pressure.</p> <p data-bbox="443 295 959 432">In this way the iTPMS warns the driver that one or more tyres may be flat and liable to puncture. In this case it is advisable to restore the correct pressure value (see the "Wheels" paragraph in the "Technical specifications" section).</p> <p data-bbox="443 441 943 488">Once the normal operating conditions of the car are restored, carry out the Reset procedure.</p>	<p data-bbox="1000 163 1501 331">In any situation in which the message on the display is "See manual", it is ESSENTIAL to refer to the contents of the "Wheels" paragraph in the "Technical specifications" section, strictly complying with the indications that you find there.</p> <p data-bbox="1000 340 1501 452">IMPORTANT Do not continue driving with one or more flat tyres as handling may be compromised. Stop the car, avoiding sharp braking and steering.</p>

Warning lights on panel	What it means	What to do
 <p data-bbox="169 367 240 389">amber</p>	<p data-bbox="344 118 831 169">ELECTRONIC STABILITY CONTROL (ESC) SYSTEM</p> <p data-bbox="344 176 839 258">When the ignition key is turned to MAR-ON, the warning light switches on, but should switch off as soon as the engine is started.</p> <p data-bbox="344 266 839 348">Intervention by the system is indicated by the flashing of the warning light: it indicates that the car is in critical stability and grip conditions.</p> <p data-bbox="344 356 839 460">If the warning light (or symbol on the display) does not switch off, or if it stays on with the engine running, this means that an ESC system fault is present.</p> <p data-bbox="344 468 772 518">On some versions, the display shows the dedicated message.</p>	<p data-bbox="887 277 1369 359">Contact an Alfa Romeo Dealership as soon as possible to have the problem diagnosed and resolved.</p>







Warning lights on panel	What it means	What to do
 <p data-bbox="268 434 336 453">amber</p>	<p data-bbox="443 117 927 169">ELECTRONIC STABILITY CONTROL (ESC) SYSTEM</p> <p data-bbox="443 176 663 199">ASR system failure</p> <p data-bbox="443 207 938 288">When the ignition key is turned to MAR-ON, the warning light switches on, but should switch off as soon as the engine is started.</p> <p data-bbox="443 296 962 348">The warning light will flash while driving to indicate that the ASR system is intervening.</p> <p data-bbox="443 356 938 463">If the warning light (or symbol on the display) does not switch off, or if it stays on with the engine running, this means that an ASR system malfunction has been detected.</p> <p data-bbox="443 471 871 523">On some versions, the display shows the dedicated message.</p> <hr/> <p data-bbox="443 543 732 565">Hill Holder system failure</p> <p data-bbox="443 573 938 655">The warning light switches on together with the  symbol and corresponding message on the display to indicate Hill Holder system failure.</p>	<p data-bbox="986 296 1505 348">In this case, contact an Alfa Romeo Dealership as soon as possible.</p> <hr/> <p data-bbox="986 573 1505 624">In this case, contact an Alfa Romeo Dealership as soon as possible.</p>



Warning lights on panel	What it means	What to do
 <p data-bbox="167 308 239 330">green</p>	<p data-bbox="343 117 821 173">CRUISE CONTROL (for versions/markets, where provided)</p> <p data-bbox="343 179 861 403">This warning light switches on when the ignition key is turned to MAR-ON, but it should switch off after a few seconds, if the Cruise Control is deactivated. The warning light switches on when the Cruise Control ring nut is turned to the ON position (see the "Cruise Control" paragraph in the "Knowing your vehicle" section). The display shows the dedicated message.</p>	  
 <p data-bbox="167 599 239 621">green</p>	<p data-bbox="343 425 502 448">SIDE LIGHTS</p> <p data-bbox="343 453 805 509">The warning light switches on when the side lights are activated.</p>	
 <p data-bbox="167 599 239 621">green</p>	<p data-bbox="343 532 582 554">FOLLOW ME HOME</p> <p data-bbox="343 560 861 672">The warning light switches on (together with a message shown on the display) when this device is in use (see the "Exterior lights" paragraph in the "Knowing your vehicle" section).</p>	
 <p data-bbox="167 812 239 834">green</p>	<p data-bbox="343 722 678 744">DIPPED BEAM HEADLIGHTS</p> <p data-bbox="343 750 837 806">The warning light switches on when the dipped beam headlights are turned on.</p>	
 <p data-bbox="167 974 239 996">green</p>	<p data-bbox="343 879 502 901">FOG LIGHTS</p> <p data-bbox="343 907 837 963">The warning light comes on when the fog lights are turned on.</p>	  





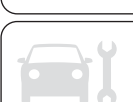

Warning lights on panel	What it means	What to do
 <p data-bbox="274 232 331 255">green</p>	<p data-bbox="443 116 861 138">LEFT-HAND DIRECTION INDICATOR</p> <p data-bbox="443 147 951 259">The warning light switches on when the direction indicator control lever is moved downwards or, together with the right direction indicator, when the hazard warning light button is pressed.</p>	
 <p data-bbox="274 394 331 416">green</p>	<p data-bbox="443 277 877 300">RIGHT-HAND DIRECTION INDICATOR</p> <p data-bbox="443 309 954 421">The warning light turns on when the direction indicator control lever is moved upwards or, together with the left direction indicator, when the hazard warning light button is pressed.</p>	
Warning lights on panel	What it means	What to do
 <p data-bbox="274 663 331 685">blue</p>	<p data-bbox="443 573 750 595">MAIN BEAM HEADLIGHTS</p> <p data-bbox="443 604 909 658">The warning light switches on when the main beam headlights are turned on.</p>	

SYMBOLS AND MESSAGES ON THE DISPLAY

Symbol on the display	What it means	What to do
	<p>FUEL CUT-OFF SYSTEM</p> <p>On some versions the display will show a message + symbol if the fuel cut-off intervenes.</p>	For the procedure to restore the fuel cut-off system see the "Controls" paragraph in the "Knowing your vehicle" section. If it is still not possible to restore the fuel supply, contact an Alfa Romeo Dealership.
	<p>POSSIBLE ICE ON ROAD</p> <p>On versions equipped with reconfigurable multifunction display, a message and a symbol will appear on the display when the outside temperature falls to or below 3°C.</p> <p>On versions with "Multifunction display" only the dedicated message is shown.</p> <p>IMPORTANT In the event of outside temperature sensor failure, the digits that indicate the value are replaced by dashes.</p>	
	<p>BRAKE LIGHT FAILURE</p> <p>On some versions the display will show a message + symbol if there is a fault in the brake lights.</p>	The fault may be caused by a blown bulb, a blown protection fuse or an interruption of the electrical connection.
	<p>DUSK SENSOR FAILURE</p> <p>(for versions/markets, where provided)</p> <p>On some versions the display will show a message + symbol if there is a fault in the dusk sensor.</p>	Go to an Alfa Romeo Dealership to have the fault fixed as soon as possible.



Symbol on the display	What it means	What to do
	<p>RAIN SENSOR FAILURE (for versions/markets, where provided) On some versions the display will show a message + symbol if there is a fault in the rain sensor.</p>	Go to an Alfa Romeo Dealership to have the fault fixed as soon as possible.
	<p>PARKING SENSOR FAILURE (for versions/markets, where provided) On some versions the display will show a message + symbol if there is a fault in the parking sensors.</p>	Go to an Alfa Romeo Dealership to have the fault fixed as soon as possible.

Symbol on the display	What it means	What to do
	<p>START&STOP SYSTEM ACTIVATION/ DEACTIVATION (for versions/markets, where provided)</p> <p>Start&Stop system activation A message will appear on the display when the Start&Stop system is activated. In this case the LED located on the  button is off (see the “Start&Stop” paragraph in this chapter).</p> <p>Start&Stop system deactivation <i>Versions with multifunction display:</i> a message is displayed when the Start&Stop system is deactivated. <i>Versions with reconfigurable multifunction display:</i> the  symbol + message appear on the display when the Start&Stop system is deactivated. The LED on the  button is on when the system is deactivated.</p> <hr/> <p>START&STOP FAILURE If the Start&Stop system is faulty the  (versions with multifunction display) or  (versions with reconfigurable multifunction display) symbol flashes on the display. For versions/markets, where provided, a warning message is also displayed.</p>	<p>In these cases contact an Alfa Romeo Dealership to have the fault fixed as soon as possible.</p>



Symbol on the display	What it means	What to do
	<p>DISPLAY OF SELECTED DRIVING MODE (“Alfa DNA” system)</p> <p>On versions equipped with a "Reconfigurable multifunction display", a message and the symbol associated with the selected driving mode "DYNAMIC", "NATURAL" or "ALL WEATHER" are shown. A warning message is shown on the display if one of these driving modes is not available.</p> <p>On versions equipped with "Multifunction display", a letter ("d" or "a") associated with the selected driving mode is shown together with a dedicated message.</p>	

SAFETY

The chapter that you are about to read is very important: it describes the safety systems with which the car is equipped and provides instructions on how to use them correctly.

SEAT BELTS	128
SBR SYSTEM (SEAT BELT REMINDER)	129
PRETENSIONERS.....	131
CARRYING CHILDREN SAFELY	133
FITTING “UNIVERSAL” CHILD SEAT (WITH SEAT BELTS).....	134
PREPARATION FOR “ISOFIX” CHILD SEAT	137
FRONT AIRBAGS.....	140
SIDE AIRBAGS (SIDE BAGS - WINDOW BAGS).....	144



SEAT BELTS

USING THE SEAT BELTS

The belt should be worn keeping the torso straight and rested against the backrest.

To fasten the seat belts, hold the tongue A fig. 106 and insert it into the buckle B, until it clicks into place.

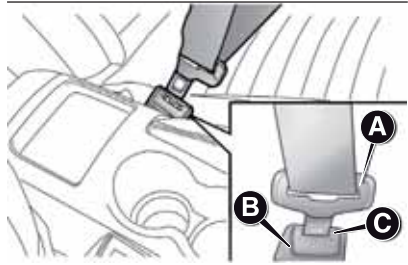

106

A0K0659

On removal of the belt, if it jams, let it rewind for a short stretch, then pull it out again without jerking.

To unfasten the seat belts, press button C and guide the seat belt with your hand while it is rewinding, to prevent it from twisting. ⚠ 70) 71) 72)

The retractor may lock when the car is parked on a steep slope: this is perfectly normal. Furthermore, the retractor mechanism locks the belt if it is pulled sharply or in the event of sudden braking, collisions or high-speed bends.

The rear seat is fitted with inertia seat belts with three anchor points and a retractor.

Wear the rear seat belts as illustrated in fig. 107.

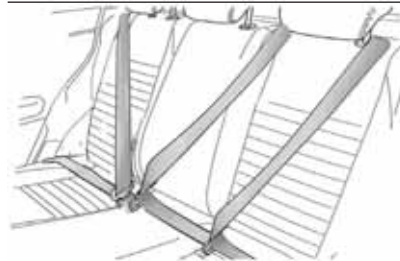

107

A0K0161

IMPORTANT The backrest is correctly secured when the red band B fig. 108 on backrest folding handle A disappears. This red band indicates that the backrest is not secured.

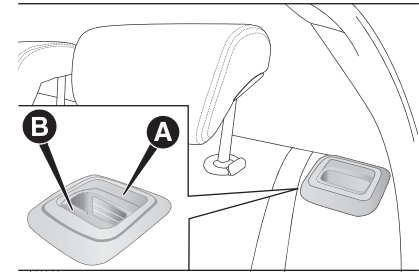

108

A0K0628

IMPORTANT When putting the rear seats back to their normal position, make sure the seat belts are positioned so they are ready to use.



WARNING

70) Never press button C fig. 106 while travelling.

71) Remember that, in the event of an accident, the rear seat passengers not wearing seat belts are exposed to a very serious risk and also represent a serious danger for the front seat occupants.

72) Make sure that the backrest is correctly secured on both sides ("red bands" B fig. 108 not visible) to prevent it from moving forward in the event of sharp braking, causing injuries to occupants.

SBR SYSTEM (Seat Belt Reminder)

This system comprises an acoustic warning which, in conjunction with the  warning lights flashing on the instrument panel, advises the front seat passengers if their seat belt has not been fastened.

On some versions there is also a panel (provided as an alternative to the warning light on the instrument panel) located above the interior rear view mirror, which warns the front and back seat passengers through acoustic and visual signals if their seat belts have not been fastened.

Contact an Alfa Romeo Dealership to deactivate this acoustic warning permanently.

The acoustic warning can be reactivated at any time through the Setup Menu (see "Menu options" paragraph in the "Knowing the instrument panel" chapter).

The warning lights may be red or green and operate as follows:

- 1 = front left seat (driver status for left-hand drive versions);
- 2 = rear left seat (passenger);
- 3 = rear centre seat (passenger);

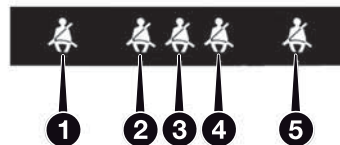
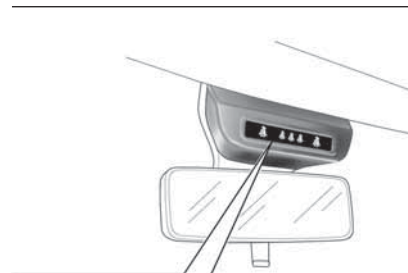

109

A0K0075

- 4 = rear right seat (passenger);
- 5 = front right seat (passenger status for left-hand drive versions).



FRONT SEATS (warning light no. 1 = driver and no. 5 = passenger)*Driver*

If the driver is the only occupant and their seat belt is not fastened, when 20 km/h is exceeded or when travelling at a speed between 10 and 20 km/h for longer than 5 seconds, an acoustic signal cycle will be started for the front seats (continuous acoustic signal for 6 seconds followed by a 90 second beep). The warning light will flash.

The warning lights will stay on constantly at the end of the cycle until the engine is stopped. The acoustic signal will be interrupted immediately when the driver's seat belt is fastened and the warning light will turn green.

The reminder cycle (acoustic and visual) will be repeated as described above and the red warning light will flash if the seat belt is unfastened again while travelling.

Passenger

A similar situation applies to the front passenger, with the difference that the warning light turns green and the indication is also interrupted when the passenger leaves the car.

If both front seat belts are unfastened a few seconds apart while the car is travelling, the acoustic signal will refer to the most recent event and the two warning lights will proceed with the visual indication independently.

REAR SEATS (warning light no. 2, no. 3 and no. 4)

For the rear seats, the reminder cycle is only activated when any seat belt is unfastened (flashing red).

In this condition, the warning light for the seat belt which has been unfastened will flash (red) for approximately 30 seconds. An acoustic signal is also emitted.

The visual indication (flashing red) will start and stop independently for each warning light if several seat belts are unfastened. The warning light will become green when the relevant seat belt is fastened again.

The rear seat warning lights will switch off, regardless of the state of the belt (red or green) approximately 30 seconds after the last signal.

IMPORTANT

The warning lights are all off if all seat belts (front and rear) are already fastened when the ignition key is turned to MAR.

All warning lights switch on when at least one belt changes from fastened to unfastened or vice versa.

PRETENSIONERS

The car is equipped with front seat belt pretensioners, which draw back the seat belts by several centimetres in the event of a violent frontal impact. This guarantees the perfect adherence of the seat belts to the occupants' bodies before the restraining action begins.

It is evident that the pretensioners have been activated when the belt withdraws towards the reel.

The car is also equipped with a second pretensioner (in the kick plate area). Its activation is signalled by the shortening of the metal cable.

A slight discharge of smoke may be produced during the activation of the pretensioner. This is not harmful and does not indicate the start of a fire.

IMPORTANT To obtain the highest degree of protection from the action of the pretensioner, wear the seat belt tight to the chest and pelvis.

The pretensioner does not require any maintenance or lubrication: any changes to its original conditions will invalidate its efficiency. If, due to unusual natural events (floods, sea storms, etc.), the device has been affected by water and/or mud, contact an Alfa Romeo Dealership to have it replaced.

LOAD LIMITERS

To increase protection, the front seat belt reels contain a load limiter which controls the force acting on the chest and shoulders during the belt restraining action in the event of a head-on collision.

! 73)

! 15)

GENERAL INSTRUCTIONS FOR USING THE SEAT BELTS

Respect and ensure that all the other occupants of the car respect the local laws in force regarding the use of seat belts. Always fasten the seat belts before starting off.

! 74) 75) 76)

Seat belts must also be worn by pregnant women: the risk of injury in the event of an accident is reduced for them and the unborn child if they are wearing a seat belt.

Pregnant women must position the lower part of the belt very low down so that it passes over the pelvis and under the abdomen fig. 110.

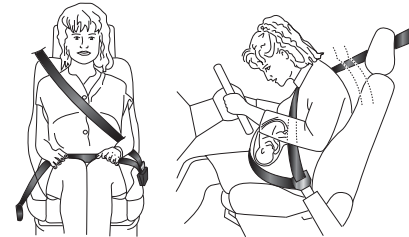

110

A0K0250

The belt must not be twisted. The upper part must pass over the shoulder and cross the chest diagonally. The lower part must adhere to the pelvis fig. 111, not to the abdomen of the occupant. Never use devices (clips, clamps, etc.) to hold the seat belt away from your body.

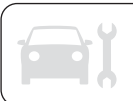



111

A0K0012

Each seat belt must be used by only one person. Never travel with a child sitting on a passenger's lap and a single belt to protect them both fig. 112. In general, do not place any objects between the person and belt.



112

A0K0013

SEAT BELT MAINTENANCE

- Always use the seat belt well stretched and never twisted; make sure that it is free to run without obstructions;
- replace the belt after an accident of a certain severity even if it does not appear to be damaged. Always replace the belt if the pretensioners were deployed;
- hand wash the seat belts with water and neutral soap, rinse and leave to dry in the shade. Never use strong detergents, bleach, paints or any other substance which could damage the belt fibres;
- prevent the retractors from getting wet: their correct operation is only guaranteed if water does not get inside;
- replace the seat belt when there is wear or cuts.



WARNING

73) The pretensioner may be used only once. After its activation, contact an Alfa Romeo Dealership to have it replaced.

74) Removing or otherwise tampering with pretensioner and seat belt components is strictly prohibited. Any operations on these components must be performed by qualified and authorised technicians. Always contact an Alfa Romeo Dealership.

75) For maximum protection, keep the backrest upright, lean back into it and make sure the seat belt fits closely across your chest and pelvis. Always fasten the seat belts for both the front and rear seats! Travelling without wearing seat belts will increase the risk of serious injury and even death in the event of an accident.

76) If the belt has been subjected to heavy strain, for example after an accident, it must be changed completely together with the anchors, anchor fastening screws and the pretensioner. Even if the belt has no visible defects, it could have lost its resilience.



IMPORTANT

15) Operations which lead to impacts, vibrations or localized heating (over 100°C for a maximum of six hours) in the area around the pretensioner may damage or deploy it. Contact an Alfa Romeo Dealership should intervention be necessary on these components.

CARRYING CHILDREN SAFELY

For optimal protection in the event of an impact, all occupants must be seated and wearing adequate restraint systems, including newborn and other children!

This prescription is compulsory in all EC countries according to EC Directive 2003/20/EC.

Compared with an adult, a child's head is larger and heavier in proportion to his/her body and the child's muscular and bone structures are not fully developed. Therefore, correct restraint systems other than adult seat belts are necessary to reduce as much as possible the risk of injuries in case of accident, braking or sudden manoeuvre.

Children must be seated safely and comfortably. As far as the characteristics of the child restraint systems used allow, you are advised to keep children in rear facing restraint systems for as long as possible (at least until 3–4 years old), since this is the most protected position in the event of an impact.  77) 78)

The choice of the most suitable child restraint device depends on the weight of the child; there are various types of child restraint systems and you are advised always to choose the one that is most suitable for the child.

When over 1.50 m in height, from the point of view of restraint systems, children are considered as adults and wear seat belts normally.

In Europe the characteristics of children restraint systems are ruled by the regulation ECE-R44, dividing them into five weight groups:

Group	Weight groups
Group 0	up to 10 kg
Group 0+	up to 13 kg
Group 1	9-18 kg
Group 2	15-25 kg
Group 3	22-36 kg



All restraint devices must bear the type-approval data along with the control mark on a label firmly secured to the child seat which must never be removed.

Lineaccessori Alfa Romeo includes child restraint systems for each weight group. These devices are recommended having been specifically tested for Alfa Romeo cars.



WARNING

77) SEVERE DANGER. *When an active passenger airbag is fitted, DO NOT install rear facing child restraint systems on the front seat. Deployment of the airbag in an accident could cause fatal injuries to the baby regardless of the severity of the impact. It is advisable to always carry children in a child restraint system on the rear seat, which is the most protected position in the event of a collision.*

78) On the sun visor there is a label with suitable symbols remembering that it is compulsory to deactivate the airbag if a rear facing child restraint system is fitted. Always comply with the instructions on the passenger's side sun visor (see the "Front airbag" paragraph).

FITTING "UNIVERSAL" CHILD SEAT (with seat belts)

GROUP 0 and 0+



Infants up to 13 kg must be carried with a child seat facing backwards of a type as shown in fig. 113 which, supporting the head, does not induce stress on the neck in the event of sudden decelerations.

The child seat is secured by the car seat belts, as shown in fig. 113 and it must restrain the child in turn with its own belts.

0-13 kg



113

A0K0014

GROUP 1

! 79) 80)

Children of weight from 9 to 18 kg may be carried in child seats facing forwards fig. 114.

9-18 kg



114

A0K0129

GROUP 2

! 80)

Children from 15 to 25 kg may use the car seat belts directly fig. 115.

15-25 kg



115

A0K0016

In this case, the child restraint system is used to position the child correctly with respect to the seat belts so that the diagonal belt section crosses the child's chest and not the neck, and the lower part is snug on the pelvis not the abdomen.

GROUP 3

! 80)

For children between 22 kg and 36 kg, there are dedicated restraint systems that allow the seat belt to be worn correctly.

fig. 116 shows an example of correct child seat positioning on the rear seat.

22-36 kg



116

A0K0017

Children over 1.50 m in height can wear seat belts like adults.



WARNING

79) Child restraint systems with Isofix attachments are available, which allow them to be secured to the seat safely without using the car seat belts. See paragraph "Isofix child restraint system setup" for the fitting instructions.

80) The figure is indicative for fitting purposes only. Fit the child restraint system according to the instructions, which must be included.



SUITABILITY OF PASSENGER SEATS FOR UNIVERSAL CHILD SEAT USE

According to the European Directive 2000/3/EC the suitability of each passenger seat position for the fixing of universal child seats is shown in the following table:

Group	Weight groups	Front passenger's seat	Rear (side and central) seats
Group 0, 0+	up to 13 kg	U (*)	U
Group 1	9-18 kg	U (*)	U
Group 2	15-25 kg	U (*)	U
Group 3	22-36 kg	U (*)	U

U (*)With height-adjustable seat, move the backrest to a vertical position.

U= Suitable for child restraint systems in the "Universal" category, according to European Standard EEC-R44 for the specified "Groups".

PREPARATION FOR “ISOFIX” CHILD SEAT

The car is equipped with ISOFIX anchorages, a new standard which makes fitting a child seat quick, simple and safe.

Isofix systems can be fitted alongside conventional child seats on different seats in the same car.

fig. 117 Shows an example of a Universal Isofix child restraint system for weight group 1.  81)

The other weight groups are covered by specific Isofix child seats, which can be used only if specifically tested for this car (see list of cars provided with the child seat).

IMPORTANT The central rear seat is not approved for any type of Isofix child seat.

INSTALLING A UNIVERSAL ISOFIX CHILD SEAT

Proceed as follows:

- attach the child restraint system to the special lower metal rings B fig. 118, located inside the rear seat backrest (to access the rings lift hinge A);

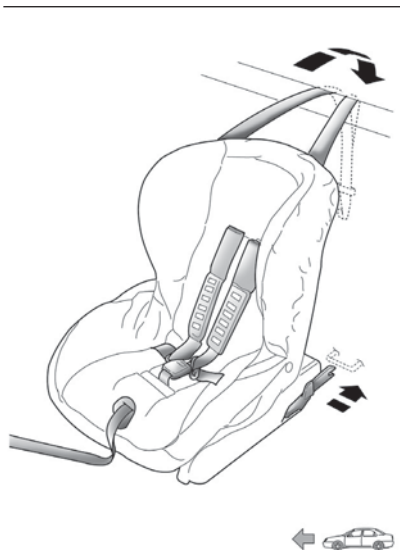

117

A0K0018

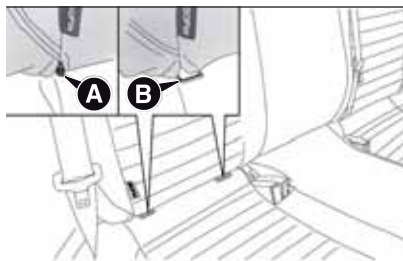

118

A0K0510

- secure the upper belt (available together with the child restraint system) to the special attachments C fig. 119 located in the rear part of the backrest.

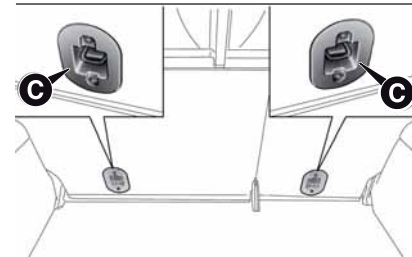

119

A0K0511

It is possible to have a mixed assembly of traditional child restraint system and Universal Isofix ones. Remember that when using a Universal Isofix child restraint system, you can only use type-approved child restraint systems with the marking ECE R44 (R44/03 or superior) “Universal Isofix”.

The Universal Isofix “Duo Plus” child seat and the special “G 0/1 S” seat are available from Lineaccessori Alfa Romeo.

For any further installation/usage details, refer to the “Instruction Manual” provided with the child restraint system.

 82) 83) 84)



SUITABILITY OF PASSENGER SEATS FOR ISOFIX CHILD SEAT USE

The table below shows the various installation possibilities for Isofix child seats on seats fitted with Isofix attachments in accordance with European standard ECE 16.

Weight group	Child restraint system position	Isofix size class	Rear side seats
Group 0 up to 10 kg	Facing backwards	E	IL (*)
	Facing backwards	E	IL (*)
Group 0+ up to 13 kg	Facing backwards	D	IL (*)
	Facing backwards	C	IL (*)
	Facing backwards	D	IL (*)
Group 1 from 9 up to 18 kg	Facing backwards	C	IL (*)
	Forward facing	B	IUF
	Forward facing	BI	IUF
	Forward facing	A	IUF

IL suitable for ISOFIX child restraint systems of the categories for "specific vehicles", "restricted" or "semiuniversal"

(*) the Isofix child seat can be installed by adjusting the front seat

IUF: suitable for Isofix child seats to be positioned in forward facing position, universal class (fitted with third upper mounting), type-approved for the relevant weight group.

Main recommendations to carry children safely

- ❑ Install the child restraint systems on the rear seat, which is the most protected position in the event of an accident.
- ❑ Keep children in rear facing child restraint systems for as long as possible, until 2 years old.
- ❑ Should a rear facing child restraint system be installed on the rear seats, it is advisable to position it as far forward as the position of the front seat allows.
- ❑ If the front passenger airbag is deactivated always check the permanent switching on of the  warning light in the trim above the internal rearview mirror to make sure that it has actually been deactivated.
- ❑ Carefully follow the instructions supplied with the child restraint system itself. Keep the instructions in the car along with the other documents and this handbook. Do not use second-hand child restraint systems without instructions.
- ❑ Only one child is to be strapped into each restraint system; never carry two children simultaneously.

- ❑ Always check that the seat belts do not interfere with the child's throat.
- ❑ Always check that the seat belt is well fastened by pulling on it.
- ❑ While travelling, do not let the child sit incorrectly or unfasten the belts.
- ❑ Never allow a child to put the belt's diagonal section under an arm or behind their back.
- ❑ Never carry children on your lap, even newborns. No-one can restrain a child in the event of an accident.
- ❑ In the event of an accident, replace the child restraint system with a new one.



WARNING

81) The figure is indicative for fitting purposes only. Fit the child restraint system according to the instructions, which must be included.

82) If a Universal Isofix child restraint system is not fixed to all three anchorages, it will not be able to protect the child correctly. In a crash, the child could be seriously or fatally injured.

83) Fit the child restraint system only when the car is stationary. The child restraint system is correctly secured to the brackets when you hear the click. Follow the instructions for assembly, disassembly and positioning that the manufacturer must supply with the child restraint system.

84) Fit the child restraint system according to the instructions, which must be included.



FRONT AIRBAGS

“SMART BAG” SYSTEM (MULTISTAGE FRONT AIRBAGS)

The car features multistage front airbags (“Smart bag”) for driver and passenger.

The front (driver and passenger) airbags protect occupants in the event of head-on crashes of medium-high severity, by placing the a cushion between the occupant and the steering wheel or dashboard.

Therefore non-deployment in other types of impacts (side impacts, rear shunts, roll-overs, etc.) does not indicate a system malfunction.

Airbags are not a replacement of but complementary to the seat belts, which you are recommended to always wear. In the event of impact, those not wearing a seat belt are projected forwards and may come into contact with the bag which is still inflating. The protection offered by the bag is compromised in these circumstances.

 85) 86) 88)

Front airbags may not activate in the following situations:

- frontal impacts against highly deformable objects not involving the front surface of the car (e.g. wing collision against guard rail, etc.);
- jamming of the car underneath other vehicles or protective barriers (e.g. underneath a truck or a guard rail) as, in this case, the bags would offer no additional protection with respect to the seat belt and their deployment would be inappropriate. In these cases, non-deployment does not indicate a system malfunction.

FRONT DRIVER SIDE AIRBAG

This consists of an instantly inflating bag contained in a special compartment in the centre of the steering wheel fig. 120.

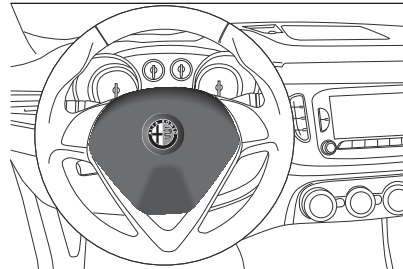

120

A0K0364

FRONT PASSENGER AIRBAG

This consists of an instantly inflating bag contained in a special recess in the dashboard fig. 121: this bag has a larger volume than that of the driver's.

 87)

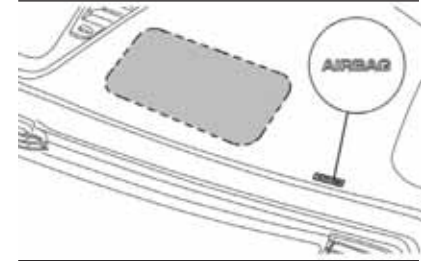

121

A0K0135

FRONT PASSENGER AIRBAG AND CHILD RESTRAINT SYSTEMS

 89)

ALWAYS comply with the instructions on the label stuck on the passenger side sun visor.

Deactivating passenger side airbags: front airbag and side bag for pelvis, chest and shoulders protection (Side bag)

If a child must be carried on the front seat in a rear facing child restraint system, deactivate the passenger side front airbag and side bag for pelvis, chest and shoulder protection (Side bag).

With airbags deactivated, a warning light  lights up on the instrument panel in the trim located above the internal rearview mirror fig. 122.

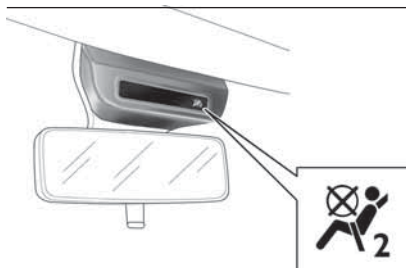

122

A0K0660



FRONT PASSENGER AIRBAG AND CHILD RESTRAINT SYSTEMS: WARNING

I	RISCHIO DI FERITE GRAVI O MORTALI. I seggiolini bambino che si montano nel verso opposto a quello di marcia non vanno installati sui sedili anteriori in presenza di air bag passeggero attivo.
GB	DEATH OR SERIOUS INJURY CAN OCCUR. NEVER use a rearward facing child restraint on a seat protected by an ACTIVE AIRBAG in front of it, DEATH or SERIOUS INJURY to the CHILD can occur
F	RISQUE DE MORT OU DE BLESSURES GRAVES. NE PAS positionner le siège pour enfant tourné vers l'arrière, en cas d'air bag passager actif.
D	Nichtbeachtung kann TOD oder SCHWERE VERLETZUNGEN zur Folge haben. Rückwärts gerichtete Kinderrückhaltesysteme (Babyschale) dürfen nicht in Verbindung mit aktiviertem Beifahrerairbag auf dem Beifahrersitz verwendet werden
NL	DIT KAN DODELIJK ZIJN OF ERNSTIGE ONGELUKKEN VEROORZAKEN. Plaats het kinderstoeeltje niet ruggelings op de voorstoel wanneer er een airbag aanwezig is.
E	PUEDE OCACIONAR MUERTE O HERIDAS GRAVES. NO ubicar el asiento para niños en sentido inverso al de marcha en el asiento delantero si hubiese airbag activo lado pasajero.
PL	MOŻE GROZIĆ ŚMIERCIA LUB CIEŻKIMI OBRAŻENIAMI. NIE WOLNO umieszczać fotelika dziecięcego tyłem do kierunku jazdy na przednim siedzeniu w przypadku zainstalowanej aktywnej poduszki powietrznej pasażera.
TR	ÖLÜM VEYA AĞIR ŞEKİLDE YARALANMAYA SEBEP OLABİLİR. Yolcu airbağı aktif halde iken çocuk koltuğunu araç gidüş yönüne ters biçimde yerleştirmeyin.
DK	FARE FOR DØDELIGE KVÆSTELSER OG LIVSTRUENDE SKADER. Placer aldrig en bagudvendt barnestol på passagerersædet, hvis passager-airbagen er indstillet til at være aktiv (on).
EST	TAGAJÄRJESKES VÕIVAD OLLA TÕSISED KEHAVIGASTUSED VÕI SURM. Turvapadja olemasolu korral ärge asetage lapse turvaistet sõidusuunaga vastassuunas.
FIN	KUOLEMANVAARA TAI VAKAVIEN VAMMOJEN UHKA. Älä aseta lasten turvaistuinta niin, että lapsi on selkää menosuuntaan, kun matkustajan airbag on käytössä.
P	RISCO DE MORTE OU FERIMENTOS GRAVES. Não posicionar o banco para crianças numa posição contrária ao sentido de marcha quando o airbag de passageiro estiver activo.
LT	GALI IŠTIKTI MIRTIS ARBA GALITE RIMTAI SUSIŽEISTI. Nedekite vaiko sėdynės atgręžtos nugarą į priekinį automobilio stiklą ten, kur yra veikiant keleivio oro pagalvė.
S	KAN VARA LIVSHOTANDE ELLER LEDA TILL ALLVARLIGA SKADOR. Placera aldrig en bakåtvänd barnstol i framsätet då passagerarsidans krockkudde är aktiv.
H	HALÁSOS VAGY SÚLYOS BALESET KÖVETKEZHET BE. Ne helyezzük a gyermekülést a menetirányal szembe, ha az utas oldalán légszák működik.
LV	VAR IZRAISĪT NĀVI VAI NOPIETNAS TRAUMAS. Nenovietot mazuļa sēdekli pretēji braukšanas virzienam, ja pasažiera pusē ir uzstādīts gaisa spilvens.
CZ	HROZÍ NEBEZPEČÍ VÁŽNĚHO UBLIŽENÍ NA ZDRAVÍ NEBO DOKONCE SMRTI. Neumisťujte detskú sedačku do opačné polohy vúči smeru jazdy v prípade aktívneho airbagu spolujazdca.
SLO	LANHO PRIDE DO SMRTI ALI HUDIH POŠKODB. Otroškega avtomobilskega sedeža ne nameščajte v obratni smeri vožnje, če ima vozilo vgrajene zračne blazine za potnike.
RO	SE POATE PRODUCÉ DECESUL SAU LEZIUNI GRAVE. Nu aşezaţi scaunul de maşină pentru bebeluşi în poziţie contrară direcţiei de mers atunci când airbag-ul pasagerului este activat.
GR	ΜΠΟΡΕΙ ΝΑ ΠΡΟΚΛΗΘΟΥΝ ΘΑΝΑΤΟΣ Ή ΣΟΒΑΡΑ ΤΡΑΥΜΑΤΑ. Μην τοποθετείτε το καρεκλάκι αυτοκινήτου για παιδιά σε αντίθετη προς την φορά πορείας θέση σε περίπτωση που υπάρχει αερόσακος εν ενεργεία στη θέση συνεπιβάτη.
BG	ИМА ОПАСНОСТ ОТ СМЪРТ И СЕРИОЗНИ НАРАНЯВАНИЯ. Не поставяйте столчето за пренасяне на бебета в положение обратно на посоката на движение, при положение активно на въздушната възглавница за пътуване.
SK	MŮŽE NASTAŤ SMŤ ALEBO VÁŽNE ZRANENIA. Nedávajte autosedačku pre deti do polohy proti chodu vozidla, keď je aktívny airbag spolujazdca.
RUS	ТРАВМЫ И ЛЕТАЛЬНЫЙ ИСХОД. Детское кресло, устанавливающееся против направления движения, нельзя монтировать на месте переднего пассажира, если последнее оборудовано активной подушкой безопасности.
HR	OPASNOST OD TEŠKIH ILI SMRTONOSNIH OZLJEDA. Sjedala za djecu koja se montiraju u smjeru suprotnom od vožnje ne smiju se instalirati na prednja sjedala ako postoji aktivni zračni jastuk suvozača.
AS	قد تحدث حالات وفاة أو إصابات بالغة. لا تستخدم مقاعد الأمان الخاصة بالأطفال على مقعد مزود "بوسادة هوائية"، حيث إن الطفل قد يتعرض للوفاة أو لإصابة بالغة.



WARNING

- 85) **Do not apply stickers or other objects on the steering wheel, on the dashboard in the passenger side airbag area, on side upholstery on the roof or on the seats. Never put objects (e.g. mobile phones) on the passenger's side dashboard since they could interfere with correct inflation of the airbag and also cause serious injury to the passengers.**
- 86) **Always drive keeping your hands on the steering wheel rim so that the airbag can inflate freely if necessary. Do not drive with your body bent forward. Keep the back of your seat upright and lean back into it.**
- 87) **When an active passenger airbag is fitted, DO NOT install rear facing child restraint systems on the front seat. Deployment of the airbag in an accident could cause fatal injuries to the child regardless of the severity of the impact. Therefore, always deactivate the passenger airbag when a rear facing child restraint system is installed on the front passenger seat. The front passenger seat must also be positioned back as far as possible in order to avoid the child restraint system from coming into contact with the dashboard. Immediately reactivate the passenger airbag as soon as the child restraint system has been removed.**
- 88) **To deactivate the airbags, see the “Knowing your car” section, “Menu Items” paragraph.**
- 89) **When an active passenger airbag is fitted, DO NOT install rear facing child restraint systems on the front seat. Deployment of the airbag in an accident could cause fatal injuries to the child regardless of the severity of the impact.**



SIDE AIRBAGS (SIDE BAGS - WINDOW BAGS)

To increase protection of occupants in case of side collision, the car is equipped with front side bags for pelvis, chest and shoulder protection (side bags) for the driver and the passenger and airbags protecting the head of front and rear occupants (window bags).

Non-activation of side bags in other types of collisions (head-on collisions, rear shunts, roll-overs, etc...) is not an indication of system malfunction.

FRONT SIDE AIRBAGS (SIDE BAGS)

These comprise two types of bags located in the front seat backrests fig. 124 which protect the pelvic, chest and shoulder area of the occupants in the event of a side impact of medium-high severity.

SIDE AIRBAGS FOR HEAD PROTECTION (WINDOW BAGS)

This comprises two "curtain" bags housed behind the roof side linings and covered by special trims fig. 125.

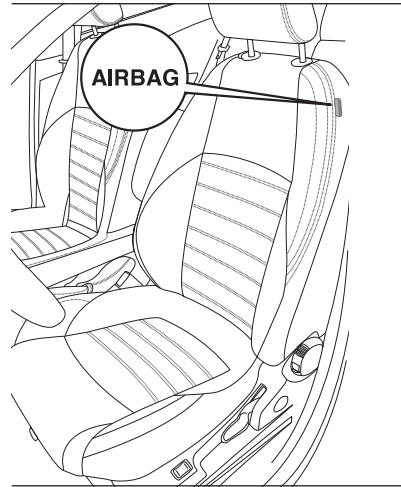

124

AOK0629

It is designed to protect the head of front and rear occupants in the event of a side collision, thanks to the wide cushion inflation surface.

The deployment of side bags in the event of side impacts of low severity is not required.

The airbags are not deployed in the event of low-severity impacts (for which the retaining action of the seat belts is sufficient). It is therefore always necessary to wear seat belts.

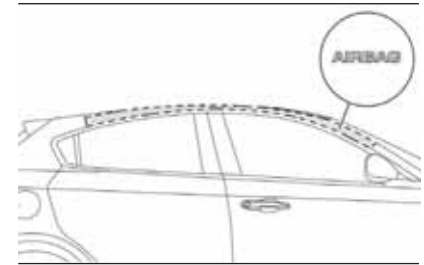

125

AOK0035

In the event of a side impact, the system provides optimum protection if the passenger assumes the correct position on the seat, thus allowing correct window bag deployment.

IMPORTANT

Do not wash the seats with water or pressurised steam (by hand or at automatic seat washing stations).

The front and/or side bags may activate in the event of sharp knocks to the underbody of the car (e.g. impact with steps, pavements, potholes or road bumps etc.).

When the airbag deploys it emits a small amount of dust: the dust is harmless and does not indicate the beginning of a fire. The dust may irritate the skin and eyes however: in this case, wash with neutral soap and water.

Airbag checking, repair and replacement must be carried out at an Alfa Romeo Dealership.

If the car is scrapped, have the airbag system deactivated at an Alfa Romeo Dealership.

Pretensioners and airbags are deployed in different ways, according to the type of impact. Failure to deploy of one of the devices does not necessarily indicate a system malfunction.

 90) 91) 92) 93) 94) 95) 96) 97) 98) 99)



WARNING

- 90) Do not hook rigid objects to the coat hooks and to the support handles.**
- 91) Do not rest your head, arms or elbows on the door, windows or the area in which the window bag is located to avoid possible injury during inflation.**
- 92) Never lean your head, arms and elbows out of the window.**
- 93) If the  warning light does not switch on when the key is turned to MAR-ON, or stays on while driving (on some versions together with a message on the display) there may be a fault in the restraint systems. In this case, airbags or pretensioners may not be activated in the case of an accident or (in a lesser number of cases) they may be activated incorrectly. Before proceeding, contact an Alfa Romeo Dealership to have the system checked immediately.**

94) Do not travel holding objects on your lap, opposite the breast, holding a pipe, pencil, etc. in your lips. Airbag deployment after a collision could cause serious damage/injury.

95) If the car has been subject to theft, attempted to theft, vandalism or flooding, have the airbag system checked by an Alfa Romeo Dealership.



96) *When the ignition key is in and turned in the MAR-ON position and the engine is off, the airbags may deploy if the car is crashed by another moving vehicle. Therefore, even if the car is stationary, when an active passenger airbag is fitted, DO NOT install rear facing child restraint systems on the front passenger seat. Deployment of the airbag following an impact could cause fatal injuries to the child. Therefore, always deactivate the passenger airbag when a rear facing child restraint system is installed on the front passenger seat. The front passenger seat must also be positioned back as far as possible in order to avoid the child restraint system from coming into contact with the dashboard. Immediately reactivate the passenger airbag as soon as the child restraint system has been removed. Also remember that, if the key is turned to STOP, none of the safety devices (airbags or pretensioners) will be deployed in the event of a collision. Non-deployment in such cases does not indicate a system malfunction.*

97) *When the ignition key is turned to MAR-ON, the  warning light turns on (front airbag on passenger's side enabled) and blinks for a few seconds to remind that the passenger airbag will activate in the event of a collision. Then it turns off.*

98) *The front airbags deploy in the event of more severe collisions than those required for deploying the pretensioners. When the impact is between the two deployment thresholds, it is normal that pretensioners only are engaged.*

99) *The airbag does not replace seat belts, but increases their efficiency. Because front airbags are not deployed for low-speed crashes, side collisions, rear-end shunts or rollovers, occupants are protected, in addition to any side bags, only by their seat belts, which must therefore always be fastened.*

STARTING AND DRIVING

Let's get to the "heart" of the car: seeing how you can exploit all of its potential to the full.

We'll look at how to drive it in any situation, so that it can be a welcome companion, with our comfort and our wallets in mind.

STARTING THE ENGINE	148
PARKING	149
USING THE GEARBOX	150
ALFA TCT	151
SAVING FUEL	158
TOWING TRAILERS	160
SNOW TYRES	160
SNOW CHAINS.....	161
STORING THE CAR.....	162



STARTING THE ENGINE



PROCEDURE FOR PETROL VERSIONS

Proceed as follows:

- engage the handbrake and place the gear lever in neutral;
- fully depress the clutch pedal, without touching the accelerator;
- turn the ignition key to AVV and release it as soon as the engine starts.

IMPORTANT INFORMATION  100) 101) 102)

 16) 17) 18)



- If the engine does not start at the first attempt, return the ignition key to STOP before repeating the starting procedure.
- If, when the ignition key is at MAR-ON, the  instrument panel warning light (or the symbol on the display) stays on together with the  warning light, turn the key to STOP and then back to MAR-ON. If the warning light (or the symbol on the display) remains on, try with the other keys provided with the car. Contact an Alfa Romeo Dealership if the engine still does not start.

- Never leave the ignition key at MAR when the engine is stopped.

PROCEDURE FOR DIESEL VERSIONS

Proceed as follows:

 19)

- engage the handbrake and place the gear lever in neutral;
- turn the ignition key to MAR-ON: the warning lights  and  on the instrument panel will turn on (for versions/markets, where provided);
- wait for the warning lights to switch off;
- fully depress the clutch pedal, without touching the accelerator;
- turn the ignition key to AVV as soon as warning light  switches off. Waiting too long will waste the heating work carried out by the glow plugs. Release the key as soon as the engine starts.

WARMING UP THE ENGINE JUST AFTER IT HAS STARTED

Proceed as follows:

- drive off slowly, letting the engine turn at medium speed without accelerating abruptly;

- do not demand full performance at first. It is advisable to wait until the engine coolant temperature indicator starts moving.

STOPPING THE ENGINE

Turn the ignition key to STOP while the engine is idling.

IMPORTANT After a demanding drive, before turning the engine off you should let it idle so that the temperature in the engine compartment decreases.



WARNING

100) It is dangerous to run the engine in enclosed areas. The engine takes in oxygen and releases carbon dioxide, carbon monoxide and other toxic gases.

101) The brake servo is not active until the engine is started, so you would need to apply much more force than usual to the brake pedal.

102) Do not start the engine by pushing, towing or driving downhill. These manoeuvres may damage the catalytic converter.



IMPORTANT

- 16) *In the first period of use, we recommend not to demand maximum performance from the car (for instance excessive accelerations, extended travel at maximum speed, sudden braking, etc.).*
- 17) *With the engine off, do not leave the key in the ignition switch on MAR-ON to prevent draining the battery.*
- 18) *A quick burst on the accelerator before turning off the engine serves absolutely no practical purpose; it wastes fuel and is especially damaging to turbocharged engines.*
- 19) *If the  warning light flashes for about 1 minute after starting or during prolonged cranking, this indicates a fault in the glow plug preheating system. If the engine starts, you may use the car normally, but should contact an Alfa Romeo Dealership as soon as possible.*

PARKING

Always remove the ignition key when leaving the car.

When parking and leaving the car, proceed as follows:

- engage a gear (1st gear if parked uphill or reverse if facing downhill) and leave the wheels turned;
- stop the engine and engage the handbrake.

Block the wheels with a wedge or a stone if the car is parked on a steep slope.

On versions equipped with Alfa TCT transmission, before releasing the brake pedal, wait for letter P to be displayed.

IMPORTANT **NEVER** leave the car with the gearbox in neutral (or, on versions equipped with Alfa TCT transmission, before placing the gear lever at P).

HANDBRAKE

To engage it, pull lever A fig. 126 upwards until the car is secured.

When the handbrake is engaged and the ignition key is at MAR-ON, the  warning light will switch on in the instrument panel.

To release it, raise lever A slightly, hold down button B and lower the lever: the  warning light on the instrument panel switches off.

 103) 104)

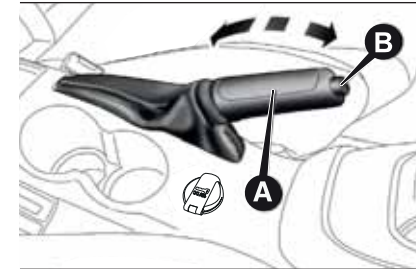

126

A0K0615

IMPORTANT Carry out these manoeuvres with the brake pedal pressed.

IMPORTANT For cars equipped with a front armrest, lift it up to ensure that it does not interfere with the action of the handbrake.





WARNING

- 103) Never leave children unattended in the car. Always remove the key from the ignition device when leaving the car and take it with you.**
- 104) The car must be locked after a few clicks of the parking brake: if this is not so, contact an Alfa Romeo Dealership to have it adjusted. Always park the car safely as indicated by the Highway Code and as described above.**

USING THE GEARBOX

To engage the gears, press the clutch pedal fully and shift the gear lever into one of the required positions (the diagram for gear engagement is shown on the knob of the lever  105)).

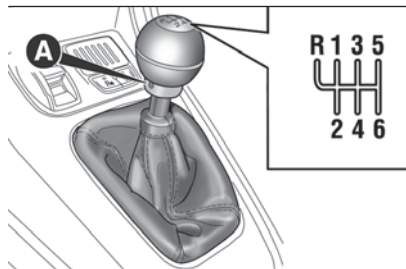

127

A0K0616

To engage the 6th gear, operate the lever by pressing it towards the right in order to avoid engaging the 4th gear by mistake. The same applies to the shift from 6th to 5th gear.  20)

To engage reverse gear (R) from the neutral position, lift up ring A fig. 127 and simultaneously move the lever to the left and then forwards.

IMPORTANT Reverse can only be engaged when the car is completely stationary.



WARNING

- 105) Press the clutch pedal fully to change gears correctly. It is therefore essential that there is nothing under the pedals: make sure the mats are lying flat and do not get in the way of the pedals.**



IMPORTANT

- 20) Do not drive with your hand resting on the gear lever as the force exerted, even if slight, could lead over time to premature wear of the gearbox internal components.**

ALFA TCT

(for versions/markets, where provided)

IN BRIEF

The car can be equipped with an electronically managed Alfa TCT 6-speed automatic transmission where gearshifting takes place automatically according to the instantaneous car usage parameters (car speed, road gradient and accelerator pedal position).

The new transmission is an absolute innovation as it matches the Start&Stop system with the most recent alternative to traditional automatic transmissions with built-in torque converter.

Manual gearshifting can still occur thanks to the sequential mode position of the gear lever.

SELECTOR LEVER

The lever fig. 128 (left hand drive versions) or fig. 129 (right hand drive versions), can be placed in the following positions:

- P** = Park
- R** = Reverse

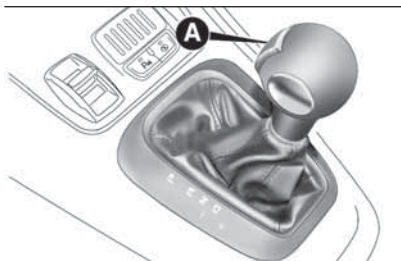

128 - Left hand drive versions

A0K0617



129 - Right hand drive versions

A0K0618

- N** = Neutral
- D** = Drive, (automatic forward speed)
- +** = Sequential upshifting
- = Sequential downshifting

If the lever is used in sequential mode, moving the latter from D to the left, the positions towards + or - are unstable.

The lever has a button A, which must be pressed to move the lever to P or R.

DISPLAY

The display can show the following:

- in automatic driving mode**, the gear selected (P, R, N, D). With lever in position D (Drive), the display will show D and the gear engaged (e.g. D3 - see fig. 130).
- in sequential driving mode**, the manual engagement of a (higher or lower) gear, with the relevant number fig. 131;



130

A0K1540



131

A0K1541

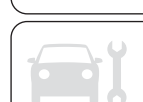

POSITIONS OF THE LEVER

Park (P)

Position P corresponds to the neutral position of the transmission and locks drive wheels mechanically.

It should only be engaged with the car stationary and the handbrake should be applied, if necessary.

With the ignition key at MAR-ON or with engine running, or when the engine switches off, if the gear lever is not correctly positioned in P, letter P starts flashing on the gear lever trim.

In this case, move the lever correctly to position P.  21)

The ignition key can be removed only when the lever is in position P. Moving the lever from P to D must be performed only when the car is stationary and the engine at idling speed.

Shifting from P to any other position of the selector lever, with ignition key in MAR-ON position, must be made pressing the brake pedal and using the button on the gear lever (see paragraph "Selector lever").

If the battery is flat, to release the lever you need to remove the gaiter and operate the lever A fig. 132.

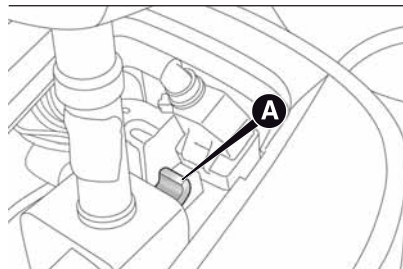

132

A0K0619

IMPORTANT NEVER leave the car before having positioned the selector lever in P.

Reverse (R)

The engine cannot be started with the lever in position R.

Shifting from R to N or D is free, while shifting from R to P can be made by the button on the gear lever, with engine at idling speed.  22)

Neutral (N)

It corresponds to neutral for a standard manual gearbox. The engine can be started with the lever in position N.

Engage N in case of prolonged stops.

To move the lever from position N, release the accelerator and make sure the engine is stable at idling speed.

Shifting from N to D is free, while shifting from N to R or P can only be made by the button on the gear lever.

Drive (D) - Automatic forward gear

It is the lever position in standard running conditions.

Shifting from D to N is free, while shifting from D to R or P can only be made by the button on the gear lever.

Sequential mode (+ / -)

Shifting the lever from position D on side in stable position, the transmission is used in sequential mode.

Shifting the lever in unstable position (+ or -) gears are changed.

Important information

IMPORTANT All movements of the gear lever must be performed with car stationary and engine idling only.

The drive wheels are mechanically locked in position P.

Shifting from P to R is possible with brake pedal pressed and button on gear lever pressed.

Shifting from R to N and from N to D is free.

Shifting from D to "Sequential mode" is free.

Shifting from "Sequential mode" to D is free.

Shifting from D to N is free.

Shifting from N to R is possible only with button on gear lever pressed.

Shifting from R to P is possible only with button on gear lever pressed.

STARTING THE ENGINE

Starting is only permitted with gear lever in position P or N (with or without brake pedal pressed).

On starting, the system is at N or P (the latter means neutral, but with the car's wheels locked mechanically).

Start&Stop system

With car at a standstill and Start&Stop system activated, the engine switches off if the gear lever is in a position other than R.

The Start&Stop system does not operate when the gear lever is in R, for making parking manoeuvres easier.

In the event of stops uphill, the engine switching off is disabled to activate the "Hill Holder" function (works only with running engine).

The engine restarts automatically if:

- the brake pedal is released (and the lever is not at N or P)
- the lever is shifted to an unstable position: +, – or R
- the lever is shifted from D to the left in "Sequential mode"
- by the "+" or "-" paddles on the steering wheel (for versions/markets, where provided)

During the engine stop and start sequence, the system passes through the automatic engagement of neutral: the display shows N.

IMPORTANT In some conditions (for example with small gradients and brake pedal not fully depressed), engine switching off is not deactivated. In this case, fully depress the brake pedal to make the "Hill Holder" function available and restart the engine, using the gear lever or the paddles on the steering wheel (for versions/markets, where provided) as described previously.

ENGINE SWITCHING OFF

Engine can be switched off in any position of the gear lever.

Versions with Start&Stop system

To switch the engine off, you need to stop the car by pressing the brake pedal properly; if the pressure is not enough, the engine will not be switched off.

This feature can be exploited so that the engine does not switch off in particular traffic conditions.

Ignition key removal

The ignition key can be removed only if the gear lever is in position P:

- if the engine is switched off with the gear lever in position P: the ignition key can be removed within 30 seconds;
- if the engine is switched off with the gear lever in a position other than P: the P letter on the display and on the gear lever trim flashes for 5 seconds and an acoustic signal will be emitted at the same time. Move the lever to P within 5 seconds; then it will be possible to remove the ignition key for about 30 seconds.



In both cases, if the described conditions and times are not respected, the ignition key will be automatically locked.

To remove the key, turn it to MAR-ON and then to STOP.

IMPORTANT If the battery is flat and the ignition key is engaged, the latter is locked in position. To remove the key manually, pull up the handbrake and insert the screwdriver supplied in the hole under the dashboard fig. 133 pressing slightly, until the key is removed.

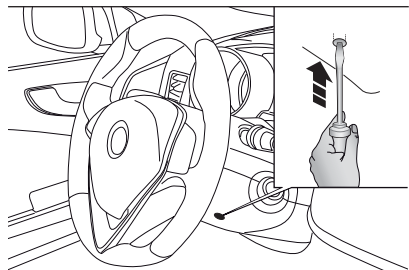

133

AOK0254

MOVING THE CAR

To move the car, from P press the brake pedal and, using the button on the gear lever, move the lever to the desired position (D, R or "Sequential mode").

The display will show the gear engaged.

When the brake pedal is released, the car starts moving forwards or backwards, as soon as the manoeuvre is activated ("creeping" effect). The accelerator should not be pressed in this case.

IMPORTANT The inconsistency between the speed actually engaged (shown on the display) and the position of the gear lever is indicated by the letter corresponding to the position of the lever flashing on the trim (also accompanied by an acoustic signal).

This condition should not be interpreted as an operational fault, but simply as a request by the system to repeat the manoeuvre.

IMPORTANT With engine running and car stationary, in "Sequential mode", the request for engaging 2nd gear is not accepted by the system (whether the brake pedal is pressed or not).

If, with 1st gear or reverse (R) engaged, the following conditions occur:

- road slope over 5%;
- clutch overheated;
- engine torque constant for a given period (e.g. if the car hits the pavement or is parked downhill/uphill);

car movement is achieved by pressing the accelerator pedal.

IMPORTANT With handbrake released and brake pedal released, engine at idling speed and gear lever in position D, R or sequential, pay the utmost care because the car can move even without the operation of the accelerator pedal. This condition can be used with the car on a level surface during tight parking manoeuvres using the brake pedal only.

AUTOMATIC DRIVING MODE

D can be selected from sequential operation in any driving conditions.

In automatic driving mode, the best ratio is selected by the electronic transmission control unit depending on speed, engine load (accelerator pedal position) and gradient of the road.

“Kick-Down” function

To resume speed quickly, when the accelerator pedal is pressed fully, the transmission control system downshifts (“Kick-down” function).

IMPORTANT When driving on roads with poor grip conditions (snow, ice, etc.) avoid activating the kick-down function.

Integration with “Alfa DNA” system

Operating the “Alfa DNA” system fig. 134, three different driving modes can be selected:

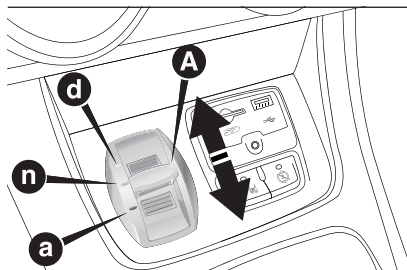

134

A0K0612

- “Dynamic”: gear changes at higher engine speeds. It enhances sporty driving;

- “Natural”: gear changes at low engine speeds. It enhances comfort and reduces consumption;

- “All Weather”: driving programme on roads with poor grip (e.g. snow, ice, mud, etc.).

Gearshifting suggestion

With the transmission in automatic mode (selector lever in position D), when gearshifting is required by the paddles on the steering wheel (for versions/markets, where provided), the system shifts to “Sequential mode”, with relevant displaying of the gear engaged, for about 5 second.

When this time has elapsed, if the paddles are not operated anymore, the system goes back to the automatic mode (D), with following displaying.

SEQUENTIAL DRIVING MODE

In sequential driving mode, the transmission works like a manual gearbox.

Gearshifting through gear lever

Move the lever sideways (to the left) from position D to the sequential position:

- lever towards “+”: engage higher gear;
- lever towards “-”: engage lower gear.

The lever correct position in “Sequential mode” is signalled when the symbols “+” and “-” switch on and the symbol D switches off on the display (the gear engaged only is shown on the display).

Gearshifting through steering wheel paddles (for versions/markets, where provided)

On some versions, the steering wheel paddles can be used to change gear fig. 135. ⚠ 106)

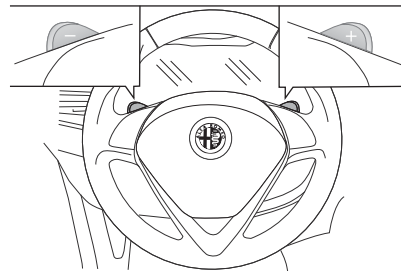

135

A0K0266

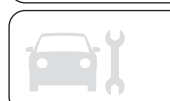

To use the paddles on the steering wheel, the gear lever must be in "Sequential mode" or in D:

- steering wheel paddle "+" (pulling paddle towards driver fig. 136): engage higher gear;
- steering wheel paddle "-" (pulling paddle towards driver fig. 136): engage lower gear.

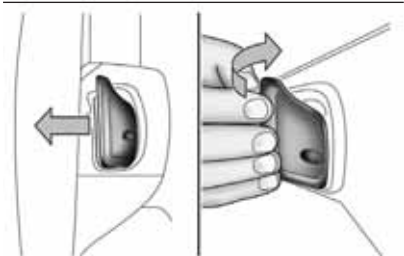

136

A0K0269

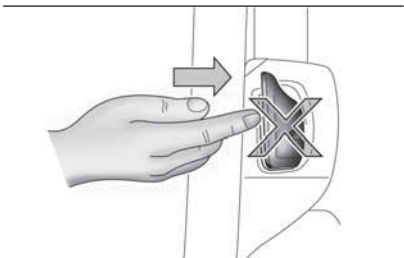

137

A0K0271

The engagement of a lower or higher gear is only permitted if the engine revs allow it.

If the car is stopped with a higher gear than 1st engaged, the transmission will automatically engage 1st gear.

"Launch Control" Function

The "Launch Control" strategy permits high-performance starting.

With the car stationary, proceed as follows to activate this function:

- operate the "Alfa DNA" system and activate the "Dynamic" driving mode;
- depress the brake pedal with your left foot and, simultaneously, fully depress the accelerator pedal with your right foot;
- shift gear using the gear lever or the steering wheel paddle "-" (pulling the paddle towards the driver as previously described): rpm are thus increased from 2750 to 4500; (1.4 Petrol versions) and from 1700 to 2700 (2.0 JTD_M versions);
- release the brake pedal: in this way a more "lively" start is achieved.

When the brake pedal is released, the car will start with maximum acceleration. Despite the "Sequential mode", the car will autonomously shift the gear to guarantee max. acceleration, once the correct shifting speed has been reached.



108)

To abandon the strategy, simply interrupt the above sequence of operations or release the accelerator pedal.

ACOUSTIC SIGNAL

For safety reasons, an acoustic signal is heard when:

- the driver's side door is opened with engine running and the gear lever is in a position other than P;
- engine is switched off with gear lever in a position other than P.

With the car stationary, the engine started and (1st), (D) or (R) gear engaged, the system activates the acoustic signal and automatically places the transmission in neutral (N) when:

- the accelerator and/or brake pedals are not pressed for at least 3 minutes with creeping deactivated (for example with handbrake engaged);

- ❑ the brake pedal is pressed for longer than 10 minutes;
- ❑ the driver's door is opened with creeping deactivated (for example with handbrake engaged) without pressing brake and/or accelerator pedals;
- ❑ a fault has been detected in the transmission.

IMPORTANT Shifting to neutral (N) - operated by the system - involves a situation of inconsistency between gear lever position and gear engaged. The manoeuvre is accompanied by an acoustic inconsistency signal. This acoustic signal continues until the gear lever is placed in P or N, to restore the correct transmission operation conditions.

PARKING THE CAR

To park safely, with the brake pedal pressed, P must be engaged and, in case of parking uphill/downhills, the handbrake must be engaged.

Before releasing the brake pedal, wait until P appears on the display.

IMPORTANT NEVER leave the car before having positioned the lever in P.

TOWING THE CAR

Make sure that the transmission is in neutral (N), checking that the car moves when pushed, and proceed in the same way as for towing a normal car with a manual gearbox.

IMPORTANT If the transmission cannot be put in neutral (N), do not tow the car and contact an Alfa Romeo Dealership. Should the lever be in P, release it before towing (see paragraph "Positions of the lever").

IMPORTANT INFORMATION

With car stationary and gear engaged, always keep the brake pedal pressed until you decide to set off, then release the brake and accelerate gradually.

During prolonged stops with the engine running, it is advisable to keep the transmission in neutral (N).

To protect the clutch, never use the accelerator to keep the car stationary (for example when stopped uphill/downhills): clutch overheating could damage it. Use the brake pedal instead or the handbrake and only press the accelerator pedal when you wish to set off.

If reverse (R) is engaged, only engage the 1st gear (or vice versa) when the car is completely stopped.

Although it is highly inadvisable, if you are driving downhill and, for unexpected reasons, you let the car move forward with the transmission in neutral (N), when there is a request to engage a gear, depending on the speed of the car, the system will automatically engage the best gear for the correct transmission of drive torque to the wheels.  107



IMPORTANT

21) If the car is on a gradient, always pull the handbrake BEFORE placing the gear lever in P.

22) Engage reverse only with the car stationary, engine at idling speed and accelerator fully released.





WARNING

106) Using the levers incorrectly (levers pushed towards the dashboard, see fig. 137) could break them.

107) Never leave children unattended in the car. Always remove the ignition key when leaving the car and take the key with you.

108) The Launch control function is only available in Dynamic mode. Regardless of what is explicitly indicated in the description of these modes, the ESC and ASR systems are deactivated during operation of the Launch Control function. This means that vehicle dynamic control is the sole responsibility of the driver. Therefore pay the utmost attention when using the Launch Control. Take into account traffic and road surface conditions and during manoeuvres make sure there is enough room in the area concerned.

SAVING FUEL

Here are some suggestions which can help you to save fuel and lower harmful emissions.

GENERAL CONSIDERATIONS

Car maintenance

Checks and adjustments should be carried out in accordance with the “Scheduled Servicing Plan” (see chapter “Maintenance and care”).

Tyres

Check the tyre pressures at least once every four weeks: if the pressure is too low, consumption levels increase as resistance to rolling is higher.

Unnecessary loads

Do not travel with an overloaded boot. The weight of the car and its arrangement greatly affect fuel consumption and stability.

Roof rack/ski rack

Remove the roof rack or the ski rack from the roof after use. These accessories lower aerodynamic penetration and adversely affect consumption levels. When transporting particularly large objects, use a trailer if possible.

Electrical devices

Use the electrical devices only for the necessary amount of time. The heated rear window, additional headlights, screen wipers and heater fan require a considerable amount of energy; increasing the current uptake increases fuel consumption (by up to +25% in an urban cycle).

Climate control system

Using the climate control system will increase consumption: use the air vents when the temperature outside permits.

Devices for aerodynamic control

The use of non-certified devices for aerodynamic control may adversely affect air drag and fuel consumption.

DRIVING STYLE

Starting

Do not warm up the engine at low or high revs when the car is stationary; this causes the engine to warm up more slowly, thereby increasing fuel consumption and emissions. It is therefore advisable to move off immediately, slowly, avoiding high speeds: in this way the engine will warm up more quickly.

Unnecessary actions

Avoid accelerating when stopped at traffic lights or before switching off the engine. The latter action, as well as double-declutching, is unnecessary and causes increased fuel consumption and pollution.

Gear selection

Use a high gear when traffic and road conditions allow it. Using a low gear for faster acceleration will increase fuel consumption. In the same way improper use of a high gear increases consumption, emissions and engine wear.

Maximum speed

Fuel consumption considerably increases as speed increases. Maintain a constant speed, avoiding unnecessary braking and acceleration, which cost in terms of both fuel consumption and emissions.

Acceleration

Accelerating violently severely affects consumption and emissions: acceleration should be gradual and should not exceed the maximum torque.

CONDITIONS OF USE

Cold starting

Short distances and frequent cold start-ups will prevent the engine from reaching optimal running temperature. This results in a significant increase in consumption levels (from +15 to +30% on the urban cycle) and emissions.

Traffic and road conditions

High fuel consumption is caused by heavy traffic, for instance when travelling in a queue with frequent use of low gears or in large towns with many traffic lights. Winding mountain roads and rough road surfaces also adversely affect consumption.

Stops in traffic

During prolonged hold-ups (e.g. level crossings) switch off the engine.



TOWING TRAILERS

IMPORTANT

The vehicle must be provided with a type-approved tow hook and adequate electrical system to tow caravans or trailers. Installation must be carried out by a specialist.

Fit any specific and/or additional rear view mirrors as specified by the Highway Code.

Remember that when towing a trailer, steep hills are harder to climb, the braking spaces increase and overtaking takes longer depending on the overall weight.

Engage a low gear when driving downhill, rather than constantly using the brake.

The weight of the trailer reduces the load capacity of the car by the same amount. Consider the weight at full load, including accessories and luggage, to make sure you do not exceed the maximum towable weight (shown in the registration document).

Do not exceed the speed limits specific to each country you are driving in, in the case of vehicles towing trailers. In any case do not exceed 100 km/h.

INSTALLING A TOW HOOK

Contact an Alfa Romeo Dealership to install a tow hook.  109) 110)



WARNING

109) The ABS with which the car is equipped will not control the braking system of the trailer. Particular caution is therefore required when travelling on slippery roads.

110) Never modify the braking system of the car to control the trailer brake. The trailer braking system must be fully independent from the hydraulic system of the car.

SNOW TYRES

Use snow tyres of the same size as the normal tyres provided with the car: the Alfa Romeo Dealership will be able to advise you on the most appropriate tyre to use.

Only use these tyres in the event of ice or snow on the roads.  111)

For the type of tyre to be used, inflation pressures and the specifications of snow tyres, follow the instructions given in the "Wheels" paragraph in the "Technical specifications" chapter.

The winter performance of these tyres is considerably reduced when the tread thickness is less than 4 mm. Replace them in this case.

Due to the specific characteristics of snow tyres, in normal weather conditions or on long motorway journeys, the performance of these tyres is lower than that of standard tyres. Their usage should therefore be restricted in accordance with their type approval.

All four tyres should be the same (brand and track) to ensure greater safety when driving and braking as well as making the car more responsive. It is inadvisable to change the rotation direction of tyres.



WARNING

111) The maximum speed for snow tyres marked "Q" is 160 km/h, while it is 190 km/h for "T" tyres and 210 km/h for "H" tyres. The highway code speed limits must however always be complied with.

SNOW CHAINS

The use of snow chains should be in compliance with local regulations. Snow chains can be fitted to the tyres of the front wheels (drive wheels) only.

Check the tension of the snow chains after the first few metres have been driven.

Use low-clearance snow chains: on all versions, for 195/55 R16", 205/55 R16" and 225/45 R17" size tyres use low-clearance snow chains with a maximum projection beyond the tyre profile of 9 mm.  23)

IMPORTANT The space-saver wheel cannot be fitted with snow chains. If a front (drive) wheel is punctured and snow chains must be used, you must remove a normal wheel from the rear axle and replace it with the space-saver wheel. In this way, with two normal drive wheels, it is possible to use snow chains.



IMPORTANT

23) Keep your speed down when snow chains are fitted; do not exceed 50 km/h. Avoid potholes, steps and pavements and avoid driving for long distances on roads not covered with snow to prevent damaging the car and the road surface.



STORING THE CAR

If the car is to be left inactive for longer than a month, the following precautions should be noted:

- park the car in covered, dry and if possible well-ventilated premises and slightly open the windows;
 - check that the handbrake is not engaged;
 - disconnect the negative battery terminal and check the battery charge. Repeat this check once every three months during storage;
 - if the battery is not disconnected from the electrical system, check its state of charge every thirty days;
 - clean and protect the painted parts using protective wax;
 - clean and protect the shiny metal parts using special compounds available commercially;
 - sprinkle talcum powder on the windscreen and rear window wiper rubber blades and lift them off the glasses;
 - slightly open the windows;
- cover the car with a cloth or perforated plastic sheet. Do not use compact plastic sheets which do not allow humidity to evaporate from the surface of the car.
 - inflate tyres to +0.5 bar above the standard prescribed pressure and check it periodically;
 - do not drain the engine cooling system;
 - Any time the car is left inactive for two weeks or more, operate the air conditioning system with engine idling for at least 5 minutes, setting external air and with fan at maximum speed. This operation will ensure a suitable lubrication to minimise possibility of damage to the compressor when the system is operated again.

IMPORTANT After turning the ignition key to STOP, wait at least 1 minute before disconnecting the electrical supply to the battery.

IN AN EMERGENCY

A punctured tyre or a burnt-out bulb?

At times, a problem may interfere with our journey.

The pages on emergencies can help you to deal with critical situations independently and with calm.

In an emergency we recommend that you call the freephone number found in the Warranty Booklet.

It is also possible to call the 00 800 2532 4200 freephone number to search the nearest Alfa Romeo Authorised Network.



STARTING THE ENGINE	164
REPLACING A WHEEL	165
"FIX&GO AUTOMATIC" KIT	170
CHANGING A BULB	173
REPLACING EXTERIOR BULBS.....	177
INTERIOR BULB REPLACEMENT...	180
REPLACING FUSES.....	181
BATTERY RECHARGING	191
RAISING THE CAR.....	192
TOWING THE CAR	192



STARTING THE ENGINE

Contact the Alfa Romeo Dealership immediately if the warning light  stays on constantly on the instrument panel.

JUMP STARTING

If the battery is flat, start the engine using an auxiliary battery with the same capacity or a little higher than the flat one.  24)  112)

Proceed as follows to start the car:

- connect the positive terminal (+) fig. 138 of the auxiliary battery only to the point indicated on the car battery (writing OK) and nowhere else;
- with a second lead, connect the negative terminal (-) of the auxiliary battery to an earthing point  on the engine or the gearbox/transmission of the car to be started;
- start the engine; when the engine has been started, remove the leads reversing the order above.

For versions with Start&Stop system, in case of starting by auxiliary battery, refer to the paragraph “Start&Stop system” in the chapter “Getting to know your car”.

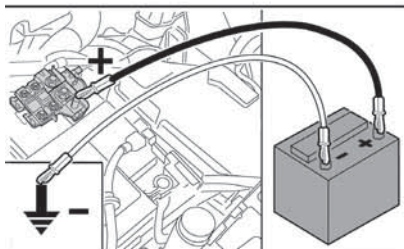
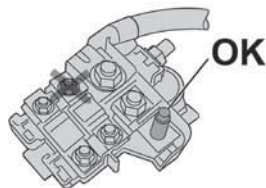

138

A0K0247

If after a few attempts the engine does not start, contact the Alfa Romeo Dealership.

BUMP STARTING

Never jump start the engine by pushing, towing or coasting downhill.



IMPORTANT

- 24) Do not connect the negative terminals of the two batteries directly! If the auxiliary battery is installed on another car, prevent accidental contact between metallic parts of the two cars.**
- 25) Never use a fast battery charger to start the engine as this could damage the electronic systems and the ignition and engine fuel supply control units.**



WARNING

- 112) This procedure must be performed by qualified personnel as incorrect actions may cause high-intensity electrical discharge. Furthermore, battery fluid is poisonous and corrosive: avoid contact with skin and eyes. Keep naked flames away from the battery. No smoking. Do not cause sparks.**

REPLACING A WHEEL

GENERAL INSTRUCTIONS

The car is equipped with the “Fix&Go Automatic Kit”: see the paragraph “Fix&Go Automatic Kit” for how to use this device.

As an alternative to the “Fix&Go Automatic Kit” the car may be requested with a space-saver wheel: see the instructions on the following pages for changing the wheel.

 113) 114) 115) 116) 117)

JACK

Please note that:

- the jack weight is 1.76 kg;
- the jack requires no adjustment;
- the jack cannot be repaired and in the event of a fault it must be replaced by another original one;
- no tool other than its cranking device may be fitted on the jack.

To change a wheel, proceed as follows:

- stop the car in a position that is not dangerous for oncoming traffic where you can change the wheel safely. The ground should be flat if possible, and sufficiently firm;
- switch off the engine, pull up the handbrake and engage the 1st gear or reverse. Wear the reflective safety jacket (compulsory by law) before getting out of the car;
- open the luggage compartment, pull tab A fig. 139 and lift up the mat;

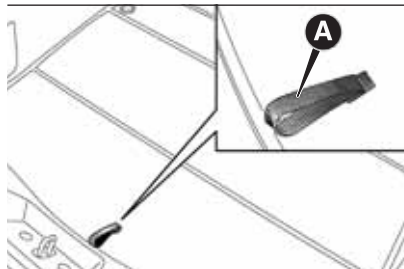

139

A0K0648

- using wrench A fig. 140 positioned in the tool box, loosen the locking device, take the tool box B and place it close to the wheel to be replaced, then take the space-saver wheel C;

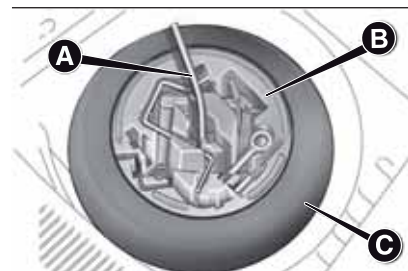

140

A0K0649

- take the wrench A fig. 141 and loosen the fixing bolts by about one turn. For versions with alloy rims, shake the car to facilitate detachment of the rim from the wheel hub.

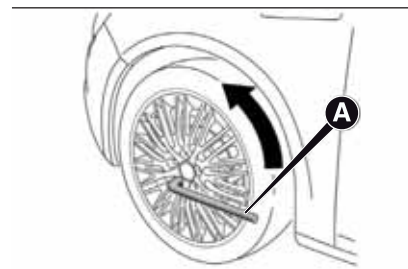

141

A0K0650

- position the jack under the car, near the wheel to be changed. On versions where this is fitted, be careful not to damage the plastic aerodynamic guard;



- operate the device A fig. 142 so as to extend the jack, until the upper part B fig. 143 is inserted correctly inside the side member C;

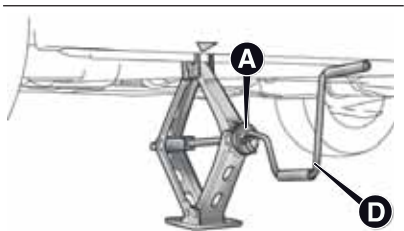

142

A0K0651

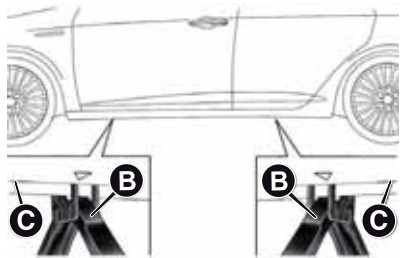

143

A0K0652

- alert any bystander that the car is about to be raised; all persons should be kept away from the car and nobody must touch it until it has been lowered;

- fit handle D into the housing in device A, operate the jack and raise the car until the wheel is a few centimetres from the ground;

- for versions with wheel cap, remove the wheel cap after loosening the 4 fastening bolts and finally loosen the fifth bolt and extract the wheel;

- make sure the contact surfaces between space-saver wheel and hub are clean so that the fastening bolts will not come loose;

- fit the space-saver wheel by inserting the first bolt for two threads into the hole closest to the valve;

- take the wrench A fig. 140 and fully tighten the fixing bolts;

- operate the jack handle D to lower the car. Then extract the jack;

- use the wrench A provided to fully tighten the bolts in a criss-cross fashion as per the numerical sequence illustrated in fig. 144;

- when replacing an alloy wheel it is advisable to place it upside down, with the aesthetic part facing upwards.

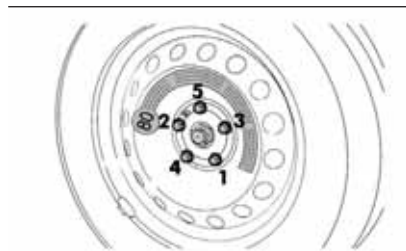

144

A0K0040

Restore the standard wheel as soon as possible, because, once placed in the associated compartment, the luggage compartment load platform is rendered uneven as the standard wheel is larger than the spare wheel.  26)

REMOVING THE SUBWOOFER (versions with Bose HI-FI system)
(for versions/markets, where provided)

IMPORTANT The following procedure only applies to cars equipped with Bose HI-FI systems with subwoofer (for versions/markets, where provided).

Subwoofer and space-saver spare wheel

On these versions, the tools needed for changing the wheel are arranged in a specific container on the left-hand side of the luggage compartment (see fig. 145).



145

A0K0235

The jack is located in a pocket, again on the left-hand side of the luggage compartment (see fig. 146).



146

A0K0228

Proceed as follows to remove the subwoofer:

- open the luggage compartment, pull tab A fig. 147, lift the mat upwards and remove the load compartment shim;

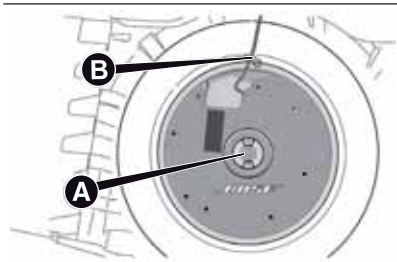

147

A0K0654

- loosen the fastening device A, remove the clip B fastening the cable and then lift the subwoofer;
- rest the subwoofer on the side of the luggage compartment and take the space-saver wheel;
- replace the wheel as described previously.

At the end of the operation:

- reposition the subwoofer correctly (see indications on the label applied over the subwoofer itself), so that the word "BOSE" is positioned in the right direction for reading;

- reposition the subwoofer wire correctly to avoid pinching it. Then fasten the clip B and fasten the blocking device A. Finally, position the load compartment shim correctly and lower the luggage compartment mat.

- reposition the subwoofer correctly (see indications on the label applied over the subwoofer itself), so that the word "BOSE" is positioned in the right direction for reading;

- reposition the subwoofer wire correctly to avoid pinching it. Then fasten the clip B and fasten the blocking device A. Finally, position the load compartment shim fig. 145 correctly and lower the luggage compartment mat.

Subwoofer and "Fix&Go Automatic Kit"

Locating the Automatic Fix&Go Kit:

- open the luggage compartment, pull tab A and lift the mat;
- take the "Fix&Go Automatic Kit" located on the left side of the luggage compartment (see fig. 148);
- inflate the wheel (see paragraph entitled "Fix&Go Automatic Kit").

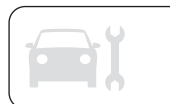



148

A0K0178

IMPORTANT If you need to remove the subwoofer, follow the indications shown on the adhesive label fig. 148 over the subwoofer itself to reposition it correctly.

REFITTING THE WHEEL

Following the procedure described previously, raise the car and remove the space-saver wheel.

Proceed as follows:

- make sure the contact surfaces between standard wheel and hub are clean so that the fastening bolts will not come loose;
- for versions with steel rims:** fix the hub cap on the rim, aligning the crescent hole with the bolt you have fitted, then insert the other 4 bolts;
- tighten the retaining bolts using wrench A fig. 139;

- lower the car and remove the jack;
- use wrench A to fully tighten the bolts, following the sequence illustrated in fig. 144

At the end of operation

Proceed as follows:

- stow the space-saver wheel in the compartment provided in the luggage compartment;
- insert the jack and the other tools in the container;
- arrange the container and tools on the space-saver wheel;
- correctly reposition the luggage compartment mat.



WARNING

113) The space-saver wheel is specific for your car. Do not use it on cars of different models. Do not use space-saver wheels of different models on your car. The space-saver wheel must only be used in the event of emergency. It must only be used for the distance necessary to reach a service point and the car speed must not exceed 80 km/h. The space-saver wheel has an orange label that summarises the main cautions for use and limitations. Never remove or cover the label. Never apply any hub cap to the space-saver wheel.

114) Use your hazard lights, warning triangle, etc to show that your car is stationary. Passengers should get out of the car, particularly if it is heavily loaded, and wait for the wheel to be changed away from the traffic. In the event of a wheel change on a slope or on unsurfaced roads, chock the wheels.

115) Car handling is modified with the space-saver wheel fitted. Avoid violent acceleration and braking, abrupt steering and fast cornering. The overall duration of the space-saver wheel is of about 3000 km, after which the relevant tyre must be replaced with another one of the same type. Never install a traditional tyre on a rim designed to be used as a space-saver wheel. Have the wheel repaired and refitted as soon as possible. Using two or more space-saver wheels at the same time is forbidden. Do not grease the bolt threads before you fit them, because they could suddenly come loose.

116) Use the jack only to replace wheels on the car with which it is supplied or on other cars of the same model. Never use the jack for other purposes, such as lifting other car models. Never use it for repair operations under the car. Incorrect positioning of the jack may cause the car to fall. Do not use the jack for loads higher than those shown on the label. Never install snow chains on the space-saver wheel; if a front tyre (driving wheel) is punctured and you need to use snow chains, use a standard wheel from the rear axle and install the space-saver wheel on the rear axle. In this way, with two normal front drive wheels, it is possible to use snow chains.

117) Incorrect hub cap assembly may cause it to come off when the car is moving. Never tamper with the inflation valve. Never introduce tools of any kind between rim and tyre. Regularly check the inflation pressure of the tyres and space-saver wheel (see chapter "Technical specifications").



IMPORTANT

26) Contact an Alfa Romeo Dealership as soon as possible to have the correct tightening of the wheel bolts checked.



"Fix&Go Automatic" kit

This is located in the luggage compartment (the kit container may vary according to version - see fig. 149).

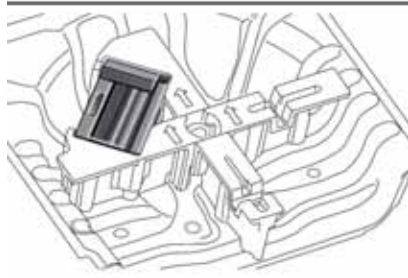
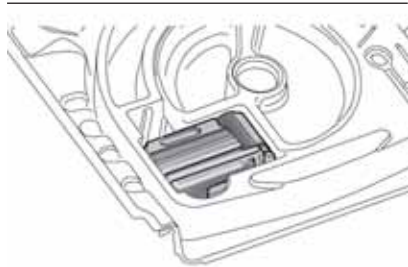

149

A0K0515

The kit also contains a screwdriver and a tow hook.

The kit also contains:

- bottle A fig. 150 containing sealant and fitted with: filling tube B and adhesive label C with the wording "max. 80 km/h" to be placed in a clearly visible position (e.g. on the dashboard) after repairing the tyre;

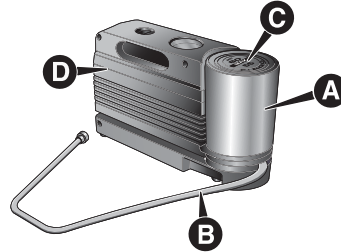

150

A0K0516

- a compressor D complete with pressure gauge and connectors;
- an information leaflet fig. 151, providing instructions for using the kit correctly. This booklet should be given to the persons charged with handling the tyre treated with this kit;
- a pair of gloves located in the side compartment of the compressor;
- adapters for inflating different elements.



2)



118) 119) 121)

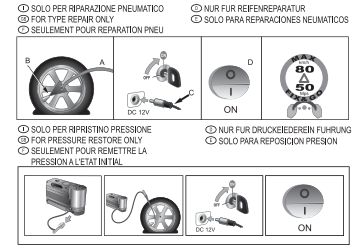

151

A0K0517

IMPORTANT The sealing liquid is suitable for use at temperatures in the range from -20°C to $+50^{\circ}\text{C}$. The sealant has an expiry date.

INFLATION PROCEDURE

120) 122) 123) 124) 125) 126)

Proceed as follows:

- engage the handbrake, unscrew the tyre valve cap, take out filler hose A fig. 152 and tighten ring nut B on the tyre valve;
- make sure that switch A for the compressor is in position **0** (off), start the engine, insert the plug into the luggage compartment power socket (see fig. 154) or on central tunnel (see fig. 155) and switch on the compressor by bringing switch A to position **I** (on);

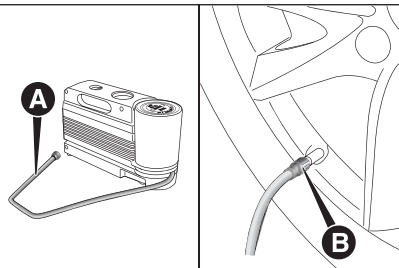

152

A0K0518

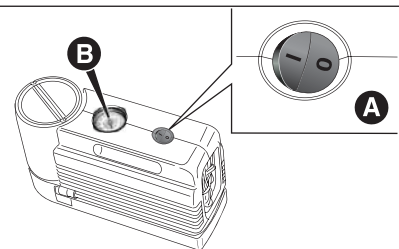

153

A0K0519

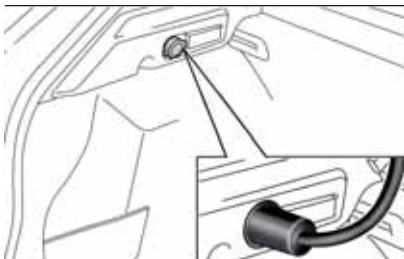

154

A0K0520



155

A0K0128

- inflate the tyre to the pressure indicated in the “Wheels” paragraph in the “Technical data” chapter. In order to obtain a more precise reading, check the pressure value on pressure gauge B fig. 153 with the compressor off;
- if after five minutes it is still impossible to reach at least 1.8 bar, disengage the compressor from the valve and power socket, then move the car forwards by approx. ten metres in order to distribute the sealing fluid inside the tyre evenly, then repeat the inflation operation;
- if you still cannot obtain a pressure of at least 1.8 bar within 5 minutes from the compressor switching on, do not drive off and contact an Alfa Romeo Dealership;

- after having driven for about 10 minutes, stop and recheck the tyre pressure; remember to engage the handbrake;
- if a pressure value of at least 1.8 bar is detected, restore the correct pressure (with the engine running and the handbrake engaged), resume driving and drive with great care to an Alfa Romeo Dealership.

CHECKING AND RESTORING TYRE PRESSURE

The compressor can also be used to check and, if necessary, adjust the tyre pressure.

Release quick coupling A fig. 157 and connect it directly to the valve of the tyre to be inflated.

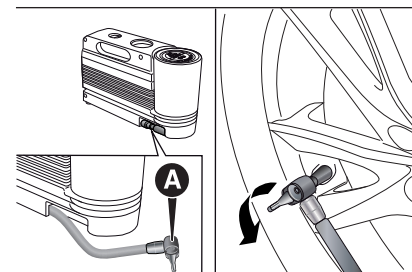

156

A0K0521



REPLACING THE BOTTLE

Proceed as follows:

- release coupling A fig. 157 and disconnect tube B;
- turn the bottle to be replaced anticlockwise and raise it;

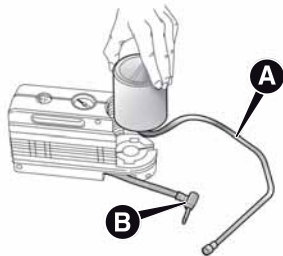

157

AOK0041

- fit the new bottle and turn it clockwise;
- insert coupling A and tube B in position.

**IMPORTANT**

27) In the event of a puncture caused by foreign bodies, the kit may be used to repair tyres showing damages on the tread or shoulder up to max. 4 mm diameter.

**IMPORTANT**

2) Dispose of the bottle and the sealant properly. Dispose of the components in compliance with national and local regulations.

**WARNING**

- 118) Give the booklet to the technicians who will be handling the tyre that was treated using the "Fix&Go Automatic" kit.**
- 119) Punctures on the sides of the tyre may not be repaired. Do not use the kit if the tyre is damaged due to travelling when flat.**
- 120) Wear the protective gloves provided with the kit.**
- 121) Apply the adhesive label where it can be easily seen by the driver as a reminder that the tyre has been treated with the quick repair kit. Drive carefully, particularly on bends. Do not exceed 80 km/h. Do not accelerate or brake suddenly.**
- 122) If the pressure has fallen below 1.8 bar, do not drive any further: the Fix&Go Automatic kit cannot guarantee proper hold because the tyre is too damaged. Contact Alfa Romeo Authorised Services.**

123) Always indicate that the tyre was repaired using the quick tyre repair kit. Give the booklet to the technicians who will be handling the tyre that was treated using the kit.

124) Repair is not possible if the wheel rim is damaged (groove is deformed, causing air to escape). Do not remove foreign bodies (screws or nails) from the tyre.

125) Do not operate the compressor for longer than 20 minutes consecutively. Risk of overheating. The kit is not suitable for definitive repairs, so the repaired tyres may only be used temporarily.

126) The bottle contains ethylene glycol and latex: it may cause an allergic reaction. It is harmful if swallowed. It is irritant for the eyes. It may cause sensitisation if inhaled or on contact. Avoid contact with eyes, skin and clothes. In the event of contact, rinse immediately with plenty of water. If ingested, do not induce vomiting. Rinse out your mouth, drink large quantities of water and seek immediate medical attention. Keep out of the reach of children. The product must not be used by asthmatics. Do not inhale the vapours during insertion and suction. Call a doctor immediately if allergic reactions are noted. Store the bottle in its proper compartment, away from sources of heat. The sealant fluid has an expiry date. Replace the bottle containing out-of-date sealant fluid.

CHANGING A BULB

 28)

 127) 128) 129)

GENERAL INSTRUCTIONS

- Before changing a bulb check the contacts for oxidation;
- replace blown bulbs with others of the same type and power;
- after replacing a headlight bulb, always check its alignment;
- when a light is not working, check that the corresponding fuse is intact before changing the bulb. For the location of fuses, refer to the paragraph "If a fuse blows" in this chapter.

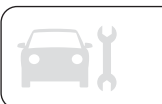

IMPORTANT When the weather is cold or damp or after heavy rain or washing, the surface of headlights or rear lights, may steam up and/or form drops of condensation on the inside. This is a natural phenomenon due to the difference in temperature and humidity between the inside and the outside of the glass which does not indicate a fault and does not compromise the normal operation of lighting devices. The mist disappears quickly when the lights are turned on, starting from the centre of the diffuser, extending progressively towards the edges.

**IMPORTANT**

28) Halogen bulbs must be handled by holding the metallic part only. Touching the transparent part of the bulb with your fingers may reduce the intensity of the emitted light and even reduce the lifespan of the bulb. In the case of accidental contact, rub the lamp with a cloth and spirit and leave to dry.

**WARNING**

127) Changes or repairs to the electrical system carried out incorrectly and without due consideration for the technical specifications of the system may lead to malfunctioning and generate a fire hazard.

128) Halogen bulbs contain pressurised gas. If they break, glass fragments could fly everywhere.

129) Due to the high supply voltage, gas discharge bulbs (Bi-Xenon) should only be replaced by specialised personnel: danger of death! Contact an Alfa Romeo Dealership.

TYPES OF BULBS

The car has the following light bulbs:

Glass bulbs: (type A) they are press-fitted. Pull to extract.

Bayonet-type bulbs: (type B) to remove from its holder, press the bulb and turn it anti-clockwise, then extract it.

Tubular bulbs: (type C) release them from their contacts to remove.

Halogen bulbs: (type D) to remove the bulb, release the clip holding the bulb in place.

Halogen bulbs: (type E) to remove the bulb, release the clip holding the bulb in place.

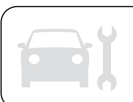
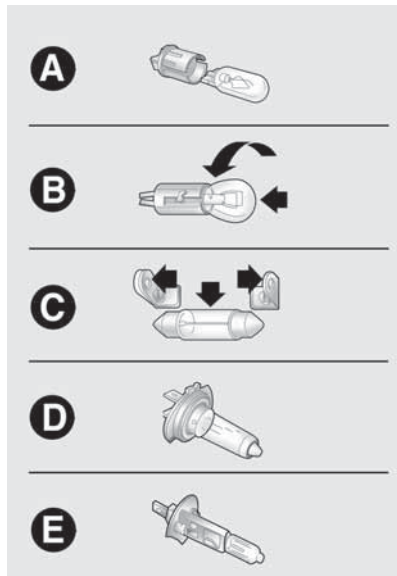

Bulbs	Type	Power	Re. Figure
Front side lights/Daytime running lights (DRL)	LED	-	-
Rear side lights	LED	-	-
Dipped headlights	H7	55W	D
Main beam headlamps	H1	55W	E
Main/Dipped beams (versions with Bi-Xenon headlights) (for versions/markets, where provided)	F	D1S	-
Front direction indicators	PY24W	24W	B
Rear direction indicators	R10W	10W	B
Side direction indicators	LED	-	-
Brake light	LED	-	-
3rd brake light	LED	-	-
Number plate light	W5W	5W	A
Fog lights	H3	55W	E
Rear fog lights	H21W	21W	B
Reversing lights	P21W	21W	B
Front roof light	C10W	10W	C
Luggage compartment roof light	W5W	5W	A
Glove compartment light	C5W	5W	C

REPLACING EXTERIOR BULBS

FRONT LIGHT CLUSTERS

These contain the bulbs for the side lights/daytime running lights (DRL), dipped beams, main beams and direction indicators. The bulbs are arranged as follows fig. 158:

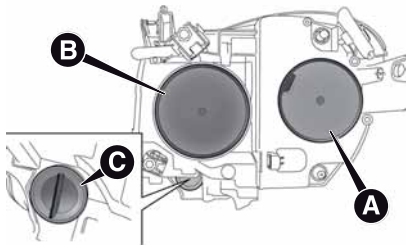

158

A0K0631

- A** Side lights/daytime running lights and main beam headlights
- B** Dipped beam headlights
- C** Direction indicators

SIDE LIGHTS/DAYTIME RUNNING LIGHTS (DRL)

These are LEDs. For the replacement, contact an Alfa Romeo Dealership.

MAIN BEAM HEADLIGHTS

To change the bulb, proceed as follows:

- remove cover A fig. 158;
- remove the connector A fig. 159 and then open the tabs B pulling outwards;

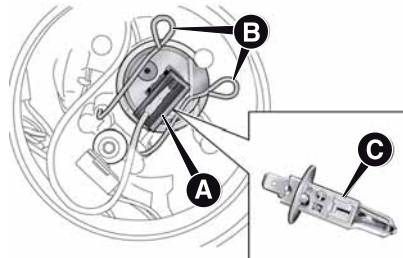

159

A0K0632

- remove the bulb C and replace it;
- refit the new lamp, making sure that it is locked correctly, secure the tabs B again and reconnect the connector A;
- then refit the cover A fig. 158.

DIPPED BEAM HEADLIGHTS

To change the bulb, proceed as follows:

- remove cover B fig. 158;
- remove the connector A fig. 160, press the tab B forward and then release by pushing it towards inside the car;

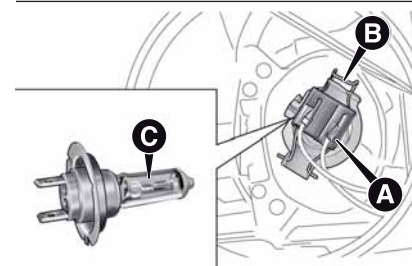

160

A0K0633

- remove the bulb C and replace it;
- refit the new lamp, making sure that it is locked correctly, secure the tab B again and reconnect the connector A;
- then refit the cover B fig. 158.



DIRECTION INDICATORS

Front

To change the bulb, proceed as follows:

- turn the cover C fig. 158 anticlockwise by $\frac{1}{4}$ of a turn;

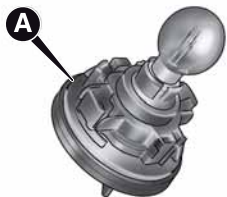

161

A0K0634

- replace the bulb + bulb holder assembly A fig. 161.

Side

These are LEDs. For the replacement, contact an Alfa Romeo Dealership.

FOG LIGHTS

(for versions/markets, where provided)

For replacing these bulbs, contact an Alfa Romeo Dealership.

REAR LIGHT CLUSTERS

These contain the side lights, brake lights, direction indicators (bulbs in fixed light cluster), reverse light and rear fog light (bulb in light cluster on boot hatch).

Removing the fixed light cluster

Proceed as follows:

- open the boot and loosen the rear light cluster fastening screw A fig. 162;

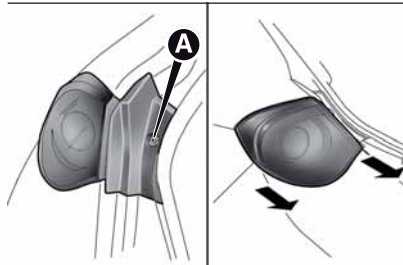

162

A0K0635

- extract the light cluster by removing it with both hands in the direction indicated by the arrows;
- disconnect the electrical connector and replace the bulb concerned.

SIDE LIGHTS/BRAKE LIGHTS

These are LEDs. For the replacement, contact an Alfa Romeo Dealership.

DIRECTION INDICATORS

With the light cluster removed, to replace the bulb undo the two screws A fig. 163, remove the bulb holder and replace bulb B.

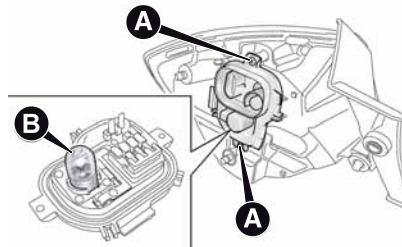

163

A0K0636

REAR FOG LIGHTS/REVERSING LIGHTS

To replace the bulbs proceed as follows:

- open the boot and remove the cover A fig. 164 using a screwdriver in the point indicated by an arrow;

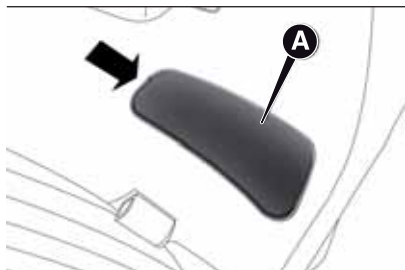

164

A0K0637

- remove the connector A fig. 165 and extract the bulb holder assembly by operating on the retaining tab B and then by loosening the screw C;
- remove the bulb by pushing it slightly and turning it anticlockwise (D = reverse light bulb; E = rear fog light bulb);
- refit the bulb holder assembly positioning it correctly, fasten screw C and then fix it by means of the retaining tab B. Reconnect connector A then refit cover A fig. 164.

IMPORTANT Protect the tip of the screwdriver with a cloth to prevent scratching when removing the cover A.

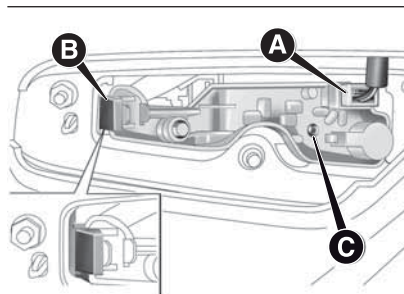

165

A0K0638

3rd BRAKE LIGHTS

These are LED lights and are located on the spoiler integrated with the tailgate. For the replacement, contact an Alfa Romeo Dealership.

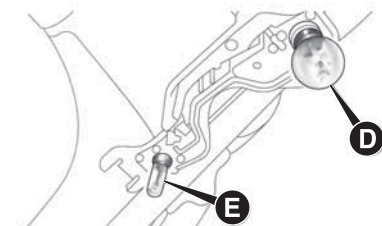

NUMBER PLATE LIGHTS

To replace the bulbs proceed as follows:

- remove the number plate light units A fig. 166;

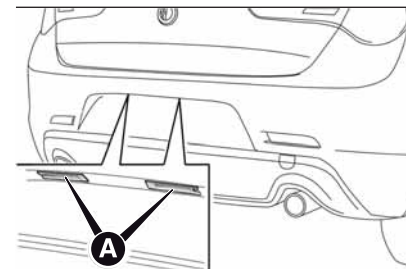

166

A0K0639

- turn the bulb holder B fig. 167 anticlockwise, extract the bulb C and replace it.

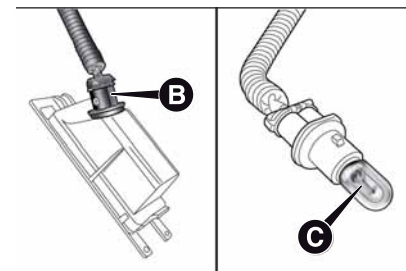

167

A0K0640



INTERIOR BULB REPLACEMENT

FRONT ROOF LIGHT

To change the bulb, proceed as follows:

- remove roof light A fig. 168 working at the points indicated by the arrows;

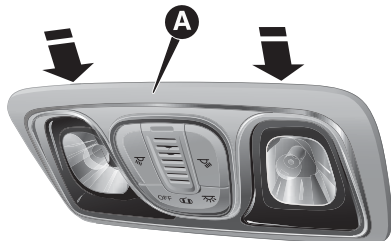

168

A0K0806

- undo the bulb housings B fig. 169 and remove them by extracting outwards: then replace bulbs C;
- correctly fit the new bulbs in the relevant housings B;
- fit roof light A fig. 168 in its housing making sure it is locked.

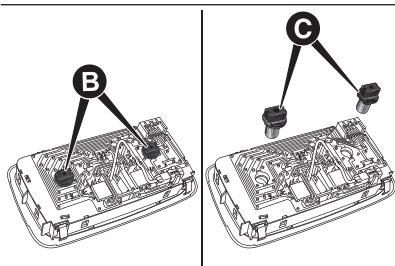

169

A0K0807

REAR ROOF LIGHT

To change the bulb, proceed as follows:

- remove roof light A fig. 170 working at the points indicated by the arrows;

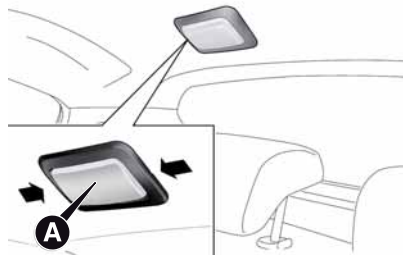

170

A0K0643

- open protective flap B fig. 171 and replace bulb C, releasing it from the side contacts. Make sure that the new bulb is correctly secured between the contacts;

- close protective flap B again and fix roof light A fig. 170 in its housing, making sure that it is locked.

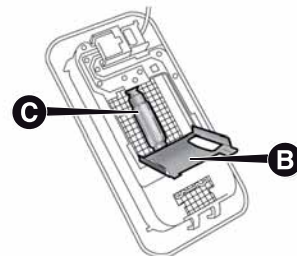

171

A0K0644

LUGGAGE COMPARTMENT COURTESY LIGHT

To change the bulb, proceed as follows:

- open the luggage compartment and extract courtesy light A fig. 172 working in the point shown by the arrow;
- open protection B fig. 173 and replace the bulb;
- refit protection B on the lens;
- refit courtesy light A fig. 172 by inserting it in its correct position firstly on one side and then pressing on the other until it clicks into place.

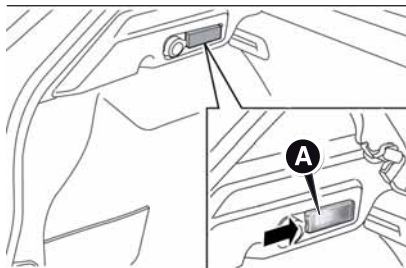

172

A0K0645

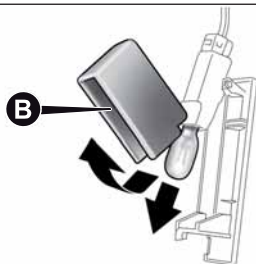

173

A0K0646

GLOVE COMPARTMENT COURTESY LIGHT

To change the bulb, proceed as follows:

- open the glove compartment and extract courtesy light A fig. 174;
- open protection B and replace the bulb;
- refit protection B on the lens;

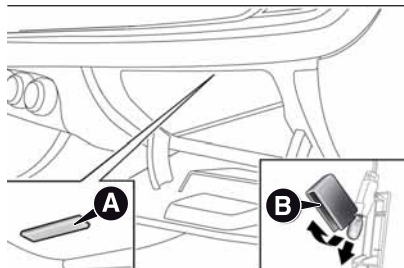

174

A0K0647

- refit courtesy light A by inserting it in its correct position firstly on one side and then pressing on the other until it clicks into place.

COURTESY LIGHT

(for versions/markets, where provided)

For bulb replacement, contact an Alfa Romeo Dealership.

REPLACING FUSES

GENERAL INFORMATION

Fuses protect the electrical system: they intervene (blow) in the event of a failure or improper intervention on the system.

When a device does not work, check the condition of its protection fuse: the filament A fig. 175 must be intact.  29) 30)

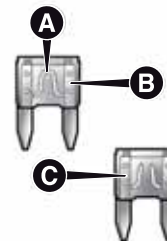

175

A0K0523

If it is not, replace the blown fuse with another having the same amperage (same colour).  130) 131) 132) 133) 134)

B = undamaged fuse.

C = fuse with damaged filament.



Use the pliers A fig. 176 under the engine compartment junction unit lid to remove the fuses (see "Engine compartment junction unit" for how to remove the lid).

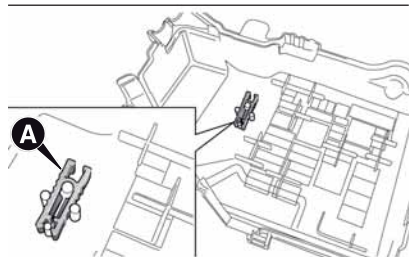

176

AOK0524

VERSIONS WITH "ALFA TCT" AUTOMATIC TRANSMISSION

(for versions/markets, where provided)

The Alfa TCT transmission components are protected by specific fuses. Contact an Alfa Romeo Dealership if a fuse needs replacing.

FUSE LOCATION

Fuses are grouped together in three fuse boxes located in the engine compartment, dashboard and luggage compartment.

Engine compartment fuse box

This is located next to the battery fig. 178: to access the fuses, undo screws A fig. 177 and remove cover B.

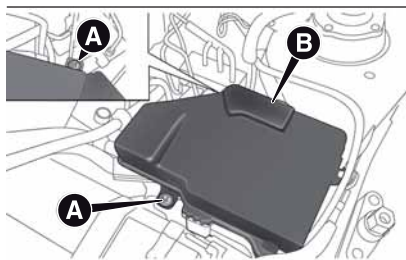

177

A0K0525

The number identifying the electrical component corresponding to each fuse is on the back of the cover.

After replacing the fuse, make sure you close cover B on the junction unit.

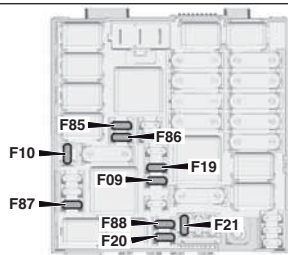

178

A0K0231

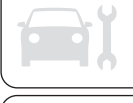

Dashboard fuse box

To access the fuses fig. 180 insert a hand in the housing A fig. 179 and lower the flap B.

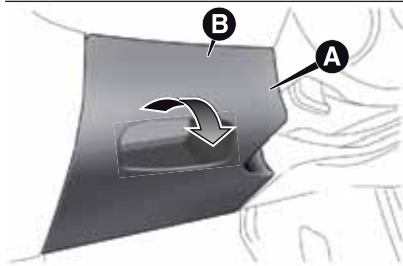

179

A0K0527

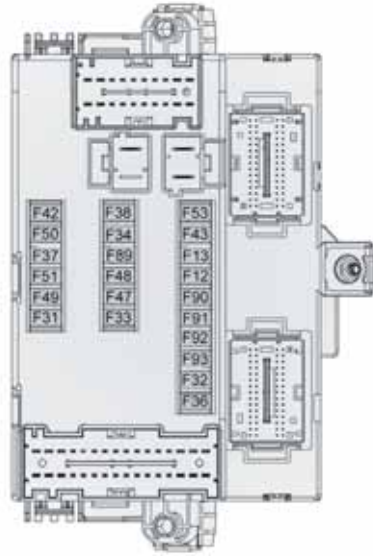

180

A0K0244

Luggage compartment fuse box

The fuse box (fig. 181) is located on the left side of the luggage compartment underneath the side cover.

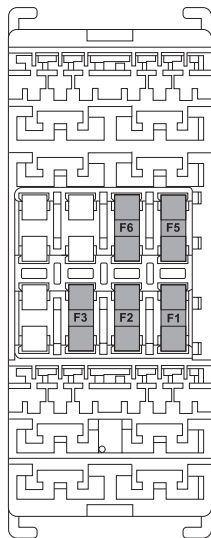

181

A0K0529

For access, contact an Alfa Romeo Dealership.



ENGINE COMPARTMENT FUSE BOX

fig. 178

DEVICE PROTECTED	FUSE	AMPS
Headlamp washer pump power supply	F09	30
Horn	F10	15
AC compressor	F19	7,5
Heated rear window	F20	30
Fuel pump	F21	15
Cigar lighter/power socket	F85	20
12 V boot power socket	F86	20
IBS Battery charge status sensor for Start&Stop system	F87	5
External mirror defrosters	F88	7,5

INSTRUMENT PANEL FUSE BOX

fig. 180

DEVICE PROTECTED	FUSE	AMPS
Right main beam headlight	F91	7,5
Left main beam headlight	F90	7,5
Right dipped beam headlight (versions with halogen headlights)	F12	7,5
Left dipped beam headlight (versions with halogen headlights)	F13	7,5
Right dipped beam headlight (versions with Bi-Xenon headlights)	F12	15
Left dipped beam headlight (versions with Bi-Xenon headlights)	F13	15
Right fog light	F93	7,5
Left fog light	F92	7,5
Luggage compartment courtesy light/Sun visor courtesy light/Glove compartment courtesy light/Front and rear roof lights	F32	10
Various devices	F31	5
Rear electric window (left side)	F33	20
Rear electric window (right side)	F34	20
+30	F36	10
Various devices	F37	7,5
Central locking	F38	20
Body Computer supply	F42	5
Two-way windscreen washer pump	F43	20
Front electric window (driver side)	F47	20



DEVICE PROTECTED	FUSE	AMPS
Front electric window (passenger side)	F48	20
Various devices	F49	5
Various devices	F50	7.5
Various devices	F51	5
+30	F53	7,5

LUGGAGE COMPARTMENT JUNCTION UNIT

fig. 181

DEVICE PROTECTED	FUSE	AMPS
Left front seat movement	F1	15
Right front seat movement	F2	15
Electric sun roof	F3	15
Front seat heating	F5	15
BOSE amplifier + Subwoofer	F6	20



IMPORTANT

29) Never replace a blown fuse with metal wires or other material.

30) If it is necessary to wash the engine compartment, take care not to directly hit the junction unit and the window wiper motors with the water jet.



**WARNING**

- 130) If the fuse blows again contact an Alfa Romeo Dealership.**
- 131) Never replace a fuse with another with a higher amp rating; DANGER OF FIRE.**
- 132) If a general protection fuse (MAXI-FUSE, MEGA-FUSE, MIDI-FUSE) blows, contact an Alfa Romeo Dealership.**
- 133) Before replacing a fuse, make sure that the ignition key has been removed and that all the other services are switched off and/or deactivated.**
- 134) Contact an Alfa Romeo Dealership if a safety system (airbags, brakes), power unit system (engine, gearbox) or steering system general protection fuse blows.**

BATTERY RECHARGING

IMPORTANT The battery recharging procedure is given as information only. To carry out this operation contact an Alfa Romeo Dealership.

IMPORTANT After turning the ignition key to STOP and having closed the driver's side door, wait at least one minute before disconnecting and then reconnecting the battery electrical supply.

Charging should be slow at a low ampere rating for approximately 24 hours. Charging for a longer time may damage the battery.

VERSIONS WITHOUT Start&Stop SYSTEM (for versions/markets, where provided)

To recharge, proceed as follows:

- disconnect the negative battery terminal;
- connect the charger cables to the battery terminals, observing the polarity;
- turn on the charger;
- when it is recharged, turn the charger off before disconnecting it from the battery;
- reconnect the negative battery terminal.

VERSIONS WITH Start&Stop SYSTEM (for versions/markets, where provided)

To recharge, proceed as follows:

- disconnect the connector A fig. 182 (pressing the button B) from the sensor C monitoring the battery conditions, on the negative pole (-) D of the battery;

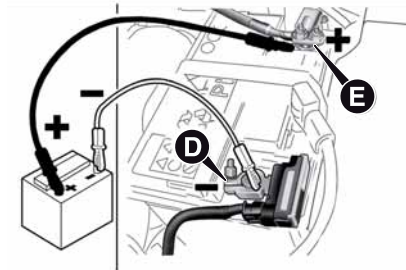
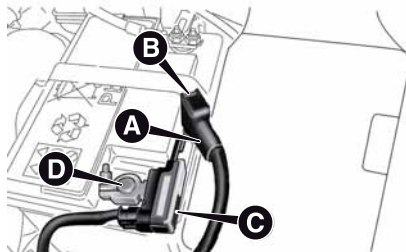

182

A0K0530

- connect the positive cable (+) of the battery charger to the positive battery terminal E and the negative cable (-) to sensor terminal D as shown;
- turn on the battery charger. At the end of the charging process, switch the battery charger off;
- after having disconnected the charging device, reconnect connector A to the sensor C as shown.



RAISING THE CAR

If the car needs to be jacked up, go to an Alfa Romeo Dealership which is equipped with shop jacks and jack arms.

IMPORTANT Be careful when positioning the arm of the lift for versions with side skirts.

TOWING THE CAR

The tow ring provided with the car is housed in the tool box in the boot.

ATTACHING THE TOW HOOK

Release plug A by pressing the lower part, take tow hook B from its housing in the tool support and tighten it securely on the front threaded pin (fig. 183) or on the rear threaded pin (fig. 184).

 135) 136) 137)

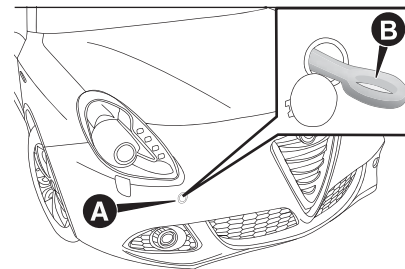

183

A0K0623

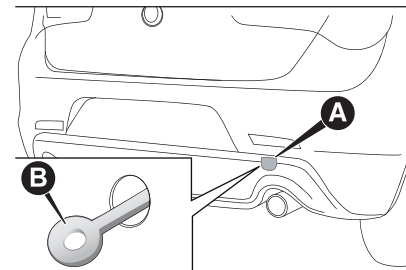

184

A0K0704



WARNING

135) Before towing, turn the ignition key to MAR-ON and then to STOP without removing it. The steering column will automatically lock when the key is removed and the wheels cannot be steered. Also check that the gearbox is in neutral (on versions equipped with Alfa TCT automatic transmission, check that the gear lever is in N position)

136) Remember that the brake servo and the electromechanical power steering will not work while towing the car. You will therefore need to apply more force on the brake pedal and steering wheel. Do not use wires for towing. Do not jerk. During towing, make sure that the trailer hitch does not damage any components it is touching. When towing the car, you must comply with all specific traffic regulations and adopt an appropriate driving behaviour. Do not start the engine while towing the car. Before tightening the ring, clean the threaded housing thoroughly. Make sure that the ring is fully fastened in the housing before towing the car.

137) The front and rear tow hooks should be used only for emergencies on the road. You are allowed to tow the vehicle for short distances using an appropriate device in accordance with the highway code (a rigid bar), to move the vehicle on the road in readiness for towing or transport via a tow truck. Tow hooks **MUST NOT be used to tow vehicles off the road or where there are obstacles and/or for towing operations using cables or other non-rigid devices. Respecting the above conditions, towing must take place with two vehicles (one towing, the other towed) aligned as much as possible along the same centre line.**



This page is intentionally left blank

SERVICING AND MAINTENANCE

Correct maintenance permits the performance of the car to be maintained over time, as well as limited running costs and safeguarding the efficiency of the safety systems.

This chapter explains how.

SCHEDULED SERVICING	196
SCHEDULED SERVICING PLAN	197
PERIODIC CHECKS	204
HEAVY-DUTY USE OF THE CAR	204
CHECKING LEVELS	205
AIR CLEANER/POLLEN FILTER/DIESEL FILTER	210
BATTERY	211
WHEELS AND TYRES	212
WINDSCREEN/REAR WINDOW WIPERS	213
BODYWORK	216
INTERIORS	218



SCHEDULED SERVICING

Correct servicing is essential in guaranteeing a long life for the car under the best conditions.

For this reason, Alfa Romeo has planned a series of checks and services at fixed distance intervals and, for versions/markets, where provided, at fixed time intervals, as described in the Scheduled Servicing Plan.

Regardless of the above, it is always necessary to carefully follow the instructions in the Scheduled Servicing Plan (e.g. periodically check level of liquids, tyre pressure, etc.).

Scheduled Servicing is offered by all Alfa Romeo Dealerships according to fixed time or kilometres/miles intervals. If, during each operation, in addition to the ones scheduled, the need arises for further replacements or repairs, these may be carried out only with your explicit agreement. If your car is used frequently for towing, the interval between one service operation and the next should be reduced.

WARNING

The Scheduled Services intervals are set out by the Manufacturer. Failure to comply with the schedule may invalidate the warranty.

It is advisable to inform the Alfa Romeo Dealership of any small operating irregularities without waiting for the next service.

For versions equipped with specific supply (e.g. LPG) and/or trim level, in addition to what is described in the following Scheduled Servicing Plan, refer to the relevant additional items in the dedicated supplements.

SCHEDULED SERVICING PLAN

PETROL VERSIONS

The checks listed in the Scheduled Servicing Plan, after reaching 120,000 km/8 years, must be cyclically repeated starting from the first interval, thus following the same intervals as before.

Thousands of miles	9	18	27	36	45	54	63	72	81	90
Thousands of kilometres	15	30	45	60	75	90	105	120	135	150
Years	1	2	3	4	5	6	7	8	9	10
Check tyre condition/wear and adjust pressure, if necessary; check "Fix&Go Automatic" kit recharge expiry date (for versions/markets, where provided)	●	●	●	●	●	●	●	●	●	●
Check operation of lighting system (headlights, direction indicators, hazard warning lights, luggage compartment, passenger compartment, glove compartment, instrument panel warning lights, etc.)	●	●	●	●	●	●	●	●	●	●
Check and, if necessary, top up fluid levels (engine coolant, hydraulic clutch/brakes, windscreen washer, battery, etc.)	●	●	●	●	●	●	●	●	●	●
Check exhaust emissions/smokiness	●	●	●	●	●	●	●	●	●	●
Use the diagnosis socket to check supply/engine management system operation, emissions and, for versions/markets, where provided, engine oil degradation	●	●	●	●	●	●	●	●	●	●
Visually inspect condition of: exterior bodywork, underbody protection, pipes and hoses (exhaust, fuel system, brakes), rubber elements (boots, sleeves, bushes, etc.)	●		●		●		●		●	
Check windscreen/rear window wiper blade position/wear	●		●		●		●		●	



Thousands of miles	9	18	27	36	45	54	63	72	81	90
Thousands of kilometres	15	30	45	60	75	90	105	120	135	150
Years	1	2	3	4	5	6	7	8	9	10
Check operation of windscreen wiper/washer system and adjust jets, if necessary	●		●		●		●		●	
Check cleanliness of bonnet and luggage compartment locks, as well as cleanliness and lubrication of linkages		●		●		●		●		●
Check handbrake lever travel and adjust, if necessary		●		●		●		●		●
Visually inspect condition and wear of front disc brake pads and operation of pad wear indicator	●	●	●	●	●	●	●	●	●	●
Visually inspect condition and wear of rear disc brake pads and operation of pad wear indicator (for versions/markets, where provided)	●	●	●	●	●	●	●	●	●	●
Visually inspect condition and tensioning of accessory drive belt(s) (for versions without automatic tensioner only)				●						
Visually inspect condition of toothed timing drive belt				●						
Check and, if necessary, top up the Alfa TCT control oil level (for versions/markets, where provided) (1)		●		●		●		●		●
Change engine oil and replace oil filter (1.4 Turbo Petrol and 1.4 Turbo MultiAir versions) (2)		●		●		●		●		●

(1) Check to be carried out every year for cars on the road in countries with particularly severe climates (cold countries).

(2) If the vehicle is used mainly around town or the annual km is less than 10,000 km, the engine oil and engine oil filter must be changed every year.

Thousands of miles	9	18	27	36	45	54	63	72	81	90
Thousands of kilometres	15	30	45	60	75	90	105	120	135	150
Years	1	2	3	4	5	6	7	8	9	10
Change engine oil and replace oil filter (1750 Turbo Petrol versions) (3)										
Replace spark plugs (1.4 Turbo Petrol and 1.4 Turbo MultiAir versions) (4)		●		●		●		●		●
Replace spark plugs (1750 Turbo Petrol versions)				●				●		
Replace accessory drive belt(s) (5)								●		
Replace toothed timing drive belt (5)								●		

(3) The actual interval for changing engine oil and replacing the engine oil filter depends on the vehicle usage conditions and is signalled by the warning light or message in the instrument panel. Anyway, it must never exceed 1 year.

(4) For 1.4 Turbo Petrol and 1.4 Turbo MultiAir versions, to guarantee correct operation and prevent serious damage to the engine, it is essential to proceed as follows: only use spark plugs specifically certified for these engines; all spark plugs should be of the same type and brand (see the "Engine" paragraph in the "Technical specifications" section); strictly comply with the replacement intervals in the Scheduled Servicing Plan. It is advisable to contact an Alfa Romeo Dealership for spark plug replacement.

(5) Areas that are not dusty: advised maximum mileage 120,000 km. Regardless of the mileage, the belt must be replaced every 6 years.

Dusty areas and/or demanding use of the car (cold climates, town use, long periods of idling): advised maximum mileage 60,000 km. Regardless of the mileage, the belt must be replaced every 4 years.



Thousands of miles	9	18	27	36	45	54	63	72	81	90
Thousands of kilometres	15	30	45	60	75	90	105	120	135	150
Years	1	2	3	4	5	6	7	8	9	10
Replace air cleaner cartridge (6)		●		●		●		●		●
Replace brake fluid		●		●		●		●		●
Replace passenger compartment filter (6)	○	●	○	●	○	●	○	●	○	●

(6) If the car is used in dusty areas, this cleaner must be replaced every 15,000 km.

(○) Recommended operations

(●) Mandatory operations

DIESEL VERSIONS

The checks listed in the Scheduled Servicing Plan, after reaching 120,000 km/6 years, must be cyclically repeated starting from the first interval, thus following the same intervals as before.

Thousands of miles	12	24	36	48	60	72	84	96	108	120
Thousands of kilometres	20	40	60	80	100	120	140	160	180	200
Years	1	2	3	4	5	6	7	8	9	10
Check tyre condition/wear and adjust pressure, if necessary; check "Fix&Go Automatic" kit recharge expiry date (for versions/markets, where provided)	●	●	●	●	●	●	●	●	●	●
Check operation of lighting system (headlights, direction indicators, hazard warning lights, luggage compartment, passenger compartment, glove compartment, instrument panel warning lights, etc.)	●	●	●	●	●	●	●	●	●	●
Check and, if necessary, top up fluid levels (engine coolant, hydraulic clutch/brakes, windscreen washer, battery, etc.)	●	●	●	●	●	●	●	●	●	●
Check exhaust emissions/smokiness	●	●	●	●	●	●	●	●	●	●
Use the diagnosis socket to check supply/engine management system operation, emissions and, for versions/markets, where provided, engine oil degradation	●	●	●	●	●	●	●	●	●	●
Visually inspect condition of: exterior bodywork, underbody protection, pipes and hoses (exhaust, fuel system, brakes), rubber elements (boots, sleeves, bushes, etc.)	●		●		●		●		●	
Check windscreen/rear window wiper blade position/wear	●		●		●		●		●	
Check operation of windscreen wiper/washer system and adjust jets, if necessary	●		●		●		●		●	



Thousands of miles	12	24	36	48	60	72	84	96	108	120
Thousands of kilometres	20	40	60	80	100	120	140	160	180	200
Years	1	2	3	4	5	6	7	8	9	10
Check cleanliness of bonnet and luggage compartment locks, as well as cleanliness and lubrication of linkages		●		●		●		●		●
Check handbrake lever travel and adjust, if necessary		●		●		●		●		●
Visually inspect condition and wear of front disc brake pads and operation of pad wear indicator	●	●	●	●	●	●	●	●	●	●
Visually inspect condition and wear of rear disc brake pads and operation of pad wear indicator (for versions/markets, where provided)	●	●	●	●	●	●	●	●	●	●
Visually inspect condition and tensioning of accessory drive belt(s) (for versions without automatic tensioner only)		●						●		
Check and, if necessary, top up the Alfa TCT control oil level (for versions/markets, where provided) (1)		●		●		●		●		●
Change engine oil and replace oil filter (2) (3)										

(1) Check to be carried out every year for cars on the road in countries with particularly severe climates (cold countries).

(2) The actual interval for changing engine oil and replacing the engine oil filter depends on the vehicle usage conditions and is signalled by the warning light or message in the instrument panel. Anyway, it must never exceed 2 years.

(3) If the car is mainly used in towns and cities, change the engine oil and filter every year.

Thousands of miles	12	24	36	48	60	72	84	96	108	120
Thousands of kilometres	20	40	60	80	100	120	140	160	180	200
Years	1	2	3	4	5	6	7	8	9	10
Replace accessory drive belt(s) (4)						●				
Replace toothed timing drive belt (4)						●				
Replace fuel filter cartridge (5)			●			●			●	
Replace air cleaner cartridge (6)			●			●			●	
Replace brake fluid		●		●		●		●		●
Replace passenger compartment filter (6)	○	●	○	●	○	●	○	●	○	●

(4) Areas that are not dusty: advised maximum mileage 120,000 km. Regardless of the mileage, the belt must be replaced every 6 years.

Dusty areas and/or demanding use of the car (cold climates, town use, long periods of idling): advised maximum mileage 60,000 km. Regardless of the mileage, the belt must be replaced every 4 years.

(5) If the car runs on fuel with quality below the relevant European specification, this filter must be replaced every 20,000 km

(6) If the car is used in dusty areas, this cleaner must be replaced every 20,000 km.

(○) Recommended operations

(●) Mandatory operations



PERIODIC CHECKS

Every 1,000 km or before long journeys, check and, if necessary, top up the following:

- engine coolant, brake fluid and windscreen washer fluid level;
- tyre inflation pressure and condition;
- operation of lighting system (headlamps, direction indicators, hazard warning lights, etc.);
- operation of window washer/wiper system and positioning/wear of windscreen/rear window wiper blades

Check and top up, if required, the engine oil level every 3,000 km.

HEAVY-DUTY USE OF THE CAR

If the car is used mainly under one of the following conditions:

- towing a trailer or caravan;
- dusty roads;
- short, repeated journeys (less than 7-8 km) at sub-zero outside temperatures;

- engine often idling or driving long distances at low speeds or long periods of idleness;

the following checks must be carried out more often than indicated in the Scheduled Servicing Plan:

- check front disc brake pad conditions and wear;
- check cleanliness of bonnet and boot locks, cleanliness and lubrication of linkage;
- visually inspect conditions of: engine, gearbox, transmission, pipes and hoses (exhaust - fuel system - brakes) and rubber elements (boots - sleeves - bushes - etc.);
- check battery charge and battery fluid level (electrolyte);
- visually inspect condition of the accessory drive belts;

- check and, if necessary, change engine oil and replace oil filter;
- check and, if necessary, replace pollen filter;
- check and, if necessary, replace air cleaner.

CHECKING LEVELS

 31)

 138) 139)

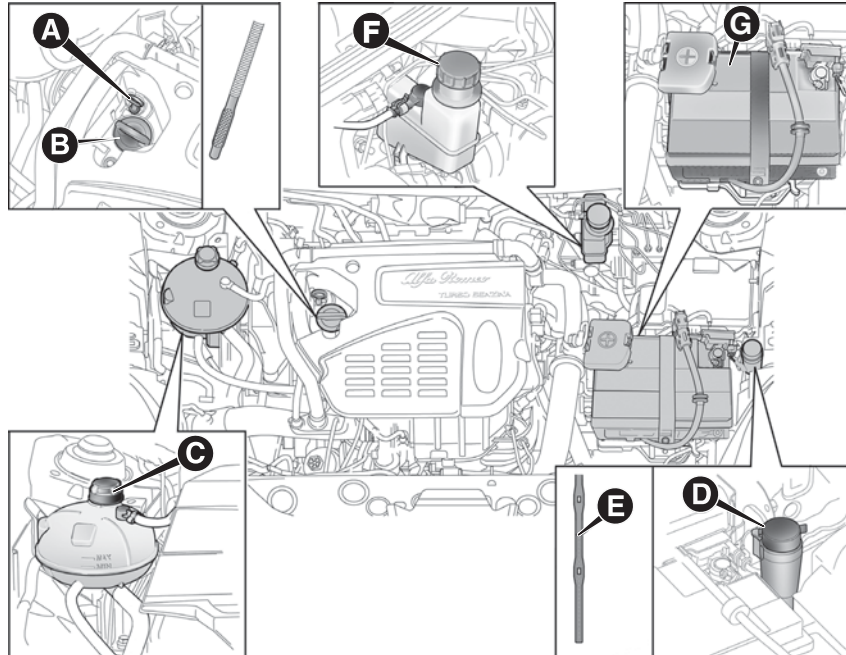

185 - 1.4 Turbo Petrol versions

A0K0655

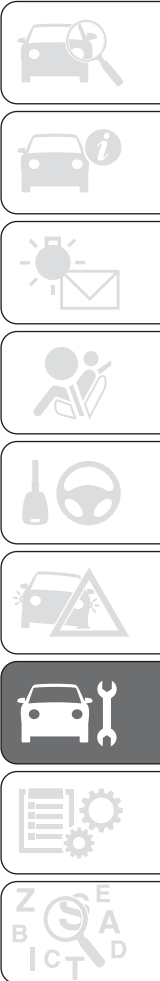

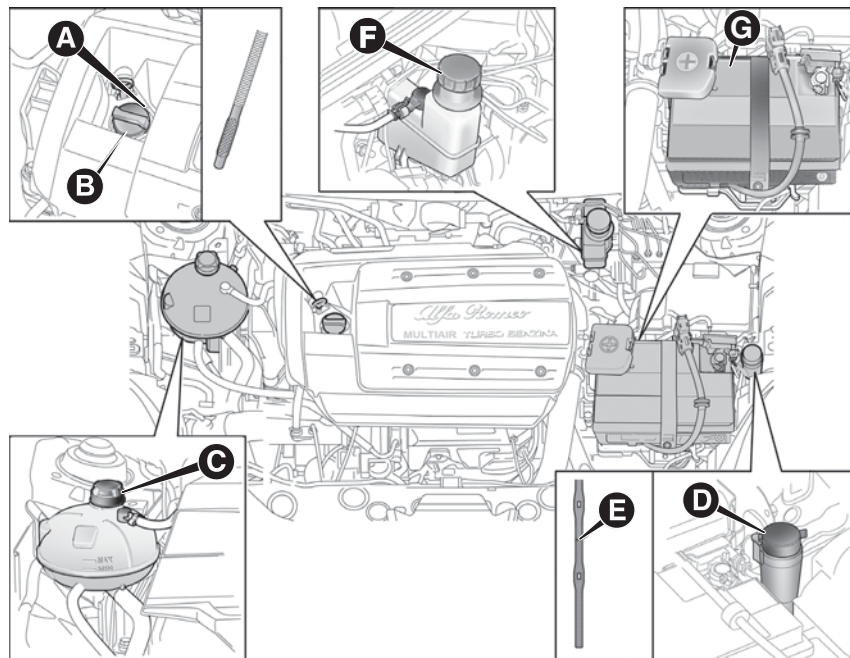

186 - 1.4 Turbo MultiAir versions

A0K0656

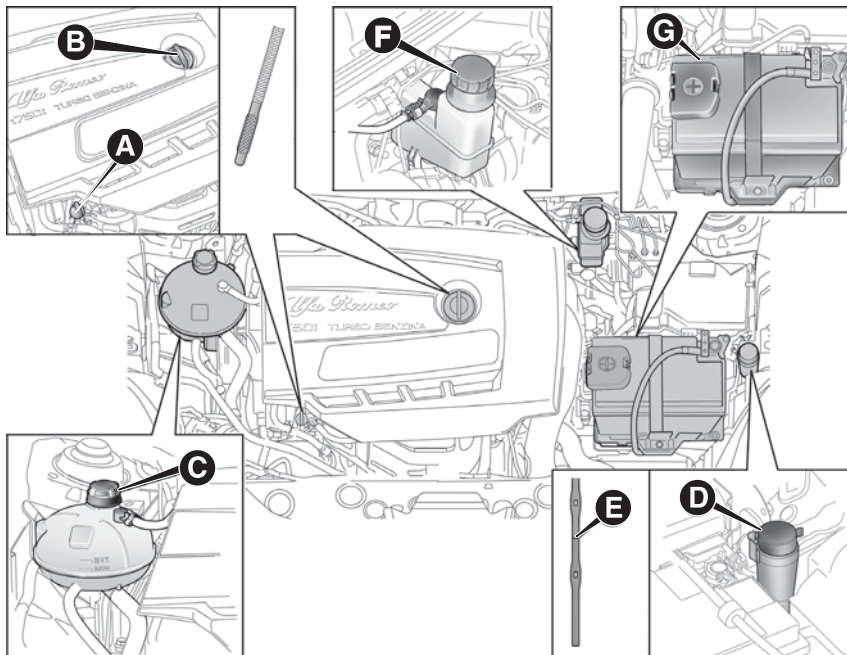

187 - 1750 Turbo Petrol versions

A0K0657



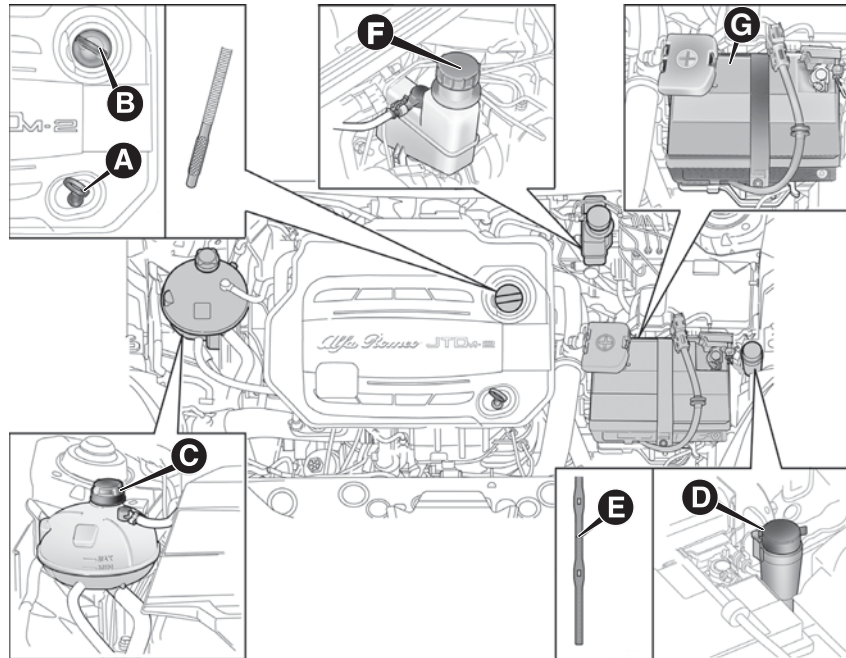

188 - Diesel versions

A0K0658

ENGINE OIL

Check that the oil level is between the MIN and MAX references on the dipstick A.

If the oil level is near or under the MIN reference, add oil through the filler B until it reaches the MAX reference.

⚠ 140) ⚠ 32)

Take out the engine oil dipstick A, clean it with a lint-free cloth and reinsert it. Extract it again and check that the level is between the MIN and MAX marks on the dipstick.

Engine oil consumption

⚠ 33) ⚠ 3)

The maximum engine oil consumption is usually 400 grams every 1,000 km. When the car is new, the engine needs to be run in; therefore the engine oil consumption can only be considered stabilised after the first 5,000 - 6,000 km.

ENGINE COOLANT

If the level is too low, unscrew reservoir cap C and add the fluid described in the "Technical Specifications" section.

 34)  141)

WINDSCREEN/REAR WINDOW WASHER FLUID

If the level is too low, lift reservoir cap P and add the fluid described in the chapter "Technical Specifications".

 142) 143)

IMPORTANT The headlight washer system will not operate when the fluid level is low, even though the windscreen/rear window washer continues to operate. For versions/markets, where provided, there is a reference notch E on the dipstick (see previous pages): **ONLY** the windscreen/rear window wiper operates with the level below this reference.

BRAKE FLUID

Check that the fluid is at the max. level.

If the fluid level in the reservoir is too low, undo reservoir cap E and add the fluid described in the chapter "Technical Specifications".

 35)  144) 145)

ALFA TCT ACTIVATION SYSTEM OIL

(for versions/markets, where provided)

The transmission control oil level should only be checked at an Alfa Romeo Dealership.  4)



IMPORTANT

31) Be careful not to confuse the various types of fluids while topping up: they are not compatible with each other! Topping up with an unsuitable fluid could severely damage your car.

32) The oil level should never exceed the MAX mark.

33) Do not add oil with specifications other than those of the oil already in the engine.

34) PARAFLU^{UP} anti-freeze fluid is used in the engine cooling system; use the same fluid type as that already in the cooling system when topping up. PARAFLU^{UP} may not be mixed with other types of anti-freeze fluids. In the event of topping up with an unsuitable product, under no circumstances start the engine and contact an Alfa Romeo Dealership.

35) Avoid allowing brake fluid, which is extremely corrosive, to come into contact with painted areas. Should it happen, wash immediately with water.



WARNING

138) Never smoke when performing operations in the engine compartment. Flammable gases and fumes may be present and risk igniting.

139) Be very careful when working in the engine compartment when the engine is hot: you may get burned.



**140) If the engine oil is being topped up, wait for the engine to cool down before loosening the filler plug, particularly for cars with aluminium plug (for versions/markets, where provided).
WARNING: risk of burns!**

141) The cooling system is pressurised. If necessary, only replace the plug with another original or the operation of the system may be adversely affected. Do not remove the reservoir plug when the engine is hot: you risk burns.

142) Do not travel with the windscreen washer reservoir empty: the windscreen washer is essential for improving visibility. Repeated operation of the system without fluid could damage or cause rapid deterioration of some system components.

143) Certain commercial additives for windscreen washer fluids are inflammable. The engine compartment contains hot components which may set it on fire.

144) Brake fluid is poisonous and highly corrosive. In the event of accidental contact, immediately wash the affected parts with water and mild soap. Then rinse thoroughly. Call a doctor immediately if swallowed.

145) The symbol  on the container indicates a synthetic brake fluid, which is different from a mineral fluid. Using a mineral-type fluid will damage the special rubber seals of the braking system beyond repair.



IMPORTANT

- 3) Used engine oil and oil filters contain substances which are harmful to the environment. You are advised to contact an Alfa Romeo Dealership to have the oil and filters changed.**
- 4) Used transmission fluid contains substances that are harmful to the environment. You are advised to contact an Alfa Romeo Dealership for oil changes.**

AIR CLEANER/ POLLEN FILTER/DIESEL FILTER

For filter replacement, contact an Alfa Romeo Dealership.

BATTERY

Battery F (see previous pages) does not require the electrolyte to be topped up with distilled water. A periodic check carried out at an Alfa Romeo Dealership is, however, necessary to check efficiency.

REPLACING THE BATTERY

! 146) 147) 148) 149)

! 36)

! 5)

If necessary, replace the battery with another original battery with the same specifications. Follow the battery manufacturer's instructions for maintenance.

USEFUL ADVICE FOR EXTENDING THE LIFE OF YOUR BATTERY

To avoid draining your battery and make it last longer, observe the following instructions:

- when you park the car, ensure that the doors, tailgate and bonnet are closed properly, to prevent any lights from remaining on inside the passenger's compartment;

- switch off all roof lights inside the car: the car is however equipped with a system which switches all internal lights off automatically;

- do not keep accessories (e.g. sound system, hazard lights, etc.) switched on for a long time when the engine is not running;

- before performing any operation on the electrical system, disconnect the negative battery cable.

IMPORTANT After the battery is disconnected, the steering must be initialised. The  warning light switches on to indicate this. To carry out this procedure, simply turn the steering wheel all the way from one end to the other or drive in a straight line for about a hundred metres.

IMPORTANT If the charge level remains under 50% for a long time, the battery is damaged by sulphation, reducing its capacity and efficiency at start-up.

The battery will also be more at risk of freezing (this can happen as early as -10°C). Refer to the paragraph "Car inactivity" in "Starting and driving" chapter if the car is left parked for a long time.

If, after purchasing the car, you wish to install electrical accessories which require permanent electrical supply (e.g. alarm, etc.) or accessories which influence the electrical supply requirements, contact an Alfa Romeo Dealership, whose qualified staff will evaluate the overall electrical consumption.



WARNING

146) Battery liquid is poisonous and corrosive. Avoid contact with the skin and eyes. Keep naked flames and sources of sparks away from the battery: risk of explosion and fire.

147) Using the battery with insufficient fluid irreparably damages the battery and may cause an explosion.

148) If the car must remain unused for a long time at a very low temperature, remove the battery and take it to a warm place, to avoid freezing.



149) When performing any operation on the battery or near it, always protect your eyes with special goggles.



IMPORTANT

36) Incorrect assembly of electrical and electronic accessories may cause severe damage to your car. Go to an Alfa Romeo Dealership if you want to install accessories (e.g. anti-theft, radio phone, etc.): they will suggest the most suitable devices and advise you whether a higher capacity battery needs to be installed.



IMPORTANT

5) Batteries contain substances which are very dangerous for the environment. For battery replacement, contact an Alfa Romeo Dealership.

WHEELS AND TYRES

Before embarking on a long trip, and every two weeks, check the tyre inflation pressure. Check the tyres when cold.

 150) 151) 152) 153)

It is normal for the pressure to increase when the car is used; for the correct tyre inflation pressure, see “Wheels” in the “Technical specifications” chapter.

Incorrect pressure causes abnormal tyre wear fig. 189:

- A normal pressure: tread evenly worn;
- B low pressure: tread particularly worn at the edges;
- C high pressure: tread particularly worn in the centre.

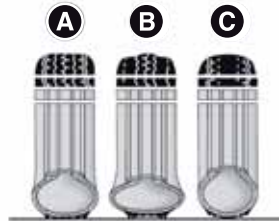

189

A0K0531

The tyres must be replaced when the tread is less than 1.6 mm thick. In any case, follow the laws in force in the country you are in.

IMPORTANT INFORMATION

Take the following precautions to prevent damage to the tyres:

- avoid violent impact against the kerb, potholes or obstacles as well as driving for extended periods on uneven road surfaces;
- periodically check that the tyres have no cuts in the side walls, abnormal swelling or irregular tread wear;
- avoid travelling with the car overloaded. If a tyre is punctured, stop immediately and change it;
- tyres age even if they are not used a great deal. Cracks in the tread and on the side walls are a sign of ageing. Have the tyres checked by specialised personnel if they have been fitted for longer than 6 years;
- in case of replacement, always fit new tyres, avoiding those of dubious origin;
- if a tyre is changed, also change the inflation valve.



WARNING

150) The road holding qualities of the car also depend on the correct inflation pressure of the tyres.

151) If tyre pressure is too low, it may overheat and be severely damaged as a result.

152) Do not switch tyres from the left to the right side and vice versa, in order to prevent inversion of the rotation direction.

153) Do not repaint alloy wheel rims at temperatures higher than 150°C. The mechanical characteristics of the wheels might be compromised.

WINDSCREEN/REAR WINDOW WIPERS

BLADES

It is advisable to replace the blades about once a year.



154)

A few simple precautions can reduce the possibility of damage to the blade:

- if the temperature falls below zero, make sure that ice has not frozen the rubber to the glass. Use an antifreeze product to release it if required;
- remove any snow from the glass;
- do not operate the windscreen/rear window wipers on dry glass.

Replacing the windscreen wiper blades

Proceed as follows:

- raise the wiper arm, press tab A fig. 190 of the attachment spring and remove the blade from the arm;
- fit the new blade by inserting the tab into the special slot in the arm. Make sure that it is properly locked into place.
- lower the wiper arm on the windscreen.

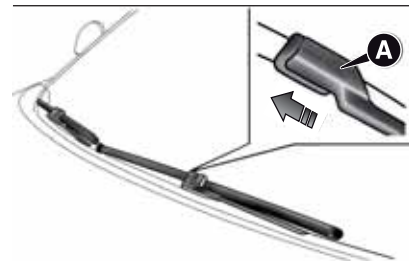

190

A0K0532

Raising the windscreen wipers

If it is necessary to lift the blade from the windscreen (e.g. in the event of snow or if the blade needs replacement) proceed as follows:

- turn the ignition key to the MAR-ON position;
- operate the lever to the right of the steering wheel to activate a windscreen wiper stroke (see paragraph "Window washing" in chapter "Getting to know your car");
- turn the ignition key to the STOP position when the driver's side wiper blade reaches the windscreen side pillar and lift the windscreen wiper to the rest position;
- bring the wiper blades back into contact with the windscreen before activating the windscreen wiper.



37)



"Service position"*Function activation*

The "Service position" function allows the driver to replace the windscreen wiper blades more easily, protecting them from snow.

To activate this function disable the windscreen wiper (ring nut A fig. 191 in position **O**) before turning the ignition key to STOP.

This function can only be activated within 2 minutes from when the ignition key is turned to STOP.



191

A0K0557

To activate this function, move the lever upwards (unstable position) for at least half a second.

Each time the function is activated correctly, the blades move to signal the correct reception of the command.

This command can be repeated up to a maximum of three times. After that the function is disabled.

If after using this function the key is brought back to MAR-ON and the blades are not in the stop position, these will be brought in the 1st speed stop position only after a command given through that lever (moving the lever in unstable position) or when 5 km/h are exceeded.

Function deactivation

The function is deactivated if:

- two minutes have passed since when the ignition key has been taken to STOP;
- the ignition key is turned to MAR-ON and the blades are in the stop position;
- is activated 3 times.

Replacing the rear window wiper blade

Proceed as follows:

- raise cover A fig. 192, undo nut B and remove arm C;

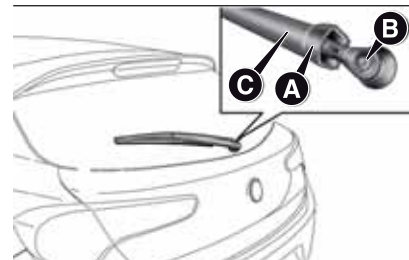

192

A0K0533

- correctly position the new arm, fully tighten the nut B then lower the cover A.

NOZZLES**Windscreen washer**

The windscreen washer nozzles are fixed fig. 193.

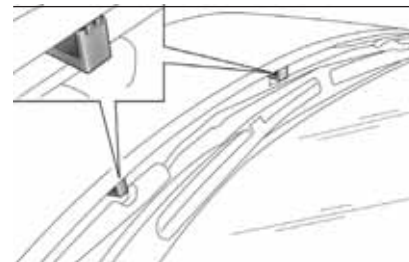

193

A0K0139

If there is no jet of fluid, firstly check that there is some fluid in the reservoir (see paragraph "Checking fluid levels" in this chapter).

Then check that the nozzle holes are not clogged, if necessary use a needle.

Rear window washer

The nozzle holder is located on the rear window fig. 194.

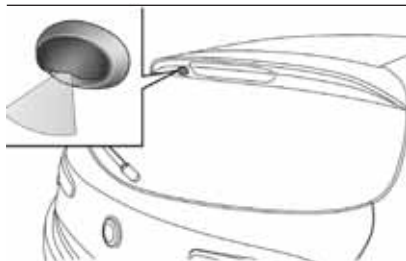

194

A0K0102

The rear window washer jets are fixed.

HEADLIGHT WASHERS

(for versions/markets, where provided)

These are located within the front bumper fig. 195.

They are activated when the dipped beam and/or main beam headlights are on and the windscreen washer is activated.

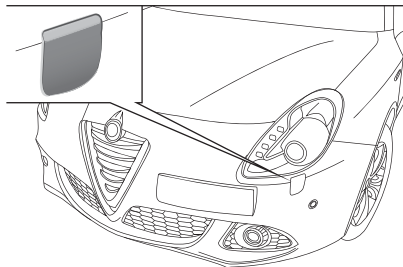

195

A0K0534

Check the correct condition and cleanliness of nozzles at regular intervals.



WARNING

154) Driving with worn windscreen/ rear window wiper blades is a serious hazard, because visibility is reduced in bad weather.



IMPORTANT

37) Do not operate the windscreen wiper with the blades lifted from the windscreen.



BODYWORK

PROTECTION AGAINST ATMOSPHERIC AGENTS

The car is equipped with the best available technological solutions to effectively protect the bodywork against corrosion.

These include:

- painting products and systems which give the car resistance to corrosion and abrasion
- use of galvanised (or pretreated) steel sheets, with high resistance to corrosion;
- spraying of plastic parts, with a protective function in the more exposed points: underdoor, inner wing, edges, etc;
- use of "open" boxed sections to prevent condensation and pockets of moisture which could favour the formation of rust inside;
- use of special films to protect against abrasion in exposed areas (e.g. rear wing, doors, etc.).

BODY AND UNDERBODY WARRANTY

Your car is covered by warranty against perforation due to rust of any original element of the structure or bodywork. For the general terms of this warranty, refer to the Warranty Booklet.

PRESERVING THE BODYWORK

Paintwork 6) 38)

Touch up abrasions and scratches immediately to prevent the formation of rust.

Maintenance of paintwork consists of washing the car: the frequency depends on the conditions and environment where the car is used. For example, it is advisable to wash the car more often in areas with high levels of atmospheric pollution or salted roads.

On some versions the car may be equipped, on request, with an exclusive opaque paint on the roof which, in order to be maintained intact, requires special care: see the instructions in the warning.  39)

To correctly wash the car, follow these instructions:

- remove the aerial from the roof when using a carwash;
 - if high pressure jets or cleaners are used to wash the car, keep a distance of at least 40 cm from the bodywork to avoid damage or alteration. Bear in mind that a build up of water could cause damage to the car in the long term;
 - wash the bodywork using a low pressure jet of water;
 - wipe a sponge with a slightly soapy solution over the bodywork, frequently rinsing the sponge;
 - rinse well with water and dry with a jet of air or a chamois leather.
- Dry the less visible parts (e.g. door frames, bonnet, headlight frames, etc.) with special care, as water may stagnate more easily in these areas. Do not wash the car after it has been left in the sun or with the bonnet hot: this may alter the shine of the paintwork.
- Exterior plastic parts must be cleaned in the same way as the rest of the car.

IMPORTANT

Avoid parking under trees; the resin dropped by trees makes the paintwork go opaque and increases the possibility of corrosion.

Bird droppings must be washed off immediately and thoroughly as the acid they contain is particularly aggressive.

Windows

Use specific detergents and clean cloths to prevent scratching or altering the transparency.

IMPORTANT Wipe the rear window inside gently with a cloth following the direction of the filaments to avoid damaging the heating device.

Front headlights

Use a soft cloth soaked in water and detergent for washing cars.

IMPORTANT Never use aromatic substances (e.g. petrol) or ketenes (e.g. acetone) for cleaning the plastic lenses of the front headlights.

IMPORTANT When cleaning with a pressure washer, keep the water jet at least 20 cm away from the headlights.

Engine compartment

At the end of every winter, wash the engine compartment thoroughly, taking care not to aim the jet of water directly at the electronic control units or at the windscreen wiper motors. Have this operation performed at a specialised workshop.

IMPORTANT The washing should take place with the engine cold and the ignition key in the STOP position. After the washing operation, make sure that the various protections (e.g. rubber caps and guards) have not been removed or damaged.



IMPORTANT

6) Detergents cause water pollution. Only wash your car in areas equipped to collect and treat wastewater from this type of activity.



IMPORTANT

38) In order to preserve the aesthetic appearance of the paint abrasive products and/or polishes should not be used for cleaning the car.



39) **Avoid washing with rollers and/or brushes in washing stations. Wash the car only by hand using neutral pH detergents; dry it with a wet chamois leather. Abrasive products and/or polishes should not be used for cleaning the car. Bird droppings must be washed off immediately and thoroughly as the acid they contain is particularly aggressive. Avoid (if at all possible) parking the car under trees; remove vegetable resins immediately as, when dried, it may only be possible to remove them with abrasive products and/or polishes, which is highly inadvisable as they could alter the typical opacity of the paint. Do not use pure windscreen washer fluid for cleaning the front windscreen and rear window; dilute it min. 50% with water. Only use pure screen washer fluid when strictly necessary due to outside temperature conditions.**

INTERIORS

 155) 156) 157)

Periodically check the cleanliness of the interior, beneath the mats, which could cause oxidation of the sheet metal.

SEATS AND FABRIC PARTS

Remove dust with a soft brush or a vacuum cleaner. It is advisable to use a moist brush on velvet upholstery. Rub the seats with a sponge moistened with a solution of water and neutral detergent.

LEATHER SEATS

(for versions/markets, where provided)

Remove the dry dirt with a slightly damp buckskin or cloth, without exercising too much pressure. Remove any liquid or grease stains using an absorbent dry cloth, without rubbing. Then clean with a soft cloth or buckskin cloth dampened with water and mild soap. If the stain persists, use specific products and observe the instructions carefully.

IMPORTANT Never use alcohol. Make sure that the cleaning products used contain no alcohol or alcohol derivatives, even in small quantities.

PLASTIC AND COATED PARTS

Clean interior plastic parts with a damp cloth (if possible made from microfibre), and a solution of water and neutral, non-abrasive detergent. To clean oily or persistent stains, use specific products free from solvents and designed to maintain the original appearance and colour of the components.

Remove any dust using a microfibre cloth, if necessary moistened with water. The use of paper tissues is not recommended as these may leave residues.  40)

LEATHER PARTS

(for versions/markets, where provided)

Use only water and mild soap to clean these parts. Never use alcohol or alcohol-based products. Before using a specific product for cleaning interiors, make sure that it does not contain alcohol and/or alcohol-based substances.



WARNING

155) Never use flammable products, such as petroleum ether or modified petrol, to clean the inside of the car. The electrostatic charges which are generated by rubbing during the cleaning operation may cause a fire.

156) Do not keep aerosol cans in the car: they might explode. Aerosol cans must not be exposed to a temperature exceeding 50°C. When the car is exposed to sunlight, the internal temperature can greatly exceed this value.

157) There should be no obstacles on the floor underneath the pedals; make sure that mats are always flat and do not interfere with the pedals.



IMPORTANT

40) Never use alcohol, petrols and derivatives to clean the dashboard and instrument panel lens.

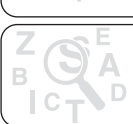

This page is intentionally left blank

TECHNICAL SPECIFICATIONS

Everything you may find useful for understanding how your car is made and works is contained in this chapter and illustrated with data, tables and graphics. For the enthusiasts and the technician, but also just for those who want to know every detail of their car.

IDENTIFICATION DATA.....	222
ENGINE CODES - BODYWORK VERSIONS	223
ENGINE	226
FUEL SUPPLY	231
TRANSMISSION	232
BRAKES	233
SUSPENSION	234
STEERING SYSTEM	235
WHEELS	236
DIMENSIONS.....	240
PERFORMANCE.....	241
WEIGHTS.....	242
REFUELLING	245
FLUIDS AND LUBRICANTS	248
FUEL CONSUMPTION	252
CO2 EMISSIONS	254
PRESCRIPTIONS FOR HANDLING THE VEHICLE AT THE END OF ITS LIFE	255



IDENTIFICATION DATA

The identification data of the car are:

- V.I.N. plate;
- Chassis marking;
- Body paintwork identification plate;
- Engine marking.

V.I.N. PLATE

This plate is fitted to the engine compartment front crossmember and contains the following data fig. 196:

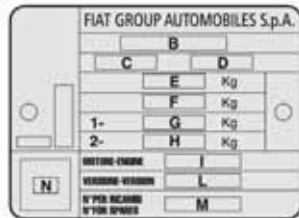

196

A0K0024

- B** Type-approval number.
- C** Vehicle type identification code
- D** Chassis serial number.
- E** Maximum authorised weight of vehicle fully laden
- F** Maximum authorised weight of vehicle fully laden plus trailer.

G Maximum permitted weight on first (front) axle

H Maximum permitted weight on second (rear) axle

I Engine type.

L Bodywork version code.

M Spares number.

N Correct value of smoke coefficient (for diesel engines)

CHASSIS MARKING

This is printed on the passenger compartment floor, near the front right seat.

Slide the flap A fig. 197 forward to access.

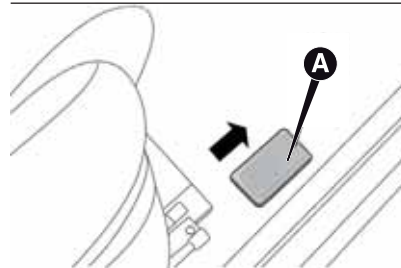

197

A0K0750

The marking includes:

- vehicle type (ZAR 940000);
- chassis serial number.

BODYWORK PAINT IDENTIFICATION PLATE

It is applied under the bonnet and shows the following data fig. 198:



198

A0K0025

- A** Paint manufacturer.
- B** Colour name.
- C** Fiat colour code.
- D** Respray and touch up code.

ENGINE MARKING

This is stamped on the cylinder block and gives the model and the chassis serial number.

ENGINE CODES - BODYWORK VERSIONS

PETROL VERSIONS

Versions	Engine code	Bodywork versions
1.4 Turbo Petrol 120 HP	940B7000	940FXT1A 18
		940FXT1A 18B (*)
		940FXT1A 18C (**)
		940FXT1A 18D (*) (**)
1.4 Turbo Petrol 105 HP (***)	940B8000	940FXU1A 19
		940FXU1A 19B (*)
		940FXU1A 19C (**)
		940FXU1A 19D (*) (**)
1.4 Turbo MultiAir 170 HP	940A2000	940FXB1A 01L
		940FXB1A 01M (*)
		940FXB1A 01N (**)
		940FXB1A 01P (*) (**)

(*) Versions with oversized brake calipers (16" tyres excluded)

(**) Versions for markets with reduced towing capacity 500 kg

(***) For versions/markets, where provided

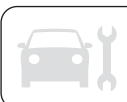

Versions	Engine code	Bodywork versions
1.4 Turbo MultiAir 170 HP TCT	940A2000	940FXB11 10G (***)
		940FXB11 10H (****)
		940FXB11 10L (*****)
		940FXB11 10M (*****)
1.4 Turbo MultiAir 170 HP TCT (***)	940A2000	940FXB11 10N
		940FXB11 10P (*)
1.4 Turbo MultiAir 163 HP (***)	955A8000	940FXG1A 06E
		940FXG1A 06F (*)
1.4 Turbo MultiAir 163 HP TCT (***)	955A8000	940FXG11 13C
		940FXG11 13D (*)
1750 Turbo Petrol 235 HP (***)	940A1000	940FXC1A 02

(*) Versions with oversized brake calipers (16" tyres excluded)

(***) For versions/markets, where provided

(****) Towable load 1300 kg

(*****) Trim levels with oversized brake calipers (towable load 1300 kg)

(******) Towable load 0 kg (for specific countries)

(******) Trim levels with oversized brake calipers (towable load 0 kg for specific countries)

DIESEL VERSIONS

Versions	Engine code	Bodywork versions
1.6 JTD_M 105 HP	940A3000	940FXD1A 03E
		940FXD1A 03F (*)
2.0 JTD_M 136 HP (**)	940B6000	940FXS1A 17
		940FXS1A 17B (*)
2.0 JTD_M 163 HP TCT (**)	940B9000	940FXZ11 21C
		940FXZ11 21D (*)
2.0 JTD_M 150 HP	940B5000	940FXQ1A 15
		940FXQ1A 15B (*)
2.0 JTD_M 175 HP TCT	940B4000	940FXV11 20C
		940FXV11 20D (*)

(*) Versions with oversized brake calipers (16" tyres excluded)

(**) For versions/markets, where provided



ENGINE

GENERAL INFORMATION	1.4 Turbo Petrol 105 HP (*)	1.4 Turbo Petrol 120 HP
Engine code	940B8000	940B7000
Cycle	Otto	Otto
Number and arrangement of cylinders	4 in line	4 in line
Piston bore and stroke (mm)	72.0 x 84.0	72.0 x 84.0
Total displacement (cm ³)	1368	1368
Compression ratio	9.8	9.8
Maximum power (EC) (kW)	77	88
Maximum power (EC) (HP)	105	120
corresponding engine speed (rpm)	5000	5000
Maximum torque (EC) (Nm)	215	215
Maximum torque (EC) (kgm)	22	22
corresponding engine speed (rpm)	2500	2500
Spark plugs	NGK IKR9J8	NGK IKR9J8
Fuel	Unleaded petrol 95 RON (EN 228 Specification)	Unleaded petrol 95 RON (EN 228 Specification)

(*) For versions/markets, where provided

GENERAL INFORMATION
1.4 Turbo MultiAir 163 HP (*)
1.4 Turbo MultiAir 170 HP

Engine code	955A8000		940A2000	
Cycle	Otto		Otto	
Number and arrangement of cylinders	4 in line		4 in line	
Piston bore and stroke (mm)	72.0 x 84.0		72.0 x 84.0	
Total displacement (cm ³)	1368		1368	
Compression ratio	10		10	
Maximum power (EC) (kW)	120		125	
Maximum power (EC) (HP)	163		170	
corresponding engine speed (rpm)	5500		5500	
	NATURAL	DYNAMIC	NATURAL	DYNAMIC
Maximum torque (EC) (Nm)	230	250	230	250
Maximum torque (EC) (kgm)	23.4	25.4	23.4	25.4
corresponding engine speed (rpm)	2250	2500	2250	2500
Spark plugs	NGK IKR9J8		NGK IKR9J8	
Fuel	Unleaded petrol 95 RON or 98 RON (EN 228 Specification)		Unleaded petrol 95 RON or 98 RON (EN 228 Specification)	

(*) For versions/markets, where provided



GENERAL INFORMATION	1750 Turbo Petrol 235 HP (*)		1.6 JTD _M 105 HP	
Engine code	940A1000		940A3000	
Cycle	Otto		Diesel	
Number and arrangement of cylinders	4 in line		4 in line	
Piston bore and stroke (mm)	83.0 x 80.5		79.5 x 80.5	
Total displacement (cm ³)	1742		1598	
Compression ratio	9.8		16.5	
Maximum power (EC) (kW)	172.5		77	
Maximum power (EC) (HP)	235		105	
corresponding engine speed (rpm)	5500		4000	
	NATURAL	DYNAMIC	NATURAL	DYNAMIC
Maximum torque (EC) (Nm)	300	340	280	320
Maximum torque (EC) (kgm)	30.5	34.6	28.5	32.6
corresponding engine speed (rpm)	4500	1900	1500	1750
Spark plugs	NGK ILKAR7D6G		-	
Fuel	Unleaded petrol 98 RON or 95 RON (EN 228 Specification)		Diesel for automotive engines (EN 590 Specification)	

(*) For versions/markets, where provided

GENERAL INFORMATION	2.0 JTD _M 150 HP		2.0 JTD _M 136 HP(*)	
Engine code	940B5000		940B6000	
Cycle	Diesel		Diesel	
Number and arrangement of cylinders	4 in line		4 in line	
Piston bore and stroke (mm)	83 x 90.4		83 x 90.4	
Total displacement (cm ³)	1956		1956	
Compression ratio	16.5		16.5	
	NATURAL	DYNAMIC		
Maximum power (EC) (kW)	103	110	100	
Maximum power (EC) (HP)	140	150	136	
corresponding engine speed (rpm)	3750	3750	3750	
	NATURAL	DYNAMIC	NATURAL	DYNAMIC
Maximum torque (EC) (Nm)	320	380	320	380
Maximum torque (EC) (kgm)	32.5	38.7	32.5	38.7
corresponding engine speed (rpm)	1500	1750	1500	1750
Spark plugs	-		-	
Fuel	Diesel for automotive engines (EN 590 Specification)		Diesel for automotive engines (EN 590 Specification)	

(*) For versions/markets, where provided



GENERAL INFORMATION	2.0 JTD _M 175 HP		2.0 JTD _M 163 HP(*)	
Type code	940B4000		940B9000	
Cycle	Diesel		Diesel	
Number and arrangement of cylinders	4 in line		4 in line	
Piston bore and stroke (mm)	83 x 90.4		83 x 90.4	
Total displacement (cm ³)	1956		1956	
Compression ratio	16.5		16.5	
	NATURAL	DYNAMIC		
Maximum power (EC) (kW)	125	128.5	120	
Maximum power (EC) (HP)	170	175	163	
corresponding engine speed (rpm)	3750	3750	4000	
	NATURAL	DYNAMIC	NATURAL	DYNAMIC
Maximum torque (EC) (Nm)	320	350	320	350
Maximum torque (EC) (kgm)	32.5	35.6	32.5	35.6
corresponding engine speed (rpm)	1500	1750	1500	1750
Spark plugs	-		-	
Fuel	Diesel for automotive engines (EN 590 Specification)		Diesel for automotive engines (EN 590 Specification)	

(*) For versions/markets, where provided

FUEL SUPPLY

Versions	Fuel supply
1.4 Turbo MultiAir	Phased sequential electronic injection with knock control and variable intake valve actuation
1.4 Turbo Petrol - 1750 Turbo Petrol	Electronically controlled phased sequential multipoint electronic injection with turbo and intercooler
1.6 JTD _M - 2.0 JTD _M	Electronically controlled Common Rail MultiJet direct injection with turbo and intercooler

 158)



WARNING

158) Modifications or repairs to the fuel supply system that are not carried out correctly or do not take the system technical specifications into account can cause malfunctions leading to the risk of fire.



TRANSMISSION

Versions	Gearbox	Clutch	Drive
1.4 Turbo Petrol	Six forward speed plus reverse with synchronisers for the engagement of the forward speeds	Self-adjusting pedal without idle stroke	Front
1.4 Turbo MultiAir			
1750 Turbo Petrol			
1.6 JTD_M			
2.0 JTD_M			

BRAKES

Versions	Front brakes	Rear brakes	Parking brake
1.4 Turbo Petrol			
1.4 Turbo MultiAir			
1750 Turbo Petrol	Self-ventilated discs	Disc	Controlled by hand lever, acting on the rear brakes
1.6 JTD_M			
2.0 JTD_M			

IMPORTANT Water, ice and salt spread on the roads may deposit on the brake disks reducing braking efficiency the first time the brakes are applied.



SUSPENSION

Versions	Front	Rear
1.4 Turbo Petrol	MacPherson independent wheel with anti-roll bar	Multi-link structure system
1.4 Turbo MultiAir		
1750 Turbo Petrol		
1.6 JTD_M		
2.0 JTD_M		

STEERING SYSTEM

Versions	Turning circle (kerb to kerb)	Type
1.4 Turbo Petrol		
1.4 Turbo MultiAir		
1750 Turbo Petrol	10.925 m	Rack and pinion with electro-mechanical power steering (Dual Pinion architecture)
1.6 JTD _M		
2.0 JTD _M		



WHEELS

RIMS AND TYRES

Pressed steel or alloy rims. Tubeless radial carcass tyres. All approved tyres are listed in the registration document.

IMPORTANT If there are any discrepancies between the Owner Handbook and the registration document, take the information from the latter. For safe driving, the car must be fitted with tyres of the same make and type on all wheels.

IMPORTANT Do not use tubes with tubeless tyres.

SPACE-SAVER WHEEL

Pressed steel rim. Tubeless tyre.

CORRECT TYRE READING

Example fig. 199: 205/55 R 16 91V

205 Rated width (S, distance in mm between sidewalls)

55 Height/width ratio (H/S) as a percentage

R Radial tyre

16 Rim diameter in inches (Ø)

91 Load rating (capacity)

V Maximum speed index

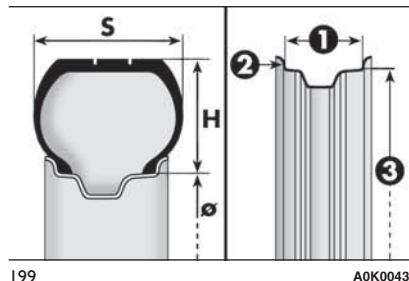

Maximum speed index

Q up to 160 km/h

R up to 170 km/h

S up to 180 km/h

T up to 190 km/h

U up to 200 km/h

H up to 210 km/h

V up to 240 km/h

W up to 270 km/h

Y up to 300 km/h

Maximum speed index for snow tyres

QM + S up to 160 km/h

TM + S up to 190 km/h

HM + S up to 210 km/h

Load rating (capacity)

60 = 250 kg **76** = 400 kg

61 = 257 kg **77** = 412 kg

62 = 265 kg **78** = 425 kg

63 = 272 kg **79** = 437 kg

64 = 280 kg **80** = 450 kg

65 = 290 kg **81** = 462 kg

66 = 300 kg **82** = 475 kg

67 = 307 kg **83** = 487 kg

68 = 315 kg **84** = 500 kg

69 = 325 kg **85** = 515 kg

70 = 335 kg **86** = 530 kg

71 = 345 kg **87** = 545 kg

72 = 355 kg **88** = 560 kg

73 = 365 kg **89** = 580 kg

74 = 375 kg **90** = 600 kg

75 = 387 kg **91** = 615 kg

CORRECT READING OF THE RIM CODE

Example fig. 199: 7 J x 16 H2 ET 41

7 rim diameter in inches (1).

J profile of the flange (side projection where the tyre bead rests) (2).

16 rim fitting diameter in inches (corresponds to diameter of the tyre to be mounted) (3 = Ø).

H2 shape and number of humps (circumference measurement which keeps the bead of Tubeless tyres in position on the rim).

ET 41 wheel camber (distance between the disc/rim support plane and the wheel rim centre line).

RIM PROTECTOR TYRES

! 159)



WARNING

159) DO NOT fit wheel caps when using integral wheel caps fixed (with springs) to the steel rim and after-sale tyres provided with Rim Protector (fig. 200). Use of unsuitable tyres and wheel caps may cause sudden loss of tyre pressure.



200

A0K0159

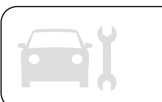

RIMS AND TYRES PROVIDED AS STANDARD

Versions	Rims	Tyres provided	Snow tyres	Space-saver wheel	
				Rim	Tyre
1.4 Turbo Petrol	7Jx16 H2 ET 41 (*)	195/55 R16 91V REINFORCED (*)	195/55 R16 91Q REINFORCED (*)		
1.4 Turbo MultiAir	7Jx16 H2 ET 41	205/55 R16 91V	205/55 R16 91Q	T135/70 R16 100M	4B x 16 ET 22
1.6 JTD_M	7 1/2 Jx17 H2 ET 41	225/45 R17 91W	225/45 R17 91Q	T125/80 R17 99M	4B x 17 ET 25
2.0 JTD_M	7 1/2 Jx18 H2 ET 41 (*)	225/40 R18 92W REINFORCED (*) (**)	225/40 R18 92Q REINFORCED		
1.4 Turbo Petrol (***)	7 1/2 Jx17 H2 ET 41	225/45 R17 91W	225/45 R17 91Q		
1.4 Turbo MultiAir (***)				T125/80 R17 99M	4B x 17 ET 25
1.6 JTD_M (***)	7 1/2 Jx18 H2 ET 41	225/40 R18 92W REINFORCED (**)	225/40 R18 92Q REINFORCED		
2.0 JTD_M (***)					
1750 Turbo Petrol (*)	7 1/2 Jx17 H2 ET 41	225/45 R17 91W	225/45 R17 91Q	T125/80 R17 99M	4B x 17 ET 25
	7 1/2 Jx18 H2 ET 41	225/40 R18 92W REINFORCED (**)	225/40 R18 92Q REINFORCED		

(*) For versions/markets, where provided

(**) Tyres which cannot be fitted with chains

(***) Versions with oversized brake calipers

On versions with 195/55 R16", 205/55 R16" e 225/45 R17" tyres, reduced size snow chains can be used, with a maximum projection of 9 mm beyond the tyre profile.

COLD TYRE INFLATION PRESSURE (bar)

VERSIONS	MEASUREMENT	TYRES PROVIDED			
		MEDIUM LOAD		FULL LOAD	
		Front	Rear	Front	Rear
1.4 Turbo petrol 115/120 HP 1.6 JTD_M	195/55 R16 91V REINFORCED	2,6	2,2	3,0	2,6
	205/55 R16 91V	2,3	2,1	2,7	2,3
	225/45 R17 91W	2,3	2,1	2,7	2,3
	225/40 R18 92W REINFORCED	2,6	2,2	3,0	2,6
1.4 Turbo Petrol 105 HP (*)	195/55 R16 91V REINFORCED	2,6	2,2	2,9	2,5
	205/55 R16 91V	2,3	2,1	2,5	2,1
	225/45 R17 91W	2,3	2,1	2,6	2,2
	225/40 R18 92W REINFORCED	2,5	2,3	2,9	2,5
1.4 Turbo MultiAir 2.0 JTD_M	195/55 R16 91V REINFORCED	2,6	2,2	3,0	2,6
	205/55 R16 91V	2,3	2,1	2,7	2,3
	225/45 R17 91W	2,3	2,1	2,7	2,3
	225/40 R18 92W REINFORCED	2,6	2,2	3,0	2,6
1750 Turbo Petrol (*)	225/45 R17 91W	2,3	2,1	2,7	2,3
	225/40 R18 92W REINFORCED	2,6	2,2	3,0	2,6
Space-saver wheel	T135/70 R16 100M			4.2	
	T125/80 R17 99M				

(*) For versions/markets, where provided

Add +0.3 bar to the prescribed pressure when the tyres are warm. Check correct pressure on a cold tyre.

With snow tyres, add +0.2 bar to the inflation pressure value prescribed for standard tyres.

When travelling at speeds over 160 km/h, inflate the tyres to the values specified for fully laden conditions.



DIMENSIONS

Dimensions are expressed in mm and refer to the vehicle equipped with its original tyres. Height is measured with car unladen.

BOOT VOLUME Unladen capacity (V.D.A. standards): = 350 dm³

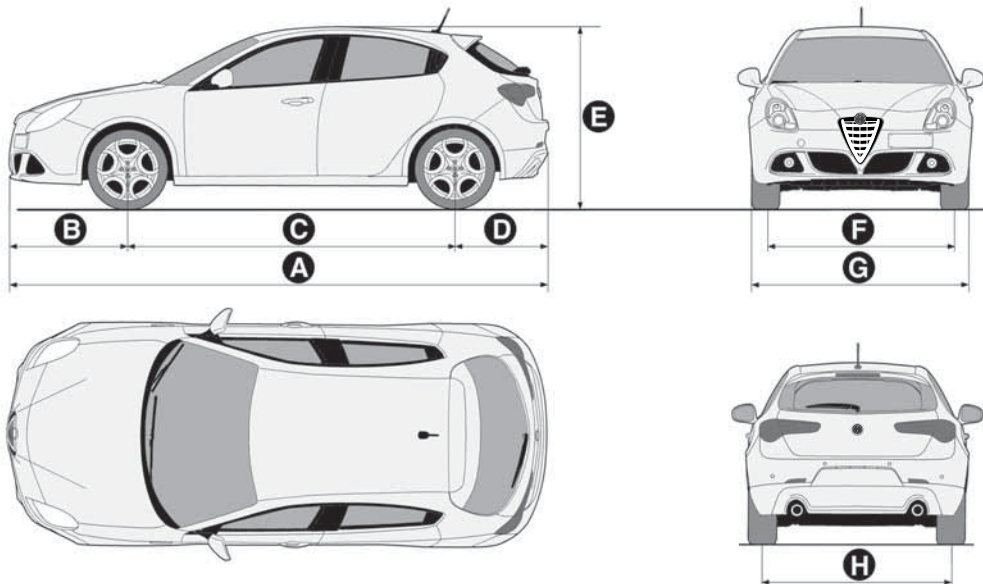

201

A0K0822

A	B	C	D	E	F	G	H
4351	955	2634	762	1465	1554	1798	1554

Small variations in size are possible depending on the dimensions of the rims

PERFORMANCE

Versions	Top speed (km/h)	Acceleration from 0-100 km/h (secs)
1.4 Turbo Petrol 120 HP	195	9,4
1.4 Turbo Petrol 105 HP (*)	185	10,6
1.4 Turbo MultiAir 163/170 HP (*)	218	7,8
1.4 Turbo MultiAir 163 HP TCT (*)	218	7.7
1.4 Turbo MultiAir 170 HP TCT	218	7.7
1750 Turbo Petrol 235 HP (*)	242	6.8
1.6 JTD_M 105 HP	185	11,3
2.0 JTD_M 136 HP (*)	205	–
2.0 JTD_M 150 HP	210	8,8
2.0 JTD_M 163 HP TCT (*)	215	8.2
2.0 JTD_M 175 HP TCT	219	7.8

(*) For versions/markets, where provided



WEIGHTS

Weights	1.4 Turbo Petrol	1.4 Turbo MultiAir(*)	1.4 Turbo MultiAir(**)
Unladen weight (with all fluids, fuel tank filled to 90% and without optional equipment)	1280	1290	1305
Payload including the driver (***)	505	505	505
Maximum permitted loads (****)			
– front axle	1100	1100	1100
– rear axle	850	850	850
– total	1785	1795	1810
Towable loads (kg)			
- braked trailer	1300	1300	1300 / 0 (****)
– trailer without brakes	500	500	500
Maximum load on roof	50	50	60
Maximum load on tow hitch (trailer with brakes)	60	60	60

(*) Versions with manual gearbox

(**) Versions with Alfa TCT

(***) If special equipment is fitted (sun roof, tow hitch, etc.) the unladen car weight increases, thus reducing the specified payload in relation to the maximum permitted loads.

(****) Hot-humid climate countries

Weights	1750 Turbo Petrol 235 HP (*)	1.6 JTD _M
Unladen weight (with all fluids, fuel tank filled to 90% and without optional equipment)	1320	1310
Payload including the driver (**)	505	505
Maximum permitted loads (***)		
– front axle	1100	1100
– rear axle	850	850
– total	1825	1815
Towable loads (kg)		
- braked trailer	1300	1300
– trailer without brakes	500	500
Maximum load on roof	50	50
Maximum load on tow hitch (trailer with brakes)	60	60

(*) For versions/markets, where provided

(**) If special equipment is fitted (sun roof, tow hitch, etc.) the unladen car weight increases, thus reducing the specified payload in relation to the maximum permitted loads.

(***) Loads not to be exceeded. The user is responsible for arranging goods in the luggage compartment and/or load platform within the maximum permitted loads.



Weights	2.0 JTD _M (*)	2.0 JTD _M (**)
Unladen weight (with all fluids, fuel tank filled to 90% and without optional equipment)	1320	1335
Payload including the driver (***)	505	505
Maximum permitted loads (****)		
– front axle	1100	1100
– rear axle	850	850
– total	1825	1840
Towable loads (kg)		
- braked trailer	1300	1300 / 600 (*****)
– trailer without brakes	500	500
Maximum load on roof	50	50
Maximum load on tow hitch (trailer with brakes)	60	60

(*) Versions with manual gearbox

(**) Versions with Alfa TCT

(***) If special equipment is fitted (sun roof, tow hitch, etc.) the unladen car weight increases, thus reducing the specified payload in relation to the maximum permitted loads.

(****) Loads not to be exceeded. The user is responsible for arranging goods in the luggage compartment and/or load platform within the maximum permitted loads.

(*****) 2.0 JTD_M 163 HP TCT versions

REFUELLING

	1.4 Turbo Petrol		1.4 Turbo MultiAir		Recommended fuels and original lubricants
	litres	kg	litres	kg	
Fuel tank	60	–	60	–	Unleaded petrol not less than 95 RON (EN 228 specification)
including a reserve of	8 - 10	–	8 - 10	–	
Engine cooling system (with climate control)	5,7	5,0	5,7	5,0	50-50 mixture of demineralised water and PARAFLU ^{UP} (*)
Engine sump	2,75	2,3	3,1	2,6	SELENIA StAR P.E. (1.4 Turbo Petrol version)
Engine sump and filter	3,1	2,6	3,5	2,9	SELENIA DIGITEK P.E. (1.4 Turbo Multi Air version)
Differential/gearbox casing	2.0	1.7	2.0	1,7	TUTELA TRANSMISSION GEARFORCE
Hydraulic brake circuit with ABS antilock brakes	0,83	0,78	0,83	0,78	TUTELA TOP 4
Windscreen/rear window/headlight washer fluid reservoir (**)	2,8 (4,6)	2,5 (4,1)	2,8 (4,6)	2,5 (4,1)	Mixture of water and TUTELA PROFESSIONAL SC 35

(*) For particularly harsh climate conditions, a mixture of 60%^{UP} and 40% demineralised water is recommended.

(**) Values in brackets refer to versions with headlight washers



	1750 Turbo Petrol 235 HP (*)		Prescribed fuels and original lubricants
	litres	kg	
Fuel tank	60	–	Unleaded petrol not less than 95 RON (EN 228 specification)
including a reserve of	8 - 10	–	
Engine cooling system (with climate control)	6,4	5,7	Mixture of 50% demineralised water and 50% PARAFLU ^{UP} (***)
Engine sump	5,0	4,25	SELENIA SPORT POWER
Engine sump and filter	5,1	4,35	
Automatic transmission casing	2,0	1,7	TUTELA TRANSMISSION GEARFORCE
Hydraulic brake circuit with ABS (Anti-lock braking system)	0,83	0,78	TUTELA TOP 4
Windscreen/rear window/headlight washer fluid reservoir (**)	2,8 (4,6)	2,5 (4,1)	Mixture of water and TUTELA PROFESSIONAL SC 35

(*) For versions/markets, where provided

(**) Values in brackets refer to versions with headlight washers

(***) For particularly harsh climate conditions, a mixture of 60% ^{UP} and 40% demineralised water is recommended.

	1.6 JTD _M		2.0 JTD _M		Recommended fuels and original lubricants
	litres	kg	litres	kg	
Fuel tank	60	–	60	–	Diesel for automotive engines (EN 590 Specification)
including a reserve of	8 - 10	–	8 - 10	–	
Engine cooling system (with climate control)	6,8	6,0	6,7	5,9	50-50 mixture of demineralised water and PARAFLU ^{UP} (**)
Engine sump	4,0	3,4	4,0	3,4	
Engine sump (versions with Alfa TCT)	–	–	4.4	3.6	SELENIA WR FORWARD
Engine sump and filter	4,2	3,5	4,2	3,5	
Engine sump and filter (versions with Alfa TCT)	–	–	4.8	4.0	
Differential/gearbox casing	2.0	1.7	2.0	1.7	TUTELA TRANSMISSION GEARFORCE
Hydraulic brake circuit with ABS antilock brakes	0,83	0,78	0,83	0,78	TUTELA TOP 4
Windscreen/rear window/headlight washer fluid reservoir (*)	2,8 (4,6)	2,5 (4,1)	2,8 (4,6)	2,5 (4,1)	Mixture of water and TUTELA PROFESSIONAL SC 35

(*) Values in brackets refer to versions with headlight washers



(**) For particularly harsh climate conditions, a mixture of 60%^{UP} and 40% demineralised water is recommended.





FLUIDS AND LUBRICANTS

Your car is equipped with an engine oil that has been thoroughly developed and tested in order to meet the requirements of the Scheduled Servicing Plan. Constant use of the prescribed lubricants guarantees the fuel consumption and emission specifications. Lubricant quality is crucial for engine operation and duration.

PRODUCT SPECIFICATIONS

Use	Fluid and lubricant features for a correct use of the car	Genuine fluids and lubricants	Replacement interval
Lubricant for petrol engines (1.4 Turbo Petrol versions)  41)	SAE 5W-40 ACEA C3 grade totally synthetic lubricant FIAT 9.55535-S2 specification	SELENIA StAR P.E. Contractual Technical Reference No. F603.D08	According to the Scheduled Servicing Plan
Lubricant for petrol engines (1.4 Turbo MultiAir versions)  41)	SAE 0W-30 ACEA C2grade totally synthetic lubricant FIAT 9.55535-S2 specification	SELENIA DIGITEK P.E. Contractual Technical Reference No. F020.B12	According to the Scheduled Servicing Plan

Use	Fluid and lubricant features for a correct use of the car	Genuine fluids and lubricants	Replacement interval
Lubricant for petrol engines (for 1750 Turbo petrol versions only)  41)	SAE 5W-40 ACEA C3 grade totally synthetic lubricant FIAT 9.55535-GH2 specification	SELENIA SPORT POWER Contractual Technical Reference No. F052.H12	According to Scheduled Servicing Plan
Lubricant for diesel engines  41)	SAE 0W-30 ACEA C2 grade totally synthetic lubricant FIAT 9.55535-DS1 specification	SELENIA WR FORWARD Contractual Technical Reference No. F842.F13	According to Scheduled Servicing Plan

In case of emergency, if lubricants with the prescribed specifications are not available, products with the minimum indicated ACEA performance can be used for topping up; in this case optimal performance of the engine is not guaranteed.

For MultiAir system engines only use lubricants with **indicated SAE grade** and specifications.



IMPORTANT

41) The use of products with different specifications than those indicated above could cause damage to the engine that is not covered by the warranty.



Use	Fluid and lubricant features for a correct use of the car	Genuine fluids and lubricants	Applications
	SAE 75W grade synthetic lubricant. FIAT 9.55550-MZ6 classification	TUTELA TRANSMISSION GEARFORCE Contractual Technical Reference No. F002.F10	Gearboxes and differentials (mechanical)
Lubricants and greases for drive transmission	Molybdenum disulphide grease, for use at high temperatures. NL.G.I. 1-2 consistency FIAT 9.55580 classification	TUTELA ALL STAR Contractual Technical Reference No. F702.G07	Wheel side constant velocity joints
	Grease for constant velocity joints with low friction coefficient. NL.G.I. 0-1 consistency FIAT 9.55580 classification	TUTELA STAR 700 Contractual Technical Reference No. F701.C07	Differential-side constant velocity joints
Lubricant for electro-hydraulic actuator (versions with Alfa TCT)	Fully synthetic oil with dedicated additive FIAT 9.55550-SA1 classification	TUTELA CS SPEED Contractual Technical Reference No. F005.F98	Lubricant for electro-hydraulic actuator
Brake fluid	Synthetic fluid for brake and clutch systems. Exceeds specifications: FMVSS no. 116 DOT 4, ISO 4925, SAE J1704. FIAT 9.55597 classification	TUTELA TOP 4 Contractual Technical Reference No. F001.A93	Hydraulic brakes and hydraulic clutch controls

Use	Fluid and lubricant features for a correct use of the car	Genuine fluids and lubricants	Applications
Protective agent for radiators	Red protective agent with antifreeze action, based on inhibited monoethylene glycol with organic formula. Exceeds the CUNA NC 956-16, ASTM D 3306 specifications. FIAT 9.55523 classification	PARAFLU^{UP} (*) Contractual Technical Reference No. F101.M01	Usage percentage: 50% demineralised water 50% PARAFLU^{UP} (**)
Diesel fuel additive	Antifreeze additive for diesel, with protective action for diesel engines.	TUTELA DIESEL ART Contractual Technical Reference No. F601.L06	To be mixed with diesel (25 cc per 10 litres)
Windscreen/rear window/headlight washer fluid	Mixture of alcohol, water and surfactants CUNA NC 956-11 FIAT 9.55522 classification	TUTELA PROFESSIONAL SC 35 Contractual Technical Reference No. F201.D02	To be used diluted or undiluted in screen washer/wiper systems

(*)IMPORTANT Do not top up or mix with other fluids which have different specifications from those described.

(**)When the vehicle is used in particularly harsh weather conditions, we recommend using a mixture of 60% **PARAFLU^{UP}** and 40% demineralised water.



FUEL CONSUMPTION

The fuel consumption figures given in the tables below are determined on the basis of the type-approval tests laid down by specific European Directives.

The procedures below are followed for measuring consumption:

- urban cycle: cold starting followed by driving that simulates urban use of the car;
- extra-urban cycle: frequent accelerating in all gears, simulating extra-urban use of the car: speed varies between 0 and 120 km/h;
- combined fuel consumption: calculated with a weighting of approximately 37% of the urban cycle and 63% of the extra-urban cycle.

IMPORTANT The type of route, traffic conditions, weather conditions, driving style, general condition of the car, trim level/equipment/accessories, use of the climate control, car load, presence of roof racks and other situations that adversely affect the aerodynamics or wind resistance lead to different fuel consumption figures than those measured.

FUEL CONSUMPTION ACCORDING TO THE CURRENT EUROPEAN DIRECTIVE (litres/100 km)

Versions	Urban	Extra-urban	Combined
1.4 Turbo Petrol	8,3	5,3	6,4
1.4 Turbo MultiAir	7,6	4,6	5,7
1.4 Turbo MultiAir 163/170 HP TCT	6,6	4,3	5,1
1.4 Turbo MultiAir 170 HP TCT (*)	6,4	4,2	5,0
1750 Turbo Petrol 235 HP (*)	10,8	5,8	7,6
1.6 JTD_M 105 HP	5,0	3,4	4,0
2.0 JTD_M 136/150 HP	5,0	3,7	4,2
2.0 JTD_M 163 HP TCT (*)	5,2	3,9	4,4
2.0 JTD_M 175 HP TCT	5,2	3,9	4,4

(*) For versions/markets, where provided



CO₂ EMISSIONS

The CO₂ emission levels given in the following tables refer to combined consumption.

Versions	CO ₂ emissions according to the current European directive (g/km)
1.4 Turbo Petrol	148
1.4 Turbo MultiAir 163/170 HP	131
1.4 Turbo MultiAir 170 HP TCT	119
1.4 Turbo MultiAir 163 HP TCT (*)	119
1.4 Turbo MultiAir 170 HP TCT (*)	117
1750 Turbo Petrol 235 HP (*)	177
1.6 JTD_M 105 HP	104
2.0 JTD_M 136/150 HP	110
2.0 JTD_M 175 HP TCT	116
2.0 JTD_M 163 HP TCT (*)	116

(*) For versions/markets, where provided

PRESCRIPTIONS FOR HANDLING THE VEHICLE AT THE END OF ITS LIFE

FCA has been committed for many years to safeguarding the environment through the constant improvement of its production processes and manufacturing products that are increasingly "eco-compatible". To grant customers the best possible service in terms of respecting environmental laws and in response to European Directive 2000/53/EC governing vehicles at the end of their life, FCA is offering its customers the chance to hand over their vehicle at the end of its life without incurring any additional costs. The European Directive sets out that when the vehicle is handed over, the last keeper or owner should not incur any expenses as a result of it having a zero or negative market value.

To hand your vehicle over at the end of its life without extra cost, contact one of our dealerships if you are purchasing another vehicle or an FCA-authorized collection and scrapping centre. These centres have been carefully chosen to offer high quality service for the collection, treatment and recycling of vehicles at their end of life, respecting the surrounding environment. You can find further information on these collection and scrapping centres either from an FCA dealership or by calling the number in the Warranty Booklet or by consulting the websites of the various FCA brands.



WHAT TO DO IF

Fault	Possible solution	
... A TYRE IS PUNCTURED.	Use the Fix&Go Automatic tyre repair kit.	See page 170.
... A TYRE DEFLATES.	Restore the correct pressure.	See page 236.
... THE BATTERY IS FLAT.	–	See page 211 or contact an Alfa Romeo Dealership.
... THE INTERNAL ROOF LIGHTS DO NOT COME ON.	Replace the bulb.	See page 180 or contact an Alfa Romeo Dealership.
... AN EXTERNAL BULB (main beam, dipped beam headlights...) DOES NOT COME ON.	Check the relevant protection fuse.	See page 181 or contact an Alfa Romeo Dealership.
	Replace the bulb.	See page 177 or contact an Alfa Romeo Dealership.
... THE REMOTE CONTROL DOES NOT WORK.	Replace the batteries inside the remote control.	See page 12.
... THE KEY WITH REMOTE CONTROL HAS BEEN LOST.	Request an additional remote control.	See page 12
... AN ELECTRIC WINDOW DOES NOT WORK	Check the relevant protection fuse.	See page 181 or contact an Alfa Romeo Dealership.
	Have the relevant window raising / lowering motor checked	Contact an Alfa Romeo Dealership.
... AN INSTRUMENT PANEL WARNING LIGHT SWITCHES ON.	–	See page 99.
... THE ENGINE DOES NOT START, THE STARTER DOES NOT TURN	The battery is flat; it needs replacing.	See page 211.

Fault	Possible solution	
... THE ENGINE DOES NOT START OR STOPS WHEN DRIVING.	Check that there is sufficient fuel in the tank.	See page 245.
... THE ENGINE DOES NOT START FOLLOWING AN IMPACT.	Check whether the fuel cut-off system has intervened.	See page 45.
... ENGINE COOLANT TEMPERATURE TOO HIGH INDICATION.	Check the engine coolant level.	See page 209, contact an Alfa Romeo Dealership.
... EXCESSIVE BRAKE PAD WEAR INDICATION.	Replace the worn brake pads.	Contact an Alfa Romeo Dealership.
... IT IS NOT POSSIBLE TO ENGAGE THE GEARS.	Have the gearbox/transmission checked.	Contact a dedicated Alfa Romeo Dealership.
... LOSS OF ENGINE PERFORMANCE, POOR DRIVEABILITY, HIGH EXHAUST EMISSIONS AND CONSUMPTION.	Have the EOBD/injection system checked.	See page 74, contact an Alfa Romeo Dealership.
... THE ABS DOES NOT WORK.	Have the ABS checked.	See page 63, contact an Alfa Romeo Dealership.

This page is intentionally left blank

DASHBOARD

The presence and position of controls, instruments and gauges may vary according to different versions.



A0K0730

1. Adjustable air vent 2. Passenger front air bag 3. Control buttons 4. Windscreen wiper/rearscreen wiper/trip computer control lever 5. Instrument panel 6. Exterior lighting control lever 7. Driver front air bag 8. Cruise Control (for versions/markets, where provided) 9. Uconnect Radio/Uconnect Radio Nav (for versions/markets, where provided) 10. Heating/ventilation/climate control system controls 11. Glove compartment

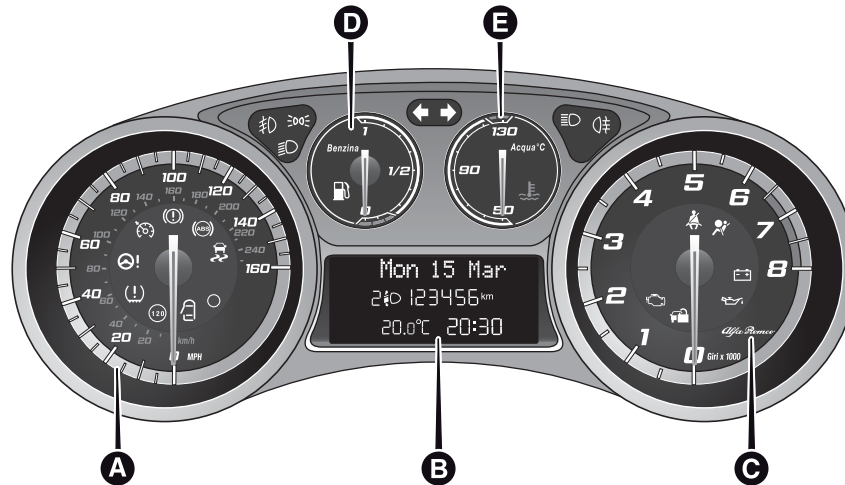
CONTROL PANEL AND INSTRUMENTS**VERSIONS WITH MULTIFUNCTIONAL DISPLAY**

2

A0K2302

A. Speedometer (speed indicator) B. Multifunctional display C. Rev counter D. Fuel level gauge with reserve warning light
E. Engine coolant temperature gauge and excessive temperature warning light

 warning lights supplied in diesel versions only. On diesel versions the rpm gauge end of scale is set at 6000 rpm.

WARNING Instrument background colour and type may vary according to the version.

VERSIONS WITH RECONFIGURABLE MULTIFUNCTIONAL DISPLAY

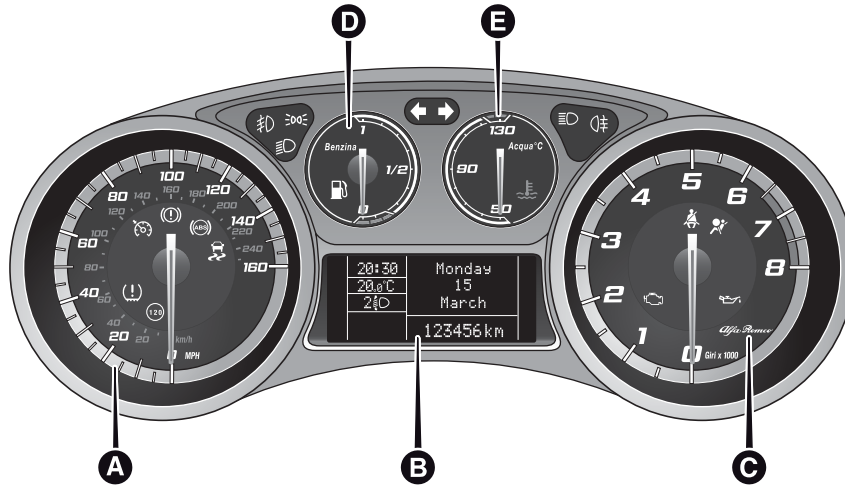

3

A0K2303

A. Speedometer (speed indicator) – B. Reconfigurable multifunctional display – C. Rev counter – D. Fuel level gauge with reserve warning light – E. Engine coolant temperature gauge and excessive temperature warning light

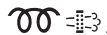
 warning lights supplied in diesel versions only. On diesel versions the rpm gauge end of scale is set at 6000 rpm.
WARNING Instrument background colour and type may vary according to the version.

CHANGING A FUSE

FUSEBOX ON DASHBOARD

Insert a hand in the seat A fig. 4 and lower the flap B to access the fuses.

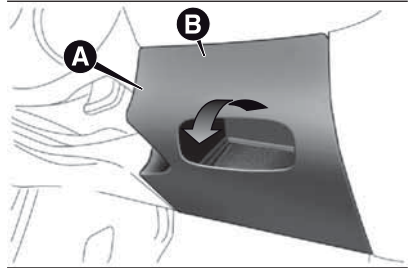

4

A0K0731

The fuses are located in the fusebox shown in fig. 5.

Note For fuse protected devices refer to the description of “In an emergency” chapter.

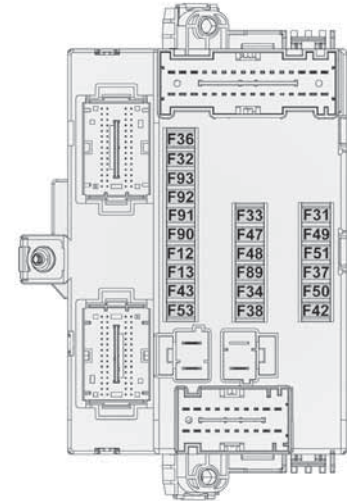

5

A0K0249

PETRONAS
SELENIA
MOTOR OIL

In the heart of your engine.



Always ask your mechanic for **PETRONAS**
SELENIA
MOTOR OIL

Oil change? The experts recommend Petronas Selenia

*The engine of your car is factory filled with **Petronas Selenia**. This is an engine oil range which satisfies the most advanced international specifications. Its superior technical characteristics allow **Petronas Selenia** to guarantee the **highest performance and protection of your engine**.*

The Petronas Selenia range includes a number of technologically advanced products:

SELENIA STAR PURE ENERGY

Fully synthetic lubricant capable of meeting the needs of high performance engines. Studied to protect the engine also in high thermal stress conditions, it prevents deposits on the turbine to achieve the utmost performance in total safety.

SELENIA WR PURE ENERGY

Fully synthetic lubricant that can meet the requirements of the latest diesel engines. Low ash content to protect the particulate filter from the residual products of combustion. High Fuel Economy System that allows considerable fuel saving. It reduces the danger of dirtying the turbine to ensure the protection of increasingly high performance diesel engines.

SELENIA MULTIPower GAS PURE ENERGY

Fully-synthetic lubricant designed for petrol engines also turbocharged, powered with methane or LPG. Its exclusive formulation improves valve protection against wear, neutralises the acid compounds formed by combustion and keeps engine performance levels unchanged.

SELENIA SPORT POWER

Fully synthetic lubricant capable of meeting the needs of high performance engines. Studied to protect the engine also in high thermal stress conditions, it prevents deposits on the turbine to achieve the utmost performance in total safety.

The range also includes Petronas Selenia si completa con Selenia StAR, Selenia 20K AR, Selenia Turbo Diesel, Selenia Sport Selenia Racing.

For further information on Petronas Selenia products visit the web site www.pli-petronas.eu

INDEX

ABS	62	Brakes	233	– Upper air diffusers	22
Additional heater	35	– brake fluid level.....	209	Climatic comfort.....	23
AFS adaptive lights (Adaptive Frontlight System)	38	bulb replacement	178	– Diffusers	23
Air cleaner.....	210	Bulb replacement		Clutch	232
Alarm	14	– exterior lights.....	177	CO2 emissions.....	254
“Alfa DNA” system	66	– interior lights.....	180	CODE Card.....	11
– Driving modes	66	Bulbs		Control buttons.....	85
– "Natural" Mode.....	67	– types of bulbs	175	Control panel and instruments	94
Alfa Romeo Code system	10	C arrying children safely	133	– Multifunction display.....	94
ALFA TCT	151	CBC (Cornering Brake Control) system	63	– Reconfigurable multifunction display.....	95
Ashtray	48	Central locking	45	Controls	44
ASR system (Anti-Slip Regulation).....	63	Changing a bulb.....	173	Courtesy light	
Automatic dual zone climate control	28	– General instructions.....	173	– bulb replacement	181
B attery.....	211	Changing a wheel	165	Cruise Control.....	40
– advice for extending lifetime	211	Checking levels	205	D aytime running lights (DRL)	35
– replacement	211	Cigar lighter.....	48	Diesel filter	210
Battery (recharging).....	191	Cleaning and maintenance		Dimensions	240
Bodywork		– bodywork.....	216	Dipped beam headlights	
– maintenance	216	– car interior.....	218	– bulb replacement	177
– protection against atmospheric agents.....	216	– front headlights	217	Direction indicators.....	37-178
– warranty	216	– leather parts	218	– bulb replacement	178
Bonnet.....	59	– leather seats.....	218	– “Lane change” function	37
– Closing.....	59	– plastic and coated parts.....	218	Display	84
– Opening	59	– seats and fabric parts.....	218	Doors.....	51
		Climate control.....	22	– Child safety device	52
		– Central air diffusers.....	22	– Door central locking/unlocking	51
		– Rear air diffuser	22	DPF (particulate filter)	81
		– Side air diffusers.....	22		

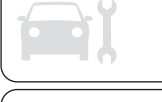

DST system (Dynamic Steering Torque).....	64	Fix&Go Automatic kit.....	170	– Light beam direction.....	61
Dual Pinion active steering	74	Flashing	37	Headlight washers	215
Dusk sensor.....	36	Fluids and lubricants	248	Head restraints.....	18
E BD system.....	62	Fog lights	44-178	– "Anti-Whiplash" device	19
Electric sun roof	49	"Follow Me Home" device	37	– Front headrests	18
Electric windows	53	F ront airbags.....	140	– Rear head restraints	19
– Controls	53	Front armrest	46	Hill Holder system	63
"Electronic Q2" system ("E-Q2")....	64	Front driver side airbag.....	140	I dentification data	
E ngine codes - bodywork versions	223	Front passenger airbag	140	– bodywork paint plate.....	222
Engine compartment		Front roof light		– Chassis marking.....	222
– washing	217	– bulb replacement	180	– engine marking.....	222
Engine coolant temperature indicator.....	96	Fuel consumption	252	– identification data plate.....	222
Engine.....	226	Fuel cut-off system.....	45	Ignition device.....	15
– engine cooling system fluid level.....	209	Fuel level gauge	96	– Steering lock	16
– marking.....	222	Fuel supply.....	231	Installing a Universal Isofix child seat.....	137
Engine oil		Fuel tank cap	80	Installing electrical/electronic devices	76
– consumption	208	Fuses (if a fuse blows).....	181	Interior fittings	46
– level check	208	G ear Shift Indicator	85	Interiors (cleaning)	218
EOBD system	74	Glove compartment courtesy light		iTPMS system.....	72
ESC (Electronic Stability Control) system.....	62	– bulb replacement	181	J ack.....	165
External courtesy lights	38	H andbrake.....	149	L ight clusters	
External lights.....	35	Hazard warning lights.....	44	– front light clusters (changing a bulb).....	177
Extinguisher	49	HBA system.....	64	– rear light clusters (changing a bulb).....	178
F illing the tank.....	80	Headlights.....	61	Luggage compartment courtesy light	
Fitting "Universal" child seat	134	– Adjusting headlights abroad	61	– bulb replacement	180
		– bulb replacement	177		
		– Headlight alignment corrector....	61		

Luggage compartment.....	56	Performance	241	Refuelling the car	80
– Bag hooks.....	58	Pollen filter	210	Rev counter	96
– Closing the luggage compartment	56	Power sockets	47	Rim Protector (tyres).....	237
– Emergency luggage compartment opening	56	Pre-Fill system (RAB - Ready Alert Brake)	64	Roof lights.....	42
– Extending the luggage compartment	57	Preparation for "Isofix" child seat	137	– Courtesy lights	43
– Luggage compartment initialisation.....	56	Pretensioners	131	– Front roof light.....	42
– Luggage retaining net.....	58	– Load limiters.....	131	– Glove compartment light	43
– Opening the luggage compartment	56	Protecting the environment	81	– Luggage compartment roof light.....	43
– Securing your load	58	R adio transmitters and mobile phones	76	– Rear roof light.....	43
M ain beam headlights	37	Rain sensor.....	39	Roof rack/ski rack	60
– bulb replacement	177	Raising the car	192	S afe Lock (device).....	13
Maintenance and care		Rear armrest	47	Saving fuel	158
– heavy-duty use of the car	204	Rear fog lights.....	44	SBR system (Seat Belt Reminder)	129
– periodic checks.....	204	Rear fog lights/reversing lights.....	178	Scheduled servicing.....	196
Manual climate control	24	Rear roof light		Scheduled Servicing Plan.....	197
Menu options.....	87	– bulb replacement	180	Seat belts.....	128
Money holder	48	Rear view mirrors	20	– Use	128
MSR system	64	– Door mirrors.....	21	Seats	16
Multifunction display.....	84	– Internal mirror.....	20	– Front seats	16
N umber plate lights		Rear window washer jets	215	Setup menu	86
– bulb replacement	179	Rear window washer		Side airbags (Side Bags - Window Bags).....	144
P arking	149	– rear window washer fluid level ...	209	Side bags (front side airbags)	144
– Handbrake	149	Rear window washer/wiper	40	Side lights/brake lights	178
Parking lights	36	Rear window wiper		Side lights/daytime running lights (DRL)	
Parking sensors	77	– blade replacement.....	214	– bulb replacement	177
		Reconfigurable multifunction display	84	Side lights/dipped beam headlights	36
		Refuelling	245		

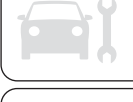

Ski compartment	47	– Installing a tow hook.....	160	– windscreen washer fluid level	209
“Smart Bag” system (Multistage front airbags).....	140	Transmission	232	Windscreen washer nozzles	214
S now chains	161	TRIP button.....	98	Windscreen washer/wiper	38
Snow tyres.....	160	Trip Computer.....	96	– “Smart washing” function	39
Speedometer (speed indicator)	96	Tyres		Windscreen wiper	
Starting the engine.....	148	– correct tyre reading	236	– replacing wiper blades.....	213
Starting the engine.....	164	– Fix&Go Automatic (kit)	170	Wiring for radio system	75
– Bump starting	164	– inflation pressure	239		
– Jump starting	164	U sing the Gearbox.....	150		
Start&Stop system.....	69	W arning lights and messages.....	99		
Steering lock.....	16	Weights.....	242		
Steering system	235	Welcome movement	85		
Steering wheel	19	Wheel rims			
Storage compartments	46	– correct reading of the rim code	236		
Storing the car	162	Wheels and tyres	212		
Sun visors	48	– changing a wheel	165		
Suspension.....	234	– spare wheel.....	236		
Symbols.....	10	– tyre inflation pressure.....	239		
T echnical specifications	222	Wheels and tyres provided.....	238		
The keys	11	Wheels.....	236		
– CODE Card	11	– rims and tyres	236		
– Key without remote control.....	11	Window bags (side airbags for head protection).....	144		
– Key with remote control.....	11	Window cleaning.....	38		
Third brake lights		Windows (cleaning)	217		
– bulb replacement	179	Windscreen/rear window wiper			
Towing the car	192	– blades.....	213		
– Attaching the tow hook	192	Windscreen washer			
Towing trailers.....	160				



SERVICE

MOPAR

TECHNICAL SERVICES – SERVICE ENGINEERING

FCA Italy S.p.A. - Largo Senatore G. Agnelli, 3 - 10040 Volvera - Torino (Italia)

Publication no. 60438735 – 4 Edition – 09/2015

All rights reserved. Reproduction, even in part is prohibited without written permission from FCA Italy S.p.A.

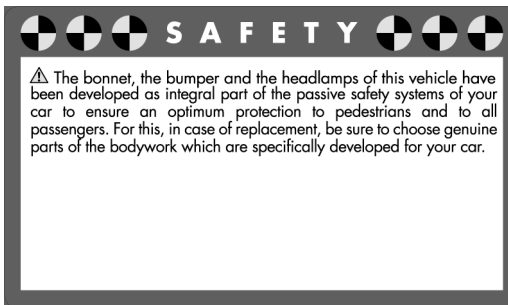

S A F E T Y

 The bonnet, the bumper and the headlamps of this vehicle have been developed as integral part of the passive safety systems of your car to ensure an optimum protection to pedestrians and to all passengers. For this, in case of replacement, be sure to choose genuine parts of the bodywork which are specifically developed for your car.

ENGLISH

Alfa Services

