



**MITSUBISHI
MOTORS**

ECLIPSE CROSS

2023 / Owner's Manual

Introduction

N09200102589

Thank you for buying a MITSUBISHI ECLIPSE CROSS.

We are confident you will enjoy your vehicle. It has been engineered for optimum performance, durability and comfort. By thoroughly reading this Owner's Manual, you will gain an understanding of the many features that are included in the ECLIPSE CROSS. The Owner's Manual contains descriptions and illustrations that will assist in the operation and maintenance of your vehicle.

Your Authorized Mitsubishi Motors Dealer will be happy to assist you with any further questions you may have regarding the operation of your vehicle.

Please note that this manual applies to all ECLIPSE CROSS models and explains all features including options. Some features explained in this manual may not be installed on your vehicle.

Please leave this Owner's Manual in the vehicle at the time of resale. The next owner will appreciate having access to the information contained here.

This manual includes instructions for standard and optional equipment available at the time of printing. Mitsubishi Motors Corporation reserves the right to make changes in design and specifications and to make additions or improvements in its product without assuming any obligation to install these on previously manufactured products.



Throughout this manual the words **WARNING** and **CAUTION** appear.

These are reminders to be especially careful. Failure to follow the instructions could result in personal injury or damage to your vehicle.

WARNING

Indicates a strong possibility of severe personal injury or death if instructions are not followed.

CAUTION

Points out hazards or unsafe practices that could cause minor personal injury or damage to your vehicle.

You will see another important symbol:

NOTE

Gives helpful information.

As with other vehicles of this type, failure to operate this vehicle correctly may result in loss of control or an accident. Be sure to read "on-pavement" and "off-road" driving guidelines in the "Driving safety" and "Features and controls" sections.

California Proposition 65 Warning

WARNING

- **Operating, servicing and maintaining a passenger vehicle or off-highway motor vehicle can expose you to chemicals including engine exhaust, carbon monoxide, phthalates, and lead, which are known to the State of California to cause cancer and birth defects or other reproductive harm. To minimize exposure, avoid breathing exhaust, do not idle the engine except as necessary, service your vehicle in a well-ventilated area and wear gloves or wash your hands frequently when servicing your vehicle.
For more information go to www.P65Warnings.ca.gov/passenger-vehicle.**

Table of contents

Overview	1
Quick index	2
General information	3
Seat and restraint systems	4
Features and controls	5
Driving safety	6
Comfort controls	7
For emergencies	8
Vehicle care and maintenance	9
Customer assistance/Reporting Safety Defects	10
Specifications	11
Alphabetical index	12

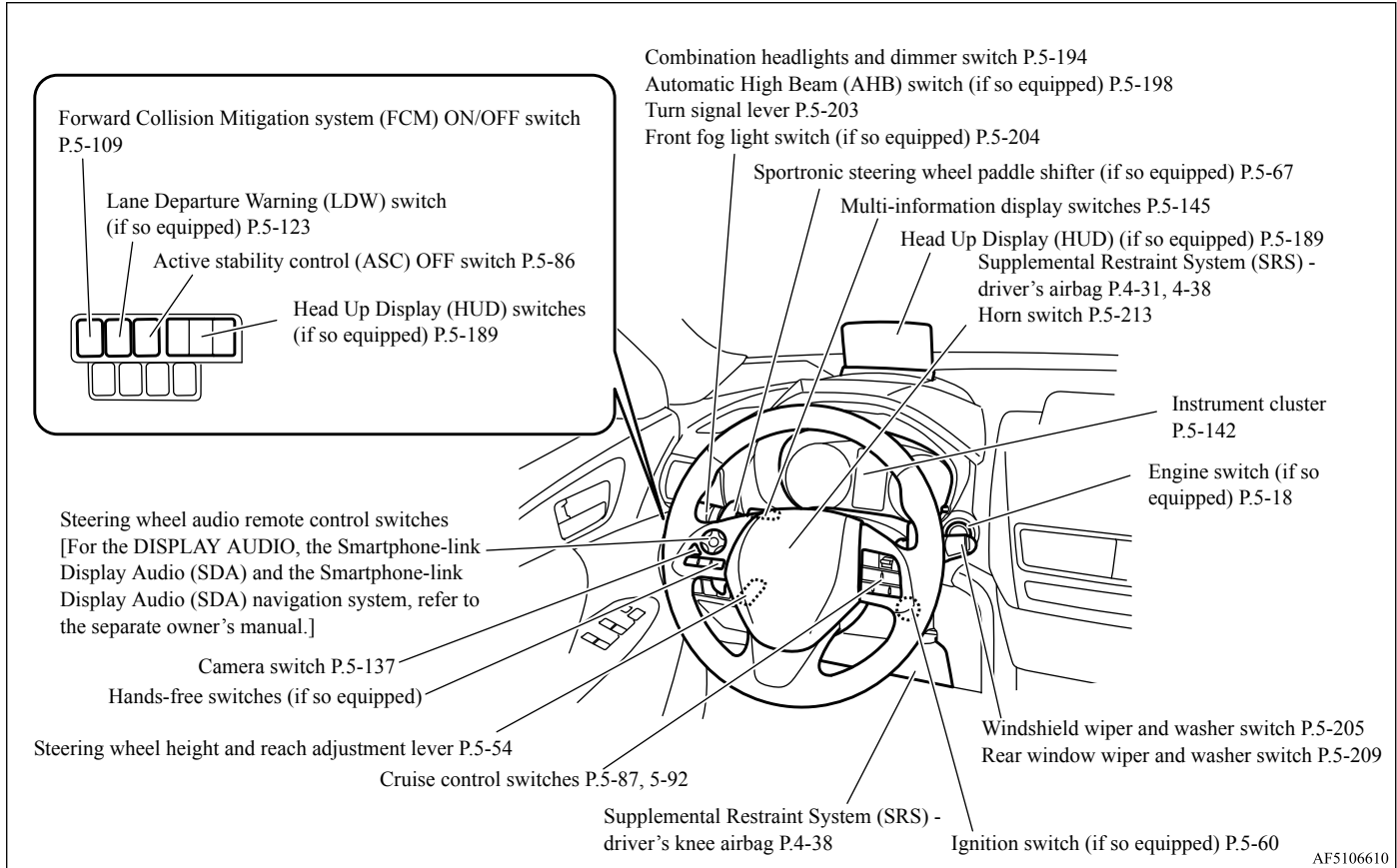

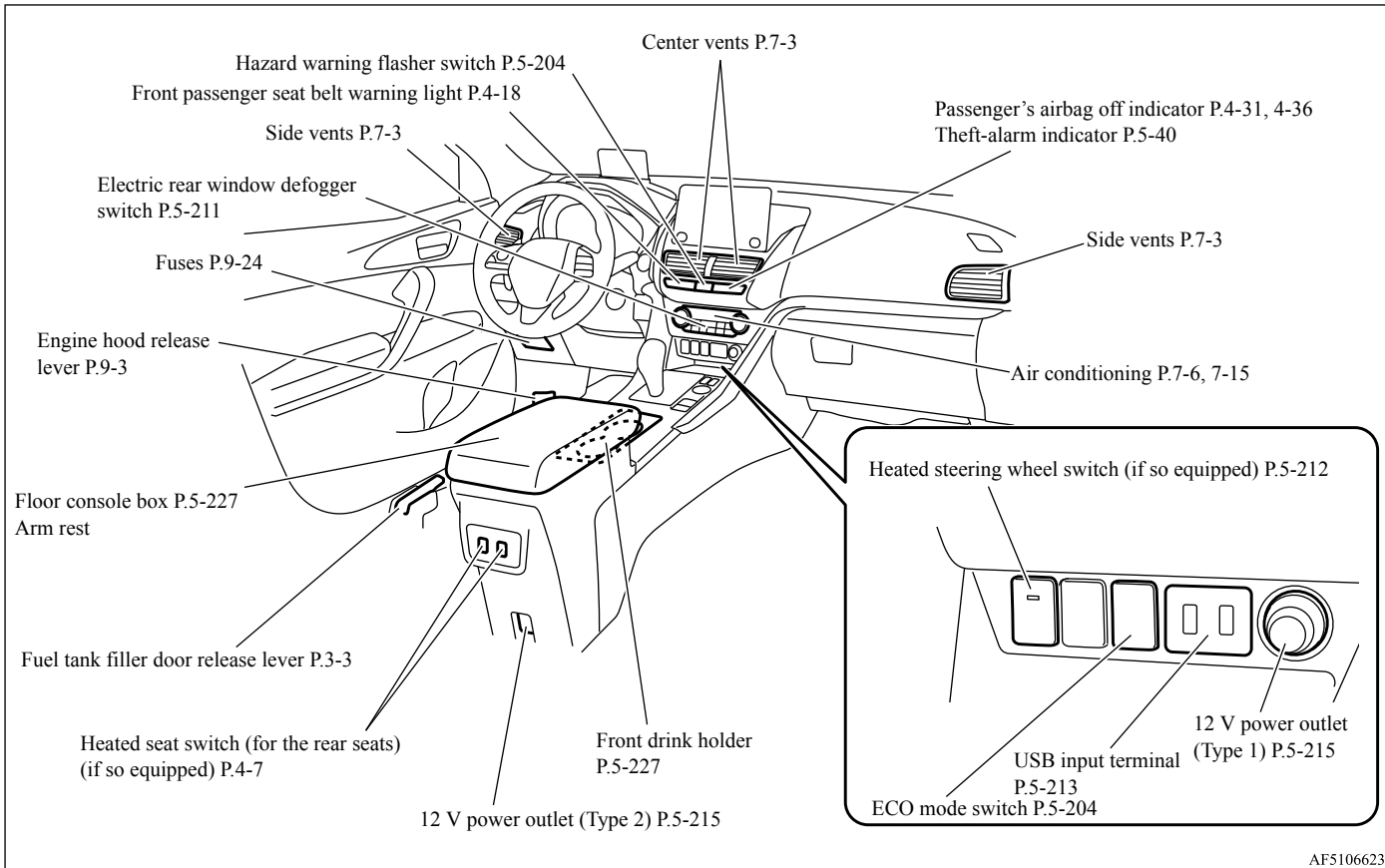

AF5106623

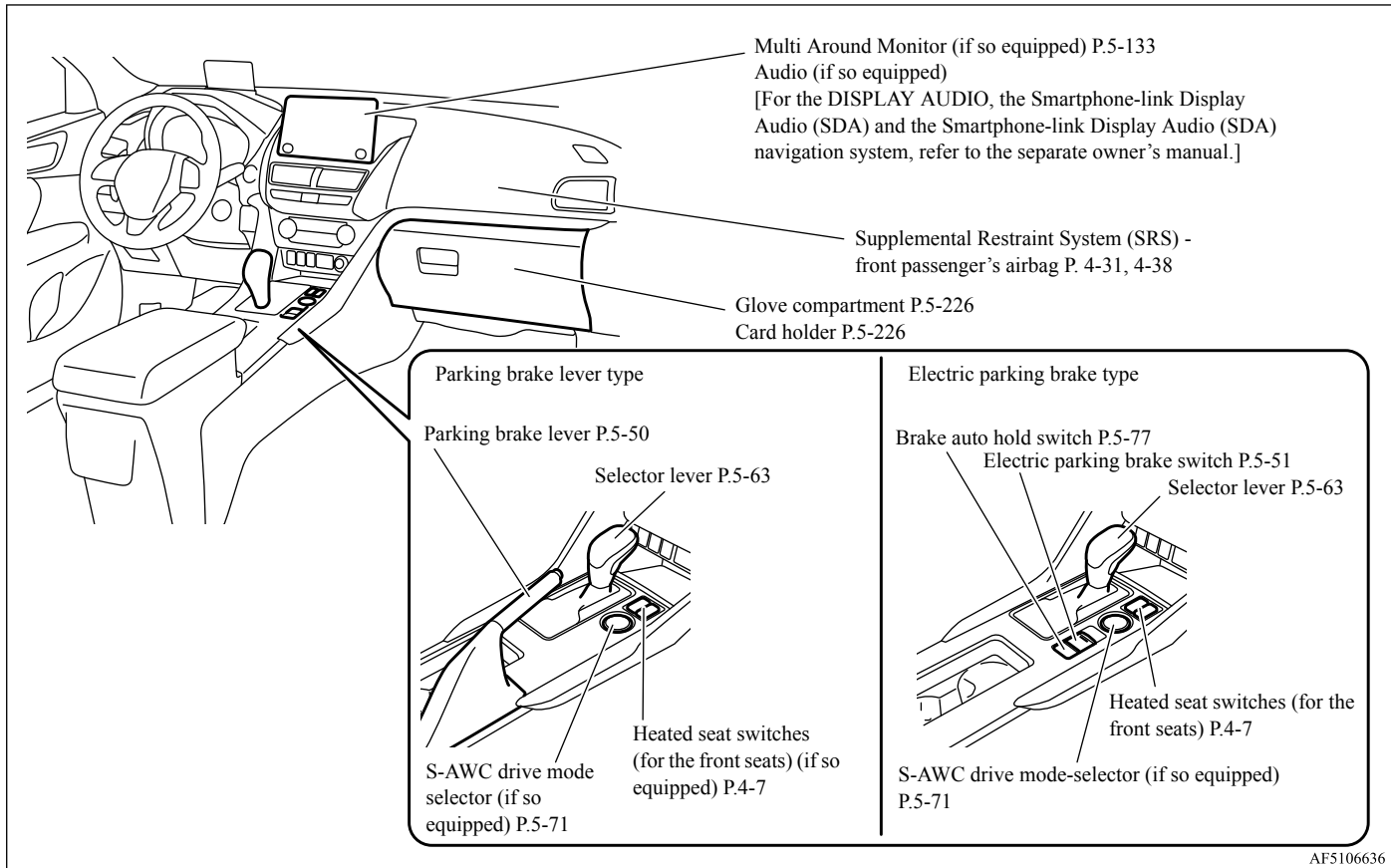

Interior

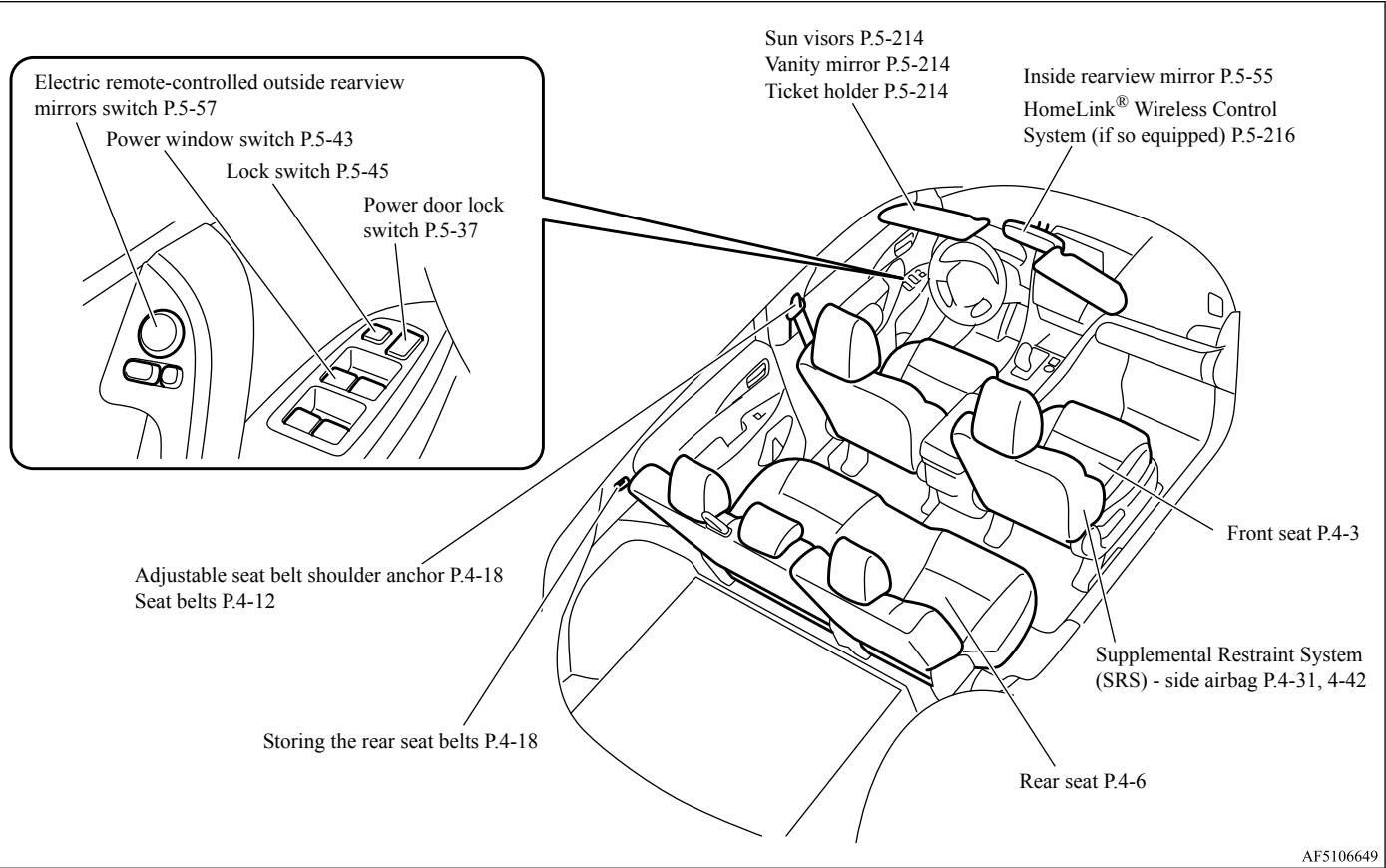

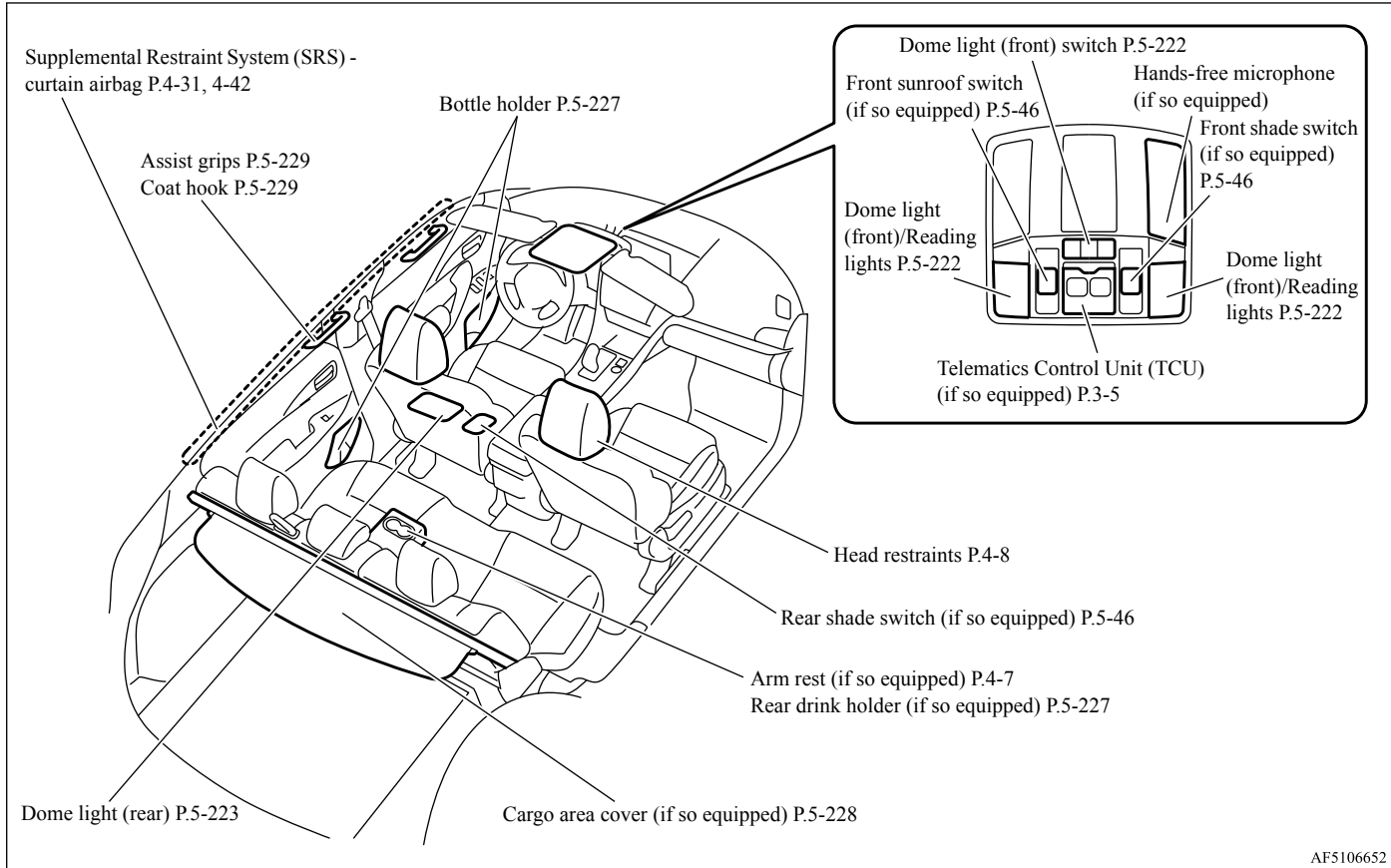

AF5106652

Luggage area

N00100501667

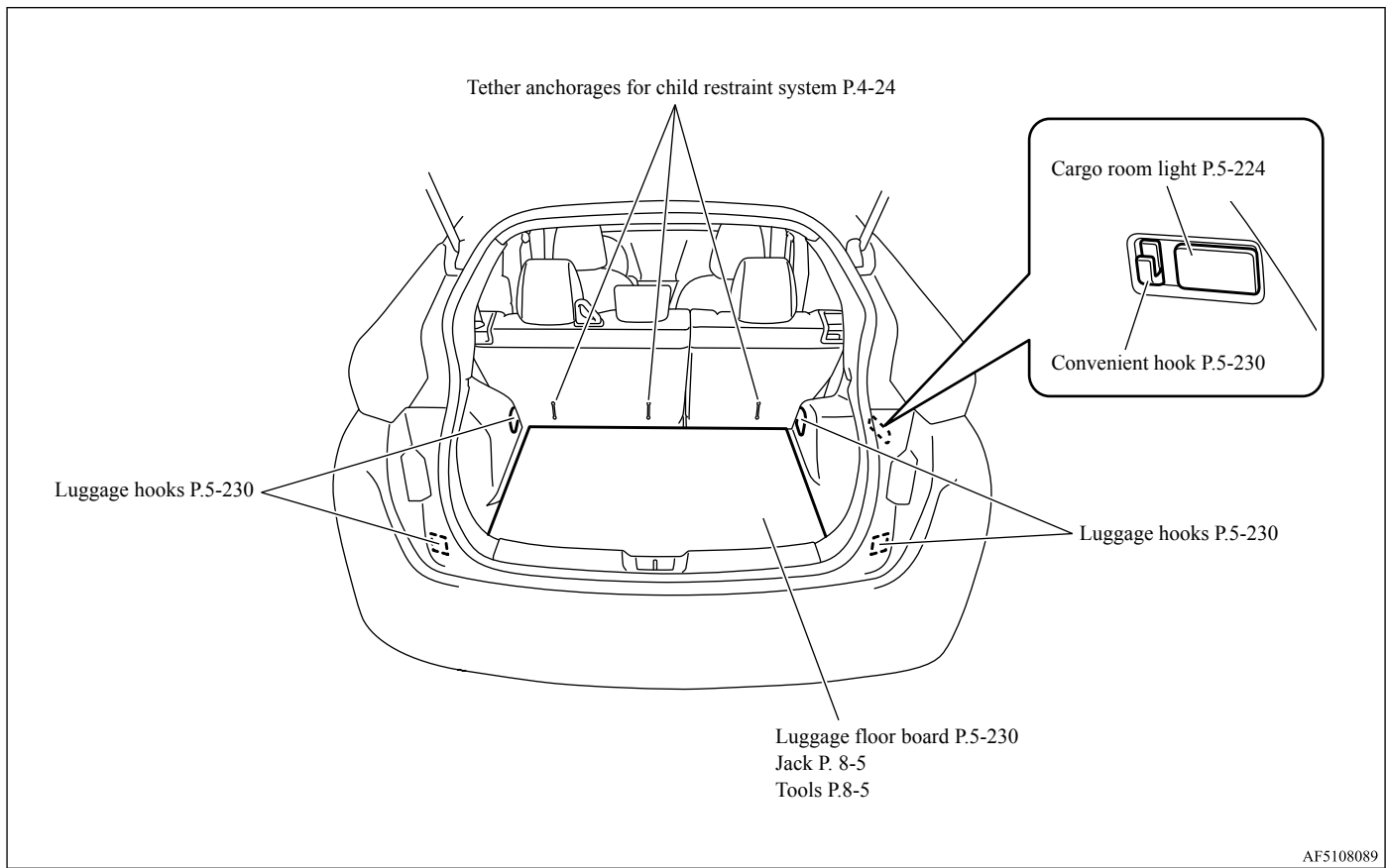

AF5108089

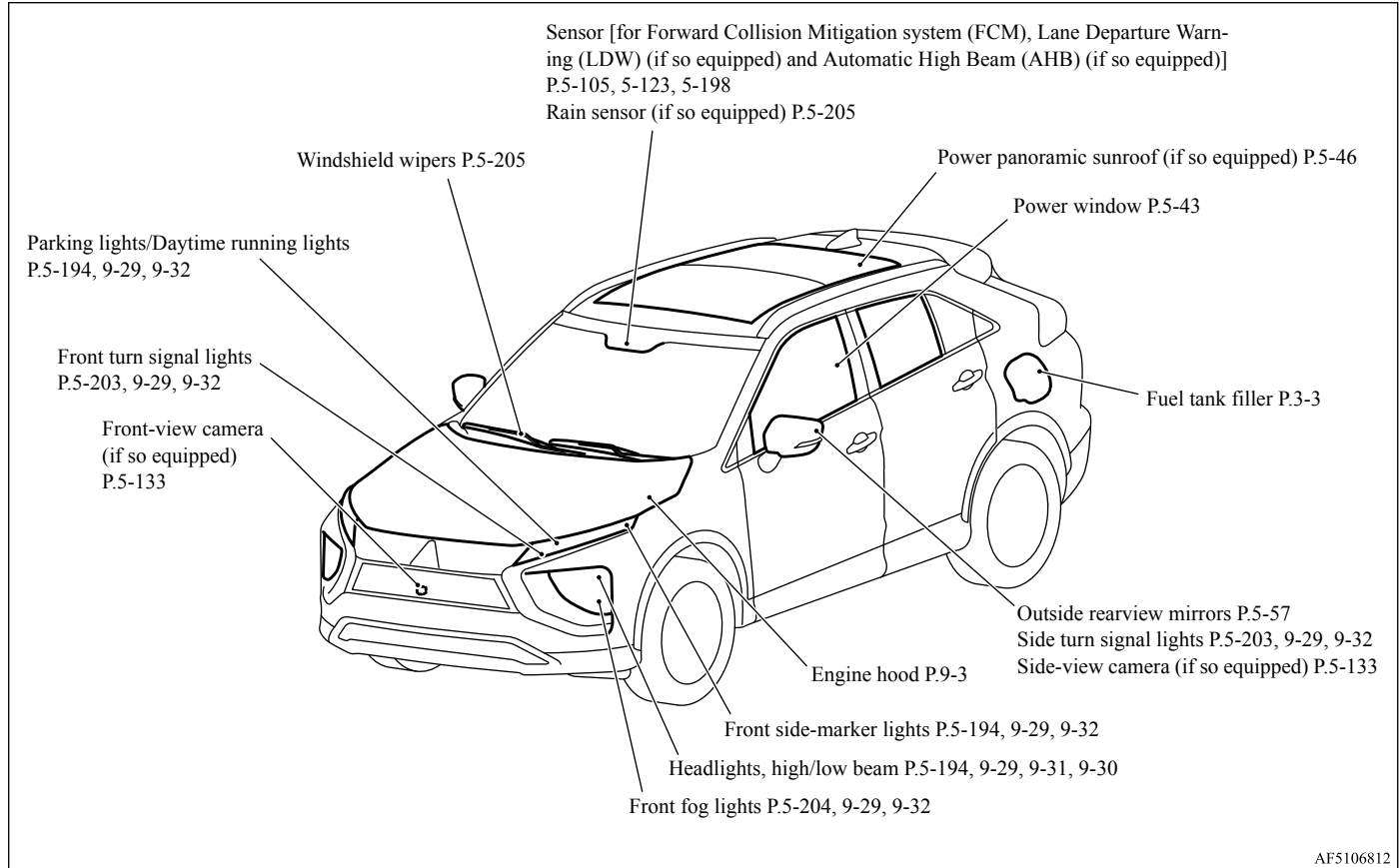

Outside (Rear)

N00100603011

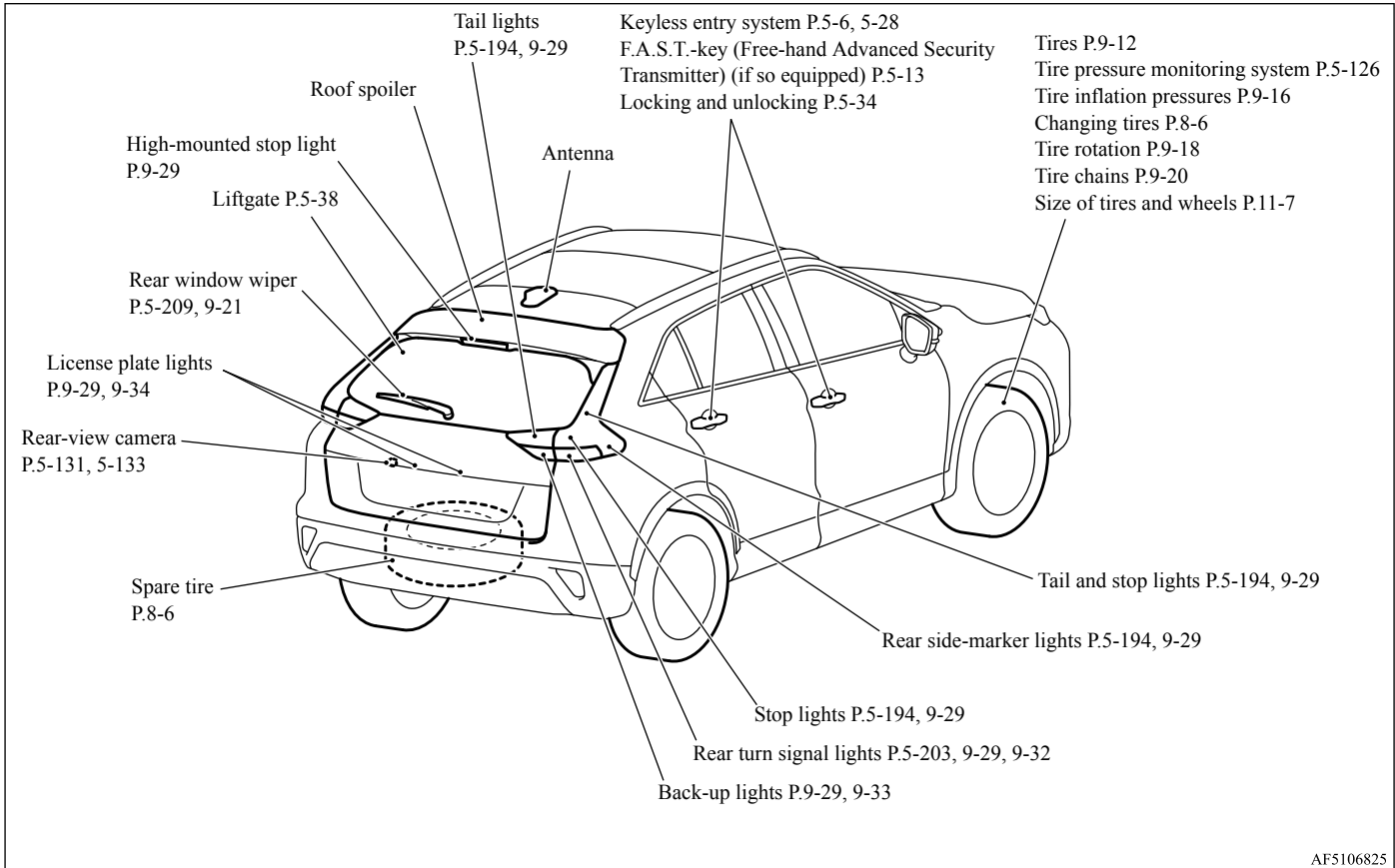



AF5106825



If this warning light comes on or flashes while you're driving...



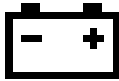

N00200702478



<p> NOTE</p> <ul style="list-style-type: none"> ● For information regarding warning displays in the multi-information display, refer to “Multi-information display” on page 5-144. ● These warning lights will come on for a few seconds for a bulb check when the ignition switch is first turned to “ON” or the operation mode is put in ON.
--

Warning lights	Do this	Ref. Page
<p style="text-align: center;"></p> <p style="text-align: center;">Charging system warning light</p>	<ul style="list-style-type: none"> ● Park your vehicle in a safe place and stop the engine. Contact your Mitsubishi Motors dealer or a repair facility of your choice for assistance immediately. 	<p style="text-align: center;">P. 5-188</p>
<p style="text-align: center;">BRAKE or </p> <p style="text-align: center;">Brake warning light</p>	<ul style="list-style-type: none"> ● If this light comes on while driving, check to see that the parking brake is fully released. ● If this light stays on after releasing the parking brake, immediately stop and check the brake fluid level. ● If the brake fluid level is correct, there may be a system malfunction. Avoid hard braking and high speed, and contact an authorized Mitsubishi Motors dealer or a repair facility of your choice for assistance. 	<p style="text-align: center;">P. 5-186</p>
<p style="text-align: center;"></p> <p style="text-align: center;">Electric parking brake warning light (if so equipped)</p>	<ul style="list-style-type: none"> ● If the warning light comes on during driving, there is the possibility that the parking brake cannot be operated or released. Immediately stop the vehicle in a safe place, and contact an authorized Mitsubishi Motors dealer or a repair facility of your choice for assistance. 	<p style="text-align: center;">P. 5-186</p>

If this warning light comes on or flashes while you're driving...

2

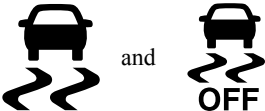
Warning lights	Do this	Ref. Page
<p>SERVICE ENGINE SOON or </p> <p>Engine malfunction indicator (“SERVICE ENGINE SOON” or “Check engine light”)</p>	<ul style="list-style-type: none"> ● Although your vehicle will usually be drivable and not need towing, have the engine system checked at an authorized Mitsubishi Motors dealer or a repair facility of your choice immediately. If the vehicle is not drivable, contact emergency roadside assistance at 1-888-648-7820 (for vehicles sold in U.S.A.) or 1-888-576-4878 (for vehicles sold in Canada), an authorized Mitsubishi Motors dealer, or local towing company for assistance. 	<p>P. 5-187</p>
<p></p> <p>Electric power steering system (EPS) warning light</p>	<ul style="list-style-type: none"> ● If this light comes on while the engine is running, it may become harder to turn the steering wheel. Have your vehicle inspected at an authorized Mitsubishi Motors dealer or a repair facility of your choice as soon as possible. 	<p>P. 5-84</p>
<p></p> <p>Anti-lock braking system warning light</p>	<ul style="list-style-type: none"> ● When this light comes on, the anti-lock braking system is not functioning and only the ordinary braking system is functioning. ● Park your vehicle in a safe place and stop the engine. Test the system as described on page 5-82. ● If the light does not go out after the test, or if it comes on again, we recommend that you have the system checked at an authorized Mitsubishi Motors dealer or a repair facility of your choice as soon as possible. 	<p>P. 5-82</p>
<p></p> <p>SRS warning light</p>	<ul style="list-style-type: none"> ● Immediately have the airbag and the pre-tensioner seat belt system checked at an authorized Mitsubishi Motors dealer. 	<p>P. 4-37</p>

Warning lights	Do this	Ref. Page
 <p>ASC indicator and ASC OFF indicator</p>	<ul style="list-style-type: none"> ● Park your vehicle in a safe place and stop the engine. Restart the engine and check whether the indicator goes out. ● If the indicator does not go out, or if it comes on again, have your vehicle inspected by an authorized Mitsubishi Motors dealer or a repair facility of your choice as soon as possible. ● When this indicator comes on, the active stability control is not functioning and normal operation of the vehicle will not be affected. 	<p>P. 5-87</p>
 <p>ASC indicator</p>	<ul style="list-style-type: none"> ● Park your vehicle in a safe place and stop the engine. Restart the engine and check whether the indicator goes out. ● If the indicator does not go out, or if it comes on again, have your vehicle inspected by an authorized Mitsubishi Motors dealer or a repair facility of your choice as soon as possible. ● When this indicator comes on, the hill start assist is not functioning. Start off carefully on a steep uphill slope. 	<p>P. 5-80</p>
 <p>Tire pressure monitoring system warning light</p>	<ul style="list-style-type: none"> ● If the warning light comes on, you should stop and adjust the tires to the proper inflation pressure as soon as possible. Refer to “Tire inflation pressures” on page 9-16. Once adjustments have been made, the warning light will go off after a few minutes of driving. ● If the warning light blinks for approximately 1 minute and then remains continuously illuminated, the system is not operating properly. If the system returns to normal, the warning light will go off. If the warning light does not go off, have the vehicle inspected at an authorized Mitsubishi Motors dealer. 	<p>P. 5-126</p>

If this problem occurs...

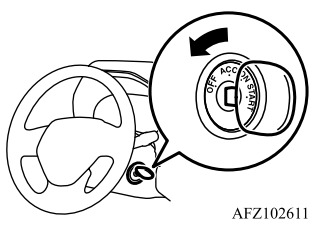
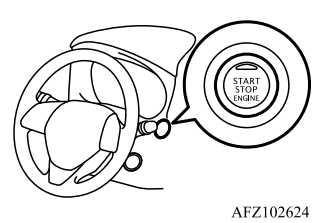
Problem	Do this	Ref. Page
<p>Unable to turn the key. (except for vehicles equipped with the F.A.S.T.-key)</p>  <p>AFZ102611</p>	<p>Will not turn from “ACC” to “OFF”. Check the position of the selector lever. The key cannot be removed unless the selector lever is set to the “P” (PARK) position.</p>	<p>P. 5-61</p>
<p>The engine does not start when the engine switch is pressed. (for vehicles equipped with the F.A.S.T.-key)</p>  <p>AFZ102624</p>	<p>Make sure the F.A.S.T.-key is in the vehicle. Make sure the selector lever is in the “P” (PARK) position, and then press the engine switch while depressing the brake pedal.</p>	<p>P. 5-23</p>

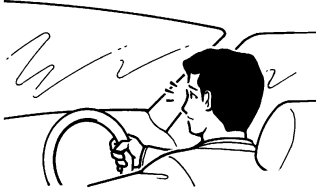
Problem	Do this	Ref. Page
<p>The engine does not start and the operation mode cannot be changed to OFF. (for vehicles equipped with the F.A.S.T.-key)</p>	<ol style="list-style-type: none"> 1. Move the selector lever to the “P” (PARK) position, and then change the operation mode to OFF. 2. One of the other causes could be low battery voltage. If this occurs, the keyless entry system and the F.A.S.T.-key operation will also not operate. Contact an authorized Mitsubishi Motors dealer or a repair facility of your choice. 	<p>P. 5-19</p>
<p>The F.A.S.T.-key does not operate. (for vehicles equipped with the F.A.S.T.-key)</p>	<p>Touch the portion of the F.A.S.T.-key to the engine switch, and then start the engine or change the operation mode. Use the emergency key to lock and unlock the driver’s door.</p>	<p>P. 5-25, 5-26</p>
<p>Cannot shift the selector lever from the “P” (PARK) position.</p>	<p>Shift the selector lever while pressing the brake pedal. Check that the ignition switch or the operation mode is in ON.</p>	<p>P. 5-63</p>
<p>The windows are fogged up.</p> 	<p>Push the defogger switch to change to the “☁” position.</p>	<p>P. 7-3, 7-9, 7-13, 7-18, 7-22</p>
<p>The engine does not start. The lights do not come on. The lights are dim. The horn does not honk. The horn sound is weak.</p>	<p>Have the battery checked. Recharge or replace as needed.</p>	<p>P. 8-2, 9-10</p>

If this problem occurs...

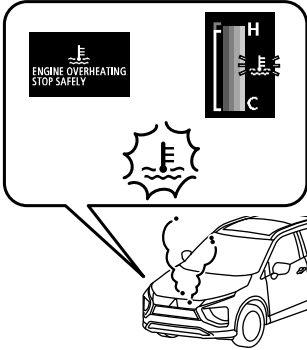

2

Problem	Do this	Ref. Page
<p>The information screen in the multi-information display will be interrupted and the engine coolant temperature warning display will appear. Also “” will blink.</p>  <p>AFM113900</p> <p>Steam comes out of the engine compartment.</p>	<p>The engine is overheated. Carefully stop the vehicle in a safe place.</p>	<p>P. 8-4</p>
<p>If your vehicle becomes stuck in sand, mud or snow.</p>	<ol style="list-style-type: none"> 1. Slowly press down on the accelerator pedal to get your vehicle moving again. For an all-wheel drive vehicle, set the drive mode-selector to the “SNOW” or “GRAVEL” position and then slowly press down on the accelerator pedal to get your vehicle moving. 2. If there is nothing to stop your tires from slipping, rock your vehicle out of the stuck position. 	<p>P. 8-12</p>

⚠ WARNING

- When attempting to rock your vehicle out of a stuck position, be sure that no one is near the vehicle. The rocking motion may cause the vehicle to suddenly lurch forward or backward, possibly injuring bystanders.
- Avoid revving the engine or spinning the wheels. Prolonged efforts to free a stuck vehicle may result in overheating and transaxle failure. If the vehicle remains stuck after several rocking attempts, have a towing service pull the vehicle out.

2

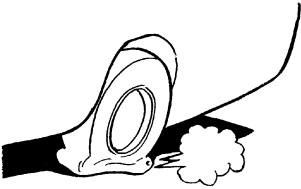
Problem	Do this	Ref. Page
The brakes are not functioning properly after crossing a puddle or stream.	Dry out the brakes by driving slowly while lightly pressing the brake pedal.	P. 5-74, 6-5
The continuously variable transmission (CVT) makes no shift change when accelerating. The initial movement of the vehicle is slow when the vehicle starts moving.	There may be a problem in the CVT. If the  or  warning display on the multi-information display will not turn off, or if they come on frequently, immediately have the vehicle checked at your nearest Mitsubishi Motors dealer.	P. 5-69
A tire is punctured. 	<ol style="list-style-type: none"> 1. Park the vehicle in a safe place where the surface is flat and level. 2. Replace the flat tire with the spare tire. 	P. 8-6



General information

Fuel selection	3-2
Filling the fuel tank	3-3
Telematics Control Unit (TCU) (if so equipped).....	3-5
Modifications to and racing of your vehicle	3-12
Genuine Mitsubishi Motors parts	3-13
California Perchlorate Materials Requirements	3-13
Break-in recommendations	3-14
Event Data Recording	3-14

Fuel selection

N00301002059

Your vehicle is designed to use unleaded gasoline only. It is equipped with a fuel tank filler pipe specifically designed to accept only a small diameter unleaded gasoline dispensing nozzle.

WARNING

- Gasoline is highly flammable and explosive. You could be burned, seriously injured or killed when handling it. Whenever you refuel your vehicle, stop the engine and keep flames, sparks, and smoking materials away from the vehicle. Always handle fuel in well-ventilated outdoor areas.

CAUTION

- Using leaded gasoline in your vehicle will damage the engine, catalytic converter, and the oxygen sensors. Also, using leaded gasoline is illegal, and will void your warranty coverage of the engine, catalytic converter, and oxygen sensors.

Gasoline detergent additives

In the United States, fuel suppliers are required by law to add detergents to their gas-

oline to minimize fuel-injector clogging and minimize intake-valve deposits. Detergent gasoline helps keep your engine in tune and your emission-control system working properly.

Octane requirement

Your vehicle is designed to operate on unleaded gasoline having a minimum octane number of 87 [(MON+RON)/2] or 91 RON.

NOTE

- Premium fuel is recommended to improve the performance under severe conditions such as hot weather or towing.

Oxygenated gasoline

Gasoline sold at some service stations contains oxygenates such as ethanol, although the oxygenates may not be identified by those names. Oxygenates are required in some areas of the country. Oxygenated fuel can be used in your vehicle.

Ethanol (Gasohol)

A mixture of up to 10 % ethanol (grain alcohol) and 90 % unleaded gasoline may be used in your vehicle, provided the octane number is at least as high as that recommended for unleaded gasoline.

Methanol

Do not operate your vehicle on gasoline containing methanol (wood alcohol). Using this type of alcohol could adversely affect the vehicle's performance and damage critical parts of the vehicle's fuel system.

Reformulated gasoline

Many areas of the country require the use of cleaner burning fuel referred to as "Reformulated Gasoline".

Reformulated gasoline contains oxygenates and is specially blended to reduce vehicle emissions and improve air quality.

Mitsubishi Motors Corporation strongly supports the use of reformulated gasoline. Properly blended reformulated gasoline has no adverse effect on vehicle performance or the durability of the engine and the fuel system.

MMT (methylcyclopentadienyl manganese tricarbonyl)

MMT is a manganese-containing metallic additive that is blended into some gasolines to increase the octane number. Mitsubishi Motors Corporation recommends using gasolines without MMT.

Use of gasolines blended with MMT may adversely affect performance, and cause the malfunction indicator on your instrument panel to come on. If this happens, contact an authorized Mitsubishi Motors dealer or a repair facility of your choice for assistance.

Sulfur in gasoline

Your vehicle may have been designed to satisfy California's low-emission regulations based on clean-burning low-sulfur gasoline. Gasoline sold in parts of the country other than California is allowed to have a higher sulfur content. Using such gasoline could adversely affect the vehicle's catalytic converter and cause the engine malfunction indicator ("SERVICE ENGINE SOON" or "Check engine light") to come on. Illumination of this indicator while using high-sulfur gasoline does not necessarily mean the vehicle's emission-control system is malfunctioning. Your authorized Mitsubishi Motors

dealer may suggest using a different, lower-sulfur brand of unleaded gasoline to determine if the problem is fuel-related.



NOTE

- Poor-quality gasoline can cause problems such as hard starting, stalling during idling, abnormal engine noise, and poor acceleration. If you experience any of these problems, try using a different brand of gasoline. If the engine malfunction indicator ("SERVICE ENGINE SOON" or "Check engine light") flashes, have the vehicle inspected immediately by the nearest authorized Mitsubishi Motors dealer or a repair facility of your choice.
- Repeatedly driving short distances at low speeds can cause deposits to form in the fuel system and engine, resulting in hard starting and poor acceleration. If these problems occur, you are advised to add a detergent additive to the gasoline when you refuel the vehicle. The additive will remove the deposits, thereby returning the engine to a normal condition. Be sure to use a Mitsubishi Motors Genuine cleaning additive. Using an unsuitable additive could make an engine malfunction. For details, please contact the nearest authorized Mitsubishi Motors dealer.

Filling the fuel tank

N00301102092

⚠ WARNING

- When handling fuel, comply with the safety regulations displayed by garages and filling stations.
- Gasoline is highly flammable and explosive. You could be burned, seriously injured or killed when handling it. When refueling your vehicle, always turn the engine off and keep away from flames, sparks, and smoking materials. Always handle fuel in well-ventilated outdoor areas.
- Before removing the fuel tank filler cap, be sure to get rid of your body's static electricity by touching a metal part of the vehicle or fuel pump. Any static electricity on your body could create a spark that ignites fuel vapor.
- Perform the whole refueling process (opening the fuel tank filler door, removing the fuel cap, etc.) by yourself; do not let any other person near the fuel tank filler. If you allowed a person to help you and that person was carrying static electricity, fuel vapor could be ignited.
- Do not move away from the fuel tank filler until refueling is finished. If you moved away and did something else (for example, sitting on a seat) part-way through the refueling process, you could pick up a fresh charge of static electricity.

Filling the fuel tank

⚠ WARNING

- Be careful not to inhale fuel vapor. Fuel contains toxic substances.
- Keep the doors and windows closed while refueling the vehicle. If they were open, fuel vapor could get into the cabin.

3

Fuel tank capacity

All-wheel drive vehicles: 15.8 gal (60 L)
Front-wheel drive vehicles: 16.6 gal (63 L)

Refueling

1. Before filling with fuel, stop the engine.
2. The fuel tank filler is located on the rear driver side of your vehicle.

The fuel tank filler door can be opened from inside the vehicle with the fuel tank filler door release lever located at the left side of the driver's seat.

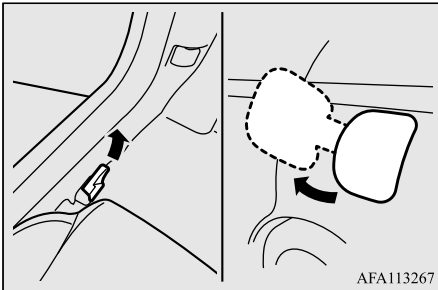

3. Open the fuel tank filler pipe by slowly turning the fuel tank filler cap counter-clockwise.

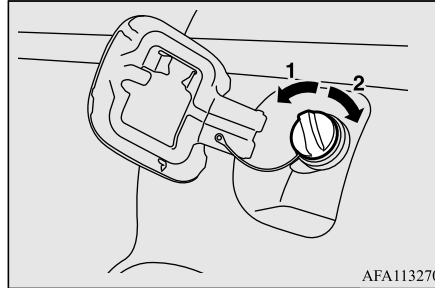

- 1- Remove
- 2- Close

⚠ WARNING

- Since the fuel system may be under pressure, remove the fuel tank filler cap slowly. This relieves any pressure or vacuum that might have built up in the fuel tank. If the cap is venting vapor or if you hear a hissing sound, wait until the sound stops before removing the cap. Otherwise, fuel may spray out, injuring you or others.

📖 NOTE

- While filling with fuel, store the fuel cap in the cap holder (A) or hang it on the hook (B) located on the inside of the fuel tank filler door.

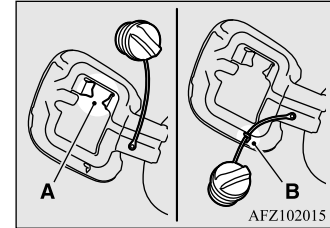

4. Fueling correctly depends mainly on correct handling of the fuel filler nozzle. Do not tilt the nozzle. Insert the nozzle in the fuel tank filler port as far as it goes.

⚠ CAUTION

- Your vehicle can only be operated using unleaded gasoline. Serious engine and catalytic converter damage will result if leaded gasoline is filled into these vehicles, and consequently, this must never be attempted.

5. When the nozzle stops automatically, do not add more fuel.

⚠ CAUTION

- To avoid fuel spillage and overfilling, do not “top-off” the fuel tank. Spilled fuel could discolor, stain, or crack the vehicle’s paintwork. If fuel spills on the paintwork, wipe it off with a soft cloth.

6. To re-install, turn the fuel tank filler pipe cap slowly clockwise until you hear clicking sounds, then gently push the fuel tank filler door closed.

⚠ WARNING

- **Make sure the fuel tank filler cap is securely closed. If the fuel cap is loose, fuel could leak, resulting in a fire.**

⚠ CAUTION

- If you need to replace the fuel tank filler cap, use only a cap specified for your model vehicle.

📖 NOTE

- If the fuel tank filler cap is not tight while driving, the engine malfunction indicator (“SERVICE ENGINE SOON” or “Check engine light”) may come on when the onboard diagnostic (OBD) system performs a self check.
Always tighten the fuel tank filler cap until you hear at least 3 clicks.
The indicator will go off after several driving cycles. If the indicator does not go off, contact your authorized Mitsubishi Motors dealer or a repair facility of your choice immediately.

📖 NOTE

- To use the TCU, a user service agreement is necessary. In addition, you must install the smartphone app, agree to the terms of service, and register as a user before using the TCU.
For details including system limitations, contact an authorized Mitsubishi Motors dealer or visit the Mitsubishi Motors website.
<https://www.mitsubishicars.com/owners/service/manuals>
- After you complete the registration using the smartphone app, you will also be able to use the telematics features on the owners portal and call center service.

Telematics Control Unit (TCU) (if so equipped)

N00302500057

The Telematics Control Unit (TCU) uses a mobile communication network to transmit notifications (SOS emergency assistance/Information assistance) in case of emergency and vehicle information. The TCU also allows you to use your smartphone to operate some vehicle functions remotely.

SOS emergency assistance/ Information assistance

- **SOS emergency assistance**
If a collision is detected or you press the SOS switch (A), the system automatically transmits the vehicle information to an emergency call center, and will call the emergency call center, allowing you to communicate the nature of your problem or emergency and request assistance. If necessary, the telephone call is forwarded to a Public Safety Answering Point (PSAP), such as dialing 911 in the United States.

Information assistance

If you press the information switch (B), you will be connected to the call center and your vehicle information will automatically be transmitted to the call center. In the case of a breakdown, your telephone call will be forwarded to roadside assistance.

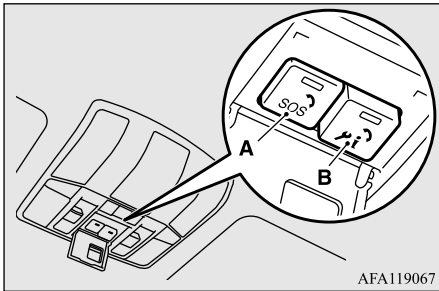

A- SOS switch
B- Information switch

WARNING

● In a country or area where no emergency call center is available for the TCU, or where radio waves for the emergency call cannot be transmitted or received normally, the system will not operate. In this case, use a cellular phone, etc., to call directly for an emergency vehicle or road service.

WARNING

- If an emergency occurs and you smell fuel or other unusual odor, do not stay inside the vehicle. Exit the vehicle immediately and move to a safe location.
- While waiting for rescue after making the emergency call, take actions to prevent a rear-end collision or other secondary accident and move to a safe location away from the vehicle and traffic.
- Always carry a cell phone or other communication device as backup against possible malfunctions or non-working conditions in SOS emergency assistance. This system should not be your sole means of receiving help in the event of an emergency.

In the following cases, use a cellular phone or other device to call directly for an emergency vehicle or road service.

- When the system does not operate due to a malfunction because of a collision, etc.
- When the vehicle is in a place where radio waves cannot be transmitted or received, such as indoors, in an underground parking structure, in a mountainous area, or in a tunnel.
- When the line to the emergency call center is busy and the call cannot reach the emergency call center.

Flow of the SOS emergency assistance/Information assistance

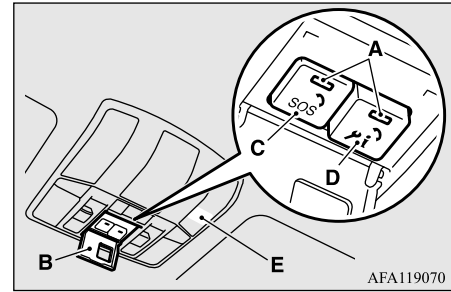

AFA119070

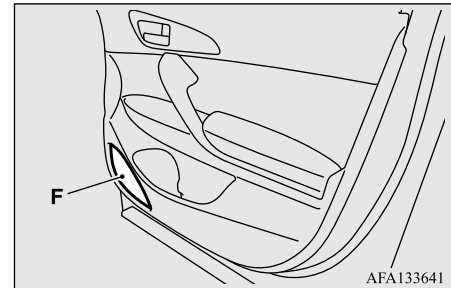

AFA133641

A- Indicator light (red/green)
B- Cover
C- SOS switch
D- Information switch
E- Microphone
F- Door speaker (only front passenger side)

⚠ WARNING

- Do not remove or modify the above parts. This can cause the system to not operate.

📖 NOTE

- Although the information switch (D) is not for use in emergencies, the operation is the same as the operation of the SOS switch (C) for SOS emergency assistance.

1. After setting the operation mode to ON, the indicator lights (A) illuminate for approximately 10 seconds. When approximately 10 seconds has elapsed after the lights turn off, the system is in the standby state.

⚠ WARNING

- If the indicator lights do not illuminate after setting the operation mode to ON, there is a possible problem in the system. Have the system inspected by an authorized Mitsubishi Motors dealer.

⚠ WARNING

- If the indicator lights (A) remain illuminated or illuminate again after setting the operation mode to ON, there is a possible problem in the system or the battery for exclusive use of the TCU may be exhausted. The battery life is approximately 3 years.
Have the system inspected or replace the battery using an authorized Mitsubishi Motors dealer.
- When the system is not in the standby state, the system does not operate. When you drive, make sure to check that the system is in the standby state.

📖 NOTE

- Even if the SOS emergency assistance is in the standby state, communication may not be possible for a while depending on the radio wave conditions.

2. The system operates by the following.

[Automatic Report]
If your vehicle's airbags deploy or if the unit detects that the vehicle was in a severe collision, your vehicle automatically will attempt to connect to the emergency call center operator. Once connected, information about your vehicle, its location, and its condition will be sent to the operator; you also can speak to the operator when connected.

[Manual Report]
When you open the cover (B) and press the SOS switch (C).

⚠ WARNING

- Before pressing the SOS switch (C), stop the vehicle in a safe place. If you operate it while driving, your attention to the surrounding conditions may be affected, resulting in an accident.

⚠ CAUTION

- Do not open the cover unless you intend to press the SOS switch (C). You may press the SOS switch (C) by mistake. In addition, if the cover is left open while driving, the cover can cause injury in the event of an accident.

 **NOTE**

- Do not press the SOS switch (C) unless there is an emergency such as an accident or sudden illness. If an emergency vehicle, such as an ambulance, firetruck, or other official response vehicle, is dispatched unnecessarily, you may be charged.

3. The green indicator light blinks fast, the system calls the emergency call center, and the location and vehicle information are transmitted to the emergency call center.

 **WARNING**

- If the red indicator light illuminates as follows, directly arrange an emergency vehicle or road service with a cellular phone, etc.
- When the red indicator light remains illuminated. (There is a possible problem in the system.)
- When the red indicator light illuminates for 60 seconds. (The vehicle may be in the place where radio waves cannot be transmitted and received.)

4. When the green indicator light changes from a fast blinking state to a slow blinking state, it is possible to speak with an operator of the emergency call center.

 **WARNING**

- Do not replace the speakers. If they are replaced, the voice of the operator at the emergency call center may not be audible. If the speakers need to be replaced due to a problem, or for any other reason, we recommend you consult an authorized Mitsubishi Motors dealer.
- It is possible that an error may occur between the actual location point of the vehicle and the location point that the TCU reports to the call center. Confirm your location and description of your vehicle through the call with the operator of the emergency call center.

 **NOTE**

- If the vehicle side microphone (E) and/or the speakers fail, you cannot talk with the operator of the emergency call center.
- An emergency call cannot be disconnected from the vehicle side.

5. The emergency call center arranges for dispatch of the emergency vehicle as required.

Indicator list

Situation	Indicator light		Cause	Solution
	Red light	Green light		
When changing the operation mode to ON	Illuminates (for approximately 10 seconds)	Turns off	The system check is in process.	Wait for a while. The indicator lights go off when the system check is complete. If the indicator lights do not illuminate, there is a possible problem in the system. In this case, immediately have the system inspected at an authorized Mitsubishi Motors dealer.
After approximately 10 seconds after changing the operation mode to ON	Turns off	Turns off	The system works normally.	–
	Illuminates	Turns off	There is a possible problem in the system or the battery may be exhausted.	Immediately have the system inspected at an authorized Mitsubishi Motors dealer.
While the SOS emergency assistance/ Information assistance is activated	Turns off	Fast blinking	<ul style="list-style-type: none"> ● The system calls the emergency call center. ● The system transmits the location and vehicle information to the emergency call center. 	–
	Turns off	Slow blinking	It is possible to speak with an operator of the emergency call center.	Mutually confirm the details of the SOS emergency assistance/Information assistance with the operator of the emergency call center. If the green light does not turn off even after the call ends, have the system inspected at an authorized Mitsubishi Motors dealer.

Situation	Indicator light		Cause	Solution
	Red light	Green light		
When the SOS emergency assistance/Information assistance failed	Illuminates (for approximately 60 seconds)	Turns off	The SOS emergency assistance/Information assistance failed.	Activate SOS emergency assistance/Information assistance again, or directly arrange an emergency vehicle or road service with the nearest public telephone, etc.

Remote control

NOTE

- To operate the remote control functions from a smartphone or to receive notifications using the smartphone, you must install the smartphone app and register as a user beforehand. For details about using the functions or changing the settings, visit the Mitsubishi Motors website.
<https://www.mitsubishicars.com/owners/service/manuals>
- The remote operation functions, other than the alert notification, cannot be activated if the vehicle engine is not started for 5 or more consecutive days.

● Alarm notification

When the vehicle's theft-alarm system is activated, an alert is sent to the smartphone using a short message service (SMS), e-mail, or push notification.

● Stolen vehicle tracking

The vehicle tracking function can be used by the call center to provide the vehicle location information quickly to police.

● Remote door lock/unlock

The vehicle doors and liftgate can be locked and unlocked using the smartphone app and the owner portal.

NOTE

- If the doors and the liftgate are unlocked using the smartphone app and the owner portal when no doors or the liftgate are opened within a certain length of time, the doors and the liftgate will automatically re-lock.
- Be sure to have the F.A.S.T.-key with you before locking the vehicle.
It is possible to lock/unlock the vehicle even when the F.A.S.T.-key is inside the vehicle. If the smartphone app cannot be used for some reason (e.g., your smartphone battery becomes discharged), you need the F.A.S.T.-key in order to unlock the vehicle.

NOTE

- When the vehicle is locked or unlocked, the power-folding outside rearview mirrors operate and the theft-alarm system turns on or off.

● Remote climate control

The engine can be started and the air conditioning can be operated using the smartphone app.

● Car finder

The location of the parked vehicle can be confirmed using the smartphone app.

● Remote horn

You can make the horn sound using the smartphone app.

● Remote lights

The lights can be turned on using the smartphone app.

NOTE

- The remote lights turns off automatically after approximately 30 seconds.

● **Speed alert**

If you set a vehicle speed limit beforehand using the smartphone app and the owner portal, an alert is sent to the smartphone app when the vehicle speed exceeds that limit.

● **Geofence**

If the specified area is set beforehand using the smartphone app and the owner portal, an alert is sent to the smartphone using a short message service (SMS), e-mail, or push notification when the vehicle enters or leaves that area.

● **Curfew alert**

If the specified time of day is set beforehand using the smartphone app and the owner portal, an alert is sent to the smartphone using a short message service (SMS), e-mail, or push notification when the curfew is violated.

● **Vehicle settings**

You can change settings of items such as “Auto Fold Mirrors” and “Headlight Timeout when Exiting Vehicle” from the smartphone app and the owner portal.

● **Vehicle Status Report (VSR)**

The vehicle communication and information regarding malfunctions can be transmitted using the TCU so that the condition of the vehicle can be checked using the smartphone app and the owner portal.

● **Over The Air Update**

When software and firmware updates are available, notifications will be sent to you to install the updates. You can also check for available updates manually.

⚠ WARNING

● **Do not use the TCU if children, persons in need of care, pets, etc., are in the vehicle. Even if the remote climate control is used, the cabin may become too hot or cold if the system stops automatically or due to any other reason. The cabin temperature may quickly rise with prolonged exposure to heat or sun, which may pose a risk of heat stroke and dehydration. In cold weather, the cabin temperature may quickly drop. Extreme changes in cabin temperature may cause bodily harm, injury, or death. In addition, children can activate switches and controls, resulting in an injury or fatal accident.**

⚠ CAUTION

● When using the remote climate control, do not use a car cover.

📖 NOTE

● Air conditioning performance may deteriorate under the following conditions:

- In extremely hot weather

📖 NOTE

- In hot sunshine
- In extremely cold weather
- The remote climate control turns off automatically after approximately 10 minutes. The remote climate control can be operated up to two times consecutively.
- Use the remote climate control according to the state or local regulations regarding idling vehicles.

General information

Your TCU operates on a radio frequency subject to Federal Communications Commission (FCC) Rules (for vehicles sold in U.S.A.). This device complies with Part 15 of the FCC Rules. Operation is subject to the following two conditions:

- This device may not cause harmful interference.
- This device must accept any interference received, including interference that may cause undesired operation.

⚠ CAUTION

- Changes or modifications made to this equipment not expressly approved by the manufacturer may void the FCC authorization to operate this equipment.

FCC Notice: This equipment has been tested and found to comply with the limits for a Class B digital device, pursuant to part 15 of the FCC Rules. These limits are designed to provide reasonable protection against harmful interference in a residential installation.

This equipment generates, uses and can radiate radio frequency energy and, if not installed and used in accordance with the instructions, may cause harmful interference to radio communications.

However, there is no guarantee that interference will not occur in a particular installation. If this equipment does cause harmful interference to radio or television reception, which can be determined by turning the equipment off and on, the user is encouraged to try to correct the interference by one or more of the following measures:

- Reorient or relocate the receiving antenna.
- Increase the separation between the equipment and receiver.
- Connect the equipment into an outlet on a circuit different from that to which the receiver is connected.
- Consult the dealer or an experienced radio/TV technician for help.

Modifications to and racing of your vehicle

N00301601218

This vehicle should not be modified with non-Mitsubishi Motors genuine parts. Mitsubishi Motors designs and manufactures high quality vehicles with an emphasis on safety and durability. Modifications using non-Mitsubishi Motors genuine parts may affect the performance, safety and/or durability of your vehicle, and may violate applicable state and/or federal regulations.

DAMAGE OR PERFORMANCE PROBLEMS RESULTING FROM MODIFICATIONS TO OR RACING OF YOUR VEHICLE ARE NOT COVERED UNDER WARRANTY.

Examples of modifications to your vehicle that can cause damage or performance problems include the following:

- Failure to use Mitsubishi Motors genuine parts
- Failure to use required fuel and fluids
- Failure to use proper size tires and wheels
- Modification of the fuel, intake, exhaust, emission, suspension, engine, drive train or electrical wiring systems

- Modification of any onboard computer/control module, including reprogramming, or replacing/adding chips to any onboard computer/control module

Review the Warranty and Maintenance Manual for further details regarding warranty coverage.

Installation of accessories

N00301701293

⚠ CAUTION

- Before any electrical or electronic accessories are installed, consult an authorized Mitsubishi Motors dealer.
- Your vehicle is equipped with a diagnosis connector (data link connector) for checking and servicing the electronic control system. Mitsubishi Motors does not recommend connecting a device other than the Scan Tool for inspections and service to this connector because an unexpected problem could result. In addition, malfunctions caused by connecting a device other than the Scan Tool may not be covered under warranty.
- The installation of accessories, optional parts, etc., should only be performed within the limits prescribed by law, and in accordance with the guidelines and warnings contained within the documents accompanying this vehicle.

Only Mitsubishi Motors approved accessories should be fitted to your vehicle.

- Improper installation of electrical parts could cause a fire. Refer to the “Modification/alterations to the electrical or fuel systems” section within this owner’s manual.
- Using a cellular phone or radio set inside the vehicle without an external antenna may cause electrical system interference, which could lead to unsafe vehicle operation.
- Tires and wheels which do not meet specifications must not be used. Refer to the “Specifications” section for information regarding wheel and tire sizes.

WARNING

- **While driving, do not use a cellular phone in a way that hinders safe driving. Anything, including cellular phone usage, that distracts you from the safe operation of your vehicle increases your risk of an accident.**

Refer to and follow all state and local laws in your area regarding cellular phone usage while driving.

Important point!

Due to the large number of accessory and replacement parts provided by different manufacturers in the market, it is not always possible for an authorized Mitsubishi Motors dealer to check whether the attachment or installation of a non-Mitsubishi Motors genuine parts affects the driving safety of your vehicle.

Modification/alterations to the electrical or fuel systems

N00301800141

Mitsubishi Motors manufactures high quality vehicles with an emphasis on safety. It is important to consult an authorized Mitsubishi Motors dealer before installation of any accessory which may involve modification of the electrical or fuel systems.

CAUTION

- Please consult an authorized Mitsubishi Motors dealer concerning any such accessory fitment or modification. If the wires interfere with the vehicle body or improper installation methods are used (protective fuses not included, etc.), electronic devices may be adversely affected, resulting in a fire, vehicle damage, or other accident.

Genuine Mitsubishi Motors parts

N00301400219

Mitsubishi Motors Genuine Parts are designed and manufactured to meet high standards of performance, and are recommended for all of your maintenance needs. Also available from your Mitsubishi Motors dealer are a wide variety of accessories to personalize your new vehicle. Each Mitsubishi Motors vehicle has a selection of Mitsubishi Motors authorized accessories to choose from to tailor your new vehicle to your own personal preference. Your Mitsubishi Motors dealer’s Parts Manager has information on various audio systems, protection items, as well as interior and exterior accessories available for your specific model.

California Perchlorate Materials Requirements

N00300100017

Certain components of this vehicle, such as airbag modules, seat belt pretensioners, and button cell batteries, may contain perchlorate materials. Special handling may apply. For additional information, see www.dtsc.ca.gov/hazardouswaste/perchlorate.

Break-in recommendations

N00302600029

3

Advanced automobile manufacturing techniques permit you to operate your new vehicle without requiring a long break-in period of low-speed driving.

However, you can add to the future performance and economy of your vehicle by observing the following precautions during the first 300 miles (500 km).

Drive your vehicle at moderate speeds during the break-in period.

- Avoid revving the engine.
- Avoid rough driving such as sudden starts, sudden acceleration, prolonged high-speed driving and sudden braking. These actions would have a detrimental effect on the engine and lead to increased fuel and oil consumption; this could ultimately result in the malfunction of engine components. Be particularly careful to avoid full acceleration while in low shift position (low gears).

- Do not overload the vehicle. Stay within the seating capacity.

Refer to “Cargo load precautions” on page 6-11.

- Refrain from towing a trailer or other vehicle.

Refer to “Trailer towing” on page 6-13.

Event Data Recording

N00302700059

This vehicle is equipped with an event data recorder (EDR).

The main purpose of an EDR is to record, in certain crash or near crash-like situations, such as an airbag deployment or hitting a road obstacle, data that will assist in understanding how a vehicle’s systems performed. The EDR is designed to record data related to vehicle dynamics and safety systems for a short period of time, typically 30 seconds or less.

The EDR in this vehicle is designed to record such data as:

- How various systems in your vehicle were operating;
- Whether or not the driver and front passenger safety belts were buckled/fastened;
- How far (if at all) the driver was depressing the accelerator and/or brake pedal; and,
- How fast the vehicle was traveling.

These data can help provide a better understanding of the circumstances in which crashes and injuries occur.



NOTE

- EDR data are recorded by your vehicle only if a non-trivial crash situation occurs; no data are recorded by the EDR under normal driving conditions and no personal data (e.g., name, gender, age, and crash location) are recorded. However, other parties, such as law enforcement, could combine the EDR data with the type of personally identifying data routinely acquired during a crash investigation.

To read data recorded by an EDR, special equipment is required, and access to the vehicle or the EDR is needed. In addition to the vehicle manufacturer, other parties, such as law enforcement, that have the special equipment, can read the information if they have access to the vehicle or the EDR.

Seat and restraint systems

Seats	4-2
Seats and restraint systems	4-3
Front seats	4-3
Rear seats	4-6
Heated seats (if so equipped).....	4-7
Head restraints	4-8
Making a cargo area	4-11
Seat belts	4-12
Seat belt use during pregnancy	4-19
Seat belt pre-tensioner and force limiter systems	4-20
Child restraint systems	4-21
Maintenance and inspection of seat belts	4-31
Supplemental Restraint System (SRS) - airbag	4-31

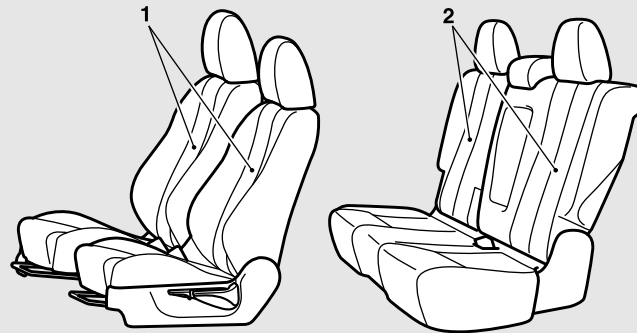

1 - Front seat

- To adjust the seat forward or backward → Page 4-4
- To adjust the seatback → Page 4-5
- To adjust the seat height (if so equipped) → Page 4-5

2 - Rear seats

- To adjust the seatback → Page 4-6
- Arm rest (if so equipped) → Page 4-7

Seats and restraint systems

N00401601277

Your vehicle has seat belts and other safety features that help protect you and your passengers in an accident.

Seat belts are the most important safety device. When worn properly, seat belts can reduce the chance of serious injury or death in various types of crashes. For added protection during a severe frontal collision, your vehicle has a Supplemental Restraint System (SRS) with airbags for the driver and passengers. The seats, head restraints, and door locks also are safety equipment, which must be used correctly.

Always check the following before you drive:

- That everyone in your vehicle is properly wearing their seat belt.
- That infants and small children are properly secured in an appropriate child restraint system in the rear seat.
- That all doors are fully closed and locked.
- That seatbacks are upright, with head restraints properly adjusted.

Safety equipment cannot prevent injury or death in all motor vehicle accidents. However, you can help reduce the risk of injury or death, by following the instructions in this manual.

⚠ WARNING

- Do not place objects under the seats. The objects could prevent the seat from locking securely, which could lead to an accident. The objects may also cause damage to the seat or other parts.

Front seats

N00401801514

Position the driver's seat as far back as possible while maintaining a position that still enables you to fully apply the pedals, easily control the steering wheel and safely operate the vehicle.

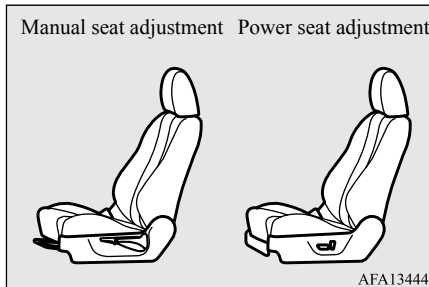

⚠ WARNING

- Do not attempt to adjust the seat while driving. This can cause loss of vehicle control and result in an accident.

⚠ WARNING

- After adjusting the seat, make sure that it is securely locked into position.
- To reduce the risk to the driver of serious injury or death during deployment of the driver's airbag, always properly wear the seat belt and adjust the driver's seat as far back as possible while maintaining a position that still enables you to fully apply the pedals, easily control the steering wheel, and safely operate the vehicle.
- To reduce the risk to the front passenger of serious injury or death during deployment of the passenger's airbag, always properly wear the seat belt and adjust the front passenger's seat as far back as possible.
- Always place children 12 years old and under in the rear seat and use appropriate child restraint systems.

⚠ CAUTION

- Make sure that the seat is adjusted by an adult. If it is adjusted by a child, an unexpected accident might occur.
- Do not place a cushion or the like between your back and the seatback while driving. The effectiveness of the head restraints will be reduced in the event of an accident.
- When sliding the seats, be careful not to catch your hand or leg.

CAUTION

- When sliding or reclining the seat rearward, pay careful attention to the rear seat passengers.

4

To adjust the seat forward or backward

N00401901414

Manual seat adjustment

Pull the seat adjusting lever up and slide the seat forward or backward to the desired position. Release the adjusting lever to lock the seat in place.

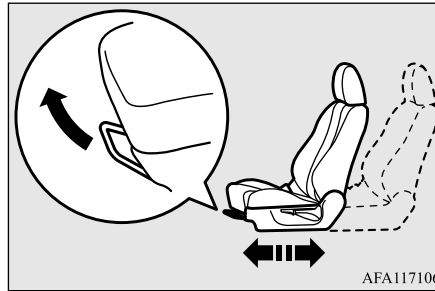

WARNING

- To make sure that the seat is securely locked, try to move it forward or backward without using the adjusting lever.

Power seat adjustment (if so equipped)

Operate the switch forward or backward to move the seat to the desired position. Release the switch to lock the seat in place.

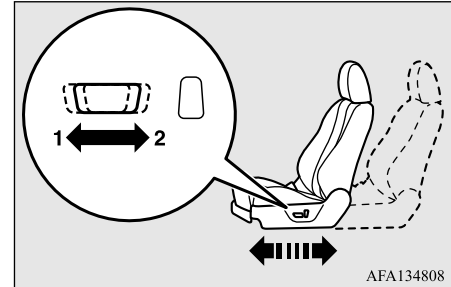

- 1- Forward (toward the front of the vehicle)
- 2- Backward (toward the rear of the vehicle)

NOTE

- To prevent the battery from completely discharging, operate the power seat with the engine running.

To adjust the seatbacks

N00402001467

Manual seat adjustment

To adjust the seatback, lean forward slightly, gently pull the seatback lock lever up, then lean backward to a comfortable position and release the lever. The seatback will lock in place.

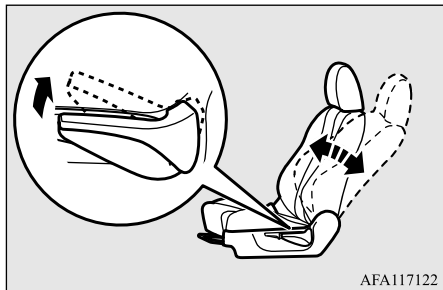

AFA117122

CAUTION

- The reclining mechanism used in the seatback is spring loaded, and will cause the seatback to return quickly to the vertical position when the lock lever is operated. When pulling the lever, sit close to the seatback or hold the seatback with your hand to control its return motion.

Power seat adjustment (if so equipped)

Operate the switch in the direction of the arrows to adjust the seatback.

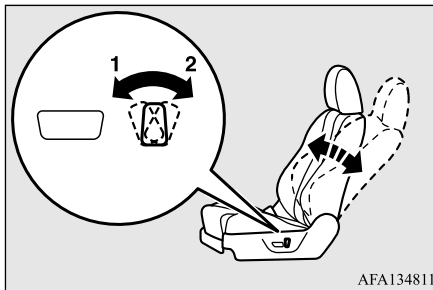

AFA134811

- 1- Move forward
- 2- Move backward

NOTE

- To prevent the battery from completely discharging, operate the power seat with the engine running.

WARNING

- To reduce the risk of serious injury or death in the event of an accident or sudden stop, all seatbacks should be kept in the upright position while the vehicle is in motion.

Seat belt performance during an accident can be adversely affected if the seatbacks are reclined. The more a seatback is reclined, the more likely seat belt performance will be adversely affected. If the seat belt is not properly positioned against the body during an accident, there is increased risk you will slide under the belt and receive serious injury or death.

4

To adjust the seat height (if so equipped)

N00402101338

Manual seat adjustment (Driver's seat only)

Operate the lever repeatedly to raise or lower the seat.

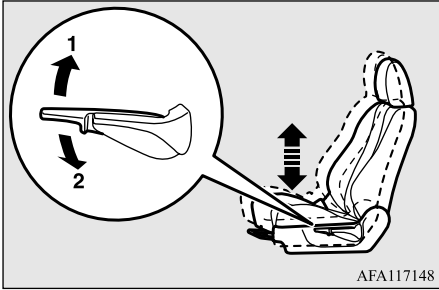

- 1- Raise
- 2- Lower

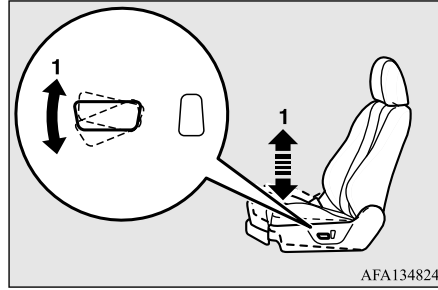

- 1- Raise or lower the front end of the seat cushion

Power seat adjustment

Operate the switch in the direction of the arrows to raise or lower the seat.

NOTE

- To prevent the battery from completely discharging, operate the power seat with the engine running.

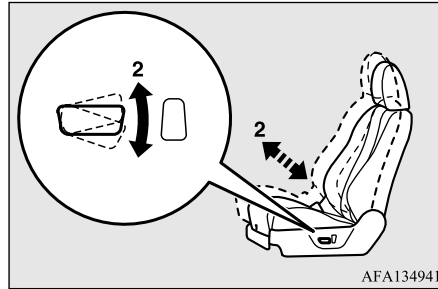

- 2- Raise or lower the seat

Rear seats

N00402501299

When sitting in the rear seat, adjust the head restraints to an appropriate height where they lock in position. Refer to “Head restraints” on

page 4-8.

To adjust the seatbacks

N00402801045

Pull the lever up and adjust the seatback by hand to the desired position, and release the lever. The seatback will lock in place.

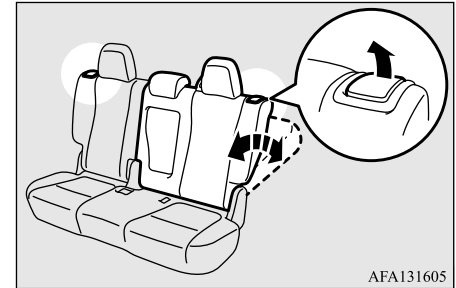

CAUTION

- If your vehicle is equipped with the arm rest and the seatback is reclined while the drink holder is used, drinks could be spilled. If the spilled drink is very hot, you could be burnt.

NOTE

- You can adjust the seatback forward or backward on either side separately.

⚠ WARNING

- To reduce the risk of serious injury or death in the event of an accident or sudden stop, all seatbacks should be kept in the upright position while the vehicle is in motion.
- Seat belt performance during an accident can be adversely affected if the seatbacks are reclined. The more a seatback is reclined, the more likely seat belt performance will be adversely affected. If the seat belt is not properly positioned against the body during an accident, there is increased risk you will slide under the belt and receive serious injury or death.
- When a person is sitting in the center seating position of the rear seats, the two sides of the rear seats must have the same forward/backward position and the same seatback angle.

Arm rest (if so equipped)

N00403001389

To use the arm rest, tilt the arm rest down for use as shown.
The arm rest includes a cup holder.

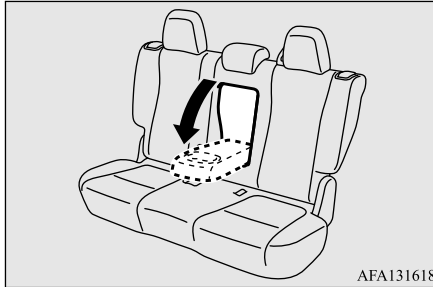

AFA131618

⚠ CAUTION

- Never sit on an arm rest. Doing so could damage the arm rest.

Heated seats (if so equipped)

N00404201030

The heated seats can be operated with the ignition switch or the operation mode in ON.

⚠ WARNING

- Persons who are unable to feel temperature change or skin pain due to age, illness, injury, medication, alcohol use, fatigue or other physical conditions or who have sensitive skin may suffer burns when using the heated seat even at low temperatures. To reduce the risk of burns, people with such conditions must use care when using the heated seat.

⚠ CAUTION

- Switch off the heated seats when not in use.
- Operate the heaters at the “HI” position for quick heating. After the seat has become warm, set the heater switch to the “LO” position to keep it warm. Slight variations in the seat temperature may be felt while using the heated seats. This is caused by the operation of the heater’s internal thermostat and does not indicate a malfunction.
- Do not place heavy objects on the seat or stick pins, needles, or other pointed objects into the seat.
- Do not place a blanket, cushion, or other insulating material on the seat while using the heater; doing so can cause the heater element to overheat.
- When cleaning the seat, do not use benzene, kerosene, gasoline, alcohol, or other organic solvents; doing so can cause damage not only to the surface of the seat, but also to the heater.

Head restraints

⚠ CAUTION

- If water or any other liquid is spilled on the seat, allow it to dry thoroughly before attempting to use the heater.
- Turn the heater off immediately if it appears to be malfunctioning during use.

📖 NOTE

- Do not use the heated seats for a long time when the engine is not running, doing so will cause the battery to be discharged.

For the front seats

Operate the switch as indicated by arrows. The indicator light (A) will illuminate while the heater is on.

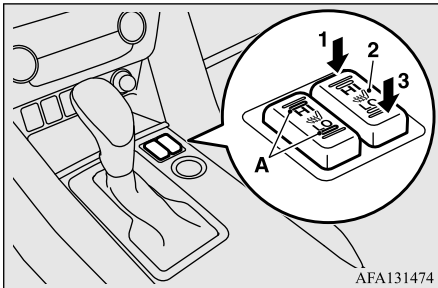

1 (HI) - Heater high (for quick heating)

- 2 (OFF) - Heater off
3 (LO) - Heater low (to keep the seat warm)

For the rear outboard seats

Each time the switch is pressed, the mode changes to the next one in the following sequence: OFF → HI → LO → OFF.

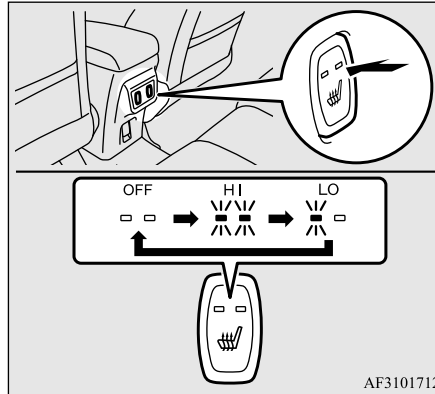

- OFF - Heater off
HI - Heater high (for quick heating)
LO - Heater low (to keep the seat warm)

📖 NOTE

- The rear seat switch will automatically return to “OFF” after the engine is stopped.

Head restraints

N00404301653

Head restraints can reduce the risk of a whiplash injury if your vehicle is hit from the rear. The head restraints are equipped in the illustrated position.

To maximize the effectiveness of the head restraints, adjust the seatback to the upright position, and the head restraint to the proper position. Sit back against the seatback with your head close to the head restraint.

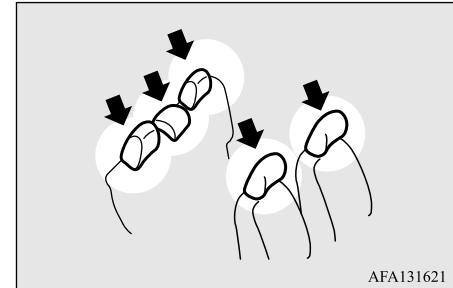

⚠ WARNING

- Driving without the head restraints in place can cause you and your passengers serious injury or death in an accident. To reduce the risk of injury in an accident, always make sure the head restraints are installed and properly positioned when the seat is occupied.
- In order to minimize the risk of a neck injury due to a rear impact, the seatback must be adjusted to the upright position and the head restraint must be adjusted to the proper position before vehicle operation. The driver should never adjust the seat while the vehicle is in motion.
- Never place a cushion or similar device on the seatback. This can adversely affect head restraint performance by increasing the distance between your head and the restraint.

Adjustment of the head restraint height**Front seats and rear outboard seats**

To reduce the risk of injury in an accident, adjust the head restraint height so that the center of the restraint is at your ear level when seated. Any person too tall for the restraint to reach their ear level when seated should raise the restraint to the highest locked position.

- To raise the head restraint, pull it straight up.
- To lower the restraint, push down on it while pressing the lock knob (A) in the direction shown by the arrow.
- After adjusting the height, push down on the restraint to make sure it is locked in position.

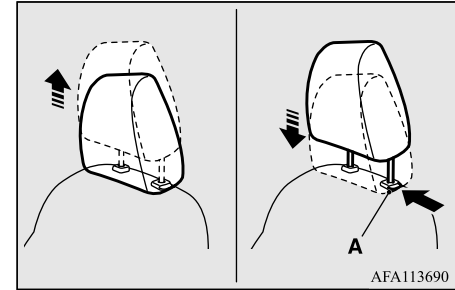
**Rear center seat**

To reduce the risk of injury in an accident, pull up the head restraint to the locked position.

- To raise the head restraint, move it upward.
- After adjustment, push the head restraint downward and make sure that it is locked.
- To lower the restraint, move it downward while pushing the height adjusting knob (A) in the direction of the arrow.

4

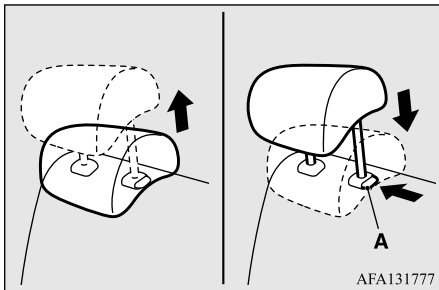

To remove

Press the lock knob (A) in the direction shown by the arrows. Then pull the head restraint up and out of the seatback.

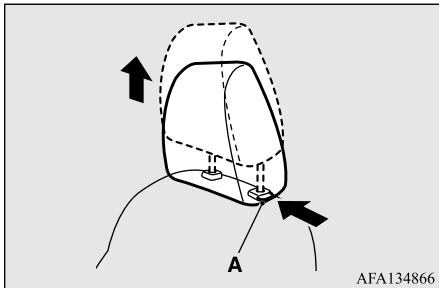

⚠ WARNING

- To help minimize the risk of neck injury in the event of an accident, the head restraints must be properly installed and positioned to proper height before vehicle operation.
- When a person sits in the rear center seating position, pull up the head restraint to a height at which it locks in position. Be sure to make this adjustment before starting to drive. Serious injuries could otherwise be suffered in the result of an impact.

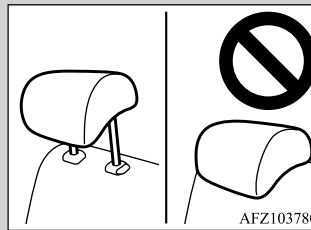

📖 NOTE

- If a front seat head restraint contacts the headliner and cannot be removed, tilt the seatback rearward slightly. Refer to “To adjust the seatbacks” on page 4-5.
- To remove the head restraint from the left or right rear seat, tilt the seatback forward to a position where the head restraint will not contact the headliner. Refer to “Rear seats” on page 4-6.

To install

📖 NOTE

- Before installing the head restraint to the left or right rear seat, tilt the seatback forward to a position where the head restraint will not contact the headliner. Refer to “Rear seats” on page 4-6.

First check that the head restraint stalk with the notches (B) is positioned toward the hole with the lock knob (A), and then insert the head restraint into the seatback.

And then insert it into the seatback. Push the head restraint down while pressing the lock knob (A) until the restraint locks into place.

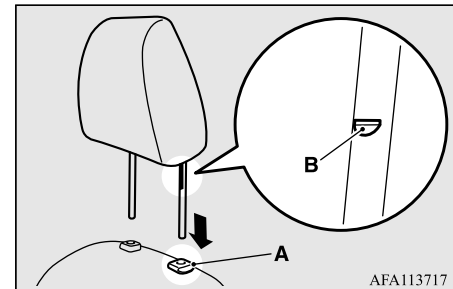

⚠ CAUTION

- Check that the lock knob (A) is extended out as shown in the illustration. Then pull the head restraint up to make sure that it is locked in place and will not come out of the seatback.

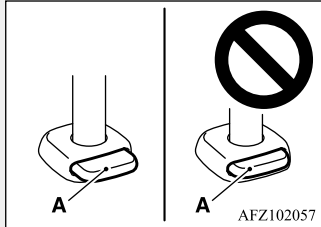

- The shape and size of the head restraint differs according to the seat. Always use the correct head restraint provided for the seat and do not install the head restraint in the wrong direction.

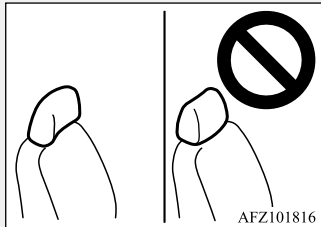

Making a cargo area

N00405501131

⚠ WARNING

- Never adjust the seats to make a cargo area when the vehicle is in motion or on a slope. The seats could move more than necessary or move suddenly causing a serious accident and/or injury.
- When returning a seatback to its seating position after folding down, make sure that the seat is firmly secured. If the seat is not secured, it could move causing a serious accident.
- Do not allow anyone to ride in the cargo area while the vehicle is in motion. People who are not properly seated and restrained can be seriously injured or killed in an accident.

⚠ CAUTION

- In the cargo area, do not load the luggage higher than the top of the seats and make sure that the luggage is firmly secured. Restricted rear vision or flying objects entering the passenger compartment during sudden braking could result in a serious accident and/or injury.
- Seats should always be operated by an adult. Seat adjustments by a child could lead to an unexpected accident.

⚠ CAUTION

- When adjusting the seats, be careful not to catch your hand or leg. Personal injury could result.

📖 NOTE

- When the seatback of a front seat is reclined, return it to the upright position before driving.

Folding the rear seatbacks forward

N00405701191

The rear seatbacks can be folded forward to create an additional cargo area.

📖 NOTE

- You can separately fold the right and left side of the rear seat.

To fold the seatbacks

1. When folding the left side rear seat, store the seat belt for the center seating position of the rear seat. Refer to “Detachable rear center seat belt” on page 4-15.

Seat belts

2. Lower the head restraints of the rear seat to the lowest position.
Refer to “Head restraints” on page 4-8.
3. Push the buckles into the seat cushion.

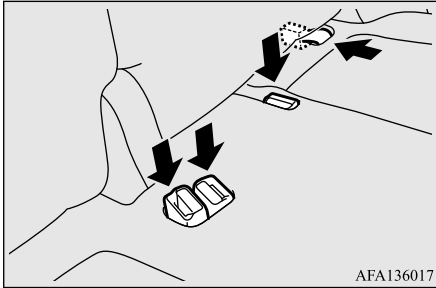

4. Pull up the lever (A), then fold the seat-back forward.

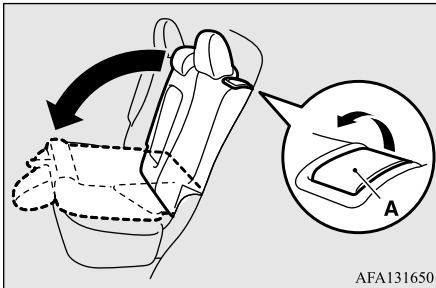

To return the seatbacks

1. Tilt the seatback up until it is locked properly in position.
2. Make sure the seatback is locked securely in place.

Seat belts

N00406001579

Seat belts are installed in your vehicle to help reduce the risk of injury to the driver and passenger in the event of an accident. Always use the provided seat belts. Carefully review the following information for proper seat belt usage.

⚠ WARNING

- To help reduce the risk of injury or death in an accident, seat belts and child restraint systems must always be used. Refer to “Child restraint systems” on page 4-21 for additional information.
- Never use one seat belt for more than one person.
- Never carry more people in your vehicle than there are seat belts.
- Always adjust the seat belt for a snug fit.
- Always place the shoulder belt over your shoulder and across your chest. Never put it behind you or under your arm.
- Always wear the lap belt as low as possible across your hips, not around your waist.

⚠ WARNING

- Never insert any foreign object, such as a piece of plastic, paper clip, button or coin, into the seat belt buckle.

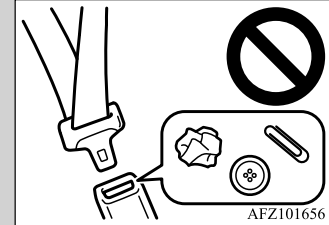

- Never modify or alter the seat belts in your vehicle.
- To reduce the risk to the driver of serious injury or death during deployment of the driver’s airbag, always properly wear the seat belt and adjust the driver’s seat as far back as possible while maintaining a position that still enables you to fully apply the pedals, easily control the steering wheel, and safely operate the vehicle.
- To reduce the risk to a front seat passenger of serious injury or death from a deploying airbag, make sure the passenger always wears the seat belt properly, remains seated all the way back and upright in their seat, and moves the seat as far back as possible. Refer to “Supplemental Restraint System (SRS) - airbag” on page 4-31 for additional information.

⚠ WARNING

- Never hold an infant or child in your arms or on your lap when riding in this vehicle even when you are wearing your seat belt. Never place any part of the seat belt you are wearing around an infant or child. Failure to follow these simple instructions creates a risk of serious injury or death to your child in the event of an accident or sudden stop.
- Children 12 years old and under should always ride in the rear seat and be properly restrained. This reduces their risk of serious injury or death in an accident, especially due to a deploying front passenger's airbag. Refer to "Child restraint systems" on page 4-21 for additional information.
- Any child who is too small to properly wear a seat belt must be properly restrained in an appropriate child restraint system.
- Infants MUST be placed in a rear-facing child safety seat and positioned in the rear seat.
- In the event of an accident, all seat belt assemblies, including retractors and attachment hardware, should be inspected by an authorized Mitsubishi Motors dealer to determine whether replacement is necessary.

⚠ WARNING

- Do not let children play with the seat belts. If children play with the seat belts by wrapping them around their bodies, the seat belt may retract and become tight. This can result in a serious injury or death, such as suffocation. This can occur even if the vehicle is parked. If the child cannot be released from the seat belt, use an appropriate tool such as a knife or scissors to cut the seat belt.

Seat belt instructions

N00406201555

All seats are equipped with a seat belt which uses one combined lap-and-shoulder belt with an emergency locking retractor.

This system is designed to provide both comfort and safety. It permits full extension and automatic retraction of the belts during normal vehicle operation. A sensing device inside the belt retractor is designed to lock the retractor in the event of a sudden change in the vehicle's motion.

📖 NOTE

- For instructions on installing a child restraint system using a seat belt, refer to "Installing a child restraint system using the seat belt" on page 4-27.

1. When using the rear seat belts, pull out the buckles from the seat cushion.

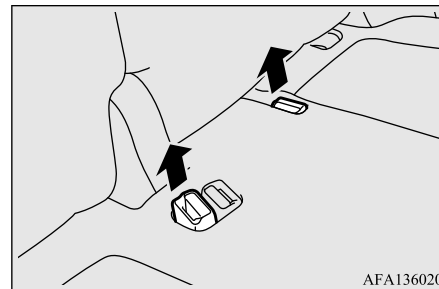

2. Occupants should always sit back in their seats with their backs against the upright seatback. To reduce the risk of serious injury or death during deployment of the airbag, adjust the driver's seat as far back as possible while maintaining a position that still enables you to fully apply the pedals, easily control the steering wheel, and safely operate the vehicle. The front passenger seat should also be moved as far back as possible. Refer to "Supplemental Restraint System (SRS) - airbag" on page 4-31. Also refer to "To adjust the seat forward or backward" on page 4-4.

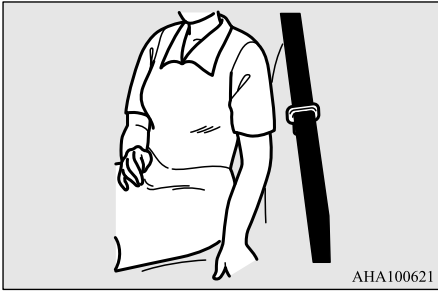

⚠ WARNING

- To reduce the risk of serious injury or death in the event of an accident or sudden stop, all seatbacks should be kept in the upright position while the vehicle is in motion.

Seat belt performance during an accident can be adversely affected if the seatbacks are reclined. The more a seatback is reclined, the more likely seat belt performance will be adversely affected. If the seat belt is not properly positioned against the body during an accident, there is increased risk you will slide under the belt and receive serious injury or death.

3. Before using the rear center seat belt, make sure that the detachable anchor is securely latched and the seat belt is not twisted. For details, refer to page 4-15.

4. Grasp the latch plate and slide it up the webbing so that it easily pulls across your body.



5. Pull the seat belt out slowly while holding the latch plate. Push the latch plate into the buckle until you hear a “click”. Pull up on the belt to be sure the latch plate is locked securely in the buckle.

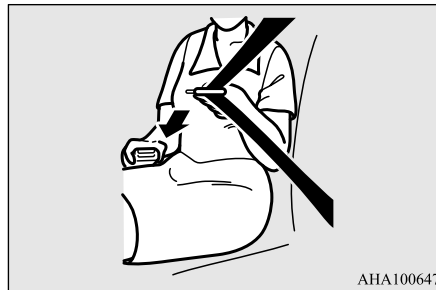

NOTE

- If the seat belt locks up and cannot be pulled out, pull it once with force and let it retract all the way. Then, pull the belt out slowly once again.

6. The lap part of the belt must always be worn low and snug across the hips. Pull up on the shoulder portion of the belt to take up any slack in the lap belt.



NOTE

- With the exception of the seat belt for the driver, the seat belts in all other seating positions are equipped with an Automatic Locking Retractor (ALR) function. If you pull the seat belt fully out of the retractor, the retractor will switch to its ALR child restraint installation function (see page 4-27).
When the ALR function has been activated, the seat belt will only retract. If this happens, let the belt fully retract, then pull the seat belt back out, repeating steps 1 through 4.

WARNING

- Be sure the lap belt portion fits snugly and is worn as low as possible across the hips, not around the waist. Failure to follow this instruction will increase the risk of serious injury or death in the event of an accident.
- Be sure the seat belt webbing is not twisted when worn. Twisted webbing may adversely affect seat belt performance.

7. To release the belt, press the button on the buckle and allow the belt to retract.
If the belt does not retract smoothly, pull it out and check for kinks or twists in the webbing. Then make sure it remains untwisted as it retracts.

NOTE

- If the seat belt (A) or ring (B) becomes dirty, the belt may not retract smoothly. If the seat belt and ring are dirty, clean them with a mild soap or detergent solution.

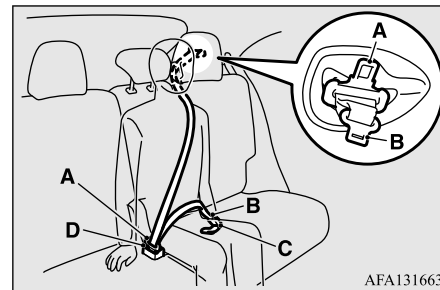
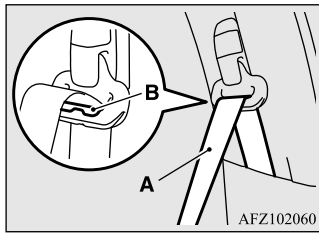

WARNING

- Never detach the center seat belt except when the left side rear seatback is folded. Using the rear center seat belt with the detachable anchor unlatched increases the risk of serious injury or death in an accident. Make sure the small latch plate (B) is properly latched to the detachable anchor (C) before the center seat belt is used.

Detachable rear center seat belt

N00409900110

The rear center seat belt can be detached to fold the left side rear seat. This seat belt must be worn correctly as illustrated.

To attach

1. Pull out the detachable anchor (C) and the buckle (D) from the seat cushion.

Seat belts

4

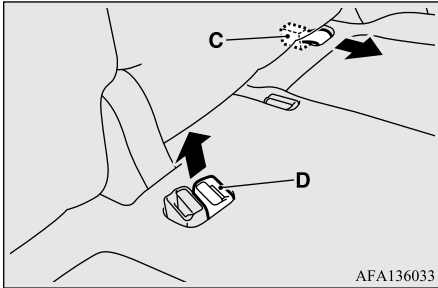

2. Pull out the latch plate (A) and then pull out the small latch plate (B) by tilting it as shown in the illustration.

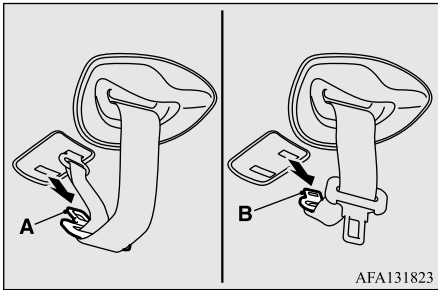

NOTE

- Pulling out the latch plate by force may damage the interior trim.

3. Pull the seat belt out slowly and pass it through the seat belt guide (E) so that the latch plate (A) is turned to the front side.

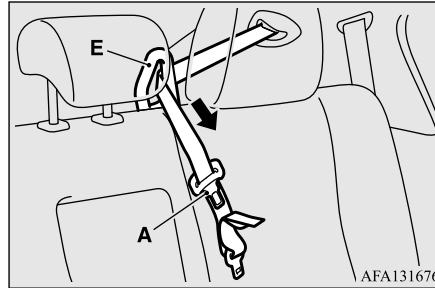

4. Pull the small latch plate (B) slowly and insert it into the detachable anchor (C) until a click is heard. Make sure that the seat belt is not twisted.

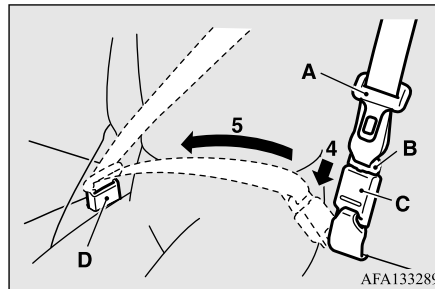

NOTE

- If the seat belt locks up and cannot be pulled out, pull it once with force and let it retract all the way. Then, pull the belt out slowly once again.
- The seat belt can be buckled up by inserting the latch plate (A) into the buckle (D) like other seat belts.
- If the seat belt switches to the Automatic Locking Retractor (ALR) child restraint installation function and cannot be pulled out, detach the latch plate (A). Refer to “Installing a child restraint system using the seat belt (with emergency/automatic locking mechanism)” on page 4-27.

To detach

1. While holding the center seat belt, insert the latch plate (A) into the slot (F) in the detachable anchor (C) to release the seat belt from the detachable anchor.

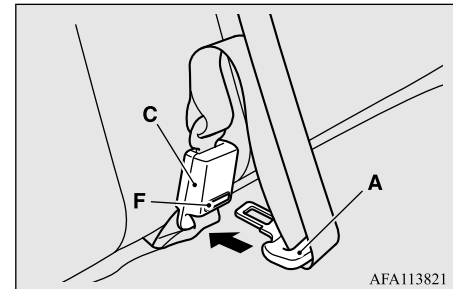

2. Pass the seat belt through the seat belt guide (E) and retract it completely toward the rear trim.

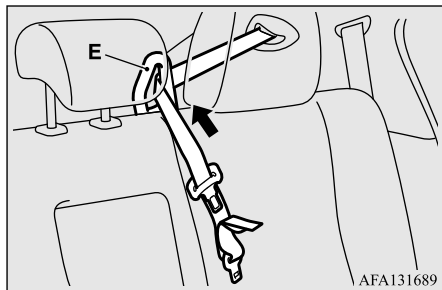

3. After the seat belt is retracted completely, insert the small latch plate (B) into the upper slit (G) and the latch plate (A) into the lower slit (H).

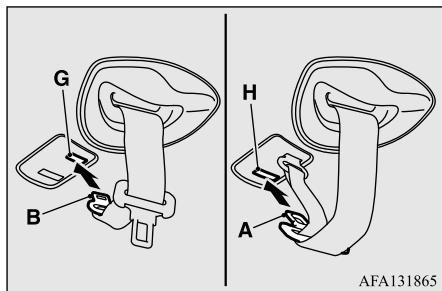

4. Store the detachable anchor between the seatback and the seat cushion.

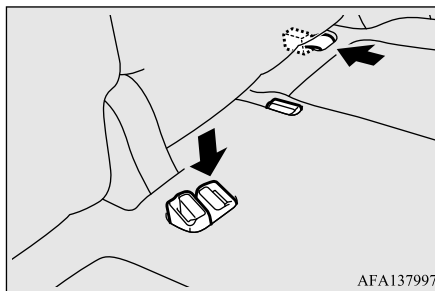

Driver's seat belt reminder/warning light and display

N00418401482

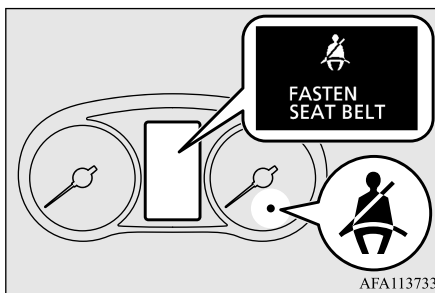

A tone and warning light are used to remind the driver to fasten the seat belt. If the ignition switch is turned to the "ON" position or the operation mode is put in ON

without the driver's seat belt being fastened, a warning light will come on and a tone will sound for approximately 6 seconds to remind you to fasten your seat belt.

If the vehicle is driven with the seat belt still unfastened, the warning light will blink and the tone will sound intermittently for approximately 90 seconds. At the same time, "FASTEN SEAT BELT" is displayed on the information screen in the multi-information display.

WARNING

- In order to reduce the risk of serious injury or death in an accident, always fasten your own seat belt. Do not allow anyone to ride in your vehicle unless he or she is also seated and fastening a seat belt. Children should additionally be restrained in a secure child restraint system.

NOTE

- If the seat belt subsequently remains unfastened, the warning light and the tone will issue further warnings each time the vehicle starts moving from a stop.

Front passenger seat belt warning light

N00418301276

The front passenger seat belt warning light is located in the instrument panel.

4

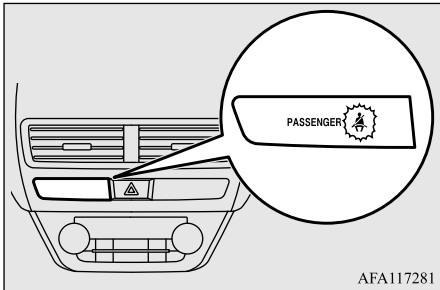

When the ignition switch is turned to the "ON" position or the operation mode is put in ON, this indicator normally comes on and goes off a few seconds later.

The light comes on when a person sits on the front passenger seat but does not fasten the seat belt. It goes off when the seat belt is subsequently fastened.

⚠ WARNING

- When a child booster seat is used on the front passenger seat, the front passenger seat belt warning light will not come on, if the seat belt is not fastened when the booster seat is used. Confirm that the child is wearing the seat belt properly.
- Do not install any accessory or sticker that makes the light difficult to see.

Adjustable seat belt shoulder anchor (front seats)

N00406301367

The seat belt shoulder anchor height can be adjusted. To move the anchor (A), pull the lock knob (B) and slide the anchor to the desired position.

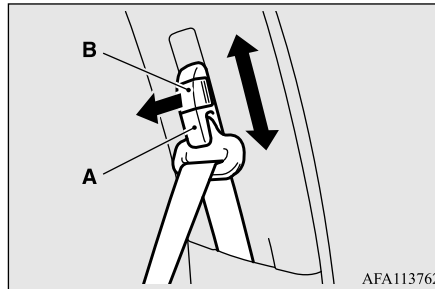

⚠ WARNING

- Always adjust the shoulder belt anchor so that the shoulder belt is positioned across the center of your shoulder without touching your neck. The shoulder belt should not be able to fall off your shoulder. Failure to follow this instruction can adversely affect seat belt performance and increase the risk of serious injury or death in the event of an accident.
- Adjust the shoulder belt anchor only when the vehicle is not in motion.
- Make sure the anchor is securely locked in position after adjusting it.

Storing the rear seat belts (outboard seating positions)

N00406501167

When the seat belts for the rear outboard seating positions are not used, the seat belts can be stored.

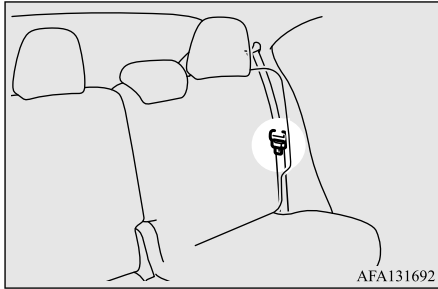

Put the seat belt webbing in the back slot (A) on the clip and insert the metal plate of the latch plate into the front slot (B) as shown in the illustration.

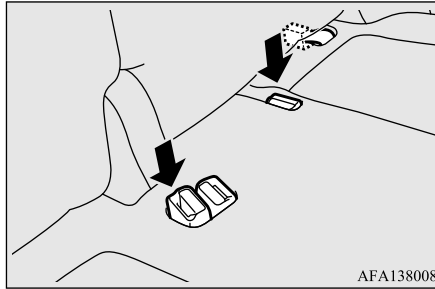

Seat belt extender

N00406701202

If your seat belt is not long enough, even when fully extended, a seat belt extender must be obtained. The extender may be used for either of the front seats.

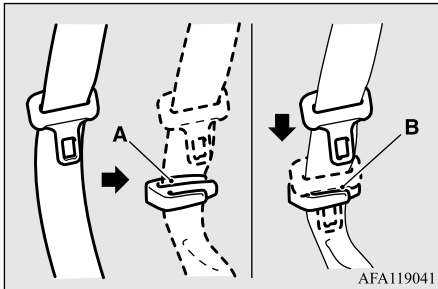

When the seat belt is not in use, store it as shown in the illustration.

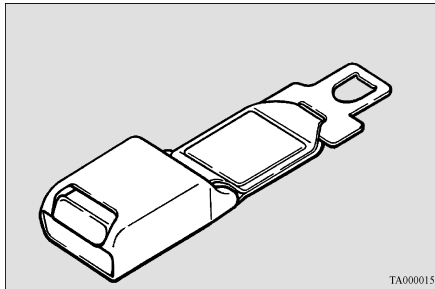

WARNING

- The extender should only be used if the existing belt is not long enough. Anyone who can use the standard seat belt should not use an extender. Unnecessary use of an extender can adversely affect seat belt performance in an accident.
- When not required, the extender must be removed and stowed.

Seat belt use during pregnancy

N00406800134

Seat belts work for everyone, including pregnant women. Like all occupants, pregnant women are more likely to be seriously injured or killed in an accident if they do not wear seat belts.

WARNING

- To reduce the risk of serious injury or death to pregnant women and unborn children in an accident, pregnant women should always wear a seat belt. The lap portion of the seat belt should be worn snug and low across the hips and below the rounding. Consult your doctor if you have any additional questions or concerns.

Seat belt pre-tensioner and force limiter systems

N00417701765

The driver's and front passenger's seats each have a seat belt equipped with a pre-tensioner system and force limiter system.

4

Pre-tensioner system

The driver and front passenger seat belts are equipped with a seat belt pre-tensioner system. In a moderate-to-severe frontal or side collision or when a rollover or overturning of the vehicle is detected, the pre-tensioner system operates simultaneously with the deployment of the front airbags, side airbags or curtain airbags.

The seat belt pre-tensioners are located in the driver's and front passenger's seat belt retractors (A) and final anchor (B). When activated, the pre-tensioners quickly draw back seat belt webbing and increase seat belt performance.

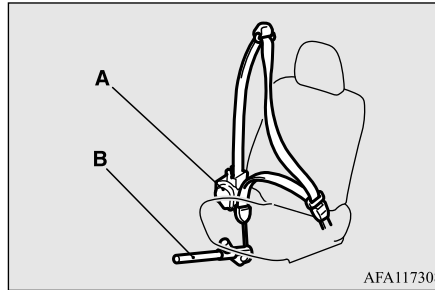

The seat belt pre-tensioner system includes the following components:

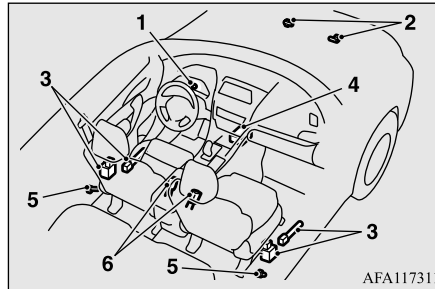

- 1- SRS warning light
- 2- Front impact sensors
- 3- Seat belt pre-tensioner
- 4- Airbag control unit
- 5- Side impact sensors
- 6- Seat belt buckle switches

The airbag control unit monitors the readiness of the electronic parts of the system whenever the ignition switch or the operation mode is under the following conditions. These include all of the items listed above and all related wiring.

[Except for vehicles equipped with the F.A.S.T.-key]

The ignition switch is in the "ON" or "START" position.

[Vehicles equipped with the F.A.S.T.-key]

The operation mode is in ON.

The seat belt pre-tensioners will operate under the same conditions as the airbag control unit.

When the seat belt pre-tensioners activate, some smoke is released and a loud noise will be heard. The smoke is not harmful, but care should be taken not to intentionally inhale it, as it may cause some temporary irritation to people with respiratory problems.

Even in the event of a severe impact, the pre-tensioners will not operate if the seat belts are not fastened. The seat belt pre-tensioners may not activate in certain collisions, even though the vehicle may appear to be severely damaged. Such non-activation does not mean that something is wrong with the seat belt pre-tensioner system, but rather that the collision forces were not severe enough to activate the system.

⚠ WARNING

- **The seat belt pre-tensioner system is designed to work only once. After the seat belt pre-tensioners have been activated, they will not work again. They must promptly be replaced and the entire seat belt pre-tensioner system inspected by an authorized Mitsubishi Motors dealer.**

SRS warning

N00408701147

This warning light tells you if there is a problem involving the SRS airbags and/or the seat belt pre-tensioner system. Refer to “SRS warning light/display” on page 4-37.

Force limiter system

N00408901152

In the event of an accident, the seat belt force limiter system will help reduce the force applied to the driver and front seat passenger.

Child restraint systems

N00407101971

When transporting infants or small children in your vehicle, an appropriate child restraint system must always be used. This is required by law in the U.S. and Canada.

Child restraint systems specifically designed for infants and small children are offered by several manufacturers. Choose only a child restraint system with a label certifying that it complies with Federal Motor Vehicle Safety Standard 213 (FMVSS 213) or Motor Vehicle Restraint Systems and Booster Seats Safety Regulations (RSSR). Look for the manufacturer’s statement of compliance on the box and child restraint system itself.

The child restraint system should be appropriate for your child’s weight and height, and should properly fit your vehicle’s seat. For detailed information, refer to the instruction manual accompanying the child restraint system.

Recommendations for child restraint system selection

All children should be properly restrained in a restraint device that offers the maximum protection for their size and age as specified by local, state, or provincial laws. Be sure to check local, state, or provincial requirements for child size and age that may vary from the recommendations listed below.

- Children less than 2 years old and who weigh 40 pounds (18 kg) or less **MUST** ride in a rear-facing child safety seat that **MUST ONLY** be used in the rear seat.
- Children older than 2 years of age and who weigh less than 60 pounds (27 kg) or who are less than 57 inches (145 cm) tall must be in an appropriate child restraint system used only in the rear seat.
- Children who weigh more than 60 pounds (27 kg) or who are more than 57 inches (145 cm) tall, regardless of age, should use a suitable child seat or a booster seat in the rear seat until the vehicle’s lap-and-shoulder belt fits them properly.

⚠ WARNING

- **All children must be seated in the rear seat, and properly restrained. Accident statistics show that children of all sizes and ages are safer when properly restrained in the rear seat, rather than in the front seat.**
- **Be sure to select a child restraint system that is appropriate not only for the child’s size and age but also for your vehicle. Some child restraint systems may not fit your vehicle properly.**

⚠ WARNING

- Any child who is too large to use a child restraint system should ride in the rear seat and wear the lap-and-shoulder belt properly. The shoulder belt must be positioned over the shoulder and across the chest, not across their neck, and with the lap belt positioned low on the child's hips, not across their stomach. If necessary, a booster seat should be used to help achieve a proper seat belt fit. Follow the booster seat manufacturer's instructions. Only use a booster seat that is certified as complying with Federal Motor Vehicle Safety Standards or Motor Vehicle Restraint Systems and Booster Seats Safety Regulations.
- Never hold an infant or child in your arms or on your lap when riding in this vehicle, even when you are wearing your seat belt. Never place any part of the seat belt you are wearing around an infant or child. Failure to follow these simple instructions creates a risk of serious injury or death to your child in the event of an accident or sudden stop.



⚠ WARNING

- Your vehicle is also equipped with a front passenger's airbag. Never put REAR-FACING CHILD RESTRAINT SYSTEMS or INFANT RESTRAINT SYSTEMS in the front passenger seat. This places the infant too close to the passenger's airbag. During deployment of that airbag, the infant can be seriously injured or killed. Rear-facing child restraint systems or infant restraint systems must only be used in the rear seat.

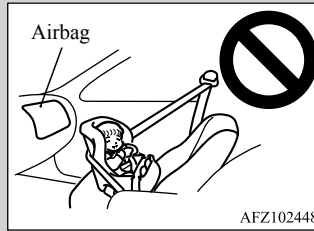

⚠ WARNING

- FRONT-FACING CHILD RESTRAINT SYSTEMS should be used in the rear seat whenever possible. If one must be used in the front passenger seat, move the seat to the most rearward position and make sure the child stays in the child restraint system, properly restrained. Also, adjust the seat height to the lowermost position when the seat height is adjustable (if so equipped). Failure to follow these instructions could result in serious injury or death to the child.



- It is important to use an approved rear-facing infant restraint until the infant is one year old (unless the infant outgrows the seat sooner). This allows the infant's neck and spine to develop enough to support the weight of their head in the event of an accident.

⚠ WARNING

- When installing a child restraint system, follow the instructions provided by the manufacturer and follow the directions in this manual. Failure to do so can result in serious injury or death to your child in an accident or sudden stop.
- After installation, push and pull the child restraint system back and forth, and side to side, to see that it is firmly secured. If the child restraint system is not installed securely, it may cause injury to the child or other occupants in the event of an accident or sudden stop.
- When not in use, keep your child restraint system secured with the seat belt, or remove it from the vehicle, in order to prevent it from being thrown around inside the vehicle during an accident.
- When attaching a child restraint system to the rear seat, prevent the front seatbacks from touching the child's feet and child restraint system. Otherwise, the child could be seriously injured in the event of hard braking or a collision.

📖 NOTE

- Before purchasing a child restraint system, try installing it in the rear seat to ensure proper fit. Due to the location of the seat belt buckles and the shape of the seat cushion, it may be difficult to securely install some manufacturer's child restraint systems. If the child restraint system can be pulled forward or to either side easily on the seat cushion after the seat belt has been tightened, choose another manufacturer's child restraint system. Depending on the seating position in the vehicle and the child restraint system that you have, the child restraint system can be attached using one of the following 2 methods:
 - Attach to the lower anchorage in the rear seat **ONLY** if the child restraint system is compatible with the LATCH system. Refer to "Installing a child restraint system using the LATCH (Lower Anchors and Tethers for children) system" on page 4-23.
 - Attach to the seat belt. Refer to "Installing a child restraint system using the seat belt (with emergency/automatic locking mechanism)" on page 4-27.

Installing a child restraint system using the LATCH (Lower Anchors and Tethers for children) system

N00418801200

4

Lower anchor locations

The outboard seating positions in the rear seat of your vehicle are equipped with lower anchors for attaching child restraint systems compatible with the LATCH system.

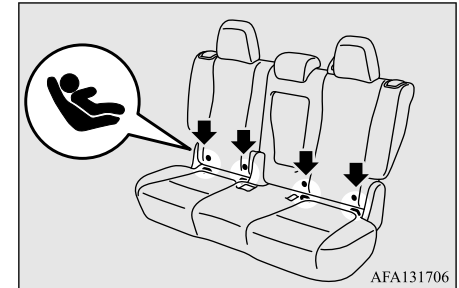
**📖 NOTE**

- The symbols on the seatback show the location of the lower anchor points.

Tether anchor locations

N00418901269

Your vehicle has 3 attachment points on the backside of the rear seats. These are for securing a child restraint system tether strap to each of the 3 rear seating positions in your vehicle.

4

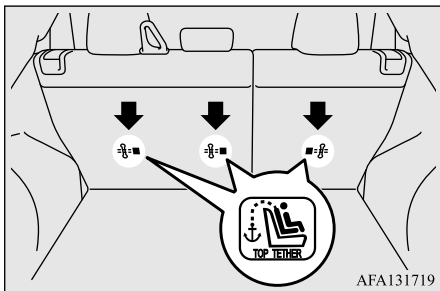

Examples of child restraint systems compatible with the LATCH system

N00419001212

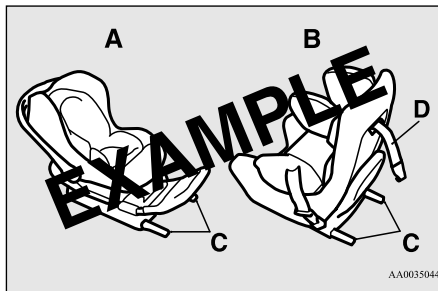

- A- Rear-facing child restraint system
 - B- Front-facing child restraint system
 - C- Child restraint system lower anchor connectors
 - D- Tether strap
- (These are only examples.)

CAUTION

- Do not sit in the center seating position of the rear seat when installing a child restraint system on the left side of the rear seat.

Using the LATCH system

N00419101372

Except for booster seat

1. In order to securely fasten the tether strap, remove the head restraint from the location where you wish to install the child restraint system.
Refer to “Head restraints” on page 4-8.
2. Push the anchor connectors (A) on the child restraint system into the lower anchors (B) in accordance with the instructions provided by the child restraint system’s manufacturer.

Remember, the lower anchors (B) provided with your vehicle are designed to secure suitable child restraint systems compatible with the LATCH system in the outboard positions of the rear seats only. The anchor connectors are NOT designed to secure a suitable child restraint system in the center seating position of the rear seat.

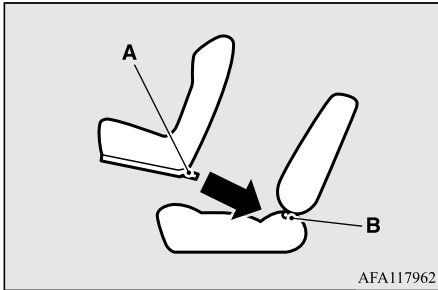

A- Connector

B- Lower anchor

NOTE

- In order to secure a child restraint system compatible with the LATCH system, use the lower anchor points in the outboard positions of the rear seat. It is not necessary to use the vehicle's seat belt. The vehicle's seat belt, however, **MUST** be used to secure a child restraint system in the center seating position of the rear seat.

WARNING

- If there is any foreign material in or around the lower anchors, remove it before installing the child restraint system. Also, make sure the seat belt is away from, not looped through or otherwise interfering with, the child restraint system. If foreign matter is not removed and/or the seat belt interferes with the child restraint system, the child restraint system will not be secured properly, could detach and move forward in the event of sudden braking or an accident, and could result in injury to the child or other vehicle occupants.
- When the vehicle is moving, do not adjust the seat where the child restraint system is installed.

3. Latch the tether strap hook (C) of the child restraint system to the tether anchor bar (D) and tighten the tether strap so it is securely fastened.

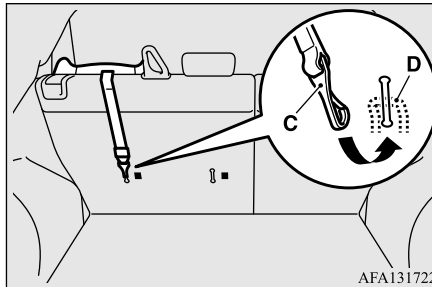

WARNING

- Child restraint system tether anchors are designed only to withstand loads from correctly fitted child restraint systems. Under no circumstances are they to be used for adult seat belts, harnesses, for attaching other items, or equipment to the vehicle.

4. Before putting your child in the restraint, push and pull the restraint in all directions to be sure it is firmly secure. Do this before each use. If the child restraint system is not firmly secure, repeat steps 2 and 3.

CAUTION

- After removing the child restraint system, install the head restraint.

Booster seat

4

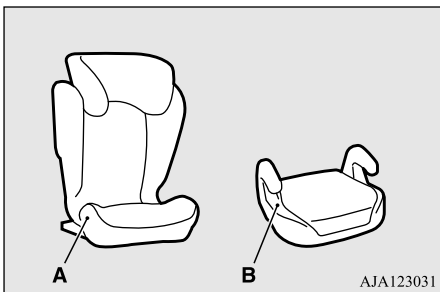

A- High back booster seat
B- Booster cushion

WARNING

- To avoid injury to child, do not use the lap/shoulder belt Automatic Locking Retractor (ALR) child restraint installation function when using a booster seat with the seat belts.

High back booster seat

1. In order to securely fasten the tether strap, remove the head restraint from the location where you wish to install the high back booster seat.
Refer to “Head restraints” on page 4-8.

2. Push the anchor connectors (A) on the high back booster seat into the lower anchors (B) in accordance with the instructions provided by the child restraint system’s manufacturer.

Remember, the lower anchors (B) provided with your vehicle are designed to secure suitable high back booster seats compatible with the LATCH system in the outboard positions of the rear seats only. The anchor connectors are NOT designed to secure a suitable high back booster seat in the center seating position of the rear seat.

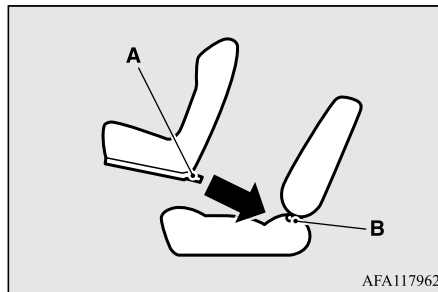

A- Connector
B- Lower anchor

WARNING

- If there is any foreign material in or around the lower anchors, remove it before installing the high back booster seat. Also, make sure the seat belt is away from, not looped through or otherwise interfering with, the high back booster seat. If foreign matter is not removed and/or the seat belt interferes with the high back booster seat, the high back booster seat will not be secured properly, could detach and move forward in the event of sudden braking or an accident, and could result in injury to the child or other vehicle occupants.
- When the vehicle is moving, do not adjust the seat where the high back booster seat is installed.

3. Latch the tether strap hook (C) of the high back booster seat to the tether anchor bar (D) and tighten the tether strap so it is securely fastened.

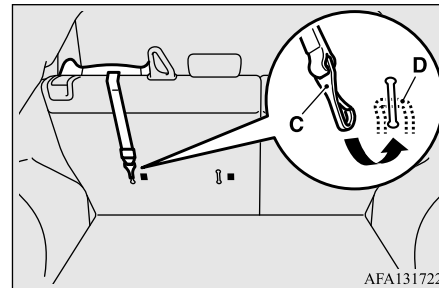

⚠ WARNING

- Child restraint system tether anchors are designed only to withstand loads from correctly fitted child restraint systems. Under no circumstances are they to be used for adult seat belts, harnesses, for attaching other items, or equipment to the vehicle.

4. Before putting your child in the restraint, push and pull the high back booster seat in all directions to be sure it is firmly secure. Do this before each use. If the high back booster seat is not firmly secure, repeat steps 2 and 3.
5. Sit the child in the high back booster seat. Fit the seat belt to the high back booster seat according to the child restraint system's manufacturer.

⚠ CAUTION

- After removing the high back booster seat, install the head restraint.

■ Booster cushion**⚠ CAUTION**

- Do not remove the head restraint when installing a booster cushion.

1. Push the anchor connectors (A) on the booster cushion into the lower anchors (B) in accordance with the instructions provided by the child restraint system's manufacturer.

Remember, the lower anchors (B) provided with your vehicle are designed to secure suitable booster cushions compatible with the LATCH system in the outboard positions of the rear seats only. The anchor connectors are NOT designed to secure a suitable booster cushion in the center seating position of the rear seat.

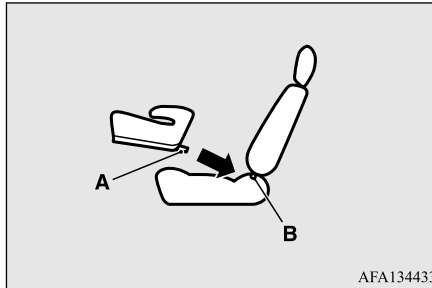

- A- Connector
B- Lower anchor

⚠ WARNING

- If there is any foreign material in or around the lower anchors, remove it before installing the booster cushion. Also, make sure the seat belt is away from, not looped through or otherwise interfering with, the booster cushion. If foreign matter is not removed and/or the seat belt interferes with the booster cushion, the booster cushion will not be secured properly, could detach and move forward in the event of sudden braking or an accident, and could result in injury to the child or other vehicle occupants.
- When the vehicle is moving, do not adjust the seat where the booster cushion is installed.

2. Sit the child in the booster cushion. Fit the seat belt to the booster cushion according to the child restraint system's manufacturer.

Installing a child restraint system using the seat belt (with emergency/automatic locking mechanism)

N00407301638

With the exception of the driver, the seat belt in all other seating positions can be converted from normal Emergency Locking Retractor

(ELR) mode, to Automatic Locking Retractor (ALR) mode. This means that when you pull the seat belt fully out of the retractor, the retractor will switch to its ALR child restraint installation function. Always use the ALR child restraint installation function when you install a child restraint system using the seat belt.

Children 12 years old and under should always be restrained in the rear seat, whenever possible, although the front passenger seat belt can also be converted to ALR mode.

⚠ WARNING

- When you install a child restraint system using the seat belt, always make sure the retractor has been switched to the ALR child restraint installation function. The ALR function will keep the child restraint system tightly secured to the seat. Failure to convert the retractor to the ALR function may allow the child restraint system to move forward during sudden braking or an accident, resulting in serious injury or death to the child or other occupants.

⚠ CAUTION

- Do not sit in the center seating position of the rear seat when installing a child restraint system on the left side of the rear seat.

Installation

Except for booster seat

1. Remove the head restraint from the location in which you wish to install a child restraint system.
Refer to “Head restraints” on page 4-8.
2. When installing a child restraint system on the front passenger seat, adjust seat slide to its most rearward position. Also, adjust the seat height to its lowermost position when the seat height is adjustable (if so equipped).

3. Adjust the seatback of the seat where the child restraint system will be installed as follows.

[For front passenger’s seat]

Adjust the angle of the seatback to match the angle of the back of the child restraint system.

Refer to “To adjust the seatbacks” on page 4-5.

[For rear seats]

Adjust the seatback angle to four steps rearward from the most upright position.

Refer to “To adjust the seatbacks” on page 4-6.

4. Place the child restraint system on the seat.

5. Route the seat belt through the child restraint system according to the instructions provided by the child restraint system’s manufacturer. Then insert the seat belt latch plate into the buckle. Make sure you hear a “click” when you insert the latch plate into the buckle.

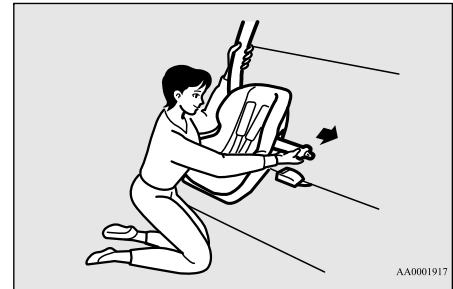

6. To activate the ALR child restraint installation function, slowly pull the shoulder part of the belt all the way out of the retractor until it stops. Then let the belt feed back into the retractor.

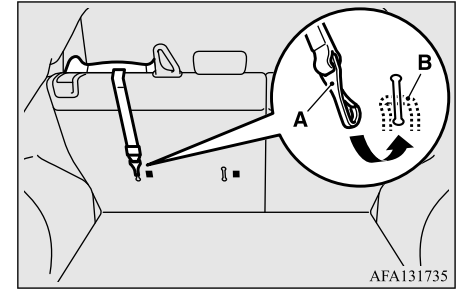
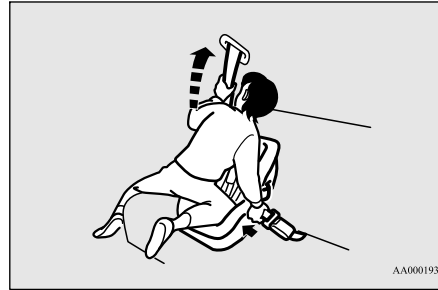
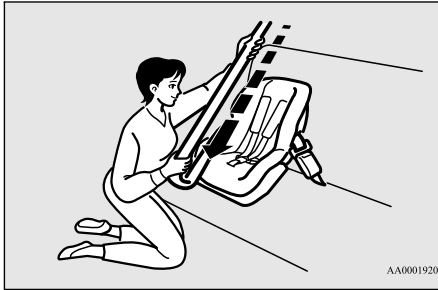

7. After the belt has retracted, tug on it.

If the belt is in the ALR function, you will not be able to pull it out. If the webbing can be pulled out from retractor, the ALR function has not been activated and you will need to repeat steps 6 and 7.

8. After confirming that the belt is locked, grab the shoulder part of the belt near the buckle and pull up to remove any slack from the lap part of the belt allowing the slack to feed into the retractor. Remember, if the lap belt portion is not tight, the child restraint system will not be secure. It may help to put your weight on the child restraint system and/or push on its seatback while pulling up on the belt (See illustration).

9. Push and pull the child restraint system in all directions to check that it is installed securely.

If the child restraint system is not installed securely, proceed to step 10.

10. [For front passenger's seat]
Repeat steps 8 and 9.

[For rear seats]

Adjust the seatback angle forward until the child restraint system is firmly secured, and then check that the seatback is locked in place. Then push and pull the child restraint system in all directions to check that it is installed securely.

If your child restraint system requires the use of a tether strap, fasten the tether strap in accordance with the following step 11.

11. Latch the tether strap hook (A) of the child restraint system to the tether anchor bar (B) and tighten the tether strap so it is securely fastened.

⚠ WARNING

- Child restraint system tether anchors are designed only to withstand loads from correctly fitted child restraint systems. Under no circumstances are they to be used for adult seat belts, harnesses, for attaching other items, or equipment to the vehicle.

12. Before putting your child in the restraint, push and pull the restraint in all directions to be sure it is firmly secure. Do this before each use. If the child restraint system is not firmly secure, repeat steps 4 through 11.

⚠ CAUTION

- After removing the child restraint system, be sure to perform the following actions.
 - Wind up the seat belt completely to deactivate the ALR mode.
 - Install the head restraint.

Booster seat

4

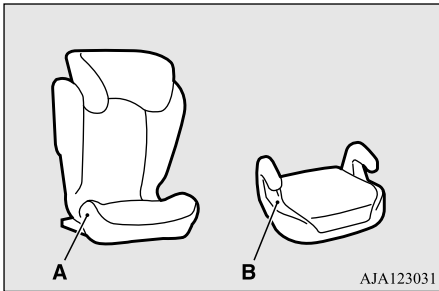

A- High back booster seat
B- Booster cushion

WARNING

● To avoid injury to child, do not use the lap/shoulder belt Automatic Locking Retractor (ALR) child restraint installation function when using a booster seat with the seat belts.

High back booster seat

1. Remove the head restraint from the location in which you wish to install a high back booster seat.
Refer to “Head restraints” on page 4-8.

2. When attaching a high back booster seat to the front passenger’s seat, adjust the front passenger seat to the most rearward position. Also, adjust the seat height to the lowermost position when the seat height is adjustable (if so equipped).
3. Place the high back booster seat on the seat.
4. If your high back booster seat requires the use of a tether strap, latch the tether strap hook (A) of the child restraint system to the tether anchor bar (B) and tighten the tether strap so it is securely fastened.

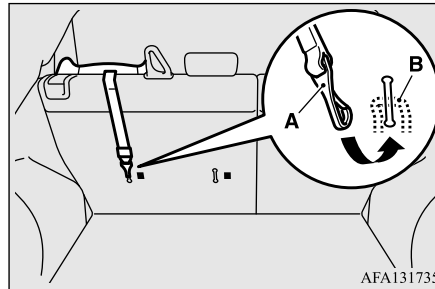

WARNING

● Child restraint system tether anchors are designed only to withstand loads from correctly fitted child restraint systems. Under no circumstances are they to be used for adult seat belts, harnesses, for attaching other items, or equipment to the vehicle.

5. Sit the child in the high back booster seat. Fit the seat belt to the high back booster seat according to the child restraint system’s manufacturer.

CAUTION

● After removing the high back booster seat, install the head restraint.

Booster cushion

CAUTION

● Do not remove the head restraint when installing a booster cushion.

1. When attaching a booster cushion to the front passenger’s seat, adjust the front passenger seat to the most rearward position. Also, adjust the seat height to the lowermost position when the seat height is adjustable (if so equipped).
2. Place the booster cushion on the seat.
3. Sit the child in the booster cushion. Fit the seat belt to the booster cushion according to the child restraint system’s manufacturer.

Children who have outgrown child restraint systems

N00407601628

Children who have outgrown a child restraint system should be seated in the rear seat and wear the seat belt. If the shoulder belt crosses their face or neck, and/or the lap belt crosses their stomach, a commercially available booster seat must be used to raise the child so that the shoulder belt crosses their shoulder and the lap belt remains positioned low across their hips. The booster seat should fit the vehicle seat and have a label certifying compliance with Federal Motor Vehicle Safety Standards or Motor Vehicle Restraint Systems and Booster Seats Safety Regulations.

WARNING

- Any child who is too small to properly wear a seat belt must be properly restrained in an appropriate child restraint system, to reduce their risk of serious injury or death in an accident.
- A child should never be left unattended in, or unsupervised around, your vehicle. When you leave the vehicle, always take the child out as well.
- Children can die from heat stroke if left or trapped inside the vehicle, especially on hot days.

WARNING

- Keep your vehicle locked when not in use. Keep your vehicle keys away from children.

Maintenance and inspection of seat belts

N00407001417

Regularly check your seat belt buckles and their release mechanisms for positive engagement and release of the latch plate. Check the retractors for automatic locking when in the Automatic Locking Retractor function.

The entire seat belt assembly should be replaced if the webbing shows any obvious cuts, tears, increase in thickness in any section of the webbing from broken fibers, or severe fading from sunlight. All of these conditions indicate a weakening of the belt, which may adversely affect seat belt performance in an accident.

WARNING

- Do not attempt to repair or replace any part of the seat belt assemblies. This work should be done by an authorized Mitsubishi Motors dealer. Failure to have an authorized Mitsubishi Motors dealer perform the work could reduce the effectiveness of the belts and could result in a serious injury or death in an accident.
- Never use an organic solvent to clean the seat belt webbing. Do not attempt to bleach or re-dye the seat belt webbing. These may weaken the seat belt webbing, increasing risk of injury or death in an accident.
Clean seat belt webbing only with mild soap or detergent solution and rinse it with lukewarm water, and dry the seat belt webbing completely before retracting it.

Supplemental Restraint System (SRS) - airbag

N00407701892

This vehicle is equipped with a Supplemental Restraint System (SRS), which includes airbags for the driver and passengers.

NOTE

- The SOS emergency assistance (if so equipped) is designed to operate when any of the airbags deploy or severe collision occurs. Refer to “Telematics Control Unit (TCU)” on page 3-5.

4

The SRS front airbags are designed to supplement the primary protection of the driver and front passenger seat belt systems by providing those occupants with protection against head and chest injuries in certain moderate to severe frontal collisions. The SRS front airbags, together with sensors at the front of the vehicle and sensors attached to the front seats, form an advanced airbag system.

The SRS driver’s knee airbag is designed to supplement the primary protection of the driver’s seat belt system. It can reduce the forward movement of the driver’s lower legs and provide increased overall body protection in certain moderate to severe frontal collisions.

The SRS side airbags and the curtain airbags are also designed to supplement the seat belts. The SRS side airbags provide the driver and front passenger with protection against chest injuries by deploying the bag on the side impacted in moderate to severe side impact collisions.

The SRS curtain airbags provide the driver and the passengers on the front seat and the rear outboard seats with protection against head injuries by deploying the curtain airbag on the side impacted in moderate to severe side impact collisions and by deploying both curtain airbags when a rollover is detected. The curtain airbags are also designed to help reduce the risk of complete and partial ejection from the vehicle through side windows in both side impact and rollover type accidents.

The SRS airbags are NOT a substitute for use of the seat belts. For maximum protection in all types of accidents, seat belts must ALWAYS be worn by everyone who drives or rides in this vehicle (with infants and small children in an appropriate child restraint system in the rear seat, and older children buckled in the rear seat). Refer to “Child restraint systems” on page 4-21.

WARNING

- **IT IS VERY IMPORTANT TO ALWAYS WEAR YOUR SEAT BELT PROPERLY EVEN WITH AN AIRBAG.**

WARNING

- **Seat belts help keep the driver and passengers properly positioned. This reduces the risk of injury in all collisions, and reduces the risk of serious injuries or death when the airbags inflate. During sudden braking just before a collision, an unrestrained or improperly restrained driver or front passenger can move forward into direct contact with, or within close proximity to, the airbag when it begins to inflate. The beginning stage of airbag inflation is the most forceful and can cause serious injuries or death if the occupant comes in contact with the airbag at this time.**
- **Seat belts reduce the risk of injury in rear impact collisions, and in lower-speed frontal collisions because the airbags are not designed to inflate in those situations.**
- **Seat belts reduce the risk of being thrown from your vehicle in a collision or rollover.**
- **IT IS VERY IMPORTANT TO BE PROPERLY SEATED.**
- **A driver or front passenger sitting too close to the steering wheel or instrument panel during airbag deployment can be seriously injured or killed.**

⚠ WARNING

- Airbags inflate very quickly and with great force. If the driver and front passenger are not properly seated and restrained, the airbag may not provide the proper protection, and can cause serious injuries or death when it inflates.
- To reduce the risk to the driver of serious injury or death due to a deploying driver's airbag, always properly wear your seat belt and adjust the driver's seat as far back as possible, maintaining a position that still allows the driver to have good control of the steering wheel, brake, accelerator, and other vehicle controls.
- To reduce the risk to the front passenger of serious injury or death from a deploying passenger's airbag, make sure the passenger always wears the seat belt properly, remains seated upright and all the way back in the seat, and positions the seat as far back as possible.
- Seat all infants and children in the rear seat, properly restrained in an appropriate child restraint system.
- Airbags inflate very quickly and with great force. Do not sit on the edge of the seat or sit with your lower legs too close to the instrument panel, or lean your head or chest close to the steering wheel or the instrument panel.

⚠ WARNING

- Do not put your feet or legs on or against the instrument panel.

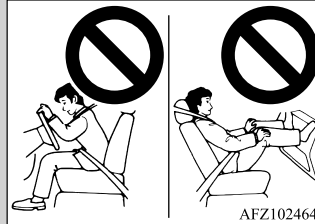

- Infants and small children should never ride unrestrained, or lean against the instrument panel. They should never ride held in your arms or on your lap. They can be seriously injured or killed in an accident, especially when the airbags inflate. Seat all infants and children in the rear seat, properly restrained in an appropriate child restraint system. Refer to "Child restraint systems" on page 4-21.

**⚠ WARNING**

- NEVER put REAR-FACING CHILD RESTRAINT SYSTEMS or INFANT RESTRAINT SYSTEMS in the front passenger seat. This places the infant too close to the passenger's airbag. During deployment of that airbag, the infant can be seriously injured or killed. Rear-facing child restraint systems or infant restraint systems must only be used in the rear seat.

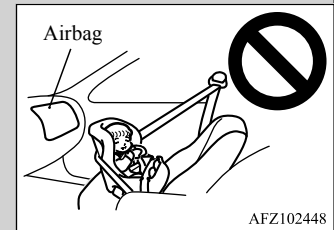

WARNING

● **FRONT-FACING CHILD RESTRAINT SYSTEMS** should be used in the rear seat whenever possible. If they must be used in the front passenger seat, move the seat to the most rearward position and make sure the child stays in the child restraint system, properly restrained. Failure to follow these instructions could result in serious injury or death to the child.

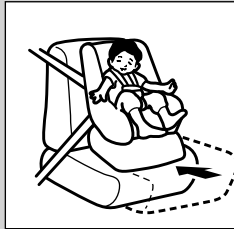

AFZ103168

● Older children should be seated in the rear seat with their seat belt properly worn, and with an appropriate booster seat if needed.

Refer to “Children who have outgrown child restraint systems” on page 4-31.

How the Supplemental Restraint System works

N00407801617

The SRS includes the following components:

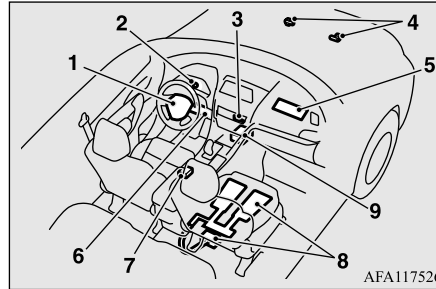

AFA117526

- 1- Airbag module (Driver)
- 2- SRS warning light
- 3- Passenger’s airbag off indicator
- 4- Front impact sensors
- 5- Airbag module (Passenger)
- 6- Airbag module (Driver’s knee)
- 7- Driver’s seat position sensor
- 8- Passenger’s seat occupant classification sensor system
- 9- Airbag control unit

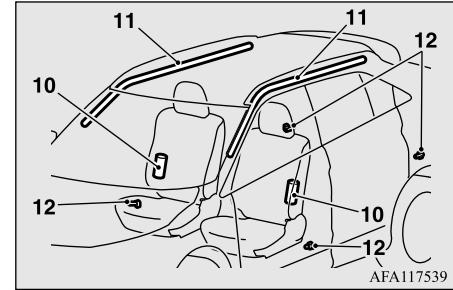

AFA117539

- 10- Side airbag modules
- 11- Curtain airbag modules
- 12- Side impact sensors

The airbag control unit monitors the readiness of the electronic parts of the system whenever the ignition switch or the operation mode is under the following conditions. These include all of the items listed above and all related wiring.

[Except for vehicles equipped with the F.A.S.T.-key]

The ignition switch is in the “ON” or “START” position.

[Vehicles equipped with the F.A.S.T.-key]

The operation mode is in ON.

The airbags will operate under the same conditions as the airbag control unit.

When the impact sensors detect a sufficient front or side impact to deploy the airbag(s), the appropriate airbag(s) will be deployed.

When the airbag control unit detects rollover of the vehicle, curtain airbags will be deployed.

When airbags deploy, some smoke is released accompanied by a loud noise. The smoke is not harmful, but do not intentionally inhale the smoke as it may cause temporary irritation to people with respiratory problems.

An inflated airbag will deflate quickly, so you may not even notice that the airbag was inflated.

Airbag inflation does not prevent the driver from seeing or being able to steer the vehicle, and does not prevent people from leaving the vehicle.

CAUTION

- Airbags inflate very quickly and with great force. In certain situations, contact with an inflating airbag may cause small cuts, abrasions, and bruises.

Driver's seat position sensor

N00417901259

The driver's seat position sensor is attached to the seat rail and provides the airbag control

unit with information on the seat's fore-aft position. The airbag control unit controls deployment of the driver's front airbag in accordance with the information it receives from this sensor.

If there is a problem involving the driver's seat position sensor, the SRS warning light in the instrument panel will come on. Refer to "SRS warning light/display" on page 4-37.

WARNING

- If the SRS warning light or warning display comes on, have the vehicle inspected by an authorized Mitsubishi Motors dealer immediately.
- Please observe the following instructions to ensure that the driver's seat position sensor can operate correctly.
 - Adjust the seat to the correct position, and sit well back against the seatback. Refer to "Front seats" on page 4-3.
 - Do not recline the seatback more than necessary when driving.
 - Do not place metallic objects or luggage under the front seat.
- If the vehicle is involved in a severe impact, have the SRS sensors inspected by an authorized Mitsubishi Motors dealer as soon as possible.

Passenger's seat occupant classification sensor system

N00418001374

The passenger's seat occupant classification sensor system is attached to the front passenger seat cushion and provides the airbag control unit with information regarding the occupant on the front passenger seat. The airbag control unit controls deployment of the passenger's front airbag in accordance with the information it receives from this system.

The passenger's front airbag will not deploy in an impact when the system senses no occupant on the front passenger's seat or a child in a child restraint system. In this case, the passenger airbag off indicator will come on.

Refer to "Passenger's airbag off indicator" on page 4-36.

If there is a problem involving the passenger's seat occupant classification sensor system, the SRS warning light in the instrument panel will come on. Refer to "SRS warning light/display" on page 4-37.

WARNING

- If any of the following conditions occur, you should immediately have your vehicle inspected by an authorized Mitsubishi Motors dealer as soon as possible:

⚠ WARNING

- The SRS warning light does not initially come on when the ignition switch or the operation mode is under the following conditions.
[Except for vehicles equipped with the F.A.S.T.-key]
The ignition switch is in the “ON” or “START” position.
[Vehicles equipped with the F.A.S.T.-key]
The operation mode is in ON.
- The SRS warning light does not go out after several seconds.
- The SRS warning light comes on while you are driving.
- To ensure that the passenger’s seat occupant classification sensor system can sense correctly, observe the following instructions. Failure to follow these instructions can adversely affect the performance of the passenger’s airbag system.
 - Adjust the seat to the correct position, and sit well back against the seatback. Refer to “Front seats” on page 4-3.
 - Do not recline the seatback more than necessary.
 - Never have more than one person (adult or child) sitting on the seat.
 - Do not place anything between the seat and the floor console.
 - When attaching a child restraint system, secure it firmly.
 - Do not place luggage or other objects on the seat.

⚠ WARNING

- Do not use a seat cover or a cushion.
- Do not modify or replace the seat and seat belt.
- Do not place luggage or other objects under the seat.
- Do not place and use an electronic device such as a computer on the seat.
- Do not place heavy objects on the seat or stick pins, needles, or other objects into it.
- Do not remove the seat cushion skin.
- If any liquid is spilled on the seat, wipe it and dry the seat immediately.
- If the vehicle is involved in a severe impact, have the SRS sensors inspected by an authorized Mitsubishi Motors dealer as soon as possible.

Passenger’s airbag off indicator

N00418101375

The passenger’s airbag off indicator is located in the instrument panel.

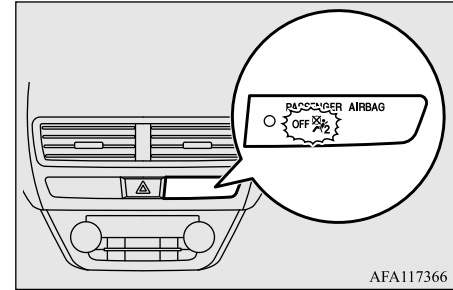

The indicator normally comes on when the ignition switch is turned to the “ON” position or the operation mode is put in ON, and goes out a few seconds later. In the following situations, the indicator will stay on to show that the passenger front airbag is not operational.

- The front passenger’s seat is not occupied.
- The system senses that a child is using a child restraint system on the front passenger’s seat.

When the passenger’s seat occupant classification sensor system sense there is a person seated in the front passenger’s seat, the indicator goes out to show that the passenger’s front airbag is operational.

⚠ WARNING

- If any of the following conditions occur, you should immediately have the airbag system in your vehicle inspected by an authorized Mitsubishi Motors dealer as soon as possible:
 - The passenger's airbag off indicator comes on when an adult is sitting on the front passenger seat.
 - The passenger's airbag off indicator does not come on when the front passenger seat is not occupied.
 - The passenger's airbag off indicator does not come on when the ignition switch is turned to the "ON" position or the operation mode is put in ON.
 - The passenger's airbag off indicator does not come on when a child is in a child restraint system on the front passenger's seat.
 - The passenger's airbag off indicator comes on and goes out repeatedly.
- Do not attach any accessory to your vehicle that makes the passenger's airbag off indicator difficult or impossible to see. You must be able to see the passenger's airbag off indicator and verify the status of the passenger's airbag system.

SRS warning light/display

N00408301710

There is a Supplemental Restraint System (SRS) warning light on the instrument panel.

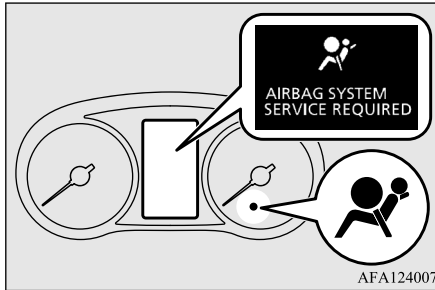

The system checks itself every time the ignition switch is turned to the "ON" position or the operation mode is put in ON. The SRS warning light will come on for several seconds and then go out. This is normal and means the system is working properly. If there is a problem involving one or more of the SRS components, the warning light will come on and stay on. At the same time, the warning display will appear on the information screen in the multi-information display. The SRS warning light/display is shared by the SRS airbag and the seat belt pre-tensioner system.

⚠ WARNING

- If any of the following conditions occur, there may be a problem with the SRS airbags and/or seat belt pre-tensioners, and they may not function properly in a collision or may suddenly activate without a collision:
 - Even when the ignition switch or the operation mode is in ON, the SRS warning light does not come on or it remains on.
 - The SRS warning light and/or the warning display comes on while driving.
- The SRS airbags and seat belt pre-tensioners are designed to help reduce the risk of serious injury or death in certain collisions. If either of the above conditions occurs, immediately have your vehicle checked by an authorized Mitsubishi Motors dealer.

📖 NOTE

- On vehicles equipped with the SOS emergency assistance, if the SOS emergency assistance system operates, the SRS warning light illuminates.

Driver's and passenger's front airbag system

N00407901357

4

The driver's airbag is located under the padded cover in the middle of the steering wheel. The front passenger's airbag is contained in the instrument panel above the glove compartment. The driver's airbag and the front passenger's airbag are designed to deploy at the same time. However, the front passenger's airbag does not deploy when the front passenger seat is not occupied or when the system senses that a child is in the child restraint system.

designed to deploy at the same time as the driver's front airbag.

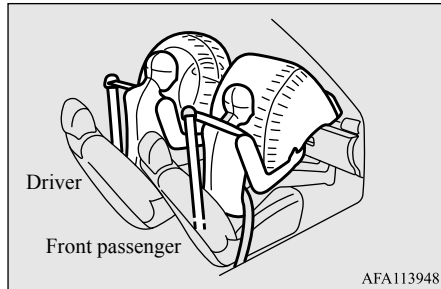
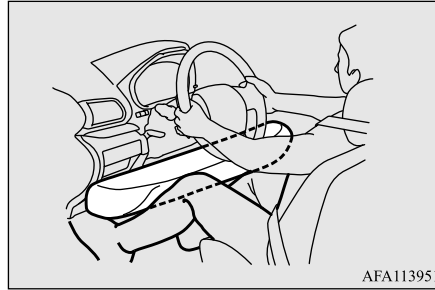

Driver's knee airbag system

N00404501046

The driver's knee airbag is located under the steering wheel. The driver's knee airbag is

Deployment of front airbags

N00408001704

The front airbags and driver's knee airbag ARE DESIGNED TO DEPLOY when ...

Head-on collision with a solid wall at speeds of approx. 15 mph (25 km/h) or higher

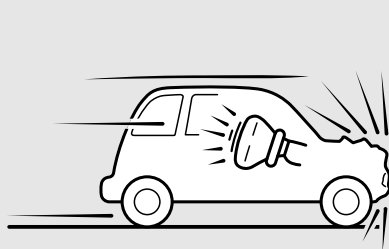

Moderate to severe frontal impact within the shaded area between the arrows

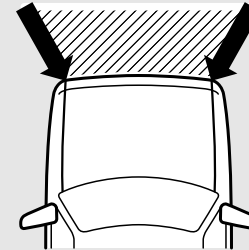

AA1000050

The front airbags and driver's knee airbag are designed to deploy when the vehicle suffers a moderate to severe frontal impact. A typical condition is shown in the illustration to the left.

The front airbags and driver's knee airbag are designed to deploy only in certain moderate to severe frontal collisions within the shaded area between the arrows in the illustration to the right.

The front airbags and driver's knee airbag will deploy if the impact to the vehicle's main structure is above a specific threshold level. The threshold level is approximately 15 mph (25 km/h) for a frontal collision straight into a solid flat wall that does not bend or deform. If the impact to the vehicle's main structure is below this threshold level, the front airbags and driver's knee airbag may not deploy. This threshold level may also be higher if the vehicle hits something that absorbs the impact, either by bending or moving (for example,

another stationary vehicle, a pole or a guard rail).

The initial stage of airbag inflation is the most forceful, and can cause serious injury or death if you are too close to the deploying airbag. Accordingly, it is important that you always wear the available seat belt.

The front airbags and driver's knee airbag MAY NOT DEPLOY when ...

4

In certain types of front collisions, the front airbags and driver's knee airbag may not deploy, even if the deformation of the body seems to be large, because the vehicle's body structure is designed to absorb the impact and deform in order to help protect the occupants. Some typical situations where the front airbags and driver's knee airbag may not deploy are shown in the illustrations.

Since the front airbags and driver's knee airbag do not protect the occupant in all types of frontal collisions, be sure to always wear your seat belts properly.

Collision with a utility pole, tree or other narrow object

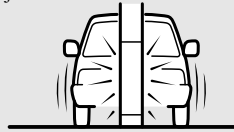

Collision where the vehicle slides under the rear body of a truck

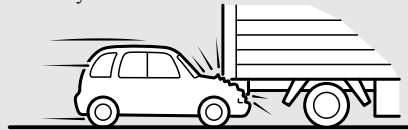

Oblique frontal impact

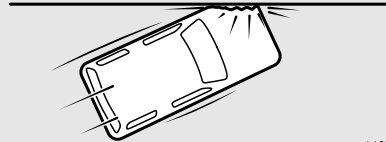

AA2000233

The front airbags and driver's knee airbag ARE NOT DESIGNED TO DEPLOY when ...

The front airbags and driver's knee airbag are not designed to deploy in situations where

they cannot provide protection to the occupants. Some typical situations are shown in the illustration.

Since the front airbags and driver's knee airbag do not protect the occupants in all types of collisions, be sure to always wear your seat belts properly.

Rear end collision to your vehicle



Side collision to your vehicle

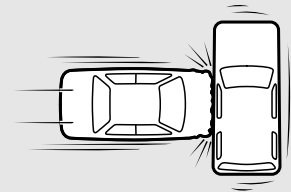

Vehicle rolls onto its side or roof

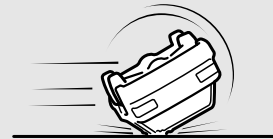

AA2000220

The front airbags and driver's knee airbag MAY DEPLOY when ...

The front airbags and driver's knee airbag may deploy if the underside of the vehicle suffers a moderate to severe impact (under-carriage impact). Some typical situations are shown in the illustration.

Since the front airbags and driver's knee airbag may deploy in certain types of unexpected impacts, as shown in the illustrations, and these unexpected impacts can move you out of position, it is important to always wear your seat belts properly. When worn properly, seat belts can help maintain your distance from the airbags when they begin to inflate. The initial stage of airbag inflation is the most forceful and can cause serious injury or death if you are close to the deploying airbag.

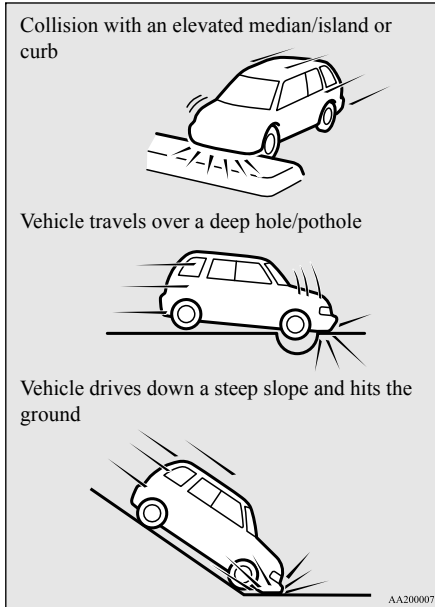

⚠ WARNING

- Do not attach anything to the steering wheel's padded cover, such as trim material, badges, etc. These could strike and injure an occupant if the airbag inflates.

⚠ WARNING

- Do not set anything on, or attach anything to, the instrument panel above the glove compartment. Such items could strike and injure an occupant if the airbag inflates.

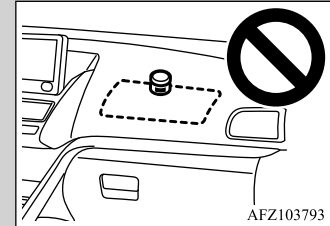

- Do not attach accessories to, or put them in front of, the windshield. They could restrict the airbag inflation, or strike and injure an occupant, when the airbag inflates.
- Do not attach additional keys or accessories (hard, pointed or heavy objects) to the ignition key. Such objects could prevent the driver's knee airbag from inflation normally or could be propelled to cause serious injury if the airbag inflates.

⚠ WARNING

- Do not attach accessories to the lower portion of the driver's side instrument panel. Such objects could prevent the driver's knee airbag from inflating normally or could be propelled to cause serious injury if the airbag inflates.

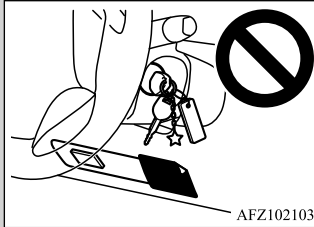

- Do not attempt to remove, install, disassemble or repair the SRS airbags.
- Do not place objects, such as packages or pets, between the airbags and the driver or the front passenger. Such objects can adversely affect airbag performance, or cause serious injury or death when the airbag deploys.
- Immediately after airbag inflation, some parts of the airbag system will be hot. Do not touch them. You could otherwise be burned.
- The airbag system is designed to work only once. After the airbags deploy, they will not work again. They must promptly be replaced and the entire airbag system must be inspected by an authorized Mitsubishi Motors dealer.

Side airbag system

N00408101473

The side airbags (A) are contained in the driver and front passenger seatbacks. The side airbag is designed to inflate only on the side of the vehicle that is impacted, even with no passenger in the front seat.

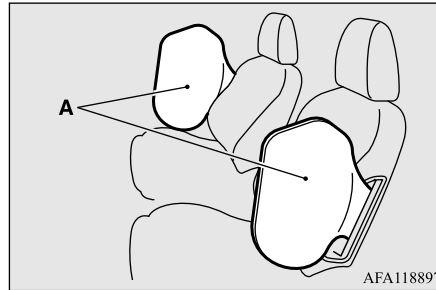

There is a symbol on the seatbacks that are equipped with side airbags.

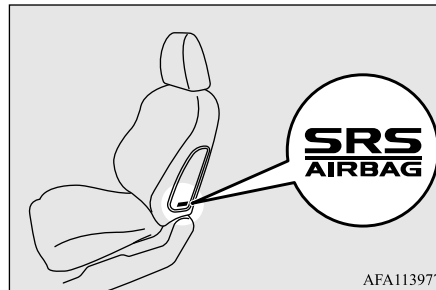

Curtain airbag system

N00419201331

The curtain airbags are contained in the front pillar, the rear pillar and the side sections of the roof.

The curtain airbag is designed to inflate only on the side of the vehicle that is impacted, even with no passenger in the seat.

Also, when the airbag control unit detects rollover of the vehicle, the curtain airbags will deploy.

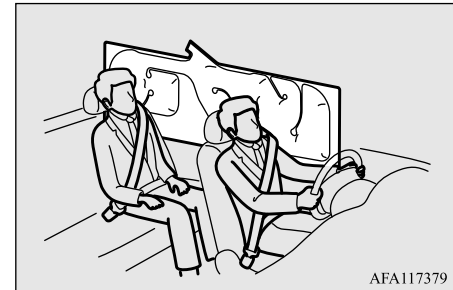

⚠ WARNING

- The side airbags and curtain airbags can cause serious injury or death to anyone too close to the airbag when it deploys. To reduce the risk of injury from a deploying side airbag or curtain airbag, driver and front passenger must be properly restrained and seated well back, upright, and in the middle of the seat. Do not lean against the door.



- In order to reduce the risk of injury from a deploying side airbag, do not allow any rear seat passengers to hold onto the back of either front seat. Special care should be taken with children.
- Do not place any objects around the area where the side airbags deploy. Such objects can interfere with proper side airbag deployment, and cause injury during deployment of the side airbag.
- Do not place stickers, labels or additional trim on the back of either front seat. They can interfere with proper side airbag deployment.

⚠ WARNING

- Do not attach a microphone (A) or any other object around the part where the curtain airbag (B) deploys, such as on the windshield, side door glass or front and rear pillars and roof side rail. When the curtain airbag inflates, the microphone or other object may be hurled with great force or the curtain airbag may not inflate correctly, resulting in death or serious injury.

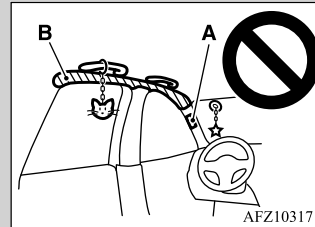

- Do not put a hanger or any heavy or pointed object on the coat hook. If the curtain airbag was activated, any such item could be propelled away with great force and could prevent the curtain airbag from inflating correctly. Hang clothes directly on the coat hook (without using a hanger). Make sure there are no heavy or sharp objects in the pockets of clothes that you hang on the coat hook.

⚠ WARNING

- Do not install seat covers or re-cover seats that have side airbags. Covers can interfere with proper side airbag deployment and adversely affect side airbag performance.
- Never install a rear-facing child restraint system in the front passenger seat. Rear-facing child restraint systems **MUST ONLY** be used in the rear seat.
- Front-facing child restraint systems should also be used **ONLY** in the rear seat. If a front-facing child restraint system must be used in the front passenger seat, move the seat as far back as possible, and make sure that the child stays in the child restraint system, properly restrained and away from the door.
- Do not allow a child to lean against or sit close to the passenger door, even if the child is seated in a child restraint system. The child's head should also not lean against or be close to the section of the seatback where the side airbag and curtain airbag are located. It is dangerous if the side airbag or curtain airbag deploys. Failure to follow all of these instructions could lead to serious injury or death to the child.

⚠ WARNING

● Work done on or in the vicinity of the side airbag or curtain airbag components should be done only by an authorized Mitsubishi Motors dealer. There is a risk of a serious injury or death. Improper work methods can cause accidental side airbag or curtain airbag deployment, or render a side airbag or curtain airbag inoperable. Either of these situations could result in serious injury or death.

4

Deployment of side airbag and curtain airbag

N00408201618

The side airbag and curtain airbag ARE DESIGNED TO DEPLOY when...

The side airbag and curtain airbag are designed to deploy when the vehicle suffers a moderate to severe side impact to the middle of the passenger compartment. Also when the vehicle detects rollover of the vehicle, the curtain airbags will deploy. Typical situations are shown in the illustration.

Moderate to severe impact to the middle of the vehicle body's side structure

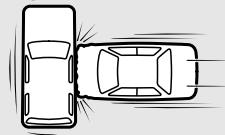

When the vehicle detects rollover of the vehicle (Curtain airbag only)

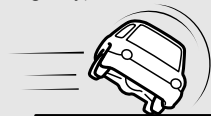

AF3102256

The seat belts in your vehicle are your primary means of protection in an accident. The SRS side airbags and curtain airbags are designed to provide additional protection. Therefore, for your safety and the safety of all occupants, be sure to always wear your seat belts properly.

The side airbag and curtain airbag MAY NOT DEPLOY when...

In certain types of side collisions, the side airbag and curtain airbag may not deploy, even if the deformation of the body seems to be large, because the vehicle's body structure is designed to absorb the impact and to deform in order to help protect the occupants. There are also cases where the side airbag and curtain airbag may not deploy at the same time, depending on the location of the impact. Some typical situations where the side airbags and curtain airbags may not deploy are shown in the illustrations.

Since the side airbags and curtain airbags do not protect the occupant in all types of side collisions, be sure to always wear the seat belts properly.

Side impact in an area away from the passenger compartment

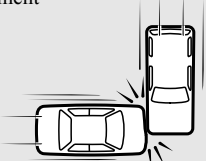

Motorcycle or other similar small vehicle collision with the side of vehicle



Collision with a utility pole, tree or other narrow object

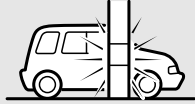

AFE101255

Oblique side impact



Vehicle rolls onto its side or roof (Side airbag only)



AF3102243

The side airbag and curtain airbag ARE NOT DESIGNED TO DEPLOY when...

The side airbag and curtain airbag are not designed to deploy in situations where they cannot provide protection to the occupants. Some typical situations are shown in the illustration.

Since the side airbags and curtain airbags do not protect the occupant in all types of collisions, be sure to always wear your seat belts properly.

Head-on collision



Rear end collision to your vehicle



Pitch end over end

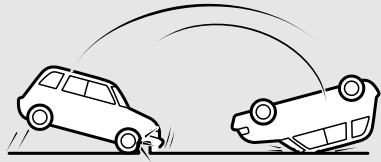

AG2000299

SRS servicing

N00408501842

WARNING

- Any maintenance performed on or near the components of the SRS should be performed only by an authorized Mitsubishi Motors dealer. Do not permit anyone else to do any service, inspection, maintenance or repair on any SRS components or wiring. Similarly, no part of the SRS should ever be handled, removed or disposed by anyone except an authorized Mitsubishi Motors dealer.

Improper work methods on the SRS components or wiring could result in an accidental airbag deployment or could make the SRS inoperable. Either of these situations could result in serious injury or death.

- Do not modify your steering wheel or any other SRS component or related vehicle part. For example, replacement of the steering wheel, or modifications to the front bumper or body structure can adversely affect SRS performance and may lead to injury.
- If your vehicle has received any damage, you should have the SRS inspected by an authorized Mitsubishi Motors dealer to make sure it is in proper working order.

WARNING

- Do not modify your front seats, center pillar or center console. Such modifications can adversely affect SRS performance and may lead to injury.

Also, if you discover any tear or open seam in the seat fabric near the side airbag, have the seat inspected by an authorized Mitsubishi Motors dealer.

- If you have found any scratch, crack or damage to the portion of the front and rear pillars and roof side rail, you should have the SRS inspected by an authorized Mitsubishi Motors dealer.

NOTE

- Steering wheel
- Instrument panel

[For vehicles sold in U.S.A.]

To contact Mitsubishi Motors North America, Inc.

call 1-888-648-7820 or write to:

Mitsubishi Motors North America, Inc.
Customer Relations Department
P.O. Box 689040
Franklin, TN 37068

[For vehicles sold in Canada]

To contact Mitsubishi Motor Sales of Canada, Inc.

call 1-888-576-4878 or write to:

Mitsubishi Motor Sales of Canada, Inc.
Customer Relations Department
P.O. Box 41009
4141 Dixie Road
Mississauga, ON L4W 5C9

NOTE

- When you transfer ownership of the vehicle to another person, we urge you to alert the new owner that it is equipped with the SRS and refer that owner to the applicable sections in this owner's manual.
- If you decide to junk or scrap your vehicle, we urge you to first take it to an authorized Mitsubishi Motors dealer so that the SRS can be made safe for disposal.
- If any of the following parts needs to be modified for use by a handicapped person, the advanced airbag system will be greatly affected. Please consult an authorized Mitsubishi Motors dealer.
 - Driver's seat
 - Front passenger seat
 - Front seat belt

[For vehicles sold in Puerto Rico]

To contact Mitsubishi Motor Sales of Caribbean, Inc.

call 1-787-251-8715 or write to:

Mitsubishi Motor Sales of Caribbean, Inc.

Customer Service Department

P.O. Box 192216

SAN JUAN PR 00919-2216

[For vehicles sold in Guam]

To contact Triple J Enterprises Inc.

call (671) 649-3673 or write to:

Triple J Enterprises, Inc.

P.O. Box 6066

TAMUNING

GUAM 96931

[For vehicles sold in Saipan]

To contact Triple J Motors

call (670) 234-7133 or write to:

Triple J Motors

P.O. Box 500487

SAIPAN, MP96950-0487

[For vehicles sold in American Samoa]

To contact Pacific Marketing Inc.

call 684 (699) 9140 or write to:

Pacific Marketing, Inc.

P.O. Box 698

PAGO PAGO,

AMERICAN SAMOA AS, 96799

Warning label

N00408601407

Occupant restraint warning labels for the SRS are located in the vehicle as shown in the illustration.

4

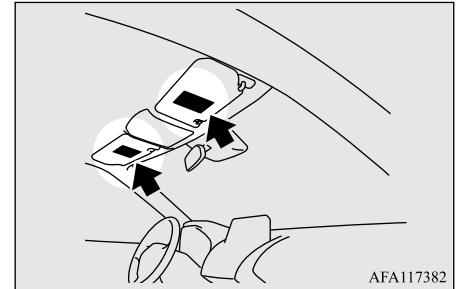

AFA117382

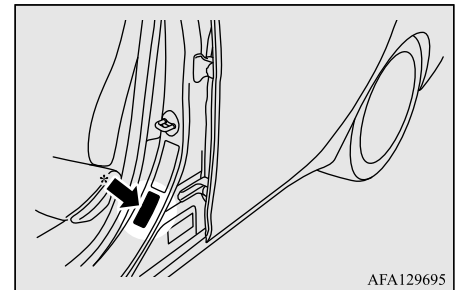

AFA129695

* - Located in the passenger's side as well.

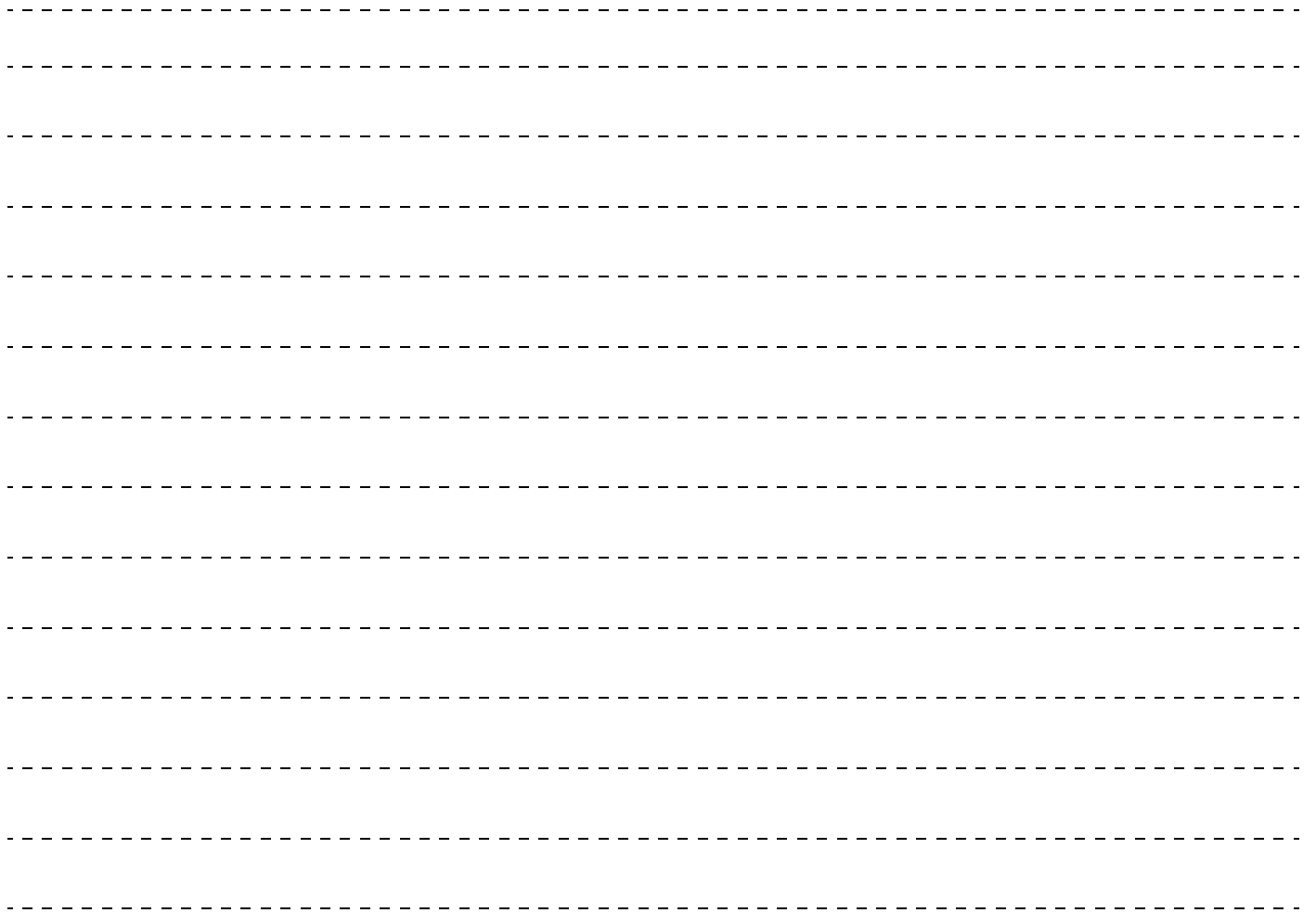

Features and controls

Keys	5-3	Active Yaw Control (AYC)	5-81
Electronic immobilizer (Anti-theft starting system)	5-4	Anti-lock braking system	5-82
Keyless entry system (if so equipped)	5-6	Electric power steering system (EPS)	5-84
Free-hand Advanced Security Transmitter (F.A.S.T.-key) (if so equipped)	5-13	Active stability control (ASC)	5-85
Door locks	5-34	Cruise control	5-87
Power door locks	5-37	Adaptive Cruise Control System (ACC) (if so equipped)	5-92
Child safety locks for rear door	5-38	Forward Collision Mitigation system (FCM)	5-105
Liftgate	5-38	Blind Spot Warning (BSW) (with Lane Change Assist) (if so equipped)	5-114
Theft-alarm system	5-40	Rear Cross Traffic Alert (RCTA) (if so equipped)	5-120
Power window control	5-43	Lane Departure Warning (LDW) (if so equipped)	5-123
Power panoramic sunroof (if so equipped)	5-46	Tire pressure monitoring system (TPMS)	5-126
Parking brake	5-50	Rear-view camera	5-131
Steering wheel height and reach adjustment	5-54	Multi Around Monitor (if so equipped)	5-133
Inside rearview mirror	5-55	Instrument cluster	5-142
Outside rearview mirrors	5-57	Multi-information display	5-144
Ignition switch	5-60	Indicator light, warning light, and information screen display list	5-164
Starting the engine	5-61	Indicators	5-185
Turbocharger operation	5-63	Warning lights	5-186
Continuously variable transmission (CVT)	5-63	Information screen display	5-188
S-AWC (Super-All Wheel Control) (if so equipped)	5-70	Head Up Display (HUD) (if so equipped)	5-189
4-wheel drive operation	5-72	Combination headlights and dimmer switch	5-194
Inspection and maintenance following rough road operation	5-75	Turn signal lever	5-203
Cautions on the handling of 4-wheel drive vehicles	5-75	Hazard warning flasher switch	5-204
Service brake	5-76	ECO mode switch	5-204
Brake auto hold (if so equipped)	5-77	Front fog light switch (if so equipped)	5-204
Hill start assist	5-79	Wiper and washer switch	5-205
Brake assist system	5-80		

Features and controls

5

Electric rear window defogger switch	5-211
Heated steering wheel switch (if so equipped).....	5-212
Horn switch	5-213
USB input terminal	5-213
Sun visors	5-214
12 V power outlets	5-215
HomeLink® Wireless Control System (if so equipped).....	5-216
Interior lights	5-222
Storage spaces	5-225
Drink holders	5-227
Bottle holders	5-227
Cargo area cover (if so equipped)	5-228
Assist grips	5-229
Coat hooks	5-229
Luggage hooks	5-230
Convenient hook	5-230
Luggage floor board	5-230

Keys

N00508801787

Type 1

Two keys are provided. The keys fit all locks. Keep one in a safe place as a spare key.

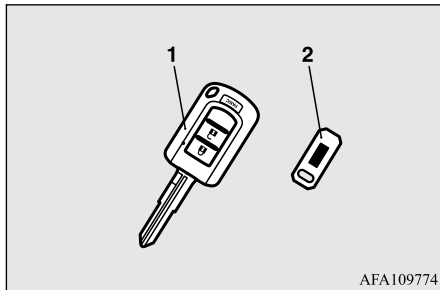

AFA109774

- 1- Key for the electronic immobilizer and keyless entry system
- 2- Key number plate

Type 2

Two F.A.S.T.-keys and two emergency keys are provided.

Keep one F.A.S.T.-key and one emergency key in a safe place together as a set of spare keys.

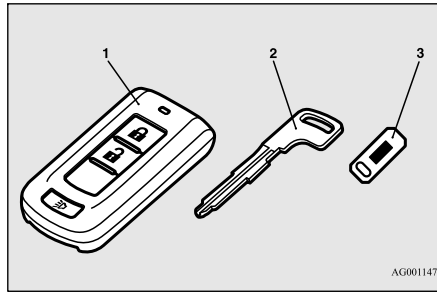

AG0011471

- 1- F.A.S.T.-key
(with electronic immobilizer and keyless entry system function)
- 2- Emergency key
- 3- Key number plate

NOTE

- The key (except for the emergency key) is a precision electronic device with a built-in signal transmitter. Please observe the following in order to prevent damage.

NOTE

- Do not leave where it may be exposed to heat caused by direct sunlight, such as on top of the dashboard.
- Do not take the key apart.
- Do not excessively bend the key or subject it to strong impacts.
- Keep the key dry.
- Keep away from magnetic objects such as key rings.
- Keep away from devices that produce magnetism, such as audio systems, computers and televisions.
- Keep away from devices that emit strong electromagnetic waves, such as cellular phones, wireless devices and high frequency equipment (including medical devices).
- Do not clean with ultrasonic cleaners.
- Do not leave the key where it may be exposed to high temperature or high humidity.
- If you lose your key, to prevent the theft of the vehicle immediately contact an authorized Mitsubishi Motors dealer. If you notify an authorized Mitsubishi Motors dealer of the key number, they can make a new key. The key number is stamped on the key number plate. Keep the key number plate in a safe place separate from the key itself.

NOTE

- No keys other than those registered in advance can be used to start the engine. Refer to “Electronic immobilizer (Anti-theft starting system)” on page 5-4. Refer to “Free-hand Advanced Security Transmitter (F.A.S.T.-key): “Electronic immobilizer (Anti-theft starting system)” on page 5-27.
- When the theft-alarm is in the system operational status, the alarm operates if a door or liftgate is opened after using the key, the door lock knob or the power door lock switch to unlock the vehicle.
- The system does not enter the preparation state if the keyless entry system or the F.A.S.T.-key was not used to lock the vehicle.

**Electronic immobilizer
(Anti-theft starting system)**

N00509101905

CAUTION

- Do not make any alterations or additions to the immobilizer system. Alterations or additions could cause failure of the immobilizer.

[For vehicles equipped with the F.A.S.T.-key]
For information on operations for vehicles equipped with the F.A.S.T.-key, refer to “Free-hand Advanced Security Transmitter

(F.A.S.T.-key): Electronic immobilizer (Anti-theft starting system)” on page 5-27.

[Except for vehicles equipped with the F.A.S.T.-key]

The electronic immobilizer is designed to significantly reduce the possibility of vehicle theft. The purpose of the system is to immobilize the vehicle if an invalid start is attempted. A valid start attempt can only be achieved (subject to certain conditions) using a key “registered” to the immobilizer system. All of the keys provided with your new vehicle have been programmed to the vehicle’s electronics.

NOTE

- In the following cases, the vehicle may not be able to recognize the registered ID code from the key. This means the engine will not start even when the key is turned to the “START” position.
- When the key contacts a key ring or other metallic or magnetic object

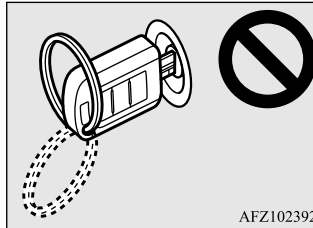

NOTE

- When the key grip contacts metal of another key

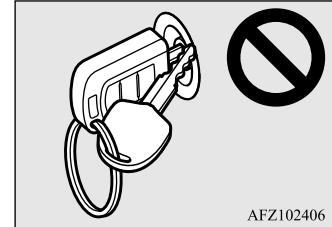

- When the key contacts or is close to other immobilizer keys (including keys of other vehicles)

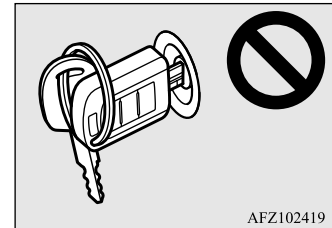

In cases like the above, move the offending object(s) away from the key and turn the key back to the “ACC” or “OFF” position. Then try to start the engine again. If the engine does not start, contact an authorized Mitsubishi Motors dealer.

- The key may not operate properly when it is near an object or facility that emits strong electromagnetic waves.

NOTE

- Electronic immobilizer is not compatible with commercially available remote starting systems. Use of commercially available remote starting systems may result in vehicle starting problems and a loss of security protection.
- A system failure is suspected when the ignition switch is turned to the “START” position, and the engine does not start. In such a case, contact an authorized Mitsubishi Motors dealer.

Replacement keys

Only keys that have been programmed to the vehicle’s electronics can be used to start the vehicle.

If you lose the key, you can order a key from your authorized Mitsubishi Motors dealer by referring to the key number.

To prevent vehicle theft, the ID code for the vehicle keys must be changed.

Take your vehicle and all remaining keys to your authorized Mitsubishi Motors dealer to have your ID code changed.

Additional keys

To add a key, you must already have two registered keys. You need to register the ID code to the vehicle.

Registering the ID code can be done by yourself (except for vehicles sold in Canada), or by your authorized Mitsubishi Motors dealer. For you to register the ID code yourself, follow the “Customer key programming” procedure below.

If you choose to have your authorized Mitsubishi Motors dealer register the ID code, take your vehicle and all remaining keys to your authorized Mitsubishi Motors dealer.

NOTE

- You are provided with two keys, but you may register up to eight keys.

**Customer key programming
(Except for vehicles sold in
Canada)**

N00562201208

You can program new keys to the system if you have two valid (already registered) keys and blank immobilizer key (specially cut for

your vehicle at your Mitsubishi Motors dealer) by doing the following:

1. Insert the first valid key into the ignition switch and turn the key to the “ON” position for 5 seconds.
2. Turn the key to the “OFF” position and remove the first key.
3. Within 30 seconds of removing the first key, insert the second valid key into the ignition and turn it to the “ON” position. Approximately 10 seconds later, the immobilizer display will start to blink.
4. When the immobilizer display starts blinking, turn the second valid key to the “OFF” position and remove it. Within 30 seconds after doing so, insert a blank immobilizer key into the ignition switch and turn it to the “ON” position. Perform this operation no more than 30 seconds after the immobilizer display starts blinking. When registration of the ID code is complete, the immobilizer display will come on for 30 seconds then go off. If an error occurs, the blinking immobilizer display will go off during the procedure.



Keyless entry system (if so equipped)

5. If you wish to register another key, perform the process again from step 1.

NOTE

- Perform the operation when the interrupt display screen is not showing. The interrupt display screen may prevent you from seeing the immobilizer display.
- It is not possible to register a key if:
 - the immobilizer display goes off during the procedure
 - the immobilizer display does not come on within 30 seconds after step 4.
- The procedure will be terminated automatically if:
 - a period of 30 seconds or longer elapses from the moment when the first key is turned to the “OFF” position to the moment when the second key is turned to the “ON” position
 - a period of 30 seconds or longer elapses from the moment when the second key is turned to the “OFF” position to the moment when the blank immobilizer key is turned to the “ON” position
- To use the new keys, it is necessary to register the key with both the electronic immobilizer and keyless entry system. Also refer to “Keyless entry system: Customer key programming” on page 5-9.

General information

N00562301094

Your electronic immobilizer operates on a radio frequency subject to Federal Communications Commission (FCC) Rules (For vehicles sold in U.S.A.) and Industry Canada Rules (For vehicles sold in Canada). This device complies with part 15 of FCC Rules and Industry Canada licence-exempt RSS standard(s).

Operation is subject to the following two conditions.

- This device may not cause harmful interference.
- This device must accept any interference received, including interference that may cause undesired operation.

CAUTION

- Changes or modifications not expressly approved by the manufacturer for compliance could void the user’s authority to operate the equipment.

Keyless entry system (if so equipped)

N00509002174

Press the key buttons to lock or unlock the doors and the liftgate.

It can also help you signal for attention by setting off the panic alarm.

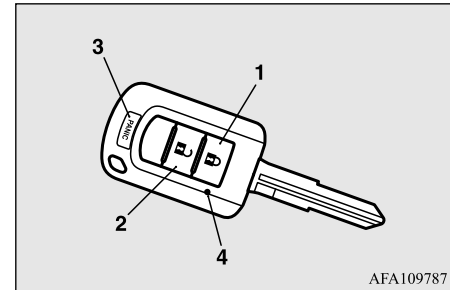

AFA109787

- 1- LOCK (🔒) button
- 2- UNLOCK (🔓) button
- 3- PANIC button
- 4- Indicator light

To lock

Press the LOCK button (1) to lock all the doors and the liftgate.

The turn signal lights will also blink once.

 **NOTE**

- If you press the LOCK button (1) twice the horn will sound once.

To unlock

Press the UNLOCK button (2) to unlock the driver's door only.

Within approximately 2 seconds, press the UNLOCK button one more time to unlock all the doors and liftgate.

The dome light will turn on for 30 seconds. The turn signal lights will also blink twice.

The front side-marker and parking lights will also turn on for approximately 30 seconds. Refer to "Welcome light" on page 5-201.

 **NOTE**

- The door and liftgate unlock function can be set so that all doors and liftgate unlock when the UNLOCK button (2) is pressed once. Refer to "Setting of door and liftgate unlock function" on page 5-8.

Answerback function

N00543501127

The horn and turn signal lights of the keyless entry system answerback function can be

changed as required. This is done with the key removed from the ignition switch.

 **NOTE**

- The answerback function will not operate if any of the doors are open.

Horn deactivation/reactivation

N00597000056

The answerback function can be set in the following three ways.

Each time the answerback function is set, a chime will sound to tell you the condition of the answerback function.

Number of chimes	Condition
One chime	The horn will not sound.
Two chimes	The horn will sound.
Four chimes	The horn will sound if the LOCK button (1) is pressed twice within 1 second.

To change the setting, refer to "Customizing the keyless entry system" on page 5-10.

 **NOTE**

- On vehicles equipped with the Smartphone-link Display Audio (SDA), the functions can be adjusted on the screen. For details, refer to the separate owner's manual.

Turn signal lights deactivation/reactivation

N00597100057

The answerback function can be turned ON or OFF separately.

To change the setting, refer to "Customizing the keyless entry system" on page 5-10.

Number of chimes	To lock	To unlock
One chime	One flash	Two flashes
Two chimes	One flash	No flash
Three chimes	No flash	Two flashes
Four chimes	Two flashes	One flash
Five chimes	No flash	One flash
Six chimes	Two flashes	No flash
Seven chimes	No flash	No flash

 **NOTE**

- On vehicles equipped with the SDA, the functions can be adjusted on the screen. For details, refer to the separate owner's manual.

5

Setting of door and liftgate unlock function

N00543601261

The door and liftgate unlock function can be set to the following two conditions.

Each time the door and liftgate unlock function is set, a chime will sound to tell you the condition of the door and liftgate unlock function.

Number of chimes	Condition
One chime	When the UNLOCK button (2) is pressed one time, all doors and the liftgate unlock.
Two chimes	When the UNLOCK button (2) is pressed one time, only the driver's door unlocks. Within approximately 2 seconds, press the UNLOCK button one more time to unlock all the doors and the liftgate. [Factory setting]

To change the setting, refer to “Customizing the keyless entry system” on page 5-10.

 **NOTE**

- On vehicles equipped with the SDA, the functions can be adjusted on the screen. For details, refer to the separate owner's manual.

Using the panic alarm

N00543701086

If you are near your vehicle and feel threatened, you may activate the alarm to call attention as follows:

1. Press the PANIC button (3) for more than 1 second.
2. The headlights will blink on and off and the horn will sound intermittently for approximately 3 minutes.
3. To turn off the alarm, press any button on the key.

Replacement keys

N00543801104

Only keys programmed with the vehicle's electronics can lock or unlock all doors and the liftgate.

If you lose the key, you can order a key from your authorized Mitsubishi Motors dealer by referring to the key number.

To prevent vehicle theft, the ID code for the key must be changed.

Take your vehicle and all keys to your authorized Mitsubishi Motors dealer to have your ID code changed.

Additional keys

N00543901075

To add a key, you must already have one registered key.

Registering the ID code can be done by yourself or by your authorized Mitsubishi Motors dealer. For you to register the ID code yourself, follow the “Customer key programming” procedure below.

If you choose to have your authorized Mitsubishi Motors dealer register the ID code, take your vehicle and any remaining keys to your authorized Mitsubishi Motors dealer.

 **NOTE**

- You are provided with two keys, but you may register up to eight keys.

Customer key programming (Except for vehicles sold in Canada)

N00544001288

You can program new keys to the system if you have one valid (already registered) key by doing the following:

1. Have available all (current and new) keys you wish to register.
2. Using a valid (already registered) key, activate the registration mode according to the following steps. Steps ii to iv should be completed within 8 seconds.

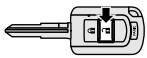
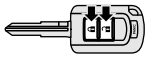
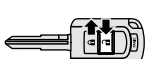
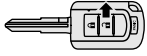
i) Press and hold the UNLOCK button (2) for 4 to 8 seconds.	
ii) While holding the UNLOCK button (2), press the LOCK button (1).	
iii) While holding the UNLOCK button (2), release the LOCK button (1).	
iv) Release the UNLOCK button (2).	

NOTE

- ID codes for all keys except for the key used in step 2 are erased and the answerback function (door is locked and unlocked) informs you that the registration mode has been activated.

3. Within 60 seconds after step 2, complete the following ID code registration operation using the next key you wish to register within 4 seconds.

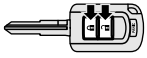
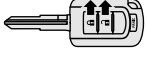
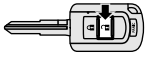
i) Press both the LOCK and UNLOCK buttons for 2 seconds.	
ii) Release both the LOCK and UNLOCK buttons for 1 second.	
iii) Press the UNLOCK button. The answerback function informs you that the ID code registration of the key is completed.	

4. To register the ID codes of additional keys, repeat step 3 within 60 seconds after step 3.

NOTE

5. If no ID code of a key is registered within 60 seconds after step 3, the registration mode is canceled and the normal mode returns.

- Be sure to press the buttons correctly when performing the procedures. If you perform the procedures incorrectly, the registered ID code information could be deleted or the settings could be changed unintentionally. If the registered ID code information is deleted, register the keys again.
- For verification purposes, try to lock and unlock the doors after the registration is completed.
- The indicator light (4) comes on each time a button is pressed.
- The keyless entry system does not work if the key is in the ignition switch.
- The key can be used from approximately 40 feet (12 m) away. However, this distance may change if your vehicle is near a TV transmitting tower, a power station, or a radio station.
- If the UNLOCK button (2) is pressed and no doors or the liftgate are opened within approximately 30 seconds, the doors and the liftgate will automatically re-lock. On vehicles equipped with the SDA, the functions can be adjusted on the screen. For details, refer to the separate owner's manual.

 **NOTE**

- If the following conditions are observed after pressing the LOCK (1) or UNLOCK (2) button on the key, the battery in the key may need to be replaced.
 - The doors and the liftgate cannot be locked or unlocked.
 - The panic alarm cannot be operated.
 - The indicator light (4) is dim or does not come on.
- If you lose your key, please contact an authorized Mitsubishi Motors dealer for a replacement.
- If you wish to obtain an additional key, please contact an authorized Mitsubishi Motors dealer. A maximum of eight keys can be programmed for your vehicle.
- To use the new keys, it is necessary to register the key with both the electronic immobilizer and keyless entry system.
Also refer to “Customer key programming (Except for vehicles sold in Canada)” on page 5-5.

Customizing the keyless entry system

N00596500054

You can change the settings for the following functions according to your preferences. When changing a setting, perform the following steps.

1. Remove the key from the ignition switch.
2. Open the driver’s door and turn the combination headlights and dimmer switch to the “OFF” position (except for vehicles equipped with the automatic control) or the “AUTO” position (for vehicles equipped with the automatic control).
3. Complete steps i to iv of the procedure. Steps ii to iv should be completed within 8 seconds.

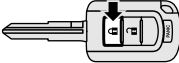
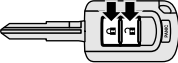
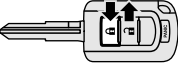
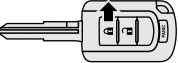
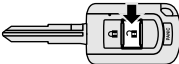
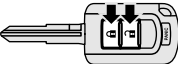
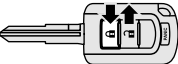
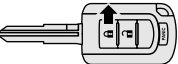
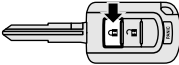
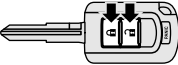
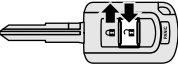
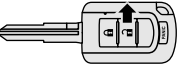
Item	Step i	Step ii	Step iii	Step iv	Notification
Horn deactivation/reactivation	Press and hold the LOCK button (1) for 4 to 8 seconds. 	While holding the LOCK button (1), press the UNLOCK button (2). 	While holding the LOCK button (1), release the UNLOCK button (2). 	Release the LOCK button (1). 	Chimes → Page 5-7
Turn signal lights deactivation/reactivation	Press and hold the UNLOCK button (2) for 4 to 8 seconds. 	While holding the UNLOCK button (2), press the LOCK button (1). 	While holding the LOCK button (1), release the UNLOCK button (2). 	Release the LOCK button (1). 	Chimes → Page 5-7
Setting of door and liftgate unlock function	Press and hold the LOCK button (1) for 4 to 8 seconds. 	While holding the LOCK button (1), press the UNLOCK button (2). 	While holding the UNLOCK button (2), release the LOCK button (1). 	Release the UNLOCK button (2). 	Chimes → Page 5-8

NOTE

- Be sure to press the buttons correctly when performing the procedures. If you perform the procedures incorrectly, the registered ID code information could be deleted or the settings could be changed unintentionally. If the registered ID code information is deleted, register the keys again. Refer to “Customer key programming (Except for vehicles sold in Canada)” on page 5-9.

General information

N00546101124

Your keyless entry system operates on a radio frequency subject to Federal Communications Commission (FCC) Rules (For vehicles

sold in U.S.A.) and Industry Canada Rules (For vehicles sold in Canada). This device complies with Part 15 of FCC Rules and

Keyless entry system (if so equipped)

Industry Canada licence-exempt RSS standard(s).

Operation is subject to the following two conditions.

- This device may not cause harmful interference.
- This device must accept any interference received, including interference that may cause undesired operation.

5

CAUTION

- Changes or modifications not expressly approved by the manufacturer for compliance could void the user's authority to operate the equipment.

Procedure for replacing the key battery

N00544101335

WARNING

- **Do not swallow a coin type battery.**
 - This product contains coin type battery. If a coin type battery is swallowed, it can cause severe internal burns and can lead to death.
 - There have been cases where a swallowed battery has caused severe internal burns in just 2 hours.
- Keep new and used batteries away from children.

WARNING

- If the key case does not close securely, stop using the product and keep it away from children.
- If you think batteries might have been swallowed or placed inside any part of a person's body, seek immediate medical attention.
- To prevent an explosion or leakage of flammable liquid or gas:
 - Do not replace the battery with an incorrect type. Replace only with the same or equivalent type.
 - Do not dispose of a battery into a fire or incinerator, or by mechanically crushing or cutting the battery.
 - Do not use, store, or take a battery any place where it may be exposed to extremely high temperature or extremely low air pressure.

CAUTION

- When the key case is opened, be careful to keep water, dust, etc. out. Also, do not touch the internal components.
- Dispose of used battery according to regulations for the disposal of battery.

1. Before replacing the battery, remove static electricity from your body by touching a metal grounded object.

2. Remove the screw (A) from the key.

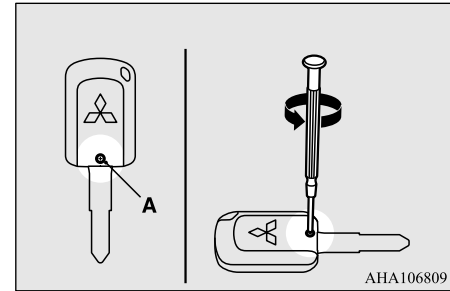

3. With the Mitsubishi mark facing you, insert the cloth-covered tip of a flat blade screwdriver into the notch in the key case and use it to open the case.

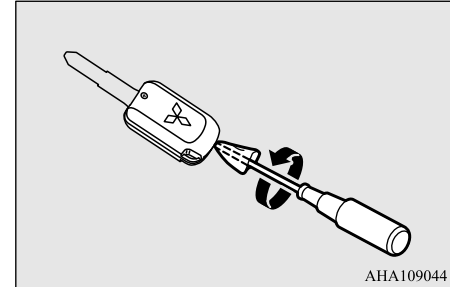

NOTE

- Be sure to perform the procedure with the Mitsubishi mark facing you. If the Mitsubishi mark is not facing you when you open the key case, the buttons may come out.

NOTE

- The Federal Communications Commission (FCC) ID number, the Industry Canada (IC) number and the model number (radio certification) are indicated in the illustrated position.

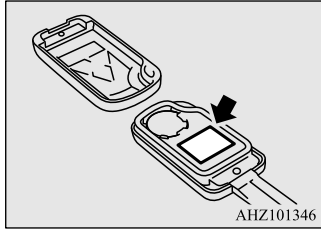

4. Remove the used battery.
5. Install a new battery with the + side (B) up.

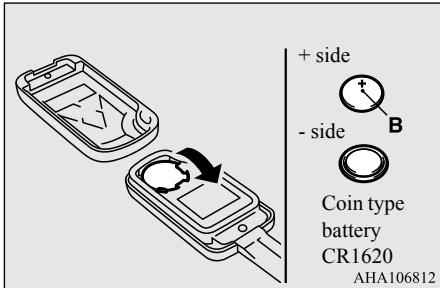

6. Close the key case firmly.
7. Attach the screw (A) removed in step 2.
8. Check the keyless entry system to see that it works.

NOTE

- You may purchase a replacement battery at an electric appliance store.
- An authorized Mitsubishi Motors dealer can replace the battery for you if you prefer.

Free-hand Advanced Security Transmitter (F.A.S.T.-key) (if so equipped)

N00503101264

The Free-hand Advanced Security Transmitter (F.A.S.T.-key) enables the doors and the liftgate to be locked and unlocked, the engine to be started and the operation mode to be changed simply by carrying it.

The F.A.S.T.-key can also be used as the key of the keyless entry system.

Refer to “Keyless entry system” on page 5-28.

The F.A.S.T.-key must be carried by the driver. The F.A.S.T.-key is required for vehicle operations such as locking and unlocking the doors and the liftgate, starting the engine and changing the operation mode. When leaving the vehicle, make sure you are carrying the F.A.S.T.-key and then lock the vehicle.

WARNING

- Individuals who use implantable pacemakers or implantable cardiovascular-defibrillators should keep away from the external and internal transmitters. The electromagnetic waves used in the F.A.S.T.-key may affect the operation of implantable pacemakers and implantable cardiovascular-defibrillators.

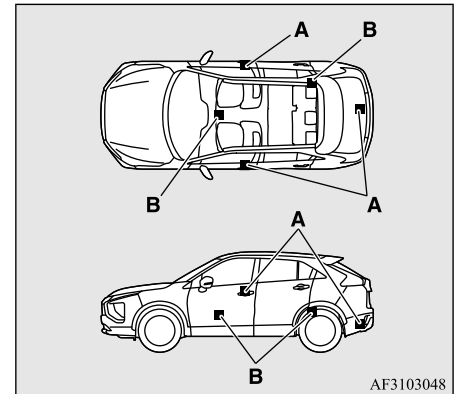

- A- External transmitter
- B- Internal transmitter

⚠ WARNING

- **Individuals using other electro-medical apparatus besides implantable pacemakers and implantable cardiovascular-defibrillators should check with the manufacturer of the apparatus to confirm the effect of the electromagnetic waves used by the F.A.S.T.-key. The electromagnetic waves may affect the operations of the electro-medical apparatus.**

5

The operations possible with the F.A.S.T.-key can be modified as stated below. (Keyless entry operations are possible.) For details, contact an authorized Mitsubishi Motors dealer.

- Enabling only the locking and unlocking of the doors and the liftgate
- Enabling only the starting of the engine
- Deactivating the F.A.S.T.-key

📖 NOTE

- The F.A.S.T.-key uses weak electromagnetic waves.
In cases such as the following, operation may be improper or unstable.
 - The vehicle is near a facility that emits strong electromagnetic waves, such as a TV transmitting tower, a power station, a radio station or an airport

📖 NOTE

- The key is carried together with other communication devices such as cellular phones or radios, or electrical appliances such as computers
- The F.A.S.T.-key touches or is covered by a metal object
- A keyless entry system is being used nearby
- The battery of the F.A.S.T.-key is run down
- The vehicle is in a location with strong electromagnetic waves or noise
Use the emergency key in such circumstances.
Refer to “To operate without using the F.A.S.T.-key” on page 5-26.
- The F.A.S.T.-key is constantly performing reception operations in its communication with the vehicle. This means that the battery is always running down, regardless of how often the F.A.S.T.-key is used. The battery life is approximately 1 to 2 years, depending on the usage conditions.
- Since the F.A.S.T.-key is constantly performing reception operations, the reception of strong electromagnetic waves can accelerate the running down of the battery. Do not place near to electrical appliances such as televisions or computers.

Operating range of the F.A.S.T.-key

N00503201311

When a person enters the operating range of the F.A.S.T.-key while carrying the F.A.S.T.-key and presses the driver’s or front passenger’s door lock/unlock switch, the liftgate lock switch or the liftgate open switch, verification of the ID code is performed.

The doors and the liftgate can be locked and unlocked and the engine can be started only when the ID codes of the vehicle and F.A.S.T.-key match.

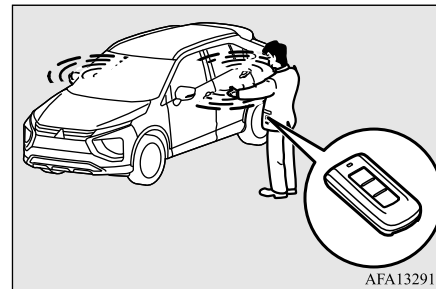

📖 NOTE

- When the battery of the F.A.S.T.-key has run down or there are strong electromagnetic waves or noise in the area, the operating range could decrease or operations could become unstable.

Operating range for locking and unlocking the doors and the lift-gate

The operating range is within approximately 2.3 feet (70 cm) of the driver's and front passenger's door lock/unlock switches, the lift-gate lock switch and the liftgate open switch.

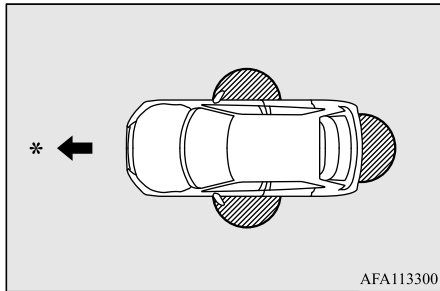

*: Front of the vehicle

: Operating range

NOTE

- Only the doors and the liftgate that detect the F.A.S.T.-key can be locked and unlocked.
- The system may not operate if the F.A.S.T.-key is too close to the windshield, door windows or liftgate.

NOTE

- Even if the F.A.S.T.-key is within approximately 2.3 feet (70 cm) of the driver's or front passenger's door lock/unlock switch, the liftgate lock switch or the liftgate open switch, the system may not operate if the key is close to the ground or in a high position.
- If the F.A.S.T.-key is within the operating range, even a person not carrying the F.A.S.T.-key can lock and unlock the doors or the liftgate by pressing the driver's or front passenger's door lock/unlock switch, the liftgate lock switch or the liftgate open switch.

Operating range for starting the engine and changing the operation mode

N00503301107

The operating range is the interior of the vehicle.

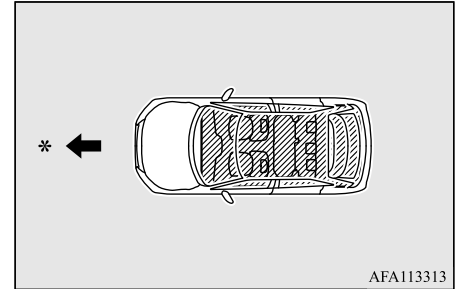

*: Front of the vehicle

: Operating range

NOTE

- Even if the F.A.S.T.-key is within the operating range, it may not be possible to start the engine and change the operation mode if the key is in a storage space such as the glove compartment, on top of the instrument panel, or in the door pocket or luggage compartment.
- Even if the F.A.S.T.-key is inside the vehicle, it may not be possible to start the engine and change the operation mode if the key is too close to a door or door window.

To operate using the F.A.S.T.-key

N00503401528

NOTE

- The outside rearview mirrors automatically retract or extend when all the doors and liftgate are locked or unlocked using the F.A.S.T.-key function. Refer to “Outside rearview mirrors” on page 5-57.

5

To lock

While carrying the F.A.S.T.-key, press the driver’s or front passenger’s door lock/unlock switch (A), or the liftgate lock switch (B) within the operating range to lock all the doors and the liftgate.

The turn signal lights will blink once and the buzzer will sound once.

Also refer to “Door locks” on page 5-34, “Power door locks” on page 5-37, and “Liftgate” on page 5-38 respectively.

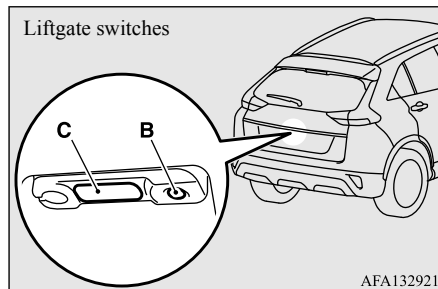
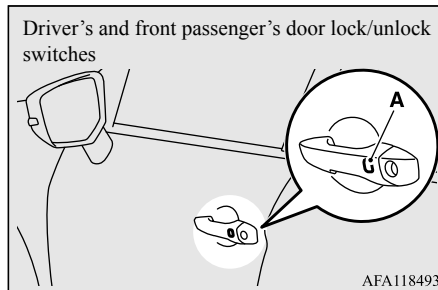

NOTE

- Be sure to have the F.A.S.T.-key with you before locking the vehicle. Even if the F.A.S.T.-key is left in the vehicle in the glove compartment or other small storage compartment, the vehicle may be locked depending on the radio waves and other conditions in the surrounding environment, trapping the key inside the vehicle.

NOTE

- In cases such as the following, the F.A.S.T.-key does not operate.
 - A door or the liftgate is open or ajar.
 - The operation mode is not in OFF.
- The liftgate open switch (C) can be used to confirm that the vehicle is locked properly. Press the liftgate open switch within approximately 3 seconds of locking.
- If the liftgate open switch is pressed 3 seconds or more after the vehicle is locked, the doors and the liftgate are unlocked.
- The time within which locking confirmation is possible can be adjusted. See an authorized Mitsubishi Motors dealer for details. On vehicles equipped with the Smartphone-link Display Audio (SDA) or the Smartphone-link Display Audio (SDA) navigation system, the function can be adjusted on the screen. For details, refer to the separate owner's manual.

To unlock

While carrying the F.A.S.T.-key within the operating range, you can unlock the doors and the liftgate by using the F.A.S.T.-key operation.

The dome light will turn on for 30 seconds. The turn signal lights will blink twice and the buzzer will sound twice.

Also refer to “Door locks” on page 5-34, “Power door locks” on page 5-37 and “Lift-gate” on page 5-38 respectively.

Press the driver’s door lock/unlock switch (A) to unlock only the driver’s door.
 Within approximately 2 seconds, press the driver’s door lock/unlock switch one more time to unlock all the doors and the liftgate.

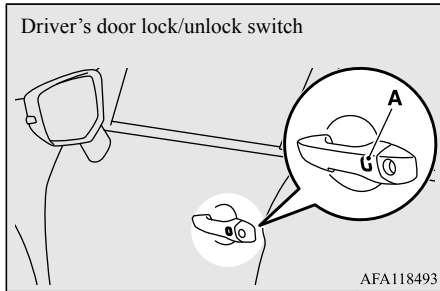

NOTE

- Settings can be changed so that all doors and the liftgate are unlocked automatically by pressing the driver’s door lock/unlock switch once.
 Refer to “Setting of door and liftgate unlock function” on page 5-30.

Press the front passenger’s door lock/unlock switch (B) or the liftgate open switch (C) to unlock all the doors and the liftgate.

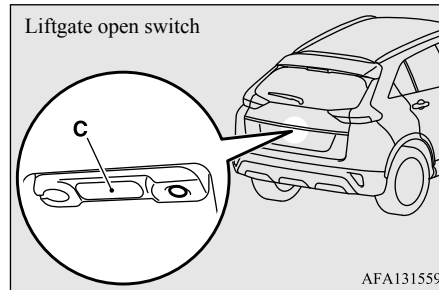
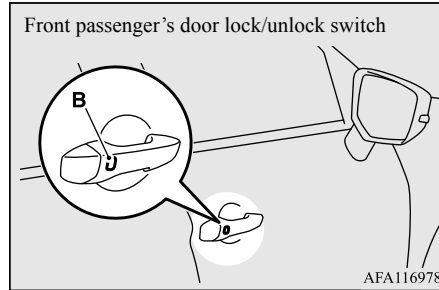

NOTE

- If the doors and the liftgate are unlocked using the driver’s or front passenger’s door lock/unlock switch when no doors or the liftgate are opened within approximately 30 seconds, the doors and the liftgate will automatically re-lock.

NOTE

- The amount of time after unlocking until the vehicle re-locks automatically can be adjusted. See an authorized Mitsubishi Motors dealer for details.
 On vehicles equipped with the SDA or the SDA navigation system, the functions can be adjusted on the screen. For details, refer to the separate owner’s manual.
- The F.A.S.T.-key does not operate when the operation mode is not in OFF.
- The doors and the liftgate cannot be unlocked by using the liftgate open switch for approximately 3 seconds after locking.
- The time within which locking confirmation is possible can be adjusted. See an authorized Mitsubishi Motors dealer for details.
 On vehicles equipped with the SDA or the SDA navigation system, the function can be adjusted on the screen. For details, refer to the separate owner’s manual.
- Functions settings can be modified as stated below.
 See an authorized Mitsubishi Motors dealer for details.
 On vehicles equipped with the SDA or the SDA navigation system, the functions can be adjusted on the screen. For details, refer to the separate owner’s manual.
- Activating the operation confirmation function (blinking of the turn signal lights) only during locking, or only during unlocking.

NOTE

- Deactivating the operation confirmation function (blinking of the turn signal lights) and buzzer.
- Modifying the number of blinks in the operation confirmation function (blinking of the turn signal lights).
- Making the buzzer sound when the F.A.S.T.-key is removed from the passenger compartment when all the doors and the liftgate are closed.

Operation of the outside rearview mirrors

N00585700131

To retract

Locking the doors and liftgate using the driver's or front passenger's door lock/unlock switch or the liftgate lock switch or the LOCK button on the F.A.S.T.-key, the outside rearview mirrors are retracted automatically.

Refer to "Keyless entry system" on page 5-28.

To extend

Unlocking the doors and liftgate using the driver's lock/unlock switch, front passenger's

door lock/unlock switch or the liftgate open switch or the UNLOCK button on the F.A.S.T.-key, the outside rearview mirrors are extended automatically.

Refer to "Keyless entry system" on page 5-28.

NOTE

- Functions can be modified as stated below. Please consult an authorized Mitsubishi Motors dealer.

On vehicles equipped with the SDA or the SDA navigation system, it is possible to change the setting by means of screen operations.

Refer to the separate owner's manual for details.

- Automatically extend when the driver's door is closed and the operation mode is put in ON.

In addition, automatically retract when the operation mode is put in OFF or ACC, and the driver's door is then opened.

- Automatically extend when the vehicle speed reaches approximately 19 mph (30 km/h).
- Deactivate the automatic extension function.

Engine switch

N00513501131

To prevent vehicle theft, no F.A.S.T.-keys other than those registered in advance can be used to start the engine. (Electronic immobilizer function)

While carrying the F.A.S.T.-key, the engine switch can be used to start the engine.

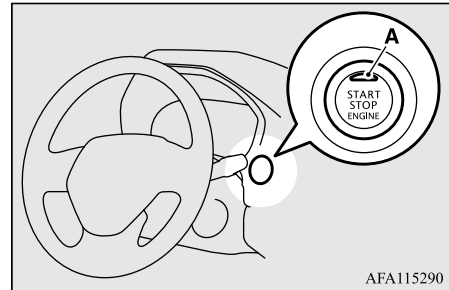

AFA115290

CAUTION

- The indicator light (A) will flash orange when there is a problem or malfunction in F.A.S.T.-key. Never drive if the indicator light on the engine switch is flashing orange. Immediately contact your authorized Mitsubishi Motors dealer.
- If the engine switch operation is not smooth and feels like it is sticking, do not operate the switch. Immediately contact an authorized Mitsubishi Motors dealer.

NOTE

- When operating the engine switch, press the switch all the way in. If the switch is not fully pressed, the engine may not start or the operation mode may not change. If the engine switch is pressed correctly, there is no need to hold the engine switch down.
- When the battery in the F.A.S.T.-key has worn out, or the F.A.S.T.-key is out of the vehicle, a warning display will appear.

Warning display (when the engine switch is pressed one time)

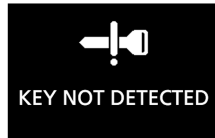

Warning display (when the engine switch is pressed two times or more)

**Operation mode of the engine switch and its function****OFF**

The indicator light on the engine switch turns off.

The operation mode cannot be put in OFF when the selector lever is in any position other than the “P” (PARK) position.

ACC

Allows operation of electrical accessories. The indicator light on the engine switch illuminates in orange.

ON

All electrical accessories can be used. The indicator light on the engine switch illuminates in green. The indicator light goes off when the engine is running.

NOTE

- Your vehicle is equipped with an electronic immobilizer. To start the engine, the ID code which the F.A.S.T.-key sends must match the one registered to the immobilizer computer. Refer to “Electronic immobilizer (Anti-theft starting system)” on page 5-27.

Changing the operation mode

N00568001136

If you press the engine switch without pressing the brake pedal while the vehicle is stationary, you can change the operation mode in the order of OFF, ACC, ON, OFF.

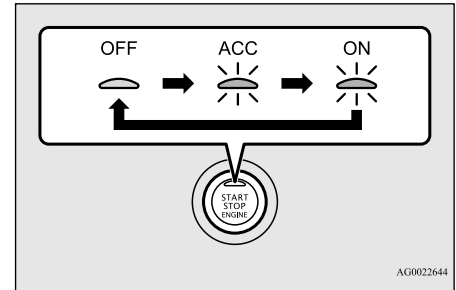

5

CAUTION

- When the engine is not running, put the operation mode in OFF. Leaving the operation mode in ON or ACC for a long time when the engine is not running may cause the battery to be discharged, making it impossible to start the engine.

⚠ CAUTION

- When the battery is disconnected, the current operation mode is memorized. After reconnecting the battery, the memorized mode is selected automatically. Before disconnecting the battery for repair or replacement, make sure to put the operation mode in OFF. Be careful if you are not sure which operation mode the vehicle is in when the battery is run down.
- The operation mode cannot be changed from OFF to ACC or ON if the F.A.S.T.-key is not detected to be in the vehicle. Refer to “Operating range for starting the engine and changing the operation mode” on page 5-15.
- When there is the F.A.S.T.-key in the vehicle and the operation mode is not changed, the battery in the F.A.S.T.-key may have worn out. Refer to “Warning activation” on page 5-20.

5

📖 NOTE

- If the operation mode cannot be changed to OFF, perform the following procedure.
 1. Move the selector lever to the “P” (PARK) position, and then change the operation mode to OFF.
 2. One of the other causes could be low battery voltage. If this occurs, the keyless entry system and the F.A.S.T.-key operation will also not operate. Contact an authorized Mitsubishi Motors dealer or a repair facility of your choice.

ACC power auto-cutout function

N00568101140

After approximately 30 minutes has elapsed with the operation mode in ACC, the function automatically cuts out the power for the audio system and other electric devices that can be operated with that mode.

When the engine switch is pressed while the operation mode is in ACC, the power is supplied again to those devices.

📖 NOTE

- It is possible to modify functions as follows:
 - The time until the power cuts out can be changed to approximately 60 minutes.
 - The ACC power auto-cutout function can be deactivated.

For details, we recommend you to consult an authorized Mitsubishi Motors dealer. On vehicles equipped with the SDA or the SDA navigation system, screen operations can be used to make the adjustment. Refer to the separate owner’s manual for details.

- When the ACC power is automatically cut out, you cannot lock and unlock the doors using the keyless entry system or F.A.S.T.-key operation.

Warning activation



N00503501327

With the F.A.S.T.-key, warnings are given through buzzers and displays on the information screen in the multi-information display in order to prevent mistaken operations or vehicle theft.



When a warning operates, be sure to check the vehicle and the F.A.S.T.-key. A warning is also displayed if there is a problem in the F.A.S.T.-key.

Item	Display	Buzzer	Solution	Note
Detection of failure		Inner buzzer sounds once	There is a problem in the F.A.S.T.-key.	—

Free-hand Advanced Security Transmitter (F.A.S.T.-key) (if so equipped)

Item	Display	Buzzer	Solution	Note
Fall of battery voltage		Inner buzzer sounds once	The battery of the F.A.S.T.-key is run down.	The warning is not activated if the battery is completely dead.
F.A.S.T.-key not detected	<p>Engine switch is pressed one time</p>  <p>Engine switch is pressed two times or more</p> 	Inner buzzer sounds once	<p>When the engine switch is pressed to change the operation mode from OFF or when the engine is started, the warning is activated, if any of the following conditions has occurred.</p> <ul style="list-style-type: none"> ● Carrying another F.A.S.T.-key with a different code, or the F.A.S.T.-key could be outside the operating range. ● The battery of the F.A.S.T.-key is dead. ● Communication is blocked by electric wave environment. <p>In such case, touch the F.A.S.T.-key to the engine switch to change the operation mode or start the engine.</p> <p>Refer to “If the F.A.S.T.-key is not operating properly” on page 5-25.</p>	—

Free-hand Advanced Security Transmitter (F.A.S.T.-key) (if so equipped)

Item	Display	Buzzer	Solution	Note
<p>F.A.S.T.-key take-out monitoring system</p>		<p>Inner buzzer sounds once</p> <p>Outer buzzer sounds intermittently</p>	<p>When the vehicle is parked with the operation mode in any mode other than OFF, if you close the door after opening any of the doors and taking the F.A.S.T.-key out of the vehicle, a warning is issued until the F.A.S.T.-key is detected in the vehicle.</p>	<ul style="list-style-type: none"> ● The F.A.S.T.-key take-out monitoring system does not function if the F.A.S.T.-key is removed through a window without opening a door. This setting can be changed. Contact an authorized Mitsubishi Motors dealer for details. ● The warning may display even if the F.A.S.T.-key is in the operating range for starting the engine and changing the operation mode. The surrounding environment or electromagnetic waves may make it impossible to verify the ID codes of the F.A.S.T.-key and vehicle.
<p>Key lock-in prevention system</p>		<p>Inner buzzer sounds once</p> <p>Outer buzzer sounds approximately 3 seconds intermittently</p>	<p>When the operation mode is in OFF, the F.A.S.T.-key is left in the passenger compartment, all the doors and the liftgate are closed, and someone tries to lock the vehicle by pressing the driver's or front passenger's door lock/unlock switch, or the liftgate lock switch, a warning is issued and you cannot lock the doors and liftgate.</p>	<p>Make sure you have the F.A.S.T.-key with you before locking the doors. Even if you leave the F.A.S.T.-key inside the vehicle, it is possible that the doors will lock depending on the surrounding environment and wireless signal conditions.</p>

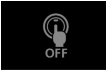
Item	Display	Buzzer	Solution	Note
Door ajar prevention system		Inner buzzer sounds once Outer buzzer sounds approximately 3 seconds intermittently	When the operation mode is in OFF, and someone tries to lock the vehicle by pressing the driver's or front passenger's door lock/unlock switch, or the liftgate lock switch while one of the doors or the liftgate is not fully closed, a warning is issued and you cannot lock the doors and liftgate.	—
Operation mode OFF reminder system		Inner buzzer sounds once Outer buzzer sounds approximately 3 seconds intermittently	When the operation mode is in any mode other than OFF, someone tries to lock the vehicle by pressing the driver's or front passenger's door lock/unlock switch, or the liftgate lock switch, a warning is issued and you cannot lock the doors and liftgate.	—

Starting and stopping the engine

N00514601416

Tips for starting

- The operation mode can be in any mode to start the engine.

- The starter motor will be turning for up to approximately 15 seconds if the engine switch is released at once. Pressing the engine switch again while the starter motor is still turning will stop the starter motor.

The starter motor will be turning for up to approximately 30 seconds while the engine switch is pressed.

If the engine does not start, wait for a while and then attempt to start the engine again. Trying repeatedly with the engine or starter motor still turning will damage the starter mechanism.

- If the engine will not start because the battery is weak or discharged, refer to “Jump-starting the engine” on page 8-2 for instructions.
- A longer warm up period will only consume extra fuel.

The engine is warmed up enough for driving when the bar graph of engine coolant temperature display starts to move. Refer to “Engine coolant temperature display” on page 5-150.

WARNING

- Never run the engine in a closed or poorly ventilated area any longer than is needed to move your vehicle out of the area. Carbon monoxide gas, which is odorless and extremely poisonous, could build up and cause serious injury or death.

CAUTION

- Do not push-start the vehicle.
- Do not run the engine at high rpms or drive at high speeds until the engine has had a chance to warm up.

Starting the engine

Your vehicle is equipped with an electronically controlled fuel injection system. This system automatically controls fuel injection. There is usually no need to depress the accelerator pedal when starting the engine. To prevent battery drain, wait a few seconds between attempts to restart the engine.

1. Make sure all occupants are properly seated with seat belts fastened.
2. Make sure the parking brake is applied.
3. Press and hold the brake pedal down firmly with your right foot.

NOTE

- After the engine has not started for a while, the brake pedal effort needed to start the engine may become greater. If this occurs, depress the brake pedal more firmly than usual.

4. Make sure the selector lever is in the “P” (PARK) position.

NOTE

- The engine can only be started when the selector lever is in the “P” (PARK) or “N” (NEUTRAL) position. For safety reasons, the engine should be started when the selector lever is in the “P” (PARK) position in which the driving wheels lock.

5. Press the engine switch.
6. Confirm that all warning lights and warning displays are functioning properly.

NOTE

- Minor noises may be heard on engine start-up. These will disappear as the engine warms up.

When the engine is hard to start

After several attempts, you may experience that the engine still does not start.

1. Make sure that all electric devices, such as lights, air conditioning blower and rear window defogger, are turned off.
2. While depressing the brake pedal, press the accelerator pedal halfway and hold it there, then crank the engine. Release the accelerator pedal, immediately after the engine starts.

3. If the engine still will not start, the engine could be flooded with too much gasoline. While depressing the brake pedal, push the accelerator pedal all the way down and hold it there, then press the engine switch to crank the engine. If the engine does not start after 5 to 6 seconds, push the engine switch to stop cranking the engine, and release the accelerator pedal. Put the operation mode in OFF. Wait a few seconds, and then press the engine switch to crank the engine again while depressing the brake pedal, but do not push the accelerator pedal. If the engine fails to start, repeat these procedures. If the engine still will not start, contact your local Mitsubishi Motors dealer or a repair facility of your choice for assistance.

Startability of the engine with an ambient temperature of -22 °F (-30 °C) or lower

When the ambient temperature is -22 °F (-30 °C) or lower, it may not be possible to start from a standstill even with the selector lever in the “D” (DRIVE) or “R” (REVERSE) position.

This phenomenon occurs because the transaxle has not warmed up sufficiently; it does not indicate a problem. If this occurs, place the selector lever in the “P” (PARK) position and let the engine idle for at least 10 minutes.

The transaxle will warm up, and you will be able to start normally.

Do not leave the vehicle during warm-up operation.

Stopping the engine

N00568201053

WARNING

- Do not operate the engine switch while driving except in an emergency. If the engine is stopped while driving, the brake servomechanism will cease to function and braking efficiency will deteriorate. Also, the power steering system will not function and it will require greater manual effort to operate the steering. This could result in a serious accident.

NOTE

- If you have to bring the engine to an emergency stop while driving, press and hold the engine switch for 3 seconds or more, or press it quickly three times or more. The engine will stop and the operation mode will go to ACC.

NOTE

- Do not stop the engine with the selector lever in any position other than the “P” (PARK) position. If the engine is stopped with the selector lever in any position other than the “P” (PARK) position, the operation mode will go to ACC rather than OFF. Put the operation mode in OFF after placing the selector lever in the “P” (PARK) position.

1. Stop the vehicle.
2. Fully engage the parking brake while depressing the brake pedal.
3. Move the selector lever to the “P” (PARK) position, and then press the engine switch to stop the engine.

If the F.A.S.T.-key is not operating properly

N00568301113

The following operation can be used to start the engine or change the operation mode.

1. Depress the brake pedal firmly with your right foot.
2. While depressing the brake pedal, touch the portion of the F.A.S.T.-key shown in the illustration to the engine switch.



AFA116981

5

3. If the F.A.S.T.-key is recognized, the indicator light on the engine switch illuminates in green, and then the engine can be started and the operation mode can be changed within approximately 10 seconds. Refer to “Starting and stopping the engine” on page 5-23 and “Changing the operation mode” on page 5-19.

NOTE

- If metal objects or other keys are near the F.A.S.T.-key, the F.A.S.T.-key may not be recognized.
- Instead of depressing the brake pedal, the F.A.S.T.-key can also be recognized in the same way within approximately 30 seconds after pushing the engine switch.
- To change the operation mode without starting the engine, release the brake pedal after the indicator light on the engine switch illuminates in green, and then push the engine switch.

To operate without using the F.A.S.T.-key

N0051480017

Emergency key

N00515201204

The emergency key is built into the F.A.S.T.-key.

When the F.A.S.T.-key cannot be used, such as when the battery of the F.A.S.T.-key or the vehicle has run down, the emergency key can be used to lock and unlock the driver's door.

To use the emergency key (A), unlock the lock knob (B) and remove it from the F.A.S.T.-key (C).

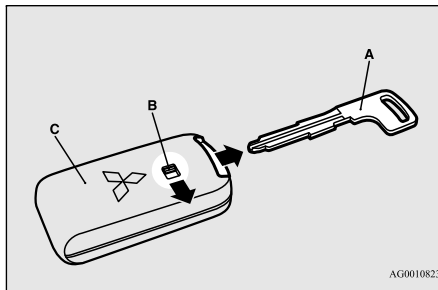

AG0010823

NOTE

- Only use the emergency key in an emergency. When the battery of the F.A.S.T.-key has run down, replace the battery as soon as possible and use it as a F.A.S.T.-key again.
- After using the emergency key, be sure to reinsert it into the F.A.S.T.-key.

Locking and unlocking the driver's door

Turn the emergency key toward the front of the vehicle to lock the door. After checking that the door is locked, turn the emergency key back to the center and remove it.

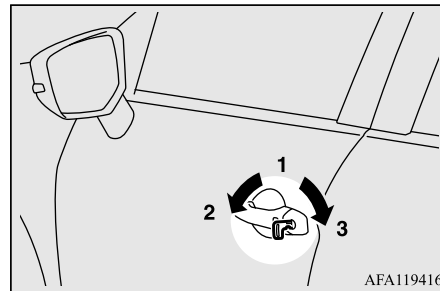

AFA119416

- 1- Insert or remove the emergency key
- 2- Lock
- 3- Unlock

Electronic immobilizer (Anti-theft starting system)

N00529601140

The electronic immobilizer is designed to significantly reduce the possibility of vehicle theft. The purpose of the system is to immobilize the vehicle if an invalid start is attempted. A valid start attempt can only be achieved (subject to certain conditions) using a F.A.S.T.-key “registered” to the immobilizer system.

All of the keys provided with your new vehicle have been programmed to the vehicle’s electronics.

NOTE

- If the engine does not start, contact an authorized Mitsubishi Motors dealer.

Replacement F.A.S.T.-keys

N00561000042

Only the F.A.S.T.-keys that have been programmed to the vehicle’s electronics can be used to start the vehicle.

If you lose the F.A.S.T.-key, you can order a F.A.S.T.-key from your authorized Mitsubishi Motors dealer by referring to the key number. To prevent vehicle theft, take your vehicle and the remaining F.A.S.T.-keys to an autho-

rized Mitsubishi Motors dealer to have the ID codes reprogrammed.

Additional F.A.S.T.-keys

N00561101066

To add a F.A.S.T.-key, you must already have two registered F.A.S.T.-keys. You need to register the ID code to the vehicle.

Registering the ID code can be done by your authorized Mitsubishi Motors dealer. Or it can be done by yourself (except for vehicles sold in Canada).

For you to register the ID code yourself, follow the “Customer F.A.S.T.-key programming” procedure below.

If you choose to have your authorized Mitsubishi Motors dealer register the ID code, take your vehicle and all remaining F.A.S.T.-keys to your authorized Mitsubishi Motors dealer.

NOTE

- You are provided with two F.A.S.T.-keys, but you may register up to four F.A.S.T.-keys.
You can obtain blank F.A.S.T.-keys specially cut for your vehicle from your Mitsubishi Motors dealer.

Customer F.A.S.T.-key programming (Except for vehicles sold in Canada)

N00561201315

You can program new F.A.S.T.-keys to the system if you have two valid (already registered) F.A.S.T.-keys and a blank (not registered) F.A.S.T.-key.

For F.A.S.T.-key programming, follow the procedures below.

1. Open the driver’s door.

NOTE

- Keep the driver’s door open until F.A.S.T.-key programming is finished. Do not open or close other doors.

2. While carrying the first valid F.A.S.T.-key, put the operation mode in ON. (Perform the following procedure within 30 seconds.)
3. With the first valid F.A.S.T.-key, press the UNLOCK button for 4 to 8 seconds and press the LOCK button during this time.
4. Release in sequence the LOCK and UNLOCK buttons within 8 seconds of pressing the LOCK button in step 3. (Perform the following procedure within 30 seconds.)

5

5. With the second valid F.A.S.T.-key, press the UNLOCK button for 4 to 8 seconds and press the LOCK button during this time.
6. Release in sequence the LOCK and UNLOCK buttons within 8 seconds of pressing the LOCK button in step 5. The immobilizer display on the information screen in the multi-information display will blink. (Perform the following step within 20 seconds.)



7. Touch the portion of the new F.A.S.T.-key shown in the illustration to the engine switch.

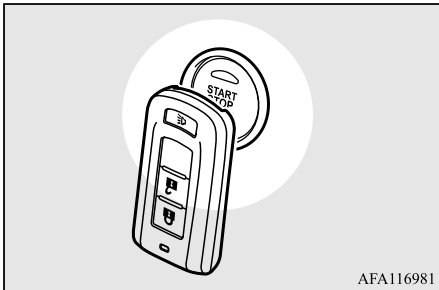

AFA116981

When registration of ID code is complete, the buzzer will sound three times and the immobilizer display will come on for 30 seconds.

If an error occurs, F.A.S.T.-key programming will be terminated and the buzzer will sound for 3 seconds.

NOTE

- F.A.S.T.-key programming will be terminated if the operation mode is put in OFF before the immobilizer display starts blinking.

8. If you wish to register another F.A.S.T.-key, repeat the process from step 1 after the operation mode is put in OFF.

NOTE

- The immobilizer display will go off immediately if the operation mode is put in OFF.
- Perform the operation when the interrupt display screen is not showing. The interrupt display screen may prevent you from seeing the immobilizer display.
- It is not possible to register a F.A.S.T.-key if the immobilizer display goes off during the procedure.

Keyless entry system

N00515501425

Press the key buttons to lock or unlock the doors and the liftgate. It can also help you signal for attention by setting off the panic alarm.

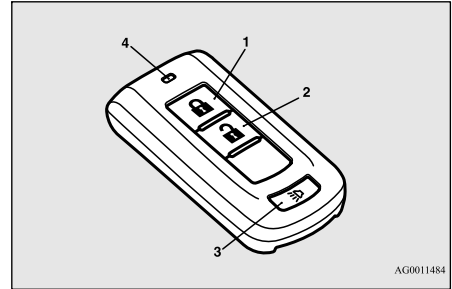

AG0011484

- 1- LOCK (🔒) button
- 2- UNLOCK (🔓) button
- 3- PANIC button
- 4- Operation indicator light

NOTE

- The outside rearview mirrors automatically retract or extend when the doors and the liftgate are locked or unlocked using the key buttons. Refer to “Operation of the outside rearview mirrors” on page 5-18 and “Outside rearview mirrors” on page 5-57.

To lock

Press the LOCK button (1) to lock all the doors and the liftgate.

The turn signal lights will also blink once.

NOTE

- If you press the LOCK button (1) twice, the horn will sound once.

To unlock

Press the UNLOCK button (2) to unlock the driver's door only.

Within approximately 2 seconds, press the UNLOCK button one more time to unlock all the doors and liftgate.

The dome light will turn on for 30 seconds.

The turn signal lights will also blink twice.

The front side-marker and parking lights will also turn on for approximately 30 seconds.

Refer to "Welcome light" on page 5-201.

NOTE

- If the UNLOCK button (2) is pressed when no doors or the liftgate are opened within approximately 30 seconds, the doors and the liftgate will automatically re-lock. On vehicles equipped with the SDA or the SDA navigation system, the functions can be adjusted on the screen. For details, refer to the separate owner's manual.
- The door and liftgate unlock function can be set so that all doors and liftgate unlock when the UNLOCK button (2) is pressed once. Refer to "Setting of door and liftgate unlock function" on page 5-30.

Answerback function

N00544501124

The horn and turn signal lights of the keyless entry system answerback function can be changed as required. This is done with the operation mode in OFF.

■ Horn deactivation/reactivation

N00597200061

The answerback function can be set in the following three ways.

Each time the answerback function is set, a chime will sound to tell you the condition of the answerback function.

Number of chimes	Condition
One chime	The horn will not sound.
Two chimes	The horn will sound.
Four chimes	The horn will sound if the LOCK button (1) is pressed twice within 1 second.

5

To change the setting, refer to "Customizing the Free-hand Advanced Security Transmitter (F.A.S.T.-key)" on page 5-32.

NOTE

- On vehicles equipped with the SDA or the SDA navigation system, the functions can be adjusted on the screen. For details, refer to the separate owner's manual.

■ Turn signal lights deactivation/reactivation

N00597300062

The answerback function from the turn signal lights can be turned ON or OFF separately.

To change the setting, refer to "Customizing the Free-hand Advanced Security Transmitter (F.A.S.T.-key)" on page 5-32.

Number of chimes	To lock	To unlock
One chime	One flash	Two flashes
Two chimes	One flash	No flash
Three chimes	No flash	Two flashes
Four chimes	Two flashes	One flash
Five chimes	No flash	One flash
Six chimes	Two flashes	No flash
Seven chimes	No flash	No flash

 **NOTE**

- On vehicles equipped with the SDA or the SDA navigation system, the functions can be adjusted on the screen. For details, refer to the separate owner's manual.

■ **Buzzer deactivation/reactivation**

N00597400063

The buzzer answerback function can be turned ON or OFF as required.

 **NOTE**

- On vehicles equipped with the SDA or the SDA navigation system, the functions can be adjusted on the screen. For details, refer to a separate owner's manual.

Setting of door and liftgate unlock function

N00544601284

The door and liftgate unlock function can be set to the following two conditions. Each time the door and liftgate unlock function is set, a chime will sound to tell you the condition of the door and liftgate unlock function.

Number of chimes	Condition
One chime	When the UNLOCK button (2), driver's or front passenger's door lock/unlock switch, or liftgate open switch is pressed one time, all doors and the liftgate unlock.
Two chimes	When the UNLOCK button (2) or the driver's door lock/unlock switch is pressed one time, only the driver's door unlocks. Within approximately 2 seconds, press the UNLOCK button or the driver's door lock/unlock switch one more time to unlock all the doors and the liftgate. [Factory setting]

To change the setting, refer to "Customizing the Free-hand Advanced Security Transmitter (F.A.S.T.-key)" on page 5-32.

 **NOTE**

- On vehicles equipped with the SDA or the SDA navigation system, the functions can be adjusted on the screen. For details, refer to the separate owner's manual.

Using the panic alarm

N00544701201

If you are near your vehicle and feel threatened, you can activate the alarm to call attention as follows:

1. Press the PANIC button (3) for more than 1 second.
2. The headlights will blink on and off and the horn will sound intermittently for approximately 3 minutes.
3. To turn off the alarm, press any button on the key.

 **NOTE**

- The indicator light (4) comes on each time a button is pressed.

 **NOTE**

- The F.A.S.T.-key can be used from approximately 40 feet (12 m) away. However, this distance may change if your vehicle is near a TV transmitting tower, a power station, or a radio station.
- If the following conditions are observed after pressing the LOCK (1) or UNLOCK (2) button on the key, the battery in the F.A.S.T.-key may need to be replaced.
 - The doors and the liftgate cannot be locked or unlocked.
 - The panic alarm cannot be operated.
 - The indicator light (4) is dim or does not come on.
- If you lose your F.A.S.T.-key, please contact an authorized Mitsubishi Motors dealer for a replacement.
- If you wish to obtain an additional F.A.S.T.-key, please contact an authorized Mitsubishi Motors dealer. A maximum of four F.A.S.T.-keys can be programmed for your vehicle.
- To use the new keys, it is necessary to register the key with both the electronic immobilizer and keyless entry system.
Also refer to “Electronic immobilizer (Anti-theft starting system): Customer F.A.S.T.-key programming” on page 5-27.

Customizing the Free-hand Advanced Security Transmitter (F.A.S.T.-key)



N00596600068

You can change the settings for the following functions according to your preferences. When changing a setting, perform the following steps.

1. Put the operation mode in OFF.
2. Open the driver's door and turn the combination headlights and dimmer switch to the "OFF" position (except for vehicles equipped with the automatic control) or the "AUTO" position (for vehicles equipped with the automatic control).
3. Complete steps i to iv of the procedure. Steps ii to iv should be completed within 8 seconds.

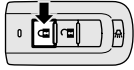
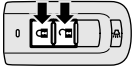
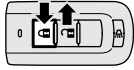
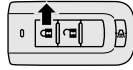
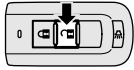
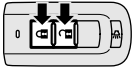
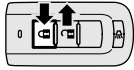
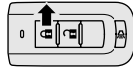
5

Item	Step i	Step ii	Step iii	Step iv	Notification
Horn deactivation/reactivation	<p>Press and hold the LOCK button (1) for 4 to 8 seconds.</p> 	<p>While holding the LOCK button (1), press the UNLOCK button (2).</p> 	<p>While holding the LOCK button (1), release the UNLOCK button (2).</p> 	<p>Release the LOCK button (1).</p> 	Chimes → Page 5-29
Turn signal lights deactivation/reactivation	<p>Press and hold the UNLOCK button (2) for 4 to 8 seconds.</p> 	<p>While holding the UNLOCK button (2), press the LOCK button (1).</p> 	<p>While holding the LOCK button (1), release the UNLOCK button (2).</p> 	<p>Release the LOCK button (1).</p> 	Chimes → Page 5-29

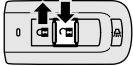
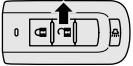
Item	Step i	Step ii	Step iii	Step iv	Notification
Setting of door and liftgate unlock function	<p>Press and hold the LOCK button (1) for 4 to 8 seconds.</p> 	<p>While holding the LOCK button (1), press the UNLOCK button (2).</p> 	<p>While holding the UNLOCK button (2), release the LOCK button (1).</p> 	<p>Release the UNLOCK button (2).</p> 	<p>Chimes → Page 5-30</p>

NOTE

- Be sure to press the buttons correctly when performing the procedures. If you perform the procedures incorrectly, the settings could be changed unintentionally.

General information

N00562001091

Your F.A.S.T.-key operates on a radio frequency subject to Federal Communications Commission (FCC) Rules (For vehicles sold in U.S.A.) and Industry Canada Rules (For vehicles sold in Canada). This device complies with Part 15 of FCC Rules and Industry Canada’s applicable licence-exempt RSS standard(s). Operation is subject to the following two conditions.

- This device may not cause harmful interference, and
- This device must accept any interference received, including interference that may cause undesired operation of this device.

CAUTION

- Changes or modifications not expressly approved by the party responsible for compliance could void the user’s authority to operate the equipment.

Procedure for replacing the key battery

N00562101249

WARNING

- Do not swallow a coin type battery.

WARNING

- This product contains coin type battery. If a coin type battery is swallowed, it can cause severe internal burns and can lead to death. There have been cases where a swallowed battery has caused severe internal burns in just 2 hours.
- Keep new and used batteries away from children.
- If the key case does not close securely, stop using the product and keep it away from children.
- If you think batteries might have been swallowed or placed inside any part of a person’s body, seek immediate medical attention.
- To prevent an explosion or leakage of flammable liquid or gas:

⚠ WARNING

- Do not replace the battery with an incorrect type. Replace only with the same or equivalent type.
- Do not dispose of a battery into a fire or incinerator, or by mechanically crushing or cutting the battery.
- Do not use, store, or take a battery any place where it may be exposed to extremely high temperature or extremely low air pressure.

⚠ CAUTION

- When the key case is opened, be careful to keep water, dust, etc. out. Also, do not touch the internal components.
- Dispose of used battery according to regulations for the disposal of battery.

1. Before replacing the battery, remove static electricity from your body by touching a metal grounded object.
2. Remove the emergency key from the key.
3. With the Mitsubishi mark facing you, insert the cloth-covered tip of a flat blade screwdriver into the notch in the case and use it to open the case.

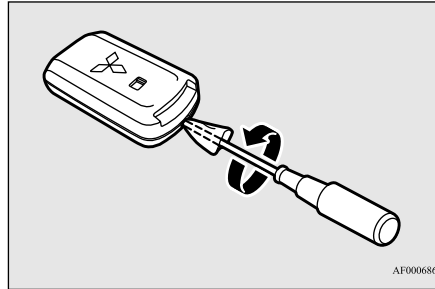

AF0006861

📖 NOTE

- Be sure to perform the procedure with the Mitsubishi mark facing you. If the Mitsubishi mark is not facing you when you open the case, the transmitter may come out.

4. Remove the used battery.
5. Install a new battery with the + side (A) up.

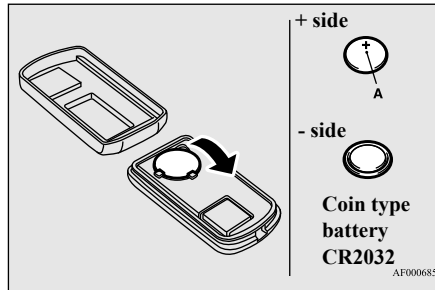

AF0006858

6. Close the case firmly.
7. Install the emergency key removed in step 2.
8. Check the keyless entry system to see that it works.

📖 NOTE

- You may purchase a replacement battery at an electric appliance store.
- An authorized Mitsubishi Motors dealer can replace the battery for you if you prefer.

Door locks

N00509201586

⚠ WARNING

- Make sure all doors are tightly closed and locked while driving.
- Locked doors, in combination with the use of seat belts, can help reduce the risk of ejection in an accident.
- Locked doors can help keep passengers, especially small children, from opening doors and falling out of moving vehicles.
- Locked doors can help prevent outsiders from gaining access to your vehicle when you slow or come to a stop.

⚠ WARNING

- Lock your vehicle whenever you leave it. Children who get into unlocked vehicles may not be able to get out. Children trapped inside vehicles can quickly be overcome by heat and suffer serious injury or death due to heat stroke.
- Never leave a child alone in the vehicle. In addition to the risk of heat stroke, children can activate switches and controls, resulting in an injury or fatal accident.
- When closing a door, make sure that the door is fully closed and the door-ajar warning display goes out on the information screen on the multi-information display. If the door is ajar it could open while driving and cause an accident.

To lock and unlock with the key (driver's door)

Turn the key toward the front of the vehicle to lock the door. After checking that the door is locked, turn the key back to the center and remove it.

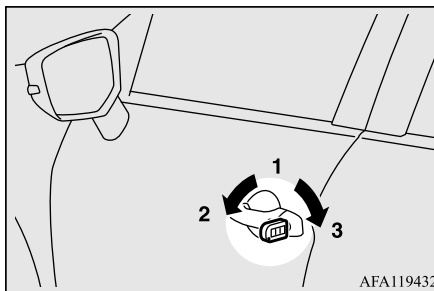

- 1- Insert or remove the key
- 2- Lock
- 3- Unlock

📖 NOTE

- When locking or unlocking with the key, only the driver's door will be locked or unlocked. To lock or unlock all doors and liftgate, use the power door lock switch, the keyless entry system or the F.A.S.T.-key operation. Refer to "Power door locks" on page 5-37, "Keyless entry system" on pages 5-6 and 5-28, and "To operate using the F.A.S.T.-key" on page 5-16.
- In vehicles equipped with the F.A.S.T.-key, the driver's door can be locked and unlocked using the emergency key. Refer to "Emergency key" on page 5-26.

To lock or unlock the door from the inside

Move the lock knob to the lock position to lock the door.

All doors should be kept locked while driving.

5

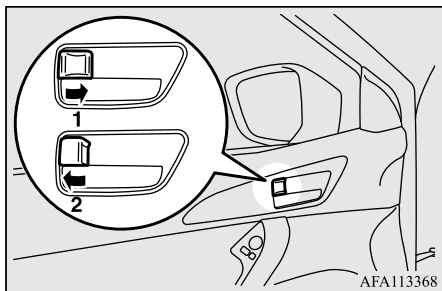

- 1- Lock
- 2- Unlock

The driver's door can be unlocked without using the lock knob by pulling on the inside door handle.

To lock the door without using the key

1. Move the inside lock knob to the locked position.

2. Be sure the keys are not inside the vehicle. Close the door.

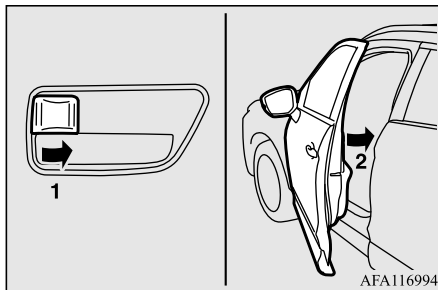

Key reminder system (except for vehicles equipped with the F.A.S.T.-key)

N00549601263

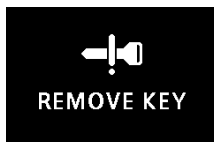

If the ignition switch is turned to the "OFF" position and the driver's door is opened with the key in the ignition switch, the key reminder buzzer will sound intermittently to remind you to remove the key.

The warning display will be displayed on the information screen in the multi-information display.

Lock out protection

N00517301078

If the ignition switch is turned to the "ON" position or the operation mode is in any mode other than OFF, when you push the lock knob forward with the driver's door or passenger's door open, the lock knob will automatically return to the unlocked position.

Operation mode ON reminder system (vehicles equipped with F.A.S.T.-key)

N00503801173



If the driver's door is opened while the engine is stopped and the operation mode is in any mode other than OFF, the operation mode ON buzzer will sound intermittently to remind you put the operation mode in OFF. The warning display will be displayed on the information screen in the multi-information display.

Power door locks

N00509301659

NOTE

- When locking or unlocking with the key on the driver's door, only the driver's door will lock or unlock.
- Repeated continuous operation between lock and unlock could activate the power door locking system's built-in protection circuit, and prevent the system from operating. If this occurs, wait approximately 1 minute before operating the power door lock switch.

To lock and unlock the doors and liftgate

Using the power door lock switch

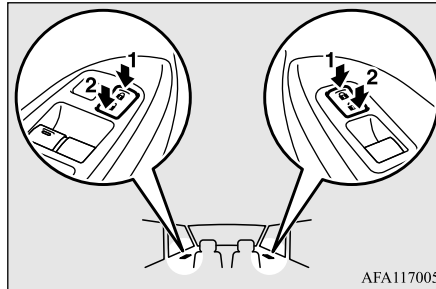

- 1- Lock
2- Unlock

All of the doors and the liftgate can be locked or unlocked by pressing the power door lock switch on the driver's or the front passenger door.

To unlock the doors and liftgate

N00563401281

You can select the functions to unlock the doors and liftgate either using the ignition switch position or the engine switch, or using the selector lever position.

These functions are not activated when the vehicle is shipped from the factory. To activate or deactivate these functions, please contact your authorized Mitsubishi Motors dealer.

Using the ignition switch or the engine switch

All doors and the liftgate will unlock when the ignition switch is turned to the "OFF" position or the operation mode is put in OFF.

Using the selector lever position

All doors and the liftgate will unlock when the selector lever is moved to the "P" (PARK) position with the ignition switch in the "ON" position or the operation mode in ON.

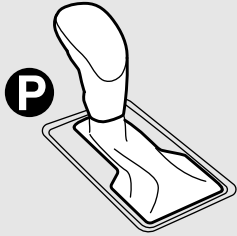

AFA113397

5

NOTE

- On vehicles equipped with the Smartphone-link Display Audio (SDA) or the Smartphone-link Display Audio (SDA) navigation system, the functions can be adjusted on the screen. For details, refer to a separate owner's manual.

Child safety locks for rear door

N00509401328

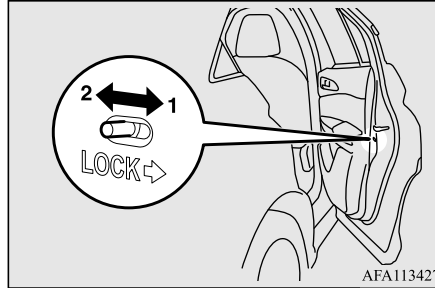

AFA113427

- 1- To lock
- 2- To release

Child safety locks help prevent rear passengers, especially children, from opening the rear door using the inside door handle.

A lock lever for the child safety lock is provided on each rear door.

When the lever is in the lock position (1), the rear door cannot be opened using the inside door handle.

To open the rear door when the child safety lock lever is in the lock position, pull the outside door handle.

When the lever is in the release position (2), the child safety lock is released and the rear

door can be opened using the inside door handle.

WARNING

- Always keep the doors tightly closed and locked when driving. An unlocked door may be accidentally opened by a passenger, especially by a child who could fall out. Also, if the doors are not locked, there is a greater risk of someone being thrown from the vehicle in an accident.

Liftgate

N00510101396

WARNING

- The luggage compartment was not designed for people to ride in it. Do not let passengers ride in or let children play in the luggage compartment. Riding or playing in the luggage compartment could result in a serious accident or injury.

- Before driving, be sure that the liftgate is securely closed. It is dangerous to drive with the liftgate open since carbon monoxide (CO) gas contained in engine exhaust gases can enter the passenger compartment.

CO is an invisible, odorless gas that can cause unconsciousness and even death.

In addition, if the liftgate opens while driving, luggage could fall onto the road and cause an accident.

⚠ WARNING

- When opening and closing the liftgate, make sure that there are no people nearby and be careful not to hit your head or pinch your hands, neck, etc.
- If snow or ice has accumulated on the liftgate, remove it before opening the liftgate. Otherwise the liftgate may abruptly close due to the weight of the snow or ice.
- When opening the liftgate, always fully open it. A partially opened liftgate can unexpectedly close due to its own weight.
- When the vehicle is parked on a slope, the effort required to open or close the liftgate may be greater or less than expected. The liftgate may also open or close more quickly.

⚠ CAUTION

- Do not stand behind the exhaust pipe when loading and unloading luggage. Heat from the exhaust could lead to burns.
- To avoid damage to the liftgate, make sure that area above and behind the liftgate is clear before opening it.

📖 NOTE

- Locking and unlocking the doors by using power door locks (driver and front passenger side), keyless entry system, or F.A.S.T.-key operation (vehicles equipped with the F.A.S.T.-key) also locks and unlocks the liftgate.

To open**To open from outside the vehicle**

1. After unlocking, push the liftgate open switch (A) and pull up the liftgate.

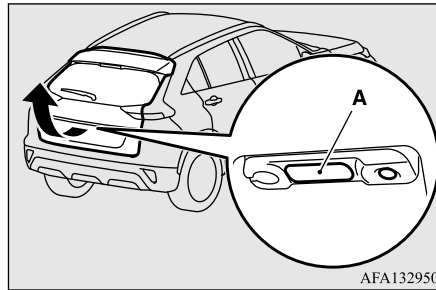
**⚠ CAUTION**

- Make sure there is no one standing nearby when opening the liftgate.

📖 NOTE

- The liftgate cannot be opened if it is not raised immediately after pressing the liftgate open switch. If this happens, press the liftgate open switch again and raise the liftgate.
- The liftgate cannot be opened when the battery is discharged or disconnected. The liftgate must then be opened using the inside liftgate release.
- When the battery is reconnected, all doors and the liftgate will be locked. Unlock them before trying to open the liftgate.
- On vehicles equipped with the mirror retractor switch, the outside rearview mirrors automatically extend when the liftgate and all doors are unlocked using the liftgate open switch (A).

To open from inside the vehicle

The liftgate can also open from the inside of vehicle. It is designed to provide a way to open the liftgate if the battery is dead or disconnected.

1. Open the lid (A) inside of the liftgate.

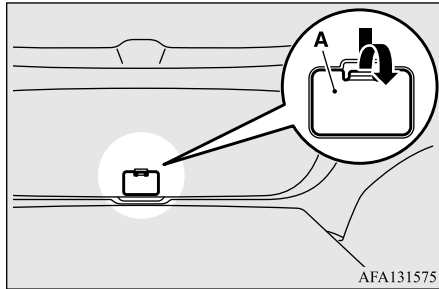

2. Move the lever (B) to unlock the liftgate.

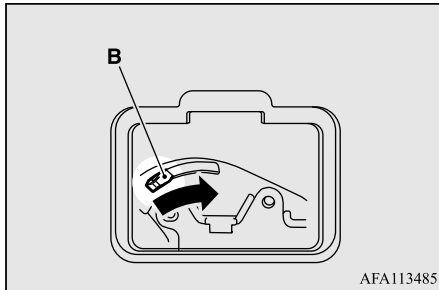

3. Push out on the liftgate to open it.

WARNING

- Always keep the release lever lid on the liftgate closed when driving so that your luggage cannot accidentally bump the lever and open the liftgate.

To close

1. Pull the liftgate grip (A) downward as illustrated and release it before the liftgate closes completely. Gently slam the liftgate from the outside so that it is completely closed.

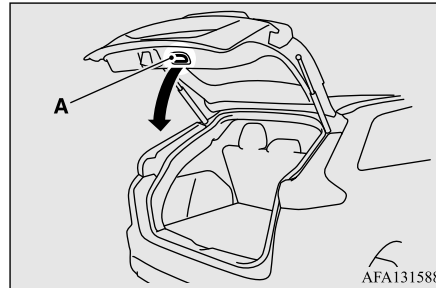

CAUTION

- To avoid injuring your hand or arm, do not attempt to close the liftgate without releasing the liftgate grip (A).
- Before starting the vehicle, be sure to confirm that the liftgate is locked. If the liftgate opens while driving the vehicle, objects stored in the luggage compartment could fall out into the road.

NOTE

- Gas struts (B) are installed in the locations illustrated in order to support the liftgate.

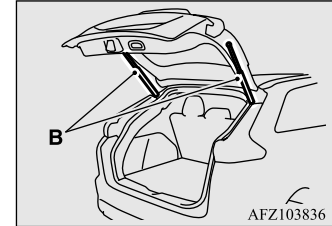

Please observe the following in order to prevent damage or faulty operation:

- Do not touch, push or pull the gas struts when closing the liftgate.
- Do not attach any plastic material, tape, etc., to the gas struts.
- Do not tie string, etc., around the gas struts.
- Do not hang objects on the gas struts.

Theft-alarm system

N00510201267

The theft-alarm system is designed to provide protection from unauthorized entry into the vehicle. This system is operated in three stages: the first is the “armed” stage, the second is the “alarm” stage, and third is the “disarmed” stage. If triggered, the system provides both audible and visual alarm signals.

⚠ CAUTION

- Do not modify or add parts to the theft-alarm system. Doing so could cause the theft-alarm to malfunction.

Armed stage

N00510301239

Park the vehicle and stop the engine. Arm the system as described below.

- Except for vehicles equipped with the F.A.S.T.-key, remove the key from the ignition switch.
For vehicles equipped with the F.A.S.T.-key, put the operation mode in OFF.
- Make sure that the engine hood is closed.
- Lock all doors and the liftgate by using the keyless entry system or the F.A.S.T.-key operation.

Arm the system and leave

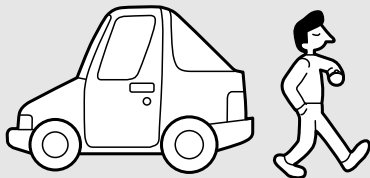

AA0056858

At this time, the theft-alarm indicator (A) on the instrument panel flashes for confirmation.

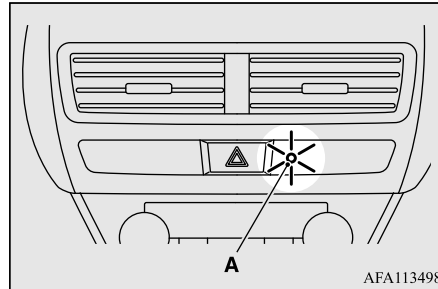

AFA113498

- The system has entered the armed stage after approximately 20 seconds, when the theft-alarm indicator (A) flashing becomes slower.
The theft-alarm indicator (A) continues to flash while the system is in the armed stage.

NOTE

- If the engine hood is open, the theft-alarm indicator (A) illuminates and the system cannot enter the armed stage.
The system enters the armed stage approximately 20 seconds after the engine hood is closed.

NOTE

- The system will be disarmed if, while the theft-alarm indicator (A) is illuminated, all doors and the liftgate are unlocked by using the keyless entry system or the F.A.S.T.-key operation.
- The system will be disarmed if, while the theft-alarm indicator is illuminated, the following operation is performed.
 - Except for vehicles equipped with the F.A.S.T.-key, if the ignition switch is turned to the "ON" position.
 - For vehicles equipped with the F.A.S.T.-key, if the operation mode is put in ON.
- The system will not be armed if a door, the liftgate or the engine hood is not completely closed. If this happens, rearm the system as described above.
- The theft-alarm system can be activated when people are riding inside the vehicle or when the windows are open. To prevent accidental activation of the alarm, do not set the system to the system armed mode while people are riding in the vehicle.

Alarm stage

N00510401243

The alarm will be activated if any of the following occur while the vehicle is parked and the system is armed.

Theft-alarm system

- One of the doors and the liftgate is opened without using the keyless entry system or the F.A.S.T.-key operation.
- The engine hood is opened.

Type of alarm

N00582500053

5

When the alarm is activated:

1. The headlights blink on and off for 3 minutes.
After 3 minutes the headlights automatically shut off.
2. The horn will sound intermittently for 3 minutes.

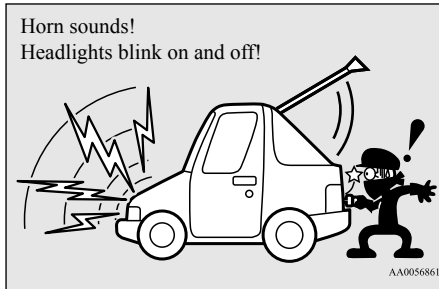

NOTE

- The alarm will continue to operate for 3 minutes. At the end of that period, the alarm will automatically shut off to save battery power. The system will then be rearmed until the proper disarming step is taken.
- The alarm will resume if unauthorized actions are taken again, even if the alarm has stopped.

Alarm deactivation

N00582600041

The alarm can be deactivated in the following ways.

- By using the keyless entry system or the F.A.S.T.-key operation to lock or unlock the doors and liftgate.
- Except for vehicles equipped with the F.A.S.T.-key, by turning the ignition switch to the “ON” position.
- For vehicles equipped with the F.A.S.T.-key, by putting the operation mode in ON.

Disarmed stage

N00510501257

The system will be disarmed if the following operation is performed.

- Except for vehicles equipped with the F.A.S.T.-key, if the ignition switch is turned to the “ON” position.
- For vehicles equipped with the F.A.S.T.-key, if the operation mode is put in ON.
- All doors and the liftgate are unlocked by using the keyless entry system or the F.A.S.T.-key operation.

Disarm...by using the keyless entry system or F.A.S.T.-key operation

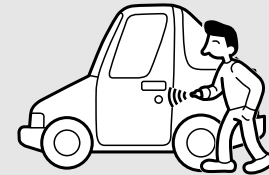

NOTE

- If the UNLOCK button on the key, or the driver's or front passenger's door lock/unlock switch is pressed when all doors and the liftgate are closed and no door is opened within approximately 30 seconds, rearming will automatically occur.

NOTE

- The amount of time after unlocking until the vehicle relocks automatically can be adjusted. See an authorized Mitsubishi Motors dealer for details.
On vehicles equipped with the Smartphone-link Display Audio (SDA) or the Smartphone-link Display Audio (SDA) navigation system, the functions can be adjusted on the screen. For details, refer to a separate owner's manual.
- Once the system has been disarmed, it cannot be rearmed except by repeating the arming procedure.

Testing the theft-alarm system

N00510601160

Use the following procedure to test the system:

1. Lower the driver's window.
2. Arm the system as explained in "Armed stage".
3. Make sure that the theft-alarm indicator comes on and flashes for approximately 20 seconds.
4. Wait a few seconds and then unlock the driver's side door by using the inside door lock knob. Open the door.
5. Make sure that the horn sounds intermittently and the headlights blink when a door is opened.

6. Disarm the system by unlocking all doors and the liftgate by using the keyless entry system or the F.A.S.T.-key operation.

Power window control

N00510801436

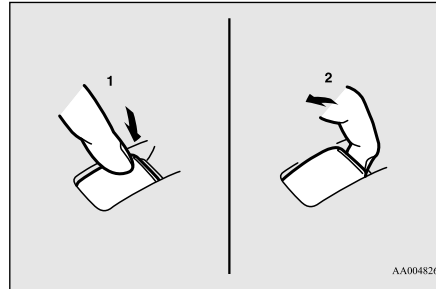

AA0048266

- 1- Open (down)
- 2- Close (up)

NOTE

- Never try to operate the main switch and sub-switch in different directions at the same time. This will freeze the window in position.
- Operating the power windows repeatedly with the engine stopped will run down the battery. Use the window switches only while the engine is running.

WARNING

- Before operating the power windows, make sure that nothing is capable of being trapped (head, hands, fingers, etc.) in the window.
- Never leave the vehicle without carrying the key.
- Never leave children or unreliable adults unattended inside the vehicle.

5

Main switch

N00548701238

Type 1

The main switch located on the driver's door can be used to operate all the windows.

A window can be opened or closed by operating the corresponding switch.

Press the switch down to open the window, and pull up the switch to close it.

If the driver's door window switch is fully pressed down/pulled up, the driver's door window automatically opens/closes completely.

If you want to stop the window movement, operate the switch lightly in the reverse direction.

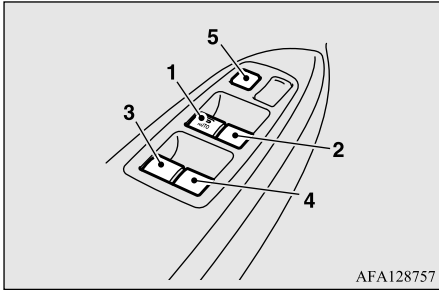

- 1- Driver's door window switch
- 2- Front passenger's door window switch
- 3- Left rear door window switch
- 4- Right rear door window switch
- 5- Lock switch

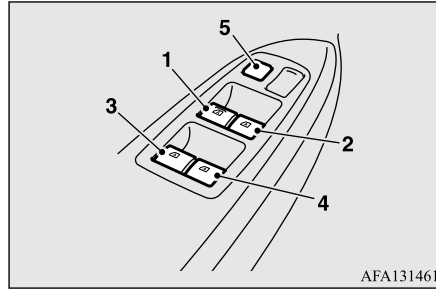

- 1- Driver's door window switch
- 2- Front passenger's door window switch
- 3- Left rear door window switch
- 4- Right rear door window switch
- 5- Lock switch

Type 2

The main switch located on the driver's door can be used to operate all the windows.

A window can be opened or closed by operating the corresponding switch.

Press the switch down to open the window, and pull up the switch to close it.

If the door window switch is fully pressed down/pulled up, the door window automatically opens/closes completely.

If you want to stop the window movement, operate the switch lightly in the reverse direction.

NOTE

- If the switch is operated repeatedly in a short, choppy manner while the door window is open, the safety mechanism may not work properly, which may momentarily make it impossible to automatically open or close the door window. Should this occur, pull the switch upwards until the window is completely closed. The window should now open and close properly.

Sub-switches

N00548801138

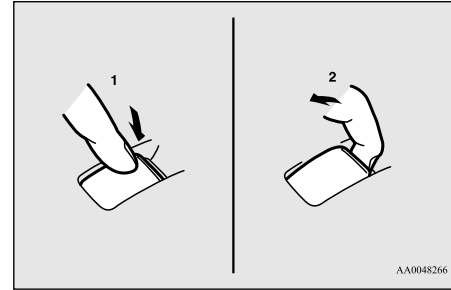

- 1- Open
- 2- Close

Each sub-switch can be used for its own door window, unless the driver's window lock switch is activated.

NOTE

- The rear door windows open only half-way.

Power window timer function

N00548901171

The power windows can be opened or closed when the ignition switch is in the "ON" position or the operation mode is in ON.

The door windows can be opened or closed for a 30-second period after the engine is

stopped. However, once the driver's door or the front passenger's door is opened, the power windows cannot be operated.

Lock switch

N00549001182

When this switch is in the lock mode, the sub-switches cannot be used to open or close the door windows, and the main switch will open or close only the driver's door window. To unlock the switch, press it again.

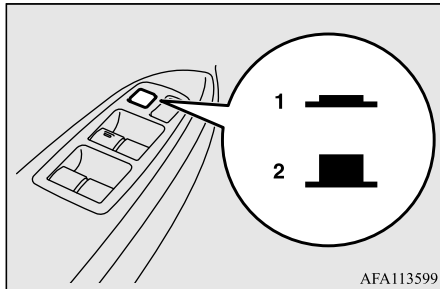

AFA113599

- 1- Lock
- 2- Unlock

⚠ WARNING

- Before driving with a child in the vehicle, be sure to lock the window switch to make it inoperative. Children tampering with the switch could easily trap their hands or heads in the window.

Safety mechanism

N00528801233

Type 1

If a hand or head is trapped, for safety the driver's door window is automatically lowered a little.

After the door window is lowered, clear the obstruction, then pull up the switch again to close the driver's door window.

⚠ WARNING

- If the battery terminals are disconnected or the fuse for power window is replaced, the safety mechanism will be cancelled. If a hand or head got trapped, a serious injury could result.

⚠ CAUTION

- The safety mechanism is deactivated just before the door window closes. This allows the door window to close completely. Therefore be especially careful that fingers are not trapped in the door window opening.
- The safety mechanism is deactivated while the switch is pulled up. Therefore be especially careful that fingers are not trapped in the door window opening.

⚠ CAUTION

- Do not deliberately trap your hands or head in order to activate the safety mechanism. Your hand or head could be trapped and personal injury could result.

📖 NOTE

- The safety mechanism can be activated if the driving conditions or other circumstances cause the driver's door window to be subjected to a physical shock similar to that caused by trapped hand or head.
- If the following operation is performed, the safety mechanism will be cancelled and the driver's door window will not automatically open/close completely.
 - When the battery terminals are disconnected.
 - When the fuse for power window is replaced.
 - When the safety mechanism is activated five or more times consecutively.

In such a case, the following procedure should be implemented to rectify this situation.

If the window is open, repeatedly raise the driver's door window switch until that window has been fully closed. Following this, release the switch, raise the switch once again and hold it in this condition for at least 1 second, then release it. You should now be able to operate the driver's door window in the normal fashion.

Type 2

If a hand or head is trapped, for safety the door window is automatically lowered a little. After the door window is lowered, clear the obstruction, then pull up the switch again to close the door window.

5

WARNING

- If the battery terminals are disconnected or the fuse for power window is replaced, the safety mechanism will be cancelled. If a hand or head got trapped, a serious injury could result.

CAUTION

- The safety mechanism is deactivated just before the door window closes. This allows the door window to close completely. Therefore be especially careful that fingers are not trapped in the door window opening.
- The safety mechanism is deactivated while the switch is pulled up. Therefore be especially careful that fingers are not trapped in the door window opening.
- Do not deliberately trap your hands or head in order to activate the safety mechanism. Your hand or head could be trapped and personal injury could result.

NOTE

- The safety mechanism can be activated if the driving conditions or other circumstances cause the door window to be subjected to a physical shock similar to that caused by trapped hand or head.
- If the following operation is performed, the safety mechanism will be cancelled and the door window will not automatically open/close completely.
 - When the battery terminals are disconnected.
 - When the fuse for power window is replaced.
 - When the safety mechanism is activated five or more times consecutively.

In such a case, the following procedure should be implemented to rectify this situation.

If the window is open, repeatedly raise the appropriate window switch until that window has been fully closed. Following this, release the switch, raise the switch once again and hold it in this condition for at least 1 second, then release it. You should now be able to operate the door window in the normal fashion.

What to do if you hear wind buffeting when driving

N00551400043

Wind buffeting can be described as the perception of pressure on the ears or a booming or rumbling sound. Your vehicle may exhibit wind buffeting when driving with one or both rear door windows down or partially opened. This is a normal occurrence that can be minimized. If the buffeting occurs with the rear door windows open, open the front door windows as well as the rear door windows to minimize the condition.

Power panoramic sunroof (if so equipped)

N00594700036

WARNING

- Do not put head, hands or anything else out of the front sunroof opening while driving the vehicle.
- Never leave children or unreliable adults unattended inside the vehicle.
- Never leave the vehicle without carrying the key.
- Before operating the front sunroof, front shade, or rear shade, make sure that nothing is capable of being trapped (head, hands, fingers, etc.) in the front sunroof, front shade, or rear shade.

⚠ WARNING

- Because the front sunroof opens to the outside of the vehicle, do not open the sunroof when cleaning the top of the roof, etc. Your hands or arms could be trapped.

📖 NOTE

- When leaving the vehicle unattended, be sure to close the front sunroof and carry the key.
- Do not try to operate the front sunroof if it is frozen closed (after snow fall or during extreme cold).
- Do not sit or place heavy luggage on the front sunroof or roof opening edge.
- Do not apply any force that may cause damage to the sunroof.
- Release the switch when the front sunroof, front shade, or rear shade starts to move.
- If the front sunroof, front shade, or rear shade does not operate when the switch is operated, release the switch and check whether something is trapped by the sunroof or shade. If nothing is trapped, we recommend you to have the sunroof or shade checked at an authorized Mitsubishi Motors dealer.
- Be careful when tilting up the front sunroof if a ski carrier or a roof carrier is installed. Depending on the model of ski carrier or roof carrier, the front sunroof may contact the carrier when the front sunroof is tilted up.

📖 NOTE

- Be sure to close the front sunroof completely when washing the vehicle or when leaving the vehicle.
- After washing the vehicle or after rain be sure to wipe off any water that is on the front sunroof before operating it.
- Operating the front sunroof, front shade, or rear shade repeatedly with the engine turned off will run down the battery. Operate the front sunroof, front shade, and rear shade only while the engine is running.

Front sunroof & front shade

The front sunroof & front shade can be opened or closed with the ignition switch in the “ON” position or the operation mode in ON.

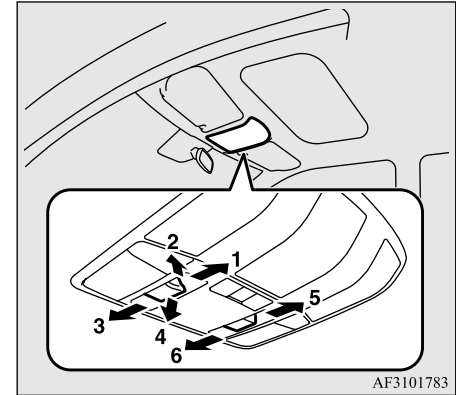

- 1- Open (front sunroof)
- 2- Tilt up (front sunroof)
- 3- Close (front sunroof)
- 4- Tilt down (front sunroof)
- 5- Open (front shade)
- 6- Close (front shade)

Opening the front sunroof

Press the switch in direction (1) to open the front sunroof automatically.

To stop the sunroof before it is fully open, operate the switches in any of the directions (1) to (6).

 **NOTE**

- The front sunroof automatically stops just before reaching the fully open position to reduce wind noise.
Press the switch again to fully open it.
- Depending on the position of the front shade, the front shade will open together with the front sunroof.

5

Closing the front sunroof

Press the switch in direction (3) to fully close the front sunroof automatically.

To stop the sunroof before it is fully closed, operate the switches in any of the directions (1) to (6).

 **NOTE**

- When you press the switch in direction (6), the front sunroof will close slightly, and then the sunroof and front shade will fully close automatically.

Tilting up the front sunroof

Press the switch in direction (2) to raise the rear edge of the front sunroof as it opens.

 **NOTE**

- Depending on the position of the front shade, the front shade will open together with the front sunroof.

Tilting down the front sunroof

Press the switch in direction (3) or pull the switch in direction (4) to fully close the front sunroof automatically.

 **NOTE**

- When you press the switch in direction (6), the front sunroof will close slightly, and then the sunroof and front shade will fully close automatically.

Opening the front shade

Press the switch in direction (5) to fully open the front shade automatically.

To stop the shade before it is fully open, operate the switches in any of the directions (1) to (6).

Closing the front shade

Press the switch in direction (6) to fully close the front shade automatically.

To stop the shade before it is fully closed, operate the switches in any of the directions (1) to (6).

 **NOTE**

- If the front sunroof is open, it will close together with the front shade.

Timer function

Within approximately 30 seconds after the ignition switch is changed to “ACC” or “OFF” or the operation mode is changed to ACC or OFF, the front sunroof and front shade can be opened and closed.

However, if the driver’s or front passenger’s door is opened within 30 seconds after the ignition switch is changed to “ACC” or “OFF” or the operation mode is changed to ACC or OFF, the front sunroof and front shade cannot be opened or closed.

Safety mechanism

If a person’s hand, neck, etc., is trapped in the front sunroof or front shade, the front sunroof or front shade will automatically open a maximum of 8 inches (20 cm) as a safety function. After the front sunroof and front shade open, you can use the switch to close them.

If the safety mechanism operates five times or more consecutively, you will not be able to close the front sunroof and front shade normally.

If this occurs, perform the following procedure to reset the safety mechanism.

1. Press and hold the switch in direction (3) or pull and hold the switch in direction (4).
2. The front sunroof (if open) and front shade will move to the fully closed positions in small increments.

NOTE

- If the front sunroof and front shade are both open, the front sunroof will move to the fully closed position, and then the front shade will move to the fully closed position.

3. When the front sunroof and front shade have both stopped in the fully closed positions, release the switch. (The resetting procedure is finished.)

If the front sunroof and front shade do not move correctly to the fully closed positions after you perform the resetting procedure, contact an authorized Mitsubishi Motors dealer.

CAUTION

- The safety mechanism is cancelled just before the front sunroof and front shade are fully closed. This allows the front sunroof and front shade to close completely. Therefore be especially careful that no fingers are trapped in the front sunroof and front shade.

NOTE

- The safety mechanism can be activated if the driving conditions or other circumstances cause the front sunroof or the front shade to be subjected to a physical shock similar to that caused by a trapped hand or head.
- Do not release the switch until the resetting procedure is finished. If you release the switch, the resetting mode will be cancelled. To perform the resetting procedure again, repeat the procedure from step 1.

Rear shade

The rear shade can be opened or closed with the ignition switch in the “ON” position or the operation mode in ON.

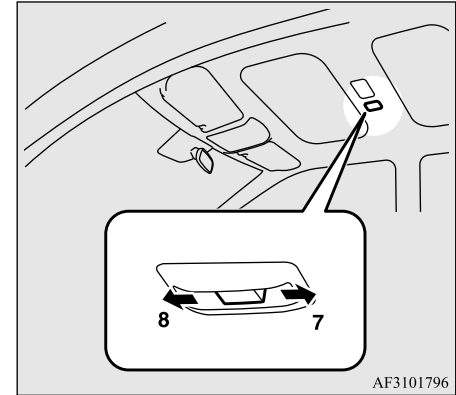

7- Open (rear shade)

8- Close (rear shade)

Opening the rear shade

Press the switch in direction (7) to fully open the rear shade automatically.

To stop the shade before it is fully open, press the switch in direction (7) or (8).

Closing the rear shade

Press the switch in direction (8) to fully close the rear shade automatically.

To stop the shade before it is fully closed, press the switch in direction (7) or (8).

Safety mechanism

If a person's hand, neck, etc., is trapped in the rear shade, the shade will automatically open a maximum of 8 inches (20 cm) as a safety function. After the rear shade opens, you can use the switch to close it.

5 If the safety mechanism operates five times or more consecutively, you will not be able to close the rear shade normally.

If this occurs, perform the following procedure to reset the safety mechanism.

1. Press and hold the switch in direction (8).
2. The rear shade will move to the fully closed position in small increments.
3. When the rear shade has stopped in the fully closed position, release the switch. (The resetting procedure is finished.)

If the rear shade does not move correctly to the fully closed positions after you perform the resetting procedure, contact an authorized Mitsubishi Motors dealer.

CAUTION

- The safety mechanism is cancelled just before the rear shade is fully closed. This allows the rear shade to close completely. Therefore be especially careful that no fingers are trapped in the rear shade.

NOTE

- The safety mechanism can be activated if the driving conditions or other circumstances cause the rear shade to be subjected to a physical shock similar to that caused by a trapped hand or head.
- Do not release the switch until the resetting procedure is finished. If you release the switch, the resetting mode will be cancelled. To perform the resetting procedure again, repeat the procedure from step 1.

Parking brake

N00511401527

To park the vehicle, first bring it to a complete stop, firmly apply the parking brake, and then move the selector lever to the "P" (PARK) position.

Make sure the brake warning light is illuminated.

Lever type parking brake (if so equipped)

N00593100059

To apply

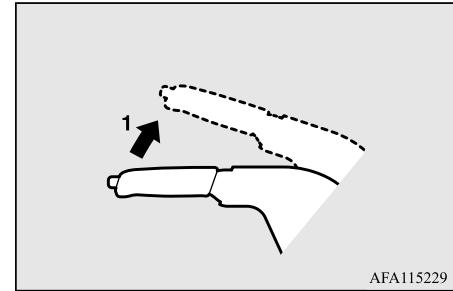

AFA115229

- 1- Pull the lever up without pressing the button at the end of hand grip.

When the parking brake is set and the ignition switch is in the "ON" position, or the operation mode is in ON the brake warning light in the instrument cluster will come on.

When parking on a hill, set the parking brake, and turn the front wheels toward the curb on a downhill, or away from the curb on an uphill.

To release

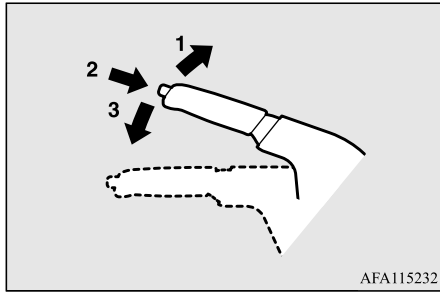

- 1- Pull the lever up slightly.
- 2- Press and hold the button at the end of the hand grip.
- 3- Pressing the lever downward.

Before driving, be sure to release the parking brake.

CAUTION

- Before driving, be sure that the parking brake is fully released and brake warning light is off.
- If you drive without the parking brake fully released, the warning display will appear on the information screen in the multi-information display.
- If a vehicle is driven without releasing the parking brake, the brakes will be overheated, resulting in ineffective braking and possible brake failure.

Warning light



Warning display



Electric parking brake (if so equipped)

N00593200119

The Electric parking brake is the system that applies the parking brake by the electric motor.

NOTE

- You may hear an operation noise from the vehicle body when operating the Electric parking brake. This does not indicate a malfunction and the Electric parking brake is operating normally.
- When the battery is weak or dead, the Electric parking brake cannot be applied or released. Refer to “Jump-starting the engine” on page 8-2.
- You may feel the brake pedal moving when operating the Electric parking brake. This does not indicate a malfunction.

5

To apply

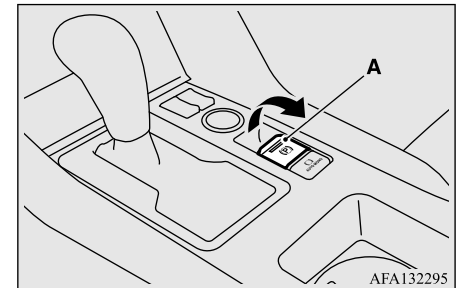

1. Stop the vehicle completely.
2. Pull up the Electric parking brake switch while depressing the brake pedal.

Parking brake

When the Electric parking brake is applied, the brake warning light in the instrument cluster and the indicator light (A) on the Electric parking brake switch will come on.

When parking on a hill, set the parking brake, and turn the front wheels toward the curb on a downhill, or away from the curb on an uphill.

5

CAUTION

- Do not place any items near the Electric parking brake switch. Items may come into contact with the switch, which may unexpectedly trigger operation of the Electric parking brake.
- While the vehicle is in motion, do not apply the Electric parking brake. Doing so may cause overheating and/or premature wear of brake parts, reducing brake performance.

NOTE

- In the following conditions, the brake warning light will illuminate for approximately 15 seconds and then go off.
 - While the Electric parking brake is applied, the operation mode is put in OFF.
 - While the operation mode is in OFF, the Electric parking brake switch is pulled up.

NOTE

- If the Electric parking brake must be applied in an emergency situation, pull and hold the Electric parking brake switch to apply the Electric parking brake. At that time, the following warning display will appear in the multi-information display and a buzzer will sound, however you should continue to pull and hold the Electric parking brake switch.



- When parking on steep grades, pull up the Electric parking brake switch twice (once more after the operation is completed once). The maximum effect of the parking brake will be obtained.
- If the parking brake does not hold the vehicle stationary after the foot brake is released, contact an authorized Mitsubishi Motors dealer or a repair facility of your choice.
- When the operation mode is other than ON, if the parking brake is applied, the Electric parking brake indicator light comes on for a while.

NOTE

- If the Electric parking brake switch is repeatedly operated in a short time, the following warning display will appear in the multi-information display and the Electric parking brake will temporarily stop working. In such case, wait for approximately 1 minute until the warning display disappears, and operate the Electric parking brake switch again.



- The brake warning light and the indicator light on the Electric parking brake switch may blink. This does not indicate a malfunction, the lights go off when/if the Electric parking brake is released.
- Depending on the situation, the Electric parking brake may be applied automatically. Refer to “Brake auto hold” on page 5-77.

To release

Manual operation

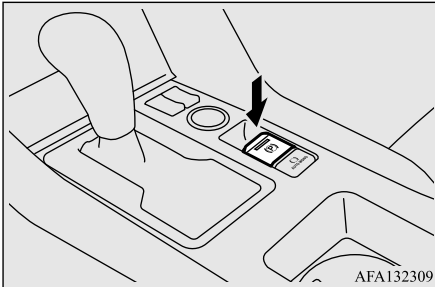

1. Make sure that the operation mode is in ON.
2. Press down the Electric parking brake switch while depressing the brake pedal.

Automatic operation

When the accelerator pedal is depressed slowly while all of the following conditions are met, the Electric parking brake is automatically released.

- The engine is running.
- The selector lever is in the “D” (DRIVE) or the “R” (REVERSE) position.
- The driver’s seat belt is fastened.

When the Electric parking brake is released, the brake warning light and the indicator light on the Electric parking brake switch light turns off and no longer illuminates.

Before driving, be sure that the parking brake is released and that no warning lights are illuminated.

CAUTION

- After the Electric parking brake switch has been operated to apply or release the Electric parking brake, if the brake warning light and the indicator light on the Electric parking brake switch remain blinking or the Electric parking brake warning light remain illuminated, the Electric parking brake system may be malfunctioning and the parking brake may not be applied or released. Immediately park your vehicle in a safe place and contact the nearest authorized Mitsubishi Motors dealer or a repair facility of your choice.
- If a vehicle is driven without releasing the parking brake, the brake will overheat, resulting in ineffective braking and possible brake failure.
- If the brake warning light does not go off after the parking brake has been released, the brake system may be malfunctioning. Contact the nearest authorized Mitsubishi Motors dealer or a repair facility of your choice.

CAUTION

- If the acceleration of the vehicle seems abnormally slow after the vehicle has been parked with the Electric parking brake applied in cold weather, stop the vehicle in a safe place, then apply and release the Electric parking brake. If the vehicle acceleration is still slow, contact the nearest authorized Mitsubishi Motors dealer or a repair facility of your choice.

NOTE

- When the operation mode is other than ON, the parking brake cannot be released.
- If the Electric parking brake does not automatically release, it may be released by manual operation.
- When the selector lever is other than “P” (PARK) position, if you try to release the Electric parking brake without depressing the brake pedal, the warning display will appear.



NOTE

- If you start driving without releasing the Electric parking brake, the warning display will appear.



- If the driver's foot contacts the accelerator pedal in the condition that the Electric parking brake can release by an automatic operation, the Electric parking brake may be released automatically.

Warning light/display

Warning light



Warning display



If there is a malfunction in the system, the warning light will come on. In addition, the warning display appears on the information screen in the multi-information display.

Under normal conditions, the warning light only comes on when the operation mode is put in ON and goes off a few seconds later.

CAUTION

- When the Electric parking brake warning light does not illuminate or remains illuminated when the operation mode is put in ON, or comes on while driving, the Electric parking brake may not be applied or released. Immediately contact the nearest authorized Mitsubishi Motors dealer or a repair facility of your choice. For details, refer to "Electric parking brake warning light" on page 5-186. When parking your vehicle while the Electric parking brake warning light is illuminated, park the vehicle on level and stable ground, move the selector lever to the "P" (PARK) position and place chocks, blocks, stones behind and in front of the tires to prevent the vehicle from moving.

NOTE

- If the following warning is displayed in the information screen in the multi-information display, operate the Electric parking brake switch several times. After operating the switch, if the display disappears, there is no abnormality.



Steering wheel height and reach adjustment

N00511501241

To adjust the steering wheel to the desired position, move the lever upward or downward while moving the steering wheel to the desired position.

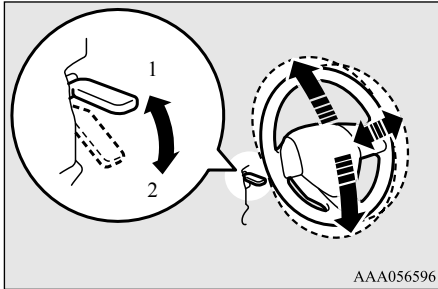

- 1- Wheel lock
- 2- Release

AAA056596

⚠ WARNING

- After adjusting, make sure the lock lever is secured in the locked (1) position.
- Do not attempt to adjust the steering wheel while driving. This can be dangerous.

Inside rearview mirror

N00511601503

Adjust the inside rearview mirror only after making any seat adjustments so as to have a clear view to the rear of the vehicle.

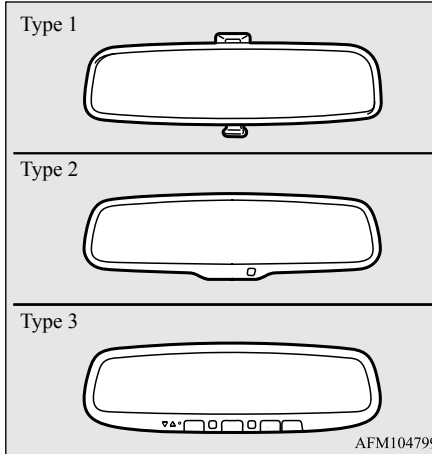

AFM104799

⚠ WARNING

- Do not attempt to adjust the inside rearview mirror while driving. This can be dangerous. Be sure to adjust the mirrors before driving.

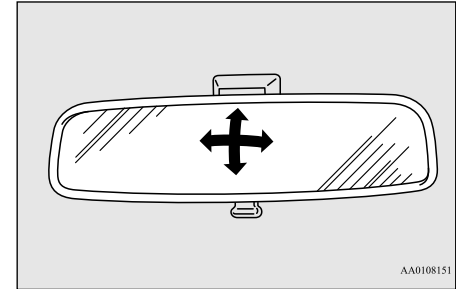

AA0108151

Adjust the inside mirror to maximize the view through the rear window.

To adjust the mirror position

It is possible to move the mirror up/down and left/right to adjust its position.

To reduce the glare

Type 1

The day/night knob (A) at the bottom of the mirror can be used to adjust the mirror to reduce the glare from the headlights of vehicles behind you during night driving.

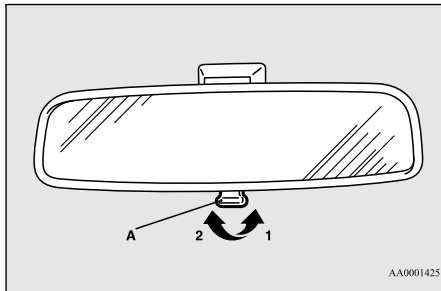

- 1- Daytime position
- 2- Night position

Type 2

When the headlights of the vehicles behind you are very bright, the reflection factor of the rearview mirror is automatically changed to reduce the glare.

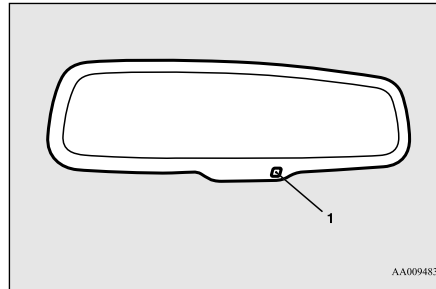

When the operation mode is put in ON, the reflection factor of the mirror is automatically changed.

NOTE

- Do not hang items on, or spray glass cleaner on the sensor (1), as reduced sensitivity could result.

Type 3

When the headlights of the vehicles behind you are very bright, the reflection factor of the rearview mirror is automatically changed to reduce the glare.

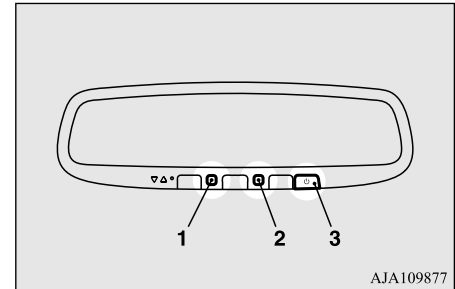

Normally, use the automatic mode. When the operation mode is put in ON, the green indicator (1) illuminates and the reflection factor of the mirror is automatically changed.

NOTE

- Do not hang items on, or spray glass cleaner on the sensors (2), as reduced sensitivity could result.
- If you want to stop automatic mode, press the switch (3) and the indicator will go off. To return to automatic mode, press the switch again or put the operation mode in ON after putting the operation mode in OFF.

Outside rearview mirrors

N00512201232

Adjust the outside rearview mirrors only after making any seat adjustments so as to have a clear view to the rear of the vehicle.

⚠ WARNING

- Do not attempt to adjust the outside rearview mirrors while driving. This can be dangerous. Be sure to adjust the mirrors before driving.
- Your passenger's side mirror is convex. The objects you see in the mirror will look smaller and farther away than they appear in a regular flat mirror. Do not use this mirror to estimate the distance of vehicles following you when changing lanes.

To adjust the mirror position

N00549101196

The outside rearview mirrors can be adjusted when the ignition switch is in the "ON" or "ACC" position or the operation mode is put in ON or ACC.

Push the switch (A) to the same side as the mirror you wish to adjust.

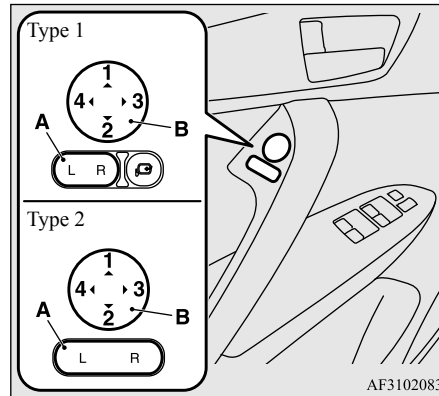

L- Left outside mirror adjustment
R- Right outside mirror adjustment

Press the switch (B) to adjust the mirror position.

- 1- Up
- 2- Down
- 3- Right

4- Left

NOTE

- After completing the adjustment, return the switch (A) to the center position.

To retract the mirror

N00549201298

5

The outside mirror can be retracted towards the side window to prevent damage when parking in tight locations.

Except for vehicles equipped with the mirror retractor switch

Push the mirror towards the back of the vehicle with your hand to retract it in. When extending the mirror, pull it out towards the front of the vehicle until it clicks to lock in place.

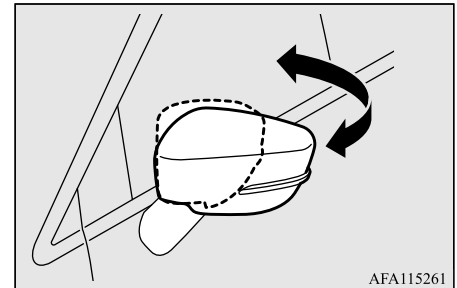

AF115261

For vehicles equipped with the mirror retractor switch

Retracting and extending the mirrors using the mirror retractor switch

5

With the operation mode in ON or ACC, push the mirror retractor switch to retract the mirrors. Push it again to extend the mirrors to their original positions.

After putting the operation mode in OFF, it is possible to retract and extend the mirrors using the mirror retractor switch for approximately 30 seconds.

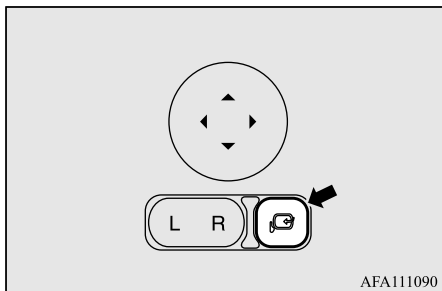

CAUTION

- It is possible to retract and extend the mirrors by hand. After retracting a mirror using the mirror retractor switch, however, you should extend it by using the switch again, not by hand. If you extended the mirror by hand after retracting it using the switch, it would not properly lock in position. As a result, the mirror could move because of the wind or vibration while you are driving, and this may impair the driver's rearward visibility.

NOTE

- Be careful not to get your hands trapped while a mirror is moving.
- If you move a mirror by hand or it moves after hitting a person or object, you may not be able to return it to its original position using the mirror retractor switch. If this happens, push the mirror retractor switch to place the mirror in its retracted position and then push the switch again to return the mirror to its original position.
- When freezing has occurred and mirrors fail to operate as intended, please refrain from repeated pushing of the retractor switch as this action can result in burn-out of the mirror motor circuits.

Retracting and extending the mirrors without using the mirror retractor switch (automatic extension function)

The mirrors automatically retract or extend when the doors are locked or unlocked using the key buttons or the F.A.S.T.-key operation. Refer to "To operate using the F.A.S.T.-key" on page 5-16.

NOTE

- Functions can be modified as stated below. Please consult an authorized Mitsubishi Motors dealer.
On vehicles equipped with the Smartphone-link Display Audio (SDA) or the Smartphone-link Display Audio (SDA) navigation system, screen operations can be used to make the adjustment. Refer to the separate owner's manual for details.
- Automatically extend when the operation mode is put in ON with the driver's door closed, and automatically retract when the operation mode is put in OFF or ACC with the driver's door opened.
- Automatically extend when the vehicle speed reaches approximately 19 mph (30 km/h).
- Deactivate the automatic extension function.

Integrated Blind Spot Mirrors

(if so equipped)

N00595900022

⚠ WARNING

- Even if no vehicles are shown to the side of your vehicle in the Integrated Blind Spot Mirrors (A), be sure to confirm that traffic is clear before changing lanes.
- Because the Integrated Blind Spot Mirrors (A) are wide-angle mirrors, objects appear smaller than their actual size. Also, be careful because vehicles and other objects shown in the mirrors are closer to your vehicle than they appear.

The Integrated Blind Spot Mirror (A) is a mirror for showing vehicles and other objects in the driver's blind spot (C) that are not shown in the main mirror (B).

When checking the area to the rear of your vehicle, check the main mirror (B), and then check the Integrated Blind Spot Mirror (A).

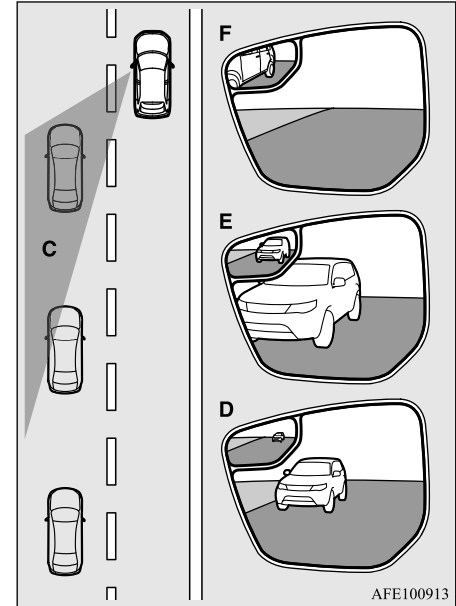
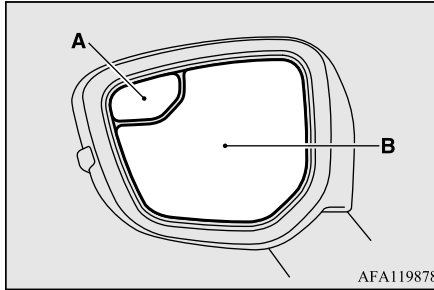

- D- When a vehicle is traveling far behind your vehicle, the main mirror (B) shows an image of the vehicle and the Integrated Blind Spot Mirror (A) shows a small image of the vehicle.
- E- When the vehicle moves closer to your vehicle, the main mirror (B) shows a larger image of the vehicle and the Integrated Blind Spot Mirror (A) also shows a larger image of the vehicle.

Ignition switch

F- When the vehicle moves even closer to your vehicle and is located in the driver's blind spot (C), the main mirror (B) does not show an image of the vehicle and only the Integrated Blind Spot Mirror (A) shows an image of the vehicle.

5 Heated outside rearview mirror (if so equipped)

N00549301361

When the rear window defogger switch is pressed with the engine running, the outside rearview mirrors are defogged or defrosted. Current will flow through the heater element inside the mirrors, thus clearing away frost or condensation.

The indicator light (A) will illuminate while the defogger is on.

The heater will be turned off automatically in approximately 15 to 20 minutes depending on the outside temperature.

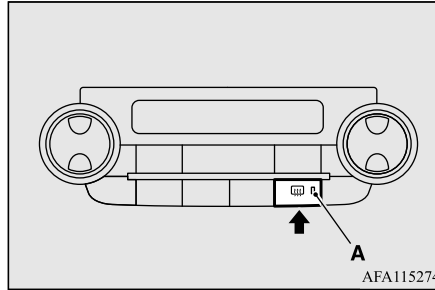

NOTE

- The heated outside rearview mirror can be turned on automatically.
For further information, please contact your authorized Mitsubishi Motors dealer.
On vehicles equipped with the SDA or the SDA navigation system, screen operations can be used to make the adjustment.
Refer to the separate owner's manual for details.

Ignition switch

N00512401755

[For vehicles equipped with the F.A.S.T.-key]

For information on operations for vehicles equipped with the F.A.S.T.-key, refer to "Free-hand Advanced Security Transmitter (F.A.S.T.-key): Engine switch" on page 5-18.

[Except for vehicles equipped with the F.A.S.T.-key]

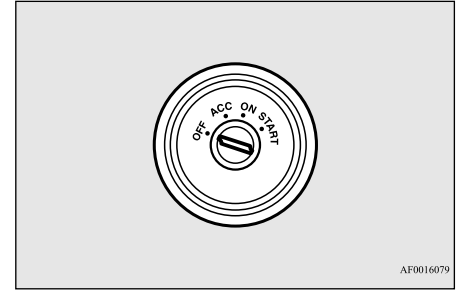

OFF

The engine is off. The key can be inserted and removed only when the switch is in this position.

ACC

Allows operation of electrical accessories with the engine off.

ON

All accessories can be used.

START

Engages the starter. Release the key when the engine starts. It will automatically return to the “ON” position.

NOTE

- Your vehicle is equipped with an electronic immobilizer. To start the engine, the ID code which the transponder inside the key sends must match the one registered to the immobilizer computer. (Refer to “Electronic immobilizer” on page 5-4.)

ACC power auto-cutout function

N00539601156

After approximately 30 minutes has elapsed with the ignition switch in the “ACC” position, the function automatically cuts out the power for the audio system and other electric devices that can be operated with that position.

When the ignition switch is turned from the “ACC” position, the power is supplied again to those devices.

NOTE

- It is possible to modify functions as follows:

NOTE

- The time until the power cuts out can be changed to approximately 60 minutes.
- The ACC power auto-cutout function can be deactivated.

For details, we recommend you to consult an authorized Mitsubishi Motors dealer. On vehicles equipped with the Smartphone-link Display Audio (SDA), screen operations can be used to make the adjustment. Refer to the separate owner’s manual for details.

To remove the key

N00550901253

When removing the key, first set the selector lever to the “P” (PARK) position, and then turn the key to the “OFF” position and remove it.

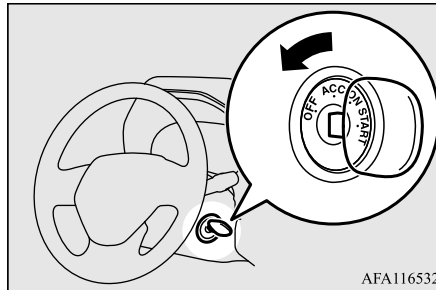

AFA116532

NOTE

- The key cannot be removed unless the selector lever is set to the “P” (PARK) position, which allows the ignition switch to turn to the “OFF” position.

CAUTION

- If the engine is stopped while driving, the power brake booster will stop functioning and greater effort for braking will be required. Also, the power steering system will not function and it will require greater effort to manually steer the vehicle.
- Do not leave the key in the “ON” position for a long time when the engine is not running. This will cause the battery to run down.
- Do not turn the key to the “START” position when the engine is running. It will damage the starter motor.

5

Starting the engine

N00512601874

[For vehicles equipped with the F.A.S.T.-key]

For information on operation for vehicles equipped with the F.A.S.T.-key, refer to “Free-hand Advanced Security Transmitter (F.A.S.T.-key): Starting” on page 5-13.

[Except for vehicles equipped with the F.A.S.T.-key]

Tips for starting

5

- Do not operate the starter motor continuously for longer than 15 seconds as this could run the battery down or damage the starter motor. If the engine does not start, turn the ignition switch back to the “OFF”, wait a few seconds, and then try again. Trying repeatedly with the engine or starter motor still turning will damage the starter mechanism.
- If the engine will not start because the battery is weak or discharged, refer to “Jump-starting the engine” (on page 8-2) for instructions.
- A longer warm up period will only consume extra fuel. The engine is warmed up enough for driving when the bar graph of engine coolant temperature display starts to move or the low coolant temperature indicator goes out. Refer to “Engine coolant temperature display” on page 5-150.

WARNING

- **Never run the engine in a closed or poorly ventilated area any longer than is needed to move your vehicle out of the area. Carbon monoxide gas, which is odorless and extremely poisonous, could build up and cause serious injury or death.**

CAUTION

- Do not push-start the vehicle.
- Do not run the engine at high revolutions or drive at high speeds until the engine has had a chance to warm up.
- Release the ignition switch as soon as the engine starts. Otherwise, the starter motor will be damaged

Starting the engine

This model is equipped with an electronically controlled fuel injection system. This is a system that automatically controls fuel injection. There is usually no need to depress the accelerator pedal when starting the engine. The starter should not be run for more than 15 seconds at a time. To prevent battery drain, wait a few seconds between attempts to restart the engine.

1. Make sure all occupants are properly seated with seat belts fastened.

2. Insert the ignition key.
3. Press and hold the brake pedal down firmly with your right foot.
4. Make sure the selector lever is in the “P” (PARK) position.
5. Turn the ignition switch to the “ON” position and make certain that all warning lights are functioning properly before starting the engine.
6. Turn the ignition switch to the “START” position without pressing the accelerator pedal. Release the ignition switch when the engine starts.

NOTE

- Minor noises may be heard on engine start-up. These will disappear as the engine warms up.

When the engine is hard to start

After several attempts, you may experience that the engine still does not start.

1. Make sure that all electric devices, such as lights, air conditioning blower and rear window defogger, are turned off.

2. While depressing the brake pedal, press the accelerator pedal halfway and hold it there, then crank the engine. Release the accelerator pedal, immediately after the engine starts.
3. If the engine still will not start, the engine could be flooded with too much gasoline. While depressing the brake pedal, push the accelerator pedal all the way down and hold it there, then crank the engine for 5 to 6 seconds. Return the ignition switch to the "OFF" and release the accelerator pedal. Wait a few seconds, and then crank the engine again for 5 to 6 seconds while depressing the brake pedal, but do not push the accelerator pedal. Release the ignition switch if the engine starts. If the engine fails to start, repeat these procedures. If the engine still will not start, contact your local Mitsubishi Motors dealer or a repair facility of your choice for assistance.

Startability of CVT vehicle with ambient temperature of -22 °F (-30 °C) or lower

When the ambient temperature is -22 °F (-30 °C) or lower, it may not be possible to start from a standstill even with the selector

lever in the "D" (DRIVE) or "R" (REVERSE) position.

This occurs because the transaxle has not warmed up sufficiently; it does not indicate a problem. If this occurs, place the selector lever in the "P" (PARK) position and let the engine idle for at least 10 minutes.

The transaxle will warm up, and you will be able to start normally.

Do not leave the vehicle during warm-up operation.

Turbocharger operation

N00537301090

CAUTION

- Do not run the engine at high speeds (for example, by revving it or by accelerating rapidly) immediately after starting it.
- Do not stop the engine immediately after high-speed or uphill driving. First allow the engine to idle to give the turbocharger a chance to cool down.
- Replace the engine oil at the specified intervals. If the engine oil is not replaced, the turbocharger could malfunction.

Continuously variable transmission (CVT)

N00560201103

The CVT will automatically and continuously change its gear ratio depending on road and driving conditions. This helps achieve smooth driving and excellent fuel efficiency. Also you can manually shift the transmission up and down. Refer to "Sports mode" on page 5-67.

5

DRIVING UPHILL

The transmission prevents unnecessary upshifts even when the accelerator pedal is released and ensures smooth driving.

DRIVING DOWNHILL

According to the conditions, the transmission will automatically shift to a lower gear ratio to achieve stronger engine braking. This may help reduce your need to use the service brake.

Selector lever operation

N00560301120

As an additional safety precaution, models equipped with a CVT have a shift-lock device

Continuously variable transmission (CVT)

that holds the selector lever in the “P” (PARK) position. To move the selector lever from the “P” (PARK) position to another position, follow the steps below.

1. Press and hold the brake pedal down.
2. Press and hold the lock button.
3. Move the selector lever to the desired position.

NOTE

- The selector lever cannot be moved from “P” (PARK) to other position if the ignition switch is set to the “OFF” or “ACC” position, or if the key has been removed, or the operation mode is put in OFF or ACC, or if the brake pedal is not pressed and held down.

The CVT selects an optimum ratio automatically when the selector lever is in the “D” (DRIVE) position, depending on the speed of the vehicle and the position of the accelerator pedal.

The selector lever (A) has two gates; the main gate (B) and sports mode gate (C).

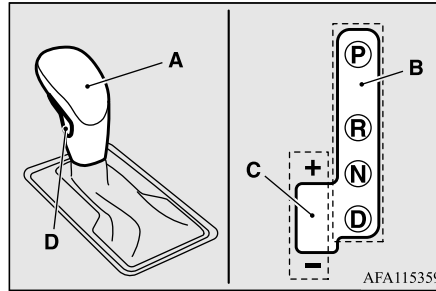

In the main gate, selector lever has four positions, and is equipped with a lock button (D) to avoid inadvertent selection of the wrong gear.

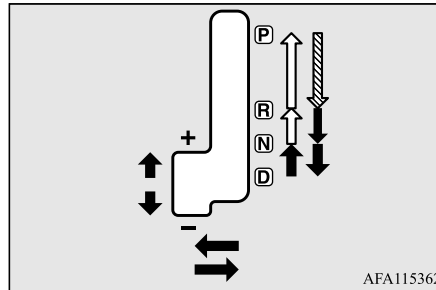

The lock button must be pushed while the brake pedal is depressed to move the selector lever.



The lock button must be pushed to move the selector lever.



The lock button need not be pushed to move the selector lever.

WARNING

- If the lock button is always pushed to operate the selector lever, the lever may be accidentally shifted into the “P” (PARK) or “R” (REVERSE) position. Be sure not to push the lock button when performing the operations indicated by ↓ in the illustration.
- Always press the brake pedal when shifting the selector lever into a selector position from the “N” (NEUTRAL) position. When beginning to drive, do not shift the selector lever from the “N” (NEUTRAL) position while pressing the accelerator pedal. This will cause the vehicle to “jump” forward or backward.

NOTE

- To prevent mistakes in operating the lever, make sure you stop briefly at each position. After operating, check the position in the multi-information display.
- If the brake pedal is not depressed and held, the shift-lock device activates to prevent the selector lever from being moved from the “P” (PARK) position.

NOTE

- For a shift indicated by  in the illustration, depress the brake pedal before moving the selector lever. If you attempt to move the selector lever before depressing the brake pedal, the selector lever may be immovable.

When the selector lever cannot be shifted from the “P” (PARK) position

N00547501024

When the selector lever cannot be shifted from the “P” (PARK) position to another position while the brake pedal is pressed and held down with the ignition switch at the “ON” position or the operation mode in ON, the battery may be flat or the shift-lock mechanism may be malfunctioning.

Immediately have your vehicle checked by an authorized Mitsubishi Motors dealer or a repair facility of your choice.

If you need to move the vehicle, shift the selector lever as follows.

1. Make sure the parking brake is firmly applied.
2. Stop the engine if it is running.

3. Insert a screwdriver with a cloth over its tip into the notch (A) of the cover. Pry gently as shown to remove the cover.

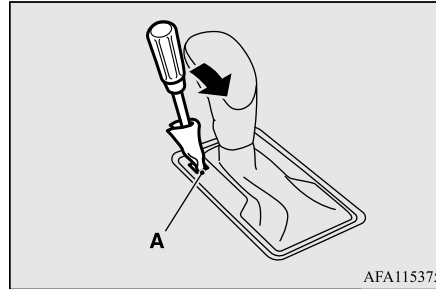

AFA115375

4. Depress the brake pedal with the right foot.
5. Insert a screwdriver in the shift-lock release hole (B). Shift the selector lever to the “N” (NEUTRAL) position while pressing the screwdriver down.

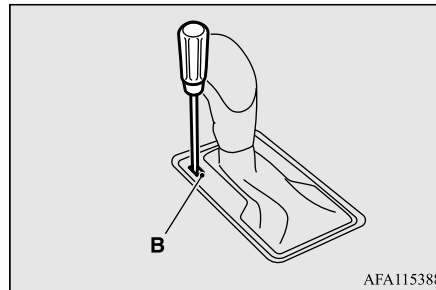

AFA115388

Selector lever position display

N00560401105

When the ignition switch is turned to the “ON” position or the operation mode is put in ON, the selector lever position is shown on the multi-information display.

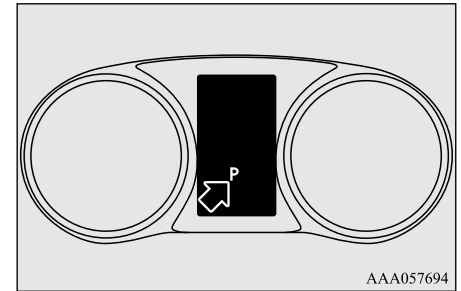

AAA057694

When the selector lever position display blinks (if the ambient temperature is low)

N00582900060

WARNING

- To avoid unintended vehicle movement, keep brake pedal applied with your right foot and do not depress the accelerator pedal, while the selector lever position display is blinking.

Continuously variable transmission (CVT)

If the ambient temperature is low, the selector lever position display on the multi-information display may blink when the selector lever is placed in the “D” (DRIVE), or “R” (REVERSE) position immediately after the engine has been started. This indicates that the transmission requires warming up. While the display is blinking, the vehicle will not move, because the transmission keeps disengaging until the warm up is completed even if the selector lever is placed in the “D” or “R” position.

When the selector lever position display is blinking, perform the following procedure:

1. Depress the brake pedal with your right foot and place the selector lever in the “N” (NEUTRAL) position for several seconds.
2. Keep depressing the brake pedal and then place the selector lever in the “D” (DRIVE), or “R” (REVERSE) position. If the selector lever position display stops blinking, the warm up is completed and the transmission will function normally.
3. If the display is still blinking, repeat steps 1 and 2 above.

NOTE

- While the selector lever position display is blinking, a buzzer will sound intermittently.



Warning display

N00560501148





or



When the  warning display or the  warning display appears on the information screen in the multi-information display while you are driving, there could be a malfunction in the CVT.

NOTE



- The selector lever position display blinks at the time of  or  warning display appears.

NOTE

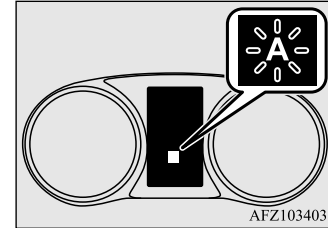
- The “A” indicator on the selector lever position display will blink only when there is a problem with the CVT position switch. It is not seen during normal driving.



CAUTION

- If a malfunction occurs in the CVT while driving, the  warning display or the  warning display will appear on the information screen in the multi-information display. In this case, follow these procedures:

[When  warning display is showing]

The CVT fluid is overheating. The engine control may activate to lower the CVT fluid temperature, causing the engine revolutions and vehicle speed to decrease. In this case, take one of the following procedures.

- Slow down your vehicle.
- Stop your vehicle in a safe place, put the selector lever in the “P” (PARK) position, and open the engine hood with the engine running to allow the engine to cool down.

⚠ CAUTION

After a while, confirm that the  warning display is no longer showing. It is safe to continue driving if the display is no longer showing. If the warning display remains or flashes frequently, have your vehicle inspected by an authorized Mitsubishi Motors dealer or a repair facility of your choice immediately.

[When  warning display is showing]

It may be that there is something unusual happening in the CVT, causing a safety device to activate. Have your vehicle inspected by an authorized Mitsubishi Motors dealer or a repair facility of your choice immediately.

Selector lever positions

N00560601110

“P” PARK

This position locks the transmission to prevent the vehicle from moving. The engine can be started in the “P” (PARK) position.

“R” REVERSE

Move the lever to this position only after the vehicle has come to a complete stop.

⚠ CAUTION

- Never shift into the “P” (PARK) or “R” (REVERSE) position while the vehicle is in motion. If the lever is shifted into the “P” (PARK) or “R” (REVERSE) position while the vehicle is in motion, the transmission may be damaged.

“N” NEUTRAL

At this position, the transmission is disengaged. It is the same as the neutral position on a manual transaxle and should be used when the vehicle is not moving for an extended length of time during driving, such as in a traffic jam.

⚠ WARNING

- Never move the selector lever to the “N” (NEUTRAL) position while driving since you could accidentally slip it into the “P” (PARK) or “R” (REVERSE) position, damaging the transmission.
- To prevent the vehicle from rolling when stopped on a slope, the engine should be started in the “P” (PARK) position, not in “N” (NEUTRAL) position.

⚠ WARNING

- To prevent rolling, always keep your foot on the brake pedal when the vehicle is in “N” (NEUTRAL) position, or when shifting into or out of “N” (NEUTRAL) position.

“D” DRIVE

This position is used for most city and highway driving. The transmission will automatically and continuously change its gear ratio depending on road and driving conditions.

⚠ CAUTION

- To prevent transmission damage, never shift into the “D” (DRIVE) position from the “R” (REVERSE) position while the vehicle is in motion.

Sports mode

N00560701137

Whether the vehicle is stationary or in motion, sports mode is selected by gently pushing the selector lever from the “D” (DRIVE) position into sports mode gate (A). To return to “D” (DRIVE) operation, gently push the selector lever back into the main gate (B).

Continuously variable transmission (CVT)

In sports mode, gear shifts can be made rapidly simply by moving the selector lever backward and forward or using the sportronic steering wheel paddle shifter at the steering wheel (for vehicles equipped with the sportronic steering wheel paddle shifter). In contrast to a M/T, the sports mode allows gear shifts with the accelerator pedal depressed.

5

NOTE

- While the vehicle is stopped, only 1st gear can be selected with the selector lever.
- You can also shift into sports mode by operating the sportronic steering wheel paddle shifter while driving in the “D” (DRIVE) position. Also, you can return to the “D” (DRIVE) operation in any of following ways.
 - When returning to “D” (DRIVE) operation, the selector lever position display will change to “D” (DRIVE) position.
 - Pull the sportronic steering wheel paddle shifter on the **+** (SHIFT UP) side for longer than 2 seconds.
 - Stop the vehicle.
 - Push the selector lever from the “D” (DRIVE) position into the manual gate (A) and push the selector lever back into the main gate (B).

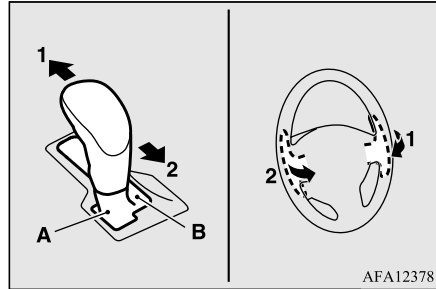

1- **+** (SHIFT UP)

Transmission shifts up once by each operation.

2- **-** (SHIFT DOWN)

Transmission shifts down once by each operation.

CAUTION

- In sports mode, the driver must execute upward shifts in accordance with prevailing road conditions, taking care to keep the engine speed below the tachometer’s red zone.
- Repeated continuous operation of the selector lever or the sportronic steering wheel paddle shifter will continuously switch shift position.
- Shift ranges may not change when the lateral paddle shifters are operated at the same time.

NOTE

- Shift ranges can only be selected in a forward direction from 1st to 8th. To reverse or park the vehicle, move the selector lever to the “R” (REVERSE) or “P” (PARK) position.
- To maintain good running performance, the transmission may refuse to perform an upshift when the selector lever or the sportronic steering wheel paddle shifter on the **+** (SHIFT UP) side is pulled at certain vehicle speeds. Also, to prevent over-revving of the engine, the transmission may refuse to perform a downshift when the selector lever or the sportronic steering wheel paddle shifter on the **-** (SHIFT DOWN) side is pulled at certain vehicle speeds. When this happens, a buzzer sounds to indicate that a downshift is not going to take place.
- Downward shifts are made automatically when the vehicle slows down. Before the vehicle stops, 1st gear is automatically selected.
- The upward shift may be made automatically in sports mode when the engine speed rises and approaches the tachometer’s red zone.

Sports mode display

N00560901083

In sports mode, the currently selected shift range is displayed on the information screen in the multi-information display.

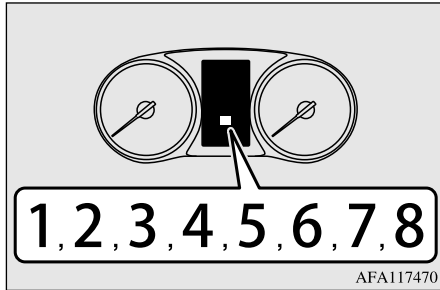

Operation of the CVT

N00560801109

⚠ CAUTION

- Before selecting a position with the engine running and the vehicle stationary, firmly depress the brake pedal to prevent the vehicle from creeping.
The vehicle will begin to move as soon as the CVT is engaged, especially when the engine speed or idle speed is high, or with the air conditioning operating.
Do not release the brake pedal until you are ready to drive away.
- Depress the brake pedal with the right foot at all times.
Using the left foot could cause driver movement delay in case of an emergency.
- To prevent sudden acceleration, never run the engine at high revolutions when shifting from the “P” (PARK) or “N” (NEUTRAL).

⚠ CAUTION

- Operating the accelerator pedal while the other foot is resting on the brake pedal will affect braking efficiency and may cause premature wear of brake pads.
- Use the selector lever in the correct shift position in accordance with driving conditions.
Never coast downhill backward in the driving shift position {“D” (DRIVE) position or sports mode} or coast forward in the “R” (REVERSE) position.
Engine stopping and increased brake pedal and steering effort could lead to an accident.
- Do not rev the engine with the brake pedal pressed when the vehicle is stationary. This can damage the CVT.
Also, when you depress the accelerator pedal while holding down the brake pedal with the selector lever in the “D” (DRIVE) position, the engine revolutions may not rise as high as when performing the same operation with the selector lever in the “N” (NEUTRAL) position.

Passing acceleration

To gain extra acceleration in “D” (DRIVE) position (when passing another vehicle) push the accelerator to the floor. The CVT will automatically downshift.

📖 NOTE

- In sports mode, downshifts do not take place when the accelerator is depressed all the way to the floor.

Waiting

For short waiting periods, such as at traffic lights, the vehicle can be left in selector lever position and held stationary with the service brake.

For longer waiting periods with the engine running, place the selector lever in the “N” (NEUTRAL) position and apply the parking brake, while holding the vehicle stationary with the service brake.

Prior to moving off after having stopped the vehicle, make sure that the selector lever is in “D” (DRIVE) position or Sports mode position.

⚠ CAUTION

- To avoid transmission overheating, never try to keep your vehicle stationary on a hill by using the accelerator pedal. Always apply the parking brake and/or service brake.
- Do not rev the engine unnecessarily while the vehicle is stationary. Unexpected acceleration may occur if the selector lever is in a position other than “P” (PARK) or “N” (NEUTRAL).



Parking

To park the vehicle, first bring it to a complete stop, firmly apply the parking brake, and then move the selector lever to the “P” (PARK) position.

5 When the CVT makes no speed change

If the CVT does not shift while driving, or your vehicle does not pick up enough speed when starting on an uphill slope, it may be that there is something unusual happening in the transmission, causing a safety device to activate. Immediately have your vehicle checked at an authorized Mitsubishi Motors dealer or a repair facility of your choice.

NOTE

- When the  warning display and “SLOW DOWN” or the  warning display and “SERVICE REQUIRED” appear on the information screen in the multi-information display, there could be a malfunction in the CVT. Refer to “Continuously variable transmission (CVT): Warning display” on page 5-66.

S-AWC (Super-All Wheel Control) (if so equipped)

N00541301118

S-AWC is an integrated vehicle dynamics control system that helps enhance driving performance, cornering performance, and vehicle stability over a wide range of driving conditions through integrated management of the electronically controlled 4WD, the AYC, the ABS and the ASC.

CAUTION

- Do not over-rely on the S-AWC. Even the S-AWC cannot prevent the natural laws of physics from acting on the vehicle. This system, like any other system, has limits and cannot help you to maintain traction and control of the vehicle in all circumstances. Reckless driving can lead to accidents. It is the driver’s responsibility to drive carefully. This means taking into account the traffic, road and environmental conditions.

Electronically Controlled 4WD

The electronically controlled 4WD is a system that improves acceleration performance and stability performance by controlling front-rear distribution of driving torque with

operating the electronic control coupling arranged in the rear differential assembly.

NOTE

- On vehicles equipped with lever type parking brake, if the parking brake lever is pulled up while the vehicle is moving, the front-rear distribution of driving torque control will be temporarily suspended, which will allow the rear wheel to lock easier.

Active Yaw Control (AYC)

Refer to “Active Yaw Control (AYC)” on page 5-81.

S-AWC drive mode

N00542401129

Select the drive mode from the following three types to suit the driving conditions.

S-AWC drive mode	Function
NORMAL	This mode can be used on both dry and wet roads. The distribution of driving/braking torque to each wheel is automatically controlled according to the driving condition.

S-AWC drive mode	Function
SNOW	This mode is for driving on slippery road surfaces, such as snow-covered roads.
GRAVEL	This mode is suitable mainly for driving on unpaved or rough roads. This mode provides 4WD high driving performance and stable cornering performance.

4-wheel drive operation requires special driving skills.

Refer to “4-wheel drive operation” on page 5-72, and take care to drive safely.

NOTE

- The S-AWC drive mode becomes “NORMAL” when you turn on the ignition switch or the operation mode.

S-AWC drive mode-selector

N0058300084

The drive mode can be switched by press the switch while the ignition switch is in the “ON” position or the operation mode is in “ON”.

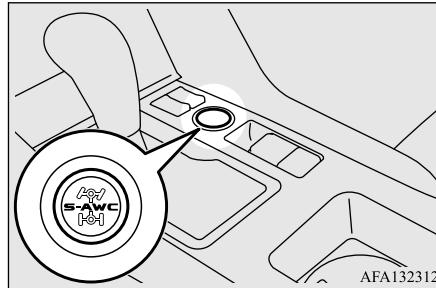

If you press the switch, you can change the drive mode in the order of NORMAL, SNOW, GRAVEL, NORMAL.

CAUTION

- Do not operate the drive mode-selector with the front wheels spinning on a snowy road or in similar conditions. The vehicle could lunge in an unexpected direction.
- Driving on dry, paved roads in “GRAVEL” and “SNOW” mode causes increased fuel consumption and noise and vibration.

NOTE

- Even if an S-AWC drive mode other than “NORMAL” was selected before turning the ignition switch to the “OFF” position or putting the operation mode in OFF, the S-AWC drive mode will be set to “NORMAL” when the ignition switch is turned to the “ON” position or the operation mode is put in ON again.
- The drive mode can be switched while driving or stopped.

S-AWC drive mode display

N00583100069



Example: “NORMAL” mode is selected.

The currently selected drive mode is displayed on the multi-information display. In addition, when the drive mode is changed, the selected mode appears on the interrupt display screen of the information screen in the multi-information display.

The drive mode display will appear on the information screen for a few seconds, and then the original screen will return.

CAUTION

- If the selected drive mode indicator begins blinking, the drive mode will automatically switch to protect the drive-system components. A warning will also be displayed in the information screen in the multi-information display.



**4WD SYSTEM
OVERHEATING
SLOW DOWN**

Reduce speed and, if the indicator stops blinking, you may resume normal driving.

- If the drive mode indicator is blinking, a problem has occurred with the S-AWC. A warning will also be displayed in the information screen in the multi-information display.



**4WD SYSTEM
SERVICE REQUIRED**

Have your vehicle inspected immediately by an authorized Mitsubishi Motors dealer.

- Make sure that all four tires are the same specified size, type, and brand, and have no significant difference in the amount of wear for all four wheels. Otherwise, the S-AWC system may not work properly may be displayed.

5

S-AWC operation display

N00542501087

The S-AWC operation status can be displayed on the information screen in the multi-information display.

To display the status, press the multi-information meter switch to change the information screen.

Refer to “Information screen (With the ignition switch or the operation mode in ON)” on page 5-148.

Display example

The S-AWC operation status is displayed.

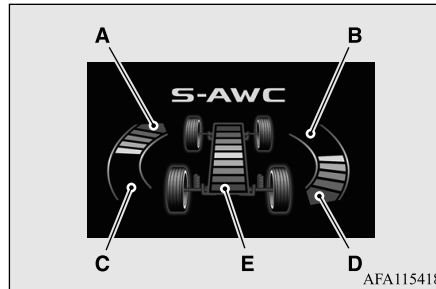

Yaw control function display

The amount of the yaw moment is displayed as a bar graph.

A, D- Clockwise yaw moment about the vehicle’s center of gravity

B, C- Counterclockwise yaw moment about the vehicle’s center of gravity

Traction control level display

The strength of the traction control operation (between the front and rear wheels) is displayed in section E of the meter as a bar graph.

WARNING

- Always concentrate on your driving first. Keep your eyes and mind on the road. Distractions while driving can lead to an accident.

4-wheel drive operation

N00530601212

Your vehicle has been designed primarily for use on pavement.

But its unique 4-wheel drive system allows you to occasionally travel on unpaved roads, to campgrounds, picnic sites, and similar locations.

Not only does this ensure better handling on dry, paved roads but also permits better traction when driving on slippery, wet or snow-covered roads and when moving out of mud.

But it is not suitable for heavy off road use or towing in rough conditions.

It is particularly important to note that 4-wheel drive may not give sufficient hill

climbing ability and engine braking on steep slopes. You should try to avoid driving on steep slopes.

Also, you must exercise caution when driving on sand and mud and when driving through water because sufficient traction may not be available in certain circumstances.

Please avoid driving the vehicle through areas where the tires may get stuck in deep sand or mud.

WARNING

- **Do not over-rely on the 4-wheel drive vehicles. Even 4-wheel drive vehicles have limits to the system and ability to maintain control and traction. Reckless driving may lead to accidents. Always drive carefully, taking account of the road conditions.**
- **Improperly operating this vehicle on or off-pavement can cause an accident or rollover in which you and your passengers could be seriously injured or killed.**
 - Follow all instructions and guidelines in the owner's manual.
 - Keep your speed low and do not drive faster than conditions.

NOTE

- Driving on rough roads can be hard on a vehicle. Before you leave the pavement, be sure all scheduled maintenance and service has been done, and that you have inspected your vehicle. Pay special attention to the condition of the tires, and check the tire pressures.
- Mitsubishi Motors is not responsible to the operator for any damage or injury caused or liability incurred by improper and negligent operation of a vehicle. All techniques of vehicle operation depend on the skill and experience of the operator and other participating parties. Any deviation from the recommended operating instructions above is at their own risk.
- Note that the stopping distance required of the 4-wheel drive vehicle differs very little from that of the front-wheel drive vehicle. When driving on a snow-covered road or a slippery, muddy surface, make sure that you keep a sufficient distance between your vehicle and the one ahead of you.
- The driving posture should be more upright; adjust the seat to a good position for easy steering and pedal operation. Be sure to wear the seat belt.
- After driving on rough roads, check each part of the vehicle and wash it thoroughly with water. Refer to the "Inspection and maintenance following rough road operation" section and "Vehicle care and Maintenance" sections.

CAUTION

- Setting the drive mode-selector to "GRAVEL" and "SNOW" position to drive on dry paved road will increase fuel consumption, with possible noise and vibration generation.

Turning sharp corners

When turning a sharp corner in "GRAVEL" position at low speed, a slight difference in steering may be experienced similar to feeling as if the brakes were applied. This is called tight corner braking and results from each of the four tires being at a different distance from the corner. The phenomenon is typical of 4-wheel drive vehicles. If this occurs, either straighten out the steering wheel or change to another mode.

On snowy or icy roads

Set the drive mode-selector to "SNOW" in accordance with the road conditions, and then gradually depress the accelerator pedal for a smooth start.

NOTE

- The use of snow tires is recommended.

 **NOTE**

- Maintain a safe distance between vehicles, avoid sudden braking, and use engine braking (downshifting).

 **CAUTION**

- Avoid sudden braking, sudden acceleration and sharp turning. Skidding occurs and control of the vehicle could be lost.



Driving on sandy or muddy roads

Set the drive mode-selector to “GRAVEL” and then gradually depress the accelerator pedal for a smooth start. Keep the pressure on the accelerator pedal as constant as possible, and drive at low speed.

 **CAUTION**

- Do not force the vehicle or drive recklessly on sandy surfaces. In comparison with normal road surfaces, the engine and other drive-system components are put under excessive strain when driving on such a surface. This could lead to accidents.
- If any of the following conditions occur while the vehicle is being driven, immediately park your vehicle in a safe place and follow these procedures:

 **CAUTION**

- If the engine coolant temperature display  flashes on the information screen in the multi-information display or the engine power drops suddenly. Refer to “Engine overheating” on page 8-4.
- If the “” warning display and “SLOW DOWN” or the “” warning display and “SERVICE REQUIRED” appear on the information screen in the multi-information display. Refer to “Warning display” on page 5-66.

 **WARNING**

- **When attempting to rock your vehicle out of a stuck position, be sure that the area around the vehicle is clear of people and physical objects. The rocking motion may cause the vehicle to suddenly launch forward/backward, causing injury or damage to nearby people or objects.**

 **NOTE**

- Avoid sudden braking, sudden acceleration and sharp turning; such operations could result in the vehicle becoming stuck.

 **NOTE**

- If the vehicle becomes stuck in sandy or muddy roads, it can often be moved with a rocking motion. Move the selector lever alternately between the “D” (DRIVE) and “R” (REVERSE) positions while pressing lightly on the accelerator pedal.
- Driving on rough road can cause rust on the vehicle; wash the vehicle thoroughly as soon as possible after such use.

Climbing/descending sharp grades

Your vehicle may not provide sufficient hill climbing ability and engine braking on steep slope. Avoid driving on steep slopes even though the vehicle is an 4-wheel drive vehicle.

Driving through water

N0053780085

If the electrical circuits become wet, further operation of the vehicle will be impossible; therefore, avoid driving through water unless absolutely necessary. If driving through water is unavoidable, use the following procedure:

Check the depth of the water and the terrain before attempting to drive through it. Drive

slowly to avoid creating excessive water splashing.

CAUTION

- Never drive through water that is deep enough to cover wheel hubs, axles or exhaust pipe. Do not change the selector lever position while driving through water. Frequent driving through water can adversely affect the life span of the vehicle; consult an authorized Mitsubishi Motors dealer or a repair facility of your choice and take the necessary measures to prepare, inspect, and repair the vehicle.
- After driving through water, apply the brakes to be sure they are functioning properly. If the brakes are wet and not functioning properly, dry them out by driving slowly while lightly depressing the brake pedal. Inspect each part of the vehicle carefully.

Inspection and maintenance following rough road operation

N00530700085

After operating the vehicle in rough road conditions, be sure to perform the following inspection and maintenance procedures:

- Check that the vehicle has not been damaged by rocks, gravel, etc.

- Carefully wash the vehicle with water. Drive the vehicle slowly while lightly depressing the brake pedal in order to dry out the brakes. If the brakes still do not function properly, contact an authorized Mitsubishi Motors dealer or a repair facility of your choice as soon as possible to have the brakes checked.
- Remove the insects, dried grass, etc. clogging the radiator core.
- After driving through water, check the engine, transaxle and differential oil. If the oil or grease is milky or cloudy because of water contamination, it must be replaced with new oil.
- Check the inside of the vehicle. If water entry is found, dry the carpet etc.
- Inspect the headlights. If water is in the headlight housing, have it drained at an authorized Mitsubishi Motors dealer or a repair facility of your choice.

Cautions on the handling of 4-wheel drive vehicles

N00530801256

Tires and wheels

Since the driving torque can be applied to the four wheels, the driving performance of the

vehicle when operating in 4-wheel drive is greatly affected by the condition of the tires.

Pay close attention to the tires.

- Install only the specified tires on all wheels. Refer to “Tires and wheels” on page 11-7.
- Be sure all four tires and wheels are the same size and type. When it is necessary to replace any of the tires or wheels, replace all four.
- All tires should be rotated before the wear difference between the front and rear tires is recognizable.

Good vehicle performance cannot be expected if there is a difference in wear between tires. Refer to “Tire rotation” on page 9-18.

- Check the tire inflation pressure regularly.

CAUTION

- Always use tires of the same size, type, and brand that have no wear differences. Using tires of different size, type, brands or degree of wear, will increase the differential oil temperature and result in possible damage to the driving system. Further, the drive train will be subject to excessive loading, possibly leading to oil leakage, component seizure, or other serious failures.

Towing

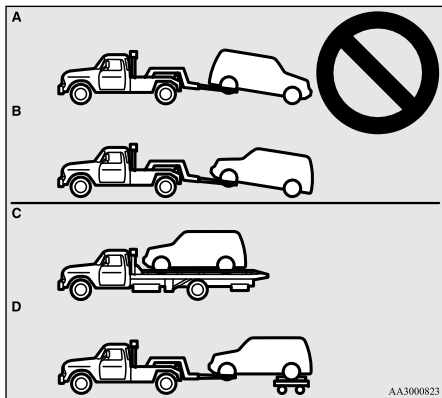

5

CAUTION

- Do not tow 4-wheel drive vehicles with the front or rear wheels on the ground (Type A or Type B) as illustrated. This could result in damage to the drivetrain, or unstable towing. If you tow 4-wheel drive vehicles, use Type C or Type D equipment.
- Even in “NORMAL” drive mode, the vehicle cannot be towed with the front or the rear wheels on the ground.

Jacking up a 4-wheel drive vehicle

WARNING

- Do not crank the engine while jacking up the vehicle. The tire on the ground may turn and the vehicle may roll off the jack.

Service brake

N00517500275

Brake pedal

Overuse of the brake can cause weakening, resulting in poor brake response and premature wear of the brake pads. When driving down a long or steep hill, use engine braking by downshifting.

WARNING

- Do not leave any objects near the brake pedal or let a floor mat slide under it; doing so could prevent the full pedal stroke that would be necessary in an emergency. Make sure that the pedal can be operated freely at all times. Make sure the floor mat is securely held in place.

CAUTION

- It is important not to drive the vehicle with your foot resting on the brake pedal when braking is not required. This practice can result in very high brake temperatures, premature lining wear, and possible damage to the brakes.

Power brakes

N00517600364

Your vehicle is equipped with power brakes for more braking force with less brake pedal effort.

Your brakes are designed to operate at full capacity, even if the power assist is not being used.

If the power assist is not being used, the effort needed to press the brake pedal is greater.

If you should lose the power assist for some reason, the brakes will still work.

If the power brake unit or either of the two brake hydraulic systems stops working properly, the rest of the brake system will still work, but the vehicle will not slow down as quickly.

You will know this has happened if you find you need to press the brake down farther, or harder when slowing down or stopping, or if the brake warning light and the warning display in the multi-information display come on.

⚠ WARNING

- Never coast downhill with the engine OFF. Keep the engine running whenever your vehicle is in motion. If you turn off the engine while driving, the power brake booster will stop working and your brakes will not work as well.
- If the power assist is lost or if either brake hydraulic system stops working properly, take your vehicle to an authorized Mitsubishi Motors dealer or a repair facility of your choice immediately.

Brake pad wear alarm

N00550700124

The disc brakes have an alarm that makes a metallic squeal when the brake pads have worn down enough to need service. If you hear this sound, have the brake pads replaced at an authorized Mitsubishi Motors dealer or a repair facility of your choice.

⚠ WARNING

- Driving with worn brake pads will make it harder to stop, and can cause an accident.

Brake auto hold (if so equipped)

N00592000110

When the vehicle is stopped at traffic lights etc., the vehicle can be held stationary with the brake auto hold system even if you release your foot from the brake pedal. When the accelerator pedal is depressed, the brakes are released.

⚠ WARNING

- Do not overly rely on the brake auto hold system. On steep slope, depress the brake pedal firmly because the system may not hold the vehicle stationary.
- Never leave the vehicle while it is being stopped by the brake auto hold system. When leaving the vehicle, apply the parking brake and move the selector lever to the “P” (PARK) position.
- Do not use brake auto hold system when driving on slippery roads. The system may not hold the vehicle stationary and could result in an accident.

📖 NOTE

- While operating the brake auto hold system, you may hear an operation noise to increase braking force when the system detected the movement of the vehicle. This does not indicate a malfunction.

How to use brake auto hold

To turn on brake auto hold

If the brake auto hold switch is pressed while all of the following conditions are met, the system will change to the standby state and the indicator light (A) on the switch comes on.

- The operation mode is in ON.
- The driver’s seat belt is fastened.
- The driver’s door is closed.

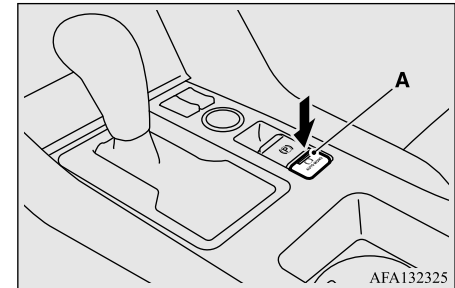

AF A132325

📖 NOTE

- When the brake auto hold system cannot be used, a buzzer will sound and the following warning will appear on the information screen in the multi-information display.

NOTE

- If this warning appears, confirm that all of the conditions for system operation are met and that there is no malfunction in the system.

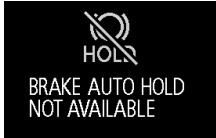

- If this warning appears, fasten the driver's seat belt.



- If any of the following occur while the system is standby state, the brake auto hold system will be turned off automatically and the indicator light on the switch goes off. A buzzer will sound and the message will appear on the information screen in the multi-information display.
 - When the driver's seat belt is unfastened.
 - When the driver's door is opened.
 - When there is a malfunction in the system



NOTE

- If keeping pressing the brake auto hold switch after setting the brake auto hold to ON (stand by), the brake auto hold will return to OFF as a protection function is operated.

After returning to OFF, the brake auto hold will not be switched to ON (Stand by) even if the brake auto hold switch is pressed. To set the brake auto hold to ON, restart the engine and press the brake auto hold switch again.

To activate brake auto hold

When the vehicle is stopped by depressing the brake pedal with the selector lever in any position other than "P" (PARK) or "R" (REVERSE), the brake auto hold activates and the vehicle will be held stationary. The brake auto hold indicator light in the instrument cluster will come on while the system activates.

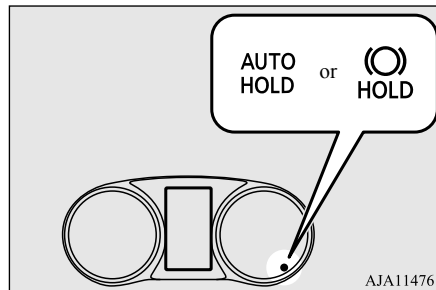

CAUTION

- Release the brake pedal only after the brake auto hold indicator light has illuminated.

NOTE

- In the following situations, the brake auto hold system may not operate temporarily.
 - The vehicle is stopped on a slippery road.
 - The vehicle was stopped while the steering wheel was turned all the way to the left or right.
 - The vehicle is being turned on a parking lot turntable.
- If this occurs, the brake auto hold system will return to the normal operation if you depress the accelerator pedal and the vehicle starts moving again.
- If the following operation is performed, the brake auto hold will be deactivated and the brake auto hold indicator light in the instrument cluster goes off.
 - When shifting the selector lever to the "P" (PARK) or "R" (REVERSE) position with depressing the brake pedal.
 - When the Electric parking brake is applied by using the Electric parking brake switch.

 **NOTE**

- While the vehicle is held stationary with the brake auto hold system, the Electric parking brake will be automatically applied under the following conditions, and a buzzer will sound and the message will appear on the information screen in the multi-information display.
 - After approximately 10 minutes has elapsed with applying the brake auto hold system.
 - When the driver's seat belt is unfastened.
 - When the driver's door is opened.
 - When the operation mode is put in OFF.
 - When the system detects the vehicle moving down a slope.

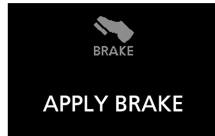

If the Electric parking brake cannot be applied automatically due to the system malfunction, the message will appear on the information screen in the multi-information display. Depress the brake pedal.

 **NOTE**

- If the operation mode is put in OFF with the selector lever in any position other than "P" (PARK) position, the message may appear on the information screen in the multi-information display.

If the message appears, shift the selector lever to the "P" (PARK) position while depressing the brake pedal.

**To start the vehicle**

Depress the acceleration pedal with the selector lever in any position other than "P" (PARK) or "N" (NEUTRAL). The brakes are released, and the brake auto hold indicator light in the instrument cluster will go off.

To turn off brake auto hold

Press the brake auto hold switch to turn off the brake auto hold. The indicator light on the switch goes off.

If you want to turn off the system while the brake auto hold indicator light is illuminated, press the switch with depressing the brake pedal.

 **NOTE**

- If the brake auto hold system is turned off without the brake pedal being depressed, a buzzer will sound and the message will appear on the information screen in the multi-information display.

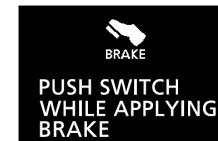
**Hill start assist**

N00562601143

The hill start assist makes it easy to start off on a steep uphill slope by preventing the vehicle from moving backwards. It keeps the braking force for approximately 2 seconds when you move your foot from the brake pedal to the accelerator pedal.

⚠ CAUTION

- Do not overly rely on the hill start assist to prevent backwards movement of the vehicle. Under certain circumstances, even when hill start assist is activated, the vehicle may move backwards if the brake pedal is not sufficiently depressed, if the vehicle is heavily loaded, or if the road is very steep or slippery.
- The hill start assist is not designed to keep the vehicle stopped in place on uphill slopes for more than 2 seconds.
- When facing uphill, do not rely on using the hill start assist to maintain a stopped position as an alternative to depressing the brake pedal. Doing so could cause an accident.
- Do not turn the ignition switch to the “OFF” or “ACC” position or put the operation mode in OFF or ACC while the hill start assist is operating. The hill start assist could stop operating, which could result in an accident.

To operate

N00562701144

1. Stop the vehicle completely using the brake pedal.
2. Release the brake pedal and the hill start assist will maintain the braking force applied while stopped for approximately 2 seconds.

3. Depress the accelerator pedal and the hill start assist will gradually decrease the braking force as the vehicle starts moving.

📖 NOTE

- The hill start assist is activated when all of the following conditions are met.
 - The engine is running. (The hill start assist will not be activated while the engine is starting or immediately after the engine is started.)
 - The selector lever is in any position other than “P” (PARK) or “N” (NEUTRAL).
 - The vehicle is completely stationary, with the brake pedal depressed.
 - The parking brake is released.
- The hill start assist will not operate if the accelerator pedal is depressed before the brake pedal is released.
- The hill start assist also operates when reversing on an uphill slope.

Warning light/display

N00562801129

If an abnormal condition occurs in the system, the following warning light/display will turn on.

Warning light



- ASC indicator

Warning display



⚠ CAUTION

- If the warning is displayed, the hill start assist will not operate. Start off carefully.
- Park your vehicle in a safe place and stop the engine. Restart the engine and check whether the light/display goes out, in which case the hill start assist is again working normally. If they remain displayed or reappear frequently, it is not necessary to stop the vehicle immediately, but the vehicle should be inspected by an authorized Mitsubishi Motors dealer or a repair facility of your choice as soon as possible.

Brake assist system

N00567301145

The brake assist system is a device assisting drivers who cannot depress the brake pedal firmly such as in emergency stop situations and provides greater braking force.

If the brake pedal is depressed suddenly, the brakes will be applied with more force than usual.

⚠ CAUTION

- The brake assist system is not a device designed to exercise braking force greater than its capacity. Make sure to always keep a sufficient distance between your vehicle and a vehicle in front of you without relying too much on the brake assist system.

📖 NOTE

- Once the brake assist system is operational, it maintains great braking force even if the brake pedal is lightly released.
To stop its operation, completely remove your foot from the brake pedal.
- The brake assist system may become operational when the brake pedal is fully depressed even if it has not been depressed suddenly.
- When the brake assist system is in use while driving, you may feel as if the depressed brake pedal is soft, the pedal moves in small motions in conjunction with the operation noise, or the vehicle body and the steering wheel vibrate. This occurs when the brake assist system is operating normally and does not indicate faulty operation. Continue to depress the brake pedal.
- You may hear an operation noise when the brake pedal is suddenly or fully depressed while stationary. This does not indicate a malfunction and the brake assist system is operating normally.

📖 NOTE

- When the anti-lock brake system warning light or only active stability control warning light illuminate, the brake assist system is not functioning.

Active Yaw Control (AYC)

N00596700030

The Active Yaw Control (AYC) is a system with a yaw control function, that controls the left-right driving/braking force using the brakes.

Yaw control function

The yaw control function is a function that enhances vehicle cornering performance and vehicle stability with management of vehicle turning power (yaw moment) by controlling the drive power difference of the left and right wheels and the braking force when the vehicle does not turn in response to steering input, such as when the steering wheel is turned quickly or when driving on slippery road.

⚠ CAUTION

- Control of the braking force does not enhance the stopping performance of the vehicle, therefore, pay careful attention to the safety of your surroundings when driving.

AYC operation display

The AYC operation status can be displayed on the information screen in the multi-information display.

To display the status, press the multi-information display switch to change the information screen.

Refer to “Information screen (With the ignition switch or the operation mode in ON)” on page 5-148.

Yaw control function display**Vehicles with S-AWC**

Refer to “S-AWC operation display” on page 5-72.

Vehicles with 2WD

The AYC operation status is displayed.

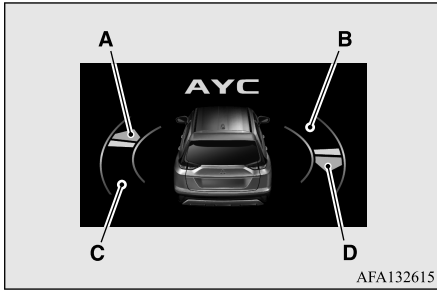

5

The amount of the yaw moment is displayed as a bar graph.

- A, D- Clockwise yaw moment about the vehicle's center of gravity
B, C- Counterclockwise yaw moment about the vehicle's center of gravity

WARNING

- Always concentrate on your driving first. Keep your eyes and mind on the road. Distractions while driving can lead to an accident.

Anti-lock braking system

N00517901351

The anti-lock braking system helps prevent the wheels from locking up when braking.

This helps maintain vehicle drivability and steering wheel handling.

Driving hints

- When using the anti-lock brakes (sudden braking), steering is slightly different from normal driving conditions. Use the steering wheel carefully.
- Always keep a safe distance from the vehicle in front of you. Even if your vehicle is equipped with the anti-lock braking system, leave a greater braking distance when:
 - Driving on gravel or snow-covered roads.
 - Driving on uneven road surfaces.
- Operation of anti-lock braking system is not restricted situations where brakes are applied suddenly. This system may also prevent the wheels from locking when you drive over manholes, steel roadwork plates, road markings, or any uneven road surface.
- When the anti-lock braking system is in use, you may feel the brake pedal vibrating and hear a unique sound. It may also feel as if the pedal resists being pressed. **In this situation, simply hold the brake pedal down firmly. Do not pump the brake, which will result in reduced braking performance.**

CAUTION

- The anti-lock braking system cannot prevent accidents. It is your responsibility to take safety precautions and to drive carefully.
- To prevent failure of the anti-lock braking system, be sure all four wheels and tires are the same size and the same type.

NOTE

- A whining sound is emitted from the engine compartment when driving immediately after starting the engine. These are the normal sounds the anti-lock braking system makes when performing a self-check. It does not indicate a malfunction.
- The anti-lock braking system can be used after the vehicle has reached a speed over approximately 6 mph (10 km/h). It stops working when the vehicle slows below 3 mph (5 km/h).

Anti-lock braking system warning light / display

N00531601701

Warning light



Warning display



If there is a malfunction in the system, the anti-lock braking system warning light will come on and the warning display will appear on the information screen in the multi-information display.

Under normal conditions, the anti-lock braking system warning light only comes on when the ignition switch is turned to the “ON” position or the operation mode is put in ON and goes off a few seconds later.

CAUTION

- Any of the following indicates that the anti-lock braking system is not functioning and only the standard brake system is working. (The standard brake system is functioning normally.) If this happens, take your vehicle to an authorized Mitsubishi Motors dealer or a repair facility of your choice.
 - When the ignition switch is in the “ON” position or the operation mode is put in ON, the warning light does not come on or it remains on and does not go off
 - The warning light comes on while driving
 - The warning display appears while driving

If the warning light/display illuminate while driving

N00531701715

If only the anti-lock braking system warning light/display illuminate

- Avoid hard braking and high-speed driving. Stop the vehicle in a safe place. Test the system by restarting the engine and driving at a speed of approximately 12 mph (20 km/h) or higher. If the warning light/display then remains off during driving, there is no abnormal condition. However, if the warning light/display do not disappear, or if they come on again when the vehicle is driven, have the vehicle checked by an authorized Mitsubishi Motors dealer or repair facility of your choice as soon as possible.

If the anti-lock braking system warning light/display and brake warning light/display illuminate at the same time

Warning light

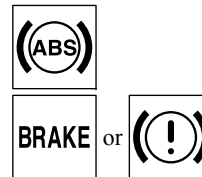

Warning display

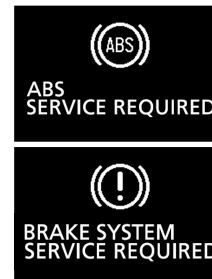

The anti-lock braking system and brake force distribution function may not work, so hard braking could make the vehicle unstable. Avoid hard braking and high-speed driving. Stop the vehicle in a safe place and contact an authorized Mitsubishi Motors dealer or repair facility of your choice.

NOTE

- The anti-lock braking system warning light and brake warning light illuminate at the same time and the warning displays appear alternately on the information screen in the multi-information display.

5

After driving on icy roads

N00529201104

After driving on snow or icy roads, remove any snow and ice which may have be left around the wheels. When doing this, be careful not to damage the wheel speed sensors (A) and the cables located at each wheel.

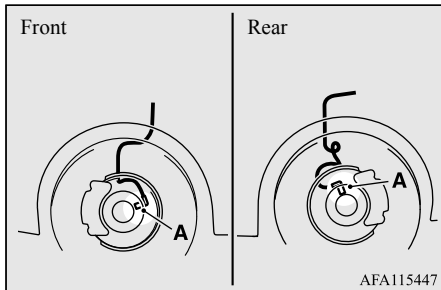

Electric power steering system (EPS)

N00568401172

The power steering system operates while the engine is running. It helps reduce the effort needed to turn the steering wheel.

The power steering system has mechanical steering capability in case the power assist is lost. If the power assist is lost for some reason, you will still be able to steer your vehicle, but you will notice it takes much more effort to steer. If this happens, have your vehicle inspected at an authorized Mitsubishi Motors dealer or a repair facility of your choice.

WARNING

- Do not stop the engine while the vehicle is moving. Stopping the engine would make the steering wheel extremely hard to turn, possibly resulting in an accident.

NOTE

- During repeated full-lock turning of the steering wheel (for example, while you are manoeuvring the vehicle into a parking space), a protection function may be activated to prevent overheating of the power steering system. This function will make the steering wheel gradually harder to turn. In this event, limit your turning of the steering wheel for a while. When the system has cooled down, the steering effort will return to normal.
- If you turn the steering wheel while the vehicle is stationary with the headlights on, the headlights may become dim. This behavior is not abnormal. The headlights will return to their original brightness after a short while.

Electric power steering system warning light/display

Warning light



Warning display



If there is a malfunction in the system, the warning light will come on and the warning display will appear on the information screen in the multi-information display.

Under normal conditions, the warning light comes on when the ignition switch is turned to the “ON” position or the operation mode is put in ON, and goes off after the engine has started.

CAUTION

- If the warning display appears while the engine is running, have the vehicle inspected by an authorized Mitsubishi Motors dealer or a repair facility of your choice as soon as possible. It may become harder to turn the steering wheel.

Active stability control (ASC)

N00559101199

The Active stability control (ASC) takes overall control of the anti-lock braking system, traction control function and skid control function to help maintain the vehicle’s control and traction. Please read this section in conjunction with the page on the anti-lock braking system, traction control function and skid control function.

Anti-lock braking system → P.5-82

Traction control function → P.5-85
Skid control function → P.5-85

CAUTION

- Do not over-rely on the ASC. Even the ASC cannot prevent the natural laws of physics from acting on the vehicle. This system, like any other system, has limits and cannot help you to maintain traction and control of the vehicle in all circumstances. Reckless driving can lead to accidents. It is the driver’s responsibility to drive carefully. This means taking into account the traffic, road and environmental conditions.
- Be sure to use the same specified type and size of tire on all four wheels. Otherwise, the ASC may not work properly.
- Do not install any aftermarket limited slip differential (LSD) on your vehicle. The ASC may stop functioning properly.

NOTE

- An operation noise may be emitted from the engine compartment in the following situations. The sound is associated with checking the operations of the ASC. At this time, you may feel a shock from the brake pedal if you depress it. These do not indicate a malfunction.
 - When the ignition switch is set to the “ON” position or the operation mode is put in ON.
 - When the vehicle is driven for a while after the engine is turned on.

NOTE

- When the ASC is activated, you may feel a vibration in the vehicle body or hear a whining sound from the engine compartment. This indicates that the system is operating normally. It does not indicate a malfunction.
- When the anti-lock braking system warning light is illuminated, the ASC is not active.

5

Traction control function

N00559200021

On slippery surfaces, the traction control function prevents the drive wheels from spinning excessive, thus helping the vehicle to start moving from a stopped condition. It also provides sufficient driving force and steering performance as the vehicle turns while pressing the acceleration pedal.

CAUTION

- When driving a vehicle on a snowy or icy road, be sure to install snow tires and drive the vehicle at moderate speeds.

Skid control function

N00559301074

The skid control function is designed to help the driver maintain control of the vehicle on slippery roads or during rapid steering

Active stability control (ASC)

maneuvers. It works by controlling the engine output and the brake on each wheel.

NOTE



- The skid control function operates at speeds of approximately 9 mph (15 km/h) or higher.

5

ASC OFF switch

N00559401336

The ASC is automatically activated when the ignition switch is turned to the “ON” position or the operation mode is put in ON. You can deactivate the system by pressing down the ASC OFF switch for 3 seconds or longer.

When the ASC is deactivated, the  indicator will turn on. To reactivate the ASC, momentarily press the ASC OFF switch; the  indicator is turned off.

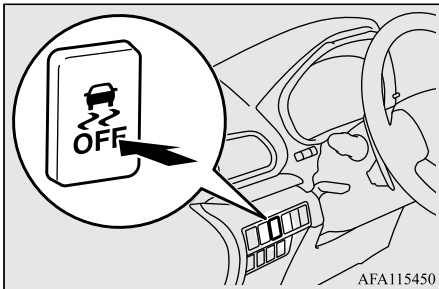

CAUTION

- For safety reasons, the ASC OFF switch should be operated when your vehicle is stopped.
- Be sure to keep the ASC on while driving in normal circumstances.

NOTE

- Using the ASC OFF switch turns off both the stability control function and the traction control function.
- When moving out of mud, sand or fresh snow, pressing the accelerator pedal may not allow the engine speed to increase. In such situations, temporarily turning off ASC with the ASC OFF switch will make it easier to move out your vehicle.
- If you continue to press the ASC OFF switch after the ASC is turned off, the “mistaken operation protection function” will activate and the ASC will turn back on.

ASC operation display or ASC OFF indicator

N00559501252





- ASC operation display/ASC indicator
The display/indicator will blink when the ASC is operating.



- ASC OFF indicator
This indicator will turn on when the ASC is turned off with the ASC OFF switch.

CAUTION



- When  display/indicator blinks, ASC is operating, which means that the road is slippery or that your vehicle’s wheels are beginning to slip. If this happens, drive slower.
- If the temperature in the braking system continues to increase due to continuous brake control on a slippery road surface, the  indicator will blink.

To prevent the brake system from overheating, the brake control of the traction control function will be temporarily suspended.

The engine control of the traction control function and normal brake operation will not be affected.

Park your vehicle in a safe place. When the temperature in the braking system has come down, the  indicator will be turned off and the traction control function will start operating again.

NOTE

- The  indicator may come on when you start the engine. This means that the battery voltage momentarily dropped when the engine was started. It does not indicate a malfunction, provided that the display goes out immediately.
- When a spare tire has been put on your vehicle, the gripping ability of the tire will be lower, making it more likely that the  display/indicator will blink.

ASC warning light/display

N00546601158

If an abnormal condition occurs in the system, the following warning light/display will turn on.

Warning light



- ASC indicator



- ASC OFF indicator

Warning display

**CAUTION**

- The system may be malfunctioning. Park your vehicle in a safe place and stop the engine. Restart the engine and check whether the light/display goes out. If they go out, there is no abnormal condition. If they do not go out or if they turn on frequently, it is not necessary to stop the vehicle immediately, but you should have your vehicle inspected by an authorized Mitsubishi Motors dealer or a repair facility of your choice as soon as possible.

Towing

N00546301096

CAUTION

- When towing the vehicle with only the front wheels or only the rear wheels raised off the ground, do not place the ignition switch in the “ON” position or do not put the operation mode in ON. Placing the ignition switch in the “ON” position or putting the operation mode in ON could cause the ASC to operate, resulting in an accident. Note that the correct towing method depends on the transmission type and the vehicle’s drive configuration. For details, refer to “Towing” on page 8-11.

Cruise control

N00518301668

Cruise control is an automatic speed control system that keeps a set speed. It can be activated at speeds from approximately 20 mph (30 km/h). Cruise control does not work at speeds below approximately 20 mph (30 km/h).

CAUTION

- When you do not wish to drive at a set speed, turn off the cruise control for safety.

CAUTION

- Do not use cruise control when driving conditions will not allow you to stay at the same speed, such as in heavy traffic or on roads that are winding, icy, snow-covered, wet, slippery, on a steep downhill slope.

5

NOTE

- Cruise control may not be able to keep your speed on uphills or downhills.
- Your speed may decrease on a steep uphill. You may use the accelerator pedal if you want to stay at your set speed.
- Your speed may increase to more than the set speed on a steep downhill. You have to use the brake to control your speed. As a result, the set speed driving is deactivated.

Cruise control switches

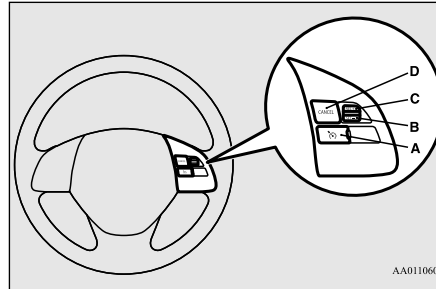

- A- **CRUISE CONTROL ON/OFF switch**
Used to turn on and off the cruise control.
- B- **“SET -” switch**
Used to reduce the set speed and to set the desired speed.
- C- **“RES +” switch**
Used to increase the set speed and to return to the original set speed.
- D- **“CANCEL” switch**
Used to deactivate the set speed driving.

NOTE

- When operating the cruise control switches, press the cruise control switches correctly. The set speed driving may be deactivated automatically if two or more switches of the cruise control are pressed at the same time.

To activate

N00518401496

1. With the ignition switch in the “ON” position or the operation mode in ON, press the CRUISE CONTROL ON/OFF switch to turn on the cruise control. The indicator display appear on the information screen of the multi-information display will come on.

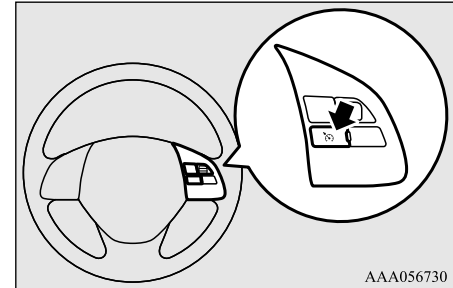

2. Accelerate or decelerate to your desired speed, then push down and release the “SET -” switch when the indicator display appear on the information screen of the multi-information display. The vehicle will then maintain the desired speed. The “SET” indicator appears on the information screen of the multi-information display.

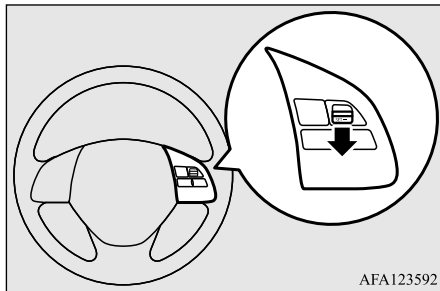

NOTE

- When you release the “SET -” switch, the vehicle speed will be set.

To increase the set speed

N00518501442

There are two ways to increase the set speed.

RES + switch

Push up and hold the “RES +” switch while driving at the set speed, and your speed will then gradually increase.

When you reach your desired speed, release the switch. Your new cruising speed is now set.

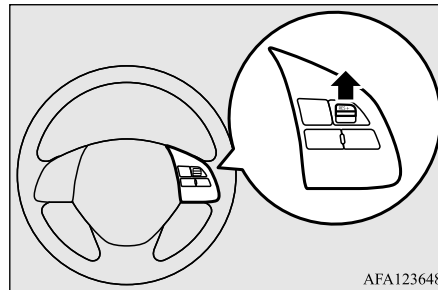

To increase your speed in small amounts, push up the “RES +” switch for less than approximately 1 second and release it. Each time you push up the “RES +” switch, your vehicle will go approximately 1 mph (1.6 km/h) faster.

Accelerator pedal

While driving at the set speed, use the accelerator pedal to reach your desired speed and then push down the “SET -” switch and release the switch momentarily to set a new desired cruising speed.

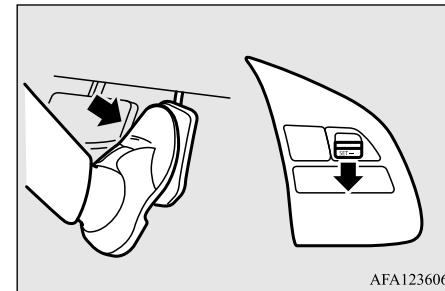

To decrease the set speed

N00518601368

There are two ways to decrease the set speed.

SET - switch

Push down and hold the “SET -” switch while driving at the set speed, and your speed will slow down gradually.

When you reach your desired speed, release the switch. Your new cruising speed is now set.

5

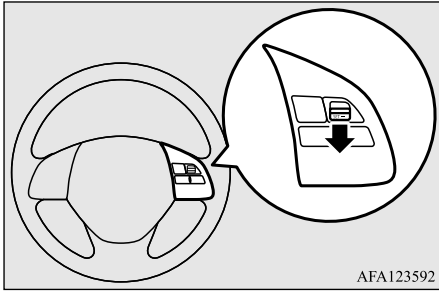

To slow down your speed in small amounts, push down the “SET -” switch for less than approximately 1 second and release it. Each time you push down the “SET -” switch, your vehicle will slow down by approximately 1 mph (1.6 km/h).

Brake pedal

While driving at the set speed, use the brake pedal, which disengages the cruise control, then push down the “SET -” switch and release the switch momentarily to set a new desired cruising speed.

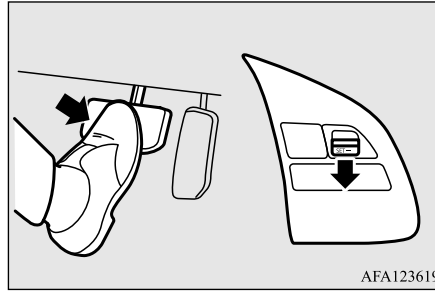

To temporarily increase or decrease the speed

N00541701138

To temporarily increase the speed

Depress the accelerator pedal as you would normally. When you release the pedal, you will return to your set speed.

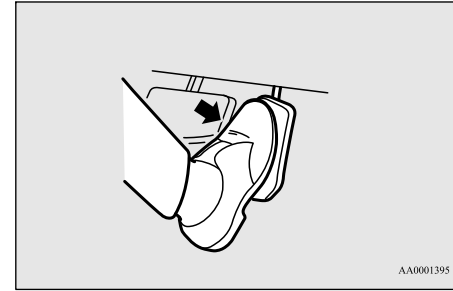

NOTE

- In some driving conditions, the set speed driving may be deactivated. If this happens, refer to “To activate” on page 5-88 and repeat the speed setting procedure.

To temporarily decrease the speed

Depress the brake pedal to decrease the speed. To return to the previously set speed, push up the “RES +” switch. Refer to “To resume the set speed” on page 5-91.

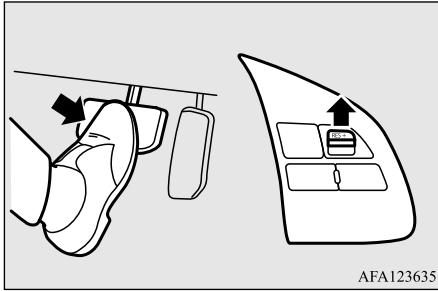

To deactivate

N00518801676

The set speed driving can be deactivated as follows:

- Press the CRUISE CONTROL ON/OFF switch (Cruise control will be turned off.)
- Press the “CANCEL” switch.
- Depress the brake pedal.

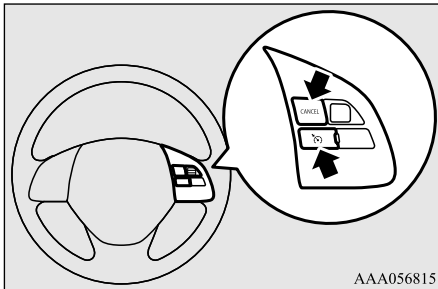

The set speed driving is deactivated automatically in any of the following ways.

- When your speed slows to approximately 10 mph (15 km/h) or more below the set speed because of a hill, etc.
- When your speed slows to approximately 20 mph (30 km/h) or less.
- When the active stability control (ASC) starts operating.
Refer to “Active stability control (ASC)” on page 5-85.

WARNING

- **Although the set speed driving will be deactivated when shifting to the “N” (NEUTRAL) position, never move the selector lever to the “N” (NEUTRAL) position while driving. You would have no engine braking and could cause a serious accident.**

Also, the set speed driving may be deactivated as follow:

- When the engine speed rises and approaches the tachometer’s red zone (the red-colored part of the tachometer dial).

CAUTION

- When the set speed driving is deactivated automatically in any situation other than those listed above, there may be a system malfunction.

Press the CRUISE CONTROL ON/OFF switch to turn off the cruise control and have your vehicle inspected by an authorized Mitsubishi Motors dealer or a repair facility of your choice.

5

To resume the set speed

N00518901420

If the set speed driving is deactivated by the condition described in “To deactivate” on page 5-91, you can resume the previously set speed by push up the “RES +” switch while driving at a speed of approximately 20 mph (30 km/h) or higher.

The “SET” indicator appears on the information screen of the multi-information display.

5

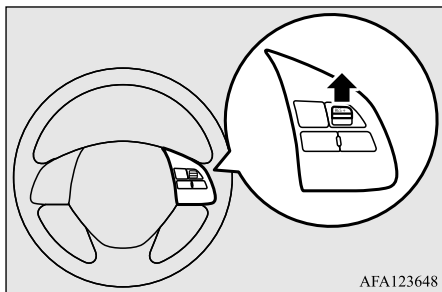

Under either of the following conditions, however, using the switch does not allow you to resume the previously set speed. In these situations, repeat the speed setting procedure:

- The CRUISE CONTROL ON/OFF switch is pressed.
- The ignition switch is turned to the “OFF” position or the operation mode is put in OFF.
- Indicator go off.

Adaptive Cruise Control System (ACC) (if so equipped)

N00576800080

Adaptive Cruise Control System (ACC) maintains a set speed with no need for you to use the accelerator pedal. Using a sensor (A), the system also measures the relative speed and distance between your vehicle and a vehicle in front, and maintains a set following distance between your vehicle and the vehicle in front by automatically decelerating your vehicle if it becomes too close to the vehicle in front.

The cruising set speed can be set from 20 to 110 mph (30 to 180 km/h). The distance can be selected from four levels.

If the vehicle in front decelerates, the ACC will automatically apply limited braking to maintain the distance, and if the front vehicle then accelerates, the ACC will automatically accelerate your vehicle up to the set speed. If your vehicle is approaching too close to the front vehicle, a buzzer will sound and a warning is shown in the multi-information display. When the ACC detects no vehicle ahead, the set speed will be maintained.

Conventional cruise control mode without the distance control can also be selected.

Stop lights are illuminated during automatic braking.

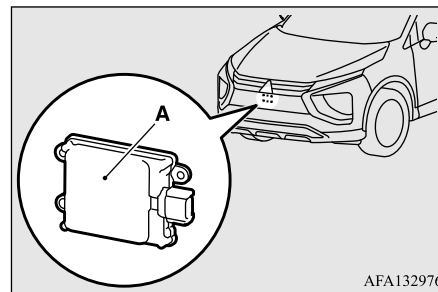

WARNING

- Before using the ACC, read this entire section to understand the limitations of this system. Failure to follow instructions could result in an accident.
- Never rely solely on the ACC. The ACC is not a collision avoidance system or an automatic driving system. It is designed to use only limited braking and is never a substitute for your safe and careful driving. Always be ready to apply the brakes manually.

Cruise control switch

N0057700047

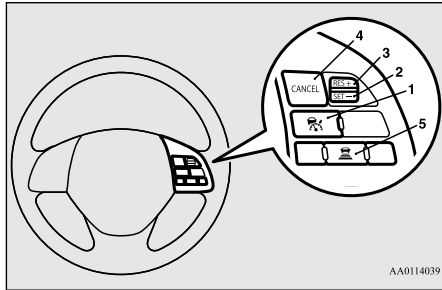

AA0114039

1- ACC ON/OFF switch

Used to turn on and off the ACC system.

2- “SET -” switch

Used to set a desired speed or to reduce the set speed.

3- “RES +” switch

Used to resume the control function after cancelling the ACC or the conventional cruise control.

Also used to increase the set speed.

4- “CANCEL” switch

Used to cancel the control function of the ACC or the cruise control.

5- ACC distance switch

Used to set or change the following distance between your vehicle and a vehicle in front.

NOTE

- Operate the individual switches correctly and one after another.
The ACC may be cancelled if two or more switches are pressed concurrently

ACC indicators

N00577100064

While the ACC is turned on, indicators for the ACC are shown in the multi-information display.

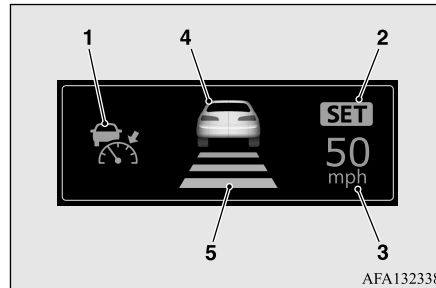

AFA132338

1- ACC indicator:

Indicating that the ACC is turned on.

2- Control state indicator:

Indicating that ACC is activated.

Two types of indication; “SET” and “HOLD” (stationary vehicle hold state)

3- Set speed indicator:

Indicating the set speed.

If the set speed is not set, “---” is shown.

4- Front vehicle indicator:

Indicating when the ACC detects a vehicle ahead.

When a front vehicle is detected while the ACC is activated, the Active front vehicle indicator shown in the illustration below will illuminate.

When a front vehicle is detected while the ACC is not activated or the ACC is canceled, the Stand by front vehicle indicator will illuminate.

5

Display	State	
	Stand by	Active
Vehicle in front detected		

Adaptive Cruise Control System (ACC) (if so equipped)

5- Following distance indicator:

Indicating the following distance.

Two states: "Stand by" and "Active"

When a front vehicle is detected while the ACC is activated, the Active following distance indicator shown in the illustration below will illuminate.

When a front vehicle is detected while the ACC is not activated or the ACC is canceled, the Stand by following distance indicator will illuminate.

5

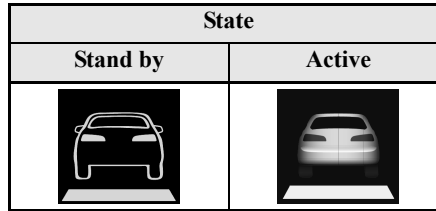

How to use ACC

N00577200094

To turn on ACC

When the operation mode is in ON, press the ACC ON/OFF switch.

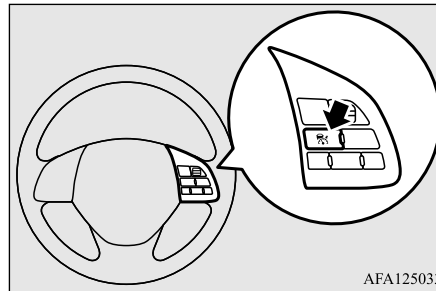

The ACC indicators will appear in the multi-information display.



NOTE

- Every time the operation mode is put in OFF, the ACC is turned off.

To turn off ACC

Press the ACC ON/OFF switch to turn off the ACC.

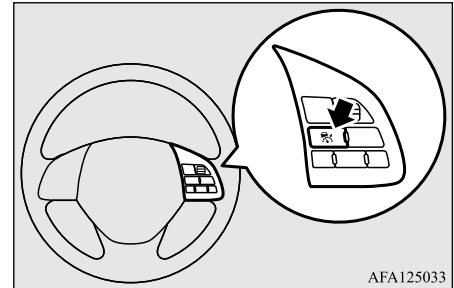

NOTE

- The ACC can be turned off even while the ACC is active.
- Every time the operation mode is put in OFF, the ACC is turned off and the set speed is erased.

To activate ACC control

With the ACC turned on, push down the “SET -” switch while driving, and when your vehicle reaches your desired speed, release the “SET -” switch. The ACC will activate and initiate the speed control to maintain the set speed.

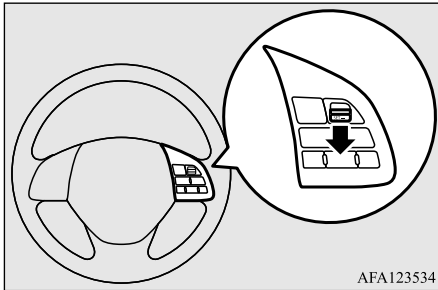

The set indicator comes on, the set speed is indicated and the following distance indicator changes to the active display.



While the ACC system is turned on (in the standby state), if you push down the “SET -” switch when a vehicle in front is detected while your vehicle is stopped and you are depressing the brake pedal, “HOLD” will

appear and the vehicle speed will be set to 20 mph (30 km/h).



You can set the speed anywhere from approximately 20 to 110 mph (30 to 180 km/h). While a vehicle in front is being detected and your vehicle speed is between approximately 0 to 20 mph (0 to 30 km/h), you can activate the ACC. In this case, the set speed will be set at 20 mph (30 km/h).

The ACC cannot otherwise be activated while your vehicle is traveling less than 20 mph (30 km/h) or greater than 110 mph (180 km/h).

NOTE

- When any of the following conditions are present, the ACC will not activate.
 - When your vehicle speed is more than 110 mph (180 km/h).
 - When your vehicle is driven at speeds between approximately 0 to 20 mph (0 to 30 km/h) and the ACC is not detecting a vehicle in front.
 - When ASC is in the OFF position.
 - While ABS, ASC or TCL is activated.
 - When the selector lever is in positions other than “D” (DRIVE).
 - While the brake pedal is depressed (only while the vehicle is moving).

NOTE

- While the parking brake is applied.
- When the ACC system has judged that the performance for detecting a front vehicle is degraded.
- When an abnormality in the ACC system has been detected.
- When the driver’s seat belt is unfastened.
- When the driver’s door is opened.
- When the vehicle is stopped on a steep slope.

When ACC detects no vehicle in front within the set distance

N00581300038

The speed of your vehicle will be maintained at the speed you have set. The speed can be set between approximately 20 to 110 mph (30 to 180 km/h).

NOTE

- If the vehicle speed exceeds the set speed on a down slope, the system will automatically apply the brake to maintain the vehicle set speed.

When ACC detects a vehicle in front within the set distance

N00581400068

The ACC will maintain the distance to the front vehicle and will apply the brakes automatically when the system judges braking is necessary. The distance can be selected from four levels.



When the front vehicle stops, the ACC will automatically apply the brakes to stop your vehicle.

After the vehicle stops, the ACC system automatically enters the stationary vehicle hold state. "HOLD" appears.



While the ACC system is in the stationary vehicle hold state, if it is possible to resume following the vehicle in front because it has started moving, "ACC READY TO RESUME" will appear on the information screen of the multi-information display. To start moving again, press the "RES+" switch or depress the accelerator pedal.



WARNING

- Never leave your vehicle while the ACC system is in the stationary vehicle hold state. When leaving the vehicle, apply the parking brake and move the selector lever to the "P" (PARK) position.

NOTE

- When the ACC system is in the stationary vehicle hold state, the stop lights will illuminate.
- While the ACC system is in the stationary vehicle hold state, the vehicle will not start moving again unless you press the "RES+" switch or depress the accelerator pedal.
- When depressing the brake pedal while the automatic brake is applied, the brake pedal will feel firm. This is normal. Depress the brake pedal harder to apply greater braking force.
- During the automatic braking, operation sounds may be heard. This is normal.
- If the turn signal lever is operated while the ACC is active, the system may accelerate the vehicle to assist you in passing a vehicle in front.

NOTE

- If the vehicle in front starts moving within 2 seconds after stopping, your vehicle will start moving.

When the ACC no longer detects a vehicle in front, the buzzer will sound, the vehicle symbol in the display will disappear and your vehicle will slowly accelerate to the set speed.



WARNING

- Your vehicle may accelerate up to the set speed in the following situations. Apply the brake, if necessary, to slow down.
- When your vehicle no longer follows the vehicle in front, e.g. at a freeway exit or when your vehicle or the vehicle in front changes its lane.

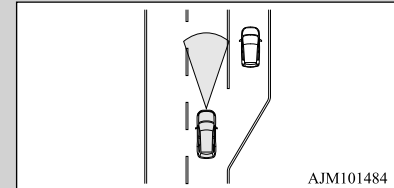

⚠ WARNING

- When driving on a curve.



- When the vehicle in front has changed its course or lane, if a stationary vehicle appears in front your vehicle, the ACC will not decelerate your vehicle.

Approach alarm

N00576900052

While the ACC is activated, if your vehicle is approaching too closely to the vehicle in front, the ACC gives a warning by sounding a buzzer and displaying a message. Apply the brakes to maintain the appropriate distance to the vehicle in front.

BRAKE!**⚠ WARNING**

- When the ACC is not being used, turn off the system to avoid unexpected ACC activation.
- Never operate the ACC from outside the vehicle.
- The ACC will not decelerate your vehicle and/or give the approach alarm in the following cases.
 - When an object other than a vehicle, such as a pedestrian, is in front.
 - When a malfunction is detected in the system.
- The ACC will not decelerate your vehicle in the following cases, but will give the approach alarm.
 - When the front vehicle is stationary or moving at an extremely slow speed.
 - When your brake system has a problem, such as overheating.
- The ACC may not be able to maintain the set speed or the distance to a vehicle in front and may not alert the driver, if the system cannot detect the front vehicle properly. Typical situations include:
 - When a vehicle cuts into your path at a close distance.
 - When a vehicle in front is not completely in your path.
 - When a vehicle in front is towing a trailer.
 - When a motorcycle or a bicycle is in front.

⚠ WARNING

- When a vehicle in front is a truck loaded with freight that protrudes rearward from the cargo bed.
- When the height of a vehicle in front is extremely low or the road clearance of the vehicle is extremely high.
- When driving on a road with alternating up and down surfaces.
- When driving on a curve.
- When driving on a bumpy or rough road.
- When driving in a tunnel.
- When driving in construction zones.
- When the rear of your vehicle is weighed down with the weight of passengers and luggage
- For up to 2 minutes after starting driving.
- When driving in curved sections of road including their entrance/outlet or running beside a closed lane in a traffic work or similar zone.

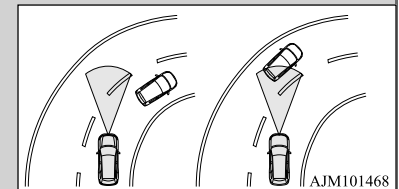

- When the surface of the sensor is covered with dirt, snow, ice, etc.
- When a front vehicle or an oncoming vehicle is splashing water, snow or dirt.

⚠ WARNING

- When driving on a winding road.

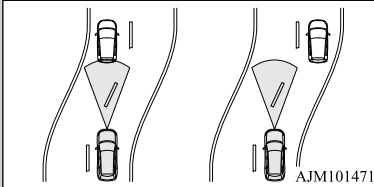

- Never use the ACC in the following situations:

- In heavy traffic.
- On winding roads.
- On slippery roads, such as icy, snow-covered or dirt roads.
- In adverse weather conditions, such as rain, snow or sand storms, etc.
- On steep downslopes.
- When the inclination of a road frequently changes.
- When the approach alarm frequently sounds.
- When your vehicle is towed or is towing another vehicle.
- When your vehicle is on a chassis dynamometer or free rollers.
- When tire inflation pressures are not adequate.
- When the temporary spare tire is being used.
- When the radar sensor and/or its surrounding area are damaged or deformed.

⚠ CAUTION

- To maintain proper performance of the ACC:
 - Always clean the surface of the radar sensor.
 - Avoid impacting the radar sensor or its surrounding area.
 - Do not put a sticker on the radar sensor or its surrounding area.
 - Do not paint the radar sensor.
 - Do not install a grill guard.
 - Do not modify the radar sensor or its surrounding area.
 - Always use tires of the same size, same type, and same brand, and which have no significant wear differences.
 - Do not modify the vehicle's suspension.

To increase the set speed

N0058150069

There are two ways to increase the set speed.

By using the “RES +” switch:

The set speed will increase by 1 mph (1.6 km/h) every time you push up the “RES +” switch while the ACC is activated. If you hold the switch pushed up, the set speed increases in 5 mph (8 km/h) increments.

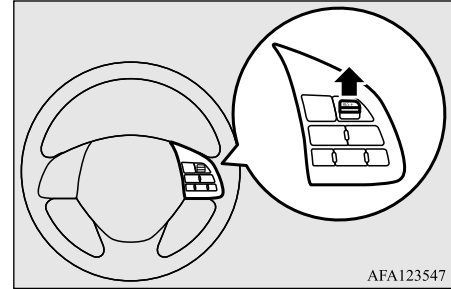

📖 NOTE

- There is some time lag until the vehicle begins accelerating to the new set speed after the set speed has been changed.
- The set speed can be changed even while your vehicle is following a vehicle in front using the ACC. In this case, however, although the set speed itself is increased, your vehicle will not accelerate.
- While the ACC system is in the stationary vehicle hold state, the vehicle speed cannot be set.

By using the accelerator pedal:

When the accelerator pedal is depressed while driving with the ACC control working, you can accelerate the vehicle beyond the presently set speed.

When the vehicle speed reaches your desired speed, push down and release the “SET -” switch and release the accelerator pedal; the new speed is then set in the system.

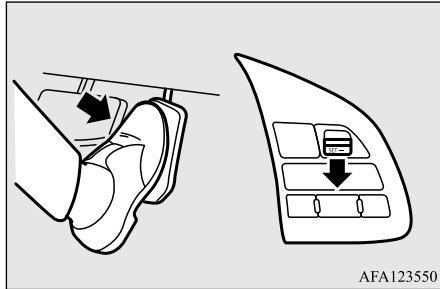

WARNING

- The ACC braking control and approach alarm functions will not work while the accelerator pedal is depressed.

NOTE

- The set speed indicator in the multi-information display will show “---” while the accelerator pedal is depressed.
- If the “SET -” button is not pushed down while depressing the accelerator pedal, your vehicle speed will return to the set speed, after the accelerator pedal is released. When the accelerator pedal is released, the ACC braking control and approach alarm functions may not immediately work.

To decrease the set speed

N00581600057

There are two ways to decrease the set speed.

By using the “SET -” switch:

The set speed will decrease by 1 mph (1.6 km/h) every time you push down the “SET -” switch while the ACC is activated. If you hold the switch pushed down, the set speed decreases in 5 mph (8 km/h) increments.

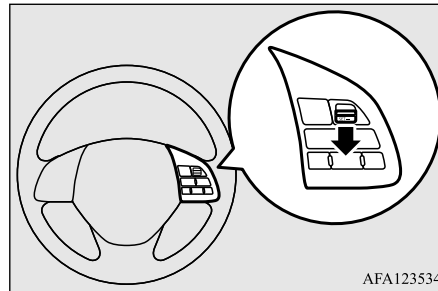

NOTE

- There is some time lag until the vehicle begins decelerating after the set speed has been changed.

NOTE

- The set speed can be changed even while your vehicle is following a vehicle in front using the ACC. In this case, however, although the set speed itself is decreased, your vehicle will not decelerate.
- While the ACC system is in the stationary vehicle hold state, the vehicle speed cannot be set.

5

By using the brake pedal:

By depressing the brake pedal while the ACC is activated, the ACC control is canceled and your vehicle speed will decrease. At the point where the vehicle speed reaches your desired speed, push down and release the “SET -” switch; the new speed is then set in the system.

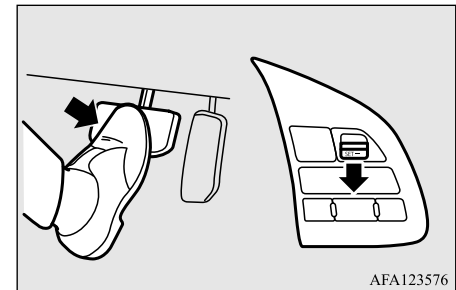

Adaptive Cruise Control System (ACC) (if so equipped)

NOTE

- The ACC control will not resume after releasing the brake pedal.

To temporarily accelerate the vehicle

5

N00582800030

Simply depress the accelerator pedal to temporarily accelerate the vehicle. Releasing the pedal to restart the ACC control.

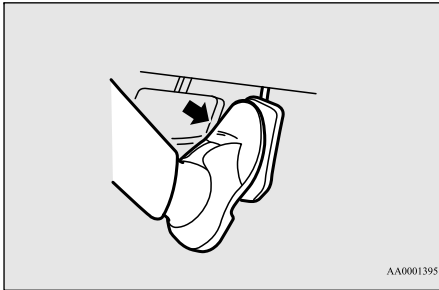

WARNING

- The ACC braking control and approach alarm functions will not work while the accelerator pedal is depressed.

NOTE

- The set speed indication on the display turns to “---” when the accelerator pedal is depressed. This indication remains as long as the pedal is in a depressed position.
- In certain conditions, the braking control and alarming functions of ACC may not work for a short while after releasing the accelerator pedal.

To cancel ACC control

N00581700090

There are two ways to cancel the ACC control.

- By pressing the “CANCEL” switch.
- By depressing the brake pedal.

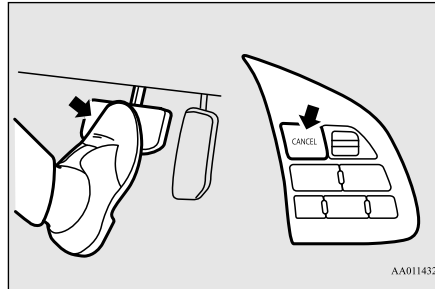

NOTE

- You can also cancel the ACC control by pressing the ACC ON/OFF switch. If this switch is pressed while the ACC is ON, the ACC will be turned off.
- If you press the “CANCEL” switch or ACC ON/OFF switch to cancel the stationary vehicle hold state, the vehicle will start creeping.

When the ACC is canceled, the “SET” indicator goes off and the following distance indicator turns to the standby display. The front vehicle indicator also turns to the standby display when a front vehicle is detected.



In any of the situations listed below, the ACC control is automatically canceled, a buzzer sounds and a message is shown in information screen of the multi-information display.

If the ACC system is in the stationary vehicle hold state, it will also be automatically canceled and the Electric parking brake will operate.



- When the ASC is turned off.
- While ABS, ASC or TCL is activated.
- When the selector lever is in a position other than “D” (DRIVE).
- When the parking brake is applied.
- When the driver’s seat belt is unfastened.
- When the driver’s door is opened.
- When the ACC no longer detects any vehicle in front while it is in the stationary vehicle hold state.
- When the vehicle is in the stationary vehicle hold state for 10 minutes or more.

- When the system detects the vehicle moving down a slope while the vehicle is in the stationary vehicle hold state.

If the ACC system judges that the stationary vehicle hold state can no longer be maintained on a steep slope after your vehicle stops when the vehicle in front stops, the stationary vehicle hold state is cancelled and a warning appears on the information screen of the multi-information display.

Depress the brake pedal.

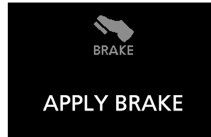

If the detection performance of the ACC system has degraded, such as in the following situations, or if the ACC system judges that it can temporarily not operate, the ACC system operation will be cancelled automatically, and then a buzzer will sound and a message will appear to inform the driver.



This can occur when

- The brake system is overheating due to continuous brake control on long downhill slope.



This can occur when

- In adverse weather conditions, such as rain, snow or sand storms, etc.
- Foreign objects, such as dirt, snow or ice, adhere to the surface of the sensor.
- A front vehicle or an oncoming vehicle is splashing water, snow or dirt.
- Driving on a nonbusy road with a few vehicles and obstacles in front.

If the display keeps showing the message, there is a possibility that the ACC has a malfunction. Contact your authorized Mitsubishi Motors dealer.

When the ACC system detects an abnormality in the system, the ACC system will be turned off, a buzzer will sound and a message will be displayed in the multi-information display.

If the message remains after the operation mode is put in OFF, and then turned back to

Adaptive Cruise Control System (ACC) (if so equipped)

ON, contact your authorized Mitsubishi Motors dealer.



5

To resume the control

N00581800075

After the ACC control has been canceled with the ACC turned on, the ACC control can be resumed by pushing up and releasing the “RES +” switch.

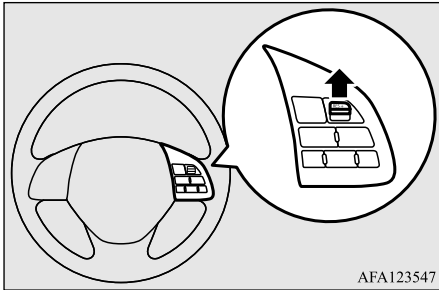

AFA123547

While the ACC system is in the stationary vehicle hold state, if it is possible to resume following the vehicle in front because it has started moving, “ACC READY TO RESUME” will appear on the meter. To start

moving again, push up the “RES +” switch or depress the accelerator pedal.



NOTE

- When any of the following conditions are present, the ACC control cannot be resumed.
 - When your vehicle speed is more than 110 mph (180 km/h).
 - When your vehicle is driven at speeds between approximately 0 to 20 mph (0 to 30 km/h) and the ACC is not detecting a vehicle in front.
 - When ASC is in the OFF position.
 - While ABS, ASC or TCL is activated.
 - When the selector lever is in positions other than “D” (DRIVE).
 - While the brake pedal is depressed.
 - While the parking brake is applied.
 - When the ACC system has judged that the performance for detecting a front vehicle is degraded.
- When an abnormality in the ACC system has been detected.
- While the brake pedal is depressed, the vehicle will not start moving again even if the driver operates the switches.

To change the following distance

N00581900050

Every time you press the ACC following distance setting switch, the set following distance changes in order. Even after turning off the ACC system or putting the operation mode in OFF, the system retains your last selected following distance setting in memory.

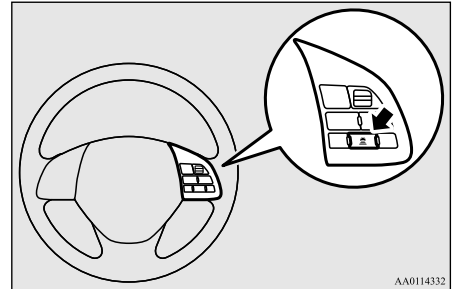

AA0114332

NOTE

- Actual distance will vary depending on your vehicle speed and the front vehicle speed. The distance will become longer when the vehicle speeds are higher.

The following distance indicator shows the level of the following distance:

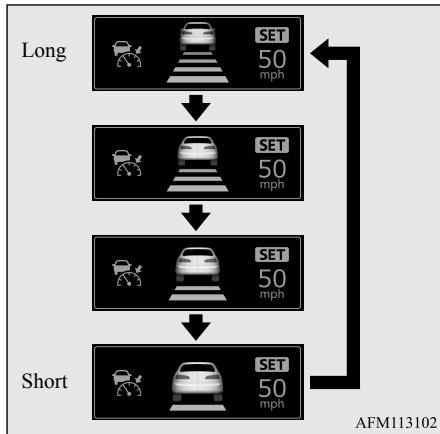

For operation of the cruise control, refer to “Cruise control” on page 5-87.

NOTE

- The conventional cruise control does not sound or display the approach alarm, will not adjust your vehicle speed, and does not control the distance between your vehicle and a vehicle in front.

To activate conventional cruise control

N00582000061

Press and hold the ACC ON/OFF switch while the operation mode is in the ON position. A buzzer will sound and the multi-information display will show the following indicator.



The conventional cruise control is turned off when the operation mode is put in OFF.

General information

N00582100105

FCC ID: OAYARS4A (for vehicles sold in the U.S.A.)
IC: 4135A-ARS4A (for vehicles sold in the Canada)

This device complies with Part 15 of the FCC Rules and with Industry Canada licence-exempt RSS standard(s). Operation is subject to the following two conditions:

5

- (1) This device may not cause harmful interference, and
- (2) This device must accept any interference received, including interference that may cause undesired operation.

Le présent appareil est conforme aux CNR d'Industrie Canada applicables aux appareils radio exempts de licence. L'exploitation est autorisée aux deux conditions suivantes:

- (1) l'appareil ne doit pas produire de brouillage, et
- (2) l'utilisateur de l'appareil doit accepter tout brouillage radioélectrique subi, même si le brouillage est susceptible d'en compromettre le fonctionnement.

Radiofrequency radiation exposure Information:

This equipment complies with FCC and IC radiation exposure limits set forth for an uncontrolled environment. This equipment should be installed and operated with minimum distance of 30 cm between the radiator and your body.

This transmitter must not be co-located or operating in conjunction with any other antenna or transmitter.

Cet équipement est conforme aux limites d'exposition aux rayonnements IC établies pour un environnement non contrôlé. Cet équipement doit être installé et utilisé avec un minimum de 30 cm de distance entre la source de rayonnement et votre corps.

FCC Notice

Changes or modifications not expressly approved by the party responsible for compliance could void the user's authority to operate the equipment.

Forward Collision Mitigation system (FCM)

N00577300154

The Forward Collision Mitigation system (FCM) is designed to help reduce the risk of a collision with a vehicle or a pedestrian straight ahead of your vehicle. The FCM uses a sensor (A) to determine the distance and relative speed to a vehicle and a pedestrian in front. The FCM is not designed as an automatic driving system or as a collision avoidance system.

When your vehicle is approaching a vehicle or a pedestrian straight-ahead in your path and the FCM judges that there is the risk of a collision, the system will give audible and visual warnings.

When the FCM judges that a collision with the vehicle or the pedestrian straight-ahead is imminent, the system will automatically apply moderate braking to warn you to apply the brakes immediately.

When the FCM judges that a collision with the vehicle or the pedestrian straight-ahead is highly unavoidable, the system will apply emergency braking to reduce the severity of the collision and, if possible, to avoid the collision.

Stop lights are illuminated during automatic braking.

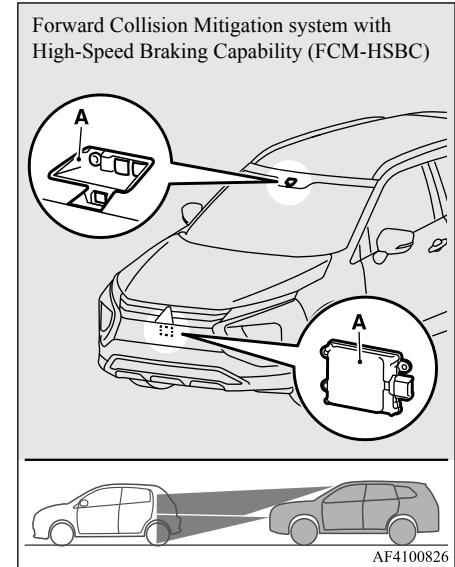
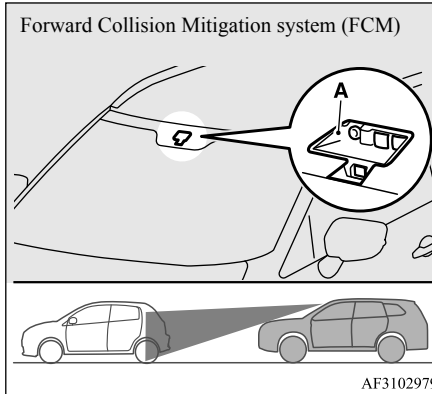

5

WARNING

- Before using the FCM, read this entire section to fully understand the limitations of this system. Failure to follow instructions could result in an accident.

⚠ WARNING

- The FCM is designed to help avoid certain frontal collisions or reduce the crash speed in such collisions. It is not a substitute for your safe and careful driving. Under certain circumstances, the system may not operate or may not detect correctly a vehicle or a pedestrian in front. When your vehicle is approaching a vehicle or a pedestrian too closely, take all necessary actions to avoid a collision, such as braking and steering, regardless of whether the FCM is activated or not. Never rely on the FCM to prevent a collision.
- Never attempt to test the operation of the FCM. Doing so could cause an accident, resulting in serious injury or death.

5

Forward collision warning function

N00577400083

If the system judges that there is a risk of your vehicle colliding with a vehicle or the pedestrian in front, this function warns you of the potential hazard with visual and audible alarms.

When this function is triggered, a buzzer sounds and, at the same time, a “BRAKE” message appears on the information screen of the multi-information display.

The FCM will also prepare to provide quick brake response and greater brake force when you apply the brakes.

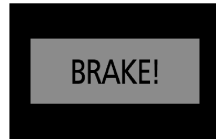

The forward collision warning function operates at the following vehicle speeds:

Forward Collision Mitigation system (FCM)

- Against a vehicle: Approximately 10 to 87 mph (15 to 140 km/h).
- Against a pedestrian: Approximately 5 to 40 mph (7 to 65 km/h).

Forward Collision Mitigation system with High-Speed Braking Capability (FCM-HSBC)

- Against a vehicle: Approximately 10 to 112 mph (15 to 180 km/h).
- Against a pedestrian: Approximately 5 to 40 mph (7 to 65 km/h).

FCM braking function

N00577700145

When the FCM judges that a collision with the vehicle or the pedestrian straight-ahead is imminent, the FCM will automatically apply moderate braking to warn the driver to apply the brakes immediately.

If the FCM judges that the collision is highly unavoidable, it will automatically apply emergency braking to reduce the severity of the collision and, if possible, to avoid the collision.

While the FCM applies emergency braking, a buzzer sounds and “BRAKE!” message is displayed in the information screen of the multi-information display.

Once the FCM braking has activated, the following message will appear on the information screen of the multi-information display.



The FCM braking function operates at the following vehicle speeds:

Forward Collision Mitigation system (FCM)

- Against a vehicle: Approximately 3 to 50 mph (5 to 80 km/h).

- Against a pedestrian: Approximately 3 to 40 mph (5 to 65 km/h).

Forward Collision Mitigation system with High-Speed Braking Capability (FCM-HSBC)

- Against a vehicle: Approximately 3 to 112 mph (5 to 180 km/h).
- Against a pedestrian: Approximately 3 to 40 mph (5 to 65 km/h).

⚠ WARNING

- If the ASC is turned off, the FCM braking function will not operate. Refer to “Active stability control” on page 5-85.
- If the brake pedal is not depressed within 2 seconds after your vehicle has been stopped by the FCM, a warning buzzer will sound and the brakes activated by the FCM will automatically be released. Apply the brakes as necessary to keep your vehicle stationary.
- The FCM will not activate and will not provide either warning or braking in certain situations. Some of these include:
 - When the selector lever is in the “P” (PARK) or “R” (REVERSE) position.
 - When an object other than a vehicle or a pedestrian is in front.
 - When the FCM has detected a problem in the system.

⚠ WARNING

- When a vehicle or a pedestrian suddenly cuts in front of your vehicle.
- The FCM may or may not detect a motorcycle, bicycle or wall depending on the situation. The FCM is not designed to detect these objects.
- The forward collision warning function and/or the FCM braking function may not activate in certain situations. Some of these include:
 - When a vehicle suddenly appears just in front of your vehicle.
 - When a vehicle cuts into your path at a close distance.
 - When a vehicle ahead is not completely in your path.
 - When your vehicle changed lanes, and your vehicle approached immediately behind the vehicle ahead.
 - When a vehicle ahead is towing a trailer.
 - When a vehicle ahead is a truck loaded with freight that protrudes rearward from the cargo bed.
 - When the height of a vehicle ahead is extremely low or its road clearance is extremely high.
 - When a vehicle ahead is extremely dirty.
 - When a vehicle ahead is covered with snow.
 - When a vehicle ahead has a large glass surface.

⚠ WARNING

- When a vehicle ahead does not have reflectors (light reflector) or the position of the reflector is low.
- When a vehicle ahead is a car carrier or a similar shaped vehicle.
- When accelerating and decelerating quickly.
- When driving on a slippery road covered by rain water, snow, ice, etc.
- When driving on a road with alternating up and down steep slopes.
- When driving on a curve.
- When driving on a bumpy or rough road.
- When driving in dark areas, such as in a tunnel or at night.
- When the system recognizes driver's steering, accelerating, braking or gear shifting actions as evasive actions to avoid collision.
- When the rear of your vehicle is weighed down with the weight of passengers and luggage.
- Up to several seconds after starting driving.
- In adverse weather conditions, such as rain, snow, fog or sand-storm.
- When the windshield of the sensor portion is covered with dirt, water droplets, snow and ice, etc.
- When a vehicle ahead or an oncoming vehicle is splashing water, snow or dirt.
- When using a windshield washer.

5

⚠ WARNING

- If windshield wipers are not Mitsubishi Motors Genuine parts or equivalent.
- When the sensor becomes extremely hot or cold.
- If the battery becomes weak or runs down.
- When the sensor is affected by strong light, such as direct sunlight or the headlights of an oncoming vehicle.
- The FCM may not detect a pedestrian in certain situations. Some of these include:
 - If the pedestrian is shorter than approximately 3.2 feet (1 m) or taller than approximately 6.5 feet (2 m).
 - If the pedestrian is wearing loose-fitting clothes.
 - If part of a pedestrian's body is hidden, such as when holding an umbrella, large bag, etc.
 - If a pedestrian bends forward, sits or lies on the road.
 - When a pedestrian is pushing/pulling something, such as a stroller, bicycle or wheelchair.
 - When pedestrians gather in a group.
 - When a pedestrian clothing appears to be nearly the same color or brightness as its surroundings.
 - When a pedestrian is very close to an object, such as a vehicle.
 - When a pedestrian is in a dark area, such as at night or in a tunnel.

⚠ WARNING

- When a pedestrian is walking fast or running.
- When a pedestrian suddenly rushes in front of the vehicle.
- When the position of a pedestrian is close to the edge of the vehicle.
- When the system recognizes driver's steering or accelerating actions as evasive actions to avoid a collision, FCM control and alarm functions may be canceled.
- In certain situations, though there is little or no risk of a collision, the FCM may activate. Examples include:
 - When overtaking a vehicle.
 - When driving on a curve.
 - When there is a road side object (B) that reflects the radar sensor signal, such as a road sign.

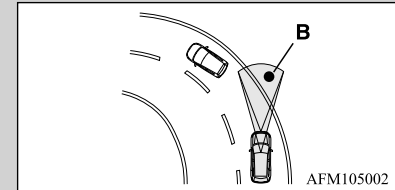

- When approaching a gate, a railroad crossing, an underpass, a narrow bridge, manhole lid or a speed bump.
- When driving under an overpass or pedestrian bridge.
- When driving in a narrow tunnel.
- When driving in a parking structure.

⚠ WARNING

- When approaching a slope where the incline changes significantly.
- When trying to stop your vehicle very close to a vehicle or an object in front.
- When passing a vehicle, a pedestrian or an object closely.

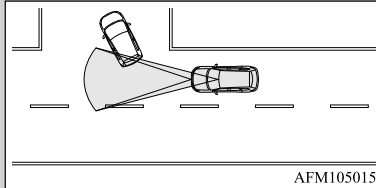

AFM105015

- When a vehicle in the next lane becomes positioned directly in front of your vehicle due to winding road conditions.

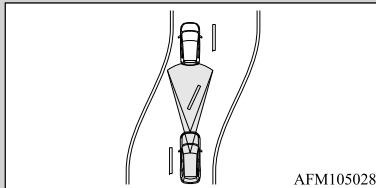

AFM105028

- When passing through an area where objects may contact the vehicle, such as thick grass, tree branches, or a banner.
- When there are patterns on the road that may be mistaken for a vehicle or a pedestrian.
- When a vehicle cuts into your path in the detecting range of the sensor.

⚠ WARNING

- When an oncoming vehicle is positioned straight ahead of your vehicle on a curved road.
- When the FCM detects a long object carried on your vehicle, such as skis or a roof carrier.
- When driving through fog, steam, smoke or dust.
- The FCM should be tuned off if any of the following situations occur:
 - When using an automatic car wash.
 - When the tires are not properly inflated.
 - When the emergency spare tire is used.
 - When your vehicle is towed or your vehicle tows another vehicle.
 - When your vehicle is carried on a truck.
 - When your vehicle is on a chassis dynamometer or free rollers.
 - If the windshield on or surrounding the sensor is cracked or scratched.

📖 NOTE

- When depressing the brake pedal while automatic braking is applied, the brake pedal will feel firm. This is normal. Depress the brake pedal harder to apply greater braking force.
- During the automatic braking, operating sounds may be heard. This is normal.

FCM ON/OFF switch

N00577800074

This switch is used to turn on or off the FCM, and also to select the distance which will trigger the forward collision warning function.

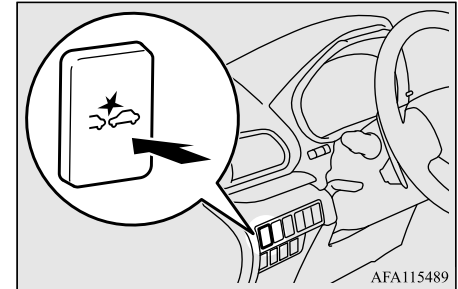



AFA115489

To turn on/off the FCM

Every time the ignition switch is turned to the "ON" position or the operation mode is put in ON, the FCM will automatically be turned on.

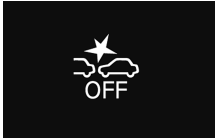
To turn off the FCM, press and hold the FCM ON/OFF switch. The following message will appear on the information screen of the multi-information display and the  indicator will come on in the instrument cluster.



To turn on the FCM again, press the FCM ON/OFF switch. The  indicator on the instrument cluster will go off, and a current distance mode for the forward collision warning will be shown in the information screen of the multi-information display.



To change forward collision warning distance

The distance to the vehicle ahead which triggers the forward collision warnings can be selected from three levels (FAR, MIDDLE or NEAR).

To change the distance mode, push the FCM ON/OFF switch. Every time the switch is pushed, the distance mode will be switched. The selected distance mode is shown on the information screen of the multi-information display.

Distance mode: FAR



Distance mode: MIDDLE

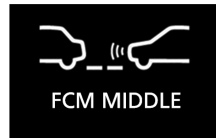

Distance mode: NEAR



NOTE

- Actual distance which triggers the forward collision warnings will vary depending on your vehicle speed and the front vehicle speed. The distance will become longer when the vehicle speeds are higher.
- The distance which will trigger the FCM braking function cannot be adjusted.

System problem warning

N00594800024

If there is a malfunction in the system, a warning will appear on the information screen of the multi-information display depending on the situation.

When the camera and radar cannot detect accurately

N00594900070

When the FCM system determines that it cannot detect objects properly, the FCM will become inoperative.

This can occur when:

- Foreign objects, such as dirt, snow, ice, mist or dew condensation adhere to the windshield of the sensor portion or the surface of the sensor.
- In adverse weather conditions, such as rain, snow, sand storms, etc.
- A front vehicle or an oncoming vehicle is splashing water, snow or dirt.
- Driving on a nonbusy road with a few vehicles and obstacles in front. {Forward Collision Mitigation system with High-Speed Braking Capability (FCM-HSBC) only}

The following message will appear on the information screen of the multi-information display and the  indicator will come on in the instrument cluster.



(FCM-HSBC only)

or



When the sensor performance returns, the FCM functions will resume operation.

If the message continues showing, there is a possibility that the sensor has a malfunction. Contact an authorized Mitsubishi Motors dealer for inspection of the sensor.

 NOTE
<ul style="list-style-type: none"> ● The “DRIVER ASSISTANCE CAMERA BLOCKED” message may temporarily appear on the information screen when the sensor cannot detect a vehicle, a pedestrian or an object within range. This is not a malfunction. When a vehicle or an object comes within range, the FCM function will resume and the message will go off.

When the system cannot operate temporarily

N00595100053

If the system becomes temporarily unavailable for some reason, the following message will appear on the information screen of the multi-information display, the  indicator will come on in the instrument cluster, and the FCM will automatically be turned off.

5



If the message continues showing, there is a possibility that the FCM has a malfunction. Contact an authorized Mitsubishi Motors dealer for inspection of the system.

Sensor is too hot or cold

N00595200067

If the system becomes temporarily unavailable due to the high or low temperature of the sensor, the following message will appear on the information screen of the multi-information display, the  indicator will come on in the instrument cluster, and the FCM will automatically be turned off.

After the temperature of the sensor has been in range, the system will automatically return to operation.

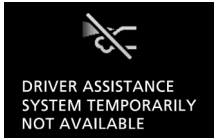

If the message continues showing, there is a possibility that the FCM has a malfunction. Contact an authorized Mitsubishi Motors dealer for inspection of the sensor.

FCM deactivation due to fault

N00595300097

If the FCM detects a malfunction in the system, either of the following messages will appear on the information screen of the multi-information display, the  indicator will come on in the instrument cluster, and the FCM will automatically be turned off.

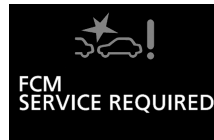

If the message remains even after the ignition switch is turned to the “OFF” position and then turned back to “ON” position or the operation mode is put in OFF, and then turned back to “ON”, please contact your authorized Mitsubishi Motors dealer.

If the display keeps showing the message, there is a possibility that the FCM has a malfunction.

Contact an authorized Mitsubishi Motors dealer.

NOTE

- If the sensor or its surrounding area becomes extremely hot (after prolonged exposure to direct sunlight, for example), the “FCM SERVICE REQUIRED” message may appear. After the temperature of the sensor or its surrounding area has been in range, if the message remains even after restarting the engine, please contact an authorized Mitsubishi Motors dealer.

Handling of the sensor

N00593400153

The sensor (A) is located inside the windshield and front bumper {Forward Collision Mitigation system with High-Speed Braking Capability (FCM-HSBC) only} as shown in the illustration.

The sensor is shared in the following systems:

- Forward Collision Mitigation system (FCM)
 - Lane Departure Warning (LDW)*
 - Automatic High Beam (AHB)*
 - Adaptive Cruise Control System (ACC)*
- *: if so equipped

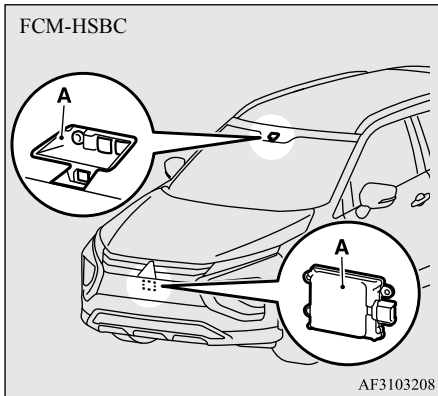
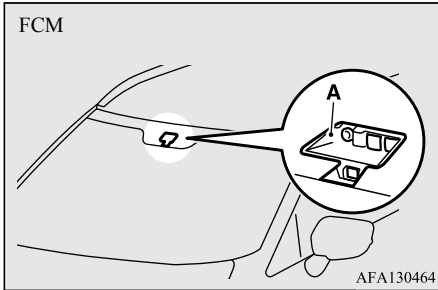

CAUTION

- To maintain proper performance of the FCM, LDW, AHB and ACC;

CAUTION

- Always keep clean the windshield and front bumper.
 - If the inside of the windshield where the sensor is installed becomes dirty or fogged, contact an authorized Mitsubishi Motors dealer.
 - Do not apply an impact or load on the sensor or its surrounding area.
 - Do not put anything including a sticker or film to the outer side of windshield in front of or surrounding the area of the sensor.
- Also, do not put anything including a sticker or film to inner side of the windshield under the sensor.

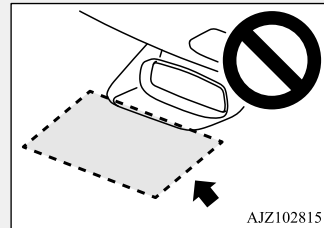

- Do not attempt to detach or disassemble the sensor and sensor mounting screw.
- The sensor front cover should not be modified or painted.
- Do not cover the sensor mounted area with a license plate or anything such as a grill guard, etc. (FCM-HSBC only)
- If the windshield is misted, remove the mist from the windshield by using the defogger switch.

CAUTION

- Maintain the wiper blades in good condition. Refer to “Wiper blades” on page 9-39. When replacing the wiper blades, use only Mitsubishi Motors Genuine parts or equivalent.
- Do not dirty or damage the sensor.
- Do not spray glass cleaner on the sensor. Also, do not spill liquid, such as a beverage, on the sensor.
- Do not install an electronic device, such as an antenna, or a device that emits strong electric waves, near the sensor.
- Always use tires of the same size, same type and same brand, and which have no significant wear differences.
- Do not modify the vehicle’s suspensions.
- If the windshield in front of the sensor or in the surrounding area of the sensor is cracked or scratched, the sensor may not detect an object properly. This could cause a serious accident. Turn off the FCM and have your vehicle inspected as soon as possible at an authorized Mitsubishi Motors dealer.
- If you need to replace the windshield, contact an authorized Mitsubishi Motors dealer.
- The sensor emits infrared rays when the operation mode is in ON. Do not look into the sensor by using optical goods such as a magnifying glass. The infrared ray might injure your eyes.

Blind Spot Warning (BSW) (with Lane Change Assist) (if so equipped)

Laser radar specifications

Laser classification

Max average power	45 mW
Pulse duration	33 ns
Wavelength	905 nm
Divergent angle (horizon x vertical)	28° x 12°

Laser classification label

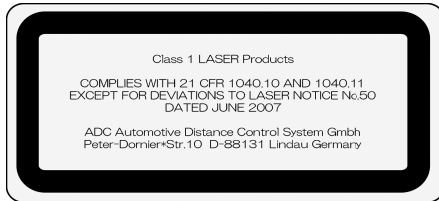

Blind Spot Warning (BSW) (with Lane Change Assist) (if so equipped)

N00592200082

The Blind Spot Warning (BSW) is a driving aid system that alerts the driver when another vehicle which may not be visible through the

outside rearview mirror is traveling in the next lane behind your vehicle.

When a vehicle in the next lane is traveling at same speed or faster in the detection areas, the BSW light in the corresponding outside rearview mirror will illuminate. If the turn signal lever is operated to the side where the BSW light is illuminated, the BSW light will blink and the system will beep three times to alert the driver.

Depending on the relative speed between your vehicle and a vehicle in the next lane, the BSW will detect up to approximately 230 feet (70 m) from your vehicle (Lane Change Assist).

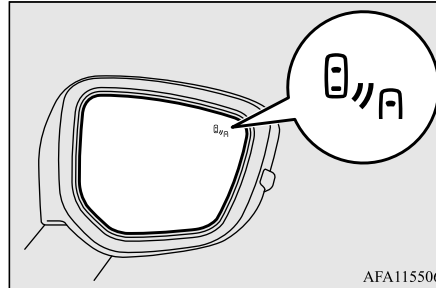

WARNING

- Before using the BSW, read this entire section to fully understand the limitations of this system. Failure to follow instructions could result in an accident.

WARNING

- Never rely solely on the BSW system when changing lanes. BSW is an aid only. It is not a substitute for your safe and careful driving. Always check visually behind and all around your vehicle for other vehicles. The performance of the BSW may vary depending on driving, traffic and/or road conditions.

Detection areas

N00592300139

The BSW uses two sensors (A) located inside the rear bumper.

The detection areas are shown as illustrated.

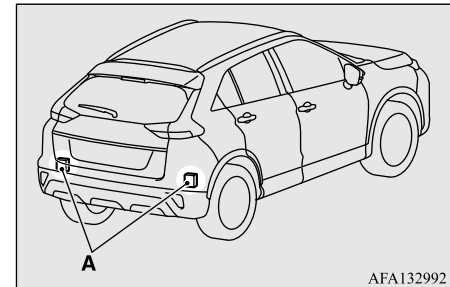

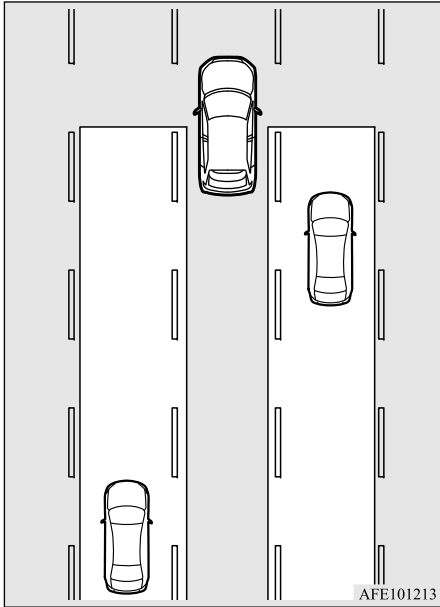

⚠ WARNING

- In certain situations, the BSW may not detect a vehicle in the detection areas or the detection may be delayed. Some of these include;
 - When a small motorcycle or a bicycle is behind your vehicle.
 - When a vehicle is traveling alongside of your vehicle at nearly the same speed for prolonged periods of time.

⚠ WARNING

- When the heights of the next lane and your lane are different.
- Immediately after the BSW has been turned on.
- Immediately after the operation mode is put in ON.
- Under adverse weather conditions, such as rain, snow, strong winds, snow or sand storm.
- When your vehicle becomes too close to another vehicle.
- While multiple vehicle are overtaking your vehicle.
- When driving near a pot hole and tram-line.
- When a surrounding vehicle or an oncoming vehicle is splashing water, snow or dirt.
- When driving on a curve including the beginning and the end of the curve.
- When driving on a road with alternating up and down steep slopes.
- When driving on a bumpy or rough road.
- When the rear of your vehicle is weighed down or your vehicle is leaning to the right or left due to the weight of passengers and luggage or the improper adjustment of tire pressure.
- When the bumper surface around the radar sensor is covered with dirt, snow and ice, etc.

⚠ WARNING

- When a bicycle carrier or accessory is installed to the rear of the vehicle.
- When the sensor is extremely hot or cold (while the vehicle is parked for a long period of time under a blazing sun or in cold weather).

⚠ CAUTION

- To maintain proper performance of the BSW, follow the instructions below.
 - Always keep the bumper surface around the sensor clean.
 - Avoid impacting the sensor or its surrounding area.
 - Do not put a sticker on the sensor or its surrounding bumper surface.
 - Do not paint the sensor or its surrounding bumper surface.
 - Do not modify the sensor or its surrounding area.
- If the bumper has experienced an impact, the sensor may have been damaged and the BSW may not function properly. Have the vehicle inspected at an authorized Mitsubishi Motors dealer.

To operate

N00593500167

When the operation mode is put in ON and “ON” is selected in the “BSW” setting







Blind Spot Warning (BSW) (with Lane Change Assist) (if so equipped)

screen, the BSW indicator light in the instrument cluster comes on and the BSW enters the standby state.

When “OFF” is selected in the “BSW” setting screen, the BSW indicator light in the instrument cluster goes off and the BSW turns off.

To turn the BSW ON/OFF, follow the procedure below.

5

1. Switch to the function setting screen.
Refer to “Multi-information display switches” on page 5-145.
Refer to “Changing the function settings” on page 5-155.
2. Press the  switch or  switch several times to switch to the “BSW” screen.
Then, press the  switch to the setting selection screen.
3. Press the  switch or  switch to select “ON” or “OFF”, and then press the  switch to confirm the setting.

Indicator light

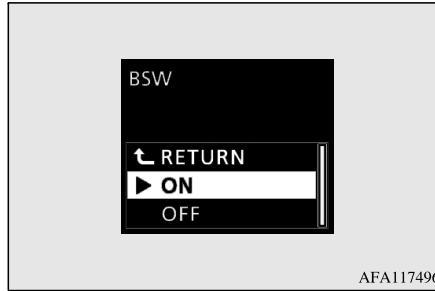

If you turn the BSW ON/OFF, the Rear Cross Traffic Alert (RCTA) also turns ON/OFF at the same time.

NOTE

- When the operation mode is set to OFF, the selected condition (BSW ON/OFF) just before setting to OFF is retained.
- The BSW operates when all of the following conditions are met.
 - The operation mode is put in ON.
 - The selector lever is in positions other than “P” (PARK) and “R” (REVERSE).
 - The speed of your vehicle is approximately 6 mph (10 km/h) or higher.

When the sensor detects an approaching vehicle

When the BSW indicator light in the instrument cluster is on, if a vehicle is approaching your vehicle in the detection area, the BSW light in the outside rearview mirror illuminates.

If the turn signal lever is operated to the side where the BSW light is illuminated, the BSW light will blink and the system will beep three times to alert the driver.

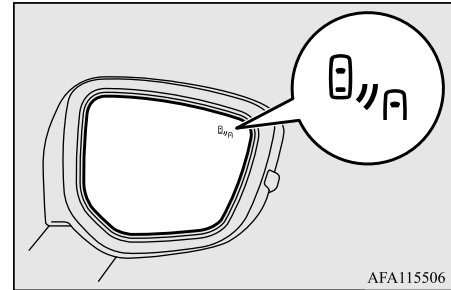

NOTE

- The BSW light in the outside rearview mirror may come on or blink in the following conditions.
 - When driving very near the guardrail or the concrete wall.

NOTE

- When driving near the entrance and outlet of the tunnel or very near the wall or near the evacuation area inside the tunnel.
- When turning at an intersection in a town area.
- Under adverse weather conditions (rain, snow, sand storm etc.).
- When driving while your vehicle is kicking up water, snow, sand, etc., on the road.
- When driving near a curb, pot hole and tramline.
- Set the BSW to OFF when towing.
- The BSW light in the outside rearview mirror may not be visible due to strong direct sunlight or the glare from the headlights of vehicles behind you during night driving.

System problem warning

N00592400042

If a problem occurs with the system, a visual warning specific to the type of the problem is given together with an audible alarm. The warnings are combined with the Rear Cross Traffic Alert (RCTA) system.

When there is a malfunction in the system

N00592700061



When the warning display appears, the BSW does not operate normally because there is a malfunction in the system. Have the vehicle inspected at an authorized Mitsubishi Motors dealer as soon as possible.

NOTE

- When the warning display appears, the BSW will be deactivated.

When the sensor is temporarily not available

N00592800046



When the warning display appears, the sensor is temporarily not available for some reason such as the environmental condition or increase of the sensor temperature. When the warning display does not disappear after waiting for a while, contact an authorized Mitsubishi Motors dealer.

When there is a foreign object on the sensor

N00592900119



5

When the warning display appears, the radar sensor cannot detect a vehicle traveling side by side or an approaching vehicle, because foreign objects, such as dirt, snow or ice, adhere to the bumper surface around the sensor.

Remove dirt, freezing or foreign material on the bumper surface around the sensor.

When the warning display does not disappear after having cleaned the bumper surface around the sensor, contact an authorized Mitsubishi Motors dealer.

General information

N00593900145

For vehicles sold in U.S.A.

Model: SRR3-A
FCC ID: OAYSRR3A

This device complies with Part 15 of the FCC Rules and with Industry Canada licence-exempt RSS standard(s). Operation is subject to the following two conditions:

- (1) This device may not cause harmful interference, and
- (2) This device must accept any interference received, including interference that may cause undesired operation.

Frequency bands: 24.05 – 24.25 Ghz

The field strength of SRR3-A is below 250 millivolts/m measured at 3 metres with an average detector.

Le présent appareil est conforme aux CNR d'Industrie Canada applicables aux appareils radio exempts de licence. L'exploitation est autorisée aux deux conditions suivantes:

- (1) l'appareil ne doit pas produire de brouillage, et
- (2) l'utilisateur de l'appareil doit accepter tout brouillage radioélectrique subi, même si le brouillage est susceptible d'en compromettre le fonctionnement.

Bande de fréquence: 24.05 – 24.25 GHz

L'intensité du champ de SRR3-A est en dessous de 250 mV / m à 3 mètres mesuré avec un détecteur à valeur moyenne

Radiofrequency radiation exposure Information:

This equipment complies with FCC and IC radiation exposure limits set forth for an uncontrolled environment. This equipment should be installed and operated with minimum distance of 30 cm between the radiator and your body.

This transmitter must not be co-located or operating in conjunction with any other antenna or transmitter.

Cet équipement est conforme aux limites d'exposition aux rayonnements IC établies pour un environnement non contrôlé. Cet équipement doit être installé et utilisé avec un minimum de 30 cm de distance entre la source de rayonnement et votre corps.

FCC Notice

Changes or modifications not expressly approved by the party responsible for compliance could void the user's authority to operate the equipment.

Rear Cross Traffic Alert (RCTA) (if so equipped)

For vehicles sold in Canada

Applicable law: RSS-210

This device contains licence-exempt transmitter(s)/receiver(s) that comply with Innovation, Science and Economic Development Canada's licence-exempt RSS(s). Operation is subject to the following two conditions:

5

1. This device may not cause interference.
2. This device must accept any interference, including interference that may cause undesired operation of the device.

Radiofrequency radiation exposure information:

This equipment complies with radiation exposure limits set forth for an uncontrolled environment. This equipment should be installed and operated with minimum distance of 20 cm between the radiator and your body.

Rear Cross Traffic Alert (RCTA) (if so equipped)

N00593000159

The Rear Cross Traffic Alert (RCTA) is an aid system for backing up. When the RCTA system detects vehicles approaching from the sides while your vehicle is reversing, the BSW lights in the outside rearview mirrors

on both sides will blink and a buzzer will sound to alert the driver. A warning message will also appear on the information screen of the multi-information display.

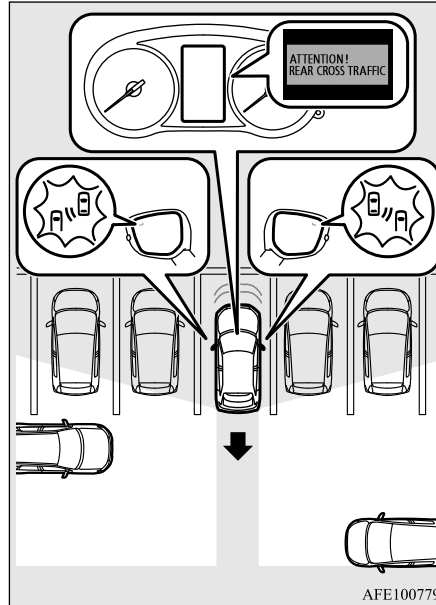

WARNING

- Before using the RCTA, read this entire section to fully understand the limitations of this system. Failure to follow instructions could result in an accident.

WARNING

- Never rely solely on the RCTA when backing up. The RCTA is an aid system. It is not a substitute for your safe and careful driving. Always check visually behind and all around your vehicle for other vehicles, persons, animals or obstructions. The performance of the RCTA may vary depending on driving, traffic and/or surrounding conditions.

NOTE

- The BSW lights in the outside rearview mirrors on both sides will blink, even when only one vehicle is approaching from one side.

Detection areas

The detection area is shown as illustrated.

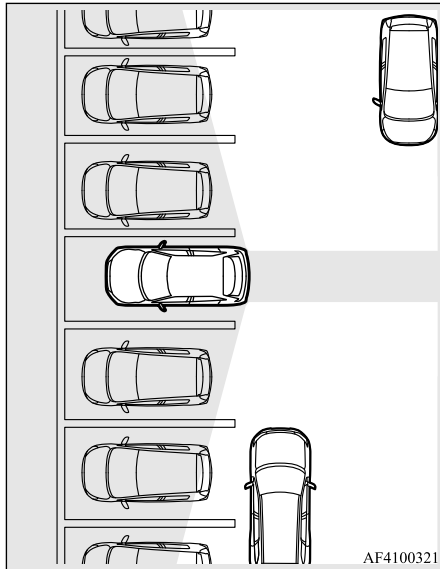

CAUTION

- In certain situations, the RCTA may not detect a vehicle in the detection areas. Some of these situations include;
 - When the reversing speed of your vehicle is approximately 11 mph (18 km/h) or higher.

CAUTION

- When the speed of an approaching vehicle is approximately 4 mph (7 km/h) or less.
- If the sensor detection area is blocked by a nearby object, such as wall or parked vehicle.
- When a vehicle is approaching from straight behind your vehicle.
- When your vehicle is exiting from an angled parking spot.

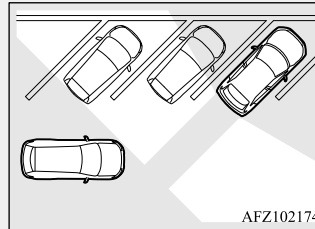

- Immediately after the RCTA has been turned on.
- Immediately after the operation mode is put in ON.
- When the bumper surface around the sensor is covered with dirt, snow and ice, etc.
- When the sensor becomes extremely hot or cold, such as after the vehicle has been parked for a prolonged time under the blazing sun or in cold weather.
- If the bumper has experienced an impact, the sensor may have been damaged and the RCTA may not function properly. Have the vehicle inspected at an authorized Mitsubishi Motors dealer.

To operate

1. Select "ON" in the "BSW" setting screen of the multi-information display. Refer to "To operate" on page 5-115.
2. When the selector lever is moved to the "R" (REVERSE) position, the RCTA will operate.

NOTE

- Set the RCTA to OFF when towing.
- The BSW light in the outside rearview mirror may not be visible due to strong direct sunlight or the glare from the headlights of vehicles behind you during night driving.

When a problem is detected in the system

If the system detects a problem, a warning is displayed on the information screen in the multi-information display. Refer to "System problem warning" on page 5-117.

General information

N00594000156

For vehicles sold in U.S.A.

Model: SRR3-A
FCC ID: OAYSRR3A

5

This device complies with Part 15 of the FCC Rules and with Industry Canada licence-exempt RSS standard(s). Operation is subject to the following two conditions:

- (1) This device may not cause harmful interference, and
- (2) This device must accept any interference received, including interference that may cause undesired operation.

Frequency bands: 24.05 – 24.25 Ghz

The field strength of SRR3-A is below 250 millivolts/m measured at 3 metres with an average detector.

Le présent appareil est conforme aux CNR d'Industrie Canada applicables aux appareils radio exempts de licence. L'exploitation est autorisée aux deux conditions suivantes:

- (1) l'appareil ne doit pas produire de brouillage, et
- (2) l'utilisateur de l'appareil doit accepter tout brouillage radioélectrique subi, même si le brouillage est susceptible d'en compromettre le fonctionnement.

Bande de fréquence: 24.05 – 24.25 GHz

L'intensité du champ de SRR3-A est en dessous de 250 mV / m à 3 mètres mesuré avec un détecteur à valeur moyenne

Radiofrequency radiation exposure Information:

This equipment complies with FCC and IC radiation exposure limits set forth for an uncontrolled environment. This equipment should be installed and operated with minimum distance of 30 cm between the radiator and your body.

This transmitter must not be co-located or operating in conjunction with any other antenna or transmitter.

Cet équipement est conforme aux limites d'exposition aux rayonnements IC établies pour un environnement non contrôlé. Cet équipement doit être installé et utilisé avec un minimum de 30 cm de distance entre la source de rayonnement et votre corps.

FCC Notice

Changes or modifications not expressly approved by the party responsible for compliance could void the user's authority to operate the equipment.

For vehicles sold in Canada

Applicable law: RSS-210

This device contains licence-exempt transmitter(s)/receiver(s) that comply with Innovation, Science and Economic Development Canada's licence-exempt RSS(s). Operation is subject to the following two conditions:

1. This device may not cause interference.
2. This device must accept any interference, including interference that may cause undesired operation of the device.

Radiofrequency radiation exposure information:

This equipment complies with radiation exposure limits set forth for an uncontrolled environment. This equipment should be installed and operated with minimum distance of 20 cm between the radiator and your body.

Lane Departure Warning (LDW) (if so equipped)

N00577900062

The Lane Departure Warning (LDW) is a driving aid system to help prevent unintentional lane departure. The LDW is designed to read lane markers by using a sensor (A) under certain conditions. The LDW will give you both visual and audible warnings when your vehicle is leaving or has left the lane.

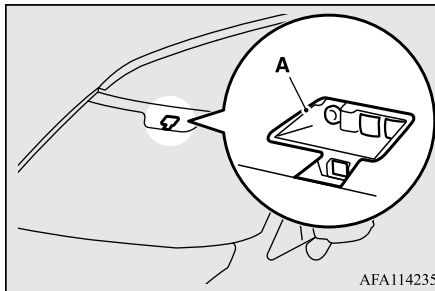

AFA114235

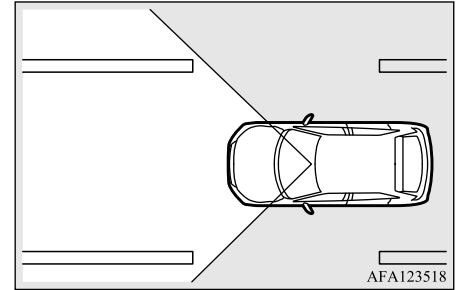

5

WARNING

- Never rely solely on the LDW. The LDW is not a collision avoidance system and is not a substitute for your safe and careful driving.
- Before using the LDW, read this entire section to understand the limitations of this system. Failure to follow instructions could result in an accident.

To turn on/off the LDW

N00578000086

NOTE

- The LDW is turned on when the vehicle is shipped from the factory.
- The currently selected LDW setting (on or off) is stored even when the ignition switch is turned to the "OFF" position or the operation mode is put in OFF.

Lane Departure Warning (LDW) (if so equipped)

To turn off the LDW, press the LDW switch. The LDW indicator in the instrument cluster will then go out.

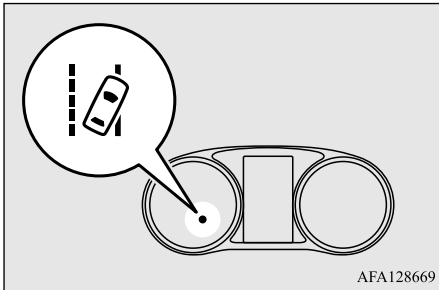
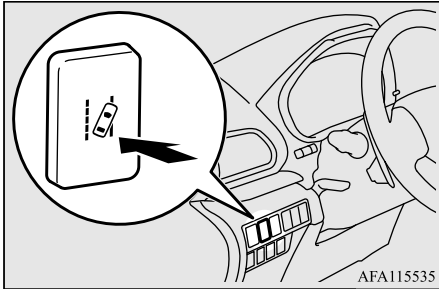

To turn the LDW back on, press the LDW switch again. The LDW indicator in the instrument cluster will then come on.

Operation of the LDW

N00581100094

The LDW, when turned ON, is capable of recognizing the lane in which your vehicle is travelling and issuing an audible warning when your vehicle begins to leave that travel lane. When operating, the LDW indicator in the instrument cluster will come on. However, the LDW will not operate in the following situations even if the LDW indicator comes on:

- The vehicle speed is less than approximately 38 mph (60 km/h).
- The turn signal lever is being operated or has been operated in the past 7 seconds.
- The hazard warning light is being operated or has been operated in the past 7 seconds.

Lane departure warning

N00581200082

While the LDW indicator in the instrument cluster is on, if your vehicle is leaving or has left the lane, a buzzer will sound intermittently, “LANE DEPARTURE” will appear on the information screen of the multi-information display.



NOTE

- The warnings will not continue for more than 3 seconds, even if your vehicle continues leaving the lane.
- If the lane markers are only on one side of the road, the LDW will operate only for the appropriate side where the lane marker is drawn.

WARNING

- The LDW will not function when no lane marker exists, such as at an intersection or near a toll booth.
- The LDW may not operate correctly in the following situations and the LDW may not give warnings or may give false warnings:

⚠ WARNING

- When lane markers are not clearly visible due to rain, snow, fog, dark area, etc.
- When the road surface is shiny.
- When old lane markers remain on the road surface.
- When the lane markers are double lines or the shape of the lane markers are complicated.
- When driving in an extremely narrow lane.
- When the distance between your vehicle and a vehicle in front is short.
- When driving into the sun light.
- When driving on curves.
- When driving on bumpy roads.
- When driving in construction zones.
- When passing through a place where the brightness suddenly changes, such as at the entrance to or exit of a tunnel.
- When the headlights of an oncoming vehicle are very bright.
- When the rear of your vehicle is weighed down with the weight of passengers and luggage.
- When the headlights of your vehicle are not clean or are not properly aimed.
- When the front windshield is not clean.
- When the front windshield wipers do not clean the windshield properly.

⚠ CAUTION

- To maintain proper function of the LDW:
 - Always keep the windshield and the headlights clean.
 - Do not put anything, such as a sticker, on the front windshield in front of the sensor.
 - Avoid applying a shock or load to the sensor.
 - Do not attempt to detach or disassemble the sensor.
 - Use only Mitsubishi Motors Genuine parts when replacing the windshield wipers.

📖 NOTE

- When driving conditions are not suitable to use the LDW, turn off the LDW.

System problem warning

N00578100087

If a problem occurs with the system, a visual warning specific to the type of the problem is given together with an audible alarm.

Sensor is too hot or cold

The alarm shown below is displayed if the system becomes temporarily unavailable due to the high or low temperature of the sensor. After temperature of the sensor has been in range, the system will automatically return to operation.

If the alarm continues showing, there is a possibility that the LDW has a malfunction. Contact an authorized Mitsubishi Motors dealer for inspection of the system.



Windshield is dirty

The alarm shown below is displayed if the system becomes temporarily unavailable due to the dirty windshield of the sensor portion. After having cleaned the windshield, the system will automatically return to operation.

If the alarm continues showing, there is a possibility that the LDW has a malfunction. Contact an authorized Mitsubishi Motors dealer for inspection of the sensor.



LDW deactivation due to fault

If the LDW is deactivated due to a malfunction in the system, the either alarm shown below is displayed. Contact your authorized Mitsubishi Motors dealer for inspection of the system.

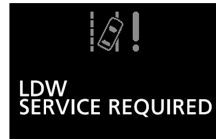

NOTE

- If the sensor or its surrounding area becomes extremely hot (after prolonged exposure to direct sunlight, for example), the “LDW SERVICE REQUIRED” message may appear.

If the message remains even after the temperature of the sensor or its surrounding area has been in range, please contact an authorized Mitsubishi Motors dealer.

Tire pressure monitoring system (TPMS)

N00530201641

The tire pressure monitoring system (TPMS) uses tire inflation pressure sensors (A) on the wheels to monitor the tire inflation pressures. The system only indicates when a tire is significantly under-inflated.

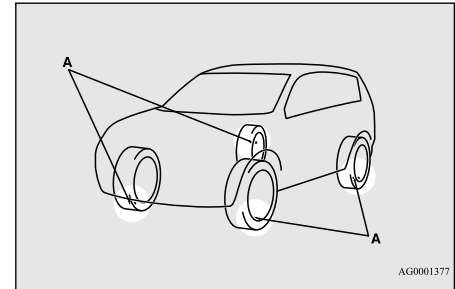

WARNING

- **The compact spare wheel does not have a tire inflation pressure sensor. When the spare tire is used, the TPMS will not work properly. See an authorized Mitsubishi Motors dealer as soon as possible to replace or repair the original tire.**

NOTE

- The TPMS is not a substitute for regularly checking tire inflation pressures. Be sure to check the tire inflation pressures as described in “Tires” on page 9-12.
- The tire inflation pressure sensor (B) is installed in the illustrated location.
 - On vehicles equipped with Type 1 sensor which has the metallic air valve (C), replace grommet and washer (D) with the new ones when the tire is replaced.
 - On vehicles equipped with Type 2 sensor which has the rubber air valve (E), replace rubber air valve (E) with new one when the tire is replaced.

NOTE

For details, please contact your authorized Mitsubishi Motors dealer.

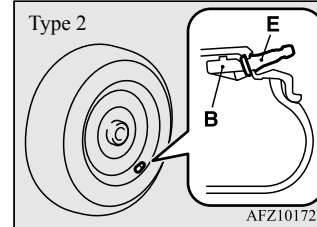
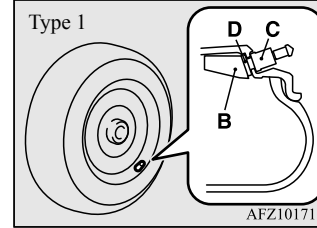

Tire pressure monitoring system warning light / display

N00532701389



When the ignition switch is turned to the “ON” position or the operation mode is put in ON, the tire pressure monitoring system

warning light normally illuminates and goes off a few seconds later.

If one or more of the vehicle tires (except for the spare tire) is significantly under-inflated, the warning light will remain illuminated while the ignition switch is in the “ON” position or the operation mode is put in ON.

Refer to “If the warning light / display illuminates while driving” on page 5-129 and take the necessary measures.

NOTE

- In addition, the warning display is displayed on the information screen in the multi-information display.



CAUTION

- If the tire pressure monitoring system warning light does not illuminate when the ignition switch is turned to the “ON” position or the operation mode is put in ON, it means that the tire pressure monitoring system is not working properly. Have the system inspected by an authorized Mitsubishi Motors dealer.

In such situations, a malfunctioning of the system may be preventing the monitoring of the tire pressure. Avoid sudden braking, sharp turning and high-speed driving.

- If a malfunction is detected in the tire pressure monitoring system, the tire pressure monitoring system warning light will blink for approximately 1 minute and then remain continuously illuminated. The warning light will issue further warnings each time the engine is restarted as long as the malfunction exists.

Check to see whether the warning light goes off after few minutes driving.

If it then goes off during driving, there is no problem.

However, if the warning light does not go off, or if it blinks again when the engine is restarted, have the vehicle inspected by an authorized Mitsubishi Motors dealer.

In such situations, a malfunctioning of the system may be preventing the monitoring of the tire pressure. For safety reasons, when the warning light appears while driving, avoid sudden braking, sharp turning and high-speed driving.

NOTE

- In addition, the warning display is displayed on the information screen in the multi-information display.



Each tire, including the spare (if provided), should be checked monthly when cold and inflated to the inflation pressure recommended by the vehicle manufacturer on the vehicle placard or tire inflation pressure label. (If your vehicle has tires of a different size than the size indicated on the vehicle placard or tire inflation pressure label, you should determine the proper tire inflation pressure for those tires.)

As an added safety feature, your vehicle has been equipped with a tire pressure monitoring system (TPMS) that illuminates a low tire pressure telltale when one or more of your tires is significantly under-inflated.

Accordingly, when the low tire pressure telltale illuminates, you should stop and check your tires as soon as possible, and inflate them to the proper pressure. Driving on a significantly under-inflated tire causes the tire to overheat and can lead to tire failure.

Under-inflation also reduces fuel efficiency and tire tread life, and may affect the vehicle's handling and stopping ability. Please note that the TPMS is not a substitute for proper tire maintenance, and it is the driver's responsibility to maintain correct tire pressure, even if under-inflation has not reached the level to trigger illumination of the TPMS low tire pressure telltale.

Your vehicle has also been equipped with a TPMS malfunction indicator to indicate when the system is not operating properly. The TPMS malfunction indicator is combined with the low tire pressure telltale.

When the system detects a malfunction, the telltale will flash for approximately 1 minute and then remain continuously illuminated. This sequence will continue upon subsequent vehicle start-ups as long as the malfunction exists.

When the malfunction indicator is illuminated, the system may not be able to detect or signal low tire pressure as intended.

TPMS malfunctions may occur for a variety of reasons, including the installation of replacement or alternate tires or wheels on the vehicle that prevent the TPMS from functioning properly. Always check the TPMS malfunction telltale after replacing one or more tires or wheels on your vehicle to ensure that the replacement or alternate tires and wheels

allow the TPMS to continue to function properly.

If the warning light / display illuminates while driving

N00532801579

1. If the tire pressure monitoring system warning light illuminates, avoiding hard braking, sharp steering maneuvers and high speeds. You should stop and adjust the tires to the proper inflation pressure as soon as possible. Adjust the spare tire at the same time. Refer to “Tires” on page 9-12.

NOTE

- In addition, the warning display is displayed on the information screen in the multi-information display.
- When inspecting or adjusting the tire pressure, do not apply excessive force to the valve stem to avoid breakage.
- After inspecting or adjusting the tire pressure, always reinstall the valve cap on the valve stem.
Without the valve cap, dirt or moisture could get into the valve, resulting in damage to the tire inflation pressure sensor.
- Do not use metal valve caps, which may cause a metal reaction, resulting in corrosion and damage of the tire inflation pressure sensors.

NOTE

- Once adjustments have been made, the warning light will go off after a few minutes of driving.
2. If the tire pressure monitoring system warning light remains illuminated after you have been driving for approximately 20 minutes after you adjust the tire inflation pressure, one or more of the tires may have a puncture. Inspect the tire and if it has a puncture, have it repaired by an authorized Mitsubishi Motors dealer as soon as possible.

WARNING

- **If the warning light / display illuminates while you are driving, avoid hard braking, sharp steering maneuvers and high speeds.
Driving with an under-inflated tire adversely affects vehicle performance and can result in an accident.**

CAUTION

- If a tire has a puncture, replace that tire with the spare tire. Driving on a punctured tire could lead to an accident.
- The warning light / display may not illuminate immediately in the event of a tire blow-out or rapid leak.

NOTE

- To avoid the risk of damage to the tire inflation pressure sensors, have any punctured tire repaired by an authorized Mitsubishi Motors dealer. If the tire repair is not done by an authorized Mitsubishi Motors dealer, it is not covered by your warranty.
- Do not use an aerosol puncture-repair spray on any tire.
Such a spray could damage the tire inflation pressure sensors.
Have any puncture repaired by an authorized Mitsubishi Motors dealer.

The tire pressure monitoring system may not work normally in the following circumstances:

- A wireless facility or device using the same frequency is near the vehicle.
- Snow or ice is stuck inside the fenders and/or on the wheels.
- The tire inflation pressure sensor's battery is dead.
- Wheels other than Mitsubishi genuine wheels are being used.
- Wheels that are not fitted with tire inflation pressure sensors are being used.
- Wheels whose ID codes are not memorized by the vehicle are used.
- Compact spare tire is fitted as a road wheel.

Tire pressure monitoring system (TPMS)

- A window tint that affects the radio wave signals is installed.

NOTE

- Tire inflation pressures vary with the ambient temperature. If the vehicle is subjected to large variations in ambient temperature, the tire inflation pressures may be under-inflated (causing the warning light / display come on) when the ambient temperature is relatively low. If the warning light / display comes on, adjust the tire inflation pressure.

Whenever the tires and wheels are replaced with new ones

N00532900081

If new wheels with new tire inflation pressure sensors are installed, their ID codes must be programmed into the tire pressure monitoring system. Have tire and wheel replacement performed by an authorized Mitsubishi Motors dealer to avoid the risk of damaging the tire inflation pressure sensors. If the wheel replacement is not done by an authorized Mitsubishi Motors dealer, it is not covered by your warranty.



CAUTION



- The use of non-genuine wheels will prevent the proper fit of the tire inflation pressure sensors, resulting in air leakage or damage to the sensors.

Tire ID set change

N00584300042

In case that 2 sets of tire inflation pressure sensor ID are registered in the receiver, the valid tire ID set can be changed by following procedure.

1. Switch to the function setting screen.
Refer to “Multi-information display switches” on page 5-145.
Refer to “Changing the function settings” on page 5-155.
2. Press the  switch or  switch several times to switch to the “TPMS ID” screen.
Then, press the  switch to the setting selection screen.

3. Press the  switch or  switch to select the “ID 1” or “ID 2”, and then press and hold the  switch for approximately 3 seconds or more to confirm the setting.

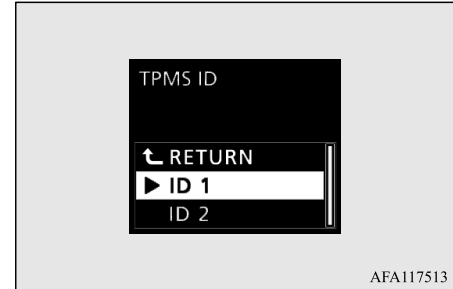

4. The valid tire ID set is changed, and the number of the tire pressure monitoring system (TPMS) SET indicator is changed.

NOTE

- The tire ID set is NOT changed, in case that only 1 set of ID is registered.

General information

N00533001233

Your tire pressure monitoring system operates on a radio frequency subject to Federal Communications Commission (FCC) Rules (For vehicles sold in U.S.A.) and Industry Canada Rules (For vehicles sold in Canada). This device complies with part 15 of FCC

Rules and Industry Canada licence-exempt RSS standard(s).

Operation is subject to the following two conditions.

- This device may not cause harmful interference.
- This device must accept any interference received, including interference that may cause undesired operation.

⚠ CAUTION

- Changes or modifications not expressly approved by the manufacturer for compliance could void the user's authority to operate the equipment.

Rear-view camera

N00546201457

When the selector lever is in the "R" (REVERSE) position with the ignition switch in the "ON" position or the operation mode in ON, the rear-view image will be displayed on the screen of the Smartphone-link Display Audio (SDA) or the Smartphone-link Display Audio (SDA) navigation system.

When the selector lever is shifted out of the "R" (REVERSE) position, the rear-view image will go off.

⚠ WARNING

- **Never rely solely on the rear-view camera to clear the area behind your vehicle. Always check visually behind and all around your vehicle for persons, animals, obstructions or other vehicles. Failure to do so can result in vehicle damage, serious injury or death.**
- **The rear-view camera is an aid system for backing up, but it is not a substitute for your visual confirmation.**
- **The view on the screen is limited, and objects outside the view, such as under the bumper or around either corner of the bumper end, cannot be seen on the screen.**

⚠ CAUTION

- If the camera lens gets dirty, a clear image cannot be obtained. As necessary, rinse the lens with clean water and gently wipe with a clean, soft cloth.
- To avoid damaging the camera;
 - Do not rub the cover excessively or polish it by using an abrasive compound.
 - Do not disassemble the camera.
 - Do not splash hot water directly on the lens.
 - Do not spray the camera and its surroundings with high-pressure water.
- Make sure that the liftgate is securely closed when backing up.

Location of rear-view camera

The rear-view camera (A) is in the liftgate, at the left side of the liftgate handle.

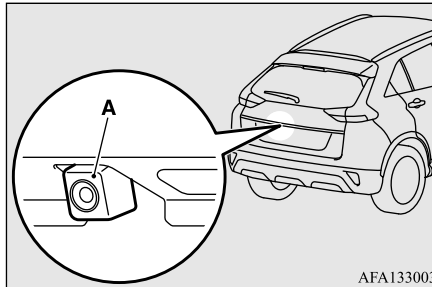

AFA133003

Reference lines on the screen

Reference lines and upper surface of the rear bumper (A) are displayed on the screen.

- Red line (B) indicates approximately 20 inches (50 cm) behind the rear bumper.
- Two Green lines (C) indicate approximately 8 inches (20 cm) outside of the vehicle body.
- Short transverse lines (1 and 2) indicate approximate distance from the rear bumper.

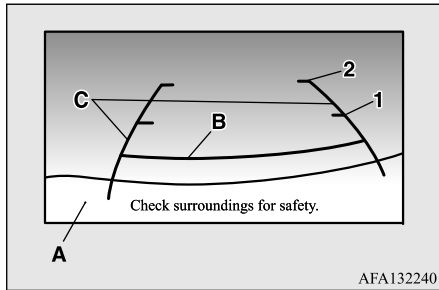

- 1- Approximately 39 inches (100 cm)
- 2- Approximately 79 inches (200 cm)

CAUTION

- The rear-view camera uses a wide-angle lens. As a result, images and distances shown on the screen are not exact.

CAUTION

- Actual distance may be different from distance indicated by the lines on the screen, depending on the loading condition of the vehicle and road surface condition. The reference lines for distance and vehicle width are based on a level, flat road surface. In the following cases, objects shown on the screen will appear to be farther off than they actually are.
 - When the rear of the vehicle is weighed down with the weight of passengers and luggage in the vehicle. (Case 1)
 - When there is an upward slope at the back. (Case 2)

Case 1

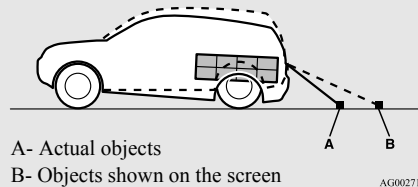

A- Actual objects
B- Objects shown on the screen

Case 2

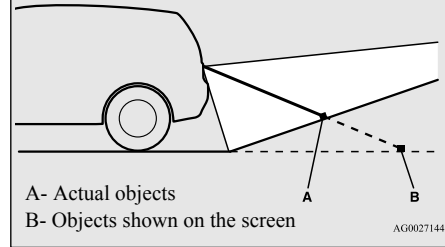

A- Actual objects
B- Objects shown on the screen

CAUTION

- The reference lines for distance and vehicle width are intended to indicate the distance to a flat object such as a level, flat road surface. They may not indicate correct distance depending on the shape of an obstacle. For example, when there is an object behind the vehicle that has upper sections projecting in the direction of the vehicle, the reference lines on the screen will indicate that point A is the farthest point and point B is the closest point to the vehicle. In reality, point A and B are actually the same distance from the vehicle, and point C is farther off than point A and B.

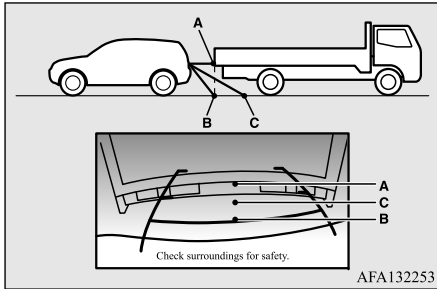

NOTE

- Mirror image is displayed on the screen.
- On vehicles equipped with the SDA or the SDA navigation system, it is possible to change the display language of the screen. For details, please refer to the separated owner's manual.
- Under certain circumstances, it may become difficult to see an image on the screen, even when the system is functioning correctly.
 - In a dark area, such as at night.
 - When water drops or condensation are on the lens.
 - When sun light or headlights shine directly into the lens.

Multi Around Monitor (if so equipped)

N00587200101

The Multi Around Monitor system uses four cameras, “Front-view camera”, “Side-view cameras (right and left)” and “Rear-view camera”, and displays composite views from those cameras on the Smartphone-link Display Audio (SDA) or the Smartphone-link Display Audio (SDA) navigation system.

The Multi Around Monitor system will assist the driver to park the vehicle in a narrow or parallel parking space.

WARNING

- Before using the Multi Around Monitor system, read this entire section to fully understand the limitations of this system. Failure to follow instructions could result in an accident.
- The Multi Around Monitor system is an aid system to help observe around the vehicle. It is not a substitute for your visual confirmation.
- Never rely solely on the Multi Around Monitor system. The view on the screen is limited, and objects outside the view cannot be seen on the screen.

CAUTION

- Before using the Multi Around Monitor, make sure that all doors and the liftgate are closed and the outside mirrors are unfolded. If an outside mirror is folded and/or if a front door and/or the liftgate is open, the areas displayed on the Multi Around Monitor will not be appropriate.

5

Location of each camera

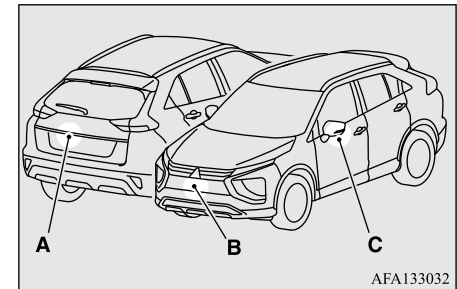

- A- Rear-view camera
- B- Front-view camera
- C- Side-view camera

CAUTION

- If the camera lens gets dirty, a clear image cannot be obtained. As necessary, rinse the lens with clean water and gently wipe with a clean, soft cloth.

 **CAUTION**

- To avoid damaging the camera;
 - Do not rub the cover excessively or polish it by using an abrasive compound.
 - Do not disassemble the camera.
 - Do not splash hot water directly on the lens.
 - Do not spray the camera and its surroundings with high-pressure water.
 - Make sure that the liftgate is securely closed when backing up.
- Do not attach anything on the camera and/or surrounding areas. Doing so will disturb the camera.

Range of view of the Multi Around Monitor

N00587300056

The range of view of the Multi Around Monitor cameras is limited to the area shown in the illustrations. It cannot show around the both sides and the lower part of the front and rear bumpers, etc. While driving, be sure to visually confirm safety around the vehicle.

Range of view of the Multi Around Monitor cameras

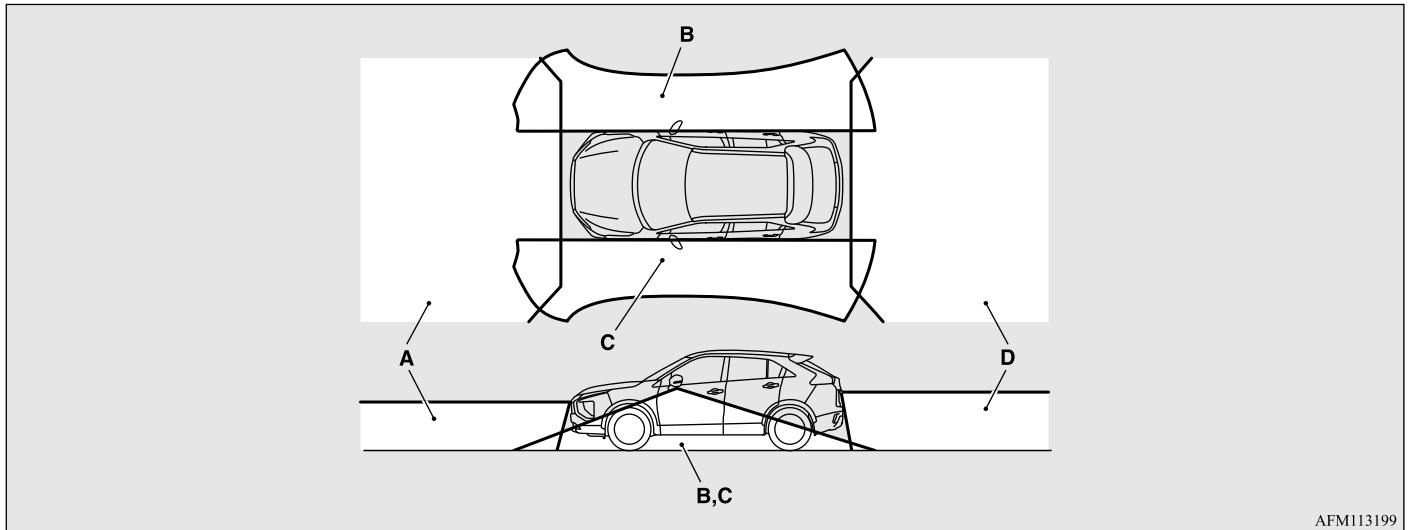

- A: Front-view camera
- B: Side-view camera (Right)
- C: Side-view camera (Left)
- D: Rear-view camera

Multi Around Monitor (if so equipped)

Types of views of the Multi Around Monitor

N00587400099

Bird's eye-view/Rear-view mode

5 Views of the surroundings of the vehicle and behind the vehicle are displayed.

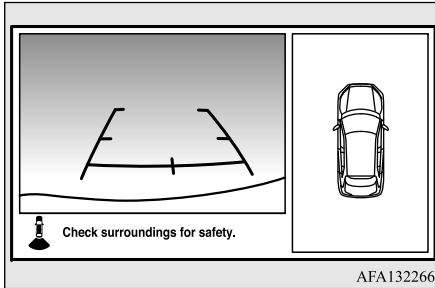

Side-view/Rear-view mode

Views of the passenger's side of the vehicle and behind the vehicle are displayed.

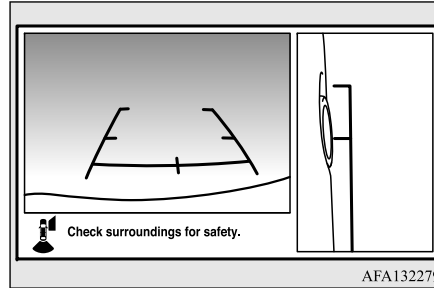

Bird's eye-view/Front-view mode

Views of the surroundings of the vehicle and the front of the vehicle are displayed.

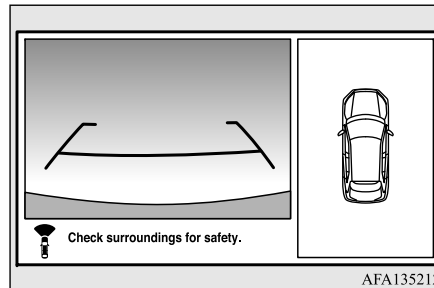

Side-view/Front-view mode

Views of the passenger's side of the vehicle and the front of the vehicle are displayed.

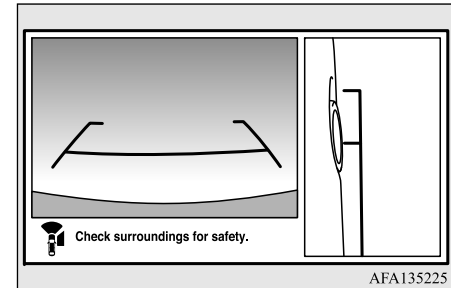

CAUTION

- The camera uses a special lens. As a result, images and distances shown on the screen are not exact.

NOTE

- Because the cameras have a special lens, the lines on the ground between parking spaces may not look parallel on the screen.
- Under certain circumstances, it may become difficult to see an image on the screen, even when the system is functioning correctly.
 - In a dark area, such as at night.
 - When water drops or condensation are on the lens.

NOTE

- When sun light or headlights shine directly into the lens.
- When a fluorescent light shines directly into the lens.
- If the atmospheric temperature is extremely hot or extremely cold, the camera images may not be clear.
There is no abnormality.
- If a wireless device is installed near the camera, the camera images may cause electrical system interference and the system may stop functioning properly.

How to use the Multi Around Monitor

N00587500104

The Multi Around Monitor can only be used when the operation mode is put in ON.

Operation with the selector lever

When you move the selector lever to the “R” (REVERSE) position, the bird’s eye-view/rear-view is displayed on the SDA or the SDA navigation system. When you move the selector lever to any other position, the display disappears.

NOTE

- The passenger’s side screen can be switched to the side-view by pressing the camera switch on the steering wheel.

Operation with the switch

When the camera switch (A) is pressed, the bird’s eye-view/front-view is displayed.

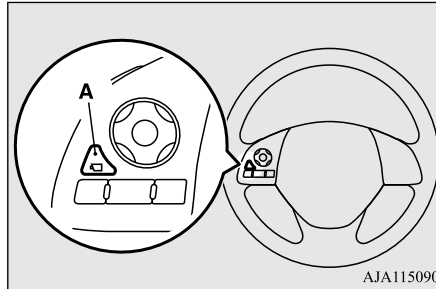
**NOTE**

- If there is no operation for 3 minutes after the Multi Around Monitor is displayed by pressing the switch with the selector lever in other than “R” (REVERSE), the display disappears.

Switching of the screen (Selector lever is “R” (REVERSE))

If the camera switch is pressed, the mode of Multi Around Monitor is switched as follows.
Bird’s eye-view/Rear-view mode → Side-view/Rear-view mode

Switching of the screen (Selector lever is other than “R” (REVERSE))

If the camera switch is pressed, the mode of Multi Around Monitor is switched, Bird’s eye-view/Front-view mode → Side-view/Front-view mode → OFF

NOTE

- When you move the selector lever to the “R” (REVERSE) position with the front-view mode displayed on the driver’s side screen, the driver’s side screen switches to the rear-view mode. When you shift the selector lever to any other position, the driver’s side screen switches to the front-view mode.
- When the camera switch is pressed at the vehicle speed of approximately 6 mph (10 km/h) or higher, only the side-view can be displayed on the passenger’s side screen.

Multi Around Monitor (if so equipped)

NOTE

- The front-view will not be displayed when the vehicle speed exceeds approximately 6 mph (10 km/h).
- The display of the view may be delayed during switching of the screen.

5

How to read the screen

N0058760088

In any mode other than the Bird's eye-view mode, the lines in the screen give the following information. Use them only as a guide.

CAUTION

- If the camera and/or its surrounding area have experienced an impact, the Multi Around Monitor system may not function correctly. Have the vehicle inspected by an authorized Mitsubishi Motors dealer.

Front-view mode

Reference lines for the distance and the vehicle width and upper surface of the front bumper (A) are displayed on the screen.

- The Red line (B) indicates approximately 20 inches (50 cm) from the front edge of the front bumper.

- The Two Green lines (C) indicate the approximate vehicle width.
- The Orange lines (D) indicates an expected course when the vehicle moves forward with the steering wheel turned. It disappears when the steering wheel is in the neutral position.
- The approximate distance from the vehicle body is as follows:

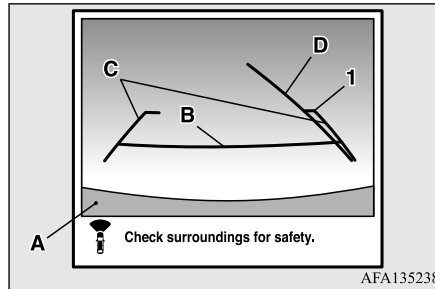

- 1- Approximately 39 inches (100 cm) from the front edge of the front bumper

NOTE

- When the expected course lines are displayed in the front-view, the expected course lines are also displayed in the bird's eye-view (Front: solid line, Rear: broken line).

NOTE

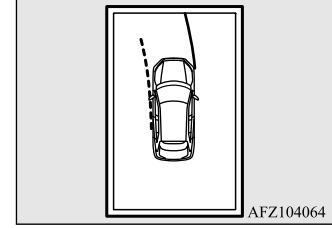

Rear-view mode

N0058770063

Reference lines for the distance and the vehicle width and upper surface of the rear bumper (A) are displayed on the screen.

- The Red line (B) indicates approximately 20 inches (50 cm) behind the rear edge of the rear bumper.
- The Two Green lines (C) indicate the approximately vehicle width.
- The Orange line (D) indicates an expected course when the vehicle is reserved with the steering wheel turned. It disappears when the steering wheel is in the neutral position.
- The approximate distance from the vehicle body is as follows:

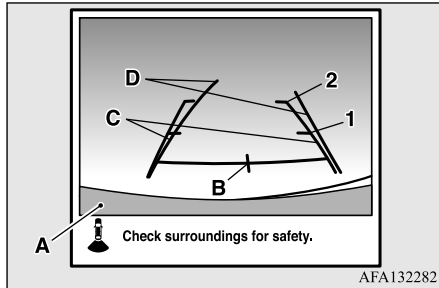

- 1- Approximately 39 inches (100 cm) from the rear edge of the rear bumper
- 2- Approximately 79 inches (200 cm) from the rear edge of the rear bumper

⚠ CAUTION

- The rear-view camera uses a wide-angle lens. As a result, images and distances shown on the screen are not exact.

- Never rely solely on the reference lines. The reference lines indicating distance and vehicle width are based on a level, flat road surface.

Actual distance may be different from distance indicated by the lines on the screen, depending on the loading condition of the vehicle and road surface condition.

Also, your vehicle width indicated by the reference lines may be different from the actual vehicle width.

⚠ CAUTION

For example;

In the following cases, objects shown on the screen will appear to be farther off than they actually are.

- When the rear of the vehicle is weighed down with the weight of passengers and luggage in the vehicle.

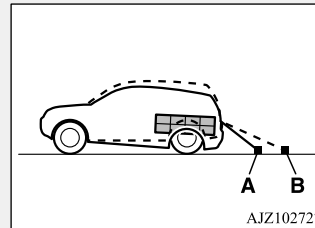

- A: Actual objects
B: Objects shown on the screen

- When there is an upward slope behind the vehicle.

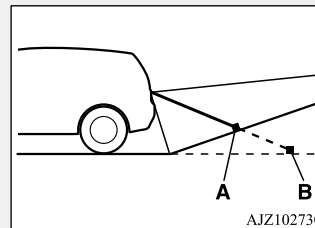

- A: Actual objects
B: Objects shown on the screen

⚠ CAUTION

- When there is a downward slope behind the vehicle, objects shown on the screen will appear to be closer than they actually are.

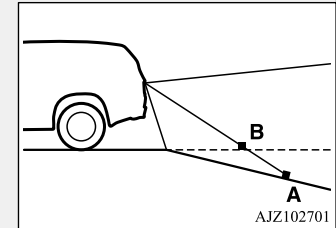

- A: Actual objects
B: Objects shown on the screen

CAUTION

- When the vehicle is approaching a truck, the reference lines indicate that your vehicle will clear the truck. In reality, the truck is in your path.

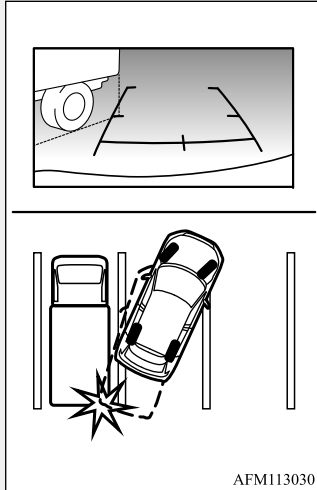

5

CAUTION

- When there is an object behind the vehicle that has upper sections projecting in the direction of the vehicle, the reference lines on the screen will indicate that point A is the farthest point and point B is the closest point to the vehicle. In reality, point A and B are actually the same distance from the vehicle, and point C is farther off than point A and B.

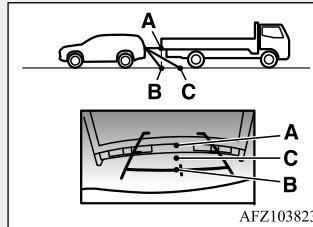

NOTE

- When the expected course lines are displayed in the rear-view, the expected course lines are also displayed in the bird's eye-view (Front: broken line, Rear: solid line).

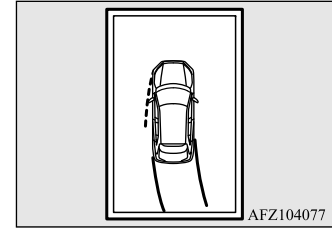

Side-view mode

N00587900036

Reference lines for the vehicle width and the front end of the vehicle are displayed on the screen.

- 1- Approximate vehicle width including the door mirror.
- 2- Approximate location of the axle center of the front wheel.
- 3- Approximate 20 inches (50 cm) from the front edge of the front bumper.

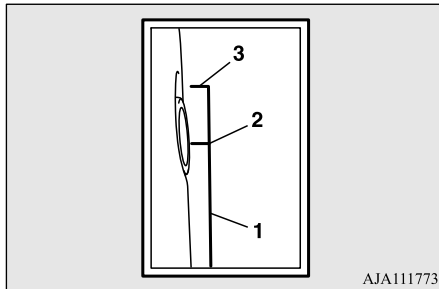

AJA111773

Bird's eye-view mode

N00588000047

An overhead view in which the vehicle is looked down is displayed so that you can easily identify the location of your vehicle and the course to enter the parking space.

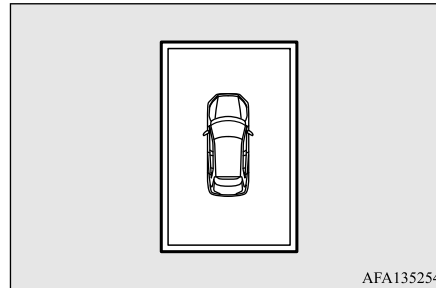

AFA135254

CAUTION

- The bird's eye-view is a composite image from images captured by the "Front-view camera", "Side-view cameras (right and left)" and "Rear-view camera". As a result, objects may appear to be farther away than they actually are. Also, an object may appear to be in a direction and/or location different from actual. In addition, blind spots exist in proximity of the vehicle.

Even if the screen indicates that there is a space between your vehicle and an object, there may actually be less or no space. Always check visually behind and all around your vehicle.

- The view at a section near each corner on the Bird's eye-view is combined from the edge of the view captured by each camera. As result, an object indicated in the section may be unclear, and it may disappear/reappear on the screen.

NOTE

- In the Bird's eye-view mode, since the views captured by the four cameras, "Front-view camera", "Side-view cameras (right and left)" and "Rear-view camera" are processed based on a level flat road surface, an image may be displayed as follows:
 - An object appears to have fallen down and looks longer or larger.

NOTE

- An object having a height from the road surface may seem to appear from the joint of the view composition processing regions.
- The brightness of the views from each camera may vary depending on the illuminance conditions.
- An object above the camera is not displayed.
- The object displayed in the Front-view mode or the Rear-view mode may not be displayed in the Bird's eye-view mode.
- The view in the Bird's eye-view mode may be displaced from its true position when the mounting location and angle of each camera are changed.
- The lines on the road may appear to be displaced or bent at the joint of the views.

To change the vehicle icon color in the bird's eye-view

N00594200028

It is possible to change the vehicle icon color in the bird's eye-view.

1. Stop the vehicle in a safe place.

CAUTION

- For reasons of safety, do not operate the switch while driving.

2. Press the switch (A) to display the bird's eye-view/front-view.

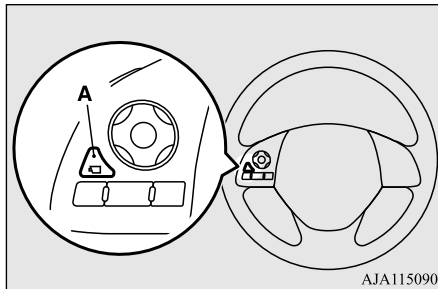

3. Press and hold down the switch (A) until the vehicle icon blinks to enter the selection mode of the vehicle icon color in the bird's eye-view.
4. Press the switch until the desired color appears on the display. Each time you press the switch, the vehicle icon color in the bird's eye-view will change to the next one.
5. When it is changed to your desired color, press and hold the switch (A) for a few seconds. This completes the setting.

NOTE

- When the selection mode is in the following situations, the vehicle icon color does not change.

NOTE

- When you place the gearshift lever or the selector lever in the "R" (REVERSE) position.
- When you do not operate anything for 30 seconds.
- The operation mode is put in OFF.

Instrument cluster

N00519001444

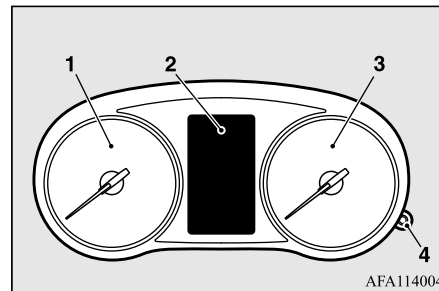

- 1- Tachometer → P.5-143
- 2- Multi-information display → P.5-144
Information screen display list → P.5-165
- 3- Speedometer → P.5-143
- 4- Rheostat illumination button → P.5-143

Speedometer

N00519101272

The speedometer shows the vehicle speed in miles per hour (mph) or kilometers per hour (km/h).

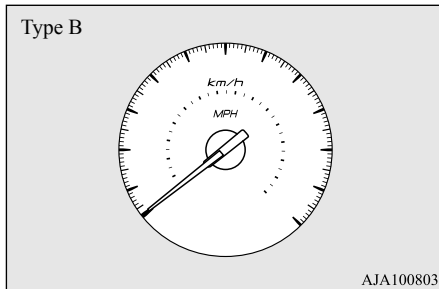
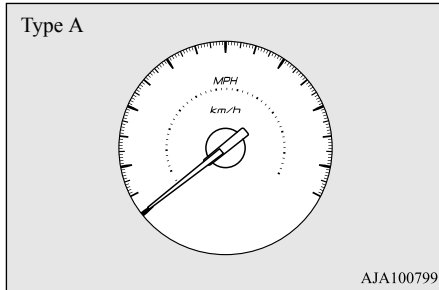

Tachometer

N00519201303

The tachometer shows engine revolutions per minute. This allows the driver to determine the most efficient selector position and engine speed combinations.

This gauge also assists in evaluating engine performance.

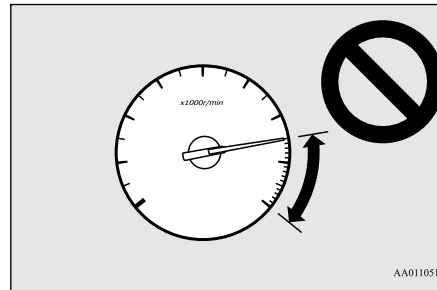

CAUTION

- The red zone indicates an engine speed beyond the range of safe operation.

Select the correct selector position to control the engine speed so that the tachometer indicator does not enter the red zone.

Meter illumination control

N00554901349

Each time you press this button, there is a sound and the brightness of the instruments changes.

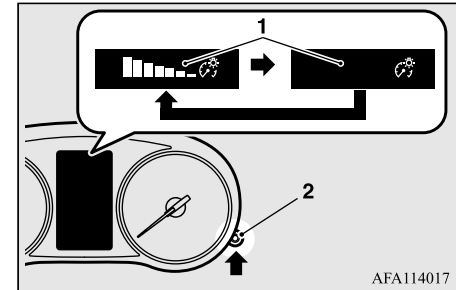

- 1- Brightness level
- 2- Rheostat illumination button

NOTE

- You can adjust to 8 different levels for when the front side-marker lights are illuminated and when they are not.
- If the vehicle is equipped with the automatic light control, the light switch is in the “”, “”, or “” position and it is sufficiently dark outside the vehicle, the meter illumination switches automatically to the adjusted brightness.

NOTE

- The brightness level of the instruments is stored when the ignition switch is turned to the “OFF” position or the operation mode is put in OFF.
- If you press and hold the button for longer than approximately 2 second when the front side-marker lights are illuminated, the brightness level changes to the maximum level. Pressing and holding the button for longer than approximately 2 second again returns the brightness level to the previous level.

It is recommended to use this function when it is difficult to read the meter due to the meter illumination is dimmed by turning on the tail lights in bright areas.

For vehicles equipped with the Smartphone-link Display Audio (SDA) or the Smartphone-link Display Audio (SDA) navigation system, the operation of the screen background theme and the switch illumination when the meter illumination brightness level is changed to the maximum vary depending on the specifications of the SDA or the SDA navigation system.

Multi-information display

N0055001549



The multi-information display displays warnings, the odometer, trip odometer, service reminder, engine coolant temperature, fuel remaining, outside temperature, selector lever

position, average and instant fuel consumption, driving range, average speed, etc.

It is also possible to change elements such as the language and units used on the multi-information display.

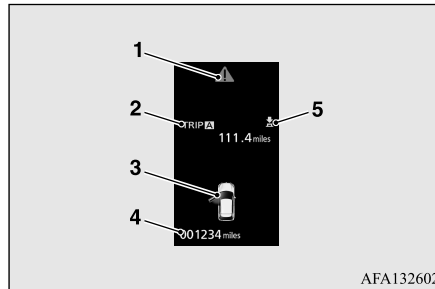
[With the ignition switch or the operation mode in OFF]



- 1-  Warning display screen → P.5-149
- 2- Information screen → P.5-146
Interrupt display screen → P.5-149
- 3- Door ajar warning display screen → P.5-150
- 4- Odometer → P.5-151
- 5-  mark indicator → P.5-149

[With the ignition switch or the operation mode in ON]

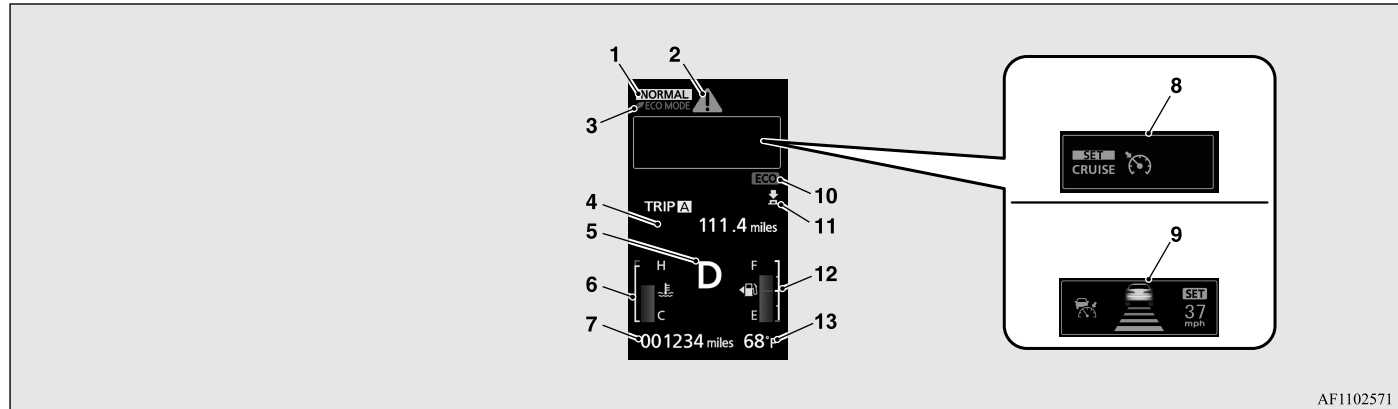

5

AF1102571

- 1- S-AWC drive mode display screen (if so equipped) → P.5-71
- 2- Warning display screen → P.5-149
- 3- ECO mode indicator display screen → P.5-204
- 4- Information screen → P.5-146
- 5- Selector lever position display → P.5-65
- 6- Engine coolant temperature display → P.5-150
- 7- Odometer → P.5-151
- 8- Cruise control display screen → P.5-87
- 9- Adaptive Cruise Control System (ACC) display screen (if so equipped) → P.5-92
- 10- ECO indicator → P.5-154
- 11- mark indicator → P.5-149
- 12- Fuel remaining display screen → P.5-150
- 13- Outside temperature display screen → P.5-151

NOTE

- The fuel units, outside temperature units, display language, and other settings can be changed.
Refer to “Changing the function settings” on page 5-155.

Multi-information display switches

N00555101234

Each time the multi-information display switches are operated, the buzzer sounds and the multi-information display changes between information such as warnings, trip odometer, average and instant fuel consumption, distance range.

It is also possible to change elements such as the language and units used on the multi-information display by operating the multi-information display switches.

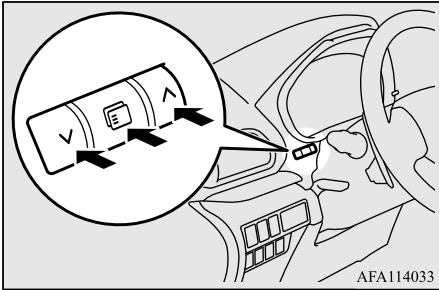

5

Information screen (With the ignition switch in “OFF” position or the operation mode in OFF)

N00555301207

Press the switch to display the information screen. Then, press the switch or switch to switch the display screen in the following order.

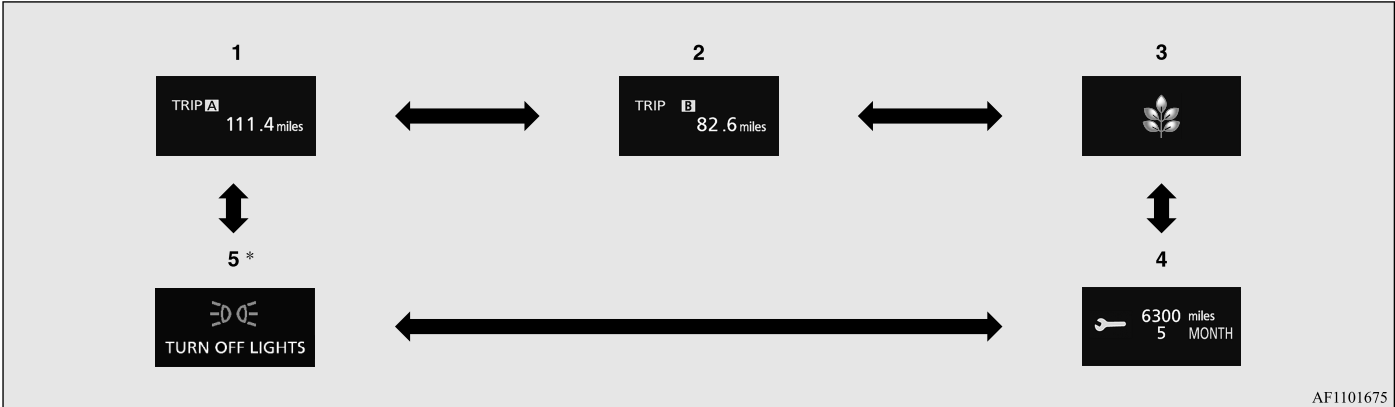

AF1101675

*: When there is a warning display

1- Trip odometer → P.5-151

- 2- Trip odometer **B** → P.5-151
- 3- ECO score display → P.5-155
- 4- Service reminder → P.5-151
- 5- Redisplay of a warning display screen → P.5-149

Information screen (With the ignition switch is turned from the “OFF” position to the “ON” position or the operation mode is changed from OFF to ON)

N00555801345

5

When the ignition switch is turned to the “ON” position or the operation mode is put in ON, the display screen switches in the following order.

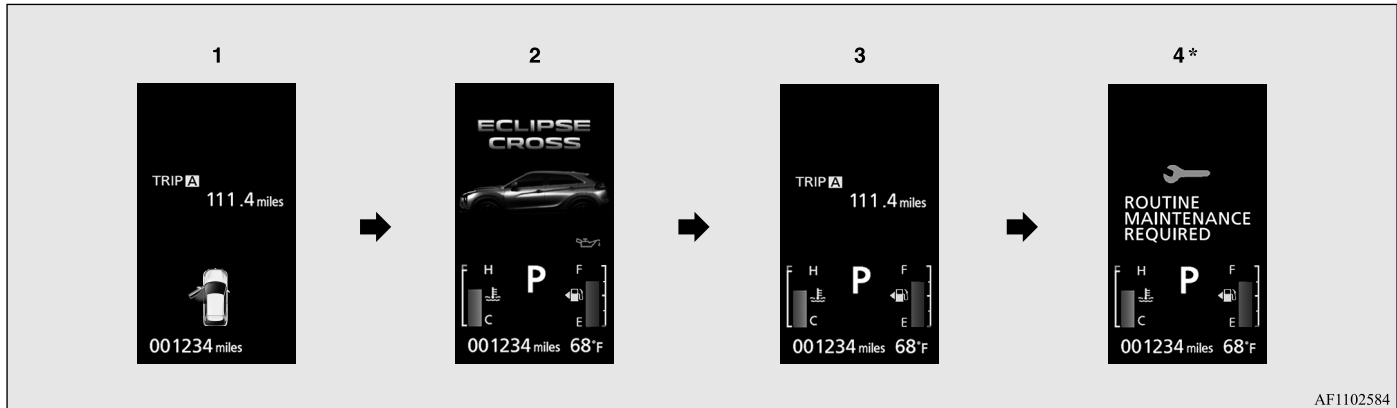

*: When the inspection time has arrived

- 1- Screen when the ignition switch or the operation mode is OFF
- 2- System check screen → P.5-153
- 3- Screen when the ignition switch or the operation mode is ON
- 4- Service reminder → P.5-151

Information screen (With the ignition switch or the operation mode in ON)

N00556201346

Press the **▼** switch or **▲** switch to switch the display screen in the following order.

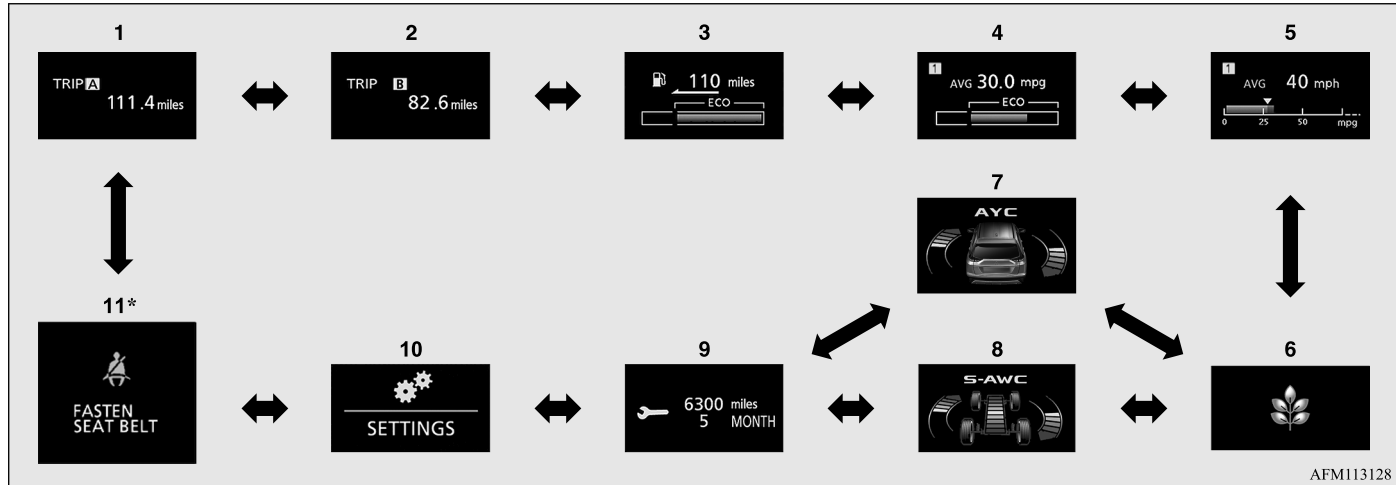

AFM113128

*: When there is a warning display

- 1- Trip odometer **A** → P.5-151
- 2- Trip odometer **B** → P.5-151
- 3- Driving range display → P.5-153
ECO drive assist display → P.5-154
- 4- Average fuel consumption display → P.5-153
ECO drive assist display → P.5-154

- 5- Average speed display → P.5-154
Instant fuel consumption display → P.5-154
- 6- ECO score display → P.5-155
- 7- AYC (Active Yaw Control) operation display (if so equipped) → P.5-81
- 8- S-AWC operation display (if so equipped) → P.5-72
- 9- Service reminder → P.5-151

- 10- Function setting screen → P.5-155
- 11- Redisplay of a warning display screen → P.5-149

NOTE

- While driving, the service reminder are not displayed even if you operate the multi-information display switches. Always stop the vehicle in a safe place before operating.

NOTE

- While driving, the function setting screen is not displayed even if you operate the multi-information display switches. Always park the vehicle in a safe place, firmly apply the parking brake and put the selector lever into the “P” (PARK) position before operating the function setting screen. Refer to “Changing the function settings” on page 5-155.
- When there is information to be announced, such as a system fault, the tone sounds and the screen display is switched. Refer to “Interrupt display screen” on page 5-149.

Interrupt display screen

N00556301246

Warning display

When there is information to be announced, such as a system fault, the tone sounds and the information screen is switched to the warning display screen.



Refer to the warning list and take the necessary measures.

Refer to “Warning display list” on page 5-166.



When the cause of the warning display is eliminated, the warning display goes out automatically.

Returning to the display screen from before the warning display

Even if the cause of the warning display is not eliminated, you can return to the screen that was displayed before the warning display.

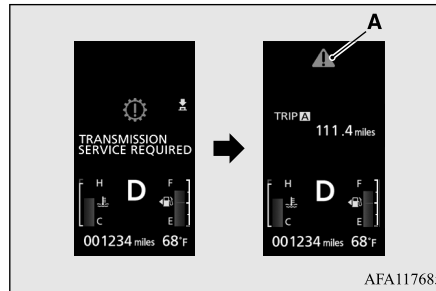

If you press the  switch, the display screen switches to the screen display from before the warning and the  warning (A) is also displayed.

**If you want to switch the display**

Warning display screens with the  mark displayed in the upper right of the screen can be switched. If you want to switch the display, press the  switch for approximately 2 seconds or more.

Redisplay of a warning display screen

N00579600034

When the  warning is displayed, if you press the  switch or  switch a few times, the warning display screen you switched from is redisplayed.

Other interrupt displays

N00579700022

The operation status of each system is displayed on the information screen. For further details, refer to the appropriate page in the warning display list. Refer to “Other interrupt displays” on page 5-182.

 warning display screen

N00555201248

This is displayed when you press the  switch and return from the warning display screen to the previous screen.

This mark is also displayed if there is another warning other than the one displayed.

When the cause of the warning display is eliminated, the  warning goes out automatically.

 **NOTE**

- When the  warning is displayed, the warning display screen can be redisplayed on the information screen.
Refer to “Information screen (with the ignition switch in “OFF” position or the operation mode in OFF)” on page 5-146.
Refer to “Information screen (with the ignition switch or the operation mode in ON)” on page 5-148.

5

Door ajar warning display screen

N00529700056



If any of the doors or the liftgate is not completely closed, this displays the open door or liftgate.

If the speed increases to approximately 5 mph (8 km/h) or higher with a door ajar, a tone will sound four times to inform you that a door is ajar.

 **CAUTION**

- Always make sure that the warning display goes out before beginning to drive.

Engine coolant temperature display

N00578200020

Shows the engine coolant temperature.

If the coolant becomes hot,  will blink. Pay careful attention to the engine coolant temperature display while you are driving.

 **CAUTION**

- If the engine is overheating,  will blink. In this case, the bar graph is on the red zone. Immediately park the vehicle in a safe place and take the required measures. Refer to “Engine overheating” on page 8-4.

Fuel remaining display screen

N00556601252

Shows the amount of fuel remaining.

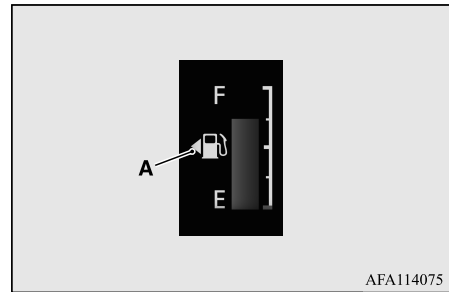

AFA114075

F- Full
E- Empty

 **CAUTION**

- Running out of gas could damage the catalytic converter. If the warning display appears, refuel immediately.

 **NOTE**

- It may take several seconds to stabilize the display after refilling the tank.
- If fuel is added with the ignition switch or the operation mode in ON, the remaining fuel display may incorrectly indicate the fuel level.
- The arrow (A) indicates that the fuel tank filler door is located on the left side of the vehicle. (Refer to “Filling the fuel tank” on page 3-3.)

Fuel remaining warning display

N00578300106

When the fuel level runs low, the information screen switches to the interrupt display of the fuel remaining warning display and the mark (B) on the fuel remaining display flashes. If the warning display appears, refuel immediately.

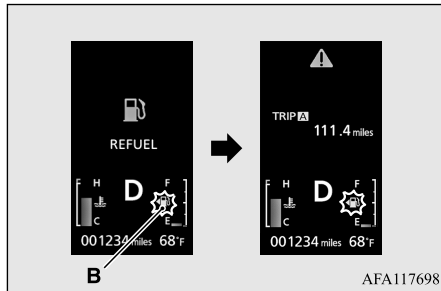

AFA117698

NOTE

- On hills or curves, the display may be incorrect due to the movement of fuel in the tank.

Outside temperature display screen

N00556501118

Shows the temperature outside the vehicle.

NOTE

- The display setting can be changed to the preferred units (°F or °C). Refer to “Changing the function settings” on page 5-155.
- Depending on factors such as the driving conditions, the displayed temperature may vary from the actual outside temperature.

Odometer

N00574901026

Shows the total distance traveled.

Trip odometer

N00575001079

Shows the distance traveled between two points.

Usage examples for trip odometer **A**, trip odometer **B**.
It is possible to measure two currently traveled distances, from home using trip odometer **A** and from a particular point on the way using trip odometer **B**.

To reset the trip odometer

To return the display to “0”, hold down the  switch for approximately 2 seconds or

more. Only the currently displayed value will be reset.

Example

If trip odometer **A** is displayed, only trip odometer **A** will be reset.

- Both trip odometers **A** and **B** can count up to 9999.9 miles/kilometers. When a trip odometer goes past 9999.9 miles/kilometers, it returns to 0.0 miles/kilometers.
- When disconnecting the battery terminal, the memories of trip odometer displays **A** and **B** are cleared, and their displays return to “0.0 miles/kilometers”.

Service reminder

N00556701338

Displays the approximate time until the next recommended periodic inspection. “---” is displayed when the inspection time has arrived.

NOTE

- The service reminder time can be modified by an authorized Mitsubishi Motors dealer, to adjust for severe usage, etc. Refer to “Severe maintenance schedule” in your vehicle’s Warranty and Maintenance Manual. For further information, please contact your authorized Mitsubishi Motors dealer.

5

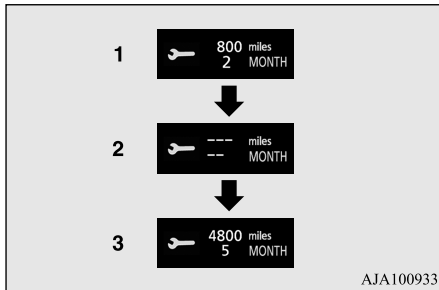

1. Shows the time until the next periodic inspection.

NOTE

- Shows the distance in units of 100 miles (100 km) and the time in units of 1 month.

2. This informs you that a periodic inspection is due. Contact an authorized Mitsubishi Motors dealer or a repair facility of your choice to have the system checked.



At that time, when the ignition switch is switched from the “OFF” position to the “ON” position or the operation mode is changed from OFF to ON, the warning display is displayed for a few seconds on the information screen.





3. After your vehicle is inspected at an authorized Mitsubishi Motors dealer, it displays the time until the next periodic inspection.

To reset

The “---” display can be reset while the ignition switch or the operation mode is in OFF. When the display is reset, the time until the next periodic inspection is displayed and the warning display is no longer displayed when the ignition switch is switched from the “OFF” position to the “ON” position or the operation mode is changed from OFF to ON.

1. When you press the  switch or  switch, the information screen switches to the service reminder display screen.



2. Press and hold the  switch (for approximately 2 seconds or more) to display “” and make it flash. (If there is no operation for approximately 10 seconds with this indicator flashing, the display returns to the previous screen.)
3. With this indicator flashing, if you press the  switch, the screen switches from “---” to “CLEAR”. After that, the time until the next periodic inspection is shown.

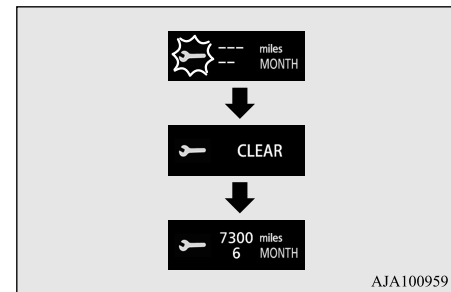

⚠ CAUTION

- The customer is responsible for making sure that regular inspections and maintenance and periodic inspections and maintenance are performed. Inspections and maintenance must be performed to prevent accidents and malfunctions.

📖 NOTE

- The “---” display cannot be reset while the ignition switch or the operation mode is in ON.
- When “---” is displayed, after a certain distance and a certain period of time, the display is reset and the time until the next periodic inspection is displayed.
- If you accidentally reset the display, consult an authorized Mitsubishi Motors dealer for assistance.

System check screen

N00578400048

When the ignition switch is turned to the “ON” position or the operation mode is put in ON, the system check screen is displayed for approximately 4 seconds. If there is no fault, the information screen is displayed. If there is a fault, the screen changes to warn-

Refer to “Warning display list” on page 5-166.

**Driving range display**

N00575201055

Shows the approximate driving range (how many more miles or kilometers you can drive). When this driving range falls below 30 miles (50 km), “---” is displayed. Refuel immediately.

📖 NOTE

- The driving range is determined based on the fuel consumption data. This may vary depending on the driving conditions and habits. Treat the distance displayed as just a rough guideline.
- When you refuel, the driving range display is updated. However, if you only add a small amount of fuel, the correct value will not be displayed. Fill to a full tank whenever possible.
- When your vehicle is stopped on an extremely steep hill, the driving range value may change. This is due to the movement of fuel in the tank and does not indicate any breakdown.

📖 NOTE

- The display setting can be changed to the preferred units (miles or km). Refer to “Changing the function settings” on page 5-155.

Average fuel consumption display

N00575301027

This displays the average fuel consumption from the last reset to the present.

There are 2 types of mode settings of manual reset and automatic reset.

Refer to “Changing the reset mode for average fuel consumption and average speed” on page 5-157.

For information on how to change the average fuel consumption display setting, refer to “Changing the function settings” on page 5-155.

📖 NOTE

- The average fuel consumption display can be reset separately in both auto reset mode and manual reset mode.
- “---” is displayed when the average fuel consumption cannot be measured.
- The initial (default) setting is “Auto reset mode”.

NOTE

- Average fuel consumption may vary depending on the driving conditions (road conditions, how you drive, etc.) The actual fuel consumption may differ from the fuel consumption displayed, so treat the fuel consumption displayed as just a rough guideline.
- Disconnecting the battery cable will erase from memory the manual reset mode or auto reset mode setting for the average fuel consumption display.
- The display setting can be changed to the preferred units {mpg (US), mpg (UK), L/100km or km/L}. Refer to “Changing the function settings” on page 5-155.

Average speed display

N00578500023

This displays the average speed from the last reset to the present.

There are 2 types of mode setting of manual reset and automatic reset.

Refer to “Changing the reset mode for average fuel consumption and average speed” on page 5-157.

For the method for changing the average speed display setting, refer to “Changing the function settings” on page 5-155.

NOTE

- The average speed display can be reset separately in both auto reset mode and manual reset mode.
- “---” is displayed when the average speed cannot be measured.
- The initial (default) setting is “Auto reset mode”.
- The display setting can be changed to the preferred units (mph or km/h). Refer to “Changing the function settings” on page 5-155.
- Disconnecting the battery cable will erase from memory the manual reset mode or auto reset mode setting for the average speed display.

Instant fuel consumption display

N00578600037

While driving, the instant fuel consumption is shown with a bar graph.

The “” mark in the instant fuel gauge shows the average fuel consumption.

When the instant fuel consumption surpasses the average fuel consumption, the instant fuel consumption is displayed with a green bar graph.

Be conscious of maintaining the instant fuel consumption above the average fuel con-

sumption, it can help you drive with the better fuel consumption.

NOTE

- When the instant fuel consumption cannot be measured, a bar graph is not shown.
- The display setting can be changed to the preferred units {mpg (US), mpg (UK), L/100km or km/L}. Refer to “Changing the function settings” on page 5-155.
- It is possible to cancel the green bar graph. Refer to “Changing the function settings” on page 5-155.

ECO indicator

N00568701032

This indicator will be displayed when fuel-efficient driving is achieved.

ECO Drive Assist

N00578700038

This function displays how fuel-efficiently you are driving under different driving conditions.

The ECO drive assist display will change as follows if you do fuel-efficient driving using the accelerator in a way well matched with the vehicle speed.

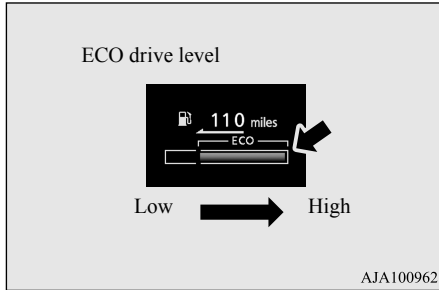

[When the ignition switch is turned to the “OFF” position or the operation mode is put in OFF]

The display shows the overall ECO score the function has counted from the time when the ignition switch is turned to the “ON” position to the time when it is turned to the “OFF” or “ACC” position, or from the time when the operation mode is set to ON to the time when it is set to OFF.

NOTE

- The ECO drive assist is displayed only when vehicle is driven with the selector lever in the “D” (DRIVE) position or when vehicle is driven in the sport mode (for vehicles equipped with sportronic steering wheel paddle shifter).

ECO Score

N00578800055

ECO score indicates the points you have scored on fuel-efficient driving by the number of leaves as follows:

[When the ignition switch or the operation mode is ON]

The display shows the score you achieved in the last several minutes.

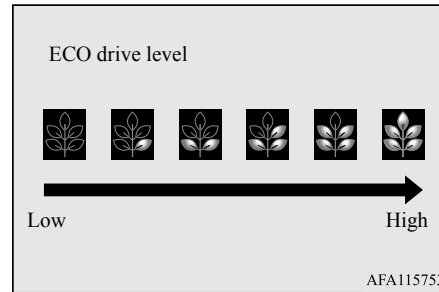

Changing the function settings

N00556801368

1. Park your vehicle in a safe place.
Firmly apply the parking brake and move the selector lever into the “P” (PARK) position.
2. When you press the ▼ switch or ▲ switch, the information screen switches to the function setting screen.

Refer to “Information screen (With the ignition switch or the operation mode in ON)” on page 5-148.



CAUTION

- For safety, stop the vehicle before operating. While driving, even if you operate the multi-information display switches (☰, ▼, ▲), the function setting screen is not displayed.

3. Press the ☰ switch to switch to the top screen (A) for the menu screens. Then, press the ▼ switch or ▲ switch to switch to the menu screens (B).

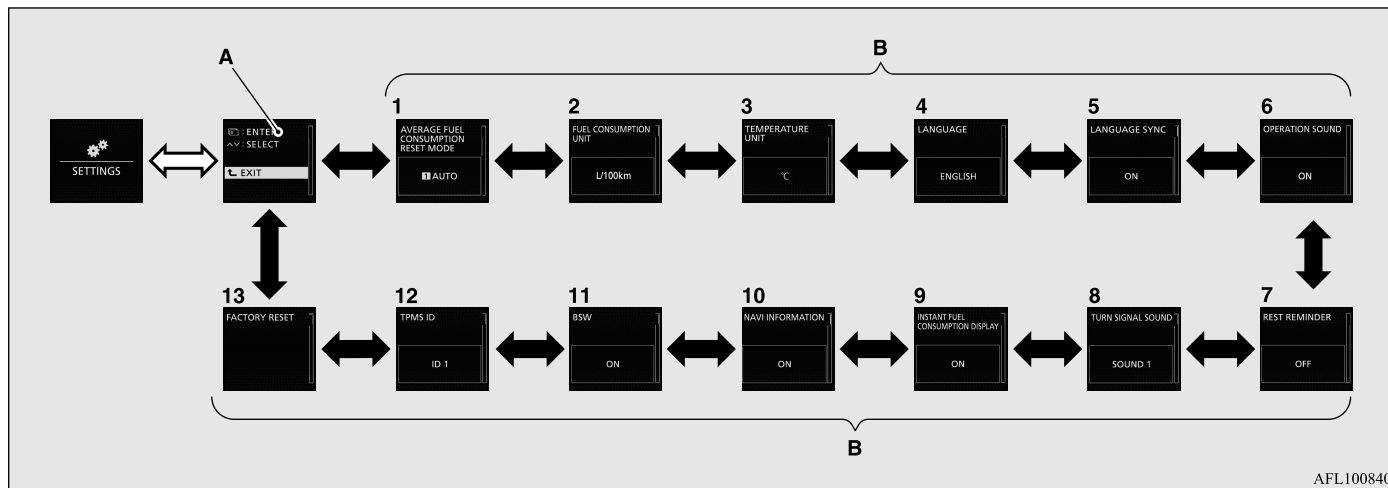

AFL100840

- : switch
- : switch or switch

- 1- Changing the reset mode for average fuel consumption and average speed → P.5-157
- 2- Changing the fuel consumption display unit → P.5-158
- 3- Changing the temperature unit → P.5-158
- 4- Changing the display language → P.5-159

- 5- Changing the language on other system to match the multi-information display (if so equipped) → P.5-160
- 6- Operation sound setting → P.5-160
- 7- Changing the time until “REST REMINDER” is displayed → P.5-161
- 8- Changing the turn signal sound → P.5-161
- 9- Changing the instant fuel consumption display → P.5-161
- 10- Changing the navigation information display (if so equipped) → P.5-162
- 11- Blind Spot Warning (BSW): To operate (if so equipped) → P.5-115

- 12- Tire ID set change → P.5-130
- 13- Returning to the factory settings → P.5-162

NOTE

- If no operations are made within approximately 30 seconds of the menu screen being displayed, the display returns to the function setting screen.

4. After switching to the menu screen (B) for the setting you want to change, press the  switch to switch to the setting selection screen. For further details on the operation methods, refer to the each sections.

NOTE



- If the battery is disconnected, these function settings are reset from memory to the factory settings automatically (except “Blind Spot Warning (BSW): To operate” and “Tire ID set change”).
- You cannot select an item that is displayed dimly on the menu.

Changing the reset mode for average fuel consumption and average speed



N00557001266

You can change the mode condition for the average fuel consumption and average speed display to “Auto reset” or “Manual reset.”

1. Switch to the function setting screen.
Refer to “Changing the function settings” on page 5-155.

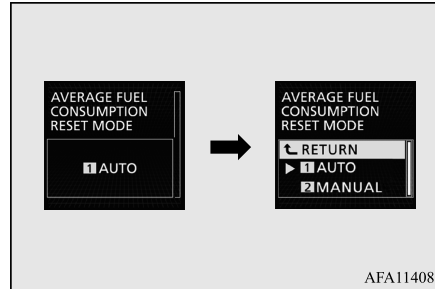
2. Press the  switch or  switch several times to switch to the “AVERAGE FUEL CONSUMPTION RESET MODE” screen. Then, press the  switch to switch to the setting selection screen.



3. Press the  switch or  switch to select the reset mode, and then press the  switch to confirm the setting.
The setting is changed to the selected reset condition.

Manual reset mode

- If you press and hold the  switch when the average fuel consumption and average speed are displayed, these calculations will be reset to zero.

- When the following operation is performed, the mode setting changes automatically from manual to auto.

[Except for vehicles equipped with the F.A.S.T.-key]
Turn the ignition switch to the “ON” position from the “ACC” or “OFF” position.

[For vehicles equipped with the F.A.S.T.-key]
Change the operation mode to ON from ACC or OFF.

Auto reset mode

- When the average fuel consumption and average speed are being displayed, if you press and hold the  switch, these calculations will be reset to zero.
- When the engine switch or the operation mode is in the following conditions, the average fuel consumption display and the average speed display will automatically reset.

[Except for vehicles equipped with the F.A.S.T.-key]
The ignition switch has been set to the “ACC” or “OFF” position for approximately 4 hours or more.

Multi-information display

[For vehicles equipped with the F.A.S.T.-key]

The operation mode has been in ACC or OFF for approximately 4 hours or more.

NOTE



- The average fuel consumption display and average speed display can be reset separately in both auto reset mode and manual reset mode.
- Disconnecting the battery cable will erase from memory the manual reset mode or auto reset mode setting for the average speed display and average fuel consumption display.
- The initial (default) setting is “Auto reset mode”.

Changing the fuel consumption display unit



N00557101238

The fuel consumption display unit can be changed. The distance, speed, and amount units are also changed to match the selected fuel consumption unit.

1. Switch to the function setting screen.
Refer to “Changing the function settings” on page 5-155.

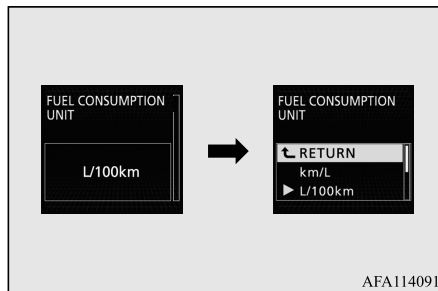
2. Press the  switch or  switch several times to switch to the “FUEL CONSUMPTION UNIT” screen. Then, press the  switch to switch to the setting selection screen.



3. Press the  switch or  switch to select the units, and then press the  switch to confirm the setting.
The setting is changed to the selected unit.

NOTE

- The display units for the driving range, the average fuel consumption, the average speed and the instant fuel consumption are changed, but the units for the indicating needle (speedometer), the odometer and the trip odometer will remain unchanged.
- If the battery is disconnected, the memory of the unit setting is erased and is automatically set to {mpg (US) or L/100 km}.



The distance and speed units are also changed in the following combinations to match the selected fuel consumption unit.

Fuel economy	Distance (driving range)	Speed (average speed)
km /L	km	km /h
L /100 km	km	km /h
mpg (US)	mile (s)	mph
mpg (UK)	mile (s)	mph

Changing the temperature unit

N00557201297

The temperature display unit can be switched.

1. Switch to the function setting screen.
Refer to “Changing the function settings” on page 5-155.
2. Press the  switch or  switch several times to switch to the “TEMPERATURE UNIT” screen. Then, press the  switch to switch to the setting selection screen.

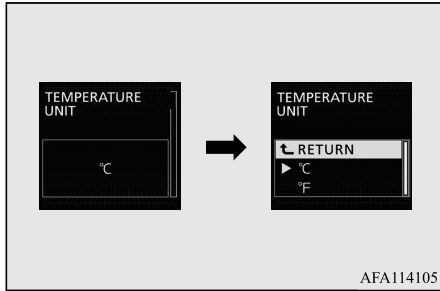

3. Press the switch or switch to select the units, and then press the switch to confirm the setting.
The setting is changed to the selected temperature unit.

NOTE

- The temperature value on air conditioning panel is switched in conjunction with outside temperature display unit of the multi-information display.
However, “°F” or “°C” are not shown to temperature display of an air conditioning.

NOTE

- On vehicles equipped with the Smartphone-link Display Audio (SDA) or the Smartphone-link Display Audio (SDA) navigation system, the temperature value shown on the air conditioning screen of audio system is switched in conjunction with outside temperature display unit of the multi-information display.
However, “°F” or “°C” are not shown to the air conditioning screen of audio system.
- If the battery is disconnected, the memory of the unit setting is erased and is automatically set to °F (°C).

Changing the display language

N00557301201

The language of the multi-information display can be changed.

1. Switch to the function setting screen.
Refer to “Changing the function settings” on page 5-155.
2. Press the switch or switch several times to switch to the “LANGUAGE” screen.
Then, press the switch to switch to the setting selection screen.

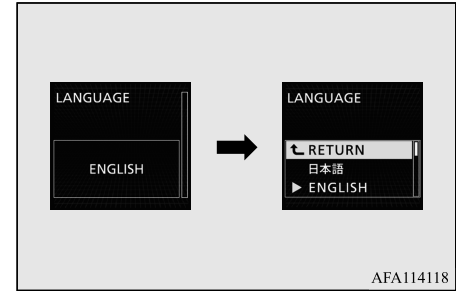

3. Press the switch or switch to select the desired language, and then press the switch to confirm the setting.
The setting is changed to the selected language.

NOTE

- If the battery is disconnected, the memory of the language setting is erased and is automatically set to ENGLISH.
- If “---” is selected in the language setting, a warning message is not displayed when there is a warning display or interrupt display.

Changing the language on other system to match the multi-information display (if so equipped)

N00529801360

The language used in Multi Around Monitor (if so equipped) or Head Up Display (HUD) (if so equipped) can be changed automatically to the same language as that shown in the multi-information display.

5

1. Switch to the function setting screen. Refer to “Changing the function settings” on page 5-155.
2. Press the \blacktriangledown switch or \blacktriangle switch several times to switch to the “LANGUAGE SYNC” screen. Then, press the ☰ switch to switch to the setting selection screen.

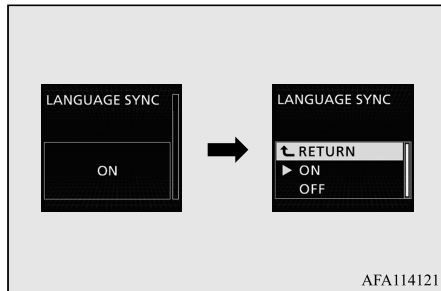

3. Press the \blacktriangledown switch or \blacktriangle switch to select the setting, and then press the ☰ switch to confirm the setting.

NOTE

- If the battery is disconnected, the language cooperative control is automatically set to “ON” (language cooperation: enabled).
- The language cooperation setting can be switched in the following manner.
 - When “ON” (language cooperation: enabled) has been selected, the language for Multi Around Monitor (if so equipped) or Head Up Display (HUD) (if so equipped) is automatically changed to the language selected for the multi-information display. However, this changing function may not work depending on the language selected for the multi-information display.
 - When “OFF” (language cooperation: disabled) has been selected, the language for Multi Around Monitor (if so equipped) or Head Up Display (HUD) (if so equipped) is not automatically changed to match the language selected for the multi-information display.
- The language on the audio system’s display does not automatically change when you select “ON” (language cooperation: enabled) in the language cooperation control.

Operation sound setting

N00557401172

You can change the operation sounds of the multi-information display switches and rheostat illumination button.

1. Switch to the function setting screen. Refer to “Changing the function settings” on page 5-155.
2. Press the \blacktriangledown switch or \blacktriangle switch several times to switch to the “OPERATION SOUND” screen. Then, press the ☰ switch to switch to the setting selection screen.

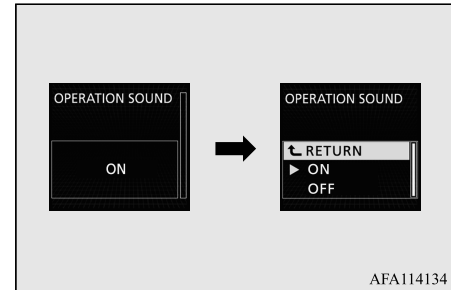

3. Press the \blacktriangledown switch or \blacktriangle switch to select the sound, and then press the ☰ switch to confirm the setting. The setting is changed to the selected condition.

NOTE

- If the battery is disconnected, the memory of the operation sound setting is erased and is automatically set to ON (operation sound on).
- The operation sound setting only deactivates the operation sound of the multi-information display switches and rheostat illumination button. The warning display and other sounds cannot be deactivated.

Changing the time until “REST REMINDER” is displayed

N00557501186

The time until the display appears can be changed.

1. Switch to the function setting screen.
Refer to “Changing the function settings” on page 5-155.
2. Press the \blacktriangledown switch or \blacktriangle switch several times to switch to the “REST REMINDER” screen. Then, press the ☰ switch to switch to the setting selection screen.

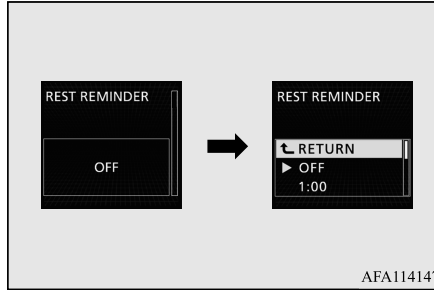

AFA114147

3. Press the \blacktriangledown switch or \blacktriangle switch to select the time, and then press the ☰ switch to confirm the setting.
The setting is changed to the selected time.

NOTE

- If the battery is disconnected, the memory of the unit setting is erased and is automatically set to the “OFF”.
- The drive time is reset when the ignition switch is in the “OFF” position or the operation mode is in OFF.

Changing the turn signal sound

N00563501107

It is possible to change the turn signal sound.

1. Switch to the function setting screen.

Refer to “Changing the function settings” on page 5-155.

2. Press the \blacktriangledown switch or \blacktriangle switch several times to switch to the “TURN SIGNAL SOUND” screen. Then, press the ☰ switch to switch to the setting selection screen.

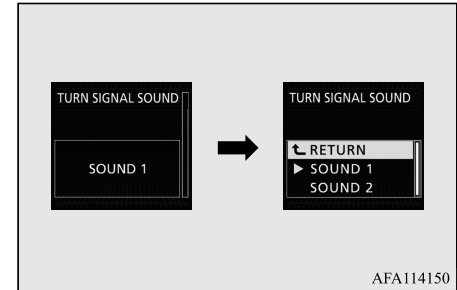

AFA114150



3. Press the \blacktriangledown switch or \blacktriangle switch to select the sound, and then press the ☰ switch to confirm the setting.
The setting changes to the selected turn signal sound.

Changing the instant fuel consumption display



N00563601052

It is possible to change the bar graph setting of the instant fuel consumption display.

Multi-information display

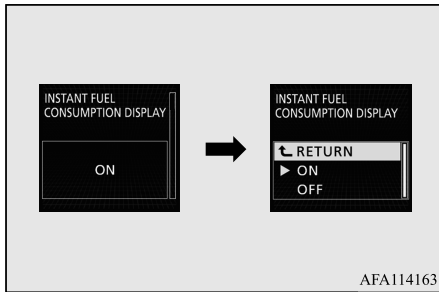
1. Switch to the function setting screen.
Refer to “Changing the function settings” on page 5-155.
2. Press the  switch or  switch several times to switch to the “INSTANT FUEL CONSUMPTION DISPLAY” screen. Then, press the  switch to switch to the setting selection screen.





3. Press the  switch or  switch to select the setting, and then press the  switch to confirm the setting.
The setting changes to the selected bar graph setting.

Changing the navigation information display (if so equipped)



N00594400033

On vehicles equipped with the SDA navigation system, you can select whether to display

the navigation information on the information screen.

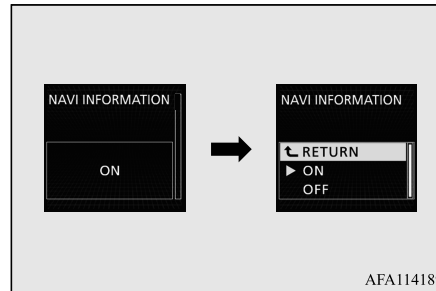
1. Switch to the function setting screen.
Refer to “Changing the function settings” on page 5-155.
2. Press the  switch or  switch several times to switch to the “NAVI INFORMATION” screen. Then, press the  switch to switch to the setting selection screen.





3. Press the  switch or  switch to select the setting, and then press the  switch to confirm the setting.
The setting is changed to the selected navigation information display setting.



Returning to the factory settings

N00557601291

Many of the function settings can be returned to their factory settings.

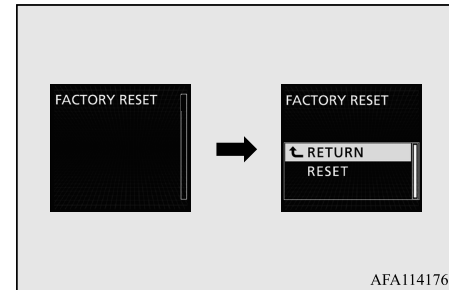
1. Switch to the function setting screen.
Refer to “Changing the function settings” on page 5-155.
2. Press the  switch or  switch several times to switch to the “FACTORY RESET” screen. Then, press the  switch to switch to the setting selection screen.



3. Press the  switch or  switch to select “RESET”, and then press and hold the  switch for approximately 5 seconds or more to confirm the setting.

The buzzer sounds and all of the function settings are returned to the factory settings.

 **NOTE**

- The factory settings are as follows.
 - “AVERAGE FUEL CONSUMPTION RESET MODE”: AUTO
 - “FUEL CONSUMPTION UNIT”: mpg (US) or (L/100 km)
 - “TEMPERATURE UNIT”: °F (Fahrenheit) or °C (Celsius)
 - “LANGUAGE”: ENGLISH
 - “LANGUAGE SYNC”: ON
 - “OPERATION SOUND”: ON
 - “REST REMINDER”: OFF
 - “TURN SIGNAL SOUND”: SOUND 1
 - “INSTANT FUEL CONSUMPTION DISPLAY”: ON
 - “NAVI INFORMATION”: ON
- “BSW” and “TPMS ID” cannot be returned to their factory settings.

Indicator light, warning light, and information screen display list

N00557701090

Indicator and warning light list

N00557801440

5

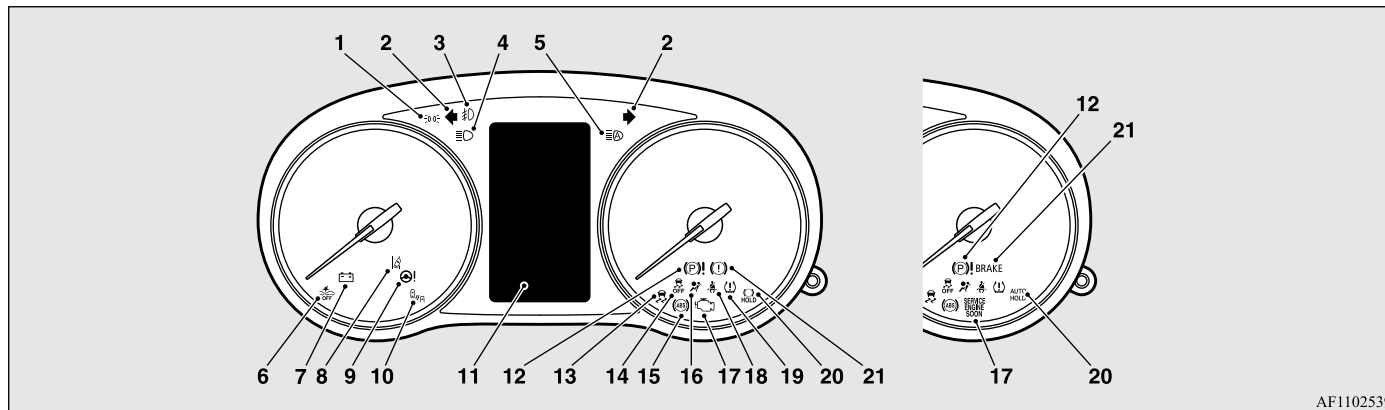

AF1102539

- | | | |
|--|---|---|
| 1- Position indicator → P.5-185 | 7- Charging system warning light → P.5-188 | 12- Electric parking brake warning light (if so equipped) → P.5-186 |
| 2- Turn signal indicators/hazard warning lights → P.5-185 | 8- Lane Departure Warning (LDW) indicator (if so equipped) → P.5-123 | 13- Active stability control (ASC) indicator → P.5-86 |
| 3- Front fog light indicator (if so equipped) → P.5-185 | 9- Electric power steering system (EPS) warning light → P.5-84 | 14- Active stability control (ASC) OFF indicator → P.5-86 |
| 4- High beam indicator → P.5-185 | 10- Blind Spot Warning (BSW) indicator light (if so equipped) → P.5-114 | 15- Anti-lock braking system warning light → P.5-82 |
| 5- Automatic High Beam (AHB) indicator (if so equipped) → P.5-198 | 11- Information screen display → P.5-165 | 16- Supplemental Restraint System (SRS) warning light → P. 4-37 |
| 6- Forward Collision Mitigation system (FCM) OFF indicator → P.5-109 | | |

- 17- Engine malfunction indicator (“SERVICE ENGINE SOON” or “Check engine light”) → P.5-187
- 18- Seat belt reminder/warning light → P.4-17
- 19- Tire pressure monitoring system warning light → P.5-127
- 20- Brake auto hold indicator (if so equipped) → P.5-77
- 21- Brake warning light → P.5-186

Information screen display

N00557901148

When there is information to be announced, such as light reminder, the tone sounds and the screen switches to the displays shown below.

Refer to the appropriate page and take the necessary measures.

When the cause of the warning display is eliminated, the warning display goes out automatically.

Refer to “Warning display list” on page 5-166.

Refer to “Navigation information display” on page 5-181.





Refer to “Other interrupt displays” on page 5-182.





NOTE

- In the following cases, a warning may be displayed on the information screen and the buzzer may sound for a few seconds, at times. This is caused by the system picking up interference such as strong electromagnetic waves or noise, and is not a functional problem.
 - An extremely strong electromagnetic wave is received from a source such as an illegal radio set, a spark from a wire, or a radar station.
 - Abnormal voltage or a static electricity discharge is generated by the operation of your vehicle’s electronics (including after-market parts).
- If the warning display has occurred a number of times, take your vehicle to an authorized Mitsubishi Motors dealer or a repair facility of your choice and have the system checked.





Warning display list





N00558001478

Screen	Cause	Do this (Reference)
<div data-bbox="24 311 73 353" style="background-color: black; color: white; padding: 2px 5px; font-weight: bold;">5</div>  <p data-bbox="152 311 302 334">REMOVE KEY</p>	<ul style="list-style-type: none"> You have forgotten to remove the key from the ignition switch. 	<ul style="list-style-type: none"> Remove the key. Refer to “Key reminder system (except for vehicles equipped with the F.A.S.T.-key)” on page 5-36.
 <p data-bbox="142 464 318 487">TURN OFF LIGHTS</p>	<ul style="list-style-type: none"> You have forgotten to turn off the lights. 	<p>Refer to “Light auto-cutout function (headlights and other lights)” on page 5-197.</p>
 <p data-bbox="131 614 326 637">LOW WASHER FLUID</p>	<ul style="list-style-type: none"> The washer fluid is running low. 	<ul style="list-style-type: none"> Replenish the container with washer fluid. Refer to “Washer fluid” on page 9-9. Refer to “Capacity” on page 11-7.
	<ul style="list-style-type: none"> The system has received the customer key programming request correctly and is currently processing the registration request. 	<p>Refer to “Customer key programming (Except for vehicles sold in Canada)” on page 5-5. Refer to “Customer F.A.S.T.-key programming (Except for vehicles sold in Canada)” on page 5-27.</p>





Screen	Cause	Do this (Reference)
<div data-bbox="168 150 380 288">  <p>KEY BATTERY LOW</p> </div> <div data-bbox="168 291 380 429">  <p>KEY NOT DETECTED</p> </div> <div data-bbox="168 432 380 570">  <p>KEY STILL IN VEHICLE</p> </div> <div data-bbox="168 574 380 711">  <p>CHECK DOORS</p> </div> <div data-bbox="168 715 380 852">  <p>KEYLESS OPERATION SYSTEM SERVICE REQUIRED</p> </div>	<ul style="list-style-type: none"> ● There is a fault in the F.A.S.T.-key. 	<p>Refer to “Free-hand Advanced Security Transmitter (F.A.S.T.-key)” on page 5-13.</p>





Indicator light, warning light, and information screen display list

Screen	Cause	Do this (Reference)
<p>Engine switch is pressed one time</p>  <p>Engine switch is pressed two times or more</p> 	<ul style="list-style-type: none"> ● Although the engine switch was pressed, the F.A.S.T.-key could not be detected. 	<ul style="list-style-type: none"> ● Touch the F.A.S.T.-key to the engine switch. Refer to “If the F.A.S.T.-key is not operating properly” on page 5-25.
	<ul style="list-style-type: none"> ● The engine switch is pressed to stop the engine while the selector lever is in a position other than the “P” (PARK) position. 	<ul style="list-style-type: none"> ● Place the selector lever in the “P” (PARK) position to put the operation mode in OFF.
	<ul style="list-style-type: none"> ● There is a fault in the EPS. 	<ul style="list-style-type: none"> ● Have the vehicle inspected by an authorized Mitsubishi Motors dealer or a repair facility of your choice as soon as possible. Refer to “Electric power steering system (EPS)” on page 5-84.
	<ul style="list-style-type: none"> ● There is a fault in the Anti-lock braking system. 	<ul style="list-style-type: none"> ● Avoid sudden braking and high-speed driving, park the vehicle in a safe place, and take corrective measures. Refer to “Anti-lock braking system warning light / display” on page 5-82.





Screen	Cause	Do this (Reference)
 <p data-bbox="168 238 380 265">LOW TIRE PRESSURE</p>	<ul style="list-style-type: none"> ● The tire pressure in one of the tires (except spare tire) is low. 	<p>Refer to “Tire pressure monitoring system warning light / display” on page 5-127.</p>
 <p data-bbox="168 388 380 414">TIRE PRESSURE MONITOR SERVICE REQUIRED</p>	<ul style="list-style-type: none"> ● There is a fault in the tire pressure monitoring system. 	<p>Refer to “Tire pressure monitoring system warning light / display” on page 5-127.</p>
	<ul style="list-style-type: none"> ● One of the doors or the liftgate is not completely closed. The open door is displayed. 	<ul style="list-style-type: none"> ● Close the door or liftgate. Refer to “Door ajar warning display screen” on page 5-150.
 <p data-bbox="168 691 380 717">CLOSE HOOD</p>	<ul style="list-style-type: none"> ● The engine hood is open. 	<ul style="list-style-type: none"> ● Close the engine hood. Refer to “Engine hood” on page 9-3.
 <p data-bbox="168 842 380 869">IMMOBILIZER SYSTEM SERVICE REQUIRED</p>	<ul style="list-style-type: none"> ● There is a fault in the electronic immobilizer (Anti-theft starting system). 	<ul style="list-style-type: none"> ● Put the operation mode in OFF, and then start the engine again. If the warning is not cancelled, please contact an authorized Mitsubishi Motors dealer or a repair facility of your choice.

Indicator light, warning light, and information screen display list



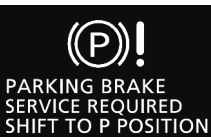

Screen	Cause	Do this (Reference)
	<ul style="list-style-type: none"> ● The driver's door is open when the operation mode is in any mode other than OFF. 	<ul style="list-style-type: none"> ● Put the operation mode in OFF. Refer to "Operation mode ON reminder system (vehicles equipped with F.A.S.T.-key)" on page 5-36.
	<ul style="list-style-type: none"> ● An attempt was made to lock all the doors and the liftgate when the operation mode is in any mode other than OFF. 	<ul style="list-style-type: none"> ● Put the operation mode in OFF. Refer to "Warning activation" on page 5-20.
	<ul style="list-style-type: none"> ● There is a fault in the electrical system. 	<ul style="list-style-type: none"> ● Park your vehicle in a safe place immediately and contact an authorized Mitsubishi Motors dealer or a repair facility of your choice to have the system checked.
	<ul style="list-style-type: none"> ● The engine is overheated. 	<ul style="list-style-type: none"> ● Park the vehicle in a safe place and take corrective measures. Refer to "Engine overheating" on page 8-4.
	<ul style="list-style-type: none"> ● The automatic transaxle or CVT fluid temperature is increased. 	<ul style="list-style-type: none"> ● Park the vehicle in a safe place and take corrective measures. Refer to "Continuously variable transmission (CVT)" on page 5-63.
	<ul style="list-style-type: none"> ● The seat belt is not fastened when the ignition switch or operation mode is in ON. 	<ul style="list-style-type: none"> ● Wear your seat belt properly. Refer to "Driver's seat belt reminder/warning light and display" on page 4-17.

Screen	Cause	Do this (Reference)
 <p>FUEL SYSTEM SERVICE REQUIRED</p>	<ul style="list-style-type: none"> ● There is a fault in the fuel system. 	<ul style="list-style-type: none"> ● Contact an authorized Mitsubishi Motors dealer or a repair facility of your choice to have the system checked.
 <p>RELEASE PARKING BRAKE</p>	<ul style="list-style-type: none"> ● The vehicle is being driven with the parking brake still applied. 	<ul style="list-style-type: none"> ● Release the parking brake. Refer to “Brake warning display” on page 5-188.
 <p>BRAKE SYSTEM SERVICE REQUIRED</p>	<ul style="list-style-type: none"> ● The brake fluid level is low. ● There is a fault in the brake system. 	<ul style="list-style-type: none"> ● Park the vehicle in a safe place and inspect it. ● If the light still illuminates after the inspection, contact an authorized Mitsubishi Motors dealer or a repair facility of your choice for assistance immediately. Refer to “Brake warning display” on page 5-188.
 <p>PARKING BRAKE SERVICE REQUIRED</p>	<ul style="list-style-type: none"> ● There is a fault in the Electric parking brake. 	<ul style="list-style-type: none"> ● Immediately have your vehicle inspected at an authorized Mitsubishi Motors dealer. Refer to “Electric parking brake” on page 5-51.
 <p>PARKING BRAKE TEMPORARILY NOT AVAILABLE</p>	<ul style="list-style-type: none"> ● The parking brake cannot be applied temporarily due to repeated operation of the Electric parking brake switch within a short time. 	<p>Refer to “Electric parking brake” on page 5-51.</p>





Indicator light, warning light, and information screen display list

Screen	Cause	Do this (Reference)
	<ul style="list-style-type: none"> You try to release the Electric parking brake switch without depressing the brake pedal. 	<p>Refer to “Electric parking brake” on page 5-51.</p>
	<ul style="list-style-type: none"> The Electric parking brake has been automatically applied. 	<p>Refer to “Brake auto hold” on page 5-77.</p>
	<ul style="list-style-type: none"> The brake auto hold is automatically cancelled. 	<p>Refer to “Brake auto hold” on page 5-77.</p>
	<ul style="list-style-type: none"> There is a fault in the Electric parking brake system or the brake auto hold system. The brake auto hold cannot be used. 	<ul style="list-style-type: none"> Contact an authorized Mitsubishi Motors dealer to have the system checked. <p>Refer to “Brake auto hold” on page 5-77.</p>
	<ul style="list-style-type: none"> The Electric parking brake is not automatically applied because there is a fault in the Electric parking brake system. 	<ul style="list-style-type: none"> When the operation mode is put in OFF, place the selector lever in the “P” (PARK) position and depress the brake pedal more firmly than usual with the right foot. Then, operate the engine switch. Contact an authorized Mitsubishi Motors dealer or a repair facility of your choice to have the system checked. <p>Refer to “Brake auto hold” on page 5-77.</p>

5





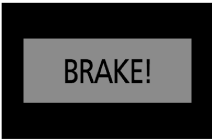
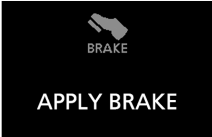

Screen	Cause	Do this (Reference)
 PUSH SWITCH AFTER FASTENING SEAT BELT	<ul style="list-style-type: none"> The brake auto hold system does not turn on because the driver's seat belt is not fastened. 	<ul style="list-style-type: none"> Press the brake auto hold switch after fastening the driver's seat belt. Refer to "Brake auto hold" on page 5-77.
 BRAKE PUSH SWITCH WHILE APPLYING BRAKE	<ul style="list-style-type: none"> The brake auto hold system does not turn off because the brake pedal is not pressed. 	<ul style="list-style-type: none"> Depress the brake pedal more firmly than usual with the right foot. Then, press the brake auto hold switch. Refer to "Brake auto hold" on page 5-77.
 LOW OIL PRESSURE	<ul style="list-style-type: none"> There is a fault in the engine oil circulation system. 	<ul style="list-style-type: none"> Park your vehicle in a safe place immediately and contact an authorized Mitsubishi Motors dealer or a repair facility of your choice to have the system checked. Refer to "Oil pressure warning display" on page 5-189.
 CHARGING SYSTEM SERVICE REQUIRED	<ul style="list-style-type: none"> There is a fault in the charging system. 	<ul style="list-style-type: none"> Park your vehicle in a safe place immediately and contact an authorized Mitsubishi Motors dealer or a repair facility of your choice for assistance. Refer to "Charging system warning display" on page 5-189.
 AIRBAG SYSTEM SERVICE REQUIRED	<ul style="list-style-type: none"> There is a fault in the SRS airbag or the pre-tensioner system. 	<ul style="list-style-type: none"> Contact an authorized Mitsubishi Motors dealer or a repair facility of your choice to have the system checked, immediately. Refer to "SRS warning light/display" on page 4-37.

Indicator light, warning light, and information screen display list





Screen	Cause	Do this (Reference)
<div data-bbox="120 216 337 357">  <p>ASC SYSTEM SERVICE REQUIRED</p> </div>	<ul style="list-style-type: none"> ● There is a fault in the active stability control (ASC). 	<ul style="list-style-type: none"> ● Contact an authorized Mitsubishi Motors dealer or a repair facility of your choice to have the system checked. Refer to “Active stability control (ASC)” on page 5-85.
	<ul style="list-style-type: none"> ● There is a fault in the hill start assist. 	<ul style="list-style-type: none"> ● Have the vehicle checked at an authorized Mitsubishi Motors dealer or a repair facility of your choice. Refer to “Hill start assist” on page 5-79.
<div data-bbox="120 440 337 580">  <p>4WD SYSTEM SERVICE REQUIRED</p> </div>	<ul style="list-style-type: none"> ● There is a fault in the S-AWC system. 	<ul style="list-style-type: none"> ● Contact an authorized Mitsubishi Motors dealer or a repair facility of your choice to have the system checked. Refer to “S-AWC (Super-All Wheel Control)” on page 5-70.
<div data-bbox="120 599 337 739">  <p>TRANSMISSION SERVICE REQUIRED</p> </div>	<ul style="list-style-type: none"> ● There is a fault in the CVT. 	<ul style="list-style-type: none"> ● Contact an authorized Mitsubishi Motors dealer or a repair facility of your choice to have the system checked immediately. Refer to “Continuously variable transmission (CVT)” on page 5-63.
<div data-bbox="120 751 337 891">  <p>4WD SYSTEM OVERHEATING SLOW DOWN</p> </div>	<ul style="list-style-type: none"> ● The S-AWC system is hot. 	<p>Refer to “S-AWC (Super-All Wheel Control)” on page 5-70.</p>
<div data-bbox="120 905 337 1045">  <p>REFUEL</p> </div>	<ul style="list-style-type: none"> ● The fuel is running low. 	<ul style="list-style-type: none"> ● Refuel immediately. Refer to “Fuel remaining display screen” on page 5-150.

Screen	Cause	Do this (Reference)
 <p>POSSIBLE ICY ROADS</p>	<ul style="list-style-type: none"> ● The outside temperature is 37 °F (3 °C) or less. 	<ul style="list-style-type: none"> ● Be careful driving on frozen ground. ● The ground may be frozen even when this warning is not displayed, so drive carefully.
 <p>BRAKE!</p>	<ul style="list-style-type: none"> ● The Adaptive Cruise Control System (ACC) has detected the approach of the vehicles in front. ● The Forward Collision Mitigation system (FCM) has detected the danger of collision. 	<ul style="list-style-type: none"> ● Increase the following distance by depressing the brake pedal or marking other decelerating control. Refer to “Approach alarm” on page 5-97. ● Take appropriate action such as depressing the brake to avoid collision. Refer to “Forward collision warning function” on page 5-106.
 <p>APPLY BRAKE</p>	<ul style="list-style-type: none"> ● The Electric parking brake cannot be applied automatically. 	<ul style="list-style-type: none"> ● Depress the brake pedal as soon as possible. Refer to “Brake auto hold” on page 5-77.



Indicator light, warning light, and information screen display list

Screen	Cause	Do this (Reference)
 <p>ACC READY TO RESUME</p>	<ul style="list-style-type: none"> ● The Adaptive Cruise Control System (ACC) control is active. 	<p>Refer to “How to use ACC” on page 5-94.</p>
 <p>ACC CANCELLED</p>	<ul style="list-style-type: none"> ● The Adaptive Cruise Control System (ACC) control is automatically canceled and the system is placed in the standby state. 	
 <p>ACC NOT AVAILABLE NOW</p>	<ul style="list-style-type: none"> ● Conditions for the start of control are not met, the Adaptive Cruise Control System (ACC) cannot start the control. 	
 <p>ACC OUT OF SPEED RANGE</p>	<ul style="list-style-type: none"> ● The Adaptive Cruise Control System (ACC) cannot start the control because the speed is out of speed range. 	
 <p>ACC NO FORWARD VEHICLE</p>	<ul style="list-style-type: none"> ● The Adaptive Cruise Control System (ACC) cannot start the control because not detected the approach of the vehicles in front. 	
 <p>ACC TEMPORARILY NOT AVAILABLE</p>	<ul style="list-style-type: none"> ● The Adaptive Cruise Control System (ACC) is temporarily unavailable due to conditions such as the adhesion of contaminants to the sensor. This is not a malfunction. 	

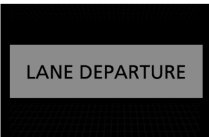
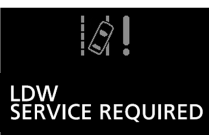

5

Screen	Cause	Do this (Reference)
 <p>ACC SERVICE REQUIRED</p>	<ul style="list-style-type: none"> ● There is a fault in the Adaptive Cruise Control System (ACC). 	<ul style="list-style-type: none"> ● Contact an authorized Mitsubishi Motors dealer or a repair facility of your choice to have the system checked. Refer to “When ACC detects a vehicle in front within the set distance” on page 5-96.
 <p>ACC RADAR BLOCKED</p>	<ul style="list-style-type: none"> ● Foreign objects, such as dirt, snow or ice, adhere to the bumper surface around the sensor. 	<ul style="list-style-type: none"> ● Remove a foreign object on the bumper surface around the sensor. When the warning display does not disappear after having cleaned the bumper surface around the sensor, contact an authorized Mitsubishi Motors dealer or a repair facility of your choice. Refer to “To cancel ACC control” on page 5-100.
 <p>FCM SERVICE REQUIRED</p>	<ul style="list-style-type: none"> ● There is a fault in the Forward Collision Mitigation system (FCM). 	<ul style="list-style-type: none"> ● Contact an authorized Mitsubishi Motors dealer or a repair facility of your choice to have the system checked. Refer to “System problem warning” on page 5-110.
 <p>FCM RADAR BLOCKED</p>	<ul style="list-style-type: none"> ● Foreign objects, such as dirt, snow or ice, adhere to the bumper surface around the sensor. 	<ul style="list-style-type: none"> ● Remove a foreign object on the bumper surface around the sensor. When the warning display does not disappear after having cleaned the bumper surface around the sensor, contact an authorized Mitsubishi Motors dealer or a repair facility of your choice. Refer to “System problem warning” on page 5-110.
 <p>FCM BRAKE ACTIVATED</p>	<ul style="list-style-type: none"> ● FCM braking function of the Forward Collision Mitigation system (FCM) has been activated. 	<ul style="list-style-type: none"> Refer to “FCM braking function” on page 5-107.



Indicator light, warning light, and information screen display list

Screen	Cause	Do this (Reference)
 <p>FCM TEMPORARILY NOT AVAILABLE</p>	<ul style="list-style-type: none"> The Forward Collision Mitigation system (FCM) is temporarily unavailable for some reason. This is not a malfunction. 	<p>Refer to “System problem warning” on page 5-110.</p>
 <p>LANE DEPARTURE</p>	<ul style="list-style-type: none"> The Lane Departure Warning (LDW) has detected that your vehicle is about to leave or has left the lane. 	<p>Refer to “Lane Departure Warning (LDW)” on page 5-123.</p>
 <p>LDW SERVICE REQUIRED</p>	<ul style="list-style-type: none"> There is a fault in the Lane Departure Warning (LDW). 	<ul style="list-style-type: none"> Contact an authorized Mitsubishi Motors dealer or a repair facility of your choice to have the system checked. <p>Refer to “Lane Departure Warning (LDW)” on page 5-123.</p>
 <p>BSW TEMPORARILY NOT AVAILABLE</p>	<ul style="list-style-type: none"> The Blind Spot Warning (BSW) sensor is temporarily not available for some reason such as the environmental condition or increase of the sensor temperature. 	<ul style="list-style-type: none"> When the warning display does not disappear after waiting for a while, contact an authorized Mitsubishi Motors dealer. <p>Refer to “When the sensor is temporarily not available” on page 5-117.</p>
 <p>BSW SERVICE REQUIRED</p>	<ul style="list-style-type: none"> The Blind Spot Warning (BSW) does not operate normally because there are some malfunctions in the system. 	<ul style="list-style-type: none"> Immediately have your vehicle inspected at an authorized Mitsubishi Motors dealer. <p>Refer to “When there is a malfunction in the system” on page 5-117.</p>

5

Screen	Cause	Do this (Reference)
 <p>BSW RADAR BLOCKED</p>	<ul style="list-style-type: none"> Foreign objects, such as dirt, snow or ice, adhere to the bumper surface around the sensor. 	<ul style="list-style-type: none"> Remove a foreign object on the bumper surface around the sensor. When the warning display does not disappear after having cleaned the bumper surface around the sensor, contact an authorized Mitsubishi Motors dealer. Refer to “When there is a foreign object on the sensor” on page 5-118.
 <p>ATTENTION! REAR CROSS TRAFFIC</p>	<ul style="list-style-type: none"> The Rear Cross Traffic Alert (RCTA) is detected the vehicle approaching your vehicle. 	<ul style="list-style-type: none"> Pay special attention to the rear of your vehicle. Refer to “Rear Cross Traffic Alert (RCTA)” on page 5-120.
 <p>DRIVER ASSISTANCE SYSTEM SERVICE REQUIRED</p>	<ul style="list-style-type: none"> There is a fault in the sensor. 	<ul style="list-style-type: none"> Contact an authorized Mitsubishi Motors dealer. Refer to “System problem warning” on page 5-110 in the section entitled “Forward Collision Mitigation system (FCM)”. Refer to “System problem warning” on page 5-125 in the section entitled “Lane Departure Warning (LDW)”. Refer to “System problem warning” on page 5-200 in the section entitled “Automatic High Beam (AHB)”.

Indicator light, warning light, and information screen display list

Screen	Cause	Do this (Reference)
<div data-bbox="29 311 74 353" style="background-color: black; color: white; padding: 2px 5px; font-weight: bold;">5</div>  <p>DRIVER ASSISTANCE SYSTEM TEMPORARILY NOT AVAILABLE</p>	<ul style="list-style-type: none"> ● The Forward Collision Mitigation system (FCM), Lane Departure Warning (LDW) and Automatic High Beam (AHB) are temporarily unavailable due to the high or low temperature of the sensor. 	<ul style="list-style-type: none"> ● After the temperature of the sensor has been in range, the system will automatically return to operation. Refer to “System problem warning” on page 5-110 in the section entitled “Forward Collision Mitigation system (FCM)”. Refer to “System problem warning” on page 5-125 in the section entitled “Lane Departure Warning (LDW)”. Refer to “System problem warning” on page 5-200 in the section entitled “Automatic High Beam (AHB)”.
 <p>DRIVER ASSISTANCE CAMERA BLOCKED</p>	<ul style="list-style-type: none"> ● The sensor is temporarily unavailable due to conditions such as the adhesion of contaminants to the sensor or windshield. This is not a malfunction. 	<p>Refer to “System problem warning” on page 5-110 in the section entitled “Forward Collision Mitigation system (FCM)”.</p> <p>Refer to “System problem warning” on page 5-125 in the section entitled “Lane Departure Warning (LDW)”.</p> <p>Refer to “System problem warning” on page 5-200 in the section entitled “Automatic High Beam (AHB)”.</p>
 <p>AHB SERVICE REQUIRED</p>	<ul style="list-style-type: none"> ● There is a fault in the system of automatic high beam. 	<ul style="list-style-type: none"> ● Contact an authorized Mitsubishi Motors dealer. Refer to “System problem warning” on page 5-200.

Navigation information display (if so equipped)

N00579100071

On vehicles equipped with the Smartphone-link Display Audio (SDA) navigation system, the following information on navigation will be displayed when guidance location such as junction and destination is approached after you set the destination and started the route guidance.

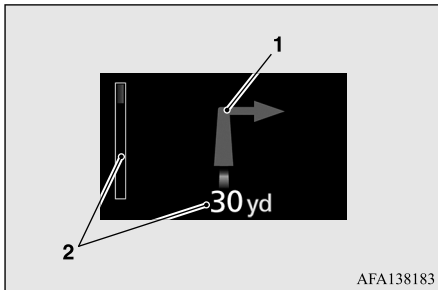

1- Guidance display

Shows the direction of vehicle travel and the guidance location.

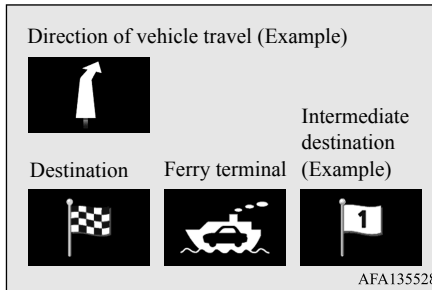

2- Remaining distance display

Shows the distance to the location where the guidance is displayed.

NOTE

- The navigation information display can be turned on or off. Refer to “Changing the navigation information display” on page 5-162.
- Please read this section and also the separate owner’s manual for the SDA navigation system.

Other interrupt displays

N00558201500





5

Screen	Cause	Do this (Reference)
	<ul style="list-style-type: none"> ● When starting the engine, the selector lever is in a position other than the “P” (PARK) or the “N” (NEUTRAL) position, or you pressed the engine switch without depressing the brake pedal. 	<ul style="list-style-type: none"> ● Place the selector lever in the “P” (PARK) position, depress and hold the brake pedal with the right foot, and then press the engine switch to start the engine. Refer to “Starting and stopping the engine” on page 5-23.
	<ul style="list-style-type: none"> ● When communication was successful after the F.A.S.T.-key was touched to the engine switch. 	<p>Refer to “If the F.A.S.T.-key is not operating properly” on page 5-25.</p>





The operation status of each system is displayed on the information screen. For further details, refer to the appropriate page for each system.

 **NOTE**

- When operating each system, confirm that the operation status of the system has changed on the information screen. However, the operation status of the system may not be displayed immediately after the warning display appears even if the system is operated.

Screen	System operation status	Reference
	<ul style="list-style-type: none"> ● When “NORMAL” mode of S-AWC is selected. 	Refer to “S-AWC (Super-All Wheel Control)” on page 5-70.
	<ul style="list-style-type: none"> ● When “SNOW” mode of S-AWC is selected. 	
	<ul style="list-style-type: none"> ● When “GRAVEL” mode of S-AWC is selected. 	
	<ul style="list-style-type: none"> ● When approaching the guidance location, etc. 	Refer to “Navigation information display” on page 5-181.
	<ul style="list-style-type: none"> ● When the ECO mode is activated. 	Refer to “ECO mode switch” on page 5-204.

Indicator light, warning light, and information screen display list

Screen	System operation status	Reference
<div style="display: flex; justify-content: space-around;"> <div style="text-align: center;">  <p>FCM NEAR</p> </div> <div style="text-align: center;">  <p>FCM MIDDLE</p> </div> </div> <div style="text-align: center; margin-top: 20px;">  <p>FCM FAR</p> </div>	<ul style="list-style-type: none"> ● When the Forward Collision Mitigation system (FCM) is activated or the timing of an alarm is changed. 	<p>Refer to “FCM ON/OFF switch” on page 5-109.</p>
<div style="text-align: center;">  <p>OFF</p> </div>	<ul style="list-style-type: none"> ● When the Forward Collision Mitigation system (FCM) is deactivated. 	<p>Refer to “FCM ON/OFF switch” on page 5-109.</p>

5

This informs you that a periodic inspection is due.

Screen	Do this
<div style="text-align: center;">  <p>ROUTINE MAINTENANCE REQUIRED</p> </div>	<p>Have an inspection made by an authorized Mitsubishi Motors dealer. For further details, refer to “Service reminder” on page 5-151.</p>

The rest time can be set.

Screen	Do this
	<p>Park the vehicle in a safe place, turn off the engine, and take a rest. Use this display as rough guide for taking rests during a long drive. The interval from the start of your trip until this message is displayed can be set. Refer to “Changing the function settings” on page 5-155. The display and buzzer alert the driver when the set time is reached. If you continue to drive without having a rest, the buzzer sounds approximately every 5 minutes to encourage you to take a rest.</p> <ul style="list-style-type: none"> ● In the following cases, the time driven is reset and the display returns to the previous display screen. After this, when the set time is reached again, the display and buzzer encourage you to take a rest. <ul style="list-style-type: none"> • The buzzer sounds three times. • The ignition switch is turned to the “OFF” position or the operation mode is put in OFF. • The multi-information display switches are held (for approximately 2 seconds or more).

Indicators

N00519901195

Turn signal indicators/Hazard warning lights

N00520000216

The arrows will flash in time with the corresponding exterior turn signals when the turn signal lever is used.

Both arrows will flash when the hazard warning flasher switch is pressed.

NOTE

- If the indicator flashes faster than usual or if the indicator stays on without flashing, check for a malfunctioning turn signal light bulb or turn signal connection.

High beam indicator

N00520100086

A blue light comes on when the headlights are on high beam.

Front fog light indicator (if so equipped)

N00520201286

This indicator comes on while the front fog lights are on.

Position indicator

N00551301094

This indicator light illuminates while the parking lights are on.

Warning lights

N00520300147

Brake warning light and buzzer

N00520401624

5

This light comes on when the ignition switch is turned to the “ON” position (engine off) or the operation mode is put in ON.

When the engine is started, the light should go off a few seconds later. A warning is also displayed in the multi-information display. The warning light also illuminates after starting the engine under the following conditions.

- When the parking brake is still applied.
- When the brake fluid level is low.
- When the brake system circuit is not working properly.

When the vehicle is moving at more than 5 mph (8 km/h) and parking brake applied, a buzzer will sound to inform the driver that the parking brake is not properly release.

Before driving, be sure that the parking brake is fully released and brake warning light is off.

CAUTION

- If the brake warning light and the Anti-lock braking system warning light are illuminated at the same time, the braking force distribution function will not operate, so the vehicle may be destabilized during sudden braking under the following conditions.
 - When the brake warning light does not go out even when the parking brake is released.
 - When the brake warning light stays on while driving.
 - If the above occurs, avoid sudden braking and high-speed driving. Park the vehicle in a safe place, and contact an authorized Mitsubishi Motors dealer or a repair facility of your choice immediately.
- The vehicle should be brought to a halt in the following manner when brake performance is deteriorated.
 - Confirm that the vehicle slows down when you press down on the brake pedal harder than usual. In some cases, the brake pedal may go all the way to the floor.

CAUTION

- Should the brakes fail, use engine braking to reduce your speed and observe the followings.
[Vehicles with the parking brake of the lever type]
Carefully pull the parking brake lever.
[Vehicles with the Electric parking brake]
Keep pulling the Electric parking brake switch.
Refer to “Electric parking brake” on page 5-51.
- Depress the brake pedal to illuminate the stop lights to alert the vehicles behind you.

Electric parking brake warning light (if so equipped)

N00591200069

This warning light will illuminate when there is a fault in the Electric parking brake system. Normally, this warning light illuminates when the operation mode is put in ON, and goes off in a few seconds.

⚠ CAUTION

- When the warning light remains on or does not come on, there is the possibility that the parking brake cannot be operated or released. Immediately contact the nearest authorized Mitsubishi Motors dealer. When the warning light comes on during driving, immediately stop the vehicle in a safe place, and contact an authorized Mitsubishi Motors dealer. If you inevitably have to park, park the vehicle on level and stable ground, shift the selector lever in “P” (PARK) position and place chocks or blocks.

Engine malfunction indicator (“SERVICE ENGINE SOON” or “Check engine light”)

N00520501902

This indicator is a part of the onboard diagnostic (OBD) system which monitors the emissions, engine control system or continuously variable transmission (CVT) control system. If a problem is detected in one of these systems, this indicator illuminates or flashes. When the ignition switch is turned to the “ON” position or the operation mode is put in ON, this indicator normally comes on and goes off after the engine has started.

This indicator will come on if the fuel tank filler cap is not properly tightened. If this

indicator comes on and stays on after refueling, stop the engine and check that the cap is properly tightened. (Turn the cap clockwise until you hear clicking sounds.)

If this indicator does not go off after several seconds or lights up while driving, have the system checked immediately at an authorized Mitsubishi Motors dealer or a repair facility of your choice.

⚠ CAUTION

- Driving for a long time with the engine malfunction indicator on may cause more damage to the emission control system. This could also affect fuel economy and drivability.
- If this indicator does not come on when the ignition switch is turned to the “ON” position or the operation mode is put in ON, have the system checked at an authorized Mitsubishi Motors dealer or a repair facility of your choice.

⚠ CAUTION

- If the engine malfunction indicator comes on while the engine is running, avoid driving at high speeds. During vehicle operation with the indicator on, the vehicle may not accelerate when you depress the accelerator pedal. When the vehicle is stationary with the indicator on, you must depress the brake pedal more firmly than usual since the engine idling speed is higher than usual and a vehicle with continuously variable transmission (CVT) has a stronger tendency to creep forward.

📖 NOTE

- Do not disconnect the battery cable when the engine malfunction indicator (“SERVICE ENGINE SOON” or “Check engine light”) is on. The engine electronic control module stores critical OBD information (especially exhaust emission data), which may be lost if the battery cable is disconnected while the engine malfunction indicator is on. This will make it difficult to diagnose the cause of future problems.

Charging system warning light

N00520601381

This light comes on in the event of a malfunction in the charging system or when the ignition switch is turned to the “ON” position (engine off) or the operation mode is put in ON. The warning is also displayed in the multi-information display. When the engine is started, the light should go out. Check to make sure that the light has gone out before driving.

CAUTION

- If the warning light stays on while the engine is running, park your vehicle in a safe place immediately and contact an authorized Mitsubishi Motors dealer or a repair facility of your choice to have the system checked.

Information screen display

N00558301077

Brake warning display

N00558401241



This warning is displayed if the vehicle is being driven with the parking brake still applied. The brake warning light in the instrument cluster only comes on when the parking brake is applied.

For details, refer to “Brake warning light and buzzer” on page 5-186.

CAUTION

- If a vehicle is driven without releasing the parking brake, the brakes will overheat, resulting in ineffective braking and possible brake failure.
If this warning is displayed, release the parking brake.



When the ignition switch is turned to the “ON” position or the operation mode is put in ON, if the brake fluid is low, this warning is displayed.

The brake warning light in the instrument cluster also illuminates.

For details, refer to “Brake warning light and buzzer” on page 5-186.

CAUTION

- If this warning stays on and does not go out while driving, there is a danger of ineffective braking. If this happens, park the vehicle in a safe place, and contact an authorized Mitsubishi Motors dealer or a repair facility of your choice immediately.
- If the brake warning display, brake warning light, and the Anti-lock braking system warning light are illuminated at the same time, the braking force distribution function will not operate, so the vehicle may be destabilized during sudden braking. Avoid sudden braking and high-speed driving. Park the vehicle in a safe place, and contact an authorized Mitsubishi Motors dealer or a repair facility of your choice.
- The vehicle should be brought to a halt in the following manner when brake performance is deteriorated.
 - Confirm that the vehicle slows down when you press down on the brake pedal harder than usual. In some cases, the brake pedal may go all the way to the floor.

⚠ CAUTION

- Should the brakes fail, use engine braking to reduce your speed and observe the followings.

[Vehicles with the parking brake of the lever type]

Carefully pull the parking brake lever.

[Vehicles with the Electric parking brake]

Keep pulling the Electric parking brake switch. (Refer to “Electric parking brake” on page 5-51.)

Depress the brake pedal to illuminate the stop lights to alert the vehicles behind you.

Charging system warning display

N00558601168



If there is a fault in the charging system, the warning display is displayed on the information screen in the multi-information display. The charge warning light in the instrument cluster also illuminates.

⚠ CAUTION

- If warnings are displayed while the engine is running, park your vehicle in a safe place immediately and contact an authorized Mitsubishi Motors dealer or a repair facility of your choice to have the system checked.

Oil pressure warning display

N00558701172



If the engine oil pressure drops while the engine is running, the warning display is displayed on the information screen in the multi-information display.

⚠ CAUTION

- If the vehicle is driven while the engine oil is low, or the oil level is normal but the warning is displayed, the engine may overheat and damage may result.
- If the warning is displayed while the engine is running, park your vehicle in a safe place immediately and check the engine oil level.

⚠ CAUTION

- If this warning display comes on when the engine oil level is proper, have your vehicle checked at an authorized Mitsubishi Motors dealer or a repair facility of your choice.

📖 NOTE

- The oil pressure warning display does not show the amount of oil. The oil level must be checked using the dipstick.

Head Up Display (HUD) (if so equipped)

N00594300058

The Head Up Display (HUD) shows information on a transparent display so that you can easily check the following information while looking ahead when driving.

Displayed information:

- Vehicle speed
- Navigation information (if so equipped)
- Auto-speed (cruise) control information
- Adaptive Cruise Control System (ACC) information (if so equipped)

Head Up Display (HUD) (if so equipped)

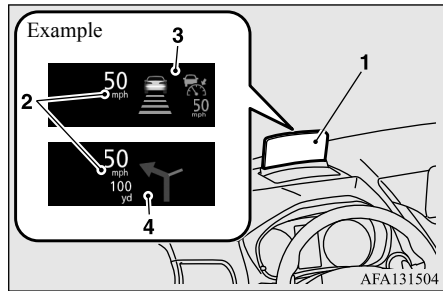

- 1- Display
- 2- Speed display screen
- 3- Information display screen
- 4- Navigation information display screen (if so equipped)

When a warning is displayed on the information screen in the meter, a warning will also be displayed on the HUD.

Examples of displayed warnings:

- Door ajar warning
- Seat belt reminder
- Adaptive Cruise Control System (ACC) warning (if so equipped)
- Forward Collision Mitigation system (FCM) warning
- Lane Departure Warning (LDW) (if so equipped)

Refer to “Indicator light, warning light, and information screen display list” on page 5-164.

WARNING

- Always stop the vehicle in a safe place before operating the HUD. If you operate it while driving, your attention to the road ahead may be affected, resulting in an accident.
- Do not spray water or spill beverages in the HUD. If the switches, wires, or electrical components become wet, they could malfunction or cause a vehicle fire. If you accidentally spill a beverage, wipe up as much liquid as possible and immediately consult an authorized Mitsubishi Motors dealer or a repair facility of your choice.

CAUTION

- When opening or closing the display, do not touch the moving parts. Otherwise, your hands could be caught, resulting in personal injury.
- Do not place any objects near the HUD. The objects could prevent the display from opening or obstruct the opening operation, resulting in a malfunction.
- Never open, close, or adjust the angle of the display manually. Applying a strong force to the display could result in a malfunction.

CAUTION

- Do not affix a sticker, label, etc., to the display. They could block the display or obstruct the opening or closing operation, resulting in a malfunction. Also, the sensor (A) that adjusts the brightness of the display may not function correctly, causing the display to be difficult to see.

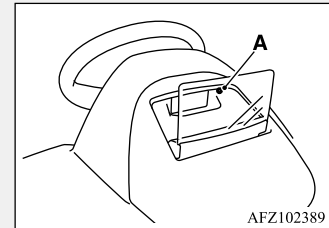

- Do not shine a bright light onto the light-receiving portion of the sensor (A). The sensor could malfunction.
- If you drop an object into the storage space for the display and cannot retrieve it, or if the display was closed while an object was in the storage space and can no longer be opened, contact an authorized Mitsubishi Motors dealer or a repair facility of your choice to have the system checked.

NOTE

- When you are wearing sunglasses, the display may be difficult to see. Remove your sunglasses or adjust the brightness of the display.
Refer to “Adjusting the brightness of the display” on page 5-192.
- If the battery is disconnected or the battery voltage is low, the display will return to the default angle and may be difficult to see. If this occurs, adjust the angle of the display.
Refer to “Adjusting the angle of the display” on page 5-192.
- It may be difficult to see the display depending on the weather conditions (rain, snow, direct sunlight, temperature, etc.). If this occurs, adjust the angle and brightness of the display.
Refer to “Adjusting the angle of the display” on page 5-192 and “Adjusting the brightness of the display” on page 5-192.

Using the HUD

NOTE

- If the display does not open or close when the  switch is pushed, check that there are no objects near the display obstructing its movement. If the display does not open or close even though there are no obstructions, contact an authorized Mitsubishi Motors dealer or a repair facility of your choice to have the system checked.

Opening the display

1. When the operation mode is in ON, push the  switch to open the display.

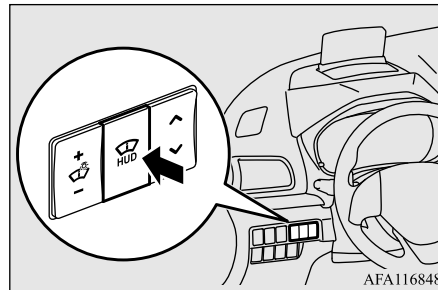

2. The launch screen will be displayed, and then information will be displayed.

NOTE

- If the HUD was open when the operation mode was put in OFF, the HUD will open automatically when the operation mode is put in ON.
- If the HUD was close when the operation mode was put in OFF, the HUD will not open automatically when the operation mode is put in ON.

Closing the display

1. When the display is open, push the  switch.

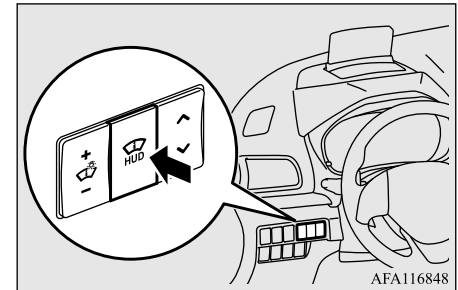

2. The setting top screen will be displayed if the vehicle is stopped, push the switch again.

Head Up Display (HUD) (if so equipped)



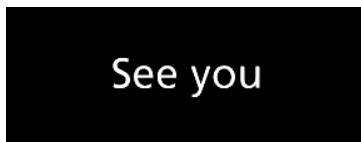

- 5 3. The ending screen will be displayed, and then the display will close.



NOTE



- When the operation mode is put in OFF, the HUD will close automatically.

Adjusting the angle of the display

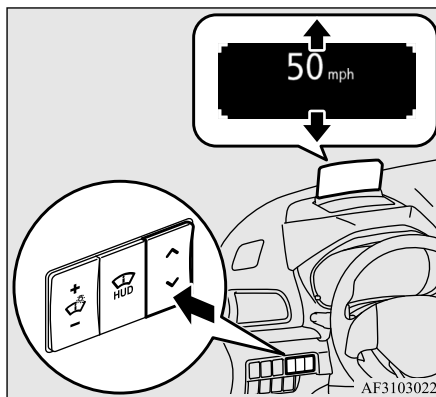
When the display is open, push the  side or  side of the  switch to adjust the angle of the display to raise or lower the position where the information is displayed.



Adjusting the brightness of the display

When the display is open, push the  side or  side of the  switch to change the brightness of the display. The nighttime and daytime brightness can each be adjusted to 16 different levels depending on whether the front side-marker lights are on or off.

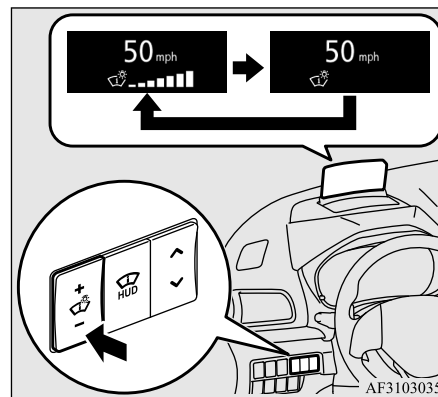

NOTE

- The nighttime and daytime brightness of the display automatically switches depending on whether the front side-marker lights are on or off.
- In addition to manual adjustment, the brightness also automatically switches and adjusts according to the brightness outside the vehicle.

Switching the navigation information display

On vehicles equipped with the Smartphone-link Display Audio (SDA) navigation system,

you can select whether to display the navigation information on the display.

1. To change the display setting, push the  switch when the display is open.

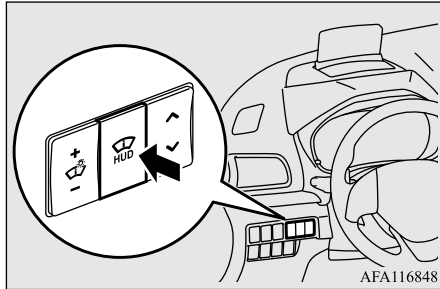



2. The setting top screen will be displayed, push and hold the  switch.



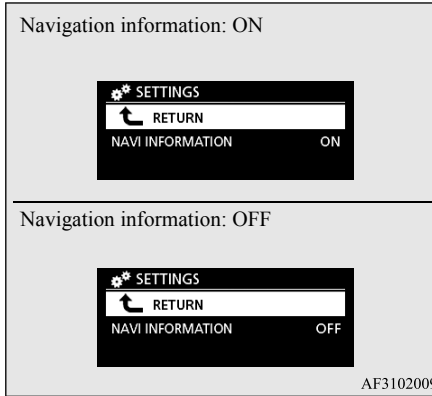



3. The display setting screen will be displayed.

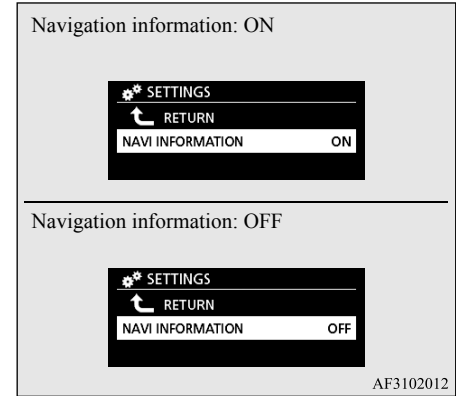
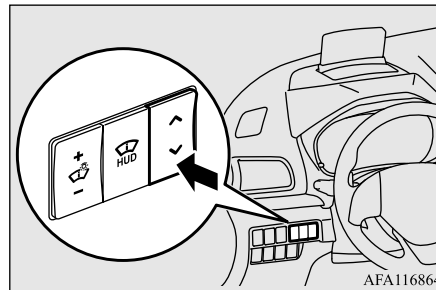



4. Push the  side of the  switch to select “NAVI INFORMATION ON” or “NAVI INFORMATION OFF”, and then push the  switch.



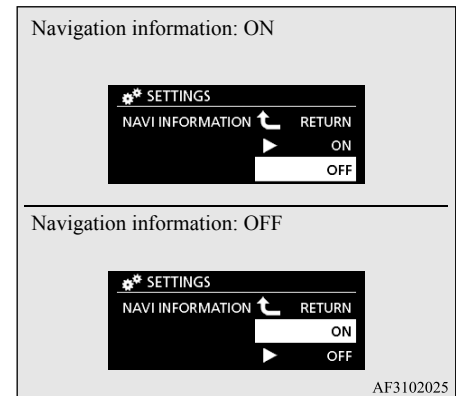

5. Push the  side or  side of the  switch to select “OFF” or “ON”, and then push the  switch.

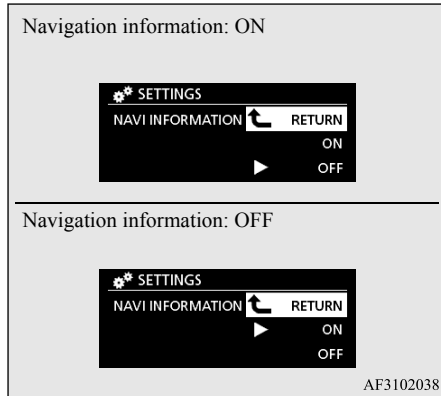

Combination headlights and dimmer switch

6. Push the  side of the  switch to select “RETURN”. Push the  switch to confirm the setting.



7. Push again the  switch while “RETURN” is selected in the setting screen, and the navigation system display will be set to “OFF” or “ON”.

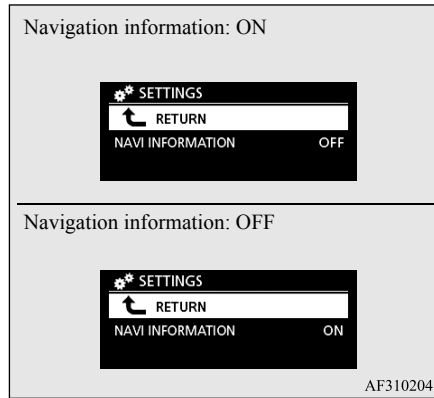

Handling the HUD

A special coating is applied to the display and mirror surface. Use a finely textured, soft cloth, such as an eyeglass cleaning cloth.

CAUTION

- Do not use cleaners or protectants that contain silicone or wax. If these cleaners and protectants are used on the display or mirror surface, the coating could be scratched and come off.

Combination headlights and dimmer switch

N00522502020

Headlights

NOTE

- Do not leave the headlights and other lights on for a long period of time when the engine is not running. The battery will run down.
- When it rains, or when the vehicle has been washed, the inside of the lens sometimes becomes foggy. This is the same as when window glass mists up on a humid day, and does not indicate a problem. When the light is switched on, the heat will dry out the fog. However, if water collects inside the light, have it checked by an authorized Mitsubishi Motors dealer or a repair facility of your choice.

Type 1

Rotate the switch to operate the lights.

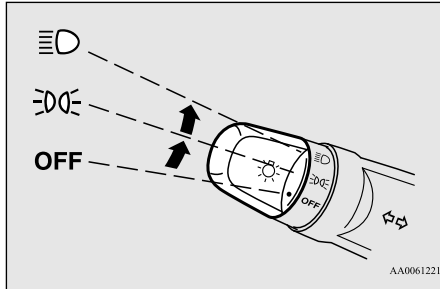

The combinations of switch operations and illuminated lights differ in accordance with the following conditions.

[When the engine is started, and the parking brake is released]

OFF	The daytime running lights illuminated
ACC	The daytime running lights illuminated Tail, front and rear side-marker lights, license plate and instrument panel lights on
ON	Headlights and other lights on

NOTE

- Once the daytime running light come on, they do not go out until the ignition switch is turned to the "OFF" or "ACC" position or the operation mode is changed to OFF or ACC.

[When the engine is not running, or when the engine is running but the parking brake is not released]

The engine starts when the lights are off.

OFF	All lights off
ACC	Parking, tail, front and rear side-marker lights, license plate and instrument panel lights on
ON	Headlights and other lights on

Type 2

Rotate the switch to operate the lights.

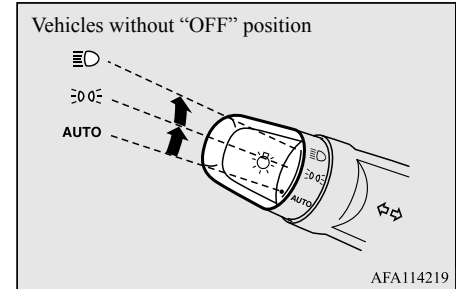
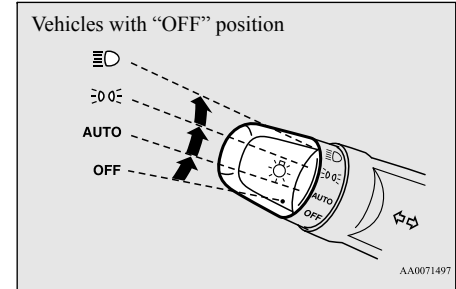



The combinations of switch operations and illuminated lights differ in accordance with the following conditions.

[When the engine is started, and the parking brake is released]

Combination headlights and dimmer switch

5

OFF	The daytime running lights illuminated
AUTO	The daytime running lights illuminated (when it is light outside the vehicle) Headlights and other lights turn on and off automatically in accordance with outside light level.
	The daytime running lights illuminated Tail, front and rear side-marker lights, license plate and instrument panel lights on
	Headlights and other lights on



NOTE

- Once the daytime running light come on, they do not go out until the ignition switch is turned to the “OFF” or “ACC” position or the operation mode is changed to OFF or ACC.

[When the engine is not running, or when the engine is running but the parking brake is not released]

The engine starts when the lights are off.

OFF	All lights off
-----	----------------

AUTO	Headlights and other lights turn on and off automatically in accordance with outside light level.
	Parking, tail, front and rear side-marker lights, license plate and instrument panel lights on
	Headlights and other lights on

NOTE

- On vehicles with an “OFF” position on the light switch, the sensitivity of the automatic on/off control can be adjusted. For further information, please contact your authorized Mitsubishi Motors dealer or a repair facility of your choice.
On vehicles equipped with the Smartphone-link Display Audio (SDA) or the Smartphone-link Display Audio (SDA) navigation system, screen operations can be used to make the adjustment. Refer to the separate owner’s manual for details.
- On vehicles without an “OFF” position on the light switch, when the engine is started while the light switch is in the “AUTO” position, the headlights and other vehicle exterior lights will remain off until the parking brake is released, the selector lever is shifted to a position other than “P” (PARK), or the vehicle starts moving, even if it is dark outside the vehicle.

NOTE

This function is to prevent blinding people who are in the vicinity of the vehicle at night or at other times.

The lights will be illuminated when the parking brake is released, when the selector lever is shifted to a position other than “P” (PARK) or when the vehicle starts moving. If you want to turn off the lights again when the vehicle is stationary, apply the parking brake, put the selector lever in the “P” (PARK) position, and then stop and restart the engine.

This function can be deactivated.

For further information, please contact your authorized Mitsubishi Motors dealer or a repair facility of your choice.

- Do not cover the sensor (A) for the automatic on/off control by affixing a sticker or label to the windshield.

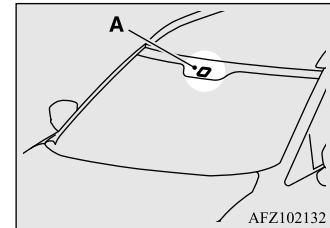

- If the lights do not turn on or off with the switch in the “AUTO” position, manually operate the switch. Have the system checked by an authorized Mitsubishi Motors dealer or a repair facility of your choice.

Light auto-cutout function (headlights and other lights)

N00532601708

- If the following operation is performed with the combination headlights and dimmer switch in the “

[Except for vehicles equipped with the F.A.S.T.-key]

The ignition switch is turned to the “OFF” or “ACC” position or the key is removed from the ignition switch and the driver’s door is opened.

[For vehicles equipped with the F.A.S.T.-key]

The operation mode is changed to OFF or ACC and the driver’s door is opened.

- If the following operation is performed with the combination headlights and dimmer switch in the “

[Except for vehicles equipped with the F.A.S.T.-key]

The ignition switch is turned to the “OFF” or “ACC” position or the key is removed from the ignition switch and the driver’s door is not opened.

[For vehicles equipped with the F.A.S.T.-key]

The operation mode is changed to OFF or ACC and the driver’s door is not opened.

NOTE

- The light auto-cutout function can be deactivated. See your authorized Mitsubishi Motors dealer for details. On vehicles equipped with the SDA or the SDA navigation system, screen operations can be used to make the adjustment. Refer to the separate owner’s manual for details.

When you want to keep the lights on:

If the combination headlights and dimmer switch is turned to the “

Headlight reminder buzzer

N00549801278

[When using a key to start the engine]
If the driver’s door is opened with the key in the “OFF” or “ACC” position or removed from the ignition switch while the lights are on, the tone will sound to remind you to turn off the lights.

[When using the F.A.S.T.-key to start the engine]

If the driver’s door is opened when the operation mode is put in OFF or ACC, or if the operation mode is changed to OFF while the lights are on, the tone will sound to remind you to turn off the lights.

In either case, the lights will turn off automatically and so will the tone. You can also turn the light switch to the “OFF” position (if so equipped) or “AUTO” position (if so equipped) to stop the tone.

Dimmer (high/low beam change)

N00549901178

To change the headlights from high beam to low beam and vice versa, pull the turn signal lever to (1). Switch the headlights to low beam as a courtesy whenever there are oncoming vehicles, or when there is traffic

Combination headlights and dimmer switch

moving ahead of you. An illuminated blue light in the instrument cluster indicates when the headlights are on high beam.

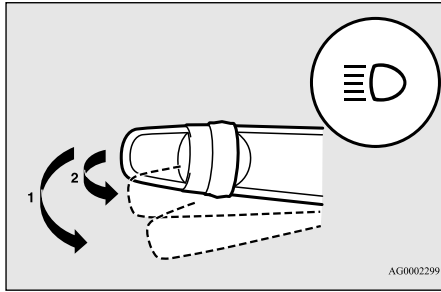

Headlight flasher

N00550001225

You can flash the high beams by pulling the lever gently toward you (2). The lights will go back to normal when you let go. While the high beam is on, you will see a blue light on the instrument panel.

NOTE

- You can flash the high beams by pulling the lever toward you, even if the light switch is off.
- If you turn the lights off with the head lights set to high beam illumination, the headlights are automatically returned to their low beam setting.

Automatic High Beam (AHB) (if so equipped)

N00591300060

The Automatic High Beam (AHB) turns the high beam light on or off automatically according to surrounding light conditions. The sensor (A) detects lights, such as the lights of an oncoming vehicle, a vehicle ahead or street lights.

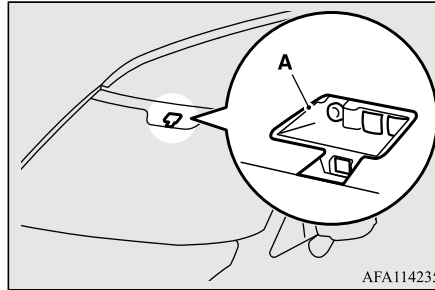

WARNING

- Do not rely solely on the AHB. Always observe surrounding traffic and light conditions. If necessary, manually turn the high beams on or off. Refer to “Dimmer (high/low beam change)” on page 5-197.

How to use the AHB

N00593600100

1. Rotate the light switch to “ D” position or “AUTO” position when the engine is running.
2. Press the AHB switch.
The AHB is activated and the indicator is illuminated.
If the AHB switch is pressed again, the AHB will be deactivated and AHB indicator will go off.

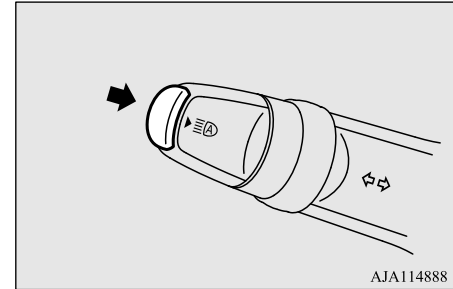

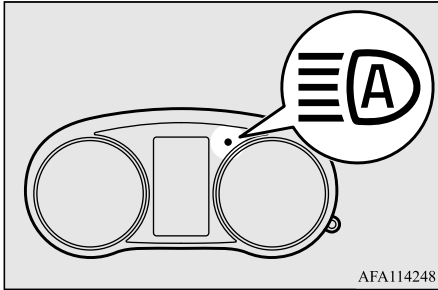

AFA114248

NOTE

- If the headlights are on when the light switch is in the “AUTO” position, the AHB works.
- You can switch the headlight beams (high/low) manually by operating the lever even if the AHB is working. Refer to “Dimmer (high/low beam change)” on page 5-197. If the lever is operated manually, the AHB indicator will go off and the AHB will be deactivated. Refer to “Manual switching” on page 5-199.
- The AHB is not deactivated when you pull the lever slightly (operation of the headlight flasher).

Manual switching

Switching to low beam

1. Pull the turn signal lever toward you.

2. The AHB indicator will go off.
3. The AHB switch is pressed again, the AHB will be activated.

Switching to high beam

1. Pull the turn signal lever toward you.
2. The AHB indicator will go off and the high beam indicator illuminates.
3. The AHB switch is pressed again, the AHB will be activated.

Automatic switching conditions

N00593700055

The high beam headlights illuminate when all of the following conditions are met:

- Your vehicle speed exceeds approximately 33 mph (53 km/h).
- It is dark ahead of your vehicle.
- There are no vehicles in front or oncoming vehicles, or none of their exterior lights are illuminating.

The low beam headlights illuminate when any of the following conditions occur:

- Your vehicle speed does not exceed approximately 28 mph (45 km/h).
- It is bright ahead of your vehicle.
- An exterior light of a vehicle in front or oncoming vehicle is illuminating.

NOTE

- The headlights may not be switched from high beam to low beam under the following circumstances.
 - A vehicle in front or oncoming vehicle is hindered by any object such as continuous bends, elevated median/island, traffic signs, roadside trees.
 - Your vehicle passes an oncoming vehicle suddenly on a bend with poor visibility.
 - Another vehicle crosses ahead of your vehicle.
- The headlights may remain at low beam (or be switched from high beam to low beam) when a reflective object (e.g. street light, traffic signal, noticeboard and signboard) reflects light.
- Any of the following factors may influence the headlight beam switching timing:
 - How brightly the exterior lights of a vehicle in front or oncoming vehicle illuminate.
 - Movement or direction of a vehicle in front or oncoming vehicle.
 - Only right or left exterior light of a vehicle in front or oncoming vehicle is illuminating.
 - A vehicle in front or oncoming vehicle is a motorcycle.
 - Road conditions (gradient, bends and road surface).
 - The number of occupants and luggage load.

 **NOTE**

- The AHB recognizes environmental conditions by sensing a light source ahead of your vehicle. Therefore, you may feel like something is not quite right when the headlight beams are switched automatically.
- The system may not detect a light vehicle such as a bicycle.
- The system may not detect an ambient brightness precisely. This causes the traffic to be dazzled by high beam or the low beam to be maintained. In such cases, you should switch the headlight beams manually.
 - In bad weather (heavy rain, fog, snow or sandstorm).
 - The windshield is dirty or fogged up.
 - The windshield is cracked or broken.
 - The sensor is deformed or dirty.
- A light, which is similar to the headlights or tail lights, is shining around your vehicle.
- A vehicle in front or oncoming vehicle is driven without lights, the exterior lights are dirty or discolored, or the direction of the headlight beams is adjusted improperly.
- It becomes dark and bright suddenly and continuously around your vehicle.
- Your vehicle is driven on uneven surfaces.
- Your vehicle is driven on a winding road.
- A reflective object such as a noticeboard or a mirror reflects a light ahead of your vehicle.

 **NOTE**

- When lights of the vehicle in front or headlights of an oncoming vehicle blend into the other lights.
- The rear end of a vehicle in front (such as a container truck) reflect a strong light.
- Your vehicle's headlight is broken or dirty.
- Your vehicle is inclined due to a flat tire or towing.
- The warning display appears.
(Refer to “System problem warning” on page 5-200.)
- Observe the precautions below to maintain good usage conditions:
 - Do not attempt to disassemble the sensor.
 - Do not affix a sticker or label on the windshield near the sensor.
 - Avoid overload.
 - Do not modify your vehicle.
 - When the windshield is replaced, use the Mitsubishi Motors genuine parts.

To adjust the sensitivity of the sensor

The sensitivity of the sensor can be temporarily lowering in the following ways.

1. Park your vehicle in a safe place and the ignition switch is turned to the “OFF” position or the operation mode is put in OFF.

2. Press the AHB switch more than 15 times within 5 seconds after operation mode is turned on.

System problem warning

N00593800102

If a problem occurs with the system, the following warning display will appear to the type of the problem.

■ **The AHB deactivation due to fault**

If a failure is detected in the system, the following warning display will appear and the AHB will automatically be turned off. If the warning display remains even after the ignition switch is turned to the “OFF” position or the operation mode is put in OFF and then turned back to ON, please contact an authorized Mitsubishi Motors dealer.

[When the AHB is malfunctioning]



[When the sensor is malfunctioning]



NOTE

- If the sensor or its surrounding area becomes extremely high temperature when parking the vehicle under a blazing sun, the “AHB SERVICE REQUIRED” warning display may appear.
If the message remains even after the temperature of the sensor or its surrounding area has been in range, please contact an authorized Mitsubishi Motors dealer.

■ **Sensor is too hot or cold**

If the system becomes temporarily unavailable due to the high or low temperature of the sensor, the following warning display will appear.

After the temperature of the sensor has been in range, the system will automatically return to operation.

If the warning display does not disappear after waiting for a while, there is a possibility that the AHB has a malfunction. Contact an authorized Mitsubishi Motors dealer for inspection of the system.



■ **Windshield is dirty**

If the AHB determines that its performance has been degraded, the warning display will appear.

This can occur when:

- Foreign objects, such as dirt, snow or ice, adhere to the windshield of the sensor portion.
- In adverse weather conditions, such as rain, snow, sandstorms, etc.
- A front vehicle or an oncoming vehicle is splashing water, snow or dirt.

When the sensor performance returns, the AHB will resume operation.

If the warning display does not disappear after waiting for a while, there is a possibility that the sensor has a malfunction. Contact an authorized Mitsubishi Motors dealer for inspection of the sensor.



Welcome light



N00563201322

This function turns on the front side-marker and parking lights for approximately 30 sec-

onds after the UNLOCK button on the key is pressed when the combination headlights and dimmer switch is in the “OFF” position (if so equipped) or “AUTO” position (if so equipped). The welcome light function will operate only when it is dark outside the vehicle.

5

NOTE

- While the welcome light function is operating, perform one of the following operations to cancel the function.
 - Press the LOCK button on the key.
 - Turn the combination headlights and dimmer switch to the “ or “” position.
 - Turn the ignition switch to the “ON” position or put the operation mode in ON.
- It is possible to modify functions as follows:
 - The headlights can be set to come on in the low beam setting.
 - The welcome light function can be deactivated.

For details, consult a Mitsubishi Motors dealer.

On vehicles equipped with the SDA or the SDA navigation system, screen operations can be used to make the adjustment.

Refer to the separate owner’s manual for details.

Coming home light

N00547301253

This function turns on the headlights in the low beam setting for approximately 30 seconds after the ignition switch is turned to the “OFF” position or the operation mode is put in OFF.

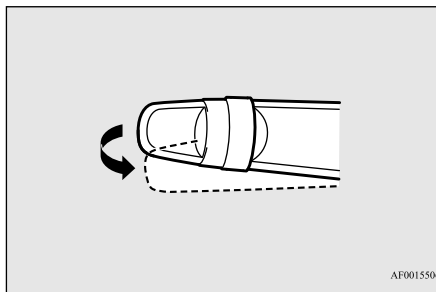

1. Turn the combination headlights and dimmer switch to the “OFF” position (if so equipped) or “AUTO” position (if so equipped).
2. Turn the ignition switch to the “OFF” position or put the operation mode in OFF. Also, if a key was used to start the engine, remove the key from the ignition switch.
3. Within 60 seconds of turning the ignition switch to the “OFF” position or putting the operation mode in OFF, pull the turn signal lever toward you.



AF0015506

4. The headlights will come on in the low beam setting for approximately 30 seconds. After the headlights go off, the headlights can be turned on again in the low beam setting for approximately 30 seconds by pulling the turn signal lever toward you within 60 seconds of turning the ignition switch to the “OFF” position or putting the operation mode in OFF. To turn on the headlights again after 60 seconds of turning the ignition switch to the “OFF” position or putting the operation mode in OFF, repeat the process from step 1.

NOTE

- While the coming home light function is operating, perform one of the following operations to cancel the function.
 - Pull the turn signal lever toward you.
 - Turn the combination headlights and dimmer switch to the “ or “” position or put the operation mode in ON.
 - Turn the ignition switch to the “ON” position or put the operation mode in ON.
- It is possible to modify functions as follows:
 - The time that the headlights remain on can be changed.
 - The coming home light function can be deactivated.

NOTE

For details, consult a Mitsubishi Motors dealer.
 On vehicles equipped with the SDA or the SDA navigation system, screen operations can be used to make the adjustment.
 Refer to separate owner's manual for details.

Turn signal lever

N00522601659

When changing lanes, or to making a gradual turn, hold the lever in the "lane change" position (1). It will return to the neutral position when you let go. Use the full position (2) when making a normal turn. The lever will return to the neutral position when the turn is complete. There may be times when the lever does not return to the neutral position. This usually happens when the steering wheel is turned only slightly. You can easily return the lever by hand.

Also, when you move the lever to (1) slightly then release it, the turn signal lights and the indicator light in the instrument cluster will flash three times.

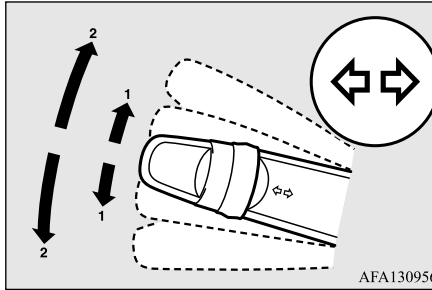
**NOTE**

- A light in the instrument panel flashes to show when the front and rear turn signal lights are working properly.
 If this light flashes faster than usual, check for a burned out turn signal light bulb or malfunctioning connection in the signal.
 If the panel light does not come on when the lever is moved, check for a blown fuse or a burned out bulb in the panel.
 Have the system inspected by your authorized Mitsubishi Motors dealer or a repair facility of your choice.
- It is possible to modify functions as follows:
 - Deactivate the turn signal light 3-flash function for lane changes.
 - Adjust the time required to operate the lever for the 3-flash function.

NOTE

- See your authorized Mitsubishi Motors dealer for details.
 On vehicles equipped with the Smartphone-link Display Audio (SDA) or the Smartphone-link Display Audio (SDA) navigation system, screen operations can be used to make the adjustment.
 Refer to the separate owner's manual for details.
- It is possible to change the tone of a sounding buzzer as the turn signal lights flash.
 Refer to "Changing the turn signal sound" on page 5-161.

Hazard warning flasher switch

N00522701344

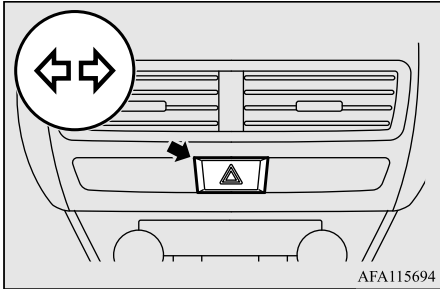

AFA115694

If you press the flasher switch, the front and rear turn signals will flash intermittently, and so will the hazard warning lights. This is an emergency warning system and should not be used when the vehicle is in motion, except for emergencies.

If you need to leave your vehicle, the flashers will keep working after the ignition switch is removed or the operation mode is put in OFF.

NOTE

- If the flashers are used for several hours, the battery will run down. This could make it difficult or impossible to restart your vehicle.

ECO mode switch

N00579300099

ECO mode is an eco-driving support system which automatically controls the engine and air conditioning system to improve fuel efficiency.

The ECO mode starts working by pressing the ECO mode switch when the ignition switch or operation mode is in ON.

Push the switch again and the ECO mode will cancel.

While the ECO mode is working, an ECO mode indicator will be turned on.



AFA114264

NOTE

- Since the air conditioning operation is controlled while the ECO mode is operating, you may feel that effectiveness of the air conditioning is weak.

NOTE

- Even if the ECO mode is operating, you can select normal operation of the air conditioning.
- For further information, please contact your authorized Mitsubishi Motors dealer.

Front fog light switch (if so equipped)

N00522801550

The front fog lights illuminate only when the headlights are on low beam.

Turning the knob in the direction of the “ON” position turns on the front fog lights as well as the indicator in the instrument cluster. To turn them off, turn the knob in the direction of the “OFF” position.

The knob will return to the neutral position when it is released.

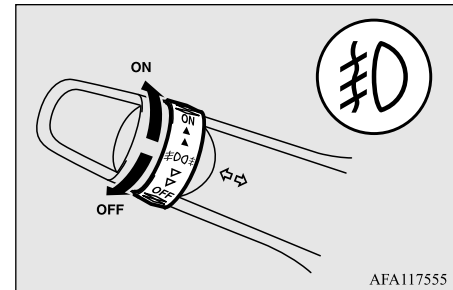

AFA117555

NOTE

- If the headlights are switched to high beam, the front fog lights will go out; they will illuminate again when the headlights are switched back to low beam.
- If the light switch is rotated to the “OFF” position (if so equipped), “AUTO” position (when the headlights are off) (if so equipped) or “FOG” position while the front fog lights are illuminated, they will automatically turn off. They can be turned back on again by rotating the combination headlights and dimmer switch back to the “FOG” position or the “AUTO” position when the headlights are on low beam, and turning the knob in the direction of the “ON” position.
- Do not use fog lights except in conditions of fog, otherwise excessive light glare may temporarily blind oncoming vehicle drivers.

Wiper and washer switch

N00523001836

CAUTION

- If the washer is used in cold weather, the washer fluid sprayed against the glass may freeze, which may hinder visibility. Warm the glass with the defroster before using the washer.

Windshield wipers**NOTE**

- To ensure a clear rearward view, the rear window wiper will automatically perform several continuous operations if the selector lever is put in the “R” (REVERSE) position while the windshield wipers are operating. Refer to “Rear window wiper and washer” on page 5-209.

Except for vehicles with rain sensor

The windshield wiper and washer can be operated when the ignition switch or the operation mode is in ON or ACC.

If the blades are frozen to the windshield, do not operate the wipers until the ice has melted and the blades are freed, otherwise the wiper motor may be damaged.

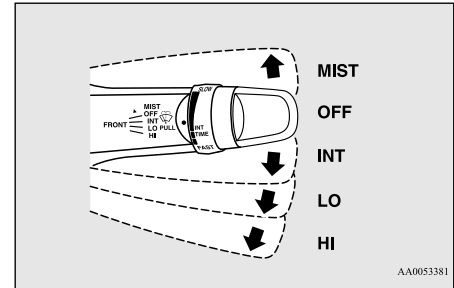
5

AA0053381

- MIST- Misting function
The wipers will operate once.
- OFF- Off
- INT- Intermittent (Speed sensitive)
- LO- Slow
- HI- Fast

To adjust intermittent intervals

With the lever in the “INT” (speed sensitive intermittent operation) position, the intermittent intervals can be adjusted by turning the knob (A).

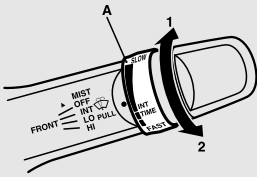

AG0009546

- 1- Fast
- 2- Slow

NOTE

- The speed-sensitive-operation function of the windshield wipers can be deactivated. For further information, please contact your authorized Mitsubishi Motors dealer or a repair facility of your choice. On vehicles equipped with the Smartphone-link Display Audio (SDA) or the Smartphone-link Display Audio (SDA) navigation system, screen operations can be used to make the adjustment. Refer to separate owner’s manual for details.

Misting function

The misting function can be used when the ignition switch or the operation mode is in ON or ACC.

The wipers will operate once if the wiper lever is raised to the “MIST” position and released. This operation is useful when it is drizzling, etc. The wipers will continue to operate while the lever is held in the “MIST” position.

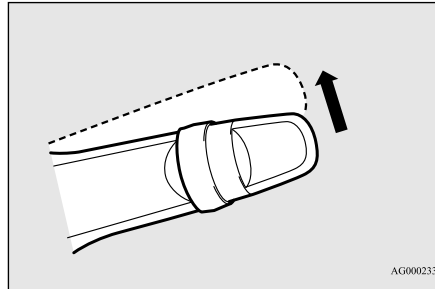

AG0002332

Vehicles with rain sensor

The windshield wipers can be operated when the ignition switch or the operation mode is in ON or ACC.

If the blades are frozen to the windshield or rear window, do not operate the wipers until the ice has melted and the blades are freed, otherwise the wiper motor may be damaged.

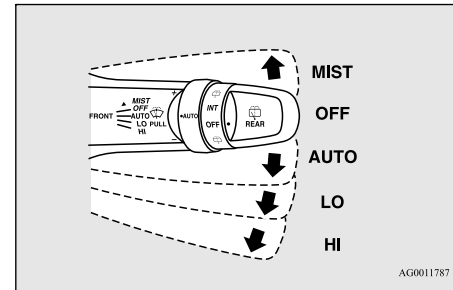

AG0011787

- MIST- Misting function
The wipers will operate once.
- OFF- Off
- AUTO- Auto-wiper control
Rain sensor
The wipers will automatically operate depending on the degree of wetness on the windshield.
- LO- Slow
- HI- Fast

Rain sensor

Can only be used when the ignition switch or the operation mode is in ON.

If the lever is put in the “AUTO” position, the rain sensor (A) will detect the extent of rain (or snow, other moisture, dust, etc.) and the wipers will operate automatically.

Keep the lever in the “OFF” position if the windshield is dirty and the weather is dry.

Wiper operation under these conditions can scratch the windshield and damage the wipers.

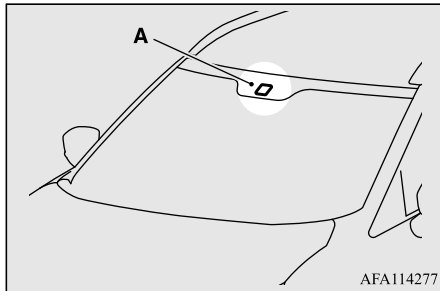
**CAUTION**

- With the ignition switch or the operation mode in ON and the lever in the “AUTO” position, the wipers may automatically operate in the situations described below.

CAUTION

- When cleaning the outside surface of the windshield, if you touch the rain sensor.
- When cleaning the outside surface of the windshield, if you wipe with a cloth the rain sensor.
- When using an automatic car wash.
- A physical shock is applied to the windshield or the rain sensor.

If your hands get trapped, you could suffer injuries or the wipers could malfunction. Be sure to turn the ignition switch to the “OFF” position or put the operation mode in OFF, or move the lever to the “OFF” position to deactivate the rain sensor.

NOTE

- To protect the rubber parts of the wipers, this operation of the wipers does not take place even if the lever is put in the “AUTO” position when the vehicle is stationary and the ambient temperature is approximately 32 °F (0 °C) or lower.
- Do not cover the sensor by affixing a sticker or label to the windshield. Also, do not put any water-repellent coating on the windshield. The rain sensor would not be able to detect the extent of rain, and the wipers might stop working normally.

NOTE

- In the following cases, the rain sensor may be malfunctioning. Have the vehicle checked at an authorized Mitsubishi Motors dealer or a repair facility of your choice.
 - When the wipers operate at a constant interval despite changes in the extent of rain.
 - When the wipers do not operate even though it is raining.
- The wipers may automatically operate when things such as insects or foreign objects are affixed to the windshield on top of the rain sensor or when the windshield is frozen. Objects affixed to the windshield will stop the wipers when the wipers cannot remove them. To operate the wipers again, move the lever to the “LO” or “HI” position. Also, the wipers may operate automatically due to strong direct sunlight or electromagnetic wave. To stop the wipers, move the lever to the “OFF” position.
- Contact an authorized Mitsubishi Motors dealer or a repair facility of your choice when replacing the windshield glass.

To adjust the sensitivity of the rain sensor

With the lever in the “AUTO” position, it is possible to adjust the sensitivity of the rain sensor by turning the knob (B).

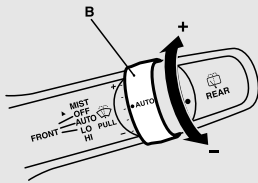

AG0000051

“+”- Higher sensitivity to rain

“-”- Lower sensitivity to rain

NOTE

- Automatic wiper operation (rain sensitive) can be changed to intermittent operation, either vehicle speed sensitive or not vehicle speed sensitive.

For further information, please contact your authorized Mitsubishi Motors dealer or a repair facility of your choice.

On vehicles equipped with the SDA or the SDA navigation system, screen operations can be used to make the adjustment.

Refer to the separate owner’s manual for details.

Misting function

Move the lever in the direction of the arrow and release, to operate the wipers once.

Use this function when you are driving in mist or drizzle.

The wipers will operate once if the lever is raised to the “MIST” position and released when the ignition switch or the operation mode is in ON or ACC. The wipers will continue to operate while the lever is held in the “MIST” position.

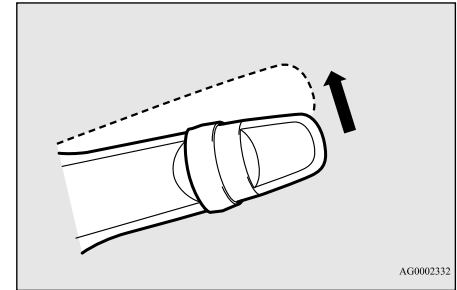

AG0002332

The wipers will operate once if the lever is moved to the “AUTO” position and the knob (C) is turned in the “+” direction when the ignition switch or the operation mode is in ON.

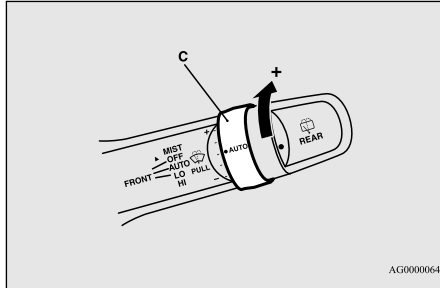

Windshield washer

N00504601471

The windshield washer can be operated with the ignition switch or the operation mode in ON or ACC.

The washer fluid will be sprayed onto the windshield by pulling the lever toward you. When the wipers are not in operation or in intermittent operation, by pulling the lever toward you, the wipers will operate several times while the washer fluid is being sprayed.

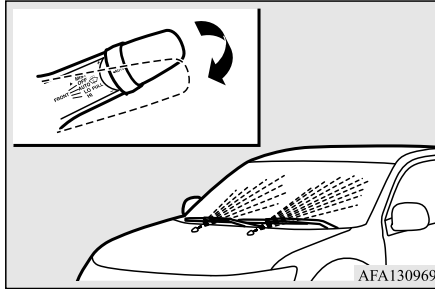

NOTE

- It is possible to modify functions as follows:
 - Intelligent washer can be deactivated. Refer to “Intelligent washer” on page 5-209.
 - The wipers can be set to operate again after approximately 6 seconds.

These functions are not activated when the vehicle is shipped from the factory.

To activate or deactivate these functions, please contact your authorized Mitsubishi Motors dealer.

On vehicles equipped with the SDA or the SDA navigation system, screen operations can be used to make the adjustment. Refer to the separate owner’s manual for details.

Intelligent washer

By releasing the lever soon after pulling it toward you, the washer fluid will be sprayed several times while the wipers are operating several times.

Intelligent washer will stop operating with any operation of the lever.

Rear window wiper and washer

N00523201535

The rear window wiper and washer can be operated when the ignition switch or the operation mode is in ON or ACC.

Turn the knob to operate the rear window wiper.

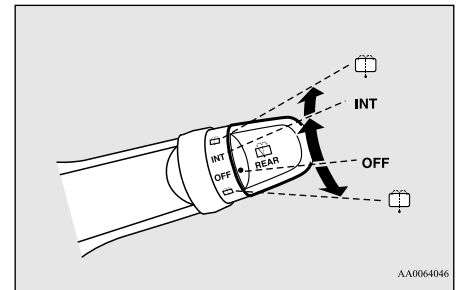

OFF- Off

INT- The wiper operates continuously for several seconds then operates intermittently at intervals of approximately 8 seconds.

 Washer fluid will be sprayed onto the rear window glass while the knob is turned fully in either direction.

When the washer fluid is sprayed, the wiper will automatically operate two or three times.

NOTE

- The rear window wiper will automatically perform several continuous operations if the selector lever is put in the “R” (REVERSE) position while the windshield wipers or the rear window wiper is operating. (automatic operation mode)

After the automatic operation, the rear window wiper will stop operating if the knob is in the “OFF” position. If the knob is in the “INT” position, the rear window wiper will return to the intermittent operation.

It is possible to set the rear window wiper to perform the automatic operation only if the selector lever is put in the “R” (REVERSE) position while the rear window wiper is operating with the knob in the “INT” position.

See your authorized Mitsubishi Motors dealer for details.

NOTE

On vehicles equipped with the SDA or the SDA navigation system, screen operations can be used to make the adjustment.

Refer to the separate owner’s manual for details.

- If the knob is in the “OFF” position, turn the knob to the “INT” position twice quickly to operate the rear window wiper continuously. (continuous operation mode)

Turn the knob to the “OFF” position to stop the rear window wiper continuous operation.

- The wiper intermittent operation time can be adjusted.

See your authorized Mitsubishi Motors dealer for details.

On vehicles equipped with the SDA or the SDA navigation system, screen operations can be used to make the adjustment.

Refer to the separate owner’s manual for details.

- The washer fluid reservoir is located in the engine compartment.

Check the fluid level regularly and refill if necessary. Refer to “Washer fluid” on page 9-9.

Precautions to observe when using wipers and washers

N00523501277

CAUTION

- If the washer is used in cold weather, the washer fluid sprayed onto the glass might freeze, blocking your view. Heat the glass with the defroster before using the washer.

NOTE

- Do not use the wipers when the windshield is dry. This could scratch the glass and wear the wiper blades prematurely.

- Before using the wipers in cold weather, check to be sure that the wiper blades are not frozen to the windshield or rear window. Using the wipers while the blades are frozen could cause the wiper motor to burn out.

- If the moving wipers become blocked part-way through a sweep by ice or other deposits on the glass, the wipers may temporarily stop operating to prevent the motor from overheating. In this case, park the vehicle in a safe place, turn the ignition switch to the “OFF” position or put the operation mode in OFF, and then remove the ice or other deposits.

Because the wipers will start operating again after the wiper motor cools down, check that the wipers operate before using them.

NOTE

- Avoid using the washer for more than 20 seconds at a time. Do not operate the washer when the washer fluid reservoir is empty or the pump may fail.
- During cold weather, add a recommended washer solution that will not freeze in the washer fluid reservoir. Otherwise the washer may not work or may be damaged.
- Replace the wiper blades when they are worn. Use the proper size replacement blades. For further information, please contact your authorized Mitsubishi Motors dealer.

Electric rear window defogger switch

N00523701.598

The rear window defogger can be used when the engine is running.

The indicator light (A) will come on when you press the electric rear window defogger switch. Electric current will flow through the heating wires on the rear window to help clear away moisture or frost.

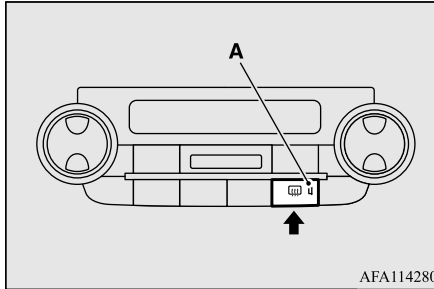

After approximately 15 to 20 minutes of operation, the system will shut off automatically.

To switch the defogger OFF before 15 to 20 minutes have passed, press the switch again. The indicator light will go out and the defogger will turn off.

If you need the defogger for more than 15 to 20 minutes, press the switch again. This will add 15 to 20 more minutes.

CAUTION

- The rear window defogger is not designed to melt snow. Remove any snow manually before using the rear window defogger.
- Use the rear window defogger only after the engine has started and is running. Be sure to turn the defogger switch off immediately after the window is clear to save on battery power.

CAUTION

- Do not place stickers, tape, or other items that are attached with adhesive over the grid wires on the rear window.
- When cleaning the inside rear window, use a soft cloth and wipe lightly over the grid wires.

NOTE

- If your vehicle is equipped with the heated outside rearview mirror, the mist can also be removed from the outside rearview mirrors when the rear window defogger switch is pressed. Refer to “Heated outside rearview mirror” on page 5-60.

NOTE

- It is possible to change the setting to make the rear window defogger operate automatically when ambient temperature becomes low while the engine is running, even if you do not push the rear window defogger switch.

It operates automatically only once after turning the ignition switch to the “ON” position or putting the operation mode in ON.

If you choose this setting, the heated outside rearview mirror (if so equipped) will also operate automatically at the same time.

For further information, please contact your authorized Mitsubishi Motors dealer.

On vehicles equipped with the Smartphone-link Display Audio (SDA) or the Smartphone-link Display Audio (SDA) navigation system, screen operations can be used to make the adjustment.

Refer to the separate owner’s manual for details.

5

Heated steering wheel switch (if so equipped)

N00589100087

The heated steering wheel contains internal heaters in the rim. Heating areas are shown in the illustration.

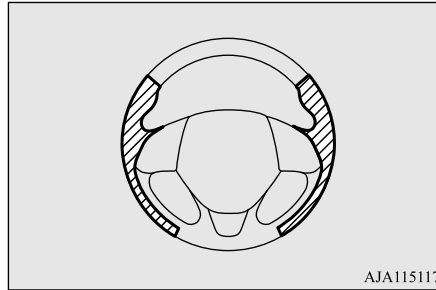

AJA115117

 Heating area

The heated steering wheel can be operated when the operation mode is in ON.

To turn on the heated steering wheel, push the heated steering wheel switch. The heated steering wheel will operate for approximately 30 minutes and then it will automatically turn off.

The indicator light (A) will illuminate while the heated steering wheel is operating.

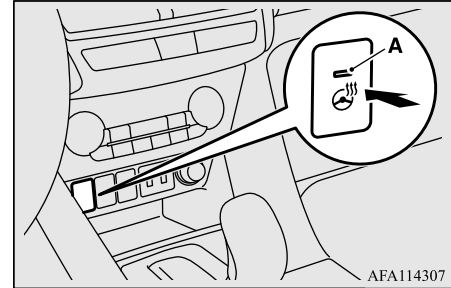

AFA114307

WARNING

- Persons who are unable to feel temperature change or skin pain due to age, illness, injury, medication, fatigue or other physical conditions or who have sensitive skin may suffer burns when using the heated steering wheel. To reduce the risk of burns, people with such conditions must use care when using the heated steering wheel.

CAUTION

- If water or any other liquid is spilled on the steering wheel, allow it to dry thoroughly before attempting to use the heated steering wheel. Turn the heated steering wheel off immediately if it appears to be malfunctioning during use.
- Also be aware that using the heated steering wheel with the engine off may run the battery down.

Horn switch

N00523801195

To honk the horn, press around the “” mark on the steering wheel.

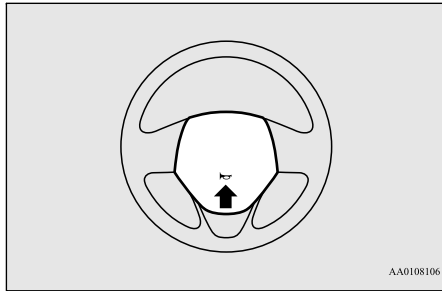

USB input terminal

N00566701269

You can connect your USB memory device or iPod* to play music files stored in the USB memory device or iPod.

*: “iPod” is a registered trademark of Apple Inc. in the United States and other countries.

The USB input terminal (A) is located in the indicated position.

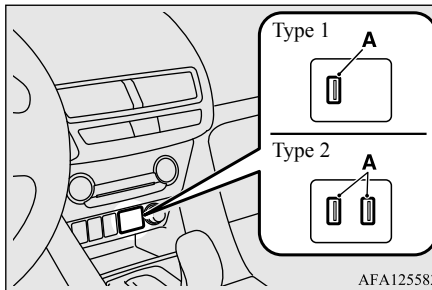

This section explains how to connect and remove a USB memory device or iPod.

How to connect a USB memory device

N00566801244

1. Park your vehicle in a safe place and turn the ignition switch to the “OFF” position or put the operation mode in OFF.
2. Connect a commercially available USB connector cable (B) to the USB memory device (A).

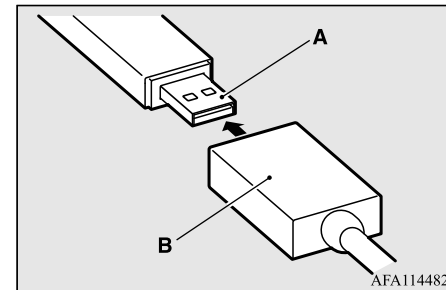

3. Connect the USB connector cable to the USB input terminal.

NOTE

- Do not connect the USB memory device to the USB input terminal directly. The USB memory device may be damaged.

Sun visors

4. To remove the USB connector cable, turn the ignition switch to the “OFF” position or put the operation mode in OFF first and perform the installation steps in reverse.

How to connect an iPod

N00566901274

5

1. Park your vehicle in a safe place and turn the ignition switch to the “OFF” position or put the operation mode in OFF.
2. Connect the connector cable to the iPod.

NOTE

- Use a genuine connector cable from Apple Inc.

3. Connect the connector cable to the USB input terminal.
4. To remove the connector cable, turn the ignition switch to the “OFF” position or put the operation mode in OFF first and perform the installation steps in reverse.

Types of connectable devices and supported file specifications

N00567001142

For details, please refer to the separated owner’s manual for the “Smartphone-link

Display Audio (SDA)”, the “Smartphone-link Display Audio (SDA) navigation system” or the “DISPLAY AUDIO”.

Sun visors

N00524601419

Pull the sun visor downward (1) to reduce front glare while driving. To reduce side glare, turn the visor to the side (2).

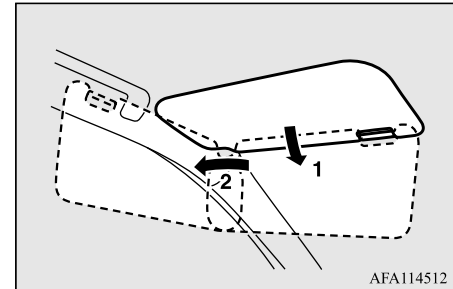

NOTE

- Pull the sun visor sideways to eliminate side glare farther to the rear. (if so equipped)

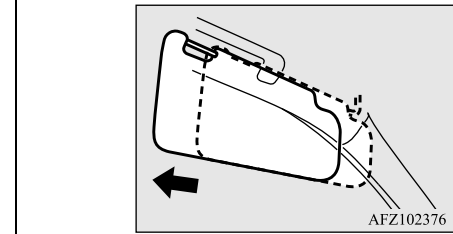

Vanity mirror

Type 1

A vanity mirror is fitted to the back of the sun visor.

Operating the lid of the vanity mirror will automatically turn on the mirror light (A).

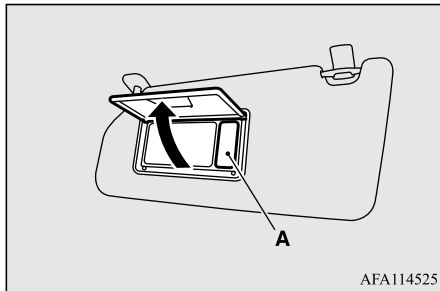

CAUTION

- If the lid of the vanity mirror with light is kept open for prolonged periods of time, the vehicle's battery will be discharged.

Type 2

A vanity mirror is fitted to the back of the sun visor.

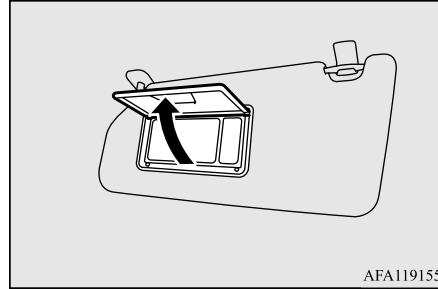

Ticket holder

The holder (B) is located on the back of the sun visor.

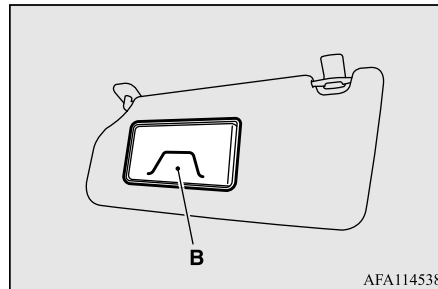

CAUTION

- Do not leave plastic cards in the ticket holder. Because the inside of the vehicle will become hot if the vehicle is parked in strong sunlight, the cards could deform or crack.

12 V power outlets

N00525001771

5

CAUTION

- Be sure to use a “plug-in” type accessory operating at 12 V and at 120 W or less. When using more than one socket at the same time, make sure the total power consumption of the electrical accessories does not exceed 120 W at 12 V.
- Also be aware that using electronic equipment with the engine off may run the battery down.
- When the power outlet is not in use, be sure to close the power outlet cover or replace the cap. This will prevent the power outlet from becoming clogged and short circuiting.

To use a “plug-in” type accessory, open the cover or remove the cap, and insert the plug in the power outlet.

NOTE

- Two 12V power outlets can be used simultaneously.

HomeLink® Wireless Control System (if so equipped)

Type 1

Accessories can be operated when the ignition switch or the operation mode is in ON or ACC.

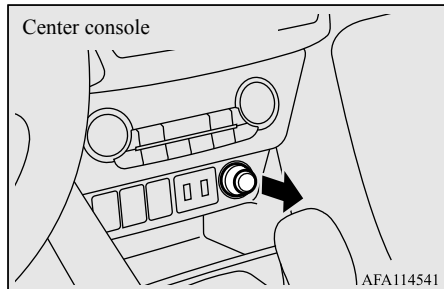

Type 2

Accessories can be operated in all ignition switch positions or all operation modes.

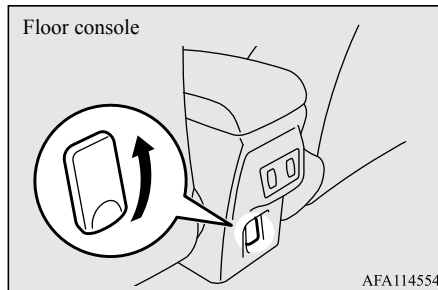

HomeLink® Wireless Control System (if so equipped)

N00554301095

HomeLink® and the HomeLink® house icon are registered trademarks of Gentex Corporation.

HomeLink® provides a convenient way to replace up to 3 hand-held radio-frequency (RF) transmitters used to activate devices such as gate operators, garage door openers, entry door locks, security systems, even home lighting. Additional HomeLink® information can be found at www.homelink.com,

www.youtube.com/HomeLinkGentex, or by calling the toll-free HomeLink®-Hotline at 1-800-355-3515.

⚠ WARNING

- Do not use HomeLink® with any garage door opener that lacks safety stop and reverse features as required by U.S. Federal Regulations. A garage door opener which cannot detect an object in the path of a closing garage door and then automatically stop and reverse, does not meet current U.S. Federal Regulations. Using a garage door opener without these features increases the risk of serious injury or death.
- During programming, your garage door or gate may open or close. Make sure that people and objects are clear of the garage door or gate that you are programming.

📖 NOTE

- Once HomeLink® is programmed, retain the original transmitter for future programming procedures (for example, new vehicle purchases). Upon sale of the vehicle, the programmed HomeLink® buttons should be erased for security purposes. Refer to “Clearing the programmed information” on page 5-220.

NOTE

- You can program a maximum of 3 devices. To change or replace any of the 3 devices after it has been initially programmed, you must first erase the current settings. Refer to “Clearing the programmed information” on page 5-220 or “Reprogramming a single HomeLink® button” on page 5-221.

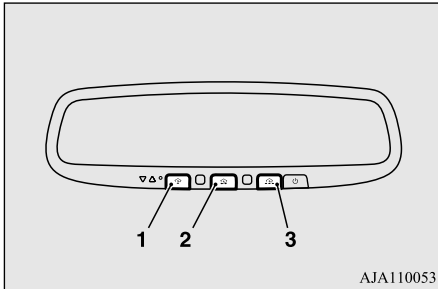

- HomeLink® button 1
- HomeLink® button 2
- HomeLink® button 3

Before programming Home-Link®

N00584600029

- Some garage door openers manufactured after 1995 have “rolling code protection”. To program a garage door opener equipped with “rolling code protection”; you will need to access the garage door opener motor to press the motor’s “Learn” or “Smart” buttons. For convenience, use a ladder and another person to assist you.
- It is recommended that a new battery be placed in the hand-held transmitter of the device being programmed to HomeLink® for quicker training and accurate transmission of the radio-frequency signal.

Programming a new Home-Link®

N00584700046

To program HomeLink® to operate a garage door, gate, entry door opener, home or office lighting, you need to be at the same location as the device.

- Press the HomeLink® button that you would like to program. The indicator light (A) will flash orange slowly.

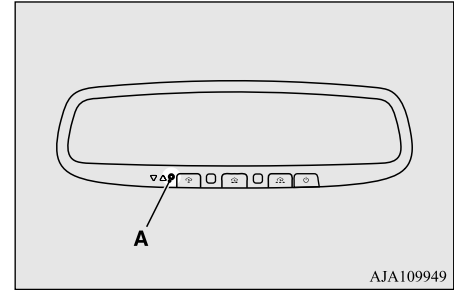
**5****NOTE**

- You do not need to continue holding the HomeLink® button.
- If the indicator light does not flash, refer to “Clearing the programmed information” on page 5-220.

- Position the end of your hand-held transmitter (B) 1 to 3 inches (2 to 8 cm) away from the HomeLink® button while keeping the indicator light in view.

5

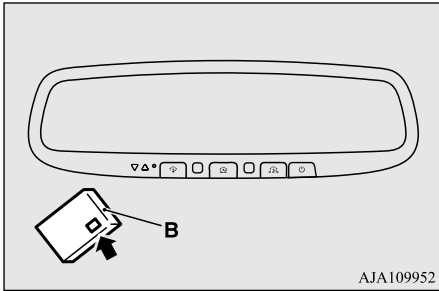

NOTE

- Some hand-held transmitters may actually train better from a distance of 6 to 12 inches (15 to 30 cm). Keep this in mind if you have difficulty with the programming process.

3. Press and hold the hand-held transmitter button while watching the indicator light (A). Continue pressing the button until the indicator light (A) changes from slowly flashing orange to either rapidly flashing green (rolling code) or continuously lit green (fixed code). Now you may release the hand-held transmitter button.

NOTE

- Some devices may require you to replace this “Programming a new HomeLink®” step 3 with procedures noted in the “Gate operator / Canadian programming” section. If the indicator light does not change to rapidly flashing green or continuously lit green after performing these steps, contact HomeLink® at www.homelink.com.

4. Press the HomeLink® button that was just programmed and observe the indicator light.
 - If the indicator light continuously illuminates green, programming is complete and your device should operate when the HomeLink® button is pressed and released.
 - If the indicator light rapidly flashes green, firmly press, hold for 2 seconds and release the programmed HomeLink® button. Repeat the “press/hold/release” sequence a second time, and, depending on the brand of the garage door opener (or other rolling code equipped device), repeat this sequence a third time to complete the programming process. At this point if your device operates, programming is complete.

- If the device does not operate, continue with “Programming a new HomeLink®” steps 5 to 7 to complete the programming of a rolling code equipped device.
5. At the garage door opener receiver (motor-head unit) in the garage, locate the “Learn” or “Smart” button. This can usually be found where the hanging antenna wire is attached to the motor-head unit (see the garage door opener manual to identify the “Learn” button.)
 6. Firmly press and release the “Learn” or “Smart” button. (The name and color of the button may vary by manufacturer.) There are typically 30 seconds to initiate step 7.
 7. Return to the vehicle and firmly press, hold for 2 seconds and release the programmed HomeLink® button. Repeat the “press/hold/release” sequence a second time, and, depending on the brand of the garage door opener (or other rolling code equipped device), repeat this sequence a third time to complete the programming process.

HomeLink® should now activate your rolling code equipped device.

NOTE

- In the event that there are still programming difficulties or questions, additional HomeLink® information and programming videos can be found online at www.homelink.com, www.youtube.com/HomeLinkGentex, or by calling the HomeLink® Hotline.

Gate operator/Canadian programming

N00584800021

Canadian radio-frequency laws require transmitter signals to “time-out” (or quit) after several seconds of transmission - which may not be long enough for HomeLink® to pick up the signal during programming. Similar to this Canadian law, some U.S. gate operators are designed to “time-out” in the same manner.

The indicator LED on the hand-held transmitter will go off when the device times out indicating that it has finished transmitting.

If you live in Canada or you are having difficulties programming a gate operator or garage door opener by using the “Programming” procedures, replace “Programming a new HomeLink®” step 3 with the following:

NOTE

- If programming a garage door opener or gate operator, it is advised to unplug the device during the “cycling” process to prevent possible overheating.

3. Press and release - every 2 seconds (“cycle”) your hand-held transmitter until the HomeLink® indicator light changes from slowly flashing orange to either rapidly flashing green (rolling code) or continuously lit green (fixed code). Now you may release the hand-held transmitter button.

Proceed with “Programming a new HomeLink®” step 4 to complete.

Additional steps for programming a door system with feedback

N00584900022

The HomeLink® has the capability of receiving garage door status from compatible garage door opener systems. Check your garage door opener manual for the available feature and HomeLink® compatibility. Also for a listing of compatible systems contact HomeLink® at: www.homelink.com

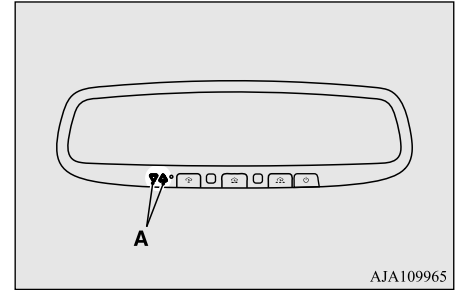

AJA109965

5

1. Within 5 seconds after successfully programming the garage door opener (refer to “Programming a new HomeLink®” section), both garage door operation indicators (A) will flash rapidly green indicating that the garage door feedback has been enabled.

If the indicators do not flash, perform steps 2 and 3 while pressing the HomeLink® button up to the first 10 times after successful programming.

2. Press and release the programmed HomeLink® button to activate the door. You now have 1 minute in which to complete step 3.

3. Once the door has stopped, press and release the “Learn” or “Smart” button on the garage door opener (refer to your garage door opener owner’s manual for the location of the “Learn” button). Both the HomeLink® garage door operation indicators will flash rapidly green upon successful synchronization with the door opener (within 5 seconds).

5

Operating HomeLink®

N0058500020

To operate, simply press and release the programmed HomeLink® button. Activation will now occur for the trained device (i.e. garage door opener, gate operator, security system, entry door lock, home/office lighting, etc.). For convenience, the hand-held transmitter of the device may also be used at any time.

Garage door feedback

N00585200022

The HomeLink® has the capability of receiving garage door status from compatible garage door opener systems. Refer to “Additional steps for programming a door system with feedback” on page 5-219.

Garage door status is then displayed with indicators (A).

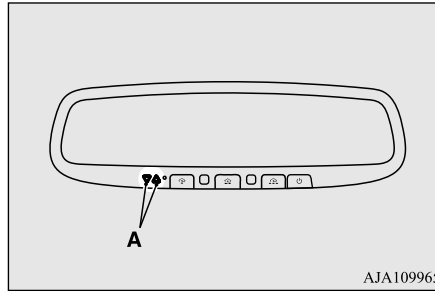

The indicators will illuminate/blink in response to the following conditions:

↔↔: Blinking ▼ ▲: Illuminates

Garage door opener closing	↔↔ (orange)
Garage door opener closed	▼ (green)
Out of range	↔↔ (red)
Garage door opener opening	↔↔ (orange)
Garage door opener opened	▲ (green)
Out of range	↔↔ (red)

The HomeLink® has the capability of listening to these messages at a range up to 820.2 feet (250 m) (open line of sight), but range may be reduced by obstacles such as houses or trees. You may have to slow your vehicle speed to receive the CLOSED or OPENED message feedback from the garage door opener. If the unit is out of range before receiving either the UP or DOWN message from the door opener, both the UP and DOWN indicators will flash red followed by a continuous lit orange indicator in the direction the door was last moving.

Recall of the door state after initial feedback is possible by simultaneously pressing either HomeLink® buttons 1 and 2 or buttons 2 and 3 for 2 seconds. The last recorded message will be displayed for 3 seconds, again following the garage door status indication of the figure above.

Clearing the programmed information

N00585300049

To erase programming from the 3 buttons (individual buttons cannot be erased but can be “reprogrammed” as outlined below), follow the steps noted:

1. Press and hold the 2 outer HomeLink® buttons for at least 10 seconds. The indicator will change from continuous yellow to rapidly flashing green.
2. Release both buttons.

 **NOTE**

- Do not hold for longer than 20 seconds.

3. HomeLink® is now in the training (or learning) mode and can be programmed at any time beginning with “Programming a new HomeLink®” step 1.

Reprogramming a single HomeLink® button

N00585400024

To reprogram a HomeLink® button, complete the following.

1. Press and hold the desired HomeLink® button. Do not release the button.
2. The indicator light will begin to slowly flash orange after 20 seconds. The HomeLink® button can be released at this point. Proceed with “Programming a new HomeLink®” step 2.

 **NOTE**

- If you do not complete the programming of a new device to the button, it will revert to the previously stored programming. For questions or comments, visit www.homelink.com, www.youtube.com/HomeLinkGentex, or by calling the HomeLink® Hotline.

General information

N00585600042

Your HomeLink® system operates on a radio frequency subject to Federal Communications Commission (FCC) Rules (For vehicles sold in U.S.A.) and Industry Canada Rules (For vehicles sold in Canada). This device complies with Part 15 of the FCC Rules and RSS-210 of the Industry Canada Rules. Operation is subject to the following two conditions.

- This device may not cause harmful interference.
- This device must accept any interference that may be received, including interference that may cause undesired operation.

 **CAUTION**

- The transmitter has been tested and complies with FCC and IC rules. Changes or modifications not expressly approved by the party responsible for compliance could void the user's authority to operate the device.

This equipment complies with FCC radiation exposure limits set forth for an uncontrolled environment. End Users must follow the specific operating instructions for satisfying RF exposure compliance. This transmitter must be at least 8 inches (20 cm) from the user and must not be co-located or operating in conjunction with any other antenna or transmitter.

The term “IC:” before the certification/registration number only signifies that Industry Canada technical specifications were met.

Interior lights

N00525301761

NOTE

- Be aware that leaving the light illuminated with the engine off may run the battery down.
Never leave the vehicle without checking that the light is off.

5

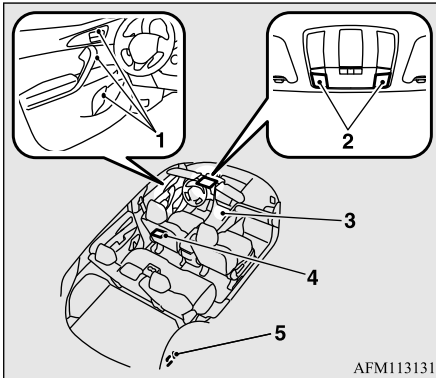

AFM113131

- 1- LED interior illumination (Front door) (if so equipped) → P.5-224
- 2- Dome light (front)/Reading lights → P.5-222
- 3- LED interior illumination (Smartphone tray) → P.5-224
- 4- Dome light (rear) → P.5-223
- 5- Cargo room light → P.5-224

Dome light (front)/Reading lights

N00525401603

Dome light (front)

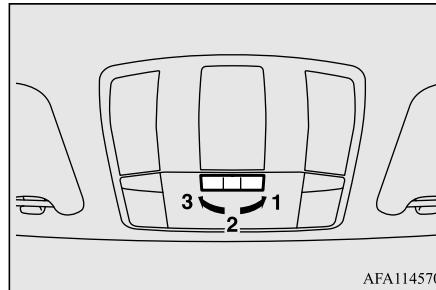

AFA114570

1- 

The dome light illuminates regardless of any door or the liftgate being opened or closed.

2- 

When any of the doors or the liftgate is opened, the dome light illuminates; when any of them are closed, the dome light goes off after approximately 30 seconds. However, the light goes off immediately if:

- The doors and the liftgate are closed while the ignition switch is in the “ON” position or the operation mode is ON.
- The driver’s door is closed while the lock knob is in the lock position, after all the other doors are closed.
- The doors and the liftgate are closed and the power door lock function is used to lock the doors.
- The key button is used to lock the doors.
- In vehicles equipped with the F.A.S.T.-key, the doors and the liftgate are locked using the F.A.S.T.-key.

NOTE

- When the engine is started using the key while the doors and liftgate are closed, if you remove the key, the dome light will illuminate for approximately 30 seconds then go off.
- When the engine is started using the F.A.S.T.-key while the doors and liftgate are closed, if the operation mode is put in OFF, the dome light will illuminate for approximately 30 seconds and then go off.

NOTE

- The time until the light goes off can be adjusted. See your authorized Mitsubishi Motors dealer for details. On vehicles equipped with the SDA or the SDA navigation system, screen operations can be used to make the adjustment. Refer to the separate owner's manual for details.

3- ○

The dome light stays off regardless of any door or the liftgate being opened or closed.

Reading lights

N00537601224

When the dome light (front) are turned off, push the switch (A) to turn on the light. Push the switch again to turn off the light.

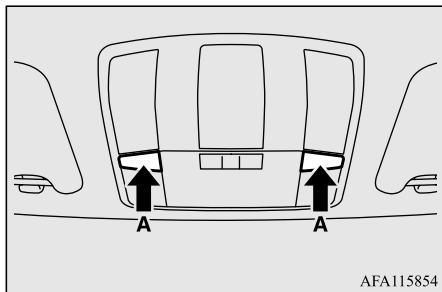

Dome light (rear)

N00525801434

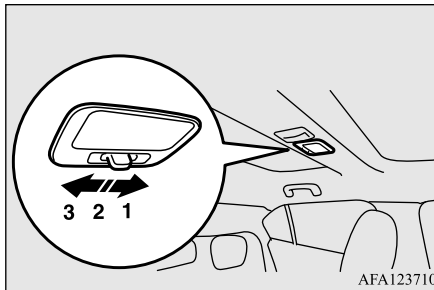

1- ☀

The dome light illuminates regardless of any door or the liftgate being opened or closed.

2- ●

When any of the doors or the liftgate is opened, the dome light illuminates; when any of them are closed, the dome light goes off after approximately 30 seconds. However, the light goes off immediately if:

- The door and the liftgate are closed while the ignition switch is in the "ON" position or the operation mode is in ON.
- The driver's door is closed while the lock knob is in the lock position, after all the other doors are closed.

- The door and the liftgate are closed and the power door lock function is used to lock the doors.
- The keyless entry system key is used to lock the doors.
- In vehicles equipped with the F.A.S.T.-key, the doors and the liftgate are locked using the F.A.S.T.-key.

NOTE

- When the engine is started using the key while the doors and liftgate are closed, if you remove the key, the dome light will illuminate for approximately 30 seconds then go off.
- When the engine is started using the F.A.S.T.-key while the doors and liftgate are closed, if the operation mode is put in OFF, the dome light will illuminate for approximately 30 seconds and then go off.
- When the dome light switch is in the "ON" position, the light will not go off, even when all the doors and the liftgate are closed.
- The time until the light goes off can be adjusted. See your authorized Mitsubishi Motors dealer for details. On vehicles equipped with the SDA or the SDA navigation system, screen operations can be used to make the adjustment. Refer to the separate owner's manual for details.

Interior lights

3- ○

The dome light stays off regardless of any door or the liftgate being opened or closed.

Cargo room light

N00526101216

5

When the liftgate is opened, the cargo room light illuminates; when it is closed, the light turns off.

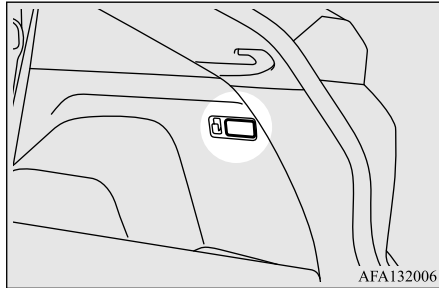
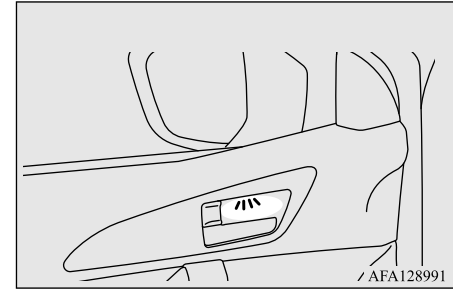
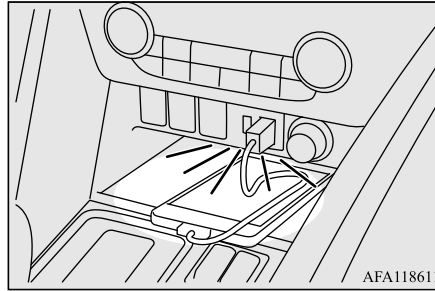

LED interior illumination (Smartphone tray)

N00595400030

When the light is illuminated with the light switch in the “ON”, “D”, or “AUTO” position (vehicles with automatic light control), the LED interior illumination (Smartphone tray) illuminates.

LED interior illumination (Front door) (if so equipped)

N00596900032

For the inside door handle

When the operation mode is set from ON to OFF, the LED interior illumination (Front door) illuminates for several seconds.

NOTE

- If the driver's door is opened when the operation mode is set to OFF or ACC, the illumination will illuminate.

For the door grip and bottle holder

When the lights are illuminated with the light switch in the “ON”, “D”, or “AUTO” position, the LED interior illumination (Front door) illuminates.

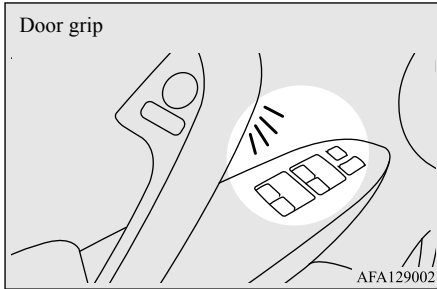

- If interior lights are left on with the ignition switch in the “OFF” position or the operation mode in OFF, the lights go off automatically after approximately 30 minutes.
- The lights come on again if the ignition switch or the engine switch is operated, if any door or liftgate is opened or closed, or if the keyless entry or F.A.S.T.-key is operated.

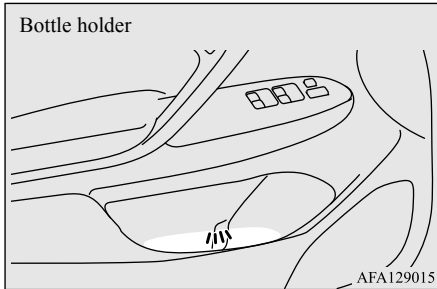

NOTE

- The interior light auto-cutout function can be deactivated. The time until the lights automatically go off can be adjusted. See your authorized Mitsubishi Motors dealer for details.
- On vehicles equipped with the SDA or the SDA navigation system, screen operations can be used to make the adjustment. Refer to the separate owner’s manual for details.

Storage spaces

N00526401613

CAUTION

- Never leave lighters, carbonated drink cans, or spectacles in the cabin when parking the vehicle in hot sunshine. The cabin will become extremely hot, so lighters and other flammable items may catch fire and unopened drink cans (especially carbonated beverages, including beer) may rupture. The heat may also deform or crack plastic spectacle lenses and other spectacle parts that are made of plastic.
- Keep the lids of storage spaces closed while driving the vehicle. A lid or the contents of a storage space could otherwise cause injuries during a sudden stop.

NOTE

- Do not leave valuables in any storage space when leaving the vehicle.

Interior light* auto-cutout function

N00526301579

*: Dome light (front)/Reading lights, dome light (rear), cargo room light and LED interior illumination (Front door) (if so equipped) for the inside door handle.

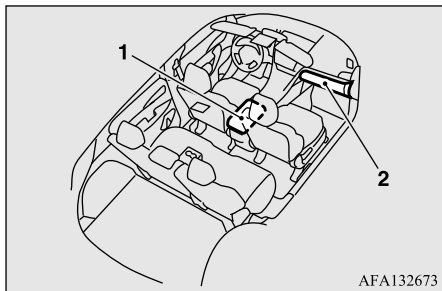

- 1- Floor console box
- 2- Glove compartment

Glove compartment

N00551501344

WARNING

- An open glove compartment door can cause a serious injury or death to the front passenger in an accident, even if the passenger is wearing his/her seat belt. Always keep the glove compartment door closed when driving.

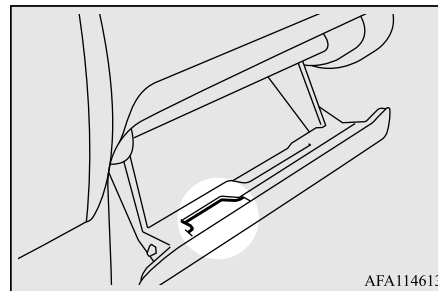

To open, pull the lever (A).

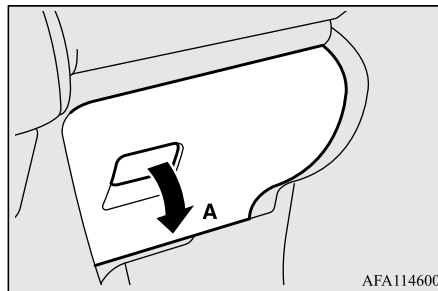

Card holder

There is a card holder on the inside of the glove compartment.

Floor console box

N00551601358

To open the console box, lift the release lever (A) and raise the lid.

The floor console box can also be used as an arm rest.

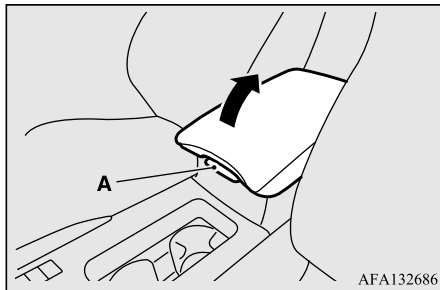

Drink holders

N00527301576

⚠ WARNING

- Do not spray water or spill beverages inside the vehicle. If the switches, wires, or electrical components become wet, they could malfunction or cause a vehicle fire. If you accidentally spill a beverage, wipe up as much liquid as possible and immediately consult an authorized Mitsubishi Motors dealer.

The drink holder is designed for holding cups or drink-cans securely in its holes.

For the front seat

The drink holder is located in front of the floor console.

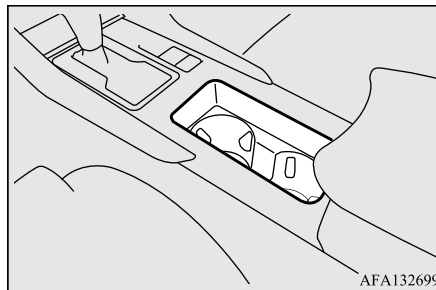

For the rear seat (if so equipped)

N00537001257

This drink holder is located in the rear seat arm rest.

Pull the arm rest down to use the drink holder.

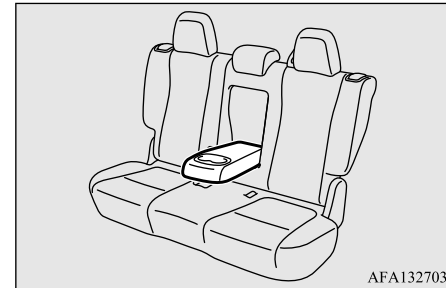

5

Bottle holders

N00502801118

⚠ WARNING

- Do not spray water or spill beverages inside the vehicle. If the switches, wires, or electrical components become wet, they could malfunction or cause a vehicle fire. If you accidentally spill a beverage, wipe up as much liquid as possible and immediately consult an authorized Mitsubishi Motors dealer.

Cargo area cover (if so equipped)

CAUTION

- Drinking beverages while driving your vehicle is distracting and can cause an accident.
- Vibration and shaking while driving may cause beverages to spill. Be very careful, as spilling hot beverages could cause burns.

- 5** There are bottle holders located on both sides of front and rear doors.



NOTE

- Do not store a cup or drink can in the bottle holder.
- Make sure all lids are tightly closed when storing beverages that are in plastic bottles, etc.
- Some beverages may not be stored, depending on the size and shape of the plastic bottles, etc.

Cargo area cover (if so equipped)

N00528301209

To use

1. Pull out the spring-loaded cover (A) and insert it in the mounting grooves (B) on both sides.

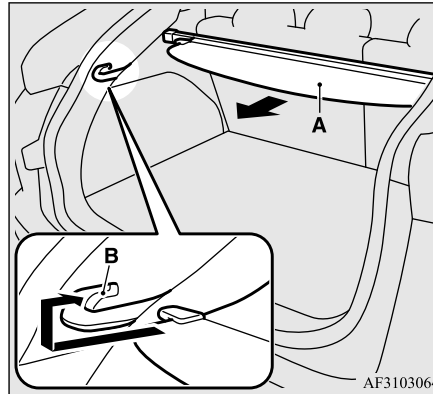

2. Remove the cover (A) from the mounting grooves (B), and the cover will be rolled back into the retracted position.

NOTE

- Do not place anything on the cargo area cover.

To remove

1. Roll back the cover (A).
2. Move one of the sliders (C) towards the inside of the vehicle and lift it to remove the cargo area cover.

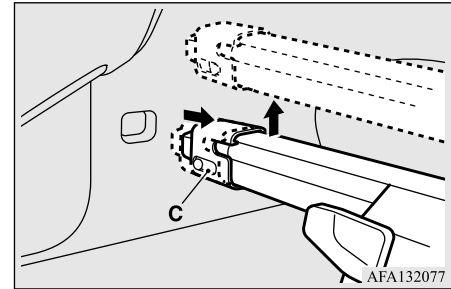

To refit

To refit the cargo area cover, follow the removal steps in reverse. Gently shake the entire cargo area cover after fitting it to make sure it is securely retained.

To store

The cargo area cover can be fitted at the indicated position when not in use.

The cargo area cover can be stored above the luggage floor board.

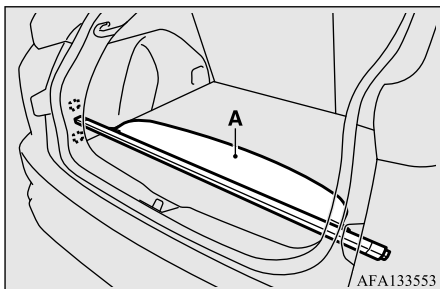

⚠ CAUTION

- When storing the cargo area cover, position the cover (A) to face the front of the vehicle. If the cover is stored facing the rear of the vehicle, the cover will be caught in the liftgate when the liftgate is closed, which may cause damage.

Assist grips

N00559001097

The assist grips (located above the doors on the headliner) are not designed to support body weight. They are intended for use only while seated in the vehicle.

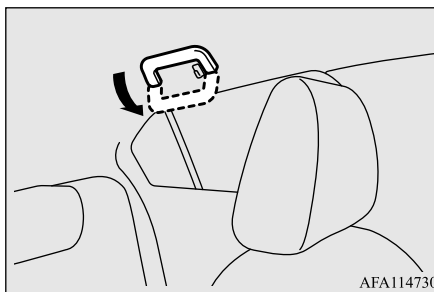

⚠ CAUTION

- Do not use the assist grips when getting into or out of the vehicle. The assist grips could detach causing you to fall.

Coat hooks

N00553601189

There is a coat hook on the rear seat assist grip of the driver's side.

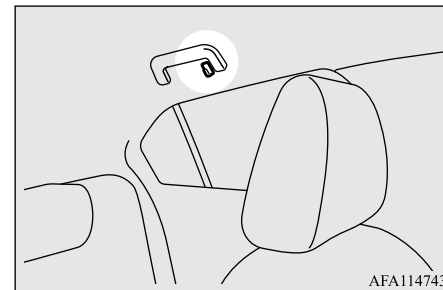

5

⚠ WARNING

- Do not put a hanger or any heavy or pointed object on the coat hook. If the curtain airbag was activated, any such item could be propelled away with great force and could prevent the curtain airbag from inflating correctly. Hang clothes directly on the coat hook (without using a hanger). Make sure there are no heavy or sharp objects in the pockets of clothes that you hang on the coat hook.

Luggage hooks

Luggage hooks

N00528501302

There are hooks on the sides of the luggage area for use in securing luggage.

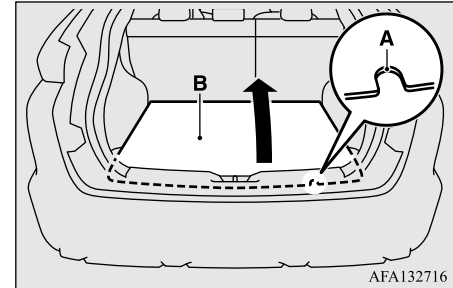
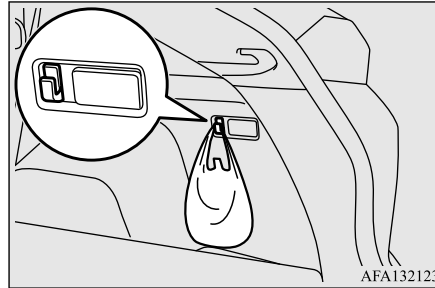
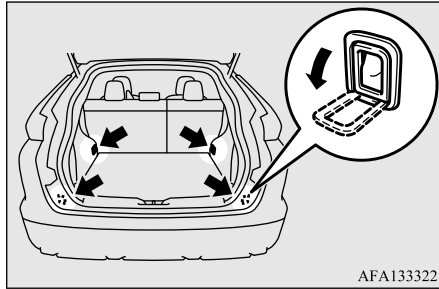

NOTE

- To avoid damage to the convenient hook, do not hang objects that weight more than 6.6 pounds (3 kg).

CAUTION

- Do not load the luggage higher than the top of the seatback.
Be sure that luggage is firmly secured.
Restricted rear vision or flying objects entering the passenger compartment during sudden braking could result in a serious accident.

Luggage floor board

N00527601032

Insert your finger in the notch (A) and lift the luggage floor board (B).

Convenient hook

N00574701037

Light items of luggage can be hung from the hook.

Driving safety

Driving precaution	6-2
Fuel economy	6-2
Driving, alcohol and drugs	6-2
Floor mat	6-3
Vehicle preparation before driving	6-4
Safe driving techniques	6-4
Driving during cold weather	6-5
Braking	6-5
Parking	6-6
Loading information	6-6
Cargo loads	6-11
Trailer towing	6-13

Driving precaution

N00629301119

WARNING

- **Utility vehicles have a significantly higher rollover rate than other types of vehicles. Avoid abrupt maneuvers and excessive speed. Always buckle up.**

6

Your vehicle has been designed for both normal and occasional off-road use. However, avoid driving the vehicle through areas where the tires may get stuck in deep sand or mud as your vehicle is designed primarily for use on pavement, unlike a conventional off-road vehicle.

Keep in mind that 2-wheel drive vehicles are less capable than 4-wheel drive vehicles for driving on muddy, slippery, wet or snow-covered roads.

Utility vehicles have higher ground clearance and a narrower track, which enables them to perform in a wide variety of off-road situations. Because of the higher ground clearance, these vehicles have a higher center of gravity, which makes them handle differently than ordinary vehicles when driving on pavement. They are not designed to maneuver or corner at the same speed on pavement as conventional 2-wheel drive passenger cars any more than low-slung sports cars are designed

to perform satisfactorily in off-road conditions.

Always drive safely and steer the vehicle carefully. Avoid operating the vehicle in a manner that might require sharp turns or abrupt maneuvers. As with other vehicles of this type, failure to operate this vehicle correctly can result in loss of control or vehicle rollover.

In a rollover crash, an unbelted person is significantly more likely to die than a person wearing a seat belt. Before starting the vehicle, always make certain that you and all your passengers are properly wearing their seat belts (with children in the rear seat, in appropriate restraints).

Fuel economy

N00628801218

Fuel economy is dependent on many factors. Your personal driving habits can have a significant effect on your fuel consumption. Several recommendations for achieving the greatest fuel economy are listed below.

- Whenever accelerating from a stop, always accelerate slowly and smoothly.
- When parked for even a short period, do not idle the engine. Shut it off.
- Plan your trips to avoid unnecessary stops.

- Keep your tires inflated to the recommended pressures.
- When driving a 4-wheel drive vehicle on highways or dry improved roads, set the drive mode to “AUTO”.
- For freeway driving, maintain a speed of approximately 50 mph (80 km/h) when traffic, roadway and weather conditions safely permit.
- Keep your air cleaner filter clean and your vehicle lubricated according to the recommendations in this manual.
- Always keep your vehicle well maintained. A poorly maintained engine wastes fuel and costs money.
- Never overload your vehicle.

Driving, alcohol and drugs

N00628900049

Drunk driving is one of the most frequent causes of accidents.

Your driving ability can be seriously impaired even with blood alcohol levels far below the legal minimum. If you have been drinking, don't drive. Ride with a designated non-drinking driver, call a cab or a friend, or use public transportation. Drinking coffee or taking a cold shower will not make you sober. Similarly, prescription and nonprescription drugs affect your alertness, perception and reaction time. Consult with your doctor or

pharmacist before driving while under the influence of any of these medications.

⚠ WARNING

● **NEVER DRINK AND DRIVE.**

Your perceptions are less accurate, your reflexes are slower and your judgment is impaired.

Floor mat

N00628601072

The original equipment floor mat provided with your vehicle was specifically designed for your vehicle.

Always properly position the floor mat and assure it does not interfere with operation of the pedals. Always use the retaining clip on the driver's floorboard to secure the floor mat. When used, this clip will help prevent the floor mat from moving forward and possibly interfering with the operation of the pedals. To prevent the floor mat from moving forward and possibly interfering with the operation of the pedals, Mitsubishi Motors Genuine floor mats are recommended.

To install the floor mat

N00628701103

1. Place the floor mat to fit the shape of the floorboard.

2. Align the floor mat with the installation holes over the retaining clips.
3. Secure the floor mat with retaining clips.

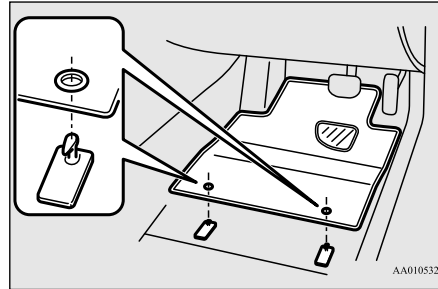

📖 NOTE

- The shape of the mat and the number of retaining clips may vary depending on the vehicle model.

⚠ WARNING

- If a floor mat is the wrong size or is not properly installed, it can interfere with the operation of the pedals. Interference with the pedals can cause unintended acceleration and/or increased stopping distances resulting in a crash and injury. Always make sure the floor mat does not interfere with the accelerator or brake pedal.
- Always use the retaining clip on the driver's floorboard to secure the floor mat.

⚠ WARNING

- Always install the mat with the correct side facing down.
- Never install a second mat over or under an existing floor mat.
- Do not use a floor mat designed for another model vehicle even if it is a Mitsubishi Motors Genuine floor mat.
- Before driving, be sure to check the following:
 - Periodically check that the floor mat is properly secured with the retaining clips. If you remove the floor mat while cleaning the inside of your vehicle or for any other reason, always check the condition of the floor mat after it has been reinstalled.
 - While the vehicle is stopped with the engine off, check that the floor mat is not interfering with the pedals by depressing the pedals fully.

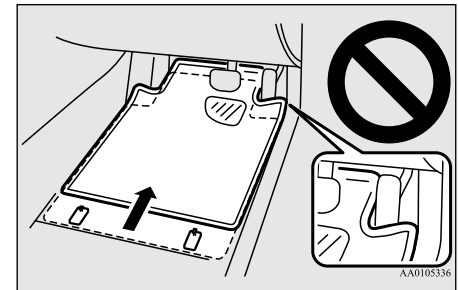

Vehicle preparation before driving

N00629001842

For a safer and more enjoyable trip, always check for the following:

Seat belts and seats

6

- Before starting the vehicle, make certain that you and all passengers are seated and wearing their seat belts properly (with children in the rear seat, in appropriate restraints), and that all the doors and the liftgate are locked.
- Move the driver's seat as far backward as possible, while keeping good visibility, and good control of the steering wheel, brakes, accelerator, and controls. Check the instrument panel indicators and multi-information display for any possible problem.
- Similarly, the front passenger seat should also be moved as far back as possible.
- Make sure that infants and small children are properly restrained in accordance with all laws and regulations.

Defrosters

Check these by selecting the defroster mode, and set the blower switch on high. You should be able to feel the air blowing against the windshield.

Refer to “Defrosting or defogging (windshield, door windows)” on page 7-13, 7-22.

Tires

Check all the tires for heavy tread wear or uneven wear patterns. Look for stones, nails, glass, or other objects stuck in the tread. Look for any tread cuts or sidewall cracks. Check the wheel nuts for tightness, and the tires (including spare tire) for proper pressure. Replace your tires before they are heavily worn out.

As your vehicle is equipped with a tire pressure monitoring system, there is a risk of damage to the tire inflation pressure sensors when the tire is replaced on the rim. Tire replacement should, only, be performed by an authorized Mitsubishi Motors dealer.

Lights

Have someone watch while you turn all the exterior lights on and off. Also check the turn

signal indicators and high-beam indicators on the instrument panel.

Fluid leaks

Check the ground under the vehicle after parking overnight, for fuel, water, oil, or other leaks. Make sure all the fluid levels are correct. Also, if you can smell fuel, you need to find out why immediately and have it fixed.

Safe driving techniques

N00629201147

Even this vehicle's safety equipment, and your safest driving, cannot guarantee that you can avoid an accident or injury. However, if you give extra attention to the following areas, you can better protect yourself and your passengers:

- Drive defensively. Be aware of traffic, road and weather conditions. Leave plenty of stopping distance between your vehicle and the vehicle ahead.
- Before changing lanes, check your mirrors, blind spots, and use your turn signal light.
- While driving, watch the behavior of other drivers, bicyclists, and pedestrians.

- Always obey applicable laws and regulations. Be a polite and alert driver. Always leave room for unexpected events, such as sudden braking.
- If you plan to drive in another country, obey their vehicle registration laws and make sure you will be able to get the right fuel.

Driving during cold weather

N00629400445

- Check the battery. At the same time, check the terminals and wiring. During extremely cold weather, the battery will not be as strong. Also, the battery power level may drop because more power is used for cold starting and driving. Before driving the vehicle, check to see if the engine runs at the proper speed and if the headlights are as bright as normally. Charge or replace the battery if necessary. During extreme cold weather, it is possible that a very low battery could freeze.

WARNING

- **The battery gives off explosive hydrogen gas. Any spark or flame can cause the battery to explode, which could cause serious injury or death.**
Always wear protective clothes and a face mask when working with your battery, or let a skilled mechanic do it.

- Warm the engine sufficiently. After starting the engine, allow a short warm-up time to distribute oil to all cylinders. Then drive your vehicle slowly. Stay at low speeds at first so that the transaxle, transfer case and rear axle oil have time to spread to all lubrication points.
- Check the engine antifreeze. If there is not enough coolant because of a leak or from engine overheating, add Mitsubishi Motors Genuine Super Long Life Coolant Premium or equivalent. Please read this section in conjunction with the “Engine coolant” on page 9-7.

WARNING

- **Never open the radiator cap when the radiator is hot. You could be seriously burned.**

Braking

N00629501528

All the parts of the brake system are critical to safety. Have the vehicle serviced by an authorized Mitsubishi Motors dealer or a repair facility of your choice at regular intervals according to the “WARRANTY AND MAINTENANCE MANUAL”.

When brakes are wet

Check the brake system while driving at a low speed immediately after starting, especially when the brakes are wet, to confirm they work normally.

A film of water can be formed on the brake discs and prevent normal braking after driving in heavy rain or through large puddles, or after the vehicle is washed. If this occurs, dry the brakes out by driving slowly while lightly depressing the brake pedal.

When driving in cold weather

On snowy roads, ice can form on the braking system, making the brakes less effective. While driving in such conditions, pay close attention to surrounding vehicles and to the condition of the road surface. From time to time, lightly depress the brake pedal and check how effective the brakes are.

When driving downhill

It is important to take advantage of the engine braking by downshifting while driving on steep downhill roads in order to prevent the brakes from overheating.

Parking

N00629601398

Parking on a hill

When parking on a hill, set the parking brake, and turn the front wheels toward the curb on a downhill, or away from the curb on an uphill. If necessary, apply chocks to the wheels.

Be sure that the parking brake is firmly set when parked and that the selector lever is in the “P” (PARK) position.

When parking on a hill, it is important to set the parking brake before moving the selector lever to the “P” (PARK) position. This prevents loading the parking brake against the transaxle. When this happens, it is difficult to move the selector lever out of the “P” (PARK) position.

Parking with the engine running

Never leave the engine running while you take a short nap or rest. Also, never leave the engine running in a closed or poorly ventilated place.

WARNING

- Leaving the engine running risks injury or death from accidentally moving the selector lever or the accumulation of toxic exhaust fumes in the passenger compartment.

Where you park

Your front bumper can be damaged if you scrape it over curbs or parking stop blocks. Be careful when traveling up or down steep slopes where your bumper can scrape the road.

WARNING

- Do not park your vehicle in areas where combustible materials such as dry grass or leaves can come in contact with a hot exhaust, since a fire could occur.

When leaving the vehicle

Always carry the key and lock all doors and the liftgate when leaving the vehicle unattended.

Always try to park your vehicle in a well lit area.

Do not keep the steering wheel fully turned for a long time

More effort could be required to turn the steering wheel.

Refer to “Electric power steering system (EPS)” on page 5-84.

Loading information

N00629901450

It is very important to know how much weight your vehicle can carry. This weight is called the vehicle capacity weight and includes the weight of all occupants, cargo (including the roof load), non-factory-installed options, and the tongue weight of the trailer, if any, being towed. The tire and loading information placard located on the driver’s door sill of your vehicle will show how much weight it may properly carry.

⚠ WARNING

● **Never overload your vehicle. Overloading can damage your vehicle, adversely affect vehicle performance, including handling and braking, cause tire failure, and result in an accident.**

It is important to familiarize yourself with the following terms before loading your vehicle:

- Vehicle maximum load on the tire: load on an individual tire that is determined by distributing to each axle its share of the maximum loaded vehicle weight and dividing by two.
- Vehicle normal load on the tire: load on an individual tire that is determined by distributing to each axle its share of the curb weight, accessory weight, and normal occupant weight and dividing by two.
- Maximum loaded vehicle weight: the sum of -
 - (a) Curb weight;
 - (b) Accessory weight;
 - (c) Vehicle capacity weight; and
 - (d) Production options weight.
- Curb weight: the weight of a motor vehicle with standard equipment including the maximum capacity of fuel, oil, and coolant.
- Accessory weight: the combined weight (in excess of those standard items which may be replaced) of automatic transaxle, power steering, power brakes, power windows, power seats, radio, and heater, to the extent that these items are available as factory-installed equipment (whether installed or not).
- Vehicle capacity weight: the rated cargo and luggage load plus 150 lbs (68 kg)* times the vehicle's designated seating capacity.
- Production options weight: the combined weight of those installed regular production options weighing over 5 lbs (2.3 kg) in excess of those standard items which they replace, not previously considered in curb weight or accessory weight, including heavy duty brakes, ride levelers, roof rack, heavy duty battery, and special trim.
- Normal occupant weight: 150 lbs (68 kg)* times the number of specified occupants (3 in the case of your vehicle)
- Occupant distribution: Occupant distribution within the passenger compartment (In your vehicle the distribution is 2 in front, 1 in rear seat)

*:150 lbs (68 kg) is the weight of one person as defined by U.S.A. and Canadian regulations.

Tire and loading information placard

N00630101423

The tire and loading information placard is located on the inside sill of the driver's door.

6

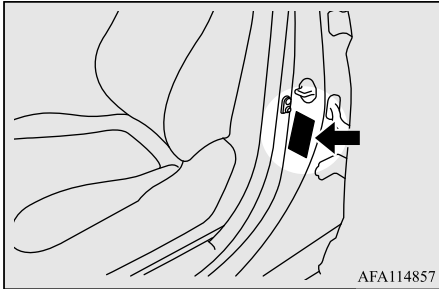

This placard shows the maximum number of occupants permitted to ride in your vehicle as well as “the combined weight of occupants and cargo” (A), which is called the vehicle capacity weight. The weight of any non-factory installed options, as well as the tongue weight of a trailer being towed and roof load is included in the definition of “cargo” when determining the vehicle capacity

weight. This placard also tells you the size and recommended inflation pressure for the original equipment tires on your vehicle. For more information, refer to “Tires” on page 9-12.

Type 1

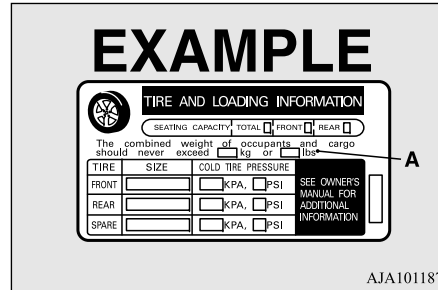

Type 2

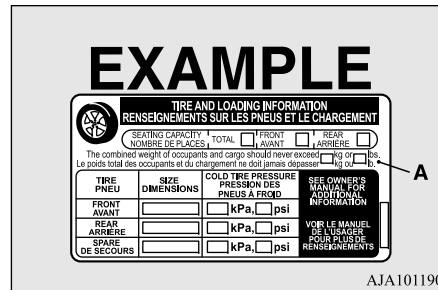

Steps for Determining Correct Load Limit

N00630201222

1. Locate the statement “The combined weight of occupants and cargo should never exceed XXX kg or XXX lbs.” on your vehicle’s placard.
2. Determine the combined weight of the driver and passengers that will be riding in your vehicle.
3. Subtract the combined weight of the driver and passengers from XXX kg or XXX lbs.
4. The resulting figure equals the available amount of cargo and luggage load capacity. For example, if the “XXX” amount equals 1400 lbs. and there will be five 150 lbs. passengers in your vehicle, the amount of available cargo and luggage load capacity is 650 lbs. (1400 - 750 (5 x 150) = 650 lbs.)

5. Determine the combined weight of luggage and cargo being loaded on the vehicle. That weight may not safely exceed the available cargo and luggage load capacity calculated in Step 4.
6. If your vehicle will be towing a trailer, load from your trailer will be transferred to your vehicle. Consult this manual to determine how this reduces the available cargo and luggage load capacity of your vehicle.

NOTE

- The following table shows examples on how to calculate total load, cargo/luggage and towing capacities of your vehicle with varying seating configurations and number and size of occupants. This table is for illustration purposes only and may not be accurate for the seating and load carry capacity of your vehicle.
- For the following example the combined weight of occupants and cargo should never exceed 865 lbs (392 kg).

Occupants			Combined weight of occupants and cargo from Tire Placard	MINUS	Combined Occupant's weight	= AVAILABLE Cargo/Luggage and Trailer Tongue Weight
TOTAL	FRONT	REAR				
<u>EXAMPLE 1</u>			↓	minus	Occupant 1: 200 lbs (91 kg) Occupant 2: 130 lbs (59 kg) Occupant 3: 160 lbs (73 kg) Occupant 4: 100 lbs (45 kg) Occupant 5: 80 lbs (36 kg) <hr/> TOTAL WEIGHT: 670 lbs (304 kg)	↓
5	2	3				
<u>EXAMPLE 2</u>			↓	minus	Occupant 1: 210 lbs (95 kg) Occupant 2: 180 lbs (82 kg) Occupant 3: 150 lbs (68 kg) <hr/> TOTAL WEIGHT: 540 lbs (245 kg)	↓
3	2	1				
<u>EXAMPLE 3</u>			↓	minus	Occupant 1: 200 lbs (91 kg) Occupant 2: 200 lbs (91 kg) <hr/> TOTAL WEIGHT: 400 lbs (182 kg)	↓
2	2	0				

AJM100083

NOTE

- Under a maximum loaded vehicle condition, gross axle weight ratings (GAWR's) for the front and rear axles must not be exceeded. For further information on GAWR's, vehicle loading and trailer towing, see the "Specifications" section of this manual.

Cargo loads

N00629700435

Cargo load precautions

N00630301122

To determine the cargo load capacity for your vehicle, subtract the weight of all vehicle occupants from the vehicle capacity weight. For additional information, if needed, refer to "Steps for Determining Correct Load Limit" on page 6-8.

DO NOT USE the Gross Vehicle Weight Rating and Gross Axle Weight Rating numbers listed on the safety certification label located on the inside sill of the driver's door as the guide for passengers and/or cargo weight.

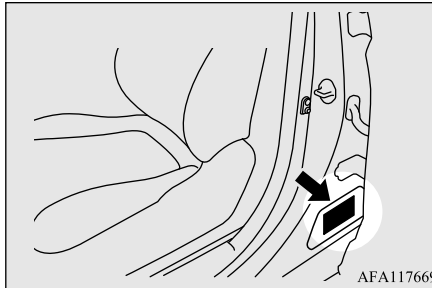
**WARNING**

- To reduce the risk of serious injury or death, the combined weights of the driver, passengers and cargo must never exceed the vehicle capacity weight.
- Exceeding the vehicle capacity weight will adversely affect vehicle performance, including handling and braking, and may cause an accident.

WARNING

- Do not load cargo or luggage higher than the top of the seatback. Be sure that your cargo or luggage cannot move when your vehicle is in motion. Having either the rear view blocked, or your cargo being thrown inside the cabin if you suddenly have to brake can cause a serious accident or injury or death.
- Put cargo or luggage in the cargo area of your vehicle. Try to spread the weight evenly.

Loading cargo on the roof (Vehicles equipped with roof rails)

N00630401181

WARNING

- Weight placed on the roof of the vehicle will raise the vehicle's center of gravity and adversely affect its handling characteristics. As a result, driving errors or emergency maneuvers could lead to a loss of control and result in an accident. Drive slowly and avoid excessive maneuvers such as sudden braking or quick turning.
- Make sure that the weight of luggage and the roof carrier do not exceed the maximum roof load, 110 lb (50 kg). If the maximum roof load is exceeded, this could cause damage to the vehicle or result in an accident.
- The total weight of all occupants and luggage, including your roof load, must not exceed the vehicle capacity weight. For more information, refer to "Tire and loading information placard" on page 11-3.
- Roof load is determined by adding the weight of the roof carrier and the weight of the luggage placed on the roof carrier.
- For additional information, refer to "Maximum roof load" on page 11-5.

CAUTION

- Do not load luggage directly onto the roof. Use a roof carrier that properly fits your vehicle.
For installation, refer to the instruction manual provided with the roof carrier.
- Place the luggage on the carrier so that its weight is distributed evenly with the heaviest items on the bottom. Do not load items that are wider than the roof carrier.
- Before driving and after traveling a short distance, always check the load to make sure it is securely fastened to the roof carrier. Stop the vehicle periodically and check that the load remains secure. If the load is not secure, it could fall from the vehicle and damage your vehicle, another vehicle or create a road hazard.

NOTE

- To prevent wind noise or reduction in gas mileage, remove the roof carrier when not in use.
- Before using an automatic car wash, check with the attendant to determine if the roof carrier should be removed.
- Be sure that adequate clearance is maintained for raising the sunroof and/or liftgate when installing a roof carrier. (For vehicle with sunroof only)

Roof carrier mounting bracket cover (if so equipped)

N00630601154

When installing the roof carrier, use the provided brackets.

The brackets are located under each cover.

To remove the covers

1. Slide each cover (A) toward the front of the vehicle.
2. Lift the front edge of the cover (A).

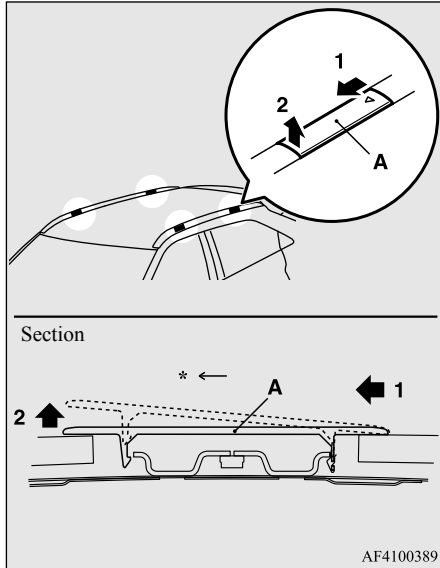

*: Front of the vehicle

To install the covers

Install the covers by performing the removal step in reverse.

Trailer towing

N00629801462

Towing a trailer will adversely affect your vehicle's handling, performance, braking, durability and driving economy (fuel consumption, etc.).

If you do tow a trailer with this vehicle, be sure to use proper equipment and cautious steering and braking for safe driving.

⚠ CAUTION

- Do not lose control of your vehicle when towing a trailer.
- Always use proper equipment.
- Always drive carefully.
- Damage to your vehicle caused by improper equipment or driving is not covered by your warranty.

Weight limits

Never exceed the vehicle capacity weight, maximum trailer weight (A), maximum tongue weight (B) and Gross Axle Weight Rating (GAWR).

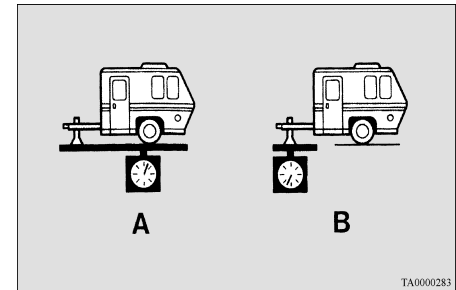

6

Vehicle capacity weight

The vehicle capacity weight is printed on the tire and loading information placard as “combined weight of occupants and cargo”.

The weight includes the weight of all occupants and the total weight it can carry.

For more information, refer to “Tire and loading information placard” on

Maximum trailer weight

Recommendations for towing up to this limit are as follows.

Vehicle condition	Maximum trailer weight
1 or 2 persons seated	With brake 2,000 lb (907 kg) Without brake 1,250 lb (567 kg)
3–5 persons seated	With brake 1,500 lb (680 kg) Without brake 1,250 lb (567 kg)

Tongue weight

The tongue weight of any trailer is important because it affects the vehicle capacity weight.

The vehicle capacity weight includes any cargo you may carry, and the people who will be riding in the vehicle. If you will tow a trailer, you must include the tongue weight of the trailer in your calculation of the vehicle capacity weight. For more information regarding vehicle capacity weight, refer to “Tire and loading information placard” on page 6-8.

Do not exceed the maximum tongue weight for your vehicle.

Vehicle condition	Maximum tongue weight
1 or 2 persons seated	With brake 200 lb (91 kg) Without brake 125 lb (57 kg)

Vehicle condition	Maximum tongue weight
3–5 persons seated	With brake 150 lb (68 kg) Without brake 125 lb (57 kg)

After you’ve loaded your trailer, weigh the trailer and then the tongue, separately, to see if the weights are proper.

Keep the trailer tongue load at 10 % of the loaded trailer weight for dead weight hitches. Tongue loads can be adjusted by proper distribution of the load in the trailer. This can be checked by separately weighing the loaded trailer and then the tongue.

Gross axle weight rating (GAWR)

The GAWRs are printed on the certification label which is riveted on the door sill on the driver’s side.

Refer to “Vehicle labeling” on page 11-2.

Trailer hitches

Choose a proper hitch and ball, and make sure it is installed at a height that is compatible with the trailer.

Use a good equalizing hitch which uniformly distributes the trailer tongue load throughout the frame.

WARNING

- If you make any holes in the body of your vehicle for installing a trailer hitch, be sure to seal the holes later when you remove the hitch. If you don't seal them, deadly carbon monoxide (CO) from your exhaust can enter your vehicle. Refer to "Exhaust system" on page 9-23.

NOTE

- Mitsubishi Motors recommends that sway control be used whenever you are towing, to improve towing stability. For further information, please contact your authorized Mitsubishi Motors dealer.

Safety chains

A safety chain must always be used between the towing vehicle and the trailer. Leave sufficient slack in the chain for turns. The chain

should cross under the trailer tongue to prevent the tongue from dropping to the ground in case it becomes damaged or separated.

For correct safety chain procedures, consult your authorized Mitsubishi Motors dealer.

CAUTION

- Never tow a trailer without using a safety chain securely attached to both the trailer and the vehicle. If the coupling unit or hitch ball experiences a problem, the trailer may separate from your vehicle.

Maintenance when trailer towing

Your vehicle will need service more often when you're towing a trailer. Refer to "WARRANTY AND MAINTENANCE MANUAL". Especially important in trailer operation are automatic transaxle fluid, engine oil, rear axle oil, belt, cooling system and brake system. Each of these is covered in this manual.

For details, please refer to the "Vehicle care and maintenance" section.

Check periodically to see that all hitch nuts and bolts are tight.

Trailer brakes

Mitsubishi Motors recommends that any trailer having a total weight of 1,250 lb (567 kg) or more be equipped with its own electric or surge-type brakes.

If you choose electric brakes, be sure they are electrically actuated. Do not attempt to tap into your vehicle's hydraulic system. No matter how successful it may seem, any attempt to attach trailer brakes to your vehicle's hydraulic system will lower braking effectiveness and create a potential hazard.

Trailer lights

Trailer lights and equipment must comply with federal, state, and local regulations. Check with your local recreational vehicle dealer for the requirements in your area, and use only equipment designed for your vehicle.

Since lighting and wiring vary by trailer type and brand, you should have a qualified technician install a suitable connector between the vehicle and the trailer. Improper equipment or installation can cause damage to your vehicle's electrical system and affect your vehicle warranty.

Additional trailer equipment

Many states and Canadian provinces require special outside mirrors when towing a trailer. Even if not required, you should install special mirrors if you cannot clearly see behind you, or if the trailer creates a blind spot.

6 Ask your trailer sales or rental agency if any other items are recommended or required for your towing situation.

Operating hints

WARNING

- If you have a rear window open and you tow a trailer with your vehicle, carbon monoxide gas which you cannot see or smell could come into your vehicle. It can cause unconsciousness or death. Refer to “Exhaust system” on page 9-23.

To maximize your safety when towing a trailer:

- Have your exhaust system inspected for leaks, and make necessary repairs before starting on your trip.
- Keep the rear windows closed.

WARNING

- If exhaust does come into your vehicle through a window or another opening, drive with your front, main heating or cooling system on and with the blower on any speed. This will bring fresh, outside air into your vehicle. Do not use recirculation because it only recirculates the air inside your vehicle. Refer to “Air selection switch” on page 7-9.

Driver preparation

Towing a trailer requires a certain amount of experience.

Before setting out for the open road, you’ll want to get to know your trailer. Acquaint yourself with the feel of handling and braking with the added weight of the trailer. Always keep in mind that the vehicle you are driving is now a good deal longer and not nearly as responsive as your vehicle is without a trailer.

Vehicle preparation

Before you start, check the trailer hitch, safety chains, tires and mirror adjustment.

Tire

Be sure your vehicle’s tires are inflated to the cold inflation pressure listed in the manual. You’ll find these numbers on the tire and loading information placard at the sill of the driver’s door.

Refer to “Tire inflation pressures” on page 9-16.

Following distance

Stay at least twice as far behind the vehicle ahead as you would when driving your vehicle without a trailer. This can help you avoid situations that require heavy braking and sudden turns.

Passing

You’ll need more passing distance up ahead when you’re towing a trailer. And, because you’re a good deal longer, you’ll need to go much farther beyond the passed vehicle before you can return to your lane.

Backing up

Hold the bottom of the steering wheel with one hand. Then, to move the trailer to the left, just move that hand to the left. To move the trailer to the right, move your hand to the right. Always back up slowly and, if possible, have someone guide you.

Making turns

CAUTION

- Making sharp turns while towing a trailer could cause the trailer to come in contact with the vehicle. Your vehicle could be damaged. Avoid making sharp turns while towing a trailer.

When you're turning with a trailer, make wider than normal turns to help prevent the trailer from striking shoulders, curbs, road signs, trees or other objects.

Avoid jerky or sudden maneuvers. Signal well in advance.



Overheating

Towing a trailer puts additional burden on the engine and transaxle, which may cause over-

heating. Following are some suggestions to reduce overheating:

Cause of overheating	Solution
Air conditioning on	Turn off
Highway speeds	Reduce speed
Going up hills	Select lower gear position
Stop-and-go city traffic	With the vehicle stopped, shift to the "N" (NEUTRAL) position and idle the engine at high idle.

When towing at high altitudes, engine coolant and automatic transaxle fluid will overheat at a lower temperature than at normal altitudes. If you turn your engine off immediately after towing at high altitude on steep uphill grades, your vehicle may show signs similar to overheating. To avoid this, let the engine run while parked (preferably on level ground) with the automatic transaxle in the "P" (PARK) position for a few minutes before turning the engine off.

- If the engine coolant temperature indicator  flashes on the information screen in the multi-information display or the engine power drops suddenly, refer to "Engine overheating" on page 8-4.
- If the  warning display or  warning display illuminates, refer to "Warning display" on page 5-66.

Driving on hills

Reduce speed and downshift before you start down a long or steep downgrade. If you don't downshift, prolonged or frequent application of the brakes can cause reduced braking efficiency and performance.

You can tow in "D" (DRIVE) position. However, you may want to shift the selector lever to the 3rd or a lower position, under heavy loads or hilly conditions.

Parking

Always place chocks or blocks under both the vehicle and trailer wheels when parking. Be sure that the parking brake is firmly set and that the selector lever is in the "P" (PARK) position. Avoid parking on a hill with a trailer, but if it cannot be avoided, do so only after performing the following:

Trailer towing

1. Apply the brakes and keep them applied.
2. Have someone place chocks or blocks under both the vehicle and trailer wheels.
3. When the chocks or blocks are in place, release your brakes slowly until the chocks or blocks absorb the load.
4. Apply the parking brake firmly.
5. Set the selector lever to the “P” (PARK) position and turn off the engine.

6

When restarting out after parking on a hill:

1. Check that the selector lever is set to the “P” (PARK) position.
2. Start the engine. Be sure to keep the brake pedal depressed.
3. Set the selector lever to the “D” (DRIVE) position or “R” (REVERSE) position.
4. Release the parking brake and brake pedal and slowly pull or back away from the chocks or blocks. Stop and apply your brakes.
5. Have someone retrieve the chocks or blocks.

Comfort controls

Important air conditioning operation tips	7-2
Vents	7-2
Automatic air conditioning (if so equipped).....	7-6
Dual-zone automatic climate control air conditioning (if so equipped)	7-15
Air purifier	7-23
General information about your radio	7-23

Important air conditioning operation tips

N00733701405

⚠ CAUTION

- The engine speed may increase when the air conditioning is operating. With increased engine speed, a CVT equipped vehicle will creep to a greater degree than with a lower engine speed. Fully depress the brake pedal to prevent the vehicle from creeping.

7

1. Park the vehicle in the shade whenever possible. Parking in the hot sun makes the vehicle interior extremely hot which then requires more time to cool. If it is necessary to park in the sun, open the windows for the first few minutes of air conditioning to expel the hot air.
2. Afterwards, keep the windows closed when the air conditioning is in use. The entry of outside air through open windows will reduce cooling efficiency.
3. When running the air conditioning, make sure the air intake, which is located in front of the windshield, is free of obstructions such as leaves. Leaves collected in the air-intake chamber may reduce air flow and plug the water drains.

Air conditioning system refrigerant and lubricant recommendations

If the air conditioning seems less effective than usual, the cause might be a refrigerant leak.

Have the system inspected by your authorized Mitsubishi Motors dealer or a repair facility of your choice.

⚠ CAUTION

- The air conditioning system in your vehicle must be charged with the refrigerant HFO-1234yf and the lubricant PAG46A. Use of any other refrigerant or lubricant will cause severe damage and may require replacing your vehicle's entire air conditioning system. The release of refrigerant into the atmosphere is not recommended. The new refrigerant HFO-1234yf in your vehicle is designed not to harm the earth's ozone layer. However, it may contribute slightly to global warming. It is recommended that the old refrigerant be saved and recycled for future use.

During a long period of disuse

The air conditioning should be operated for at least five minutes each week, even in cold weather. This includes the quick defrosting mode. Operating the air conditioning system weekly maintains lubrication of the compressor internal parts to keep the air conditioning in the best operating condition.

Vents

N00729901318

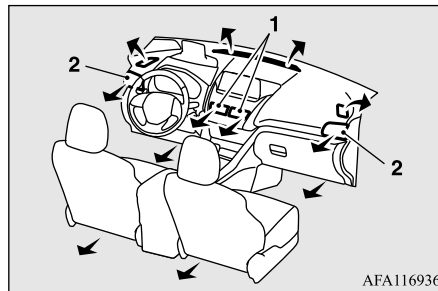

AFA116936

- 1- Center vents
- 2- Side vents

Air flow and direction adjustments

N00730201412

Center vents

Move the knob (A) to make adjustments.
To close the vent, move the knob (A) to the inside as far as possible.

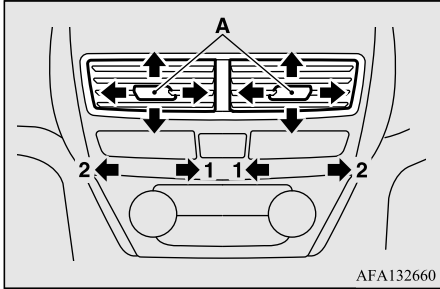

AFA132660

- 1- Close
- 2- Open

Side vents

Move the knob (A) to make adjustments.
To close the vent, move the knob (A) to the outside as far as possible.

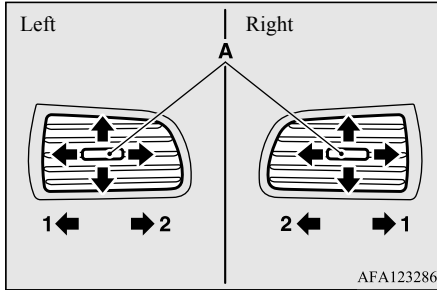

AFA123286

- 1- Close
- 2- Open

NOTE

- On rare occasions, air from the vents of an air-conditioned vehicle may be foggy. This is only due to moist air cooling suddenly and does not indicate a problem.
- Do not let drinks or other liquids get into the vents as they could prevent the air conditioning from operating normally.

Changing the mode selection

N00736401823

To change the position and amount of air flowing from the vents, press the MODE switch or defogger switch. Refer to “MODE switch” on page 7-9, 7-18 and “Defogger switch” on page 7-9, 7-18.

These symbols are used in the next several illustrations to demonstrate the quantity of air coming from the vents.

- : Small amount of air from the vents
- ➔ : Medium amount of air from the vents
- ➔➔ : Large amount of air from the vents

Face position

Air flows only to the upper part of the passenger compartment.

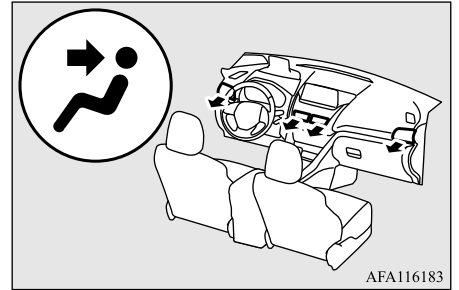

AFA116183

Foot/Face position

Air flows to the upper part of the passenger compartment, and flows to the leg area.

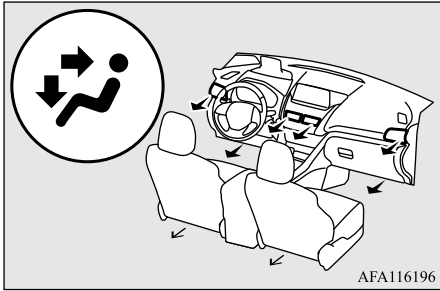

Foot position

Air flows mainly to the leg area.

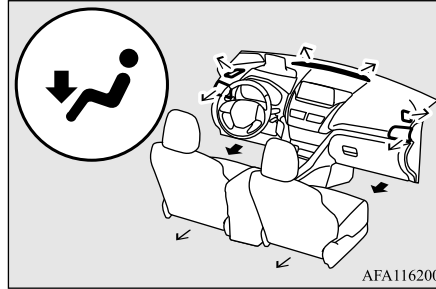

Foot/Defroster position

Air flows to the leg area, the windshield and the door windows.

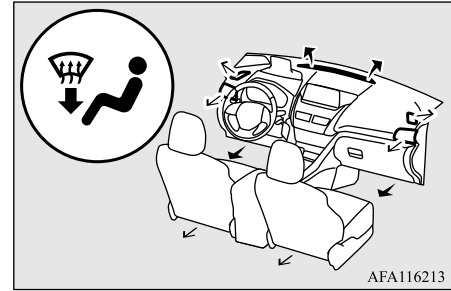

NOTE

- The foot/face air flow ratio can be adjusted with the mode selection in the “” position. For further information, we recommend you consult an authorized Mitsubishi Motors dealer or a repair facility of your choice. On vehicles equipped with the Smartphone-link Display Audio (SDA) or the Smartphone-link Display Audio (SDA) navigation system, screen operations can be used to make the adjustment. Refer to the separate owner’s manual for details.

NOTE

- The foot/defroster air flow ratio can be adjusted with the mode selection in the “” position. For further information, we recommend you consult an authorized Mitsubishi Motors dealer or a repair facility of your choice. On vehicles equipped with the Smartphone-link Display Audio (SDA) or the Smartphone-link Display Audio (SDA) navigation system, screen operations can be used to make the adjustment. Refer to the separate owner’s manual for details.

Defroster position

Air flows mainly to the windshield and the door windows.

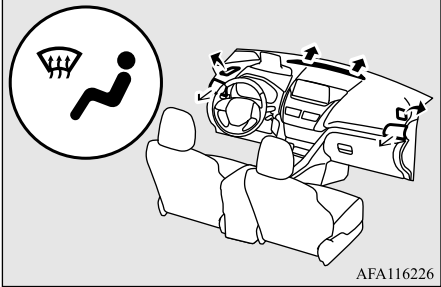

Automatic air conditioning (if so equipped)

N00731501470

The air conditioning can only be used while the engine is running.

Control panel

N00711801842

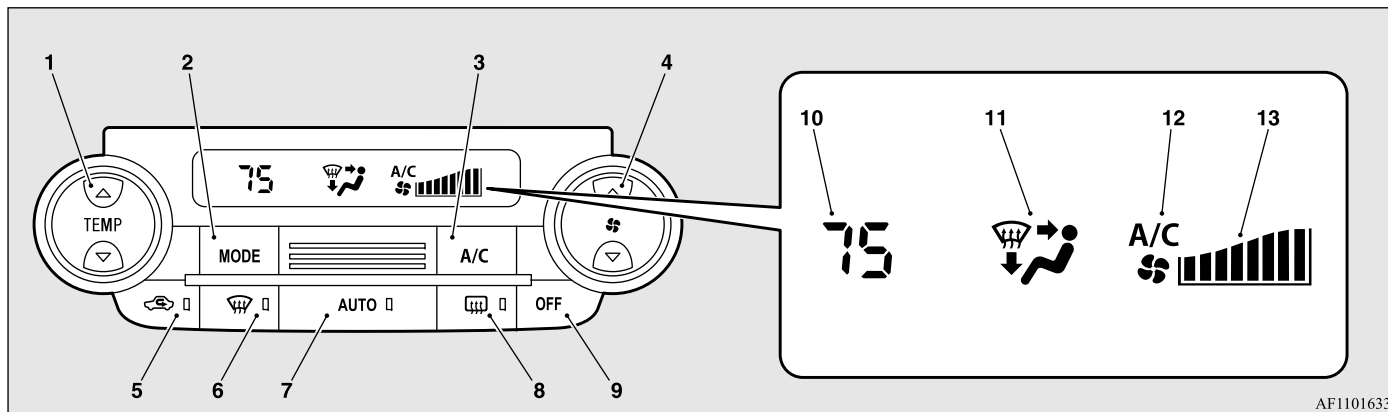

AF1101633

- 1- Temperature control switch → P.7-8
- 2- MODE switch → P.7-9
- 3- Air conditioning switch → P.7-10
- 4- Blower speed selection switch → P.7-7
- 5- Air selection switch → P.7-9
- 6- Defogger switch → P.7-9
- 7- AUTO switch → P.7-12
- 8- Electric rear window defogger switch
→ P.5-211

- 9- OFF switch → P.7-12
- 10- Temperature display → P.7-8
- 11- Mode selection display → P.7-9
- 12- Air conditioning indicator → P.7-10
- 13- Blower speed display → P.7-7

NOTE

- There is an interior air temperature sensor (A) in the illustrated position. Never place anything over the sensor, since doing so will prevent it from functioning properly.

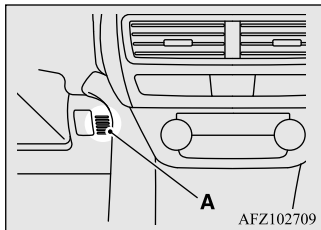

- Since the air conditioning operation is controlled while the ECO mode is operating, you may feel that effectiveness of the air conditioning is insufficient. Refer to "ECO mode switch" on page 5-204.
- Even during ECO mode operation, you can select normal operation of the air conditioning. On vehicles equipped with the Smartphone-link Display Audio (SDA), screen operations can be used to change the setting. Refer to the separate owner's manual for details.
- In extreme cold, the air conditioning control panel screen may operate sluggishly. This does not indicate a problem. It will disappear when the vehicle interior temperature rises to a normal temperature.

Blower speed selection switch

N00736901323

Press ▲ of the blower speed selection switch to increase the blower speed.
Press ▼ of the blower speed selection switch to decrease the blower speed.
The selected blower speed (A) will be shown in the display.

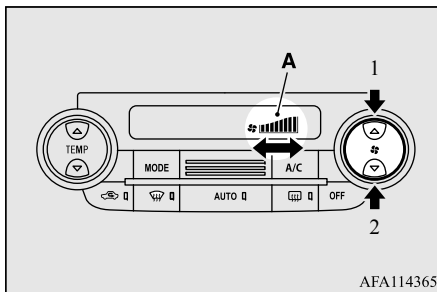

- Increase
- Decrease

NOTE

- Due to a drop in the battery voltage or some other problem, the blower speed may temporarily become less than the selected blower speed display setting or the fan may stop. If the fan stops, turn the ignition switch to the "OFF" position, wait a few minutes, and then turn the ignition switch back to the "ON" position. In the following cases, have the system inspected by your authorized Mitsubishi Motors dealer or a repair facility of your choice.
 - The blower speed remains lower than the blower speed set using the blower speed display or the blower speed decreases frequently.
 - The fan does not operate even after stopping and restarting the engine or the fan stops frequently.

Temperature control switch

N00737001510

Press ▲ of the temperature control switch to increase the temperature.

Press ▼ of the temperature control switch to decrease the temperature.

The selected temperature (A) will be shown in the display.

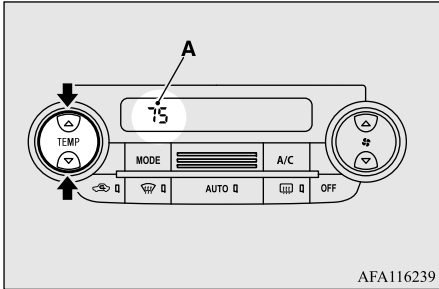

NOTE

- The temperature value of the air conditioning is switched in conjunction with the outside temperature display unit of the multi-information display. Refer to “Changing the temperature unit” on page 5-158.

NOTE

- When the engine coolant temperature is low, the air temperature from the heater will be cool/cold until the engine warms up, even if you have selected warm air with the switch. To prevent the windshield and windows from fogging up, the vent mode will be changed to “” and the blower speed will be reduced while the system is operating in the AUTO mode.
- When you feel that it is hotter or colder than the set temperature, you may adjust it to your preference. For further information, we recommend you consult an authorized Mitsubishi Motors dealer or a repair facility of your choice.
- When the temperature is set to the highest or the lowest setting, the air selection and the air conditioning will be automatically changed as follows. Also, if the air selection is operated manually after an automatic changeover, manual operation will be selected.
 - Quick Heating (When the temperature is set to the highest setting)
Outside air will be introduced and the air conditioning will stop.
 - Quick Cooling (When the temperature is set to the lowest setting)
Inside air will be recirculated and the air conditioning will operate.

air conditioning switch to match your personal preferences.

Contact your authorized Mitsubishi Motors dealer or a repair facility of your choice for assistance.

Refer to “Personalizing the air conditioning switch (Changing the function setting)” on page 7-11.

Refer to “Personalizing the air selection (Changing the function setting)” on page 7-10.

The above indicates the factory settings. You can personalize the air selection switch and

MODE switch

N00737101289

To change the amount of air flowing from the vents, press the MODE switch. Each time the MODE switch is pressed, the mode changes to the next one in the following sequence: “” → “” → “” → “” → “” → “”. The selected mode is shown in the display (A). Refer to “Changing the mode selection” on page 7-3.

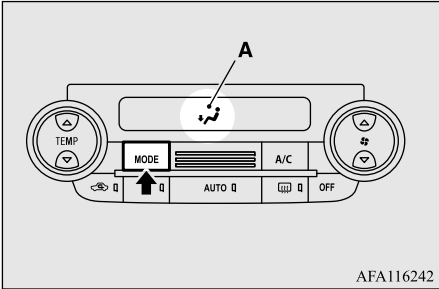

AFA116242

Defogger switch

N00703401096

When this switch is pressed, the mode changes to the “” mode and the blower speed will be set at the maximum automatically. The indicator light (A) will come on and the “” mode is shown in the display (B).

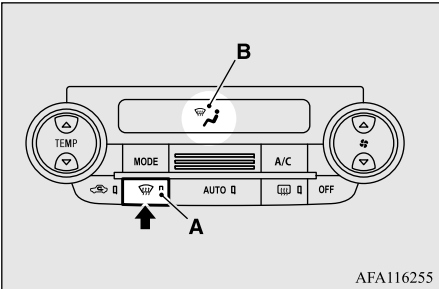

AFA116255

NOTE

- When the defogger switch is pressed, the air conditioning system automatically operates and outside air (as opposed to recirculated air) is selected. This automatic switching control is carried out to prevent misting of the windows even if “Disable automatic air conditioning control” or “Disable automatic air selection control” is set. Refer to “Personalizing the air conditioning switch (Changing the function setting)” on page 7-11, “Personalizing the air selection (Changing the function setting)” on page 7-10.
- The indicator light (A) will go off when adjusting the blower speed.

Air selection switch

N00737201479

Normally, use the outside air position to keep the windshield and side windows clear and to quickly remove fog or frost from the windshield.

To change the air selection, simply press the air selection switch.

- Outside air {Indicator light (A) OFF}
Outside air is introduced into the passenger compartment.
- Recirculated air {Indicator light (A) ON}
Air is recirculated inside the passenger compartment.

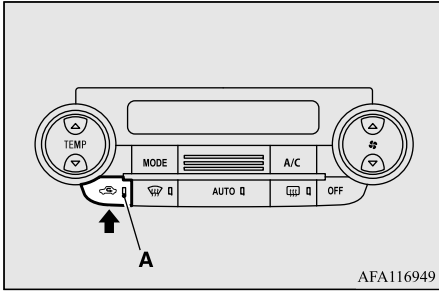

7 When the air conditioning turns on, the air selection is controlled automatically. When the air conditioning turns off, the air selection automatically goes back to the outside position.

If high cooling performance is desired, or if the outside air is dusty or contaminated in some way, use the recirculation position. Switch to the outside position every now and then to keep the windows from fogging up.

CAUTION

- Using recirculated air for a long time may cause the windows to fog up.

NOTE

- If the mode selection is set “” position, you cannot turn the air conditioning off or select the recirculation position. This prevents the windows from fogging up.

NOTE

- When the engine coolant temperature rises to a certain level, the air selection is automatically switched to the recirculation position and the indicator light (A) comes on. At this time, the system will not switch to the outside position even if the air selection switch is pushed.

■ Personalizing the air selection (Changing the function setting)

N00712300108

You can change the following functions to match your preference.

- Enable automatic air selection control:
When the AUTO switch is pressed, the air selection switch will also be automatically controlled.
- Disable automatic air selection control:
Even when the AUTO switch is pressed, the air selection switch will not be automatically controlled.
- Changing the settings:
Press the air selection switch for approximately 10 seconds or longer. When the setting has changed, the system will beep and the indicator light will flash.

- When the setting has changed from enabled to disabled, the system will beep three times and the indicator light will flash three times.
 - When the setting has changed from disabled to enabled, the system will beep two times and the indicator light will flash three times.
- On vehicles equipped with the Smartphone-link Display Audio (SDA), screen operations can also be used to change the setting. Refer to the separate owner’s manual for details.

NOTE

- The factory setting is “Enable automatic air selection control”.
- When the defogger switch is pressed, the air selection will automatically change to the outside air position, even if the system is set to “Disable automatic air selection control”, in order to prevent windows from fogging up.

Air conditioning switch

N00737301470

Push the switch, and the air conditioning compressor will turn on. The “A/C” indicator (A) will be shown in the display.

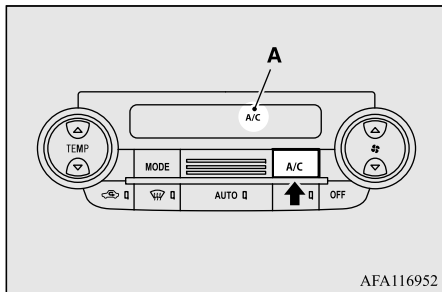

Push the switch again and the air conditioning compressor will stop and the indicator goes off.

NOTE

- If a problem is detected in the air conditioning compressor, the “A/C” indicator blinks. Press the air conditioning switch once to turn it off, then once more to turn it back on. If the “A/C” indicator does not blink, there is no problem. If it does blink, have it checked at an authorized Mitsubishi Motors dealer or a repair facility of your choice.
- For example, sometimes after using a high-pressure car wash, the condenser can get wet, and the “A/C” indicator blinks temporarily. Wait for a while, press the air conditioning switch once to turn the system off, then once more to turn it back on. Once the water evaporates, the blinking will stop.

■ Personalizing the air conditioning switch (Changing the function setting)

N00712200123

You can change the following functions to match your preference.

- Enable automatic air conditioning control: When the AUTO switch is pressed, or when the temperature control switch has been set to the minimum temperature, the air conditioning switch is automatically controlled.
- Disable automatic air conditioning control: The air conditioning switch is not automatically controlled, unless the air conditioning switch is used.
- Changing the settings: Press the air conditioning switch for approximately 10 seconds or longer. When the setting has changed, the system will beep and the indicator light will flash.
 - When the setting has changed from enabled to disabled, the system will beep three times and the indicator light will flash three times.
 - When the setting has changed from disabled to enabled, the system will beep two times and the indicator light will flash three times.

On vehicles equipped with the Smart-phone-link Display Audio (SDA), screen operations can also be used to change the setting. Refer to the separate owner’s manual for details.

NOTE

- The factory setting is “Enable automatic air conditioning control”.
- When the defogger switch is pressed, the air conditioning will run automatically, even if the system is set to “Disable automatic air conditioning control”, in order to prevent windows from fogging up.

AUTO switch

N00703501071

When the AUTO switch is pressed, the indicator light (A) comes on and the mode selection, blower speed adjustment, recirculated/outside air selection, temperature adjustment, and air conditioning ON/OFF status are all controlled automatically. The selected mode and the blower speed are not shown in the display.

7

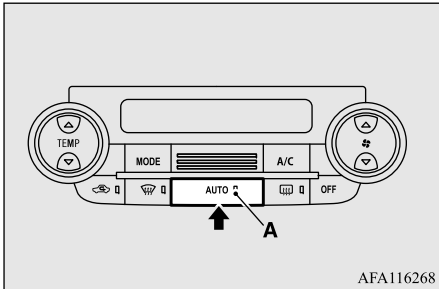

OFF switch

N00703601043

Push the switch to turn off the air conditioning system.

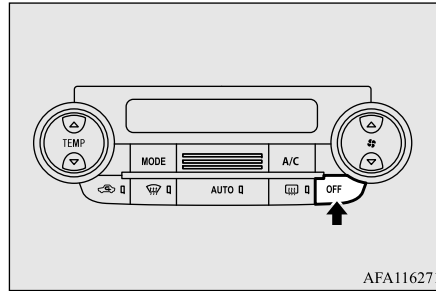

Operating the air conditioning system (automatic mode)

N00731701603

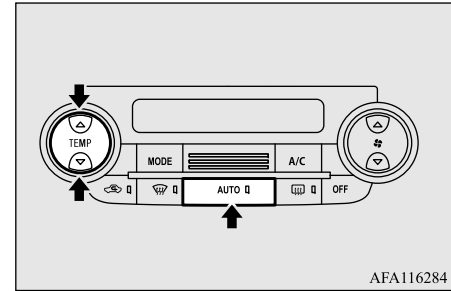

In normal conditions, use the system in the AUTO mode and follow these procedures:

1. Push the AUTO switch.
2. Set the temperature control switch to the desired temperature. The temperature can be set within a range of around 61 (LO) to 89 (HI) (when the outside temperature unit of the multi-information display shows °F) or 17 (LO) to 31 (HI) (when the outside temperature unit of the multi-information display shows °C).

The vents, recirculated/outside air, blower speed, temperature adjustment, and ON/OFF of air conditioning will be controlled automatically.

NOTE

- Set the temperature at approximately 75 (when the outside temperature unit of the multi-information display shows °F) or 24 (when the outside temperature unit of the multi-information display shows °C) under normal conditions.
- When the engine coolant temperature is low, the air temperature from the heater will be cool/cold until the engine warms up, even if you have selected warm air with the temperature switch. To prevent the windshield and windows from fogging up, the vent mode will be changed to “” and the blower speed will be reduced.

Operating the air conditioning system (manual mode)

N00731801170

Blower speed and vent mode may be controlled manually by setting the blower speed selection switch and the MODE switch to the desired positions. To return to automatic operation, press the AUTO switch.

Defrosting or defogging (windshield, door windows)

N00732401623

CAUTION

- For safety, make sure you have a clear view through all the windows.

To remove frost or mist from the windshield and door windows, use the MODE switch or defogger switch (“” or “”).

For ordinary defrosting

Use this setting to keep the windshield and door windows clear of mist, and to keep the leg area heated (when driving in rain or snow).

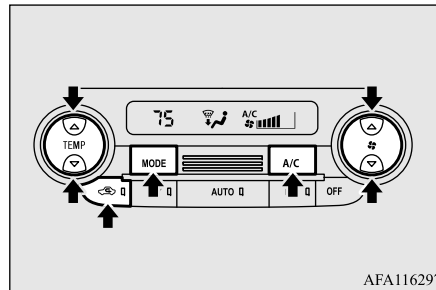

AFA116297

1. Set the air selection switch to the outside position.

2. Set the MODE switch to the “” position.
3. Select your desired blower speed by pressing the blower speed selection switch.
4. Select your desired temperature by pressing the temperature control switch.
5. Push the air conditioning switch.

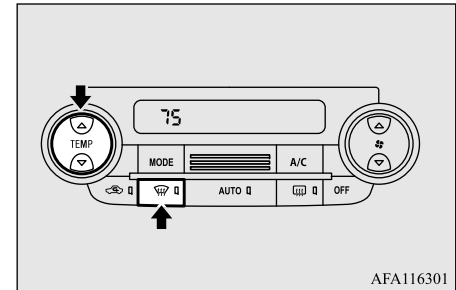
For quick defrosting

AFA116301

1. Push the defogger switch.
2. Set the temperature to the highest position.

NOTE

- While the “” indicator light is on, the air conditioning compressor will run automatically. The outside air position will also be selected and the blower speed will be set at the maximum automatically.

 **NOTE**

- If the “” indicator light is on, you cannot turn the air conditioning off or select the recirculation position. This prevents the windows from fogging up.
- To defog quickly, direct the air flow from the side vents toward the door windows.
- When defrosting, do not set the temperature to the maximum cool position. This will blow cool air on the window glass and fog it up.

Dual-zone automatic climate control air conditioning (if so equipped)

N00731501483

The air conditioning can only be used while the engine is running.

Control panel

N00711801855

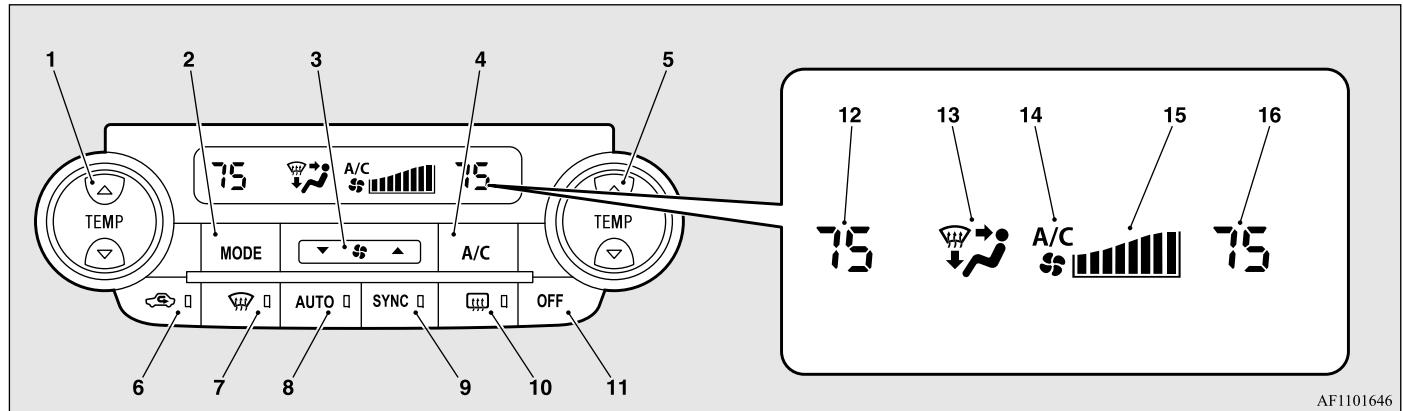

AF1101646

- | | | |
|---|--|---|
| 1- Driver's side temperature control switch → P.7-17 | 7- Defogger switch → P.7-18 | 14- Air conditioning indicator → P.7-20 |
| 2- MODE switch → P.7-18 | 8- AUTO switch → P.7-21 | 15- Blower speed display → P.7-16 |
| 3- Blower speed selection switch → P.7-16 | 9- SYNC switch → P.7-17 | 16- Passenger's side temperature display → P.7-17 |
| 4- Air conditioning switch → P.7-20 | 10- Electric rear window defogger switch → P.5-211 | |
| 5- Passenger's side temperature control switch → P.7-17 | 11- OFF switch → P.7-21 | |
| 6- Air selection switch → P.7-19 | 12- Driver's side temperature display → P.7-17 | |
| | 13- Mode selection display → P.7-18 | |

NOTE

- There is an interior air temperature sensor (A) in the illustrated position. Never place anything over the sensor, since doing so will prevent it from functioning properly.

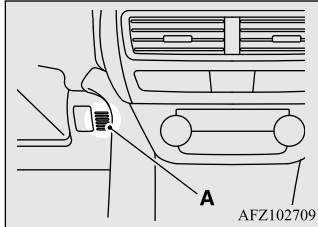

- Since the air conditioning operation is controlled while the ECO mode is operating, you may feel that effectiveness of the air conditioning is insufficient. Refer to “ECO mode switch” on page 5-204.
- Even during ECO mode operation, you can select normal operation of the air conditioning. On vehicles equipped with the Smartphone-link Display Audio (SDA) or the Smartphone-link Display Audio (SDA) navigation system, screen operations can be used to change the setting. Refer to the separate owner's manual for details.
- In extreme cold, the air conditioning control panel screen may operate sluggishly. This does not indicate a problem. It will disappear when the vehicle interior temperature rises to a normal temperature.

Blower speed selection switch

N00736901336

Press ▲ of the blower speed selection switch to increase the blower speed.
Press ▼ of the blower speed selection switch to decrease the blower speed.
The selected blower speed (A) will be shown in the display.

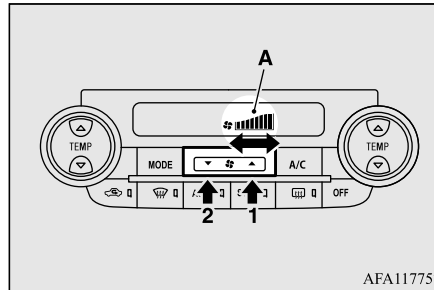

- 1- Increase
- 2- Decrease

NOTE

- Due to a drop in the battery voltage or some other problem, the blower speed may temporarily become less than the selected blower speed display setting or the fan may stop. If the fan stops, set the operation mode to OFF, wait a few minutes, and then set the operation mode back to ON. In the following cases, have the system inspected by your authorized Mitsubishi Motors dealer or a repair facility of your choice.
 - The blower speed remains lower than the blower speed set using the blower speed display or the blower speed decreases frequently.
 - The fan does not operate even after stopping and restarting the engine or the fan stops frequently.

Temperature control switch

N00737001523

Press ▲ of the temperature control switch to increase the temperature.

Press ▼ of the temperature control switch to decrease the temperature.

The selected temperature (A) will be shown in the display.

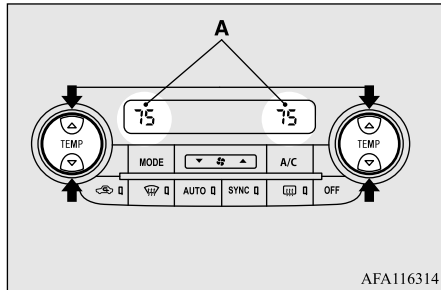

NOTE

- The temperature value of air conditioning is switched in conjunction with outside temperature display unit of the multi-information display.
Refer to “Changing the temperature unit” on page 5-158.

NOTE

- When the engine coolant temperature is low, the air temperature from the heater will be cool/cold until the engine warms up, even if you have selected warm air with the switch. To prevent the windshield and windows from fogging up, the vent mode will be changed to “☁” and the blower speed will be reduced while the system is operating in the AUTO mode.
- When you feel that it is hotter or colder than the set temperature, you may adjust it to your preference.
For further information, we recommend you consult an authorized Mitsubishi Motors dealer or a repair facility of your choice.
- When the temperature is set to the highest or the lowest setting, the air selection and the air conditioning will be automatically changed as follows. Also, if the air selection is operated manually after an automatic changeover, manual operation will be selected.
 - Quick Heating (When the temperature is set to the highest setting)
Outside air will be introduced and the air conditioning will stop.
 - Quick Cooling (When the temperature is set to the lowest setting)
Inside air will be recirculated and the air conditioning will operate.

The above indicates the factory settings. You can personalize the air selection switch and

air conditioning switch to match your personal preferences.

Contact your authorized Mitsubishi Motors dealer or a repair facility of your choice for assistance.

Refer to “Personalizing the air conditioning switch (Changing the function setting)” on page 7-20.

Refer to “Personalizing the air selection (Changing the function setting)” on page 7-19.

■ To control the driver’s side and the passenger’s side temperature independently

When the indicator light (A) goes off by pressing the passenger’s side temperature control switch (B) or the SYNC switch, the driver’s side and the passenger’s side temperature can be controlled independently of each other.

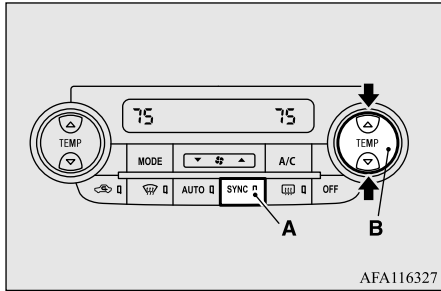

MODE switch

N00737101292

To change the amount of air flowing from the vents, press the MODE switch. Each time the MODE switch is pressed, the mode changes to the next one in the following sequence: “” → “” → “” → “” → “” → “”. The selected mode is shown in the display (A). Refer to “Changing the mode selection” on page 7-3.

Defogger switch

N00703401100

When this switch is pressed, the mode changes to the “” mode and the blower speed will be set at the maximum automatically. The indicator light (A) will come on and the “” mode is shown in the display (B).

7

NOTE

- When the indicator light (A) comes on by pressing the SYNC switch, the passenger’s side temperature will be controlled to the same setting temperature as the driver’s side. When the indicator light (A) illuminates, if the driver’s side temperature control switch is pressed, the passenger’s side setting temperature will be synchronized to the driver’s side.

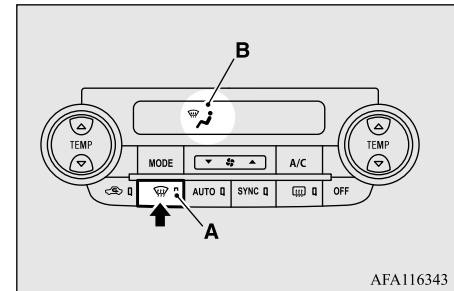
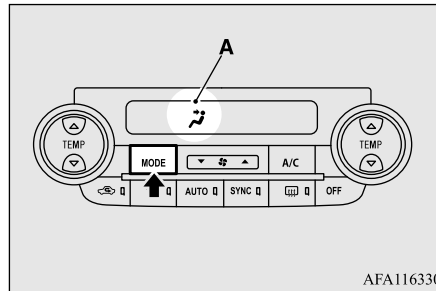

NOTE

- When the defogger switch is pressed, the air conditioning system automatically operates and outside air (as opposed to recirculated air) is selected. This automatic switching control is carried out to prevent misting of the windows even if “Disable automatic air conditioning control” or “Disable automatic air selection control” is set. Refer to “Personalizing the air conditioning switch (Changing the function setting)” on page 7-20, “Personalizing the air selection (Changing the function setting)” on page 7-19.
- The indicator light (A) will go off when adjusting the blower speed.

Air selection switch

N00737201482

Normally, use the outside air position to keep the windshield and side windows clear and to quickly remove fog or frost from the windshield.

To change the air selection, simply press the air selection switch.

- Outside air {Indicator light (A) OFF}
Outside air is introduced into the passenger compartment.
- Recirculated air {Indicator light (A) ON}
Air is recirculated inside the passenger compartment.

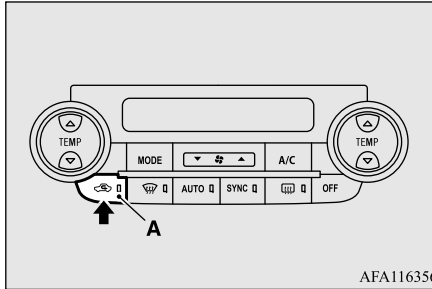

When the air conditioning turns on, the air selection is controlled automatically. When the air conditioning turns off, the air selection automatically goes back to the outside position.

If high cooling performance is desired, or if the outside air is dusty or contaminated in some way, use the recirculation position. Switch to the outside position every now and then to keep the windows from fogging up.

CAUTION

- Using recirculated air for a long time may cause the windows to fog up.

NOTE

- If the mode selection is set to the “ ” position, you cannot turn the air conditioning off or select the recirculation position. This prevents the windows from fogging up.

NOTE

- When the engine coolant temperature rises to a certain level, the air selection is automatically switched to the recirculation position and the indicator light (A) comes on. At this time, the system will not switch to the outside position even if the air selection switch is pushed.

Personalizing the air selection (Changing the function setting)

N00712300111

7

You can change the following functions to match your preference.

- Enable automatic air selection control:
When the AUTO switch is pressed, the air selection switch will also be automatically controlled.
- Disable automatic air selection control:
Even when the AUTO switch is pressed, the air selection switch will not be automatically controlled.
- Changing the settings:
Press the air selection switch for approximately 10 seconds or longer. When the setting has changed, the system will beep and the indicator light will flash.

Dual-zone automatic climate control air conditioning (if so equipped)

- When the setting has changed from enabled to disabled, the system will beep three times and the indicator light will flash three times.
- When the setting has changed from disabled to enabled, the system will beep two times and the indicator light will flash three times.

On vehicles equipped with the Smartphone-link Display Audio (SDA) or the Smartphone-link Display Audio (SDA) navigation system, screen operations can also be used to change the setting. Refer to the separate owner's manual for details.

7

NOTE

- The factory setting is “Enable automatic air selection control”.
- When the defogger switch is pressed, the air selection will automatically change to the outside air position, even if the system is set to “Disable automatic air selection control”, in order to prevent windows from fogging up.

Air conditioning switch

N00737301483

Push the switch, and the air conditioning compressor will turn on. The “A/C” indicator (A) will be shown in the display.

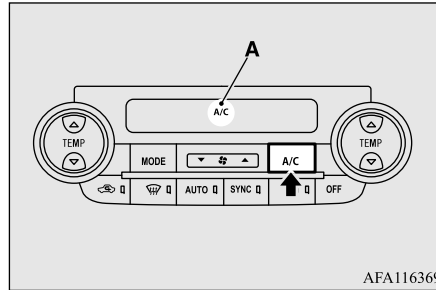

Push the switch again and the air conditioning compressor will stop and the indicator goes off.

NOTE

- If a problem is detected in the air conditioning compressor, the “A/C” indicator blinks. Press the air conditioning switch once to turn it off, then once more to turn it back on. If the “A/C” indicator does not blink, there is no problem. If it does blink, have it checked at an authorized Mitsubishi Motors dealer or a repair facility of your choice.
- For example, sometimes after using a high-pressure car wash, the condenser can get wet, and the “A/C” indicator blinks temporarily. Wait for a while, press the air conditioning switch once to turn the system off, then once more to turn it back on. Once the water evaporates, the blinking will stop.

■ Personalizing the air conditioning switch (Changing the function setting)

N00712200136

You can change the following functions to match your preference.

- Enable automatic air conditioning control: When the AUTO switch is pressed, or when the temperature control switch has been set to the minimum temperature, the air conditioning switch is automatically controlled.
- Disable automatic air conditioning control: The air conditioning switch is not automatically controlled, unless the air conditioning switch is used.
- Changing the settings: Press the air conditioning switch for approximately 10 seconds or longer. When the setting has changed, the system will beep and the indicator light will flash.
 - When the setting has changed from enabled to disabled, the system will beep three times and the indicator light will flash three times.
 - When the setting has changed from disabled to enabled, the system will beep two times and the indicator light will flash three times.

On vehicles equipped with the Smartphone-link Display Audio (SDA) or the Smartphone-link Display Audio (SDA) navigation system, screen operations can also be used to change the setting. Refer to the separate owner's manual for details.

NOTE

- The factory setting is “Enable automatic air conditioning control”.
- When the defogger switch is pressed, the air conditioning will run automatically, even if the system is set to “Disable automatic air conditioning control”, in order to prevent windows from fogging up.

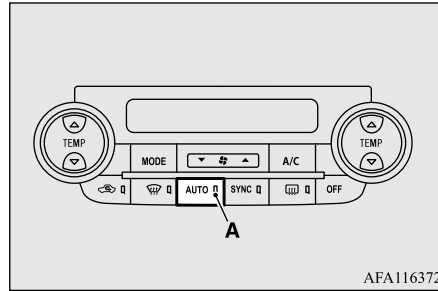

OFF switch

N00703601056

Push the switch to turn off the air conditioning system.

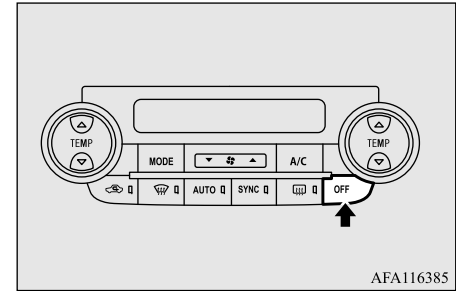

7

AUTO switch

N00703501084

When the AUTO switch is pressed, the indicator light (A) comes on and the mode selection, blower speed adjustment, recirculated/outside air selection, temperature adjustment, and air conditioning ON/OFF status are all controlled automatically. The selected mode and the blower speed are not shown in the display.

Operating the air conditioning system (automatic mode)

N00731701616

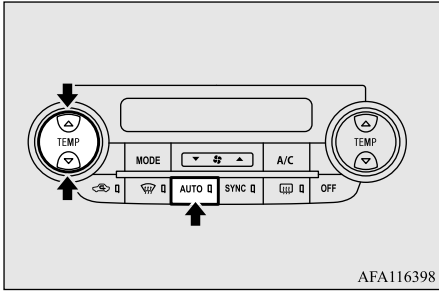

AFA116398

In normal conditions, use the system in the AUTO mode and follow these procedures:

1. Push the AUTO switch.
2. Set the temperature control switch to the desired temperature. The temperature can be set within a range of around 61 (LO) to 89 (HI) (when the outside temperature unit of the multi-information display shows °F) or 17 (LO) to 31 (HI) (when the outside temperature unit of the multi-information display shows °C).

The vents, recirculated/outside air, blower speed, temperature adjustment, and ON/OFF of the air conditioning will be controlled automatically.

NOTE

- Set the temperature at approximately 75 (when the outside temperature unit of the multi-information display shows °F) or 24 (when the outside temperature unit of the multi-information display shows °C) under normal conditions.
- When the engine coolant temperature is low, the air temperature from the heater will be cool/cold until the engine warms up, even if you have selected warm air with the temperature switch. To prevent the windshield and windows from fogging up, the vent mode will be changed to “” and the blower speed will be reduced.

Operating the air conditioning system (manual mode)

N00731801125

Blower speed and vent mode may be controlled manually by setting the blower speed selection switch and the MODE switch to the desired positions. To return to automatic operation, press the AUTO switch.

Defrosting or defogging (windshield, door windows)

N00732401636

CAUTION

- For safety, make sure you have a clear view through all the windows.

To remove frost or mist from the windshield and door windows, use the MODE switch or defogger switch (“” or “”).

■ For ordinary defrosting

Use this setting to keep the windshield and door windows clear of mist, and to keep the leg area heated (when driving in rain or snow).

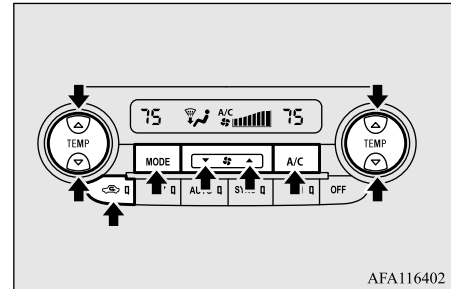

AFA116402

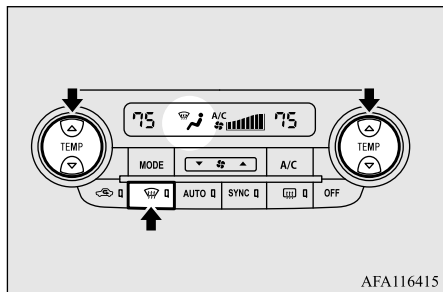

1. Set the air selection switch to the outside position.
2. Set the MODE switch to the “” position.
3. Select your desired blower speed by pressing the blower speed selection switch.
4. Select your desired temperature by pressing the temperature control switch.
5. Push the air conditioning switch.

■ For quick defrosting



1. Push the defogger switch.
2. Set the temperature to the highest position.

NOTE

- While the “” indicator light is on, the air conditioning compressor will run automatically. The outside air position will also be selected and the blower speed will be set at the maximum automatically.
- If the “” indicator light is on, you cannot turn the air conditioning off or select the recirculation position. This prevents the windows from fogging up.
- To defog quickly, direct the air flow from the side vents toward the door windows.
- When defrosting, do not set the temperature to the maximum cool position. This will blow cool air on the window glass and fog it up.

Air purifier

N00733801220

The air conditioning system is equipped with an air filter to remove pollen and dust. The air filter’s ability to collect pollen and dirt is reduced as it becomes dirty, so replace it periodically. For the maintenance interval, refer to the “WARRANTY AND MAINTENANCE MANUAL”.

NOTE

- Operation in certain conditions such as driving on a dusty road and frequent use of the air conditioning can lead to reduction of service life of the filter. When you feel that the air flow is lower than normal or when the windshield or windows start to fog up easily, replace the air filter.
Contact your authorized Mitsubishi Motors dealer or a repair facility of your choice for assistance.

General information about your radio

N00733901566

Your vehicle’s radio receives both AM and FM stations.

The quality of your reception is affected by distance, obstacles, and signal interference.

This radio complies with Part 15 of Federal Communications Commission (FCC) Rules (for vehicles sold in U.S.A.). Operation is subject to the following conditions:

- The device may not cause harmful interference.
- This device must accept any interference received, including interference that may cause undesirable operation.

⚠ CAUTION

- Changes or modifications not expressly approved by the party meeting the above conditions could void the user's authority to operate the equipment.

Signal transmission

FM signals do not follow the earth surface nor are they reflected by the upper atmosphere. For this reason, FM broadcasts cannot be received over long distances. AM signals follow the earth's surface and are reflected by the upper atmosphere. For this reason, AM broadcasts can be received over longer distances.

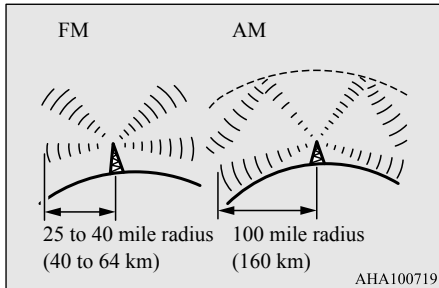

Weak reception (fading)

Because of the limited range of FM signals and the way FM waves transmit, you may experience weak or fading FM reception. When the broadcast is blocked by mountains or similar obstructions, reception can be disturbed.

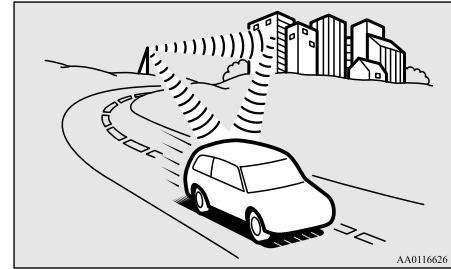

Reflection

The reason why one can hear FM but not AM in parking garages, under bridges etc., is that FM signals, unlike AM signals, are reflected by solid objects such as buildings, etc. Because FM signals are easily reflected by buildings, this can also cause reception disturbances.

The direct signal from the broadcast station reaches the antenna slightly before the reflected signal. This time difference may cause some reception disturbance or flutter. This problem occurs primarily in urban areas.

Cross modulation

If one listens to a weak station and is in the vicinity of another strong station, both stations might be received simultaneously.

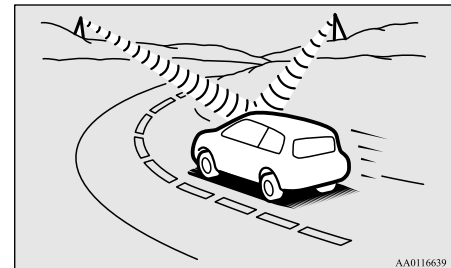

FM stereo reception

Stereo reception requires a high quality broadcast signal. This means that types of disturbances mentioned previously become more marked and the reception range is somewhat diminished during stereo reception.

Causes of disturbances

FM reception is affected by the electrical systems of vehicles in the vicinity, especially those without an electronic noise suppression device. The disturbance is even greater if the station is weak or poorly tuned.

FM reception is not as sensitive to electrical disturbances as AM. AM reception is sensitive to electrical disturbances such as power lines, lightning and other types of similar electrical phenomena.

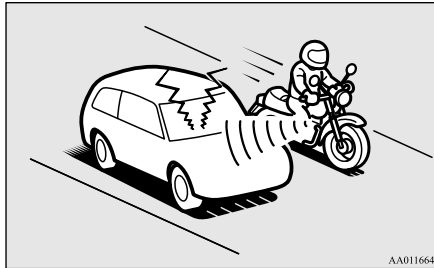



For emergencies

If the vehicle breaks down	8-2
If the operation mode cannot be changed to OFF (vehicles equipped with the F.A.S.T.-key)	8-2
Jump-starting the engine	8-2
Engine overheating	8-4
Jack and tools	8-5
How to change a tire	8-6
Towing	8-11
Operation under adverse driving conditions	8-12
Fuel Pump Shut-off System	8-13

If the vehicle breaks down

If the vehicle breaks down

N00836301230

If your vehicle breaks down on the road, move to the shoulder and turn on the hazard warning flashers. If there is no shoulder, or the shoulder is not safe, drive in the right lane slowly with the hazard lights flashing, until you come to a safe stopping place. Keep the flashers flashing.

If the engine stops/fails

If the engine stops, there will be no power assist to the steering and brakes, making these difficult to use.

- The brake booster will not work, so the brakes will not grip well. The brake pedal will be harder to press than usual.
- Since there is no power steering assist, the steering wheel will be hard to turn.

When the engine fails at the intersection

Get help from your passengers, bystanders, etc. to push the vehicle and move it to a safe area.

If the operation mode cannot be changed to OFF (vehicles equipped with the F.A.S.T.-key)

N00860700087

If the operation mode cannot be changed to OFF, perform the following procedure.

1. Move the selector lever to the “P” (PARK) position, and then change the operation mode to OFF.
2. One of the other causes could be low battery voltage. If this occurs, the keyless entry system and the F.A.S.T.-key operation will also not operate. Contact an authorized Mitsubishi Motors dealer or a repair facility of your choice.

Jump-starting the engine

N00836401879

If the engine cannot be started because the battery is weak or dead, you can start it with the battery from another vehicle using jumper cables.

WARNING

- To reduce the risk of igniting flammable gas that may be emitted from the battery, carefully read this section before jump-starting the vehicle.
- Do not try to start your vehicle by pushing or towing. This can cause an accident resulting in serious injury or death and can damage the vehicle.

NOTE

- Do not use jumper cables if they have damage or corrosion.

1. Take off any metal jewelry such as watch bands or bracelets that might create an accidental electrical contact.
2. Position the vehicles close enough together so that the jumper cables can reach, but be sure the vehicles aren't touching each other.

CAUTION

- Check the other vehicle. It must have a 12-volt battery. If the other system isn't 12-volt, both systems can be damaged.

3. Set the parking brake firmly on your vehicle and move the selector lever into the “P” (PARK) position.

- Set the parking brake firmly on the other vehicle. Put the automatic transaxle in “P” (PARK) or the manual transaxle in “N” (Neutral).
- Turn the ignition switch (the engine switch) on each vehicle to the “LOCK” or “OFF” position.

NOTE

- Turn off all lights, heater, and other electrical loads. This will avoid sparks and help save both batteries.

- Make sure your battery electrolyte is at the proper level. Refer to “Battery” on page 9-10.

WARNING

- If the electrolyte fluid is not visible, or looks frozen, **DO NOT ATTEMPT JUMP STARTING!!**
The battery might split open or explode if the temperature is below the freezing point or if it is not filled to the proper level.

- Connect one end of one jumper cable ① to the positive (+) terminal of the discharged battery (A), and then connect the other end ② to the positive (+) terminal of the booster battery (B).

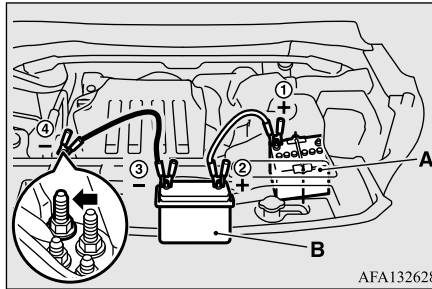

AFA132628

WARNING

- Make sure that the jumper cables and your clothing are clear of the cooling fans and drive belts. Entanglement with the fans or belts can cause serious personal injury.

NOTE

- Open the terminal cover before connecting the jumper cable to the positive terminal of the battery. Refer to “Battery” on page 9-10.
- Use the proper cables suitable for the battery size. Otherwise heat damage to the cables could result.

- Connect one end of the other jumper cable ③ to the negative (-) terminal of the booster battery (B), and then connect the other end ④ to the designated ground location of the vehicle with the discharged battery (A) at the point farthest from the battery.

WARNING

- Be sure to follow the proper order when connecting the batteries, of: ①→②→③→④
- Make sure that the connection ④ is made to the correct designated location (as shown in the illustration) properly. If the connection is directly made to the negative (-) terminal of the battery, the flammable gases from inside the battery might catch fire and explode, causing personal injury.
- When connecting the jumper cable, do not connect the positive (+) cable to the negative (-) terminal. Sparks can make the battery explode.

- Start the engine in the vehicle providing the boost. Let the engine idle a few minutes, then start the engine in the vehicle with the discharged battery.
- After the engine is started, disconnect the cables in the reverse order from the way you connected them.

Charging the battery by using an external battery charger

WARNING

- Always remove the battery from your vehicle when the battery is charged by an external battery charger.
- Keep sparks, cigarettes, and flames away from the battery because the battery could explode.
- Keep your work area well vented when charging or using the battery in an enclosed space.
- Remove all the caps before charging the battery.
- Electrolyte (battery acid) is made of corrosive diluted sulfuric acid. If electrolyte comes in contact with your hands, eyes, clothes, or the painted surface of your vehicle, thoroughly flush with water. If electrolyte gets in your eyes, flush them immediately and thoroughly with water, and get prompt medical attention.
- Always wear protective clothing and goggles when working near the battery.
- Keep the battery out of the reach of children.

As your vehicle has anti-lock brakes

If you drive your vehicle with a low battery charge after the engine has been started by using jumper cables, the engine may misfire. This can cause the anti-lock braking system warning light to blink on and off. This is only due to the low battery voltage. It is not a problem with the brake system. If this happens, fully charge the battery and ensure the charging system is operating properly.

Engine overheating

N00836501421

When the engine is overheating, the information screen in the multi-information display will be interrupted and the engine coolant temperature warning display will appear.

Also  will blink.

If these warnings are displayed:

1. Stop the vehicle in a safe place. Turn on the hazard warning flashers.
2. With the engine still running, carefully raise the engine hood to vent the engine compartment.

3. Check that the cooling fan is running. If the fan is not turning, stop the engine immediately and contact an authorized Mitsubishi Motors dealer or a repair facility of your choice for assistance.

WARNING

- To avoid personal injury, keep hands, hair, jewelry and clothes away from the cooling fan. The cooling fan can start at any time.

4. If you see steam or spray coming from under the hood, turn off the engine.
5. If you do not see steam or spray coming from under the hood, leave the engine on until the high coolant temperature warning goes off. After the high coolant temperature warning has gone off, you can start driving again. If the high coolant temperature warning stays on, turn off the engine.

WARNING

- Before raising the engine hood, check to see if there is steam or spray coming from under the hood. Steam or spray coming from an overheated engine could seriously scald you.
Do not open the hood until there is no steam or spray.

6. When you do not see any more steam or spray, open the hood. Look for obvious leaks, such as a split radiator hose. Be careful as components will be hot. Any leak source must be repaired.
7. If there is no obvious leak source, check the coolant level in the engine coolant reserve tank. If there is none, or if it is too low, slowly add coolant.
8. If the engine coolant reserve tank needs coolant, you will probably also need to add coolant to the radiator. Do not loosen or remove the radiator cap until the engine has cooled down.

WARNING

- Removing the radiator cap could scald you with escaping hot water or steam. When checking the radiator level, cover the cap with a cloth before trying to remove it. Turn it slowly counterclockwise, without pressing down, to the first notch. The pressure in the system will then be let out. When the pressure is COMPLETELY LET OUT, press down and keep turning the cap counterclockwise until it comes off.

9. Start the engine, and slowly add coolant, up to the bottom of the filler neck. Use plain water if you have to (and replace it with the right coolant as soon as possible).

10. Replace the radiator cap and tighten it fully. Check the engine coolant temperature display on the multi-information display. You can start driving again when the high coolant temperature warning does not come on.
11. Have the system inspected by your authorized Mitsubishi Motors dealer or a repair facility of your choice.

Jack and tools

N00836601480

Storage

The tools and jack are stored under the luggage floor board of the luggage compartment.

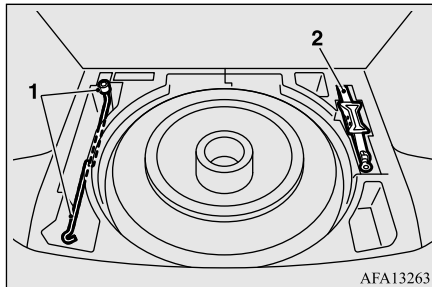

AFA132631

- 1- Tools
- 2- Jack

Tools

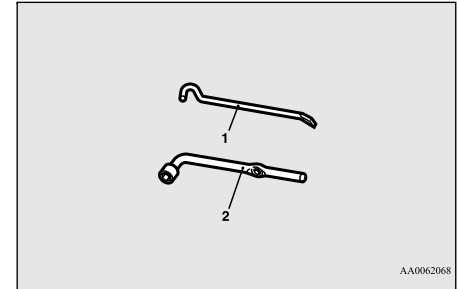

AA0062068

- 1- Bar
- 2- Wheel nut wrench

8

Jack

Before removing the jack, lift up the luggage floor board. Refer to “Luggage floor board ” on page 5-230.

How to change a tire

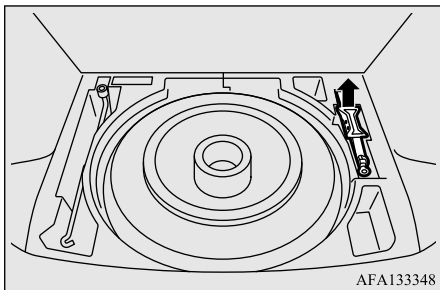

NOTE

- When returning the jack to its original position, retract the jack completely. The jack may interfere with the luggage floor board.

How to change a tire

N00836901904

Before changing a tire, first stop your vehicle in a safe, flat location.

1. Park the vehicle on level and stable ground.
2. Set the parking brake firmly.
3. Move the selector lever to the “P” (PARK) position and turn the ignition switch (the engine switch) to the “OFF” position.

4. Turn on the hazard warning flashers and set up a warning sign, such as a warning triangle or flashing signal lights, at an adequate distance from the vehicle, and have all your passengers leave the vehicle.
5. To prevent the vehicle from rolling when it is raised on the jack, place chocks or blocks (A) at the tire that is diagonally opposite from the tire (B) you are changing.

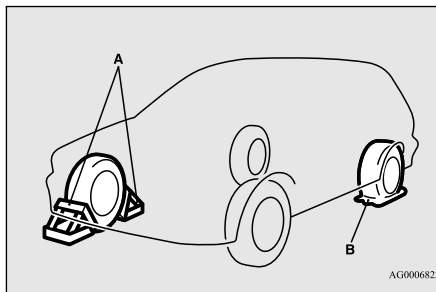

WARNING

- Be sure to apply chocks or blocks to the correct tire when jacking up the vehicle. If the vehicle moves while jacked up, the jack could slip out of position, leading to an accident.

NOTE

- The chocks shown in the illustration do not come with your vehicle. It is recommended that you purchase chocks or blocks and keep them in the vehicle for use if needed.
- If chocks or blocks are not available, use stones or any other objects that are large enough to hold the wheel in position.

6. Get the jack, bar and wheel nut wrench ready.

(Refer to “Jack and tools” on page 8-5.)

Spare tire information

N00849601341

Compact spare tire

The compact spare tire is stored under the luggage floor board of the luggage compartment. It is designed to save space in the luggage compartment. Its lighter weight makes it easier to use if a flat tire occurs.

WARNING

- Tires, including the spare tire, degrade over time with age even when they are not being used. It is recommended that tires over 6 years old generally be replaced even if damage is not obvious.

⚠ CAUTION

- While the compact spare tire is stowed, the inflation pressure should be checked at least once a month to assure that it remains at the recommended inflation pressure. See the tire and loading information placard attached to the driver's door sill. Refer to "Tire and loading information placard" on page 11-3.
- Driving with an improperly inflated tire can cause an accident. If you have no choice but to drive with an under-inflated tire, keep your speed down and avoid sudden steering or braking, if possible. Inflate the tire to the correct pressure as soon as possible. Refer to "Tire inflation pressures" on page 9-16.
- The compact spare tire should be used only temporarily. While the compact spare tire is being used, the tire pressure monitoring system will not function properly. Have the tire replaced or repaired at an authorized Mitsubishi Motors dealer or a repair facility of your choice as soon as possible.
- Do not go over 50 mph (80 km/h) when driving with the compact spare tire.
- Avoid sudden starting and braking when driving with the compact spare tire.
- Do not drive through automatic car washes and over obstacles that could possibly damage the underside of your vehicle. Because the compact spare tire is smaller than the original tire, there is less clearance between the ground and your vehicle.

⚠ CAUTION

- Because the compact spare tire is designed only for your vehicle, do not use it on any other vehicle.
- Do not put the compact spare tire on a different wheel, and do not put standard tires, snow tires, wheel covers or trim rings on the compact spare tire. Otherwise, you could damage these parts or other parts on your vehicle.
- Do not use tire chains with your compact spare tire. Using a chain could cause damage to your vehicle and loss of the chains.

To remove the spare tire

N00849701414

1. Lift up the luggage floor board. Refer to "Luggage floor board" on page 5-230.
2. To remove the spare tire, remove the spare tire pad (A), and then remove the installation clamp (B) by turning it counterclockwise.

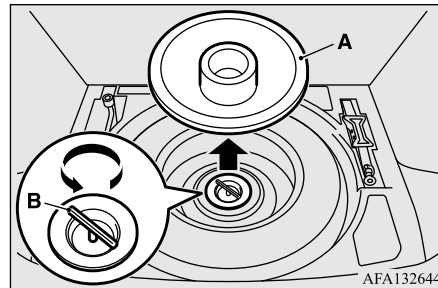

AFA132644

To change a tire

N00849801604

1. Loosen the wheel nuts with the wheel nut wrench. Do not remove the wheel nuts yet.

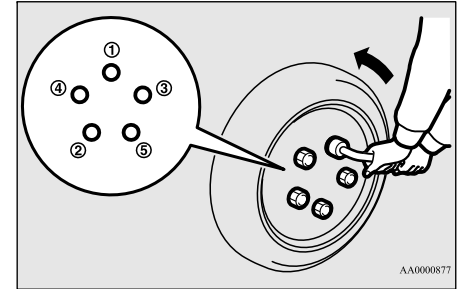

AA0000877

2. Place the jack under one of the jacking points (A) shown in the illustration. Use the jacking point closest to the tire you wish to change.

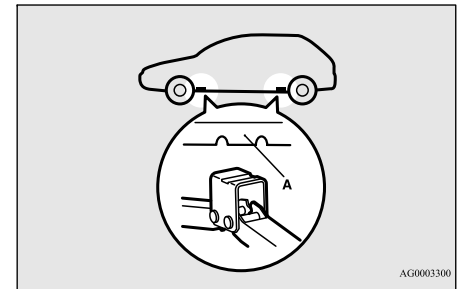

AG0003300

⚠ WARNING

- Set the jack only at the positions shown here. If the jack is set at a wrong position, it could dent your vehicle or the jack might fall over and cause personal injury.
- Do not use the jack on a tilted or soft surface. Otherwise, the jack might slip and cause personal injury. Always use the jack on a flat, hard surface. Before setting the jack, make sure there are no sand or pebbles under the jack base.

8

📖 NOTE

- Put the spare wheel under the vehicle body near the jack. This makes it safer if the jack slips out of position.

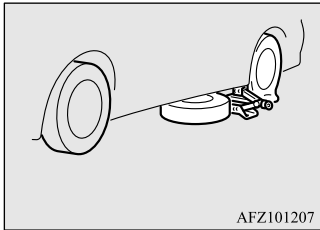

3. Rotate the jack by hand until the flange portion (B) fits in the groove (C) at the top of the jack.

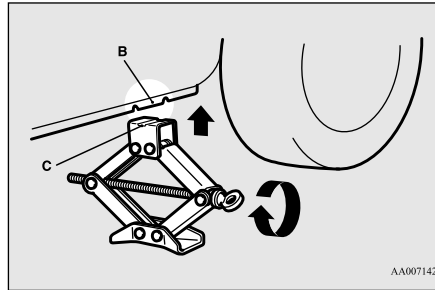

4. Check that the flange portion at the jacking point fits in the groove at the top of the jack.

Insert the bar (D) into the wheel nut wrench (E). Then put the end of the bar into the shaft's jack end, as shown in the illustration.

Slowly rotate the wheel nut wrench until the tire is raised slightly off the ground surface.

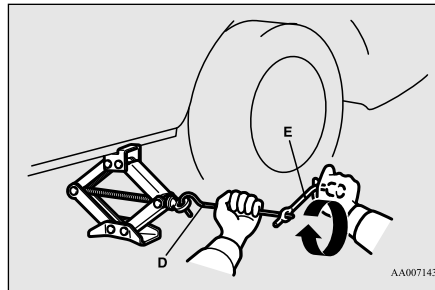

⚠ WARNING

- Stop jacking up the vehicle as soon as the tire is raised off the ground. It is dangerous to raise the vehicle any higher.
- Do not get under your vehicle while using the jack.
- Do not bump the raised vehicle or leave it sitting on the jack for a long time. Both are very dangerous.
- Do not use a jack except the one that came with your vehicle.
- The jack should not be used for any purpose other than to change a tire.
- No one should be in your vehicle when using the jack.
- Do not start or run the engine while your vehicle is on the jack.
- Do not turn the raised wheel. The tires that are still on the ground could turn and make your vehicle fall off the jack.

5. Remove the wheel nuts with the wheel nut wrench, then take the wheel off.

⚠ CAUTION

- Handle the wheel carefully when changing the tire, to avoid scratching the wheel surface.

6. Clean out any mud, etc. on the hub surface (F), hub bolts (G) or in the installation holes (H) in the wheel, and then mount the spare tire.

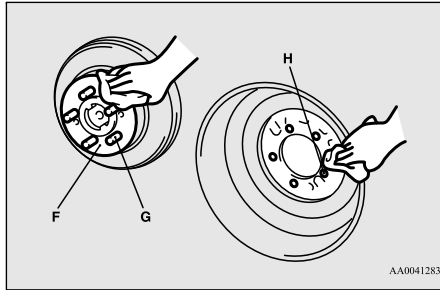

7. Turn the wheel nut clockwise by hand to initially tighten them.

Temporarily tighten the wheel nuts by hand until the flange parts of the wheel nuts make light contact with the wheel and the wheel is not loose.

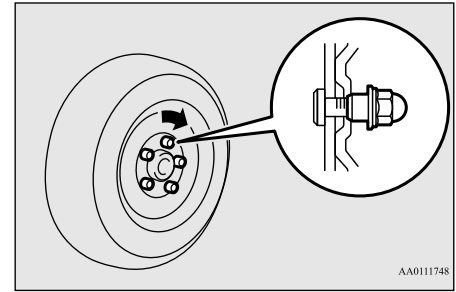
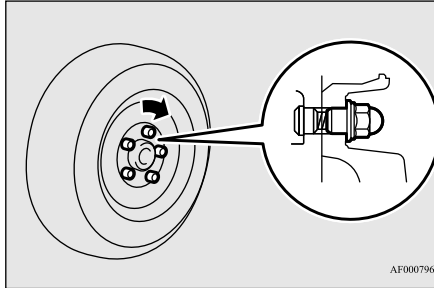

WARNING

- Mount the spare wheel with the valve stem (I) facing outward. If you cannot see the valve stem (I), you have installed the wheel backwards. Operating the vehicle with the spare wheel installed backwards can cause vehicle damage and result in an accident.

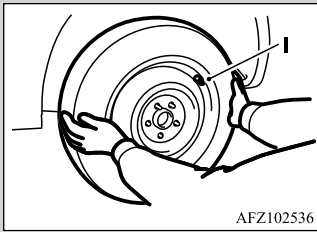

NOTE

- Flange nuts can be temporarily used on the compact spare tire as shown in the illustration, but return to the original wheel and tire as soon as possible.

CAUTION

- Never apply oil to either the wheel bolts or the nuts or they will tighten too much.

NOTE

- On vehicles with aluminum wheels, if all 4 aluminum wheels are changed to steel wheels, use tapered nuts.

8. Lower the vehicle slowly until the tire touches the ground, by rotating the wheel nut wrench counterclockwise.

How to change a tire

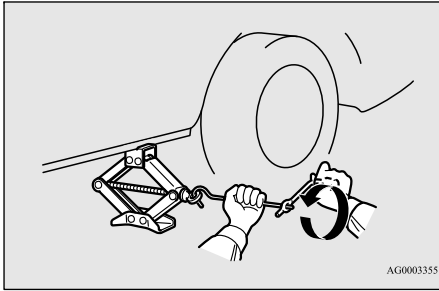

9. Tighten the nuts in the order shown in the illustration until each nut has been tightened to the torque listed here.
65 to 80 ft-lb (88 to 108 N•m)

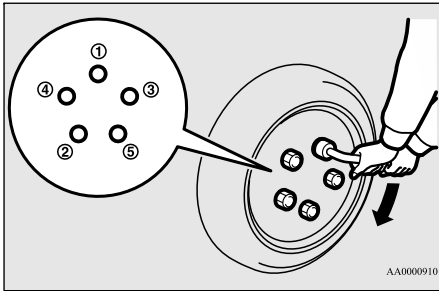

⚠ CAUTION

- Never use your foot or a pipe extension to apply added force to the wheel nut wrench when tightening the wheel nuts. If you do so, you can over-tighten the wheel nuts and damage the wheel, wheel nuts and hub bolts.

10. Lower the jack all the way and remove it.
11. Check the tire inflation pressure. The recommended tire pressure for your vehicle is listed on the tire and loading information placard attached to the driver's door sill as shown in the illustration. Refer to "Tire inflation pressures" on page 9-16.

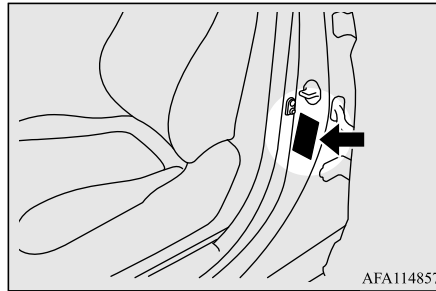

⚠ CAUTION

- Driving with an improperly inflated tire can cause an accident. If you have no choice but to drive with an under-inflated tire, keep your speed down and avoid sudden steering or braking, if possible. Inflate the tire to the correct pressure as soon as possible. Refer to "Tire inflation pressures" on page 9-16.
- After changing the tire and driving the vehicle approximately 620 miles (1,000 km), retighten the wheel nuts to make sure that they have not come loose.

⚠ CAUTION

- If the steering wheel vibrates when driving after changing the tire, have the tire checked for balance at an authorized Mitsubishi Motors dealer or a repair facility of your choice.
- Do not mix one type of tire with another or use a different size from the one listed. This would cause early wear and poor handling.

To store the spare tire

N0083230059

1. Lift up the luggage floor board. Refer to "Luggage floor board" on page 5-230.
2. Store the spare tire under the luggage floor board. To store the spare tire, fit the installation clamp (A) by turning it clockwise, and then install the spare tire pad (B).

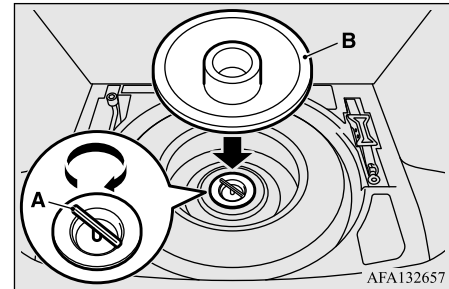

NOTE

- On vehicles with a T155/90D16 or T155/80D17 size spare tire, the clamp cannot be used for a normal size tire.

3. Have your damaged tire repaired as soon as possible.

To store the flat tire, jack, bar and wheel nut wrench

N00850001228

Store the flat tire in the luggage compartment.

CAUTION

- Placing heavy items on the luggage floor board when a spare tire is not stored may deform or damage the luggage floor board.

NOTE

- The clamp cannot be used for a normal size tire.
- Store the normal size flat tire under the luggage floor board in the space the spare tire was stored.
- When storing a normal size flat tire in the space for the spare tire under the luggage floor board, the luggage floor board will be positioned higher than usual.

Reverse the removing procedure when storing the jack, bar and wheel nut wrench. Refer to “Jack and tools” on page 8-5.

Towing

N00837002026

If your vehicle needs to be towed

If towing is necessary, we recommend you to have it done by a commercial tow truck service.

When towing is required, transport the vehicle using a tow truck.

Incorrect towing equipment could damage your vehicle.

CAUTION

- Do not attempt to be towed by another vehicle with a rope.

NOTE

- Your vehicle cannot tow any other vehicle.

There may be local regulations concerning towing in your area.

Obey the regulations of the area where you are driving your vehicle.

A



B



C Do not tow all-wheel drive vehicles with this style.



D



E



AJE100351

Towing the vehicle by a tow truck**CAUTION**

- This vehicle must not be towed by a tow truck using sling lift type equipment (Type A) as illustrated. Using a sling lift will damage the bumper and front end.

⚠ CAUTION

- This vehicle must not be towed with the driving wheels on the ground (Type B) as illustrated. This could result in damage to the driving system.
- Do not tow all-wheel drive vehicles with the rear wheels on the ground (Type C) as illustrated. This could result in damage to the driving system or the vehicle lurching forward while being towed. If you tow all-wheel drive vehicles, use only Type D or E equipment.

- [For front-wheel drive vehicle equipped with the active stability control (ASC)]
If the vehicle is towed with the ignition switch in the “ON” position or the operation mode in ON and only the front wheels raised off the ground (Type C), the ASC may operate, resulting in an accident. When towing the vehicle with the front wheels raised, keep the ignition switch or the operation mode as follows.
[Except for vehicles equipped with the F.A.S.T.-key]
The ignition switch is in “OFF” or “ACC” position.
[Vehicles equipped with the F.A.S.T.-key]
The operation mode is in OFF or ACC.

Towing a front-wheel drive vehicle with front wheels off the ground (Type C)

Release the parking brake.
Set the selector lever to the “N” (NEUTRAL) position.

Operation under adverse driving conditions

N00837201786

If your vehicle becomes stuck in sand, mud or snow

If your vehicle becomes stuck in snow, sand, or mud, it can often be moved by a rocking motion. Rock your vehicle back and forth to free it.
Do not rev the engine or spin the wheels. Constant efforts to free a stuck vehicle can cause overheating and transaxle failure. Let the engine idle for a few minutes to cool the transaxle before trying again.
If your vehicle is still stuck after several rocking attempts, call for a commercial tow truck service.

⚠ WARNING

- When trying to rock your vehicle out of a stuck position, make sure that there are no people nearby. The rocking motion can make your vehicle suddenly lurch forward or backward, and injure any bystanders.

On wet roads

⚠ CAUTION

- Avoid flooded roads. Water is often deeper than it looks, and you could be seriously hurt by driving into flood water.
- When driving in rain, on water-covered roads, or through a car wash, water could get into the brake discs and make them fail temporarily. In such cases, lightly press the brake pedal to see if they are working properly. If they are not, press the pedal lightly several times while driving to dry the brake pads or linings, then check them again.
- When driving in rain, a layer of water may form between the tires and the road surface (hydroplaning). This loosens your tires’ grip on the road, making it difficult to steer or brake properly. When driving on a wet road:
 - Drive your vehicle at a safe speed.
 - Do not drive on worn tires.
 - Always keep the tires at the correct inflation pressures.

On snowy or icy roads

- When driving on a road covered with snow or ice, use snow tires. Tire chains cannot be used on your vehicle. There may be state or local regulations about using snow tires. Always check the regulations in your local area before using them. Refer to “Snow tires” on page 9-20 and “Tire chains” on page 9-20.
- Drive slowly. Do not make sudden starts or stops, sharp turns, or slam on the brakes.
- Allow extra distance between your vehicle and the vehicle in front of you, and avoid sudden braking.
- If a skid occurs when the accelerator pedal is depressed, take your foot off the pedal. Steer gently in the direction of the skid.
- Your vehicle is equipped with an anti-lock braking system (ABS). Hold the brake pedal down firmly and keep it depressed. Do not pump the brake pedal which will result in reduced braking performance.
- After parking on snowy or icy roads, it may be difficult to move your vehicle due to the brake being frozen. Depress the accelerator pedal little by little to move the vehicle when safe to do so.

CAUTION

- Do not depress the accelerator pedal rapidly. The vehicle could start moving when it breaks free from the ice, possibly resulting in an accident.

On a bumpy or rutted road

- Drive as slow as possible when driving on bumpy, rutted roads or over potholes.

CAUTION

- Driving on bumpy, rutted roads or over potholes can damage the tires and wheels. Wheels with low-profile tires or under-inflated tires are especially at risk for damage.

Fuel Pump Shut-off System

N00860600031

WARNING

- **Before attempting to restart the engine after a collision, always inspect the ground under the vehicle for leaking fuel. If a fuel leak is found or a fuel odor is detected, do not restart the engine.**

WARNING

- **Mitsubishi Motors recommends that your vehicle be inspected by an authorized Mitsubishi Motors dealer after any collision.**

In the event of a collision causing frontal air-bag deployment, the fuel pump shut-off system will activate to stop fuel supply to the engine.

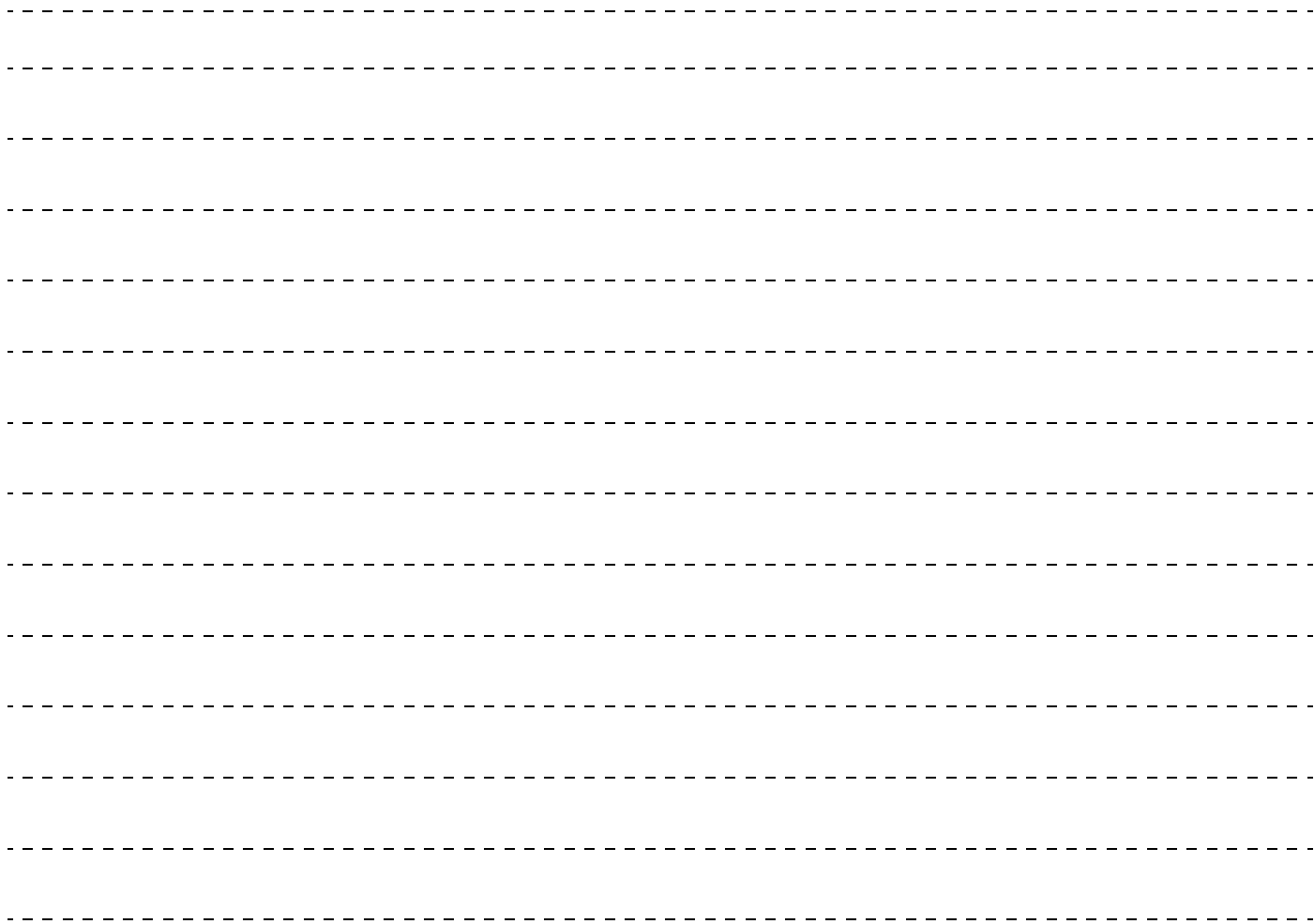

Vehicle care and maintenance

Service precautions	9-2
Catalytic converter	9-2
Engine hood	9-3
View of the engine compartment	9-5
Engine oil and oil filter	9-5
Engine coolant	9-7
Air cleaner filter	9-8
Continuously variable transmission (CVT) fluid	9-8
Transfer oil (All-wheel drive models)	9-9
Rear axle oil (All-wheel drive models)	9-9
Washer fluid	9-9
Brake fluid	9-10
Battery	9-10
Tires	9-12
Brake pedal free play	9-20
Parking brake lever stroke (if so equipped).....	9-20
Wiper blades	9-21
Emission-control system maintenance	9-21
General maintenance	9-22
For cold and snowy weather	9-23
Fusible links	9-24
Fuses	9-24
Replacement of light bulbs	9-28
Vehicle care precautions	9-34
Cleaning the inside of your vehicle	9-35
Cleaning the outside of your vehicle	9-36

Service precautions

N00937301616

Taking regular care of your vehicle will preserve its value and appearance as long as possible.

You can do some of the maintenance work yourself, and the rest should only be performed by an authorized Mitsubishi Motors dealer or a repair facility of your choice.

If you discover a malfunction or other problem, have it corrected by an authorized Mitsubishi Motors dealer or a repair facility of your choice.

This section describes the maintenance inspections that you can do yourself, if you so desire. Follow the instructions and precautions for each procedure.

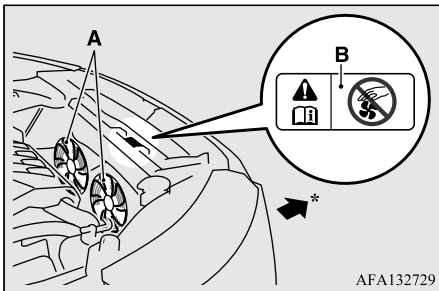

A- Cooling fans

B- Caution label

*: Front of the vehicle

WARNING

- When checking or servicing the inside of the engine compartment, be sure the engine is stopped and has had a chance to cool down.
- If you need to work in the engine compartment with the engine running, be especially careful that your clothing, hair, etc. does not get caught in the cooling fans, drive belts, or other moving parts.
- After performing the maintenance work, make sure that no tools or cloths are left behind in the engine compartment. If they are left behind, a fire or damage to the vehicle may occur.
- The cooling fans can turn on automatically even if the engine is not running. Turn the ignition switch to the "OFF" position or put the operation mode in OFF to be safe while you work in the engine compartment.
- Do not smoke or allow open flames around fuel or the battery. The fumes are flammable.
- Be extremely careful when working around the battery. It contains poisonous and corrosive sulfuric acid.
- Do not get under your vehicle while it is on a jack. Always use properly rated automotive jack stands.

WARNING

- Handling your vehicle's parts and materials in the wrong way can injure you. Ask an authorized Mitsubishi Motors dealer or a repair facility of your choice if you have questions.



DIAMOND CARE PROTECTION PLAN

Have you purchased the Mitsubishi Motors Diamond Care Protection Plan? The Plan supplements your new vehicle warranties. See your authorized Mitsubishi Motors dealer for details.

Catalytic converter

N00937401486

The catalytic converter requires you to use unleaded fuel only. Leaded gasoline will

destroy the emission-control effectiveness of the converter.

Normally, the catalytic converter does not require maintenance. However, it is important to keep the engine properly tuned for the converter to continue to work properly.

⚠ CAUTION

- Damage to the catalytic converter can result if your vehicle is not kept in proper operating condition. If the engine malfunctions or misfires, or if your vehicle performance suffers, have it serviced promptly. Running your vehicle when it is overheated may result in damage to the converter and vehicle.

⚠ WARNING

- **Do not park or run your vehicle in areas where combustible materials such as dry grass or leaves can come in contact with a hot exhaust, since a fire could occur.**
- **Do not put undercoat paint on the catalytic converter.**

To reduce the possibility of catalytic converter damage:

- Use **UNLEADED GASOLINE ONLY** of the type recommended in “Fuel selection” on page 3-2.

- Do not drive with an extremely low fuel level. Running out of gas could damage the catalytic converter.
- Do not try to start the engine by pushing or towing the vehicle. If the battery is weak or run down, use jumper cables to properly start the engine. Refer to “Jump-starting the engine” on page 8-2.
- Do not idle the engine with any spark plug wires disconnected or removed, such as when performing diagnostic tests.
- Do not idle the engine for a long time if it is idling roughly or otherwise obviously malfunctioning.
- To prevent damage to the catalytic converter from unburned gas, do not race the engine when turning off the ignition switch.
- Stop driving the vehicle if you think the performance is noticeably low, or the engine has a malfunction such as with the ignition, etc. If you are not able to stop driving immediately, slow down and drive for only a short time. Have your vehicle checked at an authorized Mitsubishi Motors dealer or a repair facility of your choice as soon as possible.

- In unusual situations involving major engine problems, a burning odor may indicate severe and abnormal catalytic converter overheating. If this occurs, stop in a safe place, shut the engine off and let the vehicle cool. Once the engine is cool, immediately take your vehicle to an authorized Mitsubishi Motors dealer or a repair facility of your choice for service.

Engine hood

N00937501735

To open

Use the engine hood release lever (located under the instrument panel near the driver's door) to unlock the engine hood.

Pull the lever toward you to release the engine hood latch.

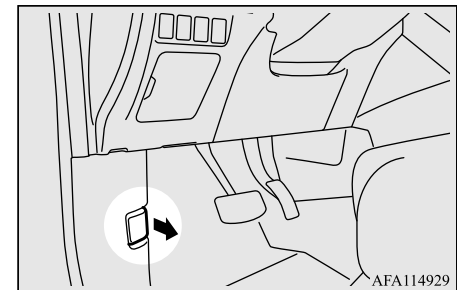

⚠ WARNING

- Never use the release lever to unlatch the engine hood while the vehicle is in motion.
- Do not drive your vehicle unless the engine hood is locked.

Release the lever and lift the engine hood.

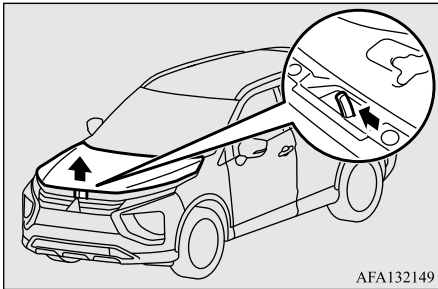

📖 NOTE

- To prevent damage to the engine hood and wipers, make sure the wipers are at resting position when you open the engine hood.

Support the engine hood with the hood prop. Insert the hood prop securely into the opening under the hood marked with an arrow.

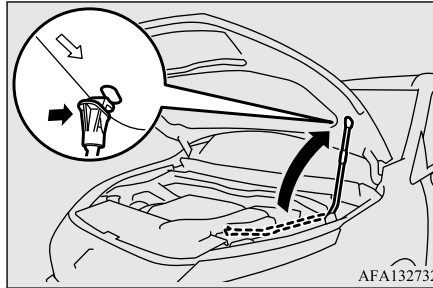

⚠ CAUTION

- Always insert the support prop into the hole specially made for it. Propping the engine hood at any other place could cause the prop to slip out and lead to an accident.
- The hood prop can fall out if the hood is lifted by a strong wind.

To close

Disengage the prop from the engine hood and put it back in its retainer.

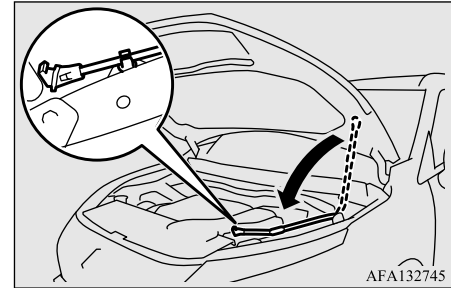

Slowly lower the engine hood approximately 8 inches (20 cm), then let it drop from its own weight.

⚠ CAUTION

- Be careful not to trap your hands or fingers when closing the engine hood.
- Make sure the engine hood is firmly closed before driving. If you drive without the engine hood completely closed, it could open up while driving.

📖 NOTE

- If this does not close the engine hood properly, drop it again from a slightly higher position.
- Do not push down strongly on the engine hood. Depending on how strongly or where you push down, you could create a dent in the vehicle body.

NOTE

- If you drive with the engine hood left open, a warning display appears on the information screen in the multi-information display.

**View of the engine compartment**

N00937601837

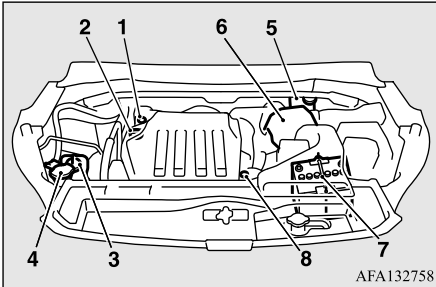

AFA132758

- 1- Engine oil level dipstick
- 2- Engine oil filler cap
- 3- Engine coolant reservoir
- 4- Washer fluid reservoir
- 5- Brake fluid reservoir
- 6- Air cleaner filter
- 7- Battery

- 8- Continuously variable transmission (CVT) fluid level dipstick

Engine oil and oil filter

N00937702213

To check and refill engine oil

It is normal for an engine to use oil. You may need to add oil between the recommended oil change intervals. Before starting the engine, check the engine oil level. Refill if necessary.

To check the oil level, remove the dipstick, wipe it off, and gently reinsert it all the way. Slowly pull the dipstick straight out and check the oil level by checking the upper surface of the dipstick. The oil level must not go above the line on the dipstick.

NOTE

- If it is difficult to verify the oil level, wipe off the dipstick and reinsert it. Wait a moment and then recheck the oil level by checking the upper surface of the dipstick.

If the level does not reach the line which shows the minimum amount of oil required, remove the oil filler cap on the cylinder head cover, and fill to within the “Good” range.

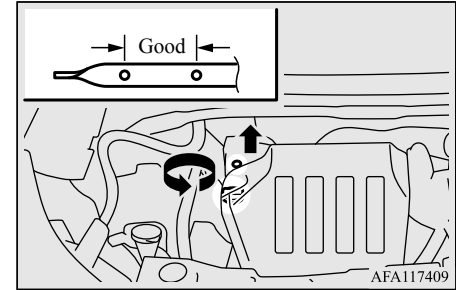

AFA117409

CAUTION

- Overfilling will cause oil aeration and loss of oil pressure, which could damage the engine.

WARNING

- Used engine oil is poisonous, and can damage your skin. Prolonged and repeated contact may cause serious skin disorders, including dermatitis and cancer. Do not let used oil touch your skin and wash thoroughly after working with it.
- Keep used oil out of the reach of children.

NOTE

- Engine oil consumption is greatly influenced by payload, engine speed, etc.

NOTE

- The engine oil will deteriorate rapidly if the vehicle is subjected to severe conditions (for example, repeated operation on rough roads, in mountainous regions, on roads with many uphill and downhill gradients, or over short distances). Consequently, the oil will require earlier replacement in accordance with the schedule in the “WARRANTY AND MAINTENANCE MANUAL”.

Engine oil identification mark

Mitsubishi Motors recommends using only engine oils with the ILSAC certification symbol on the front of the container.

ILSAC certification symbol



TA0000313

If you cannot find oils with the ILSAC certification symbol, use an API classification SP oil with the following label.

This mark appears on the top of the oil container and tells you two important things about the oil.

API service symbol

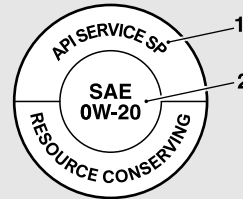

AFA136453

- 1- The upper part indicates the quality of the oil.
- 2- The center part indicates the SAE grade of the oil viscosity.

Recommended engine oil viscosity

Use engine oil with the proper thickness for the outdoor temperatures where you will be driving.

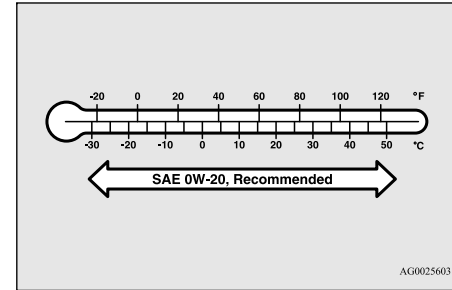

Mitsubishi Motors Genuine 0W-20 Synthetic Engine Oil is recommended for optimum fuel economy and cold weather starting.

If Mitsubishi Motors Genuine 0W-20 Synthetic Engine Oil is not available, 5W-20 grade oils displaying the ILSAC certification can be used. However, Mitsubishi Motors Genuine 0W-20 Synthetic Engine Oil should be used at the next oil change to maintain optimum fuel economy and cold weather starting.

To replace the oil filter

The oil filter should be replaced at the time or mileage specified in the “WARRANTY AND MAINTENANCE MANUAL”.

Only use high quality replacement filters on this vehicle. The manufacturer’s specifications for Mitsubishi Motors Genuine oil fil-

ters require that the filter can withstand a pressure of 256 psi (1.8 MPa). A Mitsubishi Motors Genuine oil filter is the best replacement filter.

Follow the installation instructions printed on the filter.

Engine coolant

N00937801695

To check the coolant level

The engine coolant reserve tank (A) lets you quickly see when you need to add coolant. When the engine is cold, the level of the coolant in the reserve tank should be between the FULL and LOW marks. The radiator usually stays full so there is no reason to remove the radiator cap (B) except when you check the coolant freeze point or replace the antifreeze coolant.

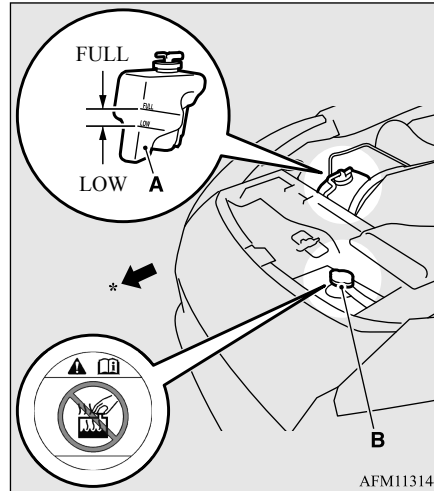

*: Front of the vehicle

To add coolant

Use “Mitsubishi Motors Genuine Super Long Life Coolant Premium” or equivalent*.

*: Similar high quality ethylene glycol based non-silicate, non-amine, non-nitrate and non-borate coolant with long life hybrid organic acid technology

Mitsubishi Motors Genuine Coolant provides excellent protection against corrosion and

rust formation on all metals, including aluminum, and prevents clogs in some parts of the engine.

If you need to add coolant often, or if the level in the reserve tank does not drop when the engine cools, the cooling system should be pressure-tested for leaks. Take your vehicle to an authorized Mitsubishi Motors dealer or a repair facility of your choice for testing.

CAUTION

- Do not use alcohol or methanol antifreeze or any engine coolants that contain them. Using the wrong antifreeze can corrode aluminum parts.
- The required concentration of anti-freeze differs depending on the expected ambient temperature.
 - Above -31 °F (-35 °C): 50 % concentration of anti-freeze
 - Below -31 °F (-35 °C): 60 % concentration of anti-freeze
 You can check the concentration level with a gauge from an automotive supply store, or your authorized Mitsubishi Motors dealer or service station can check it for you.
- Do not use water to adjust the concentration of coolant.
- Do not top off the tank with plain water only. Water by itself boils at a lower temperature and does not stop rust or freezing. If the water freezes, it will damage your cooling system. Do not use tapwater. It can cause corrosion and rust.

Radiator cap

The radiator cap must be sealed tight to prevent losing coolant, which may result in engine damage. Only use a Mitsubishi Motors Genuine Parts radiator cap, or an approved equivalent.

WARNING

- Wait for the engine to cool down before opening the radiator cap. Otherwise hot steam or boiling coolant could spray up from the radiator and scald you.

9

Points to remember

- Do not overfill the reserve tank.
- Your vehicle uses a special radiator cap that stays sealed and lets the coolant flow from the reserve tank back to the radiator when the engine cools down. If you need to change the cap, use the exact same kind.
- Check the coolant freeze point in the radiator with the proper gauge, and only when it is safe. If you add antifreeze, the contents of the reserve tank must be protected against freezing.
- Keep the front of the radiator and condenser clean.

- If the engine coolant temperature does not rise after the engine is warmed-up, take your vehicle to an authorized Mitsubishi Motors dealer or a repair facility of your choice to have the thermostat checked, and replaced if necessary.

Air cleaner filter

N00937901553

The air cleaner filter will get dirty and dusty from use and not filter properly. Replace it with a new filter using the schedule in the “WARRANTY AND MAINTENANCE MANUAL”.

1. Unclamp and take out the air cleaner filter.

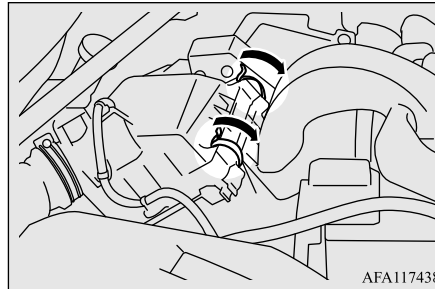

2. Install the air cleaner filter and put the cover back on in its original position.

NOTE

- Mitsubishi Motors Genuine Parts are recommended when replacing the air cleaner filter.
- After replacing the air cleaner filter, make sure that the hinges at the bottom of the cover are firmly set.

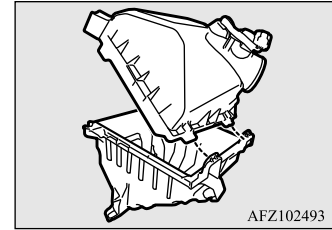

3. Put the duct back on in its original position.

Continuously variable transmission (CVT) fluid

N00938101220

The continuously variable transmission (CVT) should be maintained and serviced by an authorized Mitsubishi Motors dealer or a repair facility of your choice to obtain the best performance and longest life. It is important that the transmission fluid is kept at the correct level.

Transfer oil (All-wheel drive models)

Fluid type

Use only “Mitsubishi Motors Genuine CVTF-J4” or “Mitsubishi Motors Genuine CVTF-J4+” transmission fluid to ensure optimum transmission performance.

⚠ CAUTION

- Using the improper transaxle fluid may damage the transaxle.

Special additives

Do not use any fluid additives to the transmission.

Transfer oil (All-wheel drive models)

N00938401308

Whenever the transfer oil level is checked, add oil as necessary to maintain the proper level. Fill with the oil according to the following table.

Fluid type

Lubricant	Mitsubishi Motors Genuine Super Hypoid Gear Oil API GL-5
Viscosity range	SAE 80

Rear axle oil (All-wheel drive models)

N00915201295

Whenever the oil level is checked, add oil as necessary to maintain the proper level. Fill with the oil according to the table below.

Fluid type

Lubricant	Mitsubishi Motors Genuine Super Hypoid Gear Oil API GL-5
Viscosity range	SAE 80

Washer fluid

N00938601498

The windshield and rear window washer fluid reservoir is in the engine compartment.

Check the washer fluid level at regular intervals and add washer fluid to reservoir if necessary.

Open the reservoir cap and check the fluid level with the dipstick.

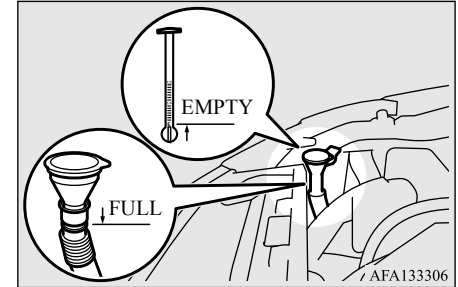

When freezing weather is anticipated, flush out the water in the reservoir by operating the pump. Fill the reservoir with windshield anti-freeze (not radiator antifreeze), and operate the system for a few seconds to flush out the residual water.

⚠ CAUTION

- Do not use any fluid other than washer fluid. Also, do not use such as soapy water, glass cleaner, and engine coolant. Using other liquids can cause damage to the vehicle, such as could cause streaking on the vehicle's painted surfaces, damage to the washer pump, or clogging the nozzle, leading to the washer fluid not spraying.

Brake fluid

CAUTION

- Over-diluting the washer fluid in winter may cause it to freeze onto the windshield.

Brake fluid

N00938701398

To check the fluid level

Check the fluid level in the reservoir.

The fluid level must be between the “MAX” and “MIN” marks on the reservoir.

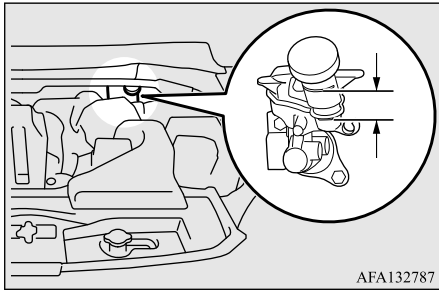

The fluid level falls slightly with wear of the brake pads, but this does not indicate any abnormality.

If the fluid level falls markedly in a short length of time, it indicates leaks from the brake system.

If this occurs, have the vehicle checked by an authorized Mitsubishi Motors dealer or a repair facility of your choice.

Fluid type

Use the recommended brake fluid conforming to DOT 3 or DOT 4. The reservoir cap must be tightly sealed to keep dirt and water out.

WARNING

- Take care in handling brake fluid as it is harmful to the eyes, may irritate your skin and will damage painted surfaces. Wipe up spills immediately. If brake fluid gets on your hands or in your eyes, flush immediately with clean water. Follow up with a doctor as necessary.

CAUTION

- Do not let any petroleum-based fluid touch, mix with, or get into the brake fluid. This will damage the seals.
- Use only the listed brake fluid. Different brands of brake fluid have different additives, and these can cause a chemical reaction. Do not mix brands of brake fluid.
- Keep the reservoir tank cap closed to keep the brake fluid from evaporating.

Battery

N00939101995

The condition of the battery is very important for quick starting and to keep the vehicle's electrical system working properly. Check the battery regularly.

If battery performance is suspect, have the battery and charging system tested by an authorized Mitsubishi Motors dealer or a repair facility of your choice.

NOTE

- After replacing the battery, the electronic control system data for the automatic trans-axle, etc., will be erased. As a result, shifting may be rough. Shifting will become smoother after several changes in speed.

Checking battery electrolyte level

The electrolyte level must be between the limits shown on the outside of the battery. Fill it with distilled water as needed. The inside of the battery is divided into several compartments. Take the cap off of each compartment and fill to the mark.

Do not fill above the top line because a spill during driving could cause damage.

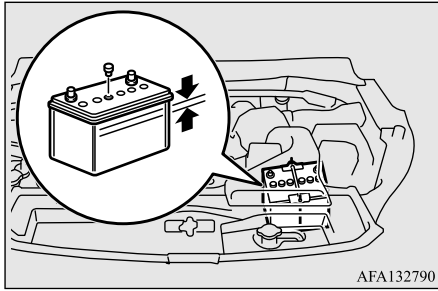

AFA132790

⚠ WARNING

- If the battery is dead, be sure to check the battery electrolyte level before connecting booster cables.
- After checking the battery electrolyte level, make sure the caps are fitted securely.
- If any of the caps has a loose fit, replace the battery.

During cold weather

The battery is weaker in cold temperatures. This has to do with its chemical and physical properties and is why a very cold battery, especially one with a low charge, will have a hard time starting your vehicle.

It is recommended that you have your battery and charging system checked by an authorized Mitsubishi Motors dealer or a repair facility of your choice before the start of cold weather. If necessary, have it charged. This will provide more reliable starting, and longer battery life.

Disconnection and connection

To disconnect the battery cable, stop the engine. Disconnect the negative (-) terminal first, then the positive (+) terminal. To reconnect the battery, first connect the positive (+) terminal and then the negative (-) terminal, before starting the vehicle.

📖 NOTE

- Open the terminal cover (A) before disconnecting or connecting the positive (+) terminal of the battery.
- Loosen the nut (B) and then disconnect the battery cable from the positive (+) terminal.

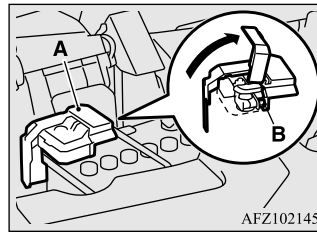

AFZ102145

⚠ WARNING

- Never disconnect the battery while the engine is running, or you could damage the vehicle's electrical parts.
- Never short-circuit the battery. This could cause it to overheat and be damaged.
- Keep sparks, cigarettes, and flames away from the battery because the battery could explode.
- Electrolyte (battery acid) is made of corrosive diluted sulfuric acid. If it spills on nearby parts, it can crack, stain, or discolor them. And if it gets on your skin or in your eyes, it can cause burns or blindness. Please observe the following handling instructions:
 - If electrolyte gets on plastic parts or other nearby parts, wipe it off with a soft cloth or chamois soaked in a solution of water and neutral detergent then immediately rinse the affected parts with plenty of water.
 - If electrolyte gets on your hands or clothes, rinse thoroughly with water. If electrolyte gets in your eyes, flush them with water immediately and get immediate medical attention.
- Open doors and windows in any closed space where you may be charging or working with the battery.
- Always wear protective clothing and goggles when working with the battery, or have a skilled automobile technician do it.

⚠ WARNING

- If you are quick-charging your battery, first disconnect the battery cables.
- In order to prevent a short-circuit, be sure to disconnect the negative (-) terminal first, and reconnect it last.
- If the electrolyte level is very low, have the battery checked at an authorized Mitsubishi Motors dealer or a repair facility of your choice.
- Battery posts, terminals and related accessories contain lead and lead compounds. Wash hands after handling.

9

📖 NOTE

- Check each battery terminal for corrosion. You can prevent further corrosion by washing with a solution of baking soda and water. Grease the posts and clamps after cleaning or tightening them.
- Ensure the battery is securely installed and cannot be moved. Also check each terminal for tightness.
- If you will not be driving your vehicle for a long period of time, remove the battery and store it in a place where the battery fluid will not freeze. The battery only should be stored with a full charge.
- Before cleaning the battery, tighten all the filler port caps to keep dirt and moisture out.

Tires

N00939201664

⚠ WARNING

- **Driving with tires that are worn, damaged or improperly inflated is dangerous. These tire conditions will adversely affect vehicle performance. These tire conditions can also cause a tread separation or blowout which may result in an accident causing serious injury or death.**
- **Tires, including the spare tire, degrade over time with age even when they are not being used. It is recommended that tires over 6 years old generally be replaced even if damage is not obvious.**

It is important to familiarize yourself with the following terms:

- Cold tire pressure:

- The measured pressure after the vehicle has been parked for at least three hours, or
- The measured pressure when the vehicle is driven less than 1 mile (1.6 km) after having been parked for three hours.
- Maximum pressure: the maximum permissible cold tire inflation pressure for this tire.
- Recommended inflation pressure: the inflation pressure for optimum tire performance.
- Intended outboard sidewall:
 - The sidewall that contains a whitewall, bears white lettering or bears manufacturer, brand, and/or model name molding that is higher or deeper than the same molding on the other sidewall of the tire, or
 - The outward facing sidewall of an asymmetrical tire that has a particular side that must always face outward when mounted on a vehicle.

- Passenger car tire: a tire intended for use on passenger cars, multi-purpose passenger vehicles, and trucks that have a gross vehicle weight rating (GVWR) of 10,000 pounds or less.
- Light truck (LT) tire: a tire designated by its manufacturer as primarily intended for use on lightweight trucks or multipurpose passenger vehicles.
- Tread: portion of a tire that comes into contact with the road.
- Tread rib: a tread section running circumferentially around a tire.
- Tread separation: pulling away of the tread from the tire carcass.
- Carcass: the tire structure, except tread and sidewall rubber which, when inflated, bears the load.
- Sidewall: portion of a tire between the tread and bead.
- Section width: the linear distance between the exteriors of the sidewalls of an inflated tire, excluding elevations due to labeling, decoration, or protective bands.

- Bead: the part of the tire that is made of steel wires, wrapped or reinforced by ply cords and that is shaped to fit the rim.
- Ply: a layer of rubber-coated parallel cords.
- Cord: the strands forming the plies in the tire.
- Rim: a metal support for a tire or a tire and tube assembly upon which the tire beads are seated.
- Rim diameter: nominal diameter of the bead seat.
- Groove: the space between two adjacent tread ribs.

- 2- Service Description
- 3- Maximum Load
- 4- Maximum Pressure
- 5- U.S. DOT Safety Standards Code (TIN)
- 6- Treadwear, Traction and Temperature Grades

Size Designation

EXAMPLE: P215/65R15

P	Passenger car tire size based on U.S.A. design standards
215	Section width in millimeters (mm)
65	Aspect ratio in percent (%) Ratio of section height to section width of tire.
R	Construction code •“R” means radial construction. •“D” means diagonal or bias construction.
15	Rim diameter in inches (in)

Tire Markings

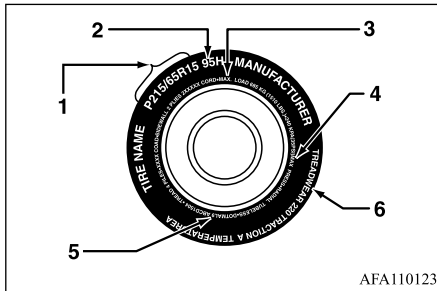

1- Size Designation

 **NOTE**

- European/Japanese metric tire sizing is based on European/Japanese design standards. Tires designed to these standards have the tire size molded into the sidewall beginning with the section width. The letter “P” is absent from this tire size designation.
Example: 215/65R15 96H.

- LT (Light Truck) -metric tire sizing is based on U.S.A. design standards. The size designation for LT-metric tires is the same as for P-metric tires except for the letters “LT” that are molded into the sidewall preceding the size designation.
Example: LT235/85R16.

 **NOTE**

- Temporary spare tires are high pressure compact spares designed for temporary emergency use only. Tires designed to this standard have the letter “T” molded into the sidewall preceding the size designation.
Example: T145/80D18 103M.

Service Description

EXAMPLE: 95H

95	<p>Load index A numerical code associated with the maximum load a tire can carry.</p>
----	---

H

Speed symbol
A symbol indicating the range of speeds at which a tire can carry a load corresponding to its load index under certain operating conditions.
The maximum speed corresponding to the speed symbol should only be achieved under specified operating conditions. (i.e. tire pressure, vehicle loading, road conditions and posted speed limits)

Maximum Load

Maximum load indicates the maximum load this tire is designed to carry.

⚠ WARNING

● **Overloading of your tire is dangerous. Overloading can cause tire failure, affect vehicle handling, and increase your stopping distance. Use tires of the recommended load capacity for your vehicle. Never overload them.**

Maximum Pressure

Maximum Pressure indicates the maximum permissible cold tire inflation pressure for this tire.

Tire Identification Number (TIN)

The TIN may be found on one or both sides of the tire but the date code may only be on one side. Look for the TIN on the outboard side of tires as mounted on the vehicle. If the TIN is not found on the outboard side then you will find it on the inboard side of the tire.

EXAMPLE: DOT MA L9 ABCD 1504

DOT	Department of Transportation This symbol certifies that the tire is in compliance with the U.S. Department of Transportation tire safety standards, and is approved for highway use.
MA	Code representing the tire manufacturing location. (2 digits)
L9 ABC D	Code representing the tire size. (2 digits) Code used by tire manufacturer. (1 to 4 digits)
15	Number representing the week in which the tire was manufactured. (2 digits)
04	Number representing the year in which the tire was manufactured. (2 digits)

Treadwear, Traction and Temperature Grades

Treadwear

The treadwear grade is a comparative rating based on the wear rate of the tire when tested under controlled conditions on a specified government test course. For example, a tire graded 150 would wear one and one-half (1^{1/2}) times as well on the government course as a tire graded 100. The relative performance of tires depends upon the actual conditions of their use, however, and may depart significantly from the norm due to variations in driving habits, service practices and differences in road characteristics and climate.

Traction

The traction grades, from highest to lowest, are AA, A, B and C. Those grades represent the tire's ability to stop on wet pavement as measured

under controlled conditions on specified government test surfaces of asphalt and concrete. A tire marked C may have poor traction performance.

Temperature

The temperature grades are A (the highest), B and C, representing the tire's resistance to the generation of heat and its ability to dissipate heat when tested under controlled conditions on a specified indoor laboratory test wheel. Sustained high temperature can cause the material of the tire to degenerate and reduce tire life, and excessive temperature can lead to sudden tire failure. The grade C corresponds to a level of performance which all passenger car tires must meet under the Federal Motor Vehicle Safety Standard No. 109. Grades B and A represent higher levels of performance on the laboratory test wheel than the minimum required by law.

Tire inflation pressures

N00939302095

Proper tire inflation pressure is essential for the safe and satisfactory operation of your vehicle. The wrong tire pressure will cause problems in three major areas:

- **Safety**
Too little pressure increases flexing in the tire and can cause tire failure. Too much pressure can cause a tire to lose its ability to cushion shock. Objects on the road and potholes could then cause tire damage that may result in tire failure.
- **Economy**
The wrong tire pressure can cause uneven wear patterns in the tire tread. These abnormal wear patterns will reduce the tread life, and the tire will have to be replaced sooner.
Too little pressure also makes it harder for the tire to roll, and this uses up more fuel.

- **Ride comfort and vehicle stability**
The superior riding experience built into your vehicle partly depends on the correct tire pressure. Too much pressure gives an uncomfortable and jarring ride. Too little pressure feels as if your vehicle is slow to respond.
Unequal tire pressures can make steering your vehicle uneven and unpredictable.

The tire pressure for your vehicle under normal driving conditions is listed on the placard attached to the driver's door sill.
Refer to "Tire and loading information placard" on page 11-3.

The recommended inflation pressures under normal driving conditions should be used for the tires listed below.

Item	Tire size	Front	Rear
Normal tire	P215/70 R16	260 KPA, 38 PSI	260 KPA, 38 PSI
	P225/55 R18	250 KPA, 36 PSI	250 KPA, 36 PSI
Compact spare tire	T155/90 D16 T155/80 D17	420 KPA, 60 PSI	

Tire pressures should be checked, and adjusted if necessary, at least once a month.

Pressures should be checked more often whenever weather temperatures change severely, because tire pressures change with outdoor tempera-

tures. The pressures listed are always “cold inflation pressure”.

Cold inflation pressure is measured after the vehicle has been parked for at least three hours or is driven less than 1 mile (1.6 km) after having been parked for three hours.

Cold inflation pressure must not go above the maximum values molded into the tire sidewall. After driving several miles, your tire inflation pressure may increase 2 to 6 psi (14 to 41 kPa) from the cold inflation pressure. Do not let air out of the tires to get back to the specified cold pressure, or your tires will be too low.

Check your tires each time you refuel. If one tire looks lower than the others, check the pressure for all of them.

You should also take the following safety precautions:

- Keep your tires inflated to the recommended pressures. (See the tire and loading information placard attached to the driver’s door sill.)

- Stay within the recommended load limits.
- Make sure that the weight of any load in your vehicle is evenly distributed.
- Drive at safe speeds.
- After filling your tires to the correct pressure, check them for damage and air leaks. Be sure to reinstall the caps on the valve stems.

Replacing tires and wheels

N00939601509

CAUTION

- Avoid using different size tires from the one listed and the combined use of different types of tires, as this can affect driving safety. Refer to “Tires and wheels” on page 11-7.
- On all-wheel drive vehicles, always use tires of the same size, same type, and same brand, and which have no wear differences. Using tires that differ in size, type, brand or the degree of wear, will increase the differential oil temperature, resulting in possible damage to the driving system. Further, the drive train will be subjected to excessive loading, possibly leading to oil leakage, component seizure, or other serious problems.

CAUTION

- Only Mitsubishi Motors Authorized wheels should be used, because your vehicle is equipped with a tire pressure monitoring system.

Use of another type of wheel risks air leaks and sensor damage, as it will not be possible to install the tire pressure sensor properly.

NOTE

- On vehicles with Electric parking brake, 16 inch steel wheels cannot be used on your vehicle because they interfere with brake parts.

Additionally, 16 inch aluminum wheels may not be used on your vehicle depending on the type, even if they are Mitsubishi Motors Genuine wheels.

Consult an authorized Mitsubishi Motors dealer with specific questions on wheels that can be used on your vehicle.

Tire maintenance

N00939700141

The following maintenance steps are recommended:

- Check tire pressures regularly.

- Have regular maintenance done on the wheel balance and front and rear suspension alignment.
- Rotate your tires regularly as described in the “Tire rotation” section on page 9-18.

Tread wear indicator

N00939800184

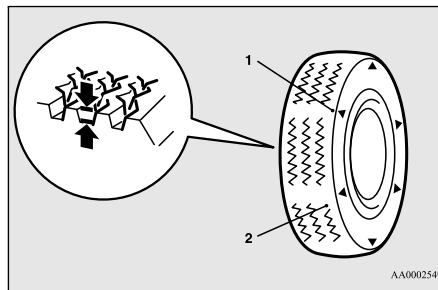

- 1- Location of the tread wear indicator
- 2- Tread wear indicator

Tread wear indicators are built into the original equipment tires on your vehicle to help you know when your tires should be replaced. Many states have laws requiring that you replace your tires at this point.

These indicators are molded into the bottom of the tread grooves and will appear when the

tire tread is worn down to 1/16 inch (1.6 mm).

When the bands appear next to one another in two or more places, replace your tires.

NOTE

- Tire wear indicators can have different marks and locations depending on the tire manufacturer.

Tire rotation

N00939901560

To even out the wear on your tires and make them last longer, Mitsubishi Motors Corporation recommends that you rotate your tires at the mileage listed in the “WAR-RANTY AND MAINTENANCE MANUAL”.

However, the timing for tire rotation may vary according to your vehicle condition, road surface conditions, and your own personal driving habits. Any time you notice unusual wear, rotate your tires as soon as possible.

When rotating tires, check for uneven wear, damage, and wheel alignment. Abnormal wear is usually caused by a wrong tire pressure, wheels that are not aligned properly, wheels that are out-of-balance, or severe braking.

Check with an authorized Mitsubishi Motors dealer or a repair facility of your choice to find out the reason for uneven tread wear.

The first tire rotation is the most important one. It will allow all your tires to wear evenly.

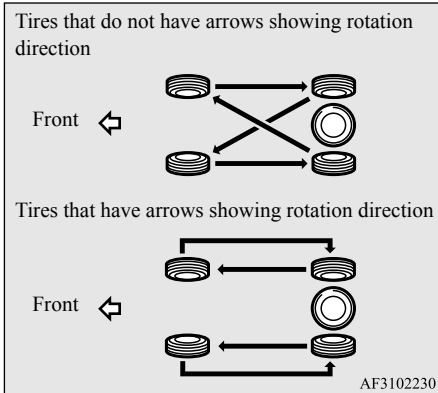

⚠ CAUTION

- A compact spare tire can be installed temporarily in place of a tire that has been removed during the tire rotation. However, it must not be included in the regular tire rotation sequence.

⚠ CAUTION

- If the tires have arrows (A) indicating the correct direction of rotation, swap the front and rear tires on the left-hand side of the vehicle and the front and rear tires on the right-hand side of the vehicle separately. Keep each tire on its original side of the vehicle. When installing the tires, make sure the arrows point in the direction in which the wheels will turn when the vehicle moves forward. Any tire whose arrow points in the wrong direction will not perform to its full potential.

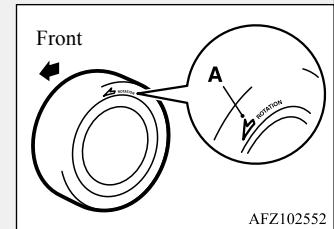

Brake pedal free play

⚠ CAUTION

- Avoid the combined use of different types of tires. Using different types of tires can affect vehicle performance and safety.

Snow tires

N00940001460

In some areas of the country, snow tires are required for winter driving. If snow tires are required in your area, you must choose snow tires of the same size and type as the original tires provided with your vehicle. Snow tires should also be installed on all four wheels. Otherwise your safety and vehicle handling can be reduced.

Even where laws may permit it, never exceed the maximum speed rating of the tire.

⚠ CAUTION

- Only Mitsubishi Motors Authorized wheels should be used, because your vehicle is equipped with a tire pressure monitoring system. Use of another type of wheel risks air leaks and sensor damage, as it will not be possible to install the tire pressure sensor properly.

Tire chains

N00940101139

⚠ CAUTION

- Tire chains cannot be used on your vehicle. The clearance between the chains and the body is not sufficient to allow proper clearance, and the vehicle body might be damaged.

Brake pedal free play

N00940300293

To check the brake pedal free play (A), turn off the engine and press the brake pedal several times with your foot. Then press the pedal down with your fingers until you first feel resistance.

Brake pedal free play:
.1 to .3 inch (3 to 8 mm)

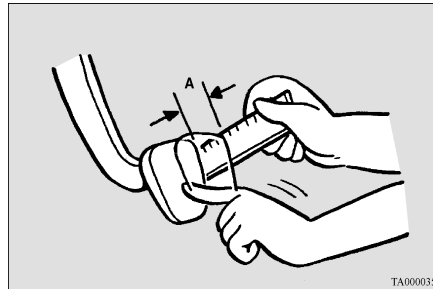

TA0000355

If the free play is not within these limits, take your vehicle to an authorized Mitsubishi Motors dealer or a repair facility of your choice for adjustment.

Parking brake lever stroke (if so equipped)

N00940401288

Check the parking brake lever travel occasionally. To check this, pull the lever up slowly and count the number of clicks of the ratchet. Parking brake lever stroke:

8 notches (clicks)

(Parking brake adjustment when pulled with the force of 200 N)

Also check to see if the lever stays gripped by the ratchet after pulling.

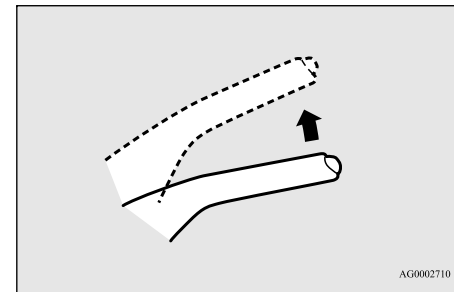

AG0002710

⚠ WARNING

- Continued operation of the vehicle with the parking brake lever out of adjustment may result in the vehicle moving when unattended.

Wiper blades

N00940701249

Check the wiper blades occasionally. Clean them regularly to remove deposits of salt and road film. Use a sponge or cloth and a mild detergent or non-abrasive cleaner to clean the blades and glass areas.

Replace the blades if they continue to streak or smear.

📖 NOTE

- Do not run the wipers on dry glass for a long time. This wears out the rubber and can scratch the glass.

During cold weather

If the blades are frozen to the windshield or rear window, do not operate the wipers until the ice has melted and the blades are freed, otherwise the wiper motor may be damaged.

Emission-control system maintenance

N00940800328

Your vehicle is equipped with an emission-control system that meets all the requirements of the U.S. Environmental Protection Agency and Environment Canada. The emission-control system is made of:

- a positive crankcase ventilation system
- an evaporative emission-control system
- an exhaust emission-control system

To be sure the emission-control system works properly, have your vehicle inspected and maintained by an authorized Mitsubishi Motors dealer or a repair facility of your choice. This should be done at the time or mileage specified in the “WARRANTY AND MAINTENANCE MANUAL”.

These, and all the other “general” maintenance services listed in this manual, need to be performed to keep your vehicle running properly and reliably.

You should also have an inspection and service any time you suspect a malfunction.

📖 NOTE

- To meet government regulations and promote cleaner air, your vehicle is equipped with an onboard diagnostic system (OBD). The engine electronic control module that controls OBD functions stores various data (especially about the exhaust emissions). This data will be erased if the battery cable is disconnected, which could make a rapid diagnosis difficult. Do not disconnect the battery cable when the engine malfunction indicator (“SERVICE ENGINE SOON” or “Check engine light”) is ON.

Spark plugs

N00940900231

Spark plugs must fire properly to ensure proper engine performance and emission-control.

Do not reuse spark plugs by cleaning or regapping. Spark plugs should be replaced at the mileage specified in the “WARRANTY AND MAINTENANCE MANUAL”.

📖 NOTE

- Use the recommended or equivalent spark plugs listed under “Engine specifications” on page 11-6. Use of other plugs could cause engine damage, loss of performance or radio noise.

Fuel hoses

N0094100040

Check the hose surfaces for any heat and mechanical damage, hard and brittle rubber, cracking, tears, cuts and abrasions. Pay special attention to the hoses closest to high heat sources such as the exhaust manifold. Check all the hose connections, such as clamps and couplings, to make sure they are secure and that there are no leaks. If you see any wear or damage, replace the hoses immediately.

Intake valve clearance

N00950100050

Have the valve clearance checked at an authorized Mitsubishi Motors dealer at the mileage specified in the “WARRANTY AND MAINTENANCE MANUAL”.

If the engine sounds abnormally loud, have adjustments made by an authorized Mitsubishi Motors dealer.

Fuel system (tank, pipe line and connection, and fuel tank filler cap)

N00941300173

Check these regularly for damage or leaks in the fuel lines and connections. Check the fuel tank filler cap for damage or looseness. Pay special attention to the fuel lines closest to

high heat sources such as the exhaust manifold.

WARNING

- If you see a fuel leak or if you smell fuel, do not run the engine. Any spark (including from the ignition), flame or smoking material could cause an explosion or fire. Call an authorized Mitsubishi Motors dealer or a repair facility of your choice for assistance.

Evaporative emission control system (except evaporative emission canister)

N00941400187

If the fuel-vapor vent line is clogged or damaged, the fuel-vapor mixture will escape, polluting the air.

Have the system checked at an authorized Mitsubishi Motors dealer at the mileage specified in the “WARRANTY AND MAINTENANCE MANUAL”.

General maintenance

N00941501299

The next pages list the maintenance service recommended by Mitsubishi Motors Corporation. In addition to the general maintenance that needs to be performed at the times listed,

there are other parts which do not usually need regular maintenance.

But, if any of these parts stops working properly, your vehicle performance could suffer. Have these items checked if you notice a problem with them.

If you have any questions, see your authorized Mitsubishi Motors dealer for assistance.

Disc brake pads

N00941600059

Good brakes are essential for safe driving. Check the brake pads for wear. For good braking performance, replace the brake pads with the same type pads as the originals.

Brake hoses

N00941700076

Brake hoses and tubing should be checked for:

- Severe surface cracking, scuffing or worn spots. If the fabric casing of the hose is showing through any cracks or worn spots in the rubber hose cover, the hose should be replaced. The brakes can fail if the hose wears through.
- Improper installation may cause twisting, or wheel, tire or chassis interference.

Ball joint, steering linkage seals, drive shaft boots

N00941800093

Check the following parts for damage and grease leaks:

- Ball joint boots of the suspension and steering linkage
- Bellows on both ends of the drive shaft

Exhaust system

N00942201118

WARNING

- **Carbon monoxide gas from your vehicle's exhaust is poisonous. Breathing these fumes can cause unconsciousness or death.**

The best way to keep carbon monoxide gas from entering inside your vehicle is to have the engine exhaust system properly serviced. Have a competent mechanic inspect the complete exhaust system and nearby body areas for broken, damaged, deteriorated, or mispositioned parts if you notice any of the following:

- A change in the sound of the exhaust system
- The smell of exhaust fumes inside the vehicle

- The underside or rear of the vehicle is damaged

Also check the exhaust system each time the vehicle is raised for lubrication, oil changes, or required service. Any open seams or loose connections could let dangerous exhaust fumes seep into the luggage and passenger compartments.

Check for any of the following conditions:

- Check for holes or exhaust gas leaks caused by corrosion or damage.
- Check the joints and connections for looseness or exhaust gas leaks.
- Check the rubber hangers and brackets for damage.

Hood lock release mechanism and safety catch

N00942501124

The hood lock release mechanism and hood safety catch should be checked, cleaned, and oiled when needed for easy movement and to prevent rust and wear. Use Multipurpose Grease NLGI Grade 2 sparingly for all sliding parts of the hood latch and release lever. Work the grease into the hood lock mecha-

nism until all the movable surfaces are covered.

Also, put a light coat of the same grease on the safety catch wherever moving parts touch.

For cold and snowy weather

N00942601141

Ventilation slots

The ventilation slots in front of the windshield should be brushed clear after a heavy snowfall so that the operation of the heating and ventilation systems will not be impaired.

Weatherstripping

To prevent freezing of the weatherstripping on the doors, engine hood, etc., they should be treated with silicone grease.

Additional equipment (For regions where snow is encountered)

It is a good idea to carry a shovel or a short-handled spade in the vehicle during the winter so that you can clear away snow if you get stranded. A small hand-brush for sweeping

Fusible links

snow off the vehicle and a plastic scraper for the windshield, rear window, and side windows are also useful.

Fusible links

N00942700291

The fusible links will melt to prevent a fire if a large current attempts to flow through certain electrical systems.

In case of a melted fusible link, see your authorized Mitsubishi Motors dealer or a repair facility of your choice for inspection and replacement.

For the fusible links, please refer to “Fuse load capacities” on page 9-24.

WARNING

- Fusible links must not be replaced by any other device. Failing to fit the correct fusible link may result in fire in the vehicle, property destruction and serious or fatal injuries at any time.

Fuses

N00942801967

Fuse block location

To prevent damage to the electrical system from short-circuiting or overloading, each

individual circuit is equipped with a fuse. The fuse blocks are located in the passenger compartment and in the engine compartment.

Passenger compartment

The fuse block in the passenger compartment is located behind the fuse lid in front of the driver’s seat at the position shown in the illustration.

Pull the fuse lid to remove it.

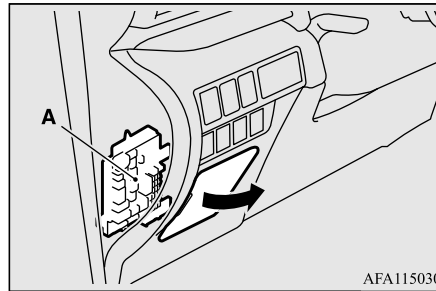

A- Fuse block

Engine compartment

The fuse block in the engine compartment is located as shown in the illustration.

Press the lock lever (1) and remove the fuse block cover (2).

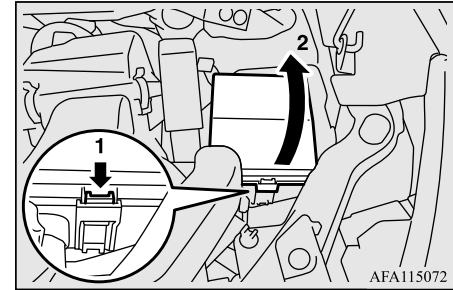

Fuse load capacities

N00954801502

This fuse list shows the names of the electrical systems and their fuse capacities.

There are spare fuses in the fuse block cover in the engine compartment. Always replace a blown fuse with one of the same capacity as the original.

Passenger compartment fuse location table

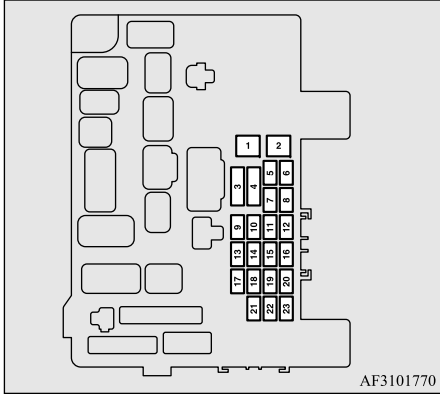

AF3101770

No.	Sym- bol	Electrical system	Capac- ity
1		Power window control	30 A*
2		Defogger	30 A*
3		Heater	30 A
4		Windshield wipers	30 A
5		Door locks	25 A
6	—	—	—
7		12 V power outlet	15 A

No.	Sym- bol	Electrical system	Capac- ity
8		Rear window wiper	15 A
9		Sunroof	20 A
10		Ignition switch	10 A
11		Option	10 A
12		Hazard warning flasher	15 A
13		4-wheel drive system	10 A
14	STOP	Stop lights (Brake lights)	15 A
15		Gauges	10 A
16		SRS airbag	7.5 A
17		Radio	15 A
18		Control unit relay	7.5 A
19		Interior lights (Room lights)	15 A
20		Back-up lights	7.5 A
21		Heated outside rearview mirrors	7.5 A
22		Outside rearview mirrors	10 A
23		Cigarette lighter/12 V power outlet	15 A

*: Fusible link

- Some fuses may not be installed on your vehicle, depending on the vehicle model or specifications.
- The table above shows the main equipment corresponding to each fuse.



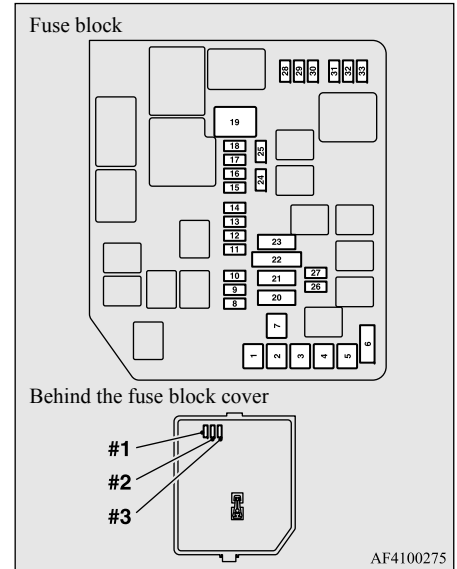



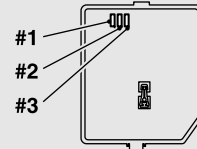







Engine compartment fuse location table

















Behind the fuse block cover



AF4100275

No.	Symbol	Electrical system	Capacity
1		Electric parking brake	30 A*
2		Electric parking brake	30 A*
3		Anti-lock braking system	40 A*
4		Anti-lock braking system	30 A*
5	—	—	—
6		Heated seats	30 A
7		Starter	30 A*
8		Alternator	7.5 A
9		Headlight washer	20 A
10		Security horn	20 A
11	A/T	Automatic transaxle	20 A
12		Horn	10 A
13		Sunshade	20 A
14		Front fog lights	15 A
15		Daytime running lights	10 A
16		Air conditioner	10 A
17		Engine control unit	7.5 A

No.	Symbol	Electrical system	Capacity
18		Audio system amplifier	15 A
19		Radiator fan motor	40 A*
20		Power seat (Driver seat)	30 A
21		Power seat (Passenger seat)	30 A
22	IOD	IOD	30 A
23		Air conditioning condenser fan motor	30 A*
24		Battery current sensor	7.5 A
25		Electric parking brake/Adaptive Cruise Control (ACC)	7.5 A
26		Headlight (high beam) (right)	10 A
27		Headlight (high beam) (left)	10 A
28		Turbo actuator	20 A
29		ENG/POWER	20 A
30		Fuel pump	15 A
31		Ignition coil	10 A

No.	Symbol	Electrical system	Capacity
32		Injector	20 A
33		ETV	15 A
#1	—	Spare fuse	10 A
#2	—	Spare fuse	15 A
#3	—	Spare fuse	20 A

*: Fusible link

- Some fuses may not be installed on your vehicle, depending on the vehicle model or specifications.
- The table above shows the main equipment corresponding to each fuse.

The fuse block does not contain spare 7.5 A, 25 A or 30 A fuses. If one of these fuses burns out, substitute with the following fuse.

7.5 A: 10 A spare fuse

25 A: 20 A spare fuse

30 A: 30 A power seat (passenger seat) fuse

When using a substitute fuse, replace with a fuse of the correct capacity as soon as possible.

Identification of fuse

Capacity	Color
7.5 A	Brown
10 A	Red
15 A	Blue
20 A	Yellow
25 A	Natural (white)
30 A	Green (fuse type) / Pink (fusible link type)
40 A	Green (fusible link type)

Fuse replacement

N00954901167

1. Before replacing a fuse, always turn off the electrical item connected to the fuse and turn the ignition switch to the "OFF" position or put the operation mode in OFF.
2. There is a fuse remover (A) in the engine compartment fuse block.

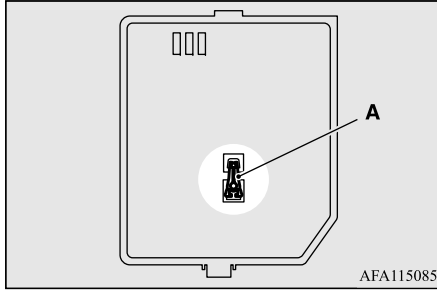

3. Clamp it on the fuse you wish to remove, and pull the fuse straight out from the fuse block.

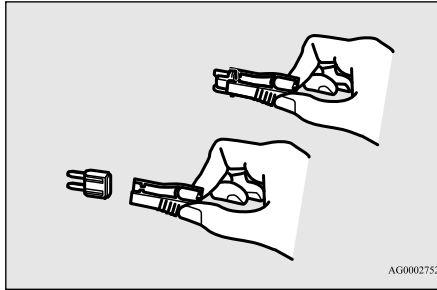

4. Use the fuse location diagrams and the matching tables, to check the fuse that is related to the problem. If the fuse is not blown, something else must be causing the problem. Have the system inspected by your authorized Mitsubishi Motors dealer or a repair facility of your choice.

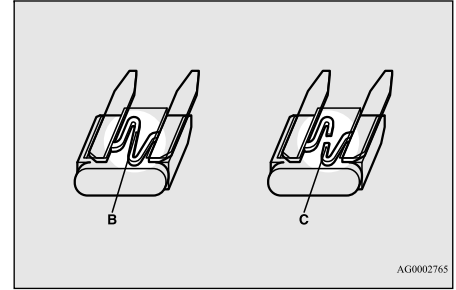

- B- Fuse is OK
- C- Blown fuse

5. Insert a new fuse of the same capacity securely into the appropriate slot.

CAUTION

- Never use a fuse with a capacity greater than the one listed or any substitute, such as wire, foil etc. This would cause the circuit wiring to heat up and could cause a fire.
- If the replacement fuse blows again after a short time, have the electrical system checked by an authorized Mitsubishi Motors dealer or a repair facility of your choice to find and correct the cause.

Replacement of light bulbs

N00942901434

Before replacing a bulb, be sure the light is off. Do not touch the glass part of the new bulb with your bare fingers; the oil from your skin will stay on the glass and dim or destroy the bulb when it gets hot.

CAUTION

- Bulbs are extremely hot immediately after being turned off.
When replacing a bulb, wait for it to cool sufficiently before touching it. You could otherwise be burned.
- Handle halogen light bulbs with care. The gas inside a halogen light bulb is highly pressurized, so dropping, knocking, or scratching a halogen light bulb can cause it to shatter.

9

CAUTION

- Never hold a halogen light bulb with a bare hand, dirty glove, etc.
The oil from your hand could cause the bulb to break the next time the headlights are used.
If the glass surface is dirty, clean it with alcohol and let it dry completely before installing the bulb.

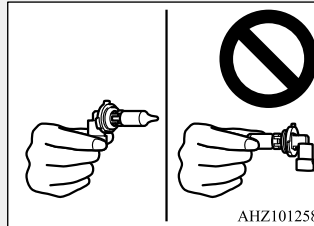

- Do not install commercially available LED type bulbs.
Commercially available LED type bulbs could adversely affect the operation of the vehicle, such as by preventing the lights and other vehicle equipment from operating properly.

NOTE

- If you are unsure of how to carry out the work as required, it is recommended that these procedures be carried out by an authorized Mitsubishi Motors dealer or a repair facility of your choice.

NOTE

- Be careful not to scratch the vehicle body when removing a light and lens.
- When it rains, or when the vehicle has been washed, the inside of the lens sometimes becomes temporarily foggy. This is the same phenomenon as when window glass mists up on a humid day, and does not indicate a functional problem.
When the light is switched on, the heat will remove the fog. However, if water gathers inside the light, please have it checked by an authorized Mitsubishi Motors dealer or a repair facility of your choice.

Bulb location and capacity

N00943001197

CAUTION

- When replacing a bulb, be sure to use a new bulb of the same type, wattage, and color.
If you install a different bulb, the bulb could malfunction or fail to come on and could lead to a vehicle fire.

Outside

N00950302245

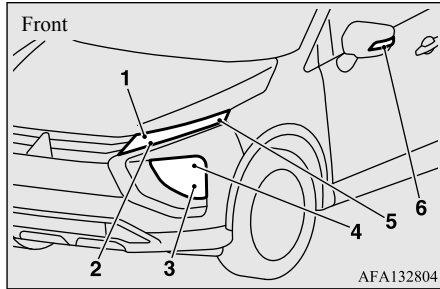

Item		Watt- age	ANSI Trade No. or Bulb type
1 - Parking light/ Daytime running light		—	—
2 - Front turn signal light		—	—
3 - Front fog light (if so equipped)		—	—
4 - Headlight	Halogen bulb	55 W	HIR2
	LED	—	—
5 - Front side-marker light		—	—

Item	Watt- age	ANSI Trade No. or Bulb type
6 - Side turn signal light	—	—

NOTE

- The following lights use an LED.
Check with an authorized Mitsubishi Motors dealer or a repair facility of your choice when any of these lights needs to be repaired or replaced.
- Parking light
- Daytime running light
- Front turn signal light
- Front fog light (if so equipped)
- Headlight (LED type)
- Front side-marker light
- Side turn signal light

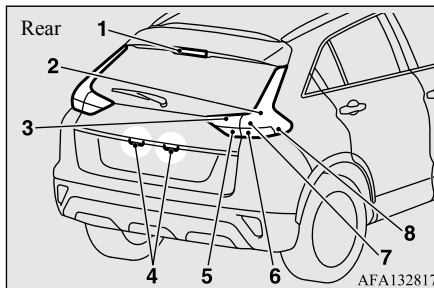

Item	Wattage	ANSI trade No. or Bulb type
1 - High-mounted stop light	—	—
2 - Tail and stop light	—	—
3 - Tail light	—	—
4 - License plate light	5 W	W5W
5 - Back-up light	21 W	W21W
6 - Rear turn sig- nal light	21 W	WY21W
7 - Stop light	—	—
8 - Rear side- marker light	—	—

NOTE

- The following lights use an LED.
Check with an authorized Mitsubishi Motors dealer or a repair facility of your choice when any of these lights needs to be repaired or replaced.
- High-mounted stop light
- Tail and stop light
- Tail light
- Stop light
- Rear side-marker light

Replacement of light bulbs

Inside

N00950401861

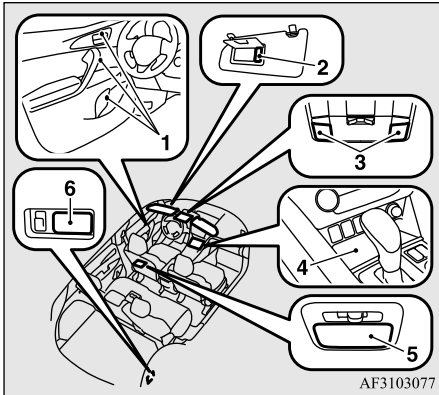

AF3103077

Item	Wattage
1 - LED interior illumination (Front door) (if so equipped)	—
2 - Vanity mirror lights (if so equipped)	2 W
3 - Dome light (front)/Reading light	10 W
4 - LED interior illumination (Smartphone tray)	—
5 - Dome light (rear)	8 W
6 - Cargo room light	5 W

NOTE

- The following lights use an LED.
Check with an authorized Mitsubishi Motors dealer or a repair facility of your choice when any of these lights needs to be repaired or replaced.
 - LED interior illumination (Front door) (if so equipped)
 - LED interior illumination (Smartphone tray)

Headlights (halogen bulb type)

N00901801320

1. To create enough work space, turn the steering wheel all the way in the direction opposite to the side you wish to replace.
2. Remove the screw (A), and then pull the wheel cut moulding (B) outward to release the three clips (C).

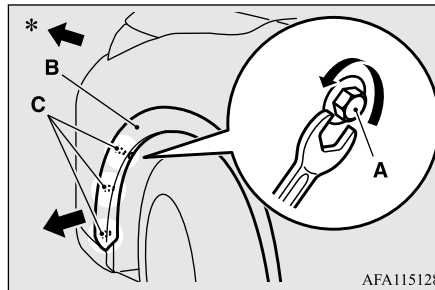

AFA115128

*: Front of the vehicle

CAUTION

- Do not pull the wheel cut moulding (B) more than is necessary to release the three clips (C). Otherwise, the wheel cut moulding could break.

3. Remove the three clips (D), and then pull back the splash shield (E).

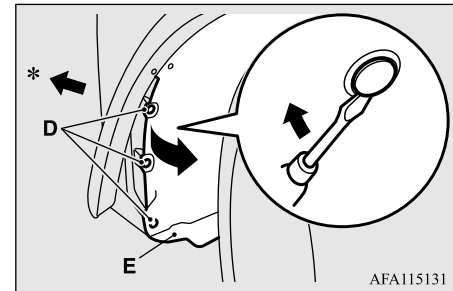

AFA115131

*: Front of the vehicle

4. Turn the cap (F) counterclockwise to remove it.

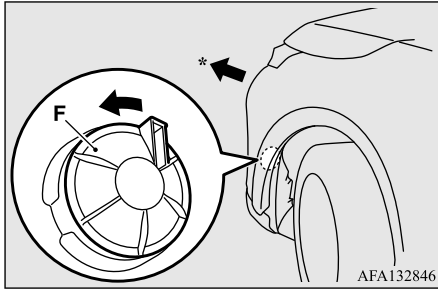

*: Front of the vehicle

5. While pulling the tab (G), pull out the socket (H).

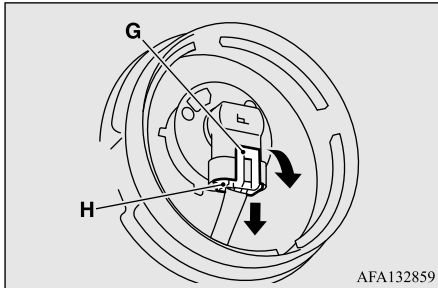

6. Turn the bulb (I) counterclockwise to remove it.

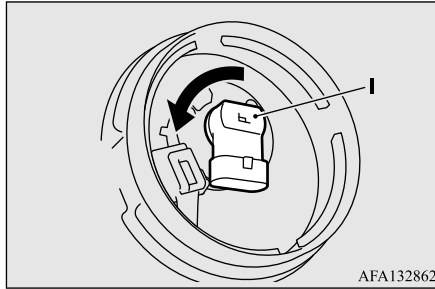

7. To install the bulb, perform the removal steps in reverse.

NOTE

- After installing the cap (F), make sure that the part on the cap that stands out (J) is pointing upward and the cap is locked in place. If the cap is not locked in place, it may become detached while the vehicle is being driven.

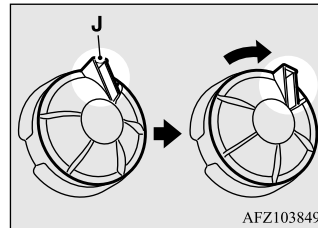

NOTE

- When refitting the clip (D), first insert part (K) of the clip into the hole and then press part (L) into it.

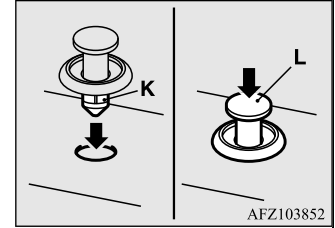

Headlights (LED type)

N00956200024

NOTE

- The headlights (LED type) use an LED. Check with an authorized Mitsubishi Motors dealer or a repair facility of your choice when the light needs to be repaired or replaced.

Headlight aim adjustment

N00943201359

The alignment of the headlights should be checked by an authorized Mitsubishi Motors dealer or a repair facility of your choice.

Replacement of light bulbs

Front side-marker lights

N00915501256

NOTE

- The front side-marker lights use an LED.
Check with an authorized Mitsubishi Motors dealer or a repair facility of your choice when the light needs to be repaired or replaced.

Side turn signal lights

N00943501235

NOTE

- The side turn signal lights use an LED.
Check with an authorized Mitsubishi Motors dealer or a repair facility of your choice when the light needs to be repaired or replaced.

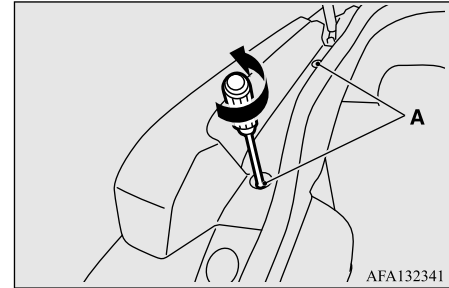

Parking lights/Daytime running lights

N00917301841

NOTE

- The parking lights and daytime running lights use an LED.
Check with an authorized Mitsubishi Motors dealer or a repair facility of your choice when the light needs to be repaired or replaced.

Front fog lights (if so equipped)

N00943602060

NOTE

- The front fog lights use an LED.
Check with an authorized Mitsubishi Motors dealer or a repair facility of your choice when the light needs to be repaired or replaced.

3. Insert the cloth-covered tip of a straight blade (or flathead) screwdriver into the hole (B) of the light unit.

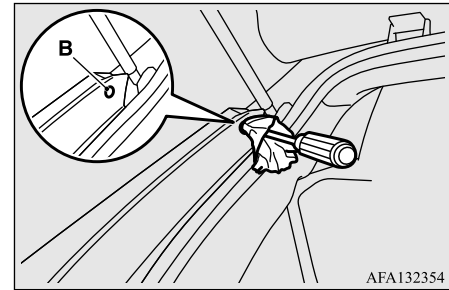

Front turn signal lights

N00943401540

NOTE

- The front turn signal lights use an LED.
Check with an authorized Mitsubishi Motors dealer or a repair facility of your choice when the light needs to be repaired or replaced.

Rear combination lights

N00943701686

1. Open the liftgate.
2. Remove the two screws (A).

4. Turn the straight blade (or flathead) screwdriver slightly to the right and press down to make the light unit (C) float up slightly.

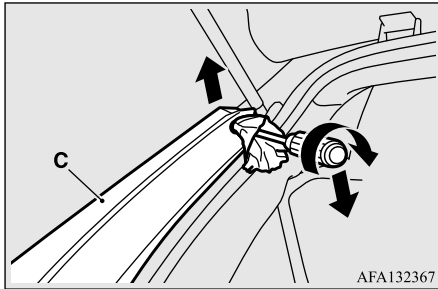

AFA132367

5. Move the light unit (C) rearward and remove the three light unit pins (D).

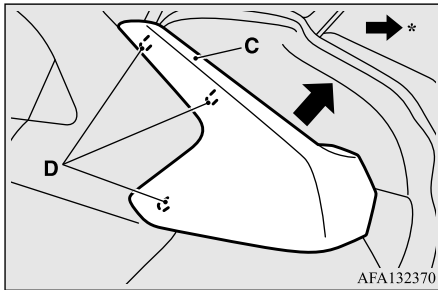

AFA132370

*: Rear of the vehicle

6. Turn the rear turn signal light socket counterclockwise and remove it, and then pull the bulb out of the socket.

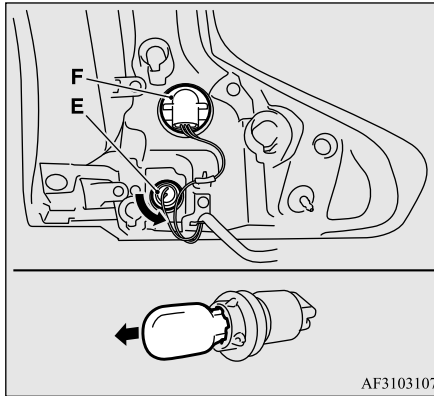

AF3103107

E- Rear turn signal light

F- Tail and stop light, stop light, and rear side-marker light (LED) - cannot be replaced

NOTE

● The tail and stop lights, stop lights and rear side-marker lights use an LED.
Check with an authorized Mitsubishi Motors dealer or a repair facility of your choice when any of these lights needs to be repaired or replaced.

7. To install the bulb, perform the removal steps in reverse.

Back-up lights

N00929101110

1. Open the liftgate.
2. Insert the cloth-covered tip of a straight blade (or flathead) screwdriver into the groove, and then pry gently to remove the lid (A).

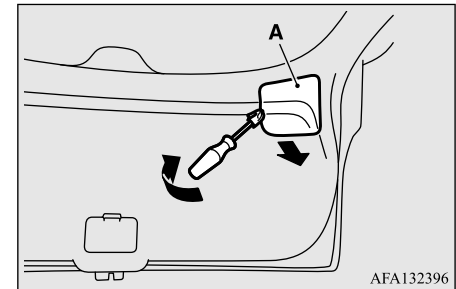

AFA132396

3. Turn the socket (B) counterclockwise to remove it, and then pull the bulb out of the socket.

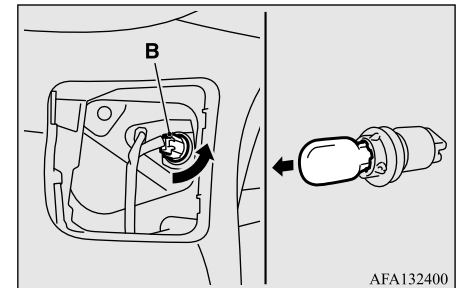

AFA132400

Vehicle care precautions

4. To install the bulb, perform the removal steps in reverse.

License plate lights

N00944001455

1. When removing the light unit (A), push it toward the left side of the vehicle body.

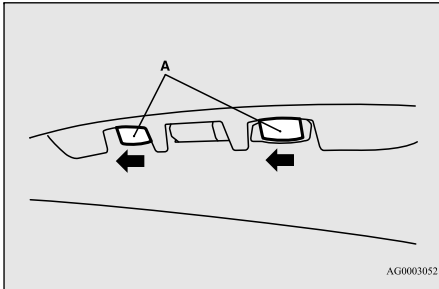

2. Use a screwdriver to gently pry up the tab (B) and remove the lens.

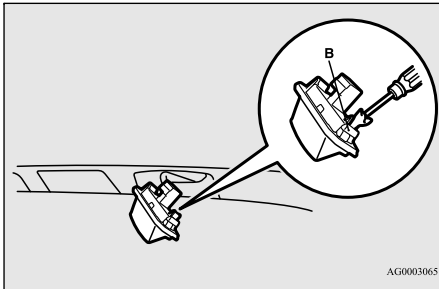

NOTE

- Wrap a cloth around the tip of the screwdriver to keep from scratching the lens.

3. Pull the bulb out of the socket.

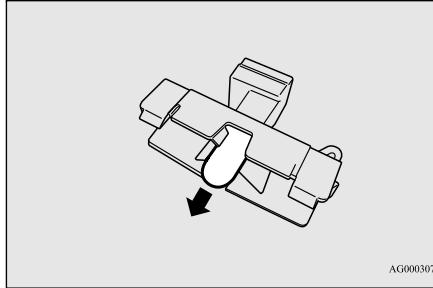

4. To install the bulb, perform the removal steps in reverse.

NOTE

- When mounting the light unit, insert tab (C) first then align tab (D) with its hole.

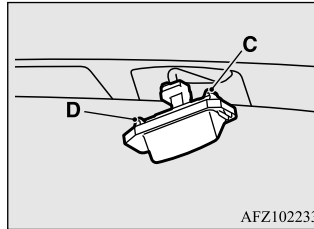

High-mounted stop light

N00943901167

NOTE

- The high-mounted stop light uses an LED type bulb.
Check with an authorized Mitsubishi Motors dealer or a repair facility of your choice when the light needs to be repaired or replaced.

Vehicle care precautions

N00945100166

In order to maintain the value of your vehicle, perform regular maintenance using the proper materials and procedures. Be sure to use only those materials and procedures that meet your local environmental pollution control regulations. Choose the materials you will use carefully, to be sure that they do not contain corrosives. If you are not sure, contact an authorized Mitsubishi Motors dealer for help in choosing these materials.

⚠ CAUTION

● Cleaning products can be dangerous. Some are poisonous and others are highly flammable. Some are dangerous if you breathe their fumes in a closed space. When you use anything in a container to clean your vehicle, be sure to follow the instructions. Always open your vehicle doors or windows when you're cleaning the inside. Never use the following chemicals to clean your vehicle:

- Gasoline
- Carbon Tetrachloride
- Benzine
- Kerosene
- Naphtha
- Acetone
- Turpentine
- Paint Thinner
- Lacquer Thinner
- Nail Polish Remover

These can all be dangerous, and they all can damage your vehicle.

Cleaning the inside of your vehicle

N00945200095

After washing the inside of your vehicle with any cleaner, wipe it dry in a shady, well ventilated area.

⚠ CAUTION

● Do not use organic substances (solvents, benzene, kerosene, alcohol, gasoline, etc.) or alkaline or acidic solutions. These chemicals can cause discoloring, staining or cracking of the surface. If you use cleaners or polishing agents, make sure their ingredients do not include the substances mentioned above.

📖 NOTE

● Always read the instructions on the cleaner label.

Plastic, vinyl, synthetic leather, fabric and flocked parts

N00945301237

1. Lightly wipe these off with a soft cloth soaked in a 3 % solution of gentle soap and water.
2. To rinse, dip the cloth in fresh water, wring it out well, and wipe off all the soap.

📖 NOTE

● Do not use cleaners, conditioners, and protectants containing silicones or wax. Such products, when applied to the instrument panels or other parts, may cause reflections on the windshield and obscure vision. Also, if such products get on the switches of the electrical accessories, it may lead to failure of these accessories.

Upholstery

N00945500128

1. To maintain the value of your new vehicle, maintain the upholstery carefully and keep the interior clean. Use a vacuum cleaner and brush to clean the seats. If stained, vinyl and synthetic leather should be cleaned with an appropriate cleaner. Cloth fabrics can be cleaned with either upholstery cleaner or a 3% solution of gentle soap in lukewarm water.
2. Clean the carpeting with a vacuum cleaner and remove any stains with carpet cleaner. Oil and grease can be removed by lightly dabbing with a clean white cloth and spot remover.

NOTE

- If fuzzing is difficult to remove from the seat upholstery, draw a suitable defuzzing brush over the surface in one direction.

Genuine leather (if so equipped)

N00945601285

1. To clean, lightly wipe the leather with a soft cloth soaked in a 5 % solution of gentle soap and water.
2. To rinse, dip the cloth in fresh water, wring it out well, and wipe off all the soap.
3. To preserve and protect, use a leather protecting agent on the genuine leather surface.

NOTE

- If genuine leather is wet with water, wipe it with a dry, soft cloth. If left damp, mildew may grow.
- The genuine leather surface can be damaged if brushed with a nylon or synthetic fiber brush.
- Organic solvents such as benzene, kerosene, alcohol, gasoline, or acid or alkaline solvents can discolor the genuine leather surface and should not be used.
- Genuine leather can mildew if not kept clean. Clean up any oil stains immediately.

NOTE

- The genuine leather surface may harden and shrink if it is exposed to direct sunlight for long hours. When your vehicle is parked, place it in the shade as much as possible.
- When the temperature of the vehicle interior rises in summer, vinyl products left on the genuine leather seat may deteriorate and stick to the seat.

Cleaning the outside of your vehicle

N00945700058

To protect your vehicle's finish, wash it often and thoroughly. If desired, you may wax your vehicle using a nonabrasive automobile wax.

Foreign material

N00945800033

Industrial pollution, road tar, bird droppings, tree sap, insect remains, sea water and other foreign matters can damage the finish on your vehicle.

Generally, the longer any foreign material stays on the finish, the worse the damage. Wash your vehicle as soon as possible whenever the finish gets soiled.

Washing

N00945901813

Chemicals contained in the dirt and dust picked up from air, rain, snow, or road surfaces can damage the paint and body of your vehicle if left on.

Frequent washing and waxing is the best way to protect your vehicle from this damage.

Do not wash the vehicle in direct sunlight. Park the vehicle in the shade and spray it with water to remove dust. Next, using plenty of clean water and a car washing mitt or sponge, wash the vehicle from top to bottom.

Use a mild car washing soap if necessary. Rinse thoroughly and wipe dry with a chamois or soft cloth. After washing the vehicle, carefully clean the joints and flanges of the doors, hood, etc., where dirt is likely to remain.

CAUTION

- When washing the underside of your vehicle or the wheels, wear a pair of gloves to protect your hands.
- If your vehicle is equipped with the rain sensor, place the wiper switch lever in the "OFF" position to deactivate the rain sensor before washing the vehicle. Otherwise, the wipers will operate in the presence of water spray on the windshield and may get damaged as a result.

⚠ CAUTION

- Never spray or splash water on the electrical parts in the engine compartment. This may damage them. Be careful also when washing the underbody to ensure that water does not enter the engine compartment.
- Some hot water washing equipment uses high pressure and heat to clean your vehicle. Because hot water can damage plastic parts and seep inside your vehicle, make sure you do the following when using such equipment:
 - Keep the washing nozzle at least 28 inches (70 cm) away from the vehicle body.
 - When washing around the door glass, hold the nozzle at a distance of more than 28 inches (70 cm) and at a right angle to the glass surface.

Using an automatic car wash**⚠ CAUTION**

- Avoid automatic car washes that use rotating brushes. These brushes may scratch the paint surface and make it dull. Scratches are more noticeable on darker colored vehicles.
- Make sure to do the following when using an automatic car wash, with help from either this manual or the car wash operator, to avoid damaging your vehicle:
 - Fold the outside rearview mirrors.
 - Close the door windows.

⚠ CAUTION

- Close the front sunroof (if so equipped)
- Tape or remove the rear wiper arm assembly.
- If your vehicle is equipped with a rain sensor, place the wiper switch in the “OFF” position to deactivate the sensor prior to washing the vehicle.
- Do not operate the windshield wiper during the car wash.
- As your vehicle is equipped with the roof spoiler, check with the car wash operator before using the car wash.
- If your vehicle is equipped with roof rails, check with the car wash operator before using the car wash.

During cold weather

Salt and other chemicals used on winter roads in some geographical areas can have a detrimental effect on the vehicle underbody. You should flush the underbody with a high pressure hose every time you wash the outside of your vehicle.

Take special care to remove mud or other debris which could trap and hold salt and moisture.

After washing your vehicle, wipe off all waterdrops from the rubber parts around the doors to prevent the doors from freezing.

📖 NOTE

- When the door is frozen, opening it by force may tear off or crack the rubber gasket installed around the door. Pour warm water to melt the ice. Be sure to thoroughly wipe off the water after opening the door. To prevent freezing of the weatherstripping on the doors, hood, etc., treat with silicone lubricant.

Waxing

N00946001257

Wax your vehicle once or twice a year, or when water does not bead up on the paint.

Use a soft cloth to put a small amount of wax on the painted surfaces. After the wax has dried, polish with a dry soft cloth.

Do not wax your vehicle in direct sunlight. You should wax when the painted surfaces are cool.

⚠ CAUTION

- Waxes containing high abrasive compounds should not be used. These waxes remove rust and stain effectively from the paintwork, but are harmful to the finish of the paint, because they also remove paint/clearcoat. They are also harmful to other glossy surfaces such as the grille, trim, moldings, etc.

CAUTION

- Do not use gasoline, benzene, kerosene or paint thinners to remove road tar or other dirt from the vehicle surface.
- Do not put wax on the areas having black matte coating because it can cause uneven discoloration, patches, blurs, etc. If these get wax on them, wipe the wax off right away with a soft cloth and warm water.
- On vehicles equipped with the power panoramic sunroof, be careful when waxing the area around the front sunroof opening, not to put any wax on the weatherstrip (black rubber) and surrounding plastic parts. If stained with wax, the weatherstrip and surrounding plastic parts cannot maintain a weatherproof seal with the front sunroof.

N00946201099

Damaged paint

Small cracks and scratches in the paint coat should be touched up as soon as possible with touch-up paint to prevent corrosion.

Check body areas facing the road or the tires carefully for damage to the paint caused by flying stones, etc. The paint code number for your vehicle can be found on the vehicle information code plate located on the front passenger door sill.

Cleaning plastic parts

N00946301250

Use a sponge or chamois to clean these parts. If the vehicle wax sticks to a gray or black rough surface of the bumper, molding or lights, the surface may appear white in color. In this case, wipe it off using lukewarm water and a soft cloth or chamois.

CAUTION

- Do not use a scrubbing brush or other rough scrubber as these may damage the plastic surface.
- Do not use wax containing compounds (polishing powder) which may damage the plastic surface.

CAUTION

- Do not let plastic parts get soiled with gasoline, oil, brake fluids, engine oils, greases, paint thinner, and sulfuric acid (battery electrolyte), as such substances will cause stains, cracks, or discoloration.

Also, be sure to avoid even brief contact with chemicals such as coating materials, which may cause cracks that allow moisture to enter, potentially damaging the lights.

If any of these get on a plastic part, wipe them up with a soft cloth or chamois and a mild solution of soap and water. Then rinse them immediately with water.

N00946400052

Chrome parts

To prevent spots and corrosion of chrome parts, wash with water, dry thoroughly, and apply a nonabrasive automotive wax. If the chrome is severely damaged or pitted, use a commercially available chrome polish.

Aluminum wheels

N00946501249

1. Remove dirt using a wet sponge.
2. Use a mild detergent on any dirt that cannot be removed easily with water. Rinse off the detergent after washing the wheel.

Polishing

N00946100046

If painted surfaces have been severely damaged and lost their original luster and color tone, polish the surface lightly with a fine polishing compound. Avoid limiting your polishing to the damaged surface only; polish a somewhat wider area, moving the polishing cloth in one direction. After polishing, flush the compound from the surface and apply a coat of wax to regain a beautiful luster.

3. Dry the wheel thoroughly using a chamois leather or a soft cloth.

CAUTION

- Do not use a brush or other hard implement on the wheels.
- Do not use any cleaner that contains an abrasive substance or is acidic or alkaline. Doing so could cause the coating on the wheels to peel or become discolored or stained.
- Do not directly apply hot water using a steam cleaner or by any other means.
- Contact with seawater or road salt used for de-icing can cause corrosion. Rinse off such substances as soon as possible.

Window glass

N00946600054

The window glass can usually be cleaned using only a sponge and water. Glass cleaner can be used to remove wax, oil, grease, dead insects, etc. After washing the glass, wipe it dry with a clean, dry, soft cloth.

Wiper blades

N00946700068

Use a soft cloth and glass cleaner to remove grease, dead insects, etc., from the wiper blades.

Replace the wiper blades when they no longer clean the windshield and rear window properly.

Cleaning the front sunroof (if so equipped)

N00946801082

Clean the inside of the front sunroof with a soft cloth. Hard deposits should be wiped away with a cloth dipped in warm, neutral detergent solution. Wipe away the solution with a sponge dipped in fresh water.

NOTE

- The surface treatment on the inside of the glass may be removed if a hard cloth or organic solvent is used.

Engine compartment

N00947000071

Never spray or splash water on the electrical accessories in the engine compartment. This puts the engine at risk of being damaged.

Do not bring the circumferential parts, the plastic parts and so on into contact with sulfuric acid (battery electrolyte) which may crack, stain or discolor them.

If they are in contact, wipe off with soft cloth, chamois or the like and an aqueous solution

of neutral detergent then immediately rinse the affected parts with plenty of water.

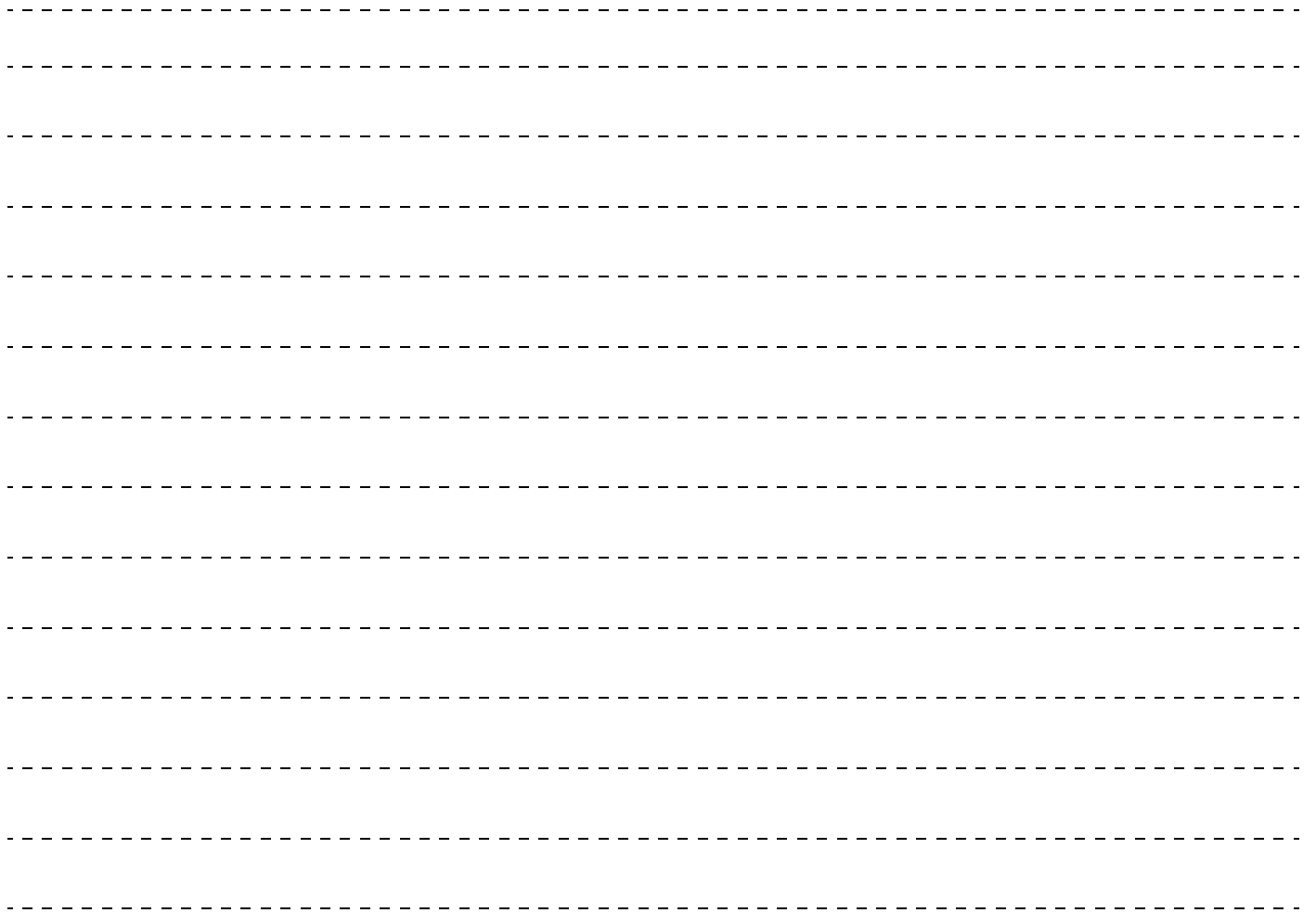

Customer assistance/Reporting Safety Defects

Consumer information (For vehicles sold in U.S.A.)	10-2
Reporting Safety Defects	10-2
Important facts to know in case of an accident	10-4

Consumer information (For vehicles sold in U.S.A.)

N01047101224

This information is provided in compliance with the requirements of the National Highway Traffic Safety Administration, Department of Transportation. It provides the purchasers and/or prospective purchasers with information on reporting safety defects.

Uniform tire quality grading

DOT quality grades - All passenger vehicle tires must conform to Federal Safety Requirements in addition to these grades. The specific grade rating in each grade category is shown on the side wall of the tires on your vehicle.

Treadwear

The treadwear grade is a comparative rating based on the wear rate of the tire when tested under controlled conditions on a specified government test course. For example, a tire graded 150 would wear one and one-half ($1\frac{1}{2}$) times as well on the government course as a tire graded 100. The relative performance of tires depends upon the actual conditions of

their use, however, and may depart significantly from the norm due to variations in driving habits, service practices and differences in road characteristics and climate.

Traction AA, A, B, C

The traction grades, from highest to lowest, are AA, A, B and C. Those grades represent the tire's ability to stop on wet pavement as measured under controlled conditions on specified government test surfaces of asphalt and concrete. A tire marked C may have poor traction performance.

WARNING

- The traction grade assigned to the tire is based on straight-ahead braking traction tests, and does not include acceleration, cornering, hydroplaning, or peak traction characteristics.

Temperature A, B, C

The temperature grades are A (the highest), B and C, representing the tire's resistance to the generation of heat and its ability to dissipate heat when tested under controlled conditions on a specified indoor laboratory test wheel. Sustained high temperature can cause the

material of the tire to degenerate and reduce tire life, and excessive temperature can lead to sudden tire failure. The grade C corresponds to a level of performance which all passenger car tires must meet under the Federal Motor Vehicle Safety Standard No. 109. Grades B and A represent higher levels of performance on the laboratory test wheel than the minimum required by law.

WARNING

- The temperature grade for the tire is established for a tire that is properly inflated and not overloaded. Excessive speed, underinflation, or excessive loading, either separately or in combination, can cause heat buildup and possible tire failure.

Reporting Safety Defects

N01047201658

If you believe that your vehicle has a defect which could cause a crash or could cause injury or death, you should immediately inform the National Highway Traffic Safety Administration (NHTSA) in addition to notifying Mitsubishi Motors Corporation.

If NHTSA receives similar complaints, it may open an investigation, and if it finds that a safety defect exists in a group of vehicles, it may order a recall and remedy campaign. However, NHTSA cannot become involved in individual problems between you, your dealer, or Mitsubishi Motors Corporation.

To contact NHTSA, you may call the Vehicle Safety Hotline toll-free at 1-888-327-4236 (TTY: 1-800-424-9153); go to <http://www.safercar.gov>; or write to:

NHTSA Headquarters
1200 New Jersey Avenue, SE
West Building
Washington, DC 20590

You can also obtain other information about motor vehicle safety from <http://www.safercar.gov>.

For vehicles sold in U.S.A.

To contact Mitsubishi Motors North America, Inc. call 1-888-648-7820 or write to:

Mitsubishi Motors North America, Inc.
Customer Relations Department
P.O. Box 689040
Franklin, TN 37068

For vehicles sold in Canada

If you live in Canada, and you believe that your vehicle has a safety defect, you should immediately notify Transport Canada. To contact Transport Canada's Defect Investigations and Recalls Division, you may call the toll-free number: 1-800-333-0510.

You may write to:

Transport Canada-ASFAD
330 Sparks Street
Ottawa, ON
K1A 0N5

You can also obtain additional information concerning motor vehicle safety from <http://www.tc.gc.ca/recalls> (English) or <http://www.tc.gc.ca/rappels> (French).

In addition to notifying Mitsubishi Motor Sales of Canada, Inc.

To contact Mitsubishi Motor Sales of Canada, Inc. call 1-888-576-4878 or write to:

Mitsubishi Motor Sales of Canada, Inc.
Customer Relations Department
P.O. Box 41009
4141 Dixie Road
Mississauga, ON L4W 5C9

Important facts to know in case of an accident

For vehicles sold in Puerto Rico

To contact Mitsubishi Motor Sales of Caribbean, Inc.
call 1-787-251-8715 or write to:

Mitsubishi Motor Sales of Caribbean, Inc.
Customer Service Department
P.O. Box 192216
SAN JUAN PR 00919-2216

10

For vehicles sold in Guam

To contact Triple J Enterprises Inc.
call (671)649-3673 or write to:

Triple J Enterprises, Inc.
P.O. Box 6066
TAMUNING
GUAM 96931

For vehicles sold in Saipan

To contact Triple J Motors

call (670)234-7133 or write to:

Triple J Motors
P.O. Box 500487
SAIPAN, MP96950-0487

For vehicles sold in American Samoa

To contact Pacific Marketing Inc.
call 684(699)9140 or write to:

Pacific Marketing, Inc.
P.O. Box 698
PAGO PAGO,
AMERICAN SAMOA AS, 96799

Important facts to know in case of an accident

N01047301284

We hope you will never be involved in an accident, but there is always that potential danger. So, please be sure to buckle up and drive safely.

In the event of an accident

- Remain calm.
- Check for injuries. Report all injuries to the police, and, if necessary, call for an ambulance.
- Record all the details of the accident. This will provide you with accurate records of the accident for discussions with your insurance company and other persons who may be acting on your behalf.

Key information to discuss with your insurance company

- Understand your repair estimate before approving repairs.
- Choosing the repair shop and the brands of parts that they use on your vehicle is your decision.
- Ask for genuine Mitsubishi Motors parts. Many times, to save money, your insurance company will recommend imitation parts that do not meet the original specifications of fit, finish, corrosion resistance or workmanship.

Mitsubishi Motors built-in protection

The strength and integrity built into your vehicle is the result of a specific design referred to as “Energy Management”. Individual body parts are designed to act as one unit in the event of an accident. Shock waves are absorbed by protective panels or are channeled around the passenger compartment. This important feature is possible because high tensile steel is used in the panels and structural parts, something that cannot be guaranteed by the manufacturers of imitation parts. All genuine body panels and support brackets are designed and constructed as important protection features in the event of an accident. By replacing body parts with imitations, your vehicle may no longer meet original equipment specifications.

Consumer rights (For vehicles sold in U.S.A.)

As a consumer requesting repair on your vehicle, you have consumer rights. Across the country, State Insurance Commissioners have begun considering rules on the use of non-OEM parts. This could mean that repair shops will have to disclose to the consumer, when

they intend to use non-OEM parts. Since regulations are not consistent on this point, remember you have a choice. So, if you want genuine Mitsubishi Motors parts, you may have to specifically request them. Make certain your insurance company understands imitations are not to be used in the repair of your vehicle. You deserve the best genuine Mitsubishi Motors parts.

Genuine Mitsubishi Motors parts

Genuine Mitsubishi Motors parts are built with the high quality and durability standards you expect. Genuine Mitsubishi Motors replacement parts are your guarantee that your vehicle will have all the technological advantages and maintain the style and protection of a brand new Mitsubishi Motors vehicle. Remember to ask for genuine Mitsubishi Motors parts.

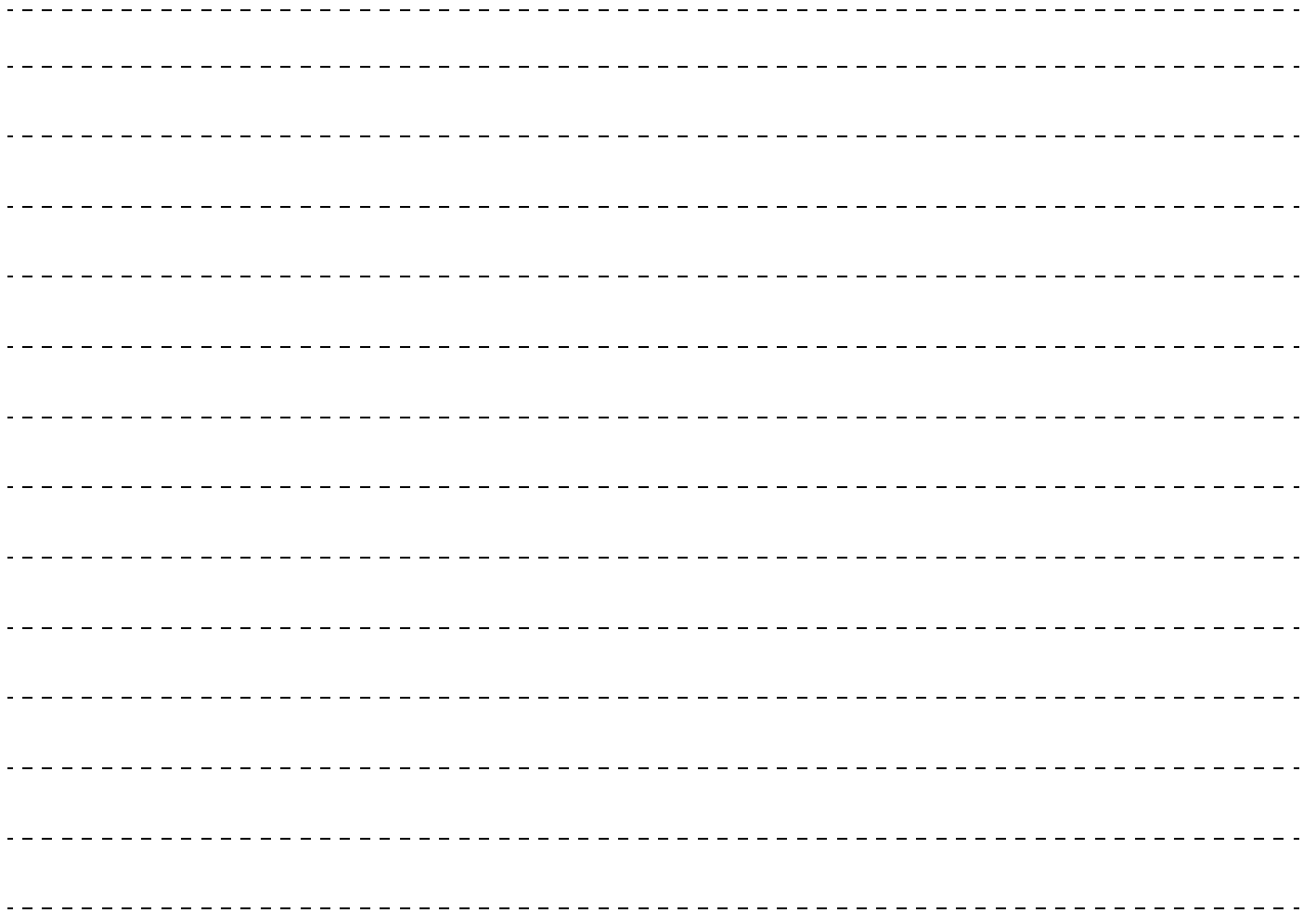

Specifications

Vehicle labeling	11-2
Vehicle dimensions	11-4
Vehicle weights	11-5
Engine specifications	11-6
Battery	11-6
Tires and wheels	11-7
Capacity	11-7

Vehicle labeling

N01147401970

Keep a record of the chassis number and vehicle identification number. Such information will assist police if your vehicle is stolen.

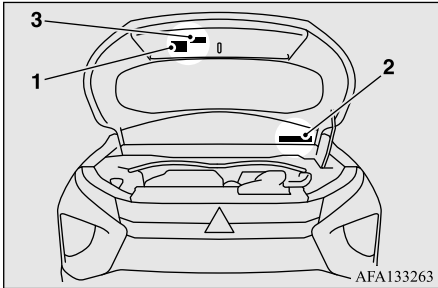

11

1 - Vehicle emission control information label

The vehicle emission control information label is affixed on the underside of the engine hood.

2 - Vehicle identification number plate

The vehicle identification number is stamped on the plate riveted to the left front corner of the dashboard. It is visible from outside of the vehicle through the windshield.

3 - Air conditioning label

The air conditioning label is affixed on the inside panel of the engine hood.

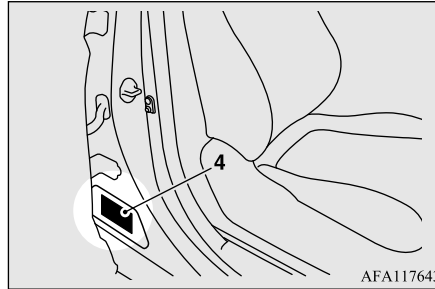

4 - Vehicle information code plate

The vehicle information code plate is located on the front passenger door sill.

Chassis number

The chassis number is stamped on the bulkhead as shown in the illustration.

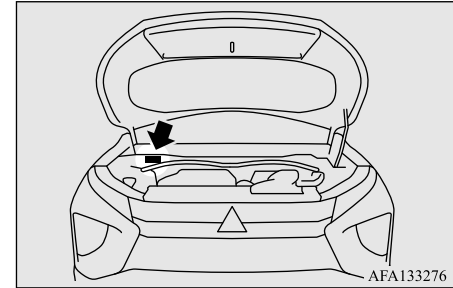

Engine model/serial number

The engine model and serial number are stamped on the cylinder block as shown in the illustration.

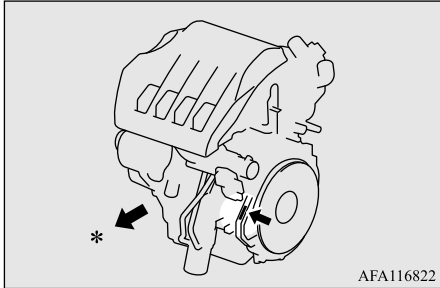

*: Front of the vehicle

Tire and loading information placard

N01148101642

The tire and loading information placard is located on the driver's door sill.

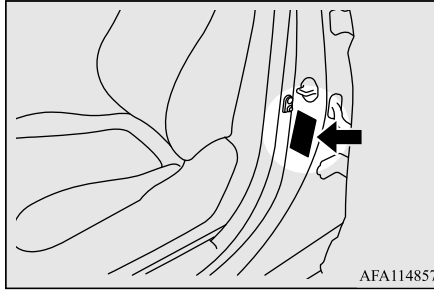

Type 1

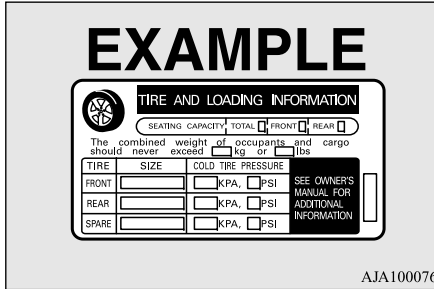

Type 2

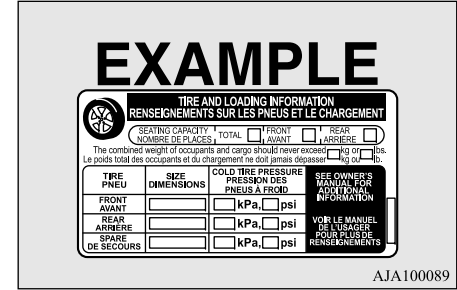

Certification label

N01148201252

The certification label is located on the driver's door sill.

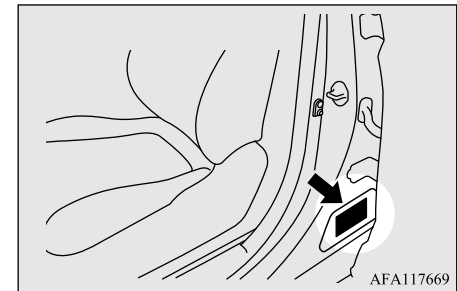

Vehicle dimensions

Vehicle dimensions

N01147501724

Overall length		179.0 in (4,545 mm)
Overall width		71.1 in (1,805 mm)
Overall height	2WD	66.3 in (1,685 mm)
	4WD	66.5 in (1,690 mm)
Wheel base		105.1 in (2,670 mm)

Vehicle weights

N01147602070

Gross vehicle weight rating (GVWR)		4,630 lb (2,100 kg)	
Gross axle weight rating (GAWR)	Front	2,646 lb (1,200 kg)	
	Rear	2,557 lb (1,160 kg)	
Maximum trailer weight	1 or 2 persons seated	With brake	2,000 lb (907 kg)
		Without brake	1,250 lb (567 kg)
	3–5 persons seated	With brake	1,500 lb (680 kg)
		Without brake	1,250 lb (567 kg)
Vehicle capacity weight		827 lb (375 kg)	
Maximum roof load*		110 lb (50 kg)	
Seating capacity		5 persons	

*: Vehicles equipped with roof rails

NOTE

- Vehicle usage condition should never exceed above “Maximum” values.
- Roof load is important because it affects the vehicle capacity weight. Refer to “Loading cargo on the roof” on page 6-12.

GVWR: maximum total weight (load) limit specified for the vehicle

GAWR: maximum weight (load) limit specified for the front or rear axle

Seating capacity: the maximum number of occupants

Engine specifications

N01147701667

Engine model	4B40	
Engine displacement	91.5 CID (1,499 cm ³)	
No. of cylinders and cylinder arrangement	Inline-4	
Bore	2.95 in (75.0 mm)	
Stroke	3.34 in (84.8 mm)	
Compression ratio	10.0	
Thermostat valve opening temperature	179.6 °F (82.0 °C)	
Spark plugs	NGK	SILKR7H8
Spark plug gap	.028 to .031 in (0.7 to 0.8 mm)	
Firing order	1-3-4-2	

11

Battery

N01147801365

75D23L

Battery is a 12 volt type.

Tires and wheels

N01147901874

Tire		P215/70R16 99H	P225/55R18 97H
Wheel	Size	16 x 6 1/2J	18 x 7J
	PCD	4.5 in (114.3 mm)	
	Offset (Inset)	1.5 in (38 mm)	

PCD: Pitch Circle Diameter (installation holes)

NOTE

- Contact an authorized Mitsubishi Motors dealer for details on the combination used on your vehicle.
- These tires satisfy vehicle loading conditions described in this owner's manual.

Capacity

N01148002505

Item		Capacity	Lubricants
Fuel (approximate)	Front-wheel drive vehicles	16.6 gal (63 L)	Refer to "Fuel selection" on page 3-2.
	All-wheel drive vehicles	15.8 gal (60 L)	
Engine oil	Oil pan	4.2 qt (4.0 L)	Engine oils displaying the ILSAC certification mark ("starburst" symbol) on the container. If these oils are not available, API classification SP can be used.
	Oil filter	.21 qt (0.2 L)	
	Oil cooler	.11 qt (0.1 L)	
Continuously variable transmission (CVT)		8.2 qt (7.8 L)	Refer to "Continuously variable transmission (CVT) fluid" on page 9-8.

Capacity

Item		Capacity	Lubricants
Transfer oil		.50 qt (0.47 L)	Mitsubishi Motors Genuine Super Hypoid Gear Oil API GL-5 SAE 80
Differential	Rear axle	.42 qt (0.4 L)	Mitsubishi Motors Genuine Super Hypoid Gear Oil API GL-5 SAE 80
Brake		As required	Conforming to Brake fluid DOT3 or DOT4
Hood lock release mechanism and safety catch		As required	Multipurpose type grease NLGI Grade 2
Engine coolant {Includes .69 qt (0.65 L) in reserve tank}		6.3 qt (6.0 L)	Mitsubishi Motors Genuine Super Long Life Coolant Premium or equivalent*
Washer fluid		3.7 qt (3.5 L)	—
Refrigerant (air conditioning)		Refer to the “Vehicle labeling” on page 11-2.	HFO-1234yf

*: Similar high quality ethylene glycol based non-silicate, non-amine, non-nitrate and non-borate coolant with long life hybrid organic acid technology

Numerics	B	C
12 V power outlets 5-215	Back-up light	California Perchlorate Materials
4-wheel drive operation 5-72	Bulb location and capacity 9-29	Requirements 3-13
	Replacement 9-33	Capacity 11-7
A	Ball joint, steering linkage seals, drive shaft	Card holder 5-226
Accessory (installation) 3-12	boots 9-23	Cargo area cover 5-228
Active stability control (ASC) 5-85	Battery 9-10	Cargo loads 6-11
Active Yaw Control (AYC) 5-81	Charging system warning light 5-188	Cargo room light 5-224
Adaptive Cruise Control System (ACC) 5-92	Checking battery electrolyte level 9-10	Bulb location and capacity 9-30
Air cleaner filter 9-8	Disconnection and connection 9-11	Catalytic converter 9-2
Air conditioning	During cold weather 9-11	Cautions on the handling of all-wheel drive
Automatic air conditioning 7-6	Specification 11-6	vehicles 5-75
Dual-zone automatic climate control air	Blind Spot Warning (BSW) 5-114	Certification label 11-3
conditioning 7-15	Brake	Charging system warning light 5-188
Important air conditioning operation tips..	Fluid 9-10, 11-7	Child restraint systems 4-21
7-2	Brake assist 5-80	Child safety locks for rear door 5-38
Air purifier 7-23	Braking	Cleaning
Airbag 4-31	Anti-lock braking system 5-82	Inside of your vehicle 9-35
All-wheel drive operation 5-72	Braking 6-5	Outside of your vehicle 9-36
Aluminum wheels 9-38	Hose 9-22	Coat hook 5-229
Anti-lock braking system 5-82	Pad wear alarm 5-77	Consumer information 10-2
Arm rest 4-7	Parking brake 5-50	Continuously variable transmission (CVT)...
Assist grip 5-229	Pedal 5-76	5-63
Automatic air conditioning 7-6	Pedal free play 9-20	Fluid 9-8, 11-7
Automatic High Beam (AHB) 5-198	Power brakes 5-76	Selector lever operation 5-63
	Service brake 5-76	Selector lever positions 5-67
	Warning lights and buzzer 5-186	Sports mode 5-67
	Bulb location and capacity 9-28	

Alphabetical index

Convenient hook 5-230
Coolant (engine)..... 9-7, 11-7
Cruise control..... 5-87

D

Daytime running lights
Bulb location and capacity..... 9-29
Replacement 9-32
Defogger (rear window) 5-211
Defrosting or defogging (windshield, door windows)..... 7-9, 7-13, 7-18, 7-22
Dimensions 11-4
Dimmer (high/low beam change) 5-197
Disc brake pads 9-22
Dome light (front)/Reading lights..... 5-222
Bulb location and capacity..... 9-30
Dome light (rear) 5-223
Bulb location and capacity..... 9-30
Doors
Lock..... 5-34
Power door locks 5-37
Drink holders 5-227
Driving during cold weather 6-5
Driving precaution 6-2
Driving, alcohol and drugs..... 6-2
Dual-zone automatic climate control air conditioning 7-15

E

ECO mode switch 5-204
Electric parking brake..... 5-51
Electric power steering system (EPS).... 5-84
Electric rear window defogger switch.. 5-211
Electronic immobilizer (Anti-theft starting system) 5-4, 5-27
Emission-control system maintenance ... 9-21
Engine
Compartment 9-5
Coolant 9-7, 11-7
Hood..... 9-3
Malfunction indicator light..... 5-187
Oil and oil filter 9-5, 11-7
Overheating 8-4
Serial number 11-2
Specification..... 11-6
Engine hood 9-3
Engine switch 5-18
Event data recorder (EDR) 3-14
Exhaust system 9-23

F

Floor console box..... 5-227
Floor mat..... 6-3
Fluid
Brake fluid 9-10, 11-7

Continuously variable transmission (CVT) fluid 9-8, 11-7
Engine coolant 9-7, 11-7
Engine oil 9-5, 11-7
Rear axle oil..... 9-9, 11-7
Transfer oil 9-9, 11-7
Washer fluid 9-9, 11-7

Fluid capacities and lubricants 11-7
Forward Collision Mitigation system (FCM) . 5-105

Free-hand advanced security transmitter (F.A.S.T.-key)..... 5-13

Front fog lights

Bulb location and capacity..... 9-29
Indicators..... 5-185
Replacement 9-32
Switch 5-204

Front seat adjustment 4-3

Front side-marker lights

Bulb location and capacity..... 9-29
Replacement 9-32

Front turn signal light

Bulb location and capacity..... 9-29
Replacement 9-32

Fuel

Filling the fuel tank..... 3-3
Fuel economy..... 6-2
Fuel hoses 9-22
Fuel selection 3-2
Tank capacity 11-7

Fuel Pump Shut-off System 8-13
 Fuses 9-24
 Fusible links 9-24

G

General maintenance 9-22
 General vehicle data 11-4
 Genuine parts 3-13
 Glove compartment 5-226

H

Hazard warning flasher switch 5-204
 Hazard warning lights 5-185
 Head restraints 4-8
 Head Up Display (HUD) 5-189
 Headlights
 Bulb location and capacity 9-29
 Dimmer 5-197
 Headlight flasher 5-198
 Replacement 9-30
 Switch 5-194
 Heated steering wheel switch 5-212
 High beam indicator 5-185
 High-mounted stop light
 Bulb location and capacity 9-29
 Hill start assist 5-79
 HomeLink® Wireless Control System 5-216

Hood lock release mechanism and safety
 catch 9-23
 Horn switch 5-213

I

If the vehicle breaks down 8-2
 Ignition switch 5-60
 Important facts to know in case of an accident
 10-4
 Indicators 5-164, 5-185
 Information screen display 5-165
 Inside rearview mirror 5-55
 Inspection and maintenance following rough
 road operation 5-75
 Instrument cluster 5-142
 Interior lights 5-222

J

Jack 8-5
 Storage 8-5
 Jump-starting the engine 8-2

K

Keyless entry system 5-6, 5-28
 Keys 5-3

L

Labeling 11-2
 Lane Departure Warning (LDW) 5-123
 License plate light
 Bulb location and capacity 9-29
 Replacement 9-34
 Liftgate 5-38
 Loading information 6-6
 Lubricants 11-7
 Luggage floor board 5-230
 Luggage hooks 5-230

M

Modification of your vehicle 3-12
 Multi Around Monitor 5-133
 Multi-information display 5-144

O

Octane number 3-2
 Oil
 Engine oil 11-7
 Rear axle oil 11-7
 Transfer oil 11-7
 Operation under adverse driving conditions..
 8-12
 Outside rearview mirrors 5-57

Alphabetical index

Overheating 8-4

P

Parking 6-6

 Parking brake 5-50

Parking brake lever stroke 9-20

Parking lights

 Bulb location and capacity..... 9-29

 Replacement 9-32

Polishing..... 9-38

Power brakes..... 5-76

Power outlet..... 5-215

Power panoramic sunroof..... 5-46

Power windows 5-43

Puncture (Tire changing)..... 8-6

R

Radiator cap..... 9-8

Radio

 General information about your radio 7-23

Reading lights

 Bulb location and capacity..... 9-30

Rear axle oil..... 9-9, 11-7

Rear combination lights

 Bulb location and capacity..... 9-29

 Replacement 9-32

Rear Cross Traffic Alert..... 5-120

Rear seat adjustment..... 4-6

Rear side-marker lights

 Bulb location and capacity 9-29

Rear turn signal light

 Bulb location and capacity 9-29

 Replacement..... 9-32

Rear-view camera 5-131

Rearview mirror

 Inside rearview mirror 5-55

 Outside rearview mirrors 5-57

Replacement of light bulbs..... 9-28

Replacing tires and wheels 9-17

Reporting Safety Defects 10-2

S

Safe driving techniques..... 6-4

S-AWC (Super-All Wheel Control) 5-70

Seat belt 4-12

 Adjustable seat belt shoulder anchor . 4-18

 Child restraint systems..... 4-21

 Front passenger seat belt warning light.....

 4-18

 Maintenance and inspection 4-31

 Seat belt extender..... 4-19

 Seat belt force limiter 4-21

 Seat belt pre-tensioners..... 4-20

 Seat belt use during pregnancy 4-19

Seats 4-2

 Arm rest..... 4-7

 Front seats 4-3

 Head restraints 4-8

 Making a cargo area..... 4-11

 Rear seats 4-6

 Seats and restraint systems 4-3

Service brake..... 5-76

Service precautions 9-2

Side turn signal light

 Bulb location and capacity..... 9-29

Snow tires 9-20

Spark plugs 9-21

Starting the engine 5-24, 5-61

Steering

 Steering wheel height and reach adjustment
 5-54

Stop lights

 Bulb location and capacity..... 9-29

Storage spaces 5-225

Sun visors 5-214

Super-all wheel control (S-AWC)

 S-AWC drive mode display 5-71

 S-AWC drive mode-selector 5-71

 S-AWC operation display..... 5-72

Supplemental Restraint System 4-31

 How the Supplemental Restraint System
 works 4-34

 Maintenance service 4-46

<hr/>			
T			
<hr/>			
Tail light		Indicators	5-185
Bulb location and capacity	9-29	Lever	5-203
Tank capacity	11-7	<hr/>	
Telematics Control Unit (TCU).....	3-5	U	
Theft-alarm system	5-40	USB input terminal.....	5-213
Ticket holder	5-215	How to connect a USB memory device ...	5-213
Tire	9-12	How to connect an iPod	5-214
Inflation pressure	9-16	<hr/>	
Maintenance.....	9-18	V	
Quality grading.....	10-2	Vanity mirror	5-215
Replacing tires and wheels.....	9-17	Vanity mirror lights	
Rotation	9-18	Bulb location and capacity	9-30
Size (tire and wheel)	11-7	Vehicle care precautions	9-34
Snow tires	9-20	Vehicle dimensions	11-4
Tire and loading information placard	11-3	Vehicle labeling	11-2
Tire chains	9-20	Vehicle preparation before driving	6-4
To change a tire	8-6	Vehicle weights.....	11-5
Tread wear indicator	9-18	Vents	7-2
Tire pressure monitoring system (TPMS).....	5-126	<hr/>	
Tools	8-5	W	
Storage	8-5	Warning lights	5-186
Towing	8-11	Washer	
Trailer towing.....	6-13	Fluid	9-9, 11-7
Transfer oil	9-9, 11-7	Rear window washer	5-209
Turbocharger operation	5-63	Switch.....	5-209
Turn signal light		Washing	9-36
		Waxing.....	9-37
		Weights	11-5
		Wheel	
		Specification	11-7
		Wiper	
		Rear window wiper	5-209
		Switch	5-205
		Wiper blades	9-21

NOTE

Name of Owner	Date of Purchase
Address of Owner	Model of Vehicle
Name and Address of Dealer	Vehicle Identification Number

Maintenance record

Service Performed	Date	Kilometers Miles	Inspection and Maintenance Item

