

A Word to Mazda Owners

Thank you for choosing a Mazda. We at Mazda design and build vehicles with complete customer satisfaction in mind.

To help ensure enjoyable and trouble-free operation of your Mazda, read this manual carefully and follow its recommendations.

An Authorized Mazda Dealer knows your vehicle best. So when maintenance or service is necessary, that's the place to go.

Our nationwide network of Mazda professionals is dedicated to providing you with the best possible service.

We assure you that all of us at Mazda have an ongoing interest in your motoring pleasure and in your full satisfaction with your Mazda product.

Mazda Motor Corporation
HIROSHIMA, JAPAN

Important Notes About This Manual

Keep this manual in the glove compartment as a handy reference for the safe and enjoyable use of your Mazda. Should you resell the vehicle, leave this manual with it for the next owner.

All specifications and descriptions are accurate at the time of printing. Because improvement is a constant goal at Mazda, we reserve the right to make changes in specifications at any time without notice and without obligation.

Air Conditioner and the Environment

Your Mazda's genuine air conditioner is filled with a refrigerant that has been found not to damage the earth's ozone layer. If the air conditioner does not operate properly, consult an Authorized Mazda Dealer.

Perchlorate

Certain components of this vehicle such as [air bag modules, seat belt pretensioners, lithium batteries, ...] may contain Perchlorate Material-- Special handling may apply for service or vehicle end of life disposal. See

www.dtsc.ca.gov/hazardouswaste/perchlorate.

Please be aware that this manual applies to all models, equipment and options. As a result, you may find some explanations for equipment not installed on your vehicle.

©2020 Mazda Motor Corporation
October 2020 (Print2)

How to Use This Manual

We want to help you get the most driving pleasure from your vehicle. Your owner's manual, when read from beginning to end, can do that in many ways.

Illustrations complement the words of the manual to best explain how to enjoy your Mazda. By reading your manual, you can find out about the features, important safety information, and driving under various road conditions.

You'll find several **WARNINGS**, **CAUTIONS**, and **NOTES** in the manual.



A **WARNING** indicates a situation in which serious injury or death could result if the warning is ignored.



A **CAUTION** indicates a situation in which bodily injury or damage to your vehicle, or both, could result if the caution is ignored.

NOTE

A **NOTE** provides information and sometimes suggests how to make better use of your vehicle.

The symbol below in this manual means "Do not do this" or "Do not let this happen".

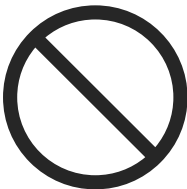

The following symbol indicates the first operation, such as a push or a turn.

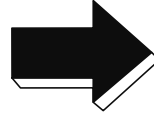

The following symbol indicates the second operation, such as a push or a turn.

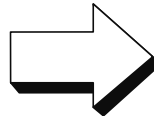

The following symbol indicates the location of parts.



The following symbol indicates a change of status.

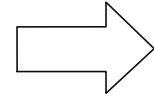

The following symbol, located on some parts of the vehicle, indicates that this manual contains information related to the part. Please refer to the manual for a detailed explanation.



Index: A good place to start is the Index, an alphabetical listing of all information in your manual.

Table of Contents

Pictorial Index Interior, exterior views and part identification of your Mazda.	1
Essential Safety Equipment Important information about safety equipment, including seats, seat belt system, child-restraint systems and SRS air bags.	2
Before Driving Use of various features, including keys, doors, mirrors and windows.	3
When Driving Information concerning safe driving and stopping.	4
Interior Features Use of various features for ride comfort, including air-conditioning system and audio system.	5
Maintenance and Care How to keep your Mazda in top condition.	6
If Trouble Arises Helpful information on what to do if a problem arises with the vehicle.	7
Customer Information and Reporting Safety Defects Important consumer information including warranties and add-on equipment.	8
Specifications Technical information about your Mazda.	9
Index	10

1

Pictorial Index

Interior, exterior views and part identification of your Mazda.

Interior Overview..... **1-2**
 Interior Equipment (View
 A)..... 1-2
 Interior Equipment (View
 B)..... 1-3
 Interior Equipment (View
 C)..... 1-4
 Interior Equipment (View
 D)..... 1-5

Interior Equipment (View
 E)..... 1-6
Exterior Overview..... **1-8**
 4-Door..... 1-8
 5-Door..... 1-9

Interior Equipment (View A)

▼ Interior Equipment (View A)

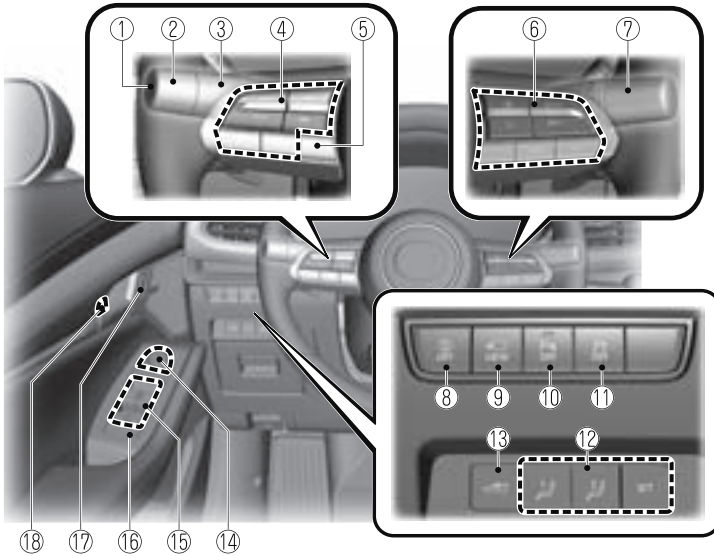

- ① High beam control switch..... page 4-92
- ② Lighting control..... page 4-46
- ③ Turn and lane-change signals..... page 4-52
- ④ Audio remote control switches..... page 5-23
- ⑤ INFO switch..... page 4-14
- ⑥ Cruise control switches..... page 4-124, 4-133, 4-146, 4-215
- ⑦ Wiper and washer lever..... page 4-53
- ⑧ i-ACTIVSENSE OFF switch..... page 4-89
- ⑨ 360° view monitor switch..... page 4-178
- ⑩ Parking sensor OFF switch..... page 4-242
- ⑪ DSC OFF switch..... page 4-80
- ⑫ Position memory buttons..... page 2-11
- ⑬ Trunk release button..... page 3-20
- ⑭ Outside mirror switches..... page 3-30
- ⑮ Power window switches..... page 3-34
- ⑯ Power window lock switch..... page 3-34
- ⑰ Door-lock switch..... page 3-16
- ⑱ Door-lock knob..... page 3-18

Interior Equipment (View B)

▼ Interior Equipment (View B)

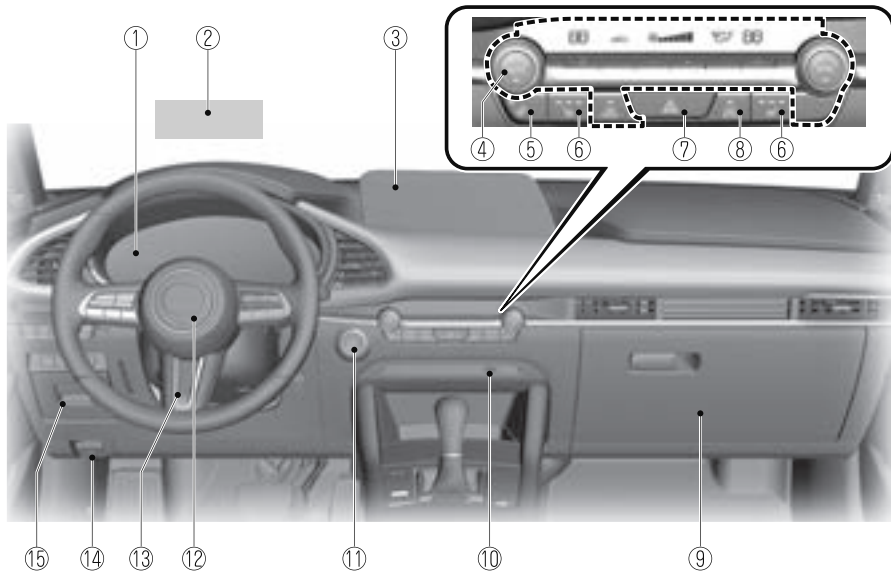

① Instrument cluster.....	page 4-12
② Active driving display.....	page 4-30
③ Mazda Connect.....	page 5-15
④ Climate control system.....	page 5-2
⑤ Heated steering wheel switch.....	page 2-21
⑥ Seat warmer switches.....	page 2-20
⑦ Hazard warning flasher switch.....	page 4-60
⑧ Rear window defogger switch.....	page 4-58
⑨ Glove compartment.....	page 5-46
⑩ External input terminal.....	page 5-15
⑪ Push button start.....	page 4-4
⑫ Horn.....	page 4-59
⑬ Lock release lever.....	page 2-5
⑭ Hood release handle.....	page 6-13
⑮ Storage pocket.....	page 5-46

Interior Overview

Interior Equipment (View C)

▼ Interior Equipment (View C)

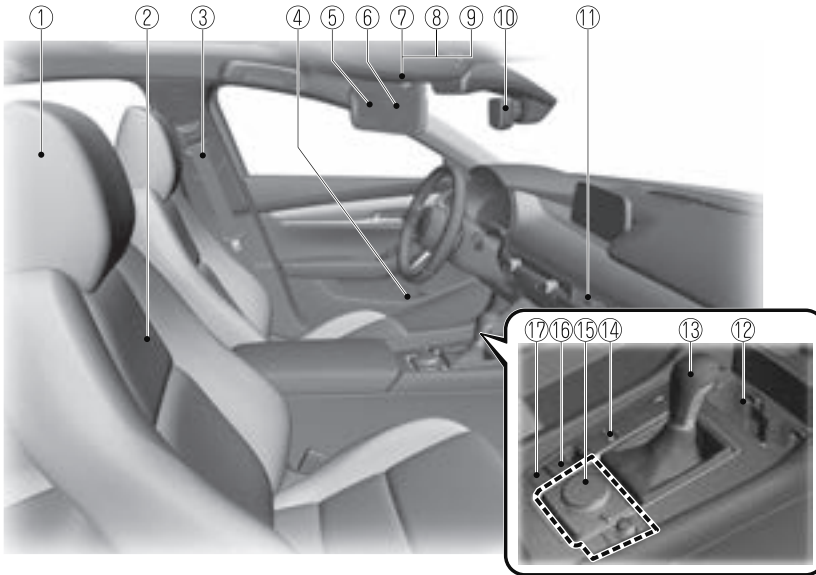

① Head restraint.....	page 2-17
② Front seat.....	page 2-5
③ Seat belt.....	page 2-23
④ Bottle holder.....	page 5-44
⑤ Vanity mirror.....	page 5-38
⑥ Sunvisor.....	page 5-38
⑦ Overhead light (front)/Map lights.....	page 5-39
⑧ Overhead console.....	page 5-46
⑨ Moonroof switch.....	page 3-38
⑩ Rearview mirror.....	page 3-32
⑪ Vent.....	page 5-3
⑫ Cup holder.....	page 5-42
⑬ Shift lever/Selector lever.....	page 4-33, 4-35
⑭ Drive selection switch.....	page 4-81
⑮ Commander switch.....	page 5-19
⑯ Electric Parking Brake (EPB) switch.....	page 4-66
⑰ AUTOHOLD switch.....	page 4-73

Interior Equipment (View D)

▼ Interior Equipment (View D)

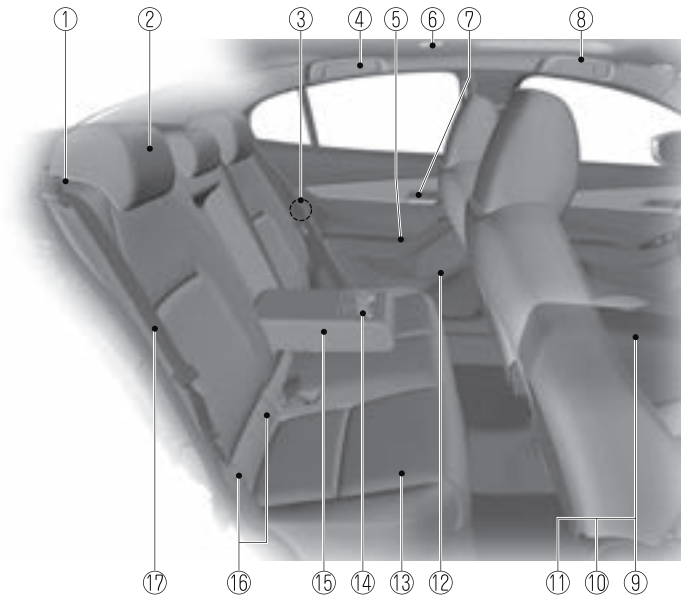

① Push knob (5-door).....	page 2-14
② Head restraint.....	page 2-17
③ Child safety lock.....	page 3-19
④ Rear coat hook.....	page 5-45
⑤ Power window switch.....	page 3-34
⑥ Overhead light (rear).....	page 5-39
⑦ Door-lock knob.....	page 3-18
⑧ Assist grip.....	page 5-44
⑨ Center console.....	page 5-46
⑩ Accessory socket.....	page 5-41
⑪ External input terminal.....	page 5-15
⑫ Bottle holder.....	page 5-44
⑬ Rear seat.....	page 2-14
⑭ Cup holder.....	page 5-42
⑮ Armrest.....	page 2-16
⑯ ISOFIX lower anchors (Mexico)/LATCH lower anchors (Except Mexico)	page 2-50
⑰ Seat belt.....	page 2-23

Interior Equipment (View E)

▼ 4-Door

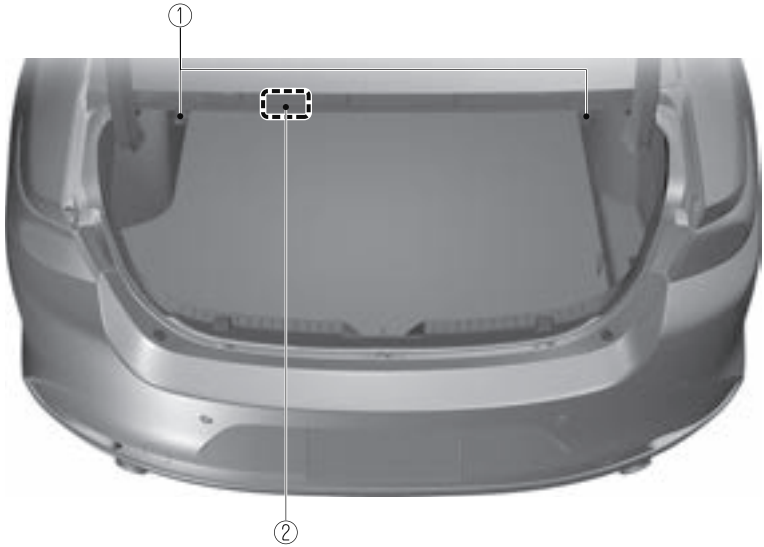

① Lever.....	page 2-14
② Trunk light.....	page 5-39

▼ 5-Door

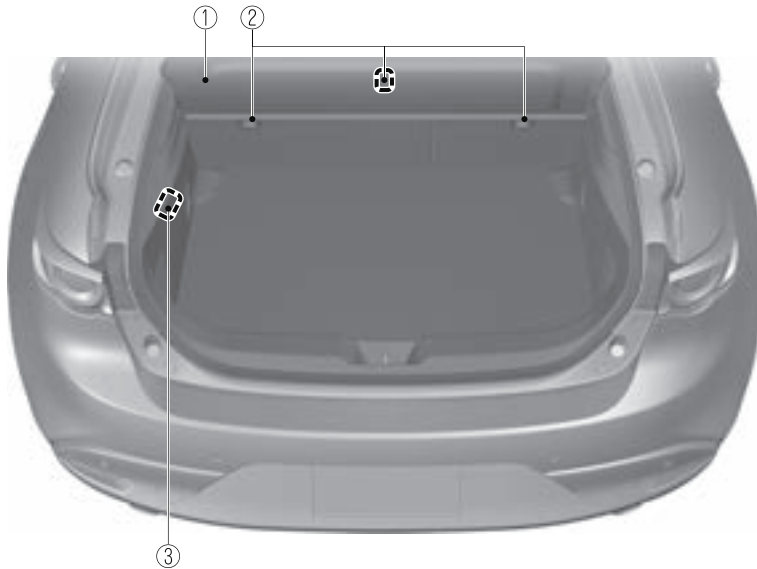

- ① Luggage compartment cover..... page 3-22
- ② Anchor brackets..... page 2-42
- ③ Luggage compartment light..... page 5-39

Exterior Overview

4-Door

▼ 4-Door

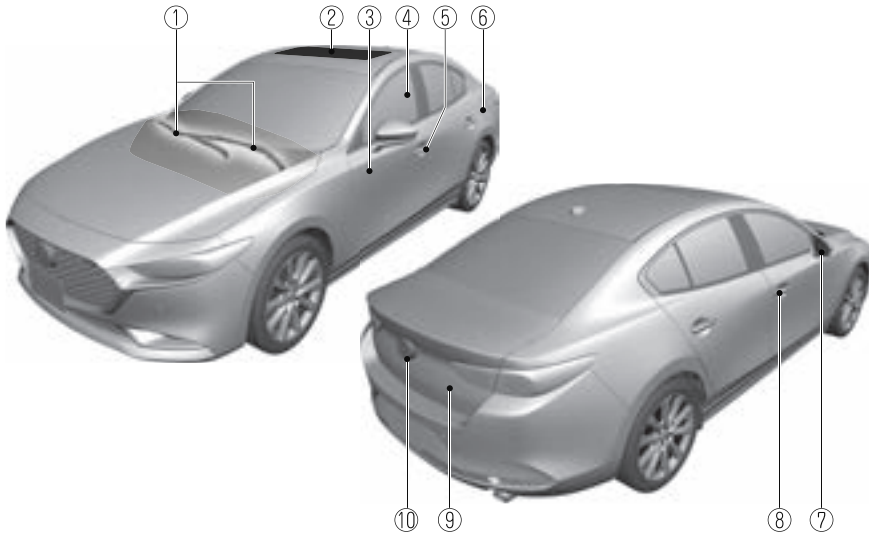

① Windshield wiper blades.....	page 6-23
② Moonroof.....	page 3-37
③ Door.....	page 3-11
④ Window.....	page 3-34
⑤ Touch sensor.....	page 3-13
⑥ Fuel-filler lid.....	page 3-27
⑦ Outside mirror.....	page 3-30
⑧ Touch sensor.....	page 3-13
⑨ Trunk lid.....	page 3-19
⑩ Electric trunk lid opener.....	page 3-20

5-Door

▼ 5-Door

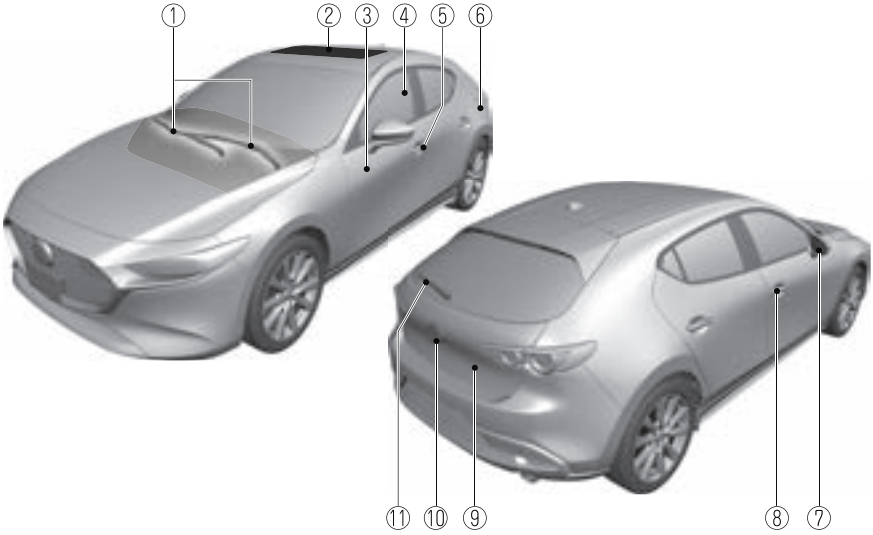

- ① Windshield wiper blades..... page 6-23
- ② Moonroof..... page 3-37
- ③ Door..... page 3-11
- ④ Window..... page 3-34
- ⑤ Touch sensor..... page 3-13
- ⑥ Fuel-filler lid..... page 3-27
- ⑦ Outside mirror..... page 3-30
- ⑧ Touch sensor..... page 3-13
- ⑨ Liftgate..... page 3-19
- ⑩ Electric liftgate opener..... page 3-20
- ⑪ Rear window wiper blade..... page 6-27

MEMO

2

Essential Safety Equipment

Important information about safety equipment, including seats, seat belt system, child-restraint systems and SRS air bags.

Seats.....	2-2	Child-Restraint System	
Seat Precautions.....	2-2	Installation.....	2-37
Front Seat.....	2-5	Child-Restraint System Suitability	
Rear Seat.....	2-14	for Various Seat Positions	
Head Restraints.....	2-17	Table.....	2-39
Seat Warmer/Heated Steering		Installing Child-Restraint	
Wheel.....	2-20	Systems.....	2-42
Seat Warmer*.....	2-20	SRS Air Bags.....	2-55
Heated Steering Wheel*.....	2-21	Supplemental Restraint System	
Seat Belt Systems.....	2-23	(SRS) Precautions.....	2-55
Seat Belt Precautions.....	2-23	Supplemental Restraint System	
Seat Belt.....	2-26	Components.....	2-61
Seat Belt Warning Systems....	2-27	How the SRS Air Bags	
Front Seat Belt Pretensioner and		Work.....	2-63
Load Limiting Systems.....	2-28	SRS Air Bag Deployment	
Seat Belt Extender.....	2-30	Criteria.....	2-67
Child Restraint.....	2-32	Limitations to SRS Air Bag.....	2-69
Child-Restraint Precautions.....		Driver and Front Passenger	
.....	2-32	Occupant Classification	
		System*.....	2-70
		Constant Monitoring.....	2-75

*Some models.

Seats

Seat Precautions

▼ Seat Precautions

WARNING

Make sure the adjustable components of a seat are locked in place:

Adjustable seats and seatbacks that are not securely locked are dangerous. In a sudden stop or collision, the seat or seatback could move, causing injury. Make sure the adjustable components of the seat are locked in place by attempting to slide the seat forward and backward and rocking the seatback.

Never allow children to adjust a seat:

Allowing children to adjust a seat is dangerous as it could result in serious injury if a child's hands or feet become caught in the seat.

Do not drive with the seatback unlocked:

All of the seatbacks play an important role in your protection in a vehicle. Leaving the seatback unlocked is dangerous as it can allow passengers to be ejected or thrown around and baggage to strike occupants in a sudden stop or collision, resulting in severe injury. After adjusting the seatback at any time, even when there are no other passengers, rock the seatback to make sure it is locked in place.

Adjust a seat only when the vehicle is stopped:

If the seat is adjusted while the vehicle is being driven, the seating posture may become unstable and the seat could move unexpectedly resulting in injury.

Do not modify or replace the front seats:

Modifying or replacing the front seats such as replacing the upholstery or loosening any bolts is dangerous. The front seats contain air bag components essential to the supplemental restraint system. Such modifications could damage the supplemental restraint system and result in serious injury.

Consult an Authorized Mazda Dealer if there is any need to remove or reinstall the front seats.

Do not drive with damaged front seats:

Driving with damaged front seats, such as seat cushions torn or damaged down to the urethane, is dangerous. A collision, even one not strong enough to deploy the air bags, could damage the front seats which contain essential air bag components. If there was a subsequent collision, an air bag may not deploy which could lead to injuries. Always have an Authorized Mazda Dealer inspect the front seats, front seat belt pretensioners and air bags after a collision.

Do not drive with either front seats reclined:

Sitting in a reclined position while the vehicle is moving is dangerous because you do not get the full protection from seat belts. During sudden braking or a collision, you can slide under the lap belt and suffer serious internal injuries. For maximum protection, sit well back and upright.

Do not place an object such as a cushion between the seatback and your back:

Putting an object such as a cushion between the seatback and your back is dangerous because you will be unable to maintain a safe driving posture and the seat belt cannot function at its full capacity in a collision, which could result in a serious accident, injury or death.

Do not place objects under the seat:

The object could get stuck and cause the seat to not be fixed securely, and result in an accident.

Do not stack cargo higher than the seatbacks:

Stacking luggage or other cargo higher than the seatbacks is dangerous. During sudden braking or a collision, objects can fly around and become projectiles that may hit and injure passengers.

Make sure luggage and cargo is secured before driving:

Not securing cargo while driving is dangerous as it could move or be crushed during sudden braking or a collision and cause injury. Additionally, if the air bags deploy, the cargo may scatter which could result in serious injury or death.

Never allow a passenger to sit or stand on the folded seatback while the vehicle is moving:

Driving with a passenger on the folded seatback is dangerous. Allowing a child to sit up on the folded seatback while the vehicle is moving is particularly dangerous. In a sudden stop or even a minor collision, a child not in a proper seat or child-restraint system and seat belt could be thrown forward, back or even out of the vehicle resulting in serious injuries or death. The child in the baggage area could be thrown into other occupants and cause serious injury.

Never give the car keys to children and do not allow them to play in the vehicle (4-Door):

Playing with the folding rear seats is dangerous. Once the seatbacks are back up, a child in the trunk would not be able to get out the way they had entered. If you have small children, keep the seatbacks locked.

Always leave your car locked and keep the car keys safely away from children (4-Door):

Leaving your car unlocked or the keys in reach of children is dangerous. Children who find their way into the trunk through an unlocked rear seatback or an open trunk can become accidentally locked in the trunk. This could result in death or brain damage from heat prostration, particularly in the summer. Always lock the doors and the trunk, and as an added measure, keep the rear seatbacks locked, whether you have children in your home or not.

Seats

CAUTION

- When operating a seat, be careful not to put your hands or fingers near the moving parts of the seat or on the side trim to prevent injury.
- When moving the seats, make sure there is no cargo in the surrounding area. If the cargo gets caught it could damage the cargo.
- **(Manual Seat)**
When moving the seats forward and rearward or returning a rear-reclined seatback to its upright position, make sure you hold onto the seatback with your hand while operating. If the seatback is not held, the seat will move suddenly and could cause injury.
- When inserting your hand under the seat to clean the cabin or pick up something you dropped under the seat, be careful not to hurt yourself. If you contact the moving parts and surrounding parts around the seat rail, seat frame, and the bottom of the seat, it could result in injury.

NOTE

- When returning a rear seat to its original position, place the seat belt in its normal position. Verify that the seat belt pulls out and retracts.

· (Power Seat)

The seat-base power adjustment is operated by motors. Avoid extended operation because excessive use can damage the motors.

- To prevent the battery from running down, avoid using the power adjustment when the engine is stopped. The adjuster uses a large amount of electrical power.
- Do not use the switch to make more than one adjustment at a time.

Front Seat

▼ Adjusting the Driver's Seat

Using the driving position set up procedure recommended by Mazda allows you to maintain a relaxed posture, drive the vehicle for longer periods without feeling tired, and make quick operations naturally. Also, you can be assured of a clear view in the forward direction to help you drive more safely and comfortably. The adjustments for the driving position recommended by Mazda are done using the following procedures.

1. Moving the steering wheel and seat to their default positions.
2. Adjusting the seatback angle.
3. Adjusting the seat position forward and back.
4. Adjusting the seat height.
5. Adjusting the height on the front edge of the seat bottom.
6. Adjusting the steering wheel position.
7. Adjusting the head restraint position.

Manual seat

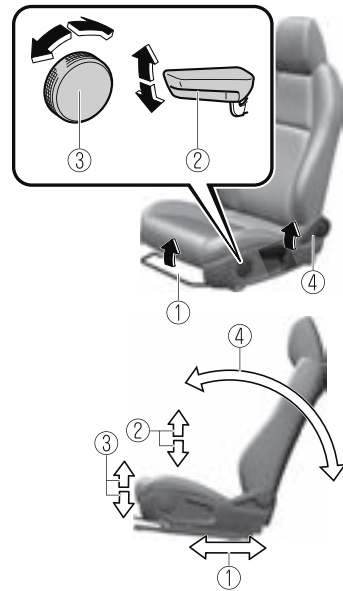

1. Seat Slide

To move a seat forward or backward, raise the lever and slide the seat to the desired position and release the lever.

Make sure the lever returns to its original position and the seat is locked in place by attempting to push it forward and backward.

2. Height Adjustment

To adjust the seat height, move the lever up or down.

3. Height Adjustment for Front Edge of Seat Bottom

To adjust the height for front edge of the seat bottom, rotate the dial to the desired position.

Seats

4. Seat Recline

To change the seatback angle, lean forward slightly while raising the lever. Then lean back to the desired position and release the lever. Make sure the lever returns to its original position and the seatback is locked in place by attempting to push it forward and backward.

Power seat



1. Seat Slide

To slide the seat, move the slide lifter switch on the outside of the seat to the front or back and hold it. Release the switch at the desired position.

2. Height Adjustment

To adjust the seat height, move the slide lifter switch up or down.

3. Height Adjustment for Front Edge of Seat Bottom

To adjust the front height of the seat bottom, raise or lower the front of the slide lifter switch.

4. Seat Recline

To change the seatback angle, press the front or rear side of the reclining switch. Release the switch at the desired position.

5. Lumbar Support Adjustment

To increase the seat firmness, press and hold the front part of the switch to the desired position, then release it.

Press the rear part of the switch to decrease firmness.

Before making adjustments to the driving position recommended by Mazda

Before making adjustments, move the steering wheel and seat to their default positions.

How to move the steering wheel to its default position

⚠ WARNING

Never adjust the steering wheel while the vehicle is moving:

Adjusting the steering wheel while the vehicle is moving is dangerous. Moving it can very easily cause the driver to abruptly turn to the left or right. This can lead to loss of control or an accident.

After adjusting the steering wheel position, make sure it is securely locked by trying to move it up and down:

Driving with the steering wheel not securely locked in position is dangerous. If the steering wheel moves unexpectedly while driving, you could lose control of the steering resulting in an accident.

Lower the lever, move the steering wheel to the lowest position, and then push it down and all the way back.

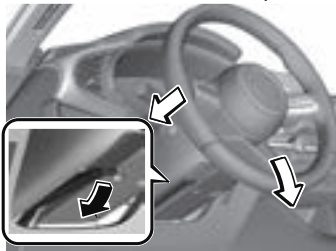

How to move a driver's seat to its default position

1. Slide the seat all the way back.
2. Lower the seat to its lowest height.
3. Lower the front edge of the seat bottom to its lowest height.
4. Sit squarely in the seat and rest your back against the seatback.

Seat adjustment procedure for the driving position recommended by Mazda

Adjusting the seatback angle (reclining)

Adjust the seatback to the angle providing a comfortable seated posture.

1. With your posture slightly slouched, move the seatback forward to the angle where your waist feels slightly cramped.

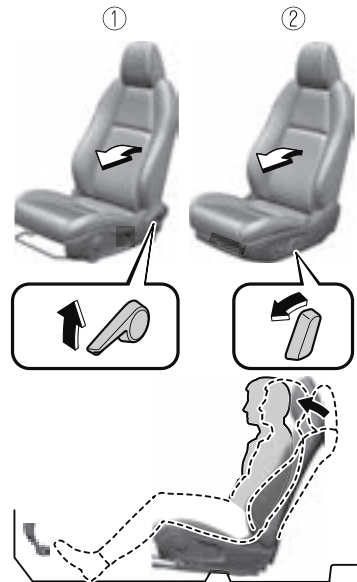

1. Manual Seat
2. Power Seat

2. Move the seatback backward to a comfortable seated posture without

Seats

any feeling of cramping in your waist.



- 1. Manual Seat
- 2. Power Seat

Adjusting the seat position forward and back (sliding)

Adjust the seat to the position best for operating the accelerator and brake pedals.

1. Place your left foot on the footrest, your right foot between the accelerator and brake pedals, and position your heel to the position allowing easy switching between the pedals.
2. With your heel set on the floor, set your right foot on the brake pedal and move the seat forward as far as possible until you feel a slight cramping in your ankle.



- 1. Manual Seat
- 2. Power Seat

3. With your right foot set on the brake pedal, move the seat back until you no longer feel cramping in your ankle.
4. With your heel set on the floor, make sure you can move your foot between the brake pedal and accelerator pedal smoothly.
5. Depress the accelerator pedal completely with your heel set on the floor and make sure that your ankle does not feel over-stretched.

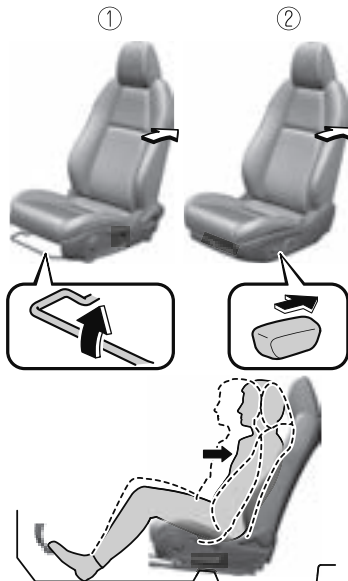

1. Manual Seat
2. Power Seat

Adjusting the seat height

Adjust the seat height to a position where you have a clear forward view and you can drive the vehicle easily.

1. With your back resting against the seatback, raise the seat to the height where you can see the rear edge area of the hood surface from the windshield.

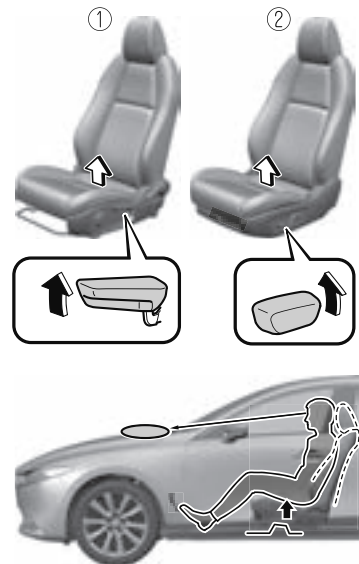

1. Manual Seat
2. Power Seat

Seats

Adjusting the height on the front edge of the seat bottom

Adjust the height on the front edge of the seat bottom to the position where the back of your knees contacts the front edge of the seat bottom.

1. With your right foot set on the accelerator pedal, adjust the height on the front edge of the seat bottom so that the back of your knees lightly contacts the front edge of the seat bottom.
2. Depress the accelerator pedal and make sure that you no longer feel cramping in the back of your knees.

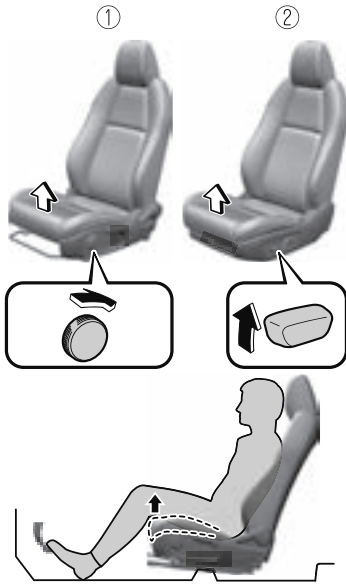

1. Manual Seat
2. Power Seat

Adjusting the steering wheel position

Adjust the steering wheel to the position where it can be operated easily and the gauges can be viewed easily.

1. With your back resting against the seatback, extend both arms, place them on the top of the steering wheel, and pull the steering wheel towards you to the position of your wrists.

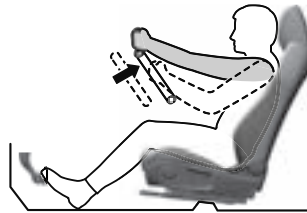

2. Adjust the steering wheel height so that the gauges can be viewed easily.
3. Raise the lever to securely lock the steering wheel.

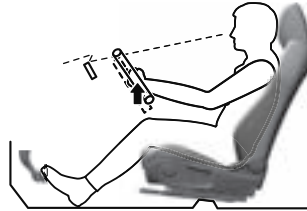

Adjusting the head restraint position

To prevent shock to the head and neck, adjust the head restraints to their correct positions.

Refer to Height Adjustment on page 2-17.

▼ **Driving Position Memory (Power Seat)***

The desired driving position can be called up after programming the position.

The following driving positions can be programmed.

- Driver's seat position (seat slide, height adjustment, front edge of seat bottom, seat recline)
 Refer to Adjusting the Driver's Seat on page 2-5.
- Active driving display (display position, brightness level, display information)
 Refer to Active Driving Display on page 4-30.
- Outside mirror angle
 Refer to Outside Mirrors on page 3-30.

A driving position can be programmed to the following parts.

- Position memory button
- Transmitter used for vehicle

NOTE

- Lumbar support adjustment cannot be programmed.

Programming

1. Make sure the parking brake is on.
2. **(Automatic transmission)**
 Make sure the selector lever is in the P position.
3. Switch the ignition ON.
4. Adjust the following parts to the desired conditions.
 - Driver's seat
 - Active driving display
 - Outside mirrors

5. Press the SET button continuously until a sound is activated.

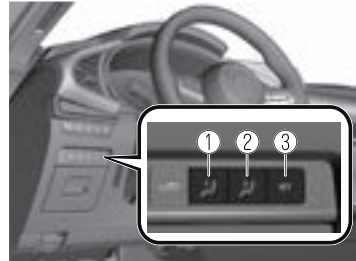

1. 1 button
2. 2 button
3. SET button
6. Do the following operation within 5 seconds after the sound is activated to program the driving position.

- **Programming to a position memory button**
 Press the button you want to program, either 1 or 2 button.
- **Programming to the transmitter**
 Press the unlock button on the transmitter.

A sound is activated when the operation is completed correctly.

NOTE

- If you do not perform the operation correctly, a sound indicating that the programming has failed is activated.
- If the angle of the outer mirrors only changes a little, the angle of the outer mirrors may not have been programmed correctly.
- If the angle of the outer mirrors is adjusted close to the limits of its range of motion, the driving position can be successfully programmed, but it may fail when calling up the programmed driving position.

Seats

Calling up the programmed driving position



Do not place fingers or hands around the bottom of the seat while the seat memory function is operating. The seat moves automatically while the seat memory function is operating and fingers or hands could get pinched and injured.

Using the position memory button

1. Make sure the parking brake is on.
2. **(Automatic transmission)**
Make sure the selector lever is in the P position.
3. Switch the ignition ON.
4. Press the programming button for the driving position you want to call up (button 1 or 2).
5. A sound is activated when the adjustment to the programmed driving position is completed.

NOTE

- When adjustment of the driving position is not necessary, a sound is not activated.
- The driving position adjustment is canceled in the following cases:
 - The seat adjustment switch on the driver's seat is operated.
 - The angle of the outer mirrors is adjusted.
 - The SET button is pressed.
 - Programming button 1 or 2 is pressed.
 - The lock button or unlock button on the transmitter is pressed.
 - The vehicle starts moving.
 - The active driving display is adjusted.
- **(Manual transmission)**
The parking brake is released.

- **(Automatic transmission)**
The selector lever is shifted to a position other than P.

Using the transmitter

1. Unlock the driver's door using one of the following methods.
 - Touch the sensing area of the door release touch sensor.
 - Press the unlock button on the transmitter.
2. When you open the driver's door within 90 seconds after unlocking the doors, the adjustment of the following parts starts.
 - Driver's seat
 - Active driving display (When the ignition is switched ON, the adjusted active driving display is activated.)
 - Outside mirrors

A sound is activated when the adjustment is completed.

NOTE

- When adjustment of the driving position is not necessary, a sound is not activated.
- The driving position adjustment is canceled in the following cases:
 - The seat adjustment switch on the driver's seat is operated.
 - The angle of the outer mirrors is adjusted.
 - The SET button is pressed.
 - Programming button 1 or 2 is pressed.
 - The lock button or unlock button on the transmitter is pressed.
 - The vehicle starts moving.
 - The active driving display is adjusted.
 - **(Manual transmission)**
The parking brake is released.
 - **(Automatic transmission)**
The selector lever is shifted to a position other than P.

Erasing programmed driving positions

Erasing the driving positions programmed to the key

1. Switch the ignition OFF.
2. Press the SET button continuously until a sound is activated.
3. Press the lock button on the transmitter within 5 seconds after the sound is activated.

NOTE

If you do not perform the operation correctly, a sound indicating that the programming has failed is activated.

▼ Adjusting the Front Passenger's Seat

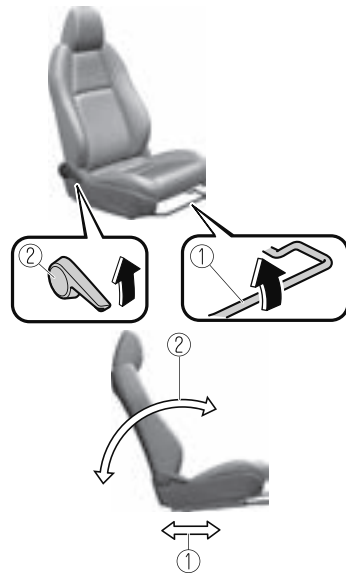

1. Seat Slide

To move a seat forward or backward, raise the lever and slide the seat to the desired position and release the lever.

Make sure the lever returns to its original position and the seat is locked in place by attempting to push it forward and backward.

2. Seat Recline

To change the seatback angle, lean forward slightly while raising the lever. Then lean back to the desired position and release the lever. Make sure the lever returns to its original position and the seatback is locked in place by attempting to push it forward and backward.

Seats

Rear Seat

▼ Split Folding the Seatbacks

By lowering the rear seatbacks the luggage compartment space can be expanded.



Do not drive the vehicle with occupants on folded down seatbacks or in the luggage compartment.

Putting occupants in the luggage compartment is dangerous because seat belts cannot be fastened which could lead to serious injury or death during sudden braking or a collision.

Do not allow children to play inside the vehicle with the seatbacks lowered.

Allowing children to play in the vehicle with the seatbacks folded down is dangerous. If a child enters the luggage compartment and the seatbacks were raised back up, the child may become trapped in the luggage compartment which could lead to an accident.

Tightly secure cargo in the luggage compartment when it is transported with the seatbacks folded down.

Driving without tightly securing cargo and luggage is dangerous as it could move and become an obstruction to driving during emergency braking or a collision resulting in an unexpected accident.

When transporting cargo, do not allow the cargo to exceed the height of the seatbacks.

Transporting cargo stacked higher than the seatbacks is dangerous as visibility to the rear and sides of the vehicle is reduced which could interfere with driving operations and lead to an accident.

Lowering the seatbacks



➤ (5-Door)

When folding the seatback forward, always support the seatback with your hand. If it is not supported by a hand, fingers or the hand pressing the push knob could be injured.

- Check the position of a front seat before folding a rear seatback. Depending on the position of a front seat, it may not be possible to fold a rear seatback all the way down because it may hit the seatback of the front seat which could scratch or damage the front seat or its pocket. Lower or remove the head restraint on the rear outboard seat if necessary.

(4-Door)

1. Open the trunk lid and pull the lever of the seatback you want to fold down.



2. Open a rear door and fold the rear seat forward.

(5-Door)

Press the push knob to fold down the seatback.

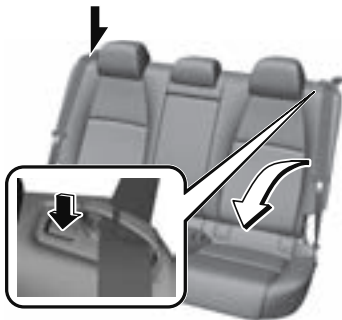

To return the seatback to its upright position:



When returning a seatback to its upright position, make sure the 3-point seat belt is not caught in the seatback and the 3-point seat belt is not twisted.

If the seat belt is used while it is twisted and caught in the seatback, the seat belt cannot function at its full capacity, which could cause serious injury or death.

When returning a seatback to its upright position, make sure that it is firmly locked and the red indication is not visible (5-Door).

If the red indication is visible behind the push knob, it means the seatback is not locked. If the vehicle is driven without the seatback locked, it could fold down suddenly and cause an accident.

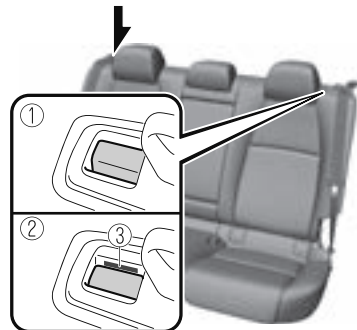

1. Locked position
2. Unlocked position
3. Red indication

Seats

1. Make sure that the seat belt passes through the seat belt guide correctly and it is not twisted, then raise the seatback while preventing the seat belt from being caught in the seatback.

(4-Door)

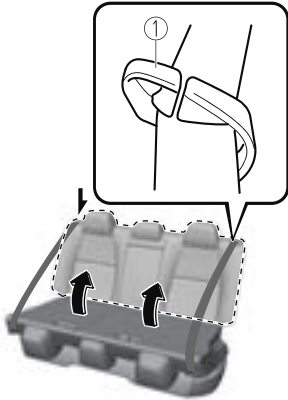

1. Seat belt guides

(5-Door)

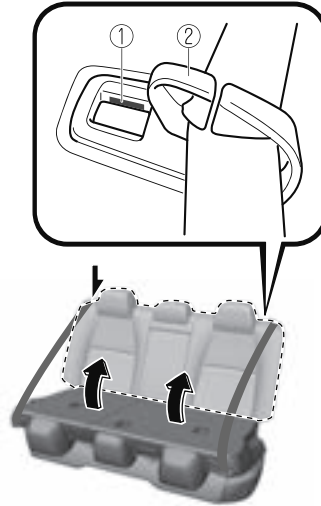

1. Red indication
 2. Seat belt guide
2. Press the seatback rearward and lock it in place. After returning the seatback to its upright position, make sure it is securely locked.

▼ Armrest*

The rear armrest in the center of the rear seatback can be used (no

occupant in the center seat) or placed upright.

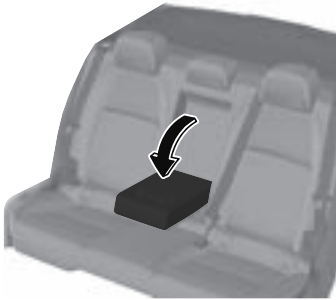

⚠ WARNING

Never put your hands and fingers around the moving parts of the seat and armrest:

Putting your hands and fingers around the moving parts of the seat and armrest is dangerous as they could get injured.

Head Restraints

▼ Head Restraints

Your vehicle is equipped with head restraints on all outboard seats and the rear center seat. The head restraints are intended to help protect you and the passengers from neck injury.

⚠ WARNING

Always drive with the head restraints installed when seats are being used and make sure they are properly adjusted:

Driving with the head restraints adjusted too low or removed is dangerous. With no support behind your head, your neck could be seriously injured in a collision.

▼ Height Adjustment

Adjust the head restraint so that the center is even with the top of the passenger's ears.

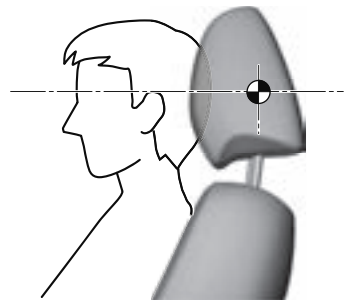

To raise a head restraint, pull it up to the desired position.

To lower the head restraint, press the stop-catch release, then push the head restraint down.

Front seats

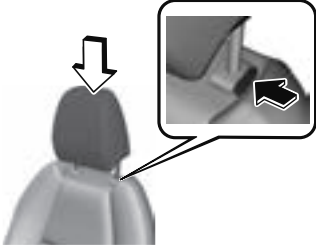

Rear outboard seats

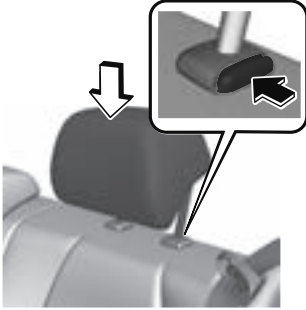

Rear center seat

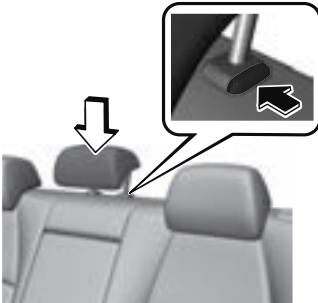

▼ **Removal/Installation**

To remove the head restraint, pull it up while pressing the stop-catch.
To install the head restraint, insert the legs into the holes while pressing the stop-catch.

⚠ WARNING

Always drive with the head restraints installed when seats are being used and make sure they are properly installed:

Driving with the head restraints not installed is dangerous. With no support behind your head, your neck could be seriously injured in a collision.

After installing a head restraint, try lifting it to make sure that it does not pull out:

Driving with an unsecured head restraint is dangerous as the effectiveness of the head restraint will be compromised which could cause it to unexpectedly detach from the seat.

 **CAUTION**

- When installing a head restraint, make sure that it is installed correctly with the front of the head restraint facing forward. If the head restraint is installed incorrectly, it could detach from the seat during a collision and result in injury.
- The head restraints on each of the front and rear seats are specialized to each seat. Do not switch around the head restraint positions. If a head restraint is not installed to its correct seat position, the effectiveness of the head restraint during a collision will be compromised which could cause injury.

Seat Warmer/Heated Steering Wheel

Seat Warmer*

▼ Seat Warmer

The front seats can be warmed up while the engine is running. While the seat warmer is operating, the indicator light in the seat warmer switch turns on according to the set temperature.

Manual mode

When the seat warmer switch is pressed, the seat warmer operates in manual mode. The set temperature changes as shown in the figure each time the seat warmer switch is pressed.

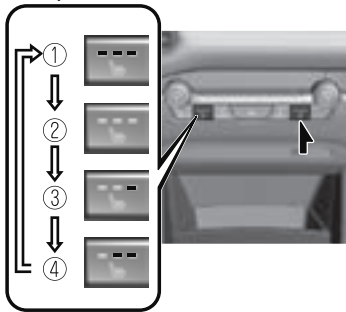

- 1. OFF
- 2. High
- 3. Mid
- 4. Low

NOTE

If the engine is turned off while the seat warmer is operating in manual mode, the seat warmer does not turn on automatically the next time the engine is turned on. To turn the seat warmer on, press the switch again.

Auto mode

The driver and front passenger's seat warmer can be operated in auto mode using the following procedure.

1. If "Link Seat & Climate Control Temperatures" has been disabled, enable it using the following procedure.
 - a) Select "Settings" from the Mazda Connect home screen.
 - b) Select "Vehicle Settings".
 - c) Enable "Link Seat & Climate Control Temperatures".
2. Press the AUTO switch.

While in auto mode, the seat temperature is automatically controlled in 4 levels (High, Mid, Low, and OFF) according to the conditions in the cabin.

NOTE

- If the front passenger's seat belt is unfastened, the front passenger's seat warmer turns off.
- If the seat warmer switch is pressed during auto mode, the seat warmer on the side where the switch was pressed switches to manual mode. To return to auto mode, press the AUTO switch.
- If the engine is turned off while the seat warmer is operating in auto mode, the seat warmer operates in auto mode again the next time the engine is turned on.

Seat Warmer/Heated Steering Wheel

⚠ WARNING

Be careful when using the seat warmer:

The heat from the seat warmer may be too hot for the following people and could cause a low-temperature burn.

- Infants, small children, elderly people, and physically challenged people
- People with delicate skin
- People who are excessively fatigued
- People who are intoxicated
- People who have taken sleep-inducing medicine such as sleeping pills or cold medicine

Do not use the seat warmer with anything having high moisture-retention ability such as a blanket or cushion on the seat:

The seat may be heated excessively and cause a low-temperature burn.

Do not use the seat warmer even when taking a short nap in the vehicle:

The seat may be heated excessively and cause a low-temperature burn.

Do not place heavy objects with sharp projections on the seat, or insert needles or pins into it:

This could cause the seat to become excessively heated and result in injury from a minor burn.

⚠ CAUTION

- Do not use organic solvents to clean the seat. It may damage the seat surface and the heater.

Heated Steering Wheel*

▼ Heated Steering Wheel

The grips on the left and right of the steering wheel can be warmed up when the ignition is switched ON. While the heated steering wheel is operating, the indicator light in the heated steering wheel switch turns on.



1. Heated steering wheel switch
2. Heating area

Manual mode

The heated steering wheel operates for about 30 minutes when the heated steering wheel switch is pressed, and then automatically turns off.

To turn the heated steering wheel off manually, press the switch again.

Seat Warmer/Heated Steering Wheel

Auto mode

The heated steering wheel can be operated in auto mode using the following procedure.

1. If "Link Seat & Climate Control Temperatures" has been disabled, enable it using the following procedure.
 - a) Select "Settings" from the Mazda Connect home screen.
 - b) Select "Vehicle Settings".
 - c) Enable "Link Seat & Climate Control Temperatures".
2. Press the AUTO switch.

While in auto mode, the heated steering wheel automatically operates/turns off according to the conditions in the cabin.

NOTE

- If the heated steering wheel switch is pressed during auto mode, the heated steering wheel switches to manual mode. To return to auto mode, press the AUTO switch.
- If the ignition is switched OFF while the heated steering wheel is operating in auto mode, the heated steering wheel operates in auto mode again the next time the ignition is switched ON.

CAUTION

The following types of persons should be careful not to touch the steering wheel. Otherwise, it could cause a low-temperature burn.

- Infants, small children, elderly people, and physically challenged people
- People with delicate skin
- People who are excessively fatigued
- People who are intoxicated
- People who have taken sleep-inducing medicine such as sleeping pills or cold medicine

Seat Belt Precautions

▼ Seat Belt Precautions

Seat belts help to decrease the possibility of severe injury during accidents and sudden stops. Mazda recommends that the driver and all passengers always wear seat belts.

(Mexico)

All the seats have lap/shoulder belts. These belts have retractors with inertia locks that keep them out of the way when not in use. The locks allow the belts to remain comfortable on users, but they will lock in position during a collision.

(Except Mexico)

All of the seat belt retractors are designed to keep the lap/shoulder belts out of the way when not in use. The driver's seat belt has no provisions for child-restraint systems and has only an emergency locking mode. The driver may wear it comfortably, and it will lock during a collision. However, the front passenger's seat and all rear lap/shoulder belt retractors operate in two modes: emergency locking mode, and for child-restraint systems, automatic locking mode. While we recommend you put all children in the rear seats, if you must use the front passenger seat for a child, slide the front passenger seat as far back as possible and make sure any child-restraint system is secured properly.

WARNING

Always wear your seat belt and make sure all occupants are properly restrained:

Not wearing a seat belt is extremely dangerous. During a collision, occupants not wearing seat belts could hit someone or things inside the vehicle or even be thrown out of the vehicle. They could be seriously injured or even killed. In the same collision, occupants wearing seat belts would be much safer.

Do not wear twisted seat belts:

Twisted seat belts are dangerous. In a collision, the full width of the belt is not available to absorb the impact. This puts more force on the bones beneath the belt, which could cause serious injury or death. So, if your seat belt is twisted, you must straighten the seat belt to remove any twists and to allow the full width of the belt to be used.

Never use one seat belt on more than one person at a time:

Using one seat belt for more than one person at a time is dangerous. A seat belt used in this way cannot spread the impact forces properly and the two passengers could be crushed together and seriously injured or even killed. Never use one belt for more than one person at a time and always operate the vehicle with each occupant properly restrained.

Seat Belt Systems

Do not operate a vehicle with a damaged seat belt:

Using a damaged seat belt is dangerous. An accident could damage the belt webbing of the seat belt in use. A damaged seat belt cannot provide adequate protection in a collision. Have an Authorized Mazda Dealer inspect all seat belt systems in use during an accident before they are used again.

Have your seat belts changed immediately if the pretensioner or load limiter has been expended:

Always have an Authorized Mazda Dealer immediately inspect the seat belt pretensioners and air bags after any collision. Like the air bags, the seat belt pretensioners and load limiters will only function once and must be replaced after any collision that caused them to deploy. A seat belt with an expended pretensioner or load limiter is still better than wearing no seat belt at all; however, if the seat belt pretensioners and load limiters are not replaced, the risk of injury in a collision will increase.

Positioning the Shoulder Portion of the Seat Belt:

Improper positioning of the shoulder portion of the seat belt is dangerous. Always make sure the shoulder portion of the seat belt is positioned across your shoulder and near your neck, but never under your arm, on your neck, or on your upper arm.

Positioning the Lap Portion of the Seat Belt:

The lap portion of the seat belt worn too high is dangerous. In a collision, this would concentrate the impact force directly on the abdominal area, causing serious injury. Wear the lap portion of the belt snugly and as low as possible.

⚠ CAUTION

Belt retraction may become difficult if the belts and rings are soiled, so try to keep them clean. For more details about cleaning the seat belts, refer to "Seat Belt Maintenance" (page 6-54).

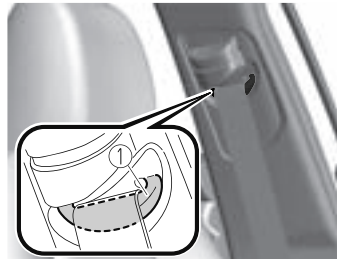

1. Ring

▼ Pregnant Women and Persons with Serious Medical Conditions

Pregnant women should always wear seat belts. Ask your doctor for specific recommendations.

The lap belt should be worn **SNUGLY AND AS LOW AS POSSIBLE OVER THE HIPS.**

The shoulder belt should be worn across your shoulder properly, but never across the stomach area.

Persons with serious medical conditions also should wear seat belts. Check with your doctor for any special instructions regarding specific medical conditions.

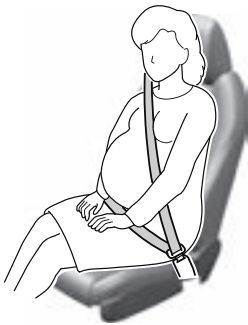

▼ Emergency Locking Mode

When the seat belt is fastened, it will always be in the emergency locking mode.

In the emergency locking mode, the belt remains comfortable on the occupant and the retractor will lock in position during a collision.

If the belt is locked and cannot be pulled out, retract the belt once, and then try pulling it out slowly. If this fails, pull the belt strongly 1 time and loosen, then pull it out again slowly.

(Seat Belt with Automatic Locking Mode)

When the seat belt is fastened, it will always be in the emergency locking

mode until it is switched to automatic locking mode by pulling it all the way out to its full length. If the belt feels tight and hinders comfortable movement while the vehicle is stopped or in motion, it may be in the automatic locking mode because the belt has been pulled too far out. To return the belt to the more comfortable emergency locking mode, wait until the vehicle has stopped in a safe, level area, retract the belt fully to convert it back to emergency locking mode and then extend it around you again.

▼ Automatic Locking Mode (Except Mexico)

Always use the automatic locking mode to keep the child-restraint system from shifting to an unsafe position in the event of an accident. To enable seat belt automatic locking mode, pull it all the way out and connect it as instructed on the child-restraint system. It will retract down to the child-restraint system and stay locked on it. See the section on child restraint (page 2-44).

Seat Belt Systems

Seat Belt

▼ Fastening the Seat Belt

Insert the seat belt tongue into the buckle.

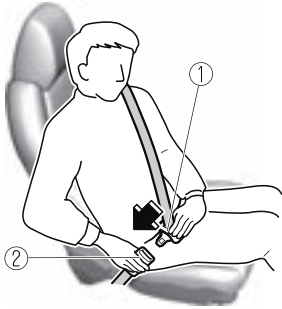

1. Seat belt tongue
2. Seat belt buckle

Position the lap belt as low as possible, not on the abdominal area, then adjust the shoulder belt so that it fits snugly against your body.

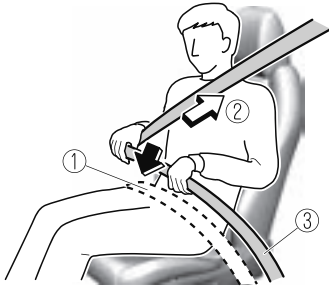

1. Keep low on hip bone
2. Take up slack
3. Too high

Before fastening the rear seat belt, make sure that the seat belt passes through the seat belt guide correctly and it is not twisted.



▼ Unfastening the Seat Belt

Depress the button on the seat belt buckle. If the belt does not fully retract, pull it out and check for kinks or twists. Then make sure it remains untwisted as it retracts.

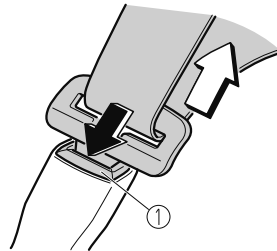

1. Button

NOTE

If a belt does not fully retract, inspect it for kinks and twists. If it is still not retracting properly, have it inspected at an Authorized Mazda Dealer.

▼ Front Shoulder Belt Adjuster

The front seat belts have a front shoulder belt adjuster. If the seat belt contacts your neck or it slips off the shoulder, adjust the seat belt height.

To raise

To heighten the seat belt, move the front shoulder belt adjuster upward.



To lower

To lower the seat belt, hold the front shoulder belt adjuster and lower the seat belt with the knob of the front shoulder belt adjuster pressed.



After adjusting, press the front shoulder belt adjuster downward and make sure that it is securely locked.

Seat Belt Warning Systems

▼ Seat Belt Warning Systems

If it detects that the occupant seat belt is unfastened, the warning light or beep alerts the occupant.

Refer to Seat Belt Warning Indication/Warning Light (Front seat) on page 7-36.

Refer to Seat Belt Warning Light (Rear seat) (Red) on page 7-36.

Refer to Seat Belt Warning Beep on page 7-42.

Seat belt indicator light (rear seat) (green)

REAR



The light turns on when the rear seat belt is fastened while the ignition is switched ON, and it turns off after a certain period.

Front Seat Belt Pretensioner and Load Limiting Systems

▼ Front Seat Belt Pretensioner and Load Limiting Systems

For optimum protection, the driver and front passenger seat belts are equipped with pretensioner and load limiting systems. For both these systems to work properly you must wear the seat belt properly.

Pretensioners:

When a collision is detected, the pretensioners deploy simultaneously with the air bags.

For vehicles with the front passenger occupant classification system, the pretensioners deploy simultaneously with the air bags when a roll-over is also detected.

For deployment details, refer to the SRS Air Bag Deployment Criteria (page 2-67).

The seat belt retractors remove slack quickly as the air bags are expanding. Any time the air bags and seat belt pretensioners have fired they must be replaced.

A system malfunction or operation conditions are indicated by a warning. Refer to Air Bag/Front Seat Belt Pretensioner System Warning Indication/Warning Light on page 7-32.

(With Front Passenger Occupant Classification System)

In addition, the pretensioner system for the front passenger, like the front and side passenger air bag, is designed to only deploy in accordance with the total seated weight on the front passenger seat.

For details, refer to the front passenger seat weight sensors (page 2-71).

Load limiter:

The load limiting system releases belt webbing in a controlled manner to reduce belt force on the occupant's chest. While the most severe load on a seat belt occurs in frontal collisions, the load limiter has an automatic mechanical function and can activate in any accident mode with sufficient occupant movement.

Even if the pretensioners have not fired, the load limiting function must be checked by an Authorized Mazda Dealer.



Wear seat belts only as recommended in this owner's manual:

Incorrect positioning of the seat belts is dangerous. Without proper positioning, the pretensioner and load limiting systems cannot provide adequate protection in an accident and this could result in serious injury. For more details about wearing seat belts, refer to "Fastening the Seat Belt" (page 2-26).

Have your seat belts changed immediately if the pretensioner or load limiter has been expended:

Always have an Authorized Mazda Dealer immediately inspect the seat belt pretensioners and air bags after any collision. Like the air bags, the seat belt pretensioners and load limiters will only function once and must be replaced after any collision that caused them to deploy. A seat belt with an expended pretensioner or load limiter is still better than wearing no seat belt at all; however, if the seat belt pretensioners and load limiters are not replaced, the risk of injury in a collision will increase.

Do not modify the components or wiring, or use electronic testing devices on the pretensioner system:

Modifying the components or wiring of the pretensioner system, including the use of electronic testing devices is dangerous. You could accidentally activate it or make it inoperable which would prevent it from activating in an accident. The occupants or repairers could be seriously injured.

Properly dispose of the pretensioner system:

Improper disposal of the pretensioner system or a vehicle with non-deactivated pretensioners is dangerous. Unless all safety procedures are followed, injury could result. Have an Authorized Mazda Dealer safely dispose of the pretensioner system or scrap a pretensioner system equipped vehicle.

NOTE

- The pretensioner system may not operate depending on the type of the collision. For details, refer to the SRS Air Bag Deployment Criteria (page 2-67).
- Some smoke (non-toxic gas) will be released when the air bags and pretensioners deploy. This does not indicate a fire. This gas normally has no effect on occupants, however, those with sensitive skin may experience light skin irritation. If residue from the deployment of the air bags or the pretensioner system gets on the skin or in the eyes, wash it off as soon as possible.

Seat Belt Extender

▼ Seat Belt Extender

If your seat belt is not long enough, even when fully extended, a seat belt extender may be available to you at no charge from your Authorized Mazda Dealer.

This extender will be only for you and for the particular vehicle and seat. Even if it plugs into other seat belts, it may not hold in the critical moment of a crash.

When ordering an extender, only order one that provides the necessary additional length to fasten the seat belt properly. Please contact your Authorized Mazda Dealer for more information.

WARNING

Do not use a seat belt extender unless it is necessary:

Using a seat belt extender when not necessary is dangerous. The seat belt will be too long and not fit properly. In an accident, the seat belt will not provide adequate protection and you could be seriously injured. Only use the extender when it is required to fasten the seat belt properly.

Do not use an improper extender:

Using a seat belt extender that is for another person or a different vehicle or seat is dangerous. The seat belt will not provide adequate protection and the user could be seriously injured in an accident. Only use the extender provided for you and for the particular vehicle and seat. NEVER use the extender in a different vehicle or seat. If you sell your Mazda, do not leave your seat belt extender in the vehicle. It could be used accidentally by the new owner of the vehicle. After removing the seat belt extender, discard it. Never use the seat belt extender in any other vehicle you may own in the future.

Do not use an extender that is too long:

Using an extender that is too long is dangerous. The seat belt will not fit properly. In an accident, the seat belt will not provide adequate protection and you could be seriously injured. Do not use the extender or choose one shorter in length if the distance between the extender's buckle and the center of the user's body is less than 15 cm (6 in).

Do not leave a seat belt extender connected to the buckle:

Leaving a seat belt extender connected to the buckle without using the seat belt is dangerous. When the seat belt extender is connected to the driver's seat belt buckle (or front passenger's seat belt buckle), the SRS driver's (or front passenger's) air bag system will determine that the driver (or front passenger) is wearing the seat belt even if the driver (or front passenger) is not wearing it. This condition could cause the driver's (or front passenger's) air bag to not activate correctly and result in death or serious injury in the event of collision. Always wear the seat belt with the seat belt extender.

Do not use the seat belt extender when installing a child-restraint system on the front or rear passenger seat:

Using a seat belt extender to fasten a child-restraint system on any seat is dangerous. Always follow the child-restraint system manufacturer's installation instructions and never use a seat belt extender.

NOTE

When not in use, remove the seat belt extender and store it in the vehicle. If the seat belt extender is left connected, the seat belt extender might get damaged as it will not retract with the rest of the seat belt and can easily fall out of the door when not in use and be damaged. In addition, the seat belt warning light will not illuminate and function properly.

Child-Restraint Precautions

▼ Child-Restraint Precautions

Mazda strongly urges the use of child-restraint systems for children small enough to use them.

You are required by law to use a child-restraint system for children in the U.S. and Canada.

Check your local and state or provincial laws for specific requirements regarding the safety of children riding in your vehicle.

Whatever child-restraint system you consider, please pick the appropriate one for the age and size of the child, obey the law and follow the instructions that come with the individual child-restraint system.

A child who has outgrown child-restraint systems should sit in the rear and use seat belts, both lap and shoulder. If the shoulder belt crosses the neck or face, move the child closer to the center of the vehicle in the outboard seats, and towards the buckle on the right if the child is seated on the center seat.

Statistics confirm that the rear seat is the best place for all children up to 12 years of age, and more so with a supplemental restraint system (air bags).

A rear-facing child-restraint system should **NEVER** be used on the front seat with the air bag system activated. The front passenger's seat is also the least preferred seat for other child-restraint systems.

(With Front Passenger Occupant Classification System)

To reduce the chance of injuries caused by deployment of the front passenger air bag, the front passenger seat weight sensors occupant classification sensor works as a part of the supplemental restraint system. This system deactivates the front passenger front and side air bags and knee air bags, and also the front passenger seat belt pretensioner system when the front passenger air bag deactivation indicator light illuminates.

When an infant or small child sits on the front passenger seat, the system shuts off the front passenger front and side air bags and knee air bags, and seat belt pretensioner system, so make sure the front passenger air bag deactivation indicator light illuminates.

Even if the front passenger air bag is shut off, Mazda strongly recommends that children be properly restrained and child-restraint systems of all kinds are properly secured on the rear seats which are the best place for children.

For more details, refer to "Front passenger seat weight sensors" (page 2-71).

⚠ WARNING

Use the correct size child-restraint system:

For effective protection in vehicle accidents and sudden stops, a child must be properly restrained using a seat belt or child-restraint system depending on age and size. If not, the child could be seriously injured or even killed in an accident.

Follow the manufacturer's instructions and always keep the child-restraint system buckled down:

An unsecured child-restraint system is dangerous. In a sudden stop or a collision it could move causing serious injury or death to the child or other occupants. Make sure any child-restraint system is properly secured in place according to the child-restraint system manufacturer's instructions. When not in use, remove it from the vehicle or fasten it with a seat belt, or attach it to BOTH ISOFIX/LATCH*¹ lower anchors for ISOFIX/LATCH*¹ child-restraint systems and the corresponding tether anchor.

*¹ ISOFIX (Mexico)/LATCH (Except Mexico)

Always secure a child in a proper child-restraint system:

Holding a child in your arms while the vehicle is moving is extremely dangerous. No matter how strong the person may be, he or she cannot hold onto a child in a sudden stop or collision and it could result in serious injury or death to the child or other occupants. Even in a moderate accident, the child may be exposed to air bag forces that could result in serious injury or death to the child, or the child may be slammed into an adult, causing injury to both child and adult.

Never use a rear-facing child-restraint system in the front seat with an air bag that could deploy:

Rear-facing child-restraint systems on the front seat are particularly dangerous even though you may feel assured that a front passenger air bag will not deploy based on the fact that the front passenger air bag deactivation indicator light illuminates. The child-restraint system can be hit by a deploying air bag and moved violently backward resulting in serious injury or death to the child.



(Mexico)

NEVER use a rearward facing child restraint on a seat protected by an ACTIVE AIRBAG in front of it, DEATH or SERIOUS INJURY to the CHILD can occur.

Vehicles with a front passenger air bag have the following warning label. The warning label reminds you not to put a rear-facing child-restraint system on the front passenger seat at any time.

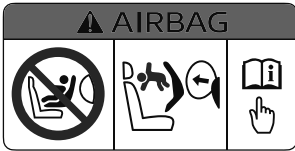

(Except Mexico)

Vehicles with a front passenger air bag have the following warning label. The warning label reminds you not to put a rear-facing child-restraint system on the front passenger seat at any time.



Do not install a front-facing child-restraint system on the front passenger seat unless it is unavoidable:

In a collision, the force of a deploying air bag could cause serious injury or death to the child. If installing a front-facing child-restraint system on the front passenger seat is unavoidable, move the front passenger seat as far back as possible.

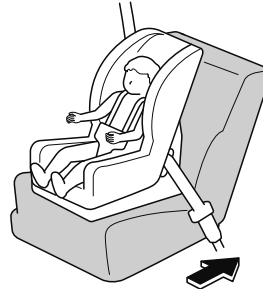

Seating a child in a child-restraint system on the front passenger seat is dangerous under certain conditions (With Front Passenger Occupant Classification System):

Your vehicle is equipped with front passenger seat weight sensors. Even with the front passenger seat weight sensors, if you must use the front passenger seat to seat a child, using a child-restraint system on the front passenger seat under the following conditions increases the danger of the front passenger air bag deploying and could result in serious injury or death to the child.

- The front passenger air bag deactivation indicator light does not illuminate when seating a child in the child-restraint system.
- Luggage or other items are placed on the seat with the child in the child-restraint system.
- A rear passenger or luggage pushing or pulling down on the front passenger seatback.
- Luggage or other items are placed on the seatback or hung on the head restraint.
- The seat is washed.
- Liquids are spilled on the seat.
- The front passenger seat is moved backward, pushing into luggage or other items placed behind it.
- The front passenger seatback contacts the rear seat.
- Luggage or other items are placed between the front passenger seat and driver seat.
- An electric device is put on the front passenger's seat.
- An additional electrical device, such as a seat warmer is installed to the surface of the front passenger seat.
- Any accessories, which might increase the total seated weight on the front passenger seat, are attached to the front passenger seat.

The designated positions with seat belts on the rear seats are the safest places for children. Always use seat belts and child restraints.

Do not allow a child or anyone to lean over to or against the side window of a vehicle with side and curtain air bags:

It is dangerous to allow anyone to lean over to or against the side window, the area of the front passenger seat, the front and rear window pillars and the roof edge along both sides from which the side and curtain air bags deploy, even if a child-restraint system is used. The impact of inflation from a side or curtain air bag could cause serious injury or death to an out of position child. Furthermore, leaning over to or against the door could block the side and curtain air bags and eliminate the advantages of supplemental protection. Because the front seats are equipped with front air bags, the rear seat is always a better location for children. Take special care not to allow a child to lean over to or against the side window, even if the child is seated in a child-restraint system.

Never use one seat belt on more than one person at a time:

Using one seat belt for more than one person at a time is dangerous. A seat belt used in this way cannot spread the impact forces properly and the two passengers could be crushed together and seriously injured or even killed. Never use one belt for more than one person at a time and always operate the vehicle with each occupant properly restrained.



A seat belt or child-restraint system can become very hot in a closed vehicle during warm weather. To avoid burning yourself or a child, check them before you or your child touches them.

Child Restraint

NOTE

Your Mazda is equipped with ISOFIX/LATCH*¹ lower anchors for attachment of specially designed ISOFIX/LATCH*¹ child-restraint systems on the rear seats. When using these anchors to secure a child-restraint system, refer to "Using ISOFIX Lower Anchor (Mexico)/Using LATCH Lower Anchor (Except Mexico)" (page 2-50).

*¹ ISOFIX (Mexico)/LATCH (Except Mexico)

Child-Restraint System Installation

▼ Categories of Child-Restraint Systems

NOTE

When purchasing, ask the manufacturer of the child-restraint system which type of child-restraint system is appropriate for your child and vehicle.

(Mexico)

Child-restraint systems are classified into the following 5 groups according to the UN-R 44 regulation.

Group	Age	Weight	Size Classification/ Fixture (CRF)
0	Up to about 9 months old	Up to 10 kg (up to 22 lb)	ISO/L1
			ISO/L2
			ISO/R1
0+	Up to about 2 years old	Up to 13 kg (up to 29 lb)	ISO/R1
			ISO/R2
			ISO/R3
1	About 8 months to 4 years old	9 kg — 18 kg (20 lb — 40 lb)	ISO/R2
			ISO/R3
			ISO/F2
			ISO/F2X
2	About 3 to 7 years old	15 kg — 25 kg (33 lb — 55 lb)	ISO/F3
			—
3	About 6 to 12 years old	22 kg — 36 kg (48 lb — 79 lb)	—

(Except Mexico)

Please comply with the legal regulations concerning the use of child-restraint systems in your country.

▼ Child-Restraint System Types

In this owner's manual, explanation of child-restraint systems is provided for the following three types of popular child-restraint systems: infant seat, child seat, booster seat.

NOTE

- Installation position is determined by the type of child-restraint system. Always read the manufacturer's instructions and this owner's manual carefully.

Child Restraint

- Due to variations in the design of child-restraint systems, vehicle seats and seat belts, all child-restraint systems may not fit all seating positions. Before purchasing a child-restraint system, it should be tested in the specific vehicle seating position (or positions) where it is intended to be used. If a previously purchased child-restraint system does not fit, you may need to purchase a different one that will.

Infant seat

An infant seat provides restraint by bracing the infant's head, neck and back against the seating surface. Equal to Group 0 and 0+ of the UN-R 44 and UN-R 129 regulation.

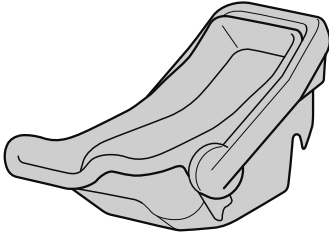

Child seat

A child seat restrains a child's body using the harness. Equal to Group 1 of the UN-R 44 and UN-R 129 regulation.



Booster seat

A booster seat is a child restraint accessory designed to improve the fit of the seat belt system around the child's body.

Equal to Group 2 and 3 of the UN-R 44 and UN-R 129 regulation.

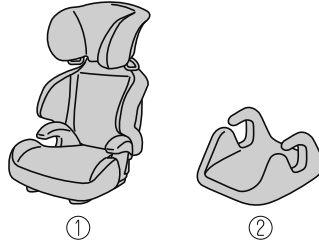

1. Full booster seat
2. Backless booster seat

When using a backless booster seat, always install the vehicle head restraint to the seat where the backless booster seat is installed.

Child-Restraint System Suitability for Various Seat Positions Table

▼ Child-Restraint System Suitability for Various Seat Positions Table

(Mexico)

Provided information in the table shows your child-restraint system suitability for various seating position. For installation suitability of other manufacturer child-restraint system, carefully consult the manufacturer's instructions which accompany the child-restraint system.

When installing a child-restraint system, the following points must be observed:

- Always remove the head restraint before installing a child-restraint system. However, when installing a backless booster seat, always install the vehicle head restraint to the seat where the backless booster seat is installed. In addition, always use a tether strap and attach it securely. Refer to Head Restraints on page 2-17.
- When installing a child-restraint system to the front passenger seat, adjust the seat slide position as far back as possible. Refer to Adjusting the Front Passenger's Seat on page 2-13.
- When it is difficult to install a child-restraint system to the front passenger seat, or the seat belt cannot be secured to the child-restraint system, perform the following operations to adjust the seat holding the child-restraint system so that the seat belt can be secured completely to it.
 - Move the seat forward or back.
 - Move the seatback forward or back.
 - Move the seat upward or downward. (Vehicles with height adjustment function)
- When installing a child-restraint system to the rear seat, adjust the front seat position so that the front seat does not contact the child-restraint system. Refer to Adjusting the Driver's Seat on page 2-5. Refer to Adjusting the Front Passenger's Seat on page 2-13.
- When installing a child-restraint system equipped with a tether, remove the head restraint. Refer to Head Restraints on page 2-17.
- An i-Size child-restraint system refers to a child-restraint system which has acquired i-Size category certification for the UN-R 129 regulation.

Child Restraint

When installing a child-restraint system to the rear seat, refer to the child-restraint system manufacturer's instructions and the Using ISOFIX Lower Anchor on page 2-50.

Seating position	Passenger	Rear (Left)	Rear (Center)	Rear (Right)
Seating position suitable for universal belted (Yes/No)	Yes (UF)	Yes (U)	Yes (U)	Yes (U)
i-Size seating position (Yes/No)	No	No	No	No
Largest suitable rearward facing fixture (R1)	No	Yes (IL)	No	Yes (IL)
Largest suitable rearward facing fixture (R2)	No	Yes (IL)	No	Yes (IL)
Largest suitable rearward facing fixture (R2X)	No	Yes (IL)	No	Yes (IL)
Largest suitable rearward facing fixture (R3)	No	Yes (IL)	No	Yes (IL)
Largest suitable forward facing fixture (F2)	No	Yes (IUF)	No	Yes (IUF)
Largest suitable forward facing fixture (F2X)	No	Yes (IUF)	No	Yes (IUF)
Largest suitable forward facing fixture (F3)	No	Yes (IUF)	No	Yes (IUF)
Largest suitable lateral facing fixture (L1)	No	No	No	No
Largest suitable lateral facing fixture (L2)	No	No	No	No
Largest suitable booster fixture (B2)	No	Yes (IUF)	No	Yes (IUF)
Largest suitable booster fixture (B3)	No	Yes (IUF)	No	Yes (IUF)

Seating position	Passenger	Rear (Left)	Rear (Center)	Rear (Right)
Non i-size compatible with a support leg (Yes/No)	Yes*1	Yes	No	Yes
Lower ISOFIX anchorages but without Top Tether (Yes/No)	No	No	No	No

U = Suitable for “universal” category restraints approved for use in this mass group.

UF = Suitable for forward-facing “universal” category restraints approved for use in this mass group.

IUF = Suitable for ISOFIX forward child restraints systems of universal category approved for use in the mass group.

L = Suitable for particular child restraints given on attached list. These restraints may be of the “specific vehicle”, “restricted” or “semi-universal” categories.

IL = Suitable for particular ISOFIX child restraint systems (CRS) given in the attached list. These ISOFIX CRS are those of the “specific vehicle”, “restricted” or “semi-universal” categories.

i-U = Suitable for i-Size “universal” Child Restraint Systems forward and rearward facing.

i-UF = Suitable for forward-facing i-Size “universal” Child Restraint Systems only.

Yes = Child-restraint system can be secured on the seat.

No = Child-restraint system cannot be secured on the seat, or there is no fixture.

X = Child-restraint system cannot be installed.

*1 Child restraint system can only be installed in the forward-facing position.

A Mazda genuine child-restraint system can be installed. Regarding child-restraint systems which can be installed, refer to the accessories catalog.

(Except Mexico)

- Regarding child-restraint systems which can be installed to your Mazda, consult an Authorized Mazda Dealer.
- A child-restraint system with a support leg cannot be installed on the rear center seat position.
- Please comply with the legal regulations concerning the use of child-restraint systems in your country.
- For the CRS which do not carry the ISO/XX size class identification (A to G), for the applicable mass group, the child seat manufacturer shall indicate the vehicle specific LATCH child-restraint systems recommended for each position.

Child Restraint

Installing Child-Restraint Systems

▼ Installing Child-Restraint Systems

Accident statistics reveal that a child is safer in the rear seat. The front passenger's seat is clearly the worst choice for any child under 12, and with rear-facing child-restraint systems it is clearly unsafe due to air bags.

NOTE

Even if your vehicle is equipped with front passenger occupant classification sensor (page 2-71), which automatically deactivates the front passenger air bag, a rear seat is the safest place for a child of any age or size.

Some child-restraint systems now come with tethers and therefore must be installed on the seats that take tethers to be effective. In your Mazda, tethered child-restraint systems can only be accommodated in the three positions on the rear seat.

Some child-restraint systems also employ specially designed ISOFIX/LATCH*1 attachments; refer to "Using ISOFIX Lower Anchor (Mexico)/Using LATCH Lower Anchor (Except Mexico)" (page 2-50).

*1 ISOFIX (Mexico)/LATCH (Except Mexico)

⚠ WARNING

Tethered Child-Restraint Systems Work Only on Tether-Equipped Rear Seats:

Installation of a tether equipped child-restraint system in the front passenger's seat defeats the safety design of the system and will result in an increased chance of serious injury if the child-restraint system goes forward without benefit of being tethered. Place tether equipped child-restraint systems where there are tether anchors.

▼ Anchor Bracket

Anchor brackets for securing child-restraint systems are equipped in the vehicle. Locate each anchor position using the illustration. To install a child-restraint system, remove the head restraint. Always follow the instruction manual accompanying the child-restraint system.

Anchor bracket location

Use the indicated anchor bracket locations when installing a child-restraint system equipped with a tether.

(4-Door)

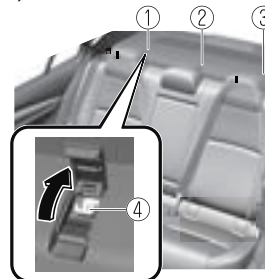

1. For right
2. For center (Except Mexico)
3. For left

4. Anchor bracket

(5-Door)

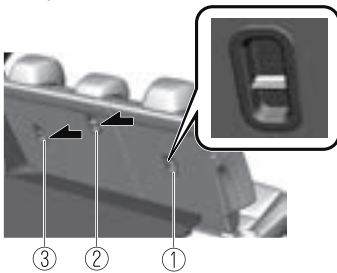

1. For right
2. For center (Except Mexico)
3. For left

WARNING

Always attach the tether strap to the correct tether anchor position:

Attaching the tether strap to the incorrect tether anchor position is dangerous. In a collision, the tether strap could come off and loosen the child-restraint system. If the child-restraint system moves it could result in death or injury to the child.

Always remove the head restraint and install child-restraint system:

Installing a child-restraint system without removing the head restraint is dangerous. The child-restraint system cannot be installed correctly which may result in death or injury to the child in a collision.

(4-Door)

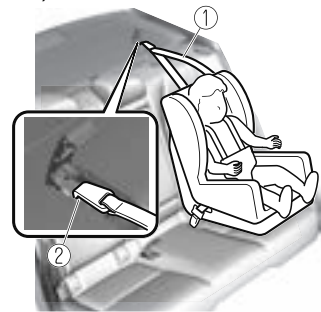

1. Tether strap
2. Anchor bracket

(5-Door)

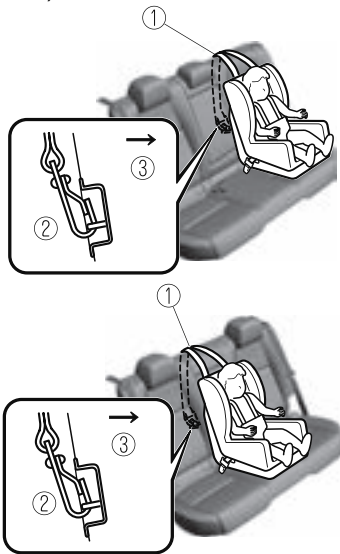

1. Tether strap
2. Anchor bracket
3. Forward

Always install the head restraint and adjust it to the appropriate position after removing the child-restraint system:

Driving with the head restraint removed is dangerous as impact to the occupant's head cannot be prevented during emergency braking or in a collision, which could result in a serious accident, injury or death. Refer to Head Restraints on page 2-17.

▼ Using Automatic Locking Mode (Except Mexico)

Follow these instructions when using a child-restraint system, unless you are attaching a LATCH-equipped child-restraint system to the rear LATCH lower anchors. Refer to "Using LATCH Lower Anchor" (page 2-50).

NOTE

Follow the child-restraint system manufacturer's instructions carefully. If you are not sure whether you have a LATCH system or tether, check in the child-restraint system manufacturer's instructions and follow them accordingly. Depending on the type of child-restraint system, it may use LATCH system instead of seat belts or if the belt goes across the child's chest, may recommend against using automatic locking mode.

1. Make sure the seatback is securely latched by pushing it back until it is fully locked.
2. Remove the head restraint. However, when installing a backless booster seat, always install the vehicle head restraint to the seat where the backless booster seat is installed. Refer to Head Restraints on page 2-17.
3. Secure the child-restraint system with the lap portion of the lap/shoulder belt. See the manufacturer's instructions on the child-restraint system for belt routing instructions.

4. To get the retractor into the automatic locking mode, pull the shoulder belt portion of the seat belt until the entire length of the belt is out of the retractor.



5. Push the child-restraint system firmly into the vehicle seat. Be sure the belt retracts as snugly as possible. A clicking noise from the retractor will be heard during retraction if the system is in the automatic locking mode. If the belt does not lock the seat down tight, repeat this step.



NOTE

- Inspect this function before each use of the child-restraint system. You should not be able to pull the shoulder belt out of the retractor while the system is in the automatic locking mode. When you remove the child-restraint system, be sure the belt fully retracts to return the system to emergency locking mode before occupants use the seat belts.
6. If your child-restraint system requires the use of a tether strap, refer to the manufacturer's instructions to hook and tighten the tether strap.

WARNING

Use the tether and tether anchor only for a child-restraint system:

Using the tether or tether anchor to secure anything but a child-restraint system is dangerous. This could weaken or damage the tether or tether anchor and result in injury.

Always remove the head restraint and install child-restraint system (except when installing a backless booster seat):

Installing a child-restraint system without removing the head restraint is dangerous. The child-restraint system cannot be installed correctly which may result in death or injury to the child in a collision.

(4-Door)

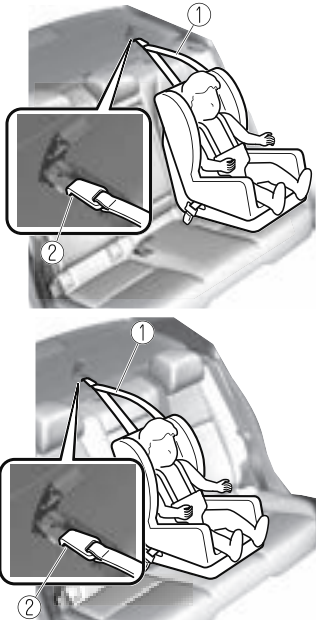

- 1. Tether strap
- 2. Anchor bracket

(5-Door)

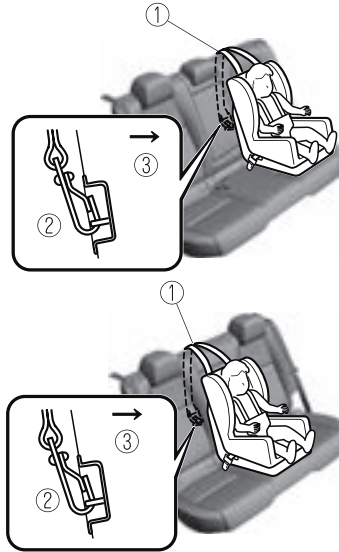

- 1. Tether strap
- 2. Anchor bracket
- 3. Forward

Always attach the tether strap to the correct tether anchor position:

Attaching the tether strap to the incorrect tether anchor position is dangerous. In a collision, the tether strap could come off and loosen the child-restraint system. If the child-restraint system moves it could result in death or injury to the child.

Always install the head restraint and adjust it to the appropriate position after removing the child-restraint system:

Driving with the head restraint removed is dangerous as impact to the occupant's head cannot be prevented during emergency braking or in a collision, which could result in a serious accident, injury or death. Refer to Head Restraints on page 2-17.

▼ If You Must Use the Front Seat for Children

If you cannot put all children in the rear seat, at least put the smallest children in the rear and be sure the largest child up front uses the shoulder belt over the shoulder.

NEVER put a rear-facing child-restraint system on the front passenger seat whether your vehicle is equipped with an occupant classification sensor or not.

This seat is also not set up for tethered child-restraint systems, put them in one of the rear seat positions set up with tether anchors.

Likewise the ISOFIX/LATCH¹ child-restraint system cannot be secured in the front passenger's seat and should be used in the rear seat.

Do not allow anyone to sleep against the side window since your vehicle has side and curtain air bags, it could cause serious injuries to an out of position occupant. As children more often sleep in cars, it is better to put them in the rear seat. If installing the child-restraint system on the front seat is unavoidable, follow these instructions when using a front-facing child-restraint system in the front passenger's seat.

¹ ISOFIX (Mexico)/LATCH (Except Mexico)

NOTE

- To check if your front seats have side air bags:
Mazda vehicles equipped with side air bag will have a "SRS AIRBAG" tag on the outboard shoulder of the front seats.

- To check if your vehicle has curtain air bags:

Mazda vehicles equipped with curtain air bag will have an "SRS AIRBAG" marking on the window pillars along the roof edge.



Always move the front passenger seat as far back as possible if installing a front-facing child-restraint system on it is unavoidable:

As your vehicle has front air bags and doubly so because your vehicle has side air bags, a front-facing child-restraint system should be put on the front passenger seat only when it is unavoidable.

Even if the front passenger air bag deactivation indicator light illuminates, always move the seat as far back as possible, because the force of a deploying air bag could cause serious injury or death to the child.

Never use a rear-facing child-restraint system in the front seat with an air bag that could deploy:

Rear-facing child-restraint systems on the front seat are particularly dangerous.

Even in a moderate collision, the child-restraint system can be hit by a deploying air bag and moved violently backward resulting in serious injury or death to the child. Even though you may feel assured that the front passenger air bag will not deploy based on the fact that the front passenger air bag deactivation indicator light illuminates, you should not use a rear-facing child-restraint system in the front seat.

Child Restraint

Do not allow a child or anyone to lean over to or against the side window of a vehicle with side and curtain air bags:

It is dangerous to allow anyone to lean over to or against the side window, the area of the front passenger seat, the front and rear window pillars and the roof edge along both sides from which the side and curtain air bags deploy, even if a child-restraint system is used. The impact of inflation from a side or curtain air bag could cause serious injury or death to an out of position child. Furthermore, leaning over to or against the door could block the side and curtain air bags and eliminate the advantages of supplemental protection. Because the front seats are equipped with front air bags, the rear seat is always a better location for children. Take special care not to allow a child to lean over to or against the side window, even if the child is seated in a child-restraint system.

Always remove the head restraint and install child-restraint system (except when installing a backless booster seat):

Installing a child-restraint system without removing the head restraint is dangerous. The child-restraint system cannot be installed correctly which may result in death or injury to the child in a collision.

Always install the head restraint and adjust it to the appropriate position after removing the child-restraint system:

Driving with the head restraint removed is dangerous as impact to the occupant's head cannot be prevented during emergency braking or in a collision, which could result in a serious accident, injury or death. Refer to Head Restraints on page 2-17.

Front Passenger's Seat Child-Restraint System Installation (With Front Passenger Occupant Classification System)

1. Make sure the ignition is switched off.
2. Slide the seat as far back as possible.

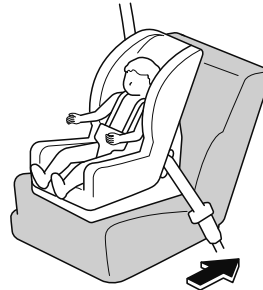

3. Remove the head restraint. However, when installing a backless booster seat, always install the vehicle head restraint to the seat where the backless booster seat is installed.
4. Place the child-restraint system on the seat without putting your weight on the seat and fasten the seat belt. See the manufacturer's instructions on the child-restraint system for belt routing instructions.

5. To get the retractor into the automatic locking mode, pull the shoulder belt portion of the seat belt until the entire length of the belt is out of the retractor.
6. Push the child-restraint system firmly into the vehicle seat. Be sure the belt retracts as snugly as possible. A clicking noise from the retractor will be heard during retraction if the system is in automatic locking mode. If the belt does not lock the seat down tight, repeat the previous step and also this one.

NOTE

- Inspect this function before each use of the child-restraint system. You should not be able to pull the shoulder belt out of the retractor while the system is in the automatic locking mode. When you remove the child-restraint system, be sure the belt fully retracts to return the system to emergency locking mode before occupants use the seat belts.
 - Follow the child-restraint system manufacturer's instructions carefully. Depending on the type of child-restraint system, it may not employ seat belts which are in automatic locking mode.
7. Seat your child safely in the child-restraint system and secure the child according to the instructions from the child-restraint system manufacturer.

8. Switch the ignition ON and make sure the front passenger air bag deactivation indicator light illuminates after installing a child-restraint system on the front passenger seat. If the front passenger air bag deactivation indicator light does not illuminate, remove the child-restraint system, switch the ignition to OFF, and then re-install the child-restraint system (page 2-71).



Child Restraint

WARNING

Do not seat a child in a child-restraint system on the front passenger seat if the front passenger air bag deactivation indicator light does not illuminate:

While it is always better to install any child-restraint system on the rear seat, it is imperative that a child-restraint system **ONLY** be used on the front passenger seat if the deactivation indicator light illuminates when the child is seated in the child-restraint system (page 2-71). Seating a child in a child-restraint system installed on the front passenger seat with the front passenger air bag deactivation indicator light not illuminated is dangerous. If this indicator light does not illuminate, this means that the front passenger front and side air bags, and knee air bags, and seat belt pretensioners are ready for deployment. If an accident were to deploy an air bag, a child in a child-restraint system sitting in the front passenger seat could be seriously injured or killed. If the indicator light does not illuminate after seating a child in a child-restraint system on the front passenger seat, seat a child in a child-restraint system on the rear seat and consult an Authorized Mazda Dealer as soon as possible.

▼ **Using ISOFIX Lower Anchor (Mexico)/Using LATCH Lower Anchor (Except Mexico)**

Your Mazda is equipped with ISOFIX/LATCH*1 lower anchors for attachment of specially designed ISOFIX/LATCH*1 child-restraint systems in the rear seats. Both anchors must be used, otherwise the seat will bounce around and put the child in danger. Most ISOFIX/LATCH*1 child-restraint systems must also be used in conjunction with a tether to be effective. If they have a tether you must use it to better assure your child's safety.

WARNING

Follow the manufacturer's instructions for the use of the child-restraint system:

An unsecured child-restraint system is dangerous. In a sudden stop or a collision it could move causing serious injury or death to the child or other occupants. Make sure the child-restraint system is properly secured in place according to the child-restraint system manufacturer's instructions.

Never attach two child-restraint systems to the same ISOFIX/LATCH*¹ lower anchor:

Attaching two child-restraint systems to the same ISOFIX/LATCH*¹ lower anchor is dangerous. In a collision, one anchor may not be strong enough to hold two child-restraint system attachments, and it may break, causing serious injury or death. If you use the seat position for another child-restraint system when an outboard ISOFIX/LATCH*¹ position is occupied, use the center seat belts instead, and the tether if tether-equipped.

Make sure the child-restraint system is properly secured:

An unsecured child-restraint system is dangerous. In a sudden stop or a collision it could move causing serious injury or death to the child or other occupants. Follow the child-restraint system manufacturer's instructions on belt routing to secure the seat just as you would with a child in it so that nobody is tempted to put a child in an improperly secured seat later on. When not in use, remove it from the vehicle or fasten it with a seat belt, or attach it to BOTH ISOFIX/LATCH*¹ lower anchors for ISOFIX/LATCH*¹ child-restraint systems.

Make sure there are no seat belts or foreign objects near or around the ISOFIX/LATCH*¹ child-restraint system:

Not following the child-restraint system manufacturer's instructions when installing the child-restraint system is dangerous. If seat belts or a foreign object prevent the child-restraint system from being securely attached to the ISOFIX/LATCH*¹ lower anchors and the child-restraint system is installed improperly, the child-restraint system could move in a sudden stop or collision causing serious injury or death to the child or other occupants. When installing the child-restraint system, make sure there are no seat belts or foreign objects near or around the ISOFIX/LATCH*¹ lower anchors. Always follow the child-restraint system manufacturer's instructions.

*¹ ISOFIX (Mexico)/LATCH (Except Mexico)

Installation on rear outboard seats

1. First, adjust the front seat to allow clearance between the child-restraint system and the front seat.
Refer to Adjusting the Driver's Seat on page 2-5.
Refer to Adjusting the Front Passenger's Seat on page 2-13.
2. Make sure the seatback is securely latched by pushing it back until it is fully locked.

3. Remove the cover of the child-restraint system's ISOFIX/LATCH*1 lower anchors to verify the locations of the ISOFIX/LATCH*1 lower anchors.

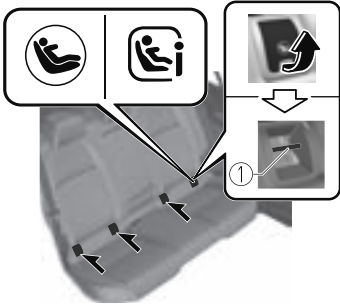

1. Lower anchor

NOTE

- The ISOFIX/LATCH*1 lower anchors marking on the cover indicates the position of the ISOFIX/LATCH*1 lower anchors for the attachment of a child-restraint system.
 - Store the removed cover so that it does not get lost.
4. Remove the head restraint. However, when installing a backless booster seat, always install the vehicle head restraint to the seat where the backless booster seat is installed. Refer to Head Restraints on page 2-17.
 5. Secure the child-restraint system using BOTH ISOFIX/LATCH*1 lower anchors, following the child-restraint system manufacturer's instruction. Pull on the child-restraint to be sure both anchors are engaged.

6. If your child-restraint system came equipped with a tether, that means it is very important to properly secure the tether for child safety. Please carefully follow the child-restraint system manufacturer's instructions when installing tethers.

*1 ISOFIX (Mexico)/LATCH (Except Mexico)

⚠ WARNING

Use the tether and tether anchor only for a child-restraint system:

Using the tether or tether anchor to secure anything but a child-restraint system is dangerous. This could weaken or damage the tether or tether anchor and result in injury.

Always remove the head restraint and install child-restraint system (except when installing a backless booster seat):

Installing a child-restraint system without removing the head restraint is dangerous. The child-restraint system cannot be installed correctly which may result in death or injury to the child in a collision.

(4-Door)

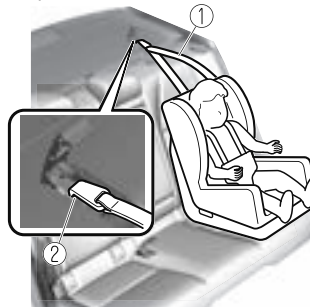

1. Tether strap

2. Anchor bracket

(5-Door)

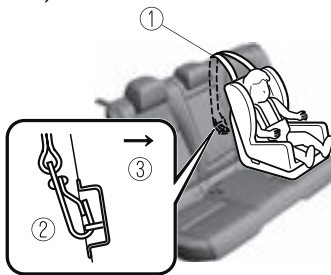

1. Tether strap
2. Anchor bracket
3. Forward

Always attach the tether strap to the correct tether anchor position:

Attaching the tether strap to the incorrect tether anchor position is dangerous. In a collision, the tether strap could come off and loosen the child-restraint system. If the child-restraint system moves it could result in death or injury to the child.

Always install the head restraint and adjust it to the appropriate position after removing the child-restraint system:

Driving with the head restraint removed is dangerous as impact to the occupant's head cannot be prevented during emergency braking or in a collision, which could result in a serious accident, injury or death. Refer to Head Restraints on page 2-17.

Installation on rear center seat

The ISOFIX/LATCH*¹ lower anchors at the center of the rear seat are much further apart than the sets of ISOFIX/LATCH*¹ lower anchors for child-restraint system installation at other seating positions. Child-restraint systems with rigid ISOFIX/LATCH*¹ attachments cannot be installed on the center seating position. Some ISOFIX/LATCH*¹ equipped child-restraint systems can be placed in the center position and will reach the nearest ISOFIX/LATCH*¹ lower anchors which are 434 mm (17.1 in) apart. ISOFIX/LATCH*¹ compatible child-restraint systems (with attachments on belt webbing) can be used at this seating position only if the child-restraint system manufacturer's instructions state that the child-restraint system can be installed to ISOFIX/LATCH*¹ lower anchors that are 434 mm (17.1 in) apart. Do not attach two child-restraint systems to the same ISOFIX/LATCH*¹ lower anchor. If your child-restraint system has a tether, it must also be used for your child's optimum safety.

The procedure is the same as the installation for the rear outboard seats.

*¹ ISOFIX (Mexico)/LATCH (Except Mexico)

ISOFIX/LATCH*¹ lower anchor location



⚠ WARNING

Always remove the head restraint and install child-restraint system (except when installing a backless booster seat):

Installing a child-restraint system without removing the head restraint is dangerous. The child-restraint system cannot be installed correctly which may result in death or injury to the child in a collision.

(4-Door)



- 1. Tether strap
- 2. Anchor bracket

(5-Door)

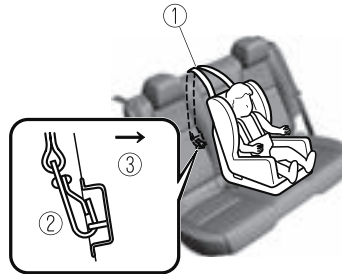

- 1. Tether strap
- 2. Anchor bracket
- 3. Forward

Always attach the tether strap to the correct tether anchor position:

Attaching the tether strap to the incorrect tether anchor position is dangerous. In a collision, the tether strap could come off and loosen the child-restraint system. If the child-restraint system moves it could result in death or injury to the child.

Always install the head restraint and adjust it to the appropriate position after removing the child-restraint system:

Driving with the head restraint removed is dangerous as impact to the occupant's head cannot be prevented during emergency braking or in a collision, which could result in a serious accident, injury or death. Refer to Head Restraints on page 2-17.

*1 ISOFIX (Mexico)/LATCH (Except Mexico)

Supplemental Restraint System (SRS) Precautions

▼ Supplemental Restraint System (SRS) Precautions

The front and side supplemental restraint systems (SRS) include different types of air bags. **Please verify the different types of air bags which are equipped on your vehicle by locating the “SRS AIRBAG” location indicators.** These indicators are visible in the area where the air bags are installed. The air bags are installed in the following locations:

- The steering wheel hub (driver air bag)
- The front passenger dashboard (front passenger air bag)
- Under the instrument panel (driver and front passenger* knee air bags)
- The outboard sides of the front seatbacks (side air bags)
- The front and rear window pillars, and the roof edge along both sides (curtain air bags)

Vehicles with the Front Passenger Occupant Classification System have a sensor which detects an impending roll-over accident.

The air bag supplemental restraint systems are designed to provide supplemental protection in certain situations so seat belts are always important in the following ways:

Without seat belt usage, the air bags cannot provide adequate protection during an accident. Seat belt usage is necessary to:

- Keep the occupant from being thrown into an inflating air bag.
- Reduce the possibility of injuries during an accident that is not designed for air bag inflation, such as rear impact.
- Reduce the possibility of injuries in frontal, near frontal or side collisions or roll-over accidents that are not severe enough to activate the air bags.
- Reduce the possibility of being thrown from your vehicle.
- Reduce the possibility of injuries to lower body and legs during an accident because the air bags provide no protection to these parts of the body.
- Hold the driver in a position which allows better control of the vehicle.

SRS Air Bags

If your vehicle is also equipped with a front passenger occupant classification system, refer to the **Front Passenger Occupant Classification System (page 2-70)** for details.

If your vehicle is equipped with a front passenger occupant classification system, the front passenger air bag deactivation indicator light illuminates for a specified time after the ignition is switched ON.



Small children must be protected by a child-restraint system as stipulated by law in every state and province. In certain states and provinces, larger children must use a child-restraint system (page 2-32).

Carefully consider which child-restraint system is necessary for your child and follow the installation directions in this Owner's Manual as well as the child-restraint system manufacturer's instructions.

WARNING

Seat belts must be worn in air bag equipped vehicles:

Depending only on the air bags for protection during an accident is dangerous. Alone, air bags may not prevent serious injuries. The appropriate air bags can be expected to inflate only in the first accident, such as frontal, near frontal or side collisions or roll-over accidents that are at least moderate. Vehicle occupants should always wear seat belts.

Children should not ride in the front passenger seat:

Placing a child, 12 years or under, in the front seat is dangerous. The child could be hit by a deploying air bag and be seriously injured or even killed. A sleeping child is more likely to lean against the door and be hit by the side air bag in moderate collision to the front-passenger side of the vehicle. Whenever possible, always secure a child 12 years and under on the rear seats with an appropriate child-restraint system for the child's age and size.

Never use a rear-facing child-restraint system in the front seat with an air bag that could deploy:

Rear-facing child-restraint systems on the front seat are particularly dangerous even though you may feel assured that a front passenger air bag will not deploy based on the fact that the front passenger air bag deactivation indicator light illuminates. The child-restraint system can be hit by a deploying air bag and moved violently backward resulting in serious injury or death to the child.



Do not sit too close to the driver and front passenger air bags:

Sitting too close to the driver and front passenger air bag modules or placing hands or feet on them is extremely dangerous. The driver and front passenger air bags inflate with great force and speed. Serious injuries could occur if someone is too close. The driver should always hold onto only the rim of the steering wheel. The front seat passenger should keep both feet on the floor. Front seat occupants should adjust their seats as far back as possible and always sit upright against the seatbacks with seat belts worn properly.

Sit in the center of the seat and wear seat belts properly:

Sitting too close to the side air bag modules or placing hands on them, or sleeping up against the door or hanging out the windows is extremely dangerous. The side and curtain air bags inflate with great force and speed directly expanding along the door on the side the car is hit. Serious injury could occur if someone is sitting too close to the door or leaning against a window, or if rear seat occupants grab the sides of the front seatbacks. Give the side and curtain air bags room to work by sitting in the center of the seat while the vehicle is moving with seat belts worn properly.

Do not attach objects on or around the area where air bags deploy:

Attaching objects to the air bags or placing something in the area where the air bags deploy is dangerous. In an accident, an object could interfere with air bag inflation and injure the occupants. Furthermore, the bag could be damaged causing gases to release. Always keep the deployment area of the air bag modules free of any obstructions.

For example, you should not do any of the following as it may interfere with air bag deployment.

- Do not put a covering on or lean anything against areas such as the dashboard and lower portion of the instrument panel that blocks the passenger front air bag and knee air bags.
- Do not use seat covers on the front seats and rear seats equipped with in-seat side air bags.
- Do not hang any backpacks, bags or pouches that cover the sides of the seats that block the side air bags.

SRS Air Bags

- Do not place any objects on the assist grips. Only hang clothes directly on the coat hooks.

Do not touch the components of the supplemental restraint system after the air bags have inflated:

Touching the components of the supplemental restraint system after the air bags have inflated is dangerous. Immediately after inflation, they are very hot. You could get burned.

Never install any front-end equipment to your vehicle:

Installation of front-end equipment, such as frontal protection bar (kangaroo bar, bull bar, push bar, or other similar devices), snowplow, or winches, is dangerous. The air bag crash sensor system could be affected. This could cause air bags to inflate unexpectedly, or it could prevent the air bags from inflating during an accident. Front occupants could be seriously injured.

Do not modify the suspension:

Modifying the vehicle suspension is dangerous. If the vehicle's height or the suspension is modified, the vehicle will be unable to accurately detect a collision or roll-over accident resulting in incorrect or unexpected air bag deployment and the possibility of serious injuries.

To prevent false detection by the air bag sensor system, heed the following:

- Do not use tires or wheels other than those specified for your Mazda: Use of any tire or wheel other than those specified for your Mazda (page 9-10) is dangerous. Use of such wheels will prevent the vehicle's accident detections system from accurately detecting a collision or roll-over accident resulting in incorrect or unexpected air bag deployment and the possibility of serious injuries.
- Do not overload your vehicle: Overloading your vehicle is dangerous as it could prevent the air bag crash sensor system from accurately detecting a collision or roll-over accident resulting in incorrect or unexpected air bag deployment and the possibility of serious injuries. The gross axle weight rating (GAWR) and the gross vehicle weight rating (GVWR) for your vehicle are on the Motor Vehicle Safety Standard Label on the driver's door frame. Do not exceed these ratings.
- Do not drive the vehicle off-road: Driving your Mazda off-road is dangerous because the vehicle has not been designed to do so. Driving the vehicle off-road could prevent the air bag crash sensor system from accurately detecting a collision or roll-over accident resulting in incorrect or unexpected air bag deployment and the possibility of serious injuries.

Do not modify a front door or leave any damage unrepaired. Always have an Authorized Mazda Dealer inspect a damaged front door:

Modifying a front door or leaving any damage unrepaired is dangerous. Each front door has a side crash sensor as a component of the supplemental restraint system. If holes are drilled in a front door, a door speaker is left removed, or a damaged door is left unrepaired, the sensor could be adversely affected causing it to not detect the pressure of an impact correctly during a side collision. If a sensor does not detect a side impact correctly, the side and curtain air bags and the front seat belt pretensioner may not operate normally which could result in serious injury to occupants.

Do not modify the supplemental restraint system:

Modifying the components or wiring of the supplemental restraint system is dangerous. You could accidentally activate it or make it inoperable. Do not make any modifications to the supplemental restraint system. This includes installing trim, badges, or anything else over the air bag modules. It also includes installing extra electrical equipment on or near system components or wiring. An Authorized Mazda Dealer can provide the special care needed in the removal and installation of front seats. It is important to protect the air bag wiring and connections to assure that the bags do not accidentally deploy, and that the front passenger occupant classification system and the seats retain an undamaged air bag connection.

Do not place luggage or other objects under the front seats:

Placing luggage or other objects under the front seats is dangerous. The components essential to the supplemental restraint system could be damaged, and in the event of a side collision, the appropriate air bags may not deploy, which could result in death or serious injury. To prevent damage to the components essential to the supplemental restraint system, do not place luggage or other objects under the front seats.

Do not operate a vehicle with damaged air bag/seat belt pretensioner system components:

Expend or damaged air bag/seat belt pretensioner system components must be replaced after any collision which caused them to deploy or damage them. Only a trained Authorized Mazda Dealer can fully evaluate these systems to see that they will work in any subsequent accident. Driving with an expended or damaged air bag or pretensioner unit will not afford you the necessary protection in the event of any subsequent accident which could result in serious injury or death.

Do not remove interior air bag parts:

Removing any components such as the front seats, front dashboard, the steering wheel or parts on the front and rear window pillars and along the roof edge, containing air bag parts or sensors is dangerous. These parts contain essential air bag components. The air bag could accidentally activate and cause serious injuries. Always have an Authorized Mazda Dealer remove these parts.

SRS Air Bags

Properly dispose of the air bag system:

Improper disposal of an air bag or a vehicle with live air bags in it can be extremely dangerous. Unless all safety procedures are followed, injury could result. Have an Authorized Mazda Dealer safely dispose of the air bag system or scrap an air bag equipped vehicle.

NOTE

- If it becomes necessary to have the components or wiring system for the supplementary restraint system modified to accommodate a person with certain medical conditions in accordance with a certified physician, contact an Authorized Mazda Dealer, refer to "Customer Assistance (U.S.A.)" (page 8-2).
- When an air bag deploys, a loud inflation noise can be heard and some smoke will be released. Neither is likely to cause injury, however, the texture of the air bags may cause light skin injuries on body parts not covered with clothing through friction.
- Should you sell your Mazda, we urge you to tell the new owner of its air bag systems and that familiarization with all instructions about them, from the Owner's Manual, is important.

- This highly-visible label is displayed which warns against the use of a rear-facing child-restraint system on the front passenger seat.

(Mexico)



(Except Mexico)



Supplemental Restraint System Components

▼ Supplemental Restraint System Components

(With Front Passenger Occupant Classification System)

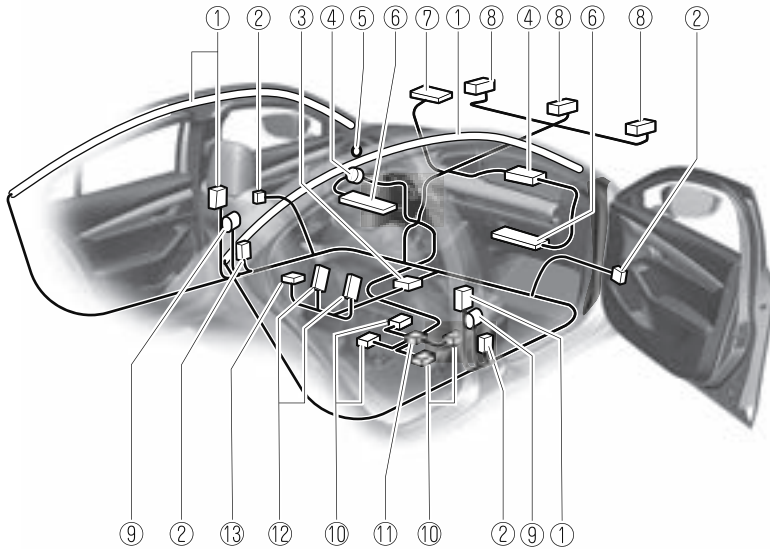

1. Side and curtain inflators and air bags
2. Side crash sensors
3. Roll-over sensor, crash sensors, and diagnostic module (SAS unit)
4. Driver/Front passenger inflators and air bags
5. Air bag/front seat belt pretensioner system warning indication/warning light (page 7-32)
6. Driver/Front passenger knee inflators and air bags
7. Front passenger air bag deactivation indicator light (page 2-71)
8. Front air bag sensors
9. Seat belt pretensioners (page 2-28)
10. Front passenger seat weight sensors (page 2-71)
11. Front passenger seat weight sensor control module
12. Driver and front passenger seat belt buckle switches (page 2-75)
13. Driver seat slide position sensor (page 2-70)

(Without Front Passenger Occupant Classification System)

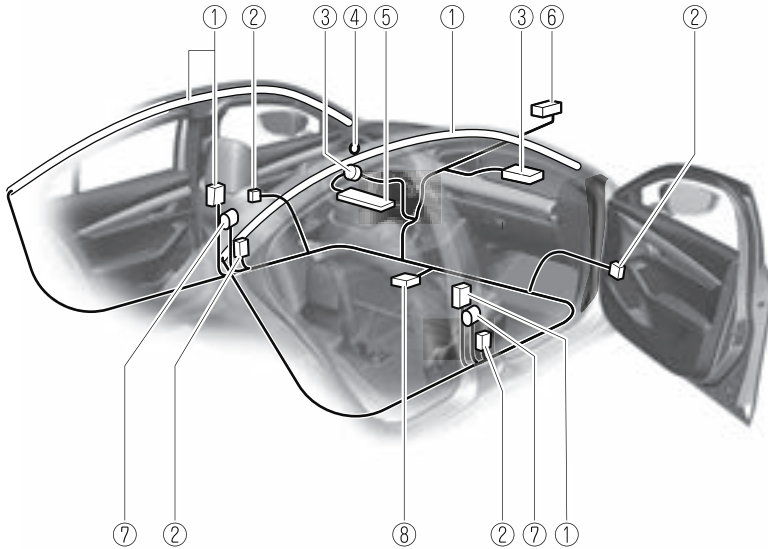

- 1. Side and curtain inflators and air bags
- 2. Side crash sensors
- 3. Driver/Front passenger inflators and air bags
- 4. Air bag/
front seat belt pretensioner system warning indication
/warning light (page 7-32)
- 5. Driver knee inflator and air bag
- 6. Front air bag sensor
- 7. Seat belt pretensioners (page 2-28)
- 8. Crash sensors, and diagnostic module (SAS unit)

How the SRS Air Bags Work

▼ How the SRS Air Bags Work

Your Mazda is equipped with the following types of SRS air bags. SRS air bags are designed to work together with the seat belts to help to reduce injuries during an accident.

The SRS air bags are designed to provide further protection for passengers in addition to the seat belt functions. Be sure to wear seat belts properly.

▼ Front Seat Belt Pretensioners

The front seat belt pretensioners are designed to deploy in moderate or severe frontal, near frontal collisions. In addition, the pretensioners operate when a side collision or a roll-over accident is detected. The pretensioners operate differently depending on what types of air bags are equipped. For more details about seat belt pretensioner operation, refer to the SRS Air Bag Deployment Criteria (page 2-67).

▼ Driver Air Bag

The driver's air bag is mounted in the steering wheel.

When air bag crash sensors detect a frontal impact of greater than moderate force, the driver's air bag inflates quickly helping to reduce injury mainly to the driver's head or chest caused by directly hitting the steering wheel.

For more details about air bag deployment, refer to "SRS Air Bag Deployment Criteria" (page 2-67).

(With Front Passenger Occupant Classification System)

The driver's dual-stage air bag controls air bag inflation in two energy stages. During an impact of moderate severity, the driver's air bag deploys with lesser energy, whereas during more severe impacts, it deploys with more energy.

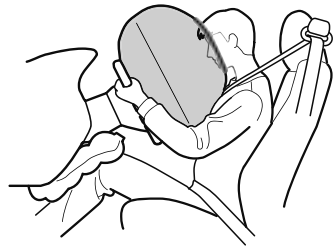

SRS Air Bags

▼ Front Passenger Air Bag

The front passenger air bag is mounted in the front passenger dashboard. The inflation mechanism for the front passenger air bag is the same as the driver's air bag.

For more details about air bag deployment, refer to "SRS Air Bag Deployment Criteria" (page 2-67).

(With Front Passenger Occupant Classification System)

In addition, the front passenger air bag is designed to only deploy in accordance with the total seated weight on the front passenger seat. For details, refer to the front passenger occupant classification system (page 2-70).

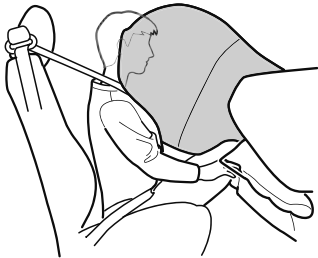

▼ Driver and Front Passenger Knee Air Bags*

The knee air bags are equipped under the instrument panel.

If the air bag crash sensors receive a frontal impact of greater than moderate force, the knee air bags deploy immediately to reduce impact to the driver and front passenger's legs.

For more details about air bag deployment, refer to "SRS Air Bag Deployment Criteria" (page 2-67).

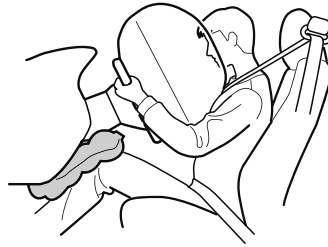

▼ Side Air Bags

The side air bags are mounted in the outboard sides of the front seatbacks. When the air bag crash sensors detect a side impact of greater than moderate force, the system inflates the side air bag only on the side in which the vehicle was hit. The side air bag inflates quickly to reduce injury to the driver or front passenger's chest caused by directly hitting interior parts such as a door or window.

For more details about air bag deployment, refer to "SRS Air Bag Deployment Criteria" (page 2-67).

(With Front Passenger Occupant Classification System)

In addition, the front passenger side air bag is designed to only deploy in accordance with the total seated weight on the front passenger seat. For details, refer to the front passenger occupant classification system (page 2-70).

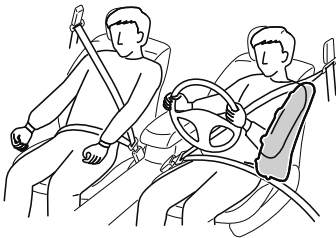

▼ Curtain Air Bags

The curtain air bags are mounted in the front and rear window pillars, and the roof edge along both sides.

When the air bag crash sensors detect a side impact of greater than moderate force, the curtain air bag inflates quickly and helps to reduce injury mainly to the driver and front and rear outboard passengers' heads caused by directly hitting interior parts such as a door or window.

For more details about air bag deployment, refer to "SRS Air Bag Deployment Criteria" (page 2-67).

In a side impact:

Greater than moderate impact to one side of the vehicle will cause the curtain air bag on that side only to inflate.

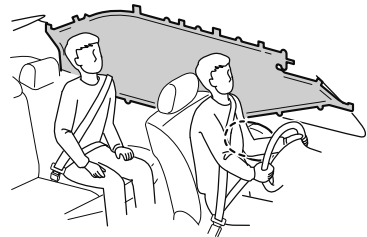

Only one side curtain air bag will deploy on the side of the vehicle that receives the force of an impact.

SRS Air Bags

(With Front Passenger Occupant Classification System)

In a roll-over:

In response to a vehicle roll-over, both curtain air bags inflate.

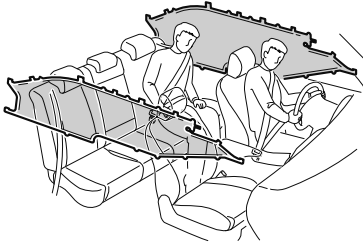

Both curtain air bags will deploy after the roll-over accident is detected.





▼ Warning Light/Beep

A system malfunction or operation conditions are indicated by a warning. Refer to Air Bag/Front Seat Belt Pretensioner System Warning Indication/Warning Light on page 7-32.

SRS Air Bag Deployment Criteria

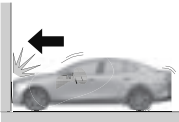
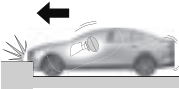
▼ SRS Air Bag Deployment Criteria

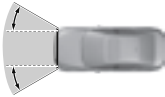
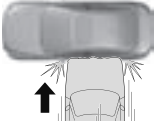
This chart indicates the applicable SRS equipment that will deploy depending on the type of collision.
 (The illustrations are the representative cases of collisions.)

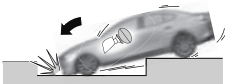
SRS equip- ment	Types of collision			
	A severe frontal/near frontal collision	A severe side collision	A roll-over/near roll-over ²	A rear collision
	 			
	 			
				

SRS Air Bags

SRS equipment	Types of collision			
	A severe frontal/near frontal collision	A severe side collision	A roll-over/near roll-over ²	A rear collision
Front seat belt pretensioner	X ¹	X ¹	X ¹	No air bag and front seat belt pretensioner will be activated in a rear collision.
Driver air bag	X	—	—	
Front passenger air bag	X ¹	—	—	
Knee air bag	X ¹	—	—	
Side air bag	—	X ¹ (impact side only)	—	
Curtain air bag	—	X (impact side only)	X (both sides)	

X: The SRS air bag equipment deploys in a collision.

—: The SRS air bag equipment does not deploy in a collision.

¹ **(With Front Passenger Occupant Classification System)**

The front passenger front and side air bags, seat belt pretensioner and knee air bag are designed to deploy depending on the condition of the total seated weight on the front passenger seat.

² **(With Front Passenger Occupant Classification System)**

In a roll-over accident, the seat belt pretensioners and the curtain air bags deploy.

NOTE

In a frontal offset collision, the equipped air bags and pretensioners may all deploy depending on the direction, angle, and rate of impact.

Limitations to SRS Air Bag

▼ Limitations to SRS Air Bag

In severe collisions such as those described previously in "SRS Air Bag Deployment Criteria", the applicable SRS air bag equipment will deploy. However, in some accidents, the equipment may not deploy depending on the type of collision and its severity.

Limitations to front/near front collision detection:

The following illustrations are examples of front/near front collisions that may not be detected as severe enough to deploy the SRS air bag equipment.

Impacts involving trees or poles

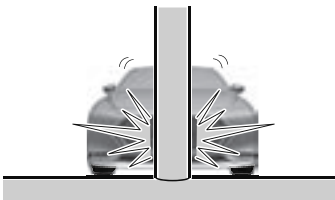

Frontal offset impact to the vehicle



Rear-ending or running under a truck's tail gate

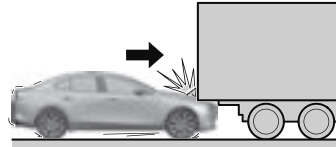

Limitations to side collision detection:

The following illustrations are examples of side collisions that may not be detected as severe enough to deploy the SRS air bag equipment.

Side impacts involving trees or poles



Side impacts with two-wheeled vehicles

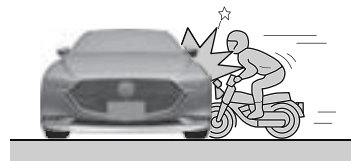

Roll-over (Without Front Passenger Occupant Classification System)

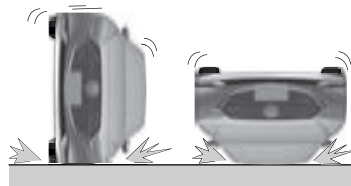

**Limitations to roll-over detection
(With Front Passenger Occupant
Classification System):**

The following illustration is an example of an accident that may not be detected as a roll-over accident. Therefore, the front seat belt pretensioners and curtain air bags may not deploy.

Pitch end over end

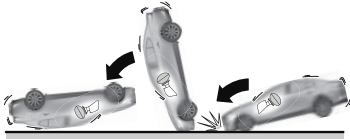

**Driver and Front
Passenger Occupant
Classification System***

**▼ Driver and Front Passenger
Occupant Classification System**

First, please read "Supplemental Restraint System (SRS) Precautions" (page 2-55) carefully.

▼ Driver Seat Slide Position Sensor

Your vehicle is equipped with a driver seat slide position sensor as a part of the supplemental restraint system. The sensor is located under the driver seat. The sensor determines whether the driver seat is fore or aft of a reference position and sends the seat position to the diagnostic module (SAS unit). The SAS unit is designed to control the deployment of the driver air bag depending on how close the driver seat is to the steering wheel. The air bag/front seat belt pretensioner system warning light flashes if the sensor has a possible malfunction (page 2-66).

▼ Front Passenger Seat Weight Sensors

Your vehicle is equipped with a front passenger seat weight sensors as a part of the supplemental restraint system. These sensors are located under both of the front passenger seat rails. These sensors determine the total seated weight on the front passenger seat and monitor the seat belt buckle for the front passenger seat. The SAS unit is designed to prevent the front passenger front and side air bags and knee air bags, and seat belt pretensioner system from deploying if the front passenger air bag deactivation indicator light illuminates. To reduce the chance of injuries caused by deployment of the front passenger air bag, the system deactivates the front passenger front and side air bags and knee air bags, and also the seat belt pretensioner system when the front passenger air bag deactivation indicator light illuminates. Refer to the following table for the front passenger air bag deactivation indicator light illumination conditions.

This system shuts off the front passenger front and side air bags and knee air bags, and seat belt pretensioner system, so make sure the front passenger air bag deactivation indicator light illuminates according to the following table.

The air bag/front seat belt pretensioner system warning light flashes and the front passenger air bag deactivation indicator light illuminates if the sensors have a possible malfunction. If this happens, the front passenger front and side air bags and knee air bags, and seat belt pretensioner system will not deploy.

Front passenger air bag deactivation indicator light

This indicator light illuminates to remind you that the front passenger front and side air bags and knee air bags, and seat belt pretensioners will not deploy during a collision.



SRS Air Bags

If the front passenger weight sensors are normal, the indicator light illuminates when the ignition is switched ON. The light turns off after a few seconds. Then, the indicator light illuminates or is off under the following conditions:

Front passenger air bag deactivation indicator light on/off condition chart

Condition detected by the front passenger occupant classification system	Front passenger air bag deactivation indicator light	Front passenger front and side and knee air bags	Front passenger seat belt pretensioner system
Empty (Not occupied)	On	Deactivated	Deactivated
Child or child-restraint system ^{*1}	On	Deactivated	Deactivated
Adult ^{*2}	Off	Ready	Ready

- *1 If a larger child sits on the front passenger seat, the sensors might detect the child as being an adult depending on the child's physique.
- *2 If a smaller adult sits on the front passenger seat, the sensors might detect the person as being a child depending on the person's physique.

The curtain air bag is ready for inflating regardless of what the front passenger air bag deactivation indicator light on/off condition chart indicates.

If the front passenger air bag deactivation indicator light does not illuminate when the ignition is switched ON and does not illuminate as indicated in the front passenger air bag deactivation indicator light on/off condition chart, do not allow a child to sit in the front passenger seat and consult an Authorized Mazda Dealer as soon as possible. The system may not work properly in an accident.



Do not decrease the total seated weight on the front passenger seat: When an adult or large child sits on the front passenger seat, decreasing the total seated weight on the front passenger seat required for air bag deployment is dangerous. The front passenger seat weight sensors will detect the reduced total seated weight condition and the front passenger front and side air bags and knee air bags, and the seat belt pretensioner system will not deploy during an accident. The front passenger will not have the supplementary protection of the air bag, which could result in serious injury. Decreasing the total seated weight on the front passenger seat could result in an air bag not deploying under the following conditions, for example:

- A front passenger is seated as shown in the following figure:



- A rear passenger pushes up on the front passenger seat with their feet.

- Luggage or other items placed under the front passenger seat or between the front passenger seat and driver seat that push up the front passenger seat bottom.
- Any accessories which might decrease the total seated weight on the front passenger seat are attached to the front passenger seat. The front passenger front and side air bags and knee air bags, and the seat belt pretensioner system will deactivate if the front passenger air bag deactivation indicator light illuminates.

Do not increase the total seated weight on the front passenger seat:

When an infant or small child sits on the front passenger seat, increasing the total seated weight on the front passenger seat is dangerous. The front passenger seat weight sensors will detect the increased total seated weight, which could result in the unexpected deployment of the front passenger front and side air bags and knee air bags, and seat belt pretensioner system in an accident and may cause serious injury. Increasing the total seated weight on the front passenger seat could result in the front passenger front and side air bags and knee air bags, and seat belt pretensioner system deployment in an accident under the following conditions, for example:

- Luggage or other items are placed on the seat with the child in the child-restraint system.
- A rear passenger or luggage push or pull down on the front passenger seatback.

SRS Air Bags

- A rear passenger steps on the front passenger seat rails with their feet.
- Luggage or other items are placed on the seatback or hung on the head restraint.
- Heavy items are placed in the seatback map pocket.
- The seat is washed.
- Liquids are spilled on the seat.
- The front passenger seat is moved backward, pushing into luggage or other items placed behind it.
- The front passenger seatback contacts the rear seat.
- Luggage or other items are placed between the front passenger seat and driver seat.
- Any accessories which might increase the total seated weight on the front passenger seat are attached to the front passenger seat.

CAUTION

- To assure proper deployment of the front air bag and to prevent damage to the sensors in the front seat bottoms:
 - Do not place sharp objects on the front seat bottoms or leave heavy luggage on them.
 - Do not spill any liquids on the front seats or under the front seats.
- To allow the sensors to function properly, always perform the following:
 - Adjust the front seats as far back as possible and always sit upright against the seatbacks with seat belts worn properly.

- If you place your child on the front passenger seat, secure the child-restraint system properly and slide the front passenger seat as far back as possible (page 2-47).

NOTE

- The system requires about 10 seconds to alternate between turning the front passenger front and side air bags and knee air bags, and seat belt pretensioner system on or off.
- The front passenger air bag deactivation indicator light may illuminate repeatedly if luggage or other items are put on the front passenger seat, or if the temperature of the vehicle's interior changes suddenly.
- The front passenger air bag deactivation indicator light may illuminate for 10 seconds if the total seated weight on the front passenger seat changes.
- The air bag/front seat belt pretensioner system warning light might illuminate if the front passenger seat receives a severe impact.
- If the front passenger air bag deactivation indicator light does not illuminate after installing a child-restraint system on the front passenger seat, first, re-install your child-restraint system according to the procedure in this owner's manual. Then, if the front passenger air bag deactivation indicator light still does not illuminate, install the child-restraint system on the rear seat and consult an Authorized Mazda Dealer as soon as possible.

- If the front passenger air bag deactivation indicator light illuminates when an adult is seated in the front passenger seat, have the passenger re-adjust their posture by sitting with their feet on the floor, and then re-fastening the seat belt. If the front passenger air bag deactivation indicator light still illuminates, move the passenger to the rear seat. If sitting in the rear seat is not possible, slide the front passenger seat as far back as possible. Consult an Authorized Mazda Dealer as soon as possible.

▼ Driver and Front Passenger Buckle Switches

The buckle switches on the front seat belts detect whether or not the front seat belts are securely fastened and further control the deployment of the air bags.

Constant Monitoring

▼ Constant Monitoring

The following components of the air bag systems are monitored by a diagnostic system:

- Front air bag sensors
- Crash sensors, and diagnostic module (SAS unit)
- Side crash sensors
- Air bag modules
- Front seat belt pretensioners
- Air bag/Front seat belt pretensioner system warning light
- Related wiring

(With Driver and Front Passenger Occupant Classification System)

- Driver seat slide position sensor
- Front passenger occupant classification sensor
- Front passenger occupant classification module
- Front passenger air bag deactivation indicator light
- Front passenger seat belt buckle switch

The diagnostic module continuously monitors the system's readiness. This begins when the ignition is switched ON and continues while the vehicle is being driven.

MEMO

3

Before Driving

Use of various features, including keys, doors, mirrors and windows.

Keys	3-2
Keys.....	3-2
Keyless Entry System.....	3-4
Advanced Keyless Entry System	3-9
Advanced Keyless Entry System*.....	3-9
Operational Range.....	3-10
Doors and Locks	3-11
Door Locks.....	3-11
Liftgate/Trunk Lid.....	3-19
Inside Trunk Release Lever (4-door)*.....	3-24
Fuel and Emission	3-25
Fuel and Engine Exhaust Precautions.....	3-25
Fuel-Filler Lid and Cap.....	3-27
Mirrors	3-30
Mirrors.....	3-30
Windows	3-34
Power Windows.....	3-34
Moonroof*.....	3-37
Security System	3-40
Modification and Add-On Equipment.....	3-40
Immobilizer System.....	3-40
Theft-Deterrent System*.....	3-42
Driving Tips	3-44
Break-In Period.....	3-44
Saving Fuel and Protection of the Environment.....	3-44
Hazardous Driving.....	3-45
Floor Mat.....	3-46
Rocking the Vehicle.....	3-46
Winter Driving.....	3-47
Driving In Flooded Area.....	3-49
Overloading.....	3-49
Driving on Uneven Road.....	3-50
Turbocharger Information (SKYACTIV-G 2.5T).....	3-50
Towing	3-51
Trailer Towing.....	3-51
Recreational Towing.....	3-51

*Some models.

Keys

Keys

▼ Keys

WARNING

Do not leave the key in your vehicle with children and keep them in a place where your children will not find or play with them:

Leaving children in a vehicle with the key is dangerous. This could result in someone being badly injured or even killed. Children may find these keys to be an interesting toy to play with and could cause the power windows or other controls to operate, or even make the vehicle move.

CAUTION

- Because the key (transmitter) uses low-intensity radio waves, it may not function correctly under the following conditions:
 - The key (transmitter) is carried with communication devices such as cellular phones.
 - The key (transmitter) contacts or is covered by a metal object.
 - The key (transmitter) is near electronic devices such as personal computers.
 - Non-Mazda genuine electronic equipment is installed in the vehicle.
 - There is equipment which discharges radio waves near the vehicle.
- The key (transmitter) may consume battery power excessively if it receives high-intensity radio waves. Do not place the key (transmitter) near electronic devices such as televisions or personal computers.

- To avoid damage to the key (transmitter), DO NOT:
 - Drop the key (transmitter).
 - Get the key (transmitter) wet.
 - Disassemble the key (transmitter).
 - Expose the key (transmitter) to high temperatures on places such as the dashboard, under direct sunlight.
 - Expose the key (transmitter) to any kind of magnetic field.
 - Place heavy objects on the key (transmitter).
 - Put the key (transmitter) in an ultrasonic cleaner.
 - Put any magnetized objects close to the key (transmitter).

NOTE

The driver must carry the key (transmitter) to ensure the system functions properly.

Transmitter

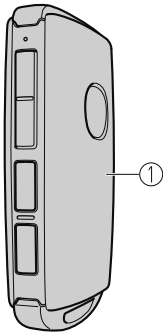

1. Transmitter (page 3-5)

Auxiliary key

There is a removable auxiliary key inside the transmitter.

Removing the auxiliary key

1. Remove the lower cover while pressing the knob in the direction of the arrow.

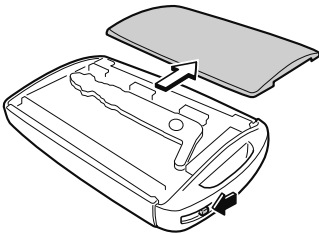

2. Remove the auxiliary key.

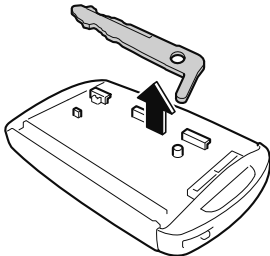

Installing the auxiliary key

1. Install the auxiliary key as the illustration.

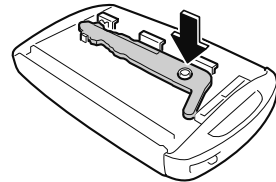

2. Insert the tabs of the lower cover into the slots of the transmitter and install the lower cover.

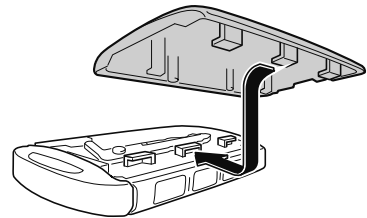

Key code number plate

A code number is stamped on the plate attached to the key set; detach this plate and store it in a safe place (not in the vehicle) for use if you need to make a replacement key (auxiliary key).

Also write down the code number and keep it in a separate safe and convenient place, but not in the vehicle.

If your key (auxiliary key) is lost, consult an Authorized Mazda Dealer and have your code number ready.



1. Key code number plate

Keyless Entry System

▼ Keyless Entry System

This system uses the key buttons to remotely lock and unlock the doors, liftgate, and fuel-filler lid, and opens the trunk lid.

The system can start the engine without having to take the key out of your purse or pocket.

It can also help you signal for attention or help.

Operating the theft-deterrent system is also possible on theft-deterrent system-equipped vehicles.

System malfunctions or warnings are indicated by the following warning lights or beeps.

Check the displayed message for more information and, if necessary, have the vehicle inspected at an Authorized Mazda Dealer, according to the indication.

- KEY Warning Indication/Warning Light (Red)
Refer to KEY Warning Indication/Warning Light (Red) on page 7-33.
- Ignition Not Switched Off (STOP) Warning Beep
Refer to Ignition Not Switched Off (STOP) Warning Beep on page 7-43.
- Key Removed from Vehicle Warning Beep
Refer to Key Removed from Vehicle Warning Beep on page 7-43.

If you have a problem with the key, consult an Authorized Mazda Dealer.

If your key is lost or stolen, consult an Authorized Mazda Dealer as soon as possible for a replacement and to make the lost or stolen key inoperative.



Radio equipment like this is governed by laws in the United States. Changes or modifications not expressly approved by the party responsible for compliance could void the user's authority to operate the equipment.

NOTE

- The keyless entry system operation may vary due to local conditions.
- The keyless entry system is fully operational when the ignition is switched off. The system does not operate if the ignition is switched to any position other than off.
- If the key does not operate when pressing a button or the operational range becomes too small, the battery may be weak. To install a new battery, refer to Key Battery Replacement (page 6-31).
- Battery life is about 1 year. Replace the battery with a new one if the messages are displayed in the instrument cluster. Replacing the battery about once a year is recommended because the KEY warning indication may not display depending on the rate of battery depletion.
- Additional keys can be obtained at an Authorized Mazda Dealer. Up to 6 keys can be used with the keyless functions per vehicle. Bring all keys to an Authorized Mazda Dealer when additional keys are required.

▼ Transmitter

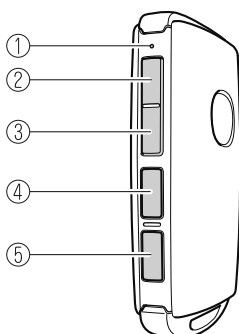

1. Operation indicator light
2. Lock button (🔒)
3. Unlock button (🔓)
4. Trunk button (4-door) (🚗) (HOLD)
5. Panic button (🚨) (HOLD)

NOTE

- The headlights turn on/off by operating the transmitter. Refer to Leaving Home Light on page 4-50.
- **(With theft-deterrent system)**
The hazard warning lights flash when the theft-deterrent system is armed or turned off.
Refer to Theft-Deterrent System on page 3-42.

• **(With the advanced keyless function)**

A beep sound can be heard for confirmation when the doors, liftgate, and fuel-filler lid are locked/unlocked using the key. If you prefer, the beep sound can be turned off.

The volume of the beep sound can also be changed.

Refer to the Settings section in the Mazda Connect Owner's Manual.

The operation indicator light flashes when the buttons are pressed.

Lock button

To lock the doors, liftgate, and fuel-filler lid, press the lock button and the hazard warning lights will flash once.

(With the advanced keyless function)

A beep sound will be heard once.

To confirm that all the doors, liftgate, and fuel-filler lid have been locked, press the lock button again within 5 seconds. If they are closed and locked, the horn will sound.



NOTE

- If the lock button is pressed with any door or liftgate/trunk lid open, any closed door can be locked. Close any open door and liftgate/trunk lid to lock.
- Confirm that all the doors, liftgate, and fuel-filler lid are locked visually or audibly by use of the double click.
- Make sure all the doors, liftgate, and fuel-filler lid are locked after pressing the button.

Keys

- **(With theft-deterrent system)**
If the lock button is pressed with all the doors and liftgate closed, the hazard warning lights will flash and the theft-deterrent system is armed.

Unlock button

To unlock the driver's door and the fuel-filler lid, press the unlock button and the hazard warning lights will flash twice.

(With the advanced keyless function)
A beep sound will be heard twice.

To unlock the other doors and liftgate, press the unlock button again within 5 seconds and two more beep sounds will be heard.



NOTE

- The system can be set to unlock all the doors, liftgate, and fuel-filler lid when pressing the unlock button once.
Refer to the Settings section in the Mazda Connect Owner's Manual.
- **(Auto re-lock function)**
After unlocking with the key, all the doors, liftgate, and fuel-filler lid will automatically lock if any of the following operations are not performed within about 60 seconds. If your vehicle has a theft-deterrent system, the hazard warning lights will flash for confirmation.
The time required for the doors to lock automatically can be changed. Refer to the Settings section in the Mazda Connect Owner's Manual.
- A door or the liftgate/trunk lid is opened.

- The ignition is switched to any position other than off.
- **(With theft-deterrent system)**
When the doors are unlocked by pressing the unlock button on the key while the theft-deterrent system is turned off, the hazard warning lights will flash twice to indicate that the system is turned off.

Trunk button (4-door)

To open the trunk lid, press and hold the trunk button until the trunk lid opens.



HOLD

Panic button

If you witness from a distance someone attempting to break into or damage your vehicle, press and hold the panic button to activate the vehicle's alarm. Call emergency services if necessary.



HOLD

NOTE

The panic button will work whether any door or the liftgate/trunk lid is open or closed.

(Turning on the alarm)

Pressing the panic button for 1 second or more will trigger the alarm for about 2 minutes and 30 seconds, and the following will occur:

- The horn sounds intermittently.
- The hazard warning lights flash.

(Turning off the alarm)

The alarm stops by pressing any button on the key.

Power saving function

By turning on the transmitter power saving function, the advanced keyless entry^{*1} and push button start system functions turn off and the battery power consumption of the transmitter is restricted.

The remote control function is operational by operating the transmitter switch even while the power saving function is turned on. However, the operation indicator light of the transmitter does not turn on/flash.

Turning on the power saving function

After you have turned on the power saving function according to the following procedure, the hazard warning lights and sound operate^{*1} one time.

1. Press the lock button on the transmitter 4 times within 3 seconds to turn on the operation indicator light.
2. Press the lock button continuously for 1.5 seconds or longer while the operation indicator light turns on (for 5 seconds).
3. Press any of the buttons on the transmitter to make sure that the operation indicator light does not turn on/flash.

Turning off the power saving function

After you have turned off the power saving function according to the following procedure, the hazard warning lights and sound operate^{*1} one time.

1. Press any of the buttons on the transmitter to make sure that the operation indicator light does not turn on/flash.
2. Press the lock button on the transmitter 4 times within 3 seconds to turn on the operation indicator light.
3. Press the lock button continuously for 1.5 seconds or longer while the operation indicator light turns on (for 5 seconds).

^{*1} With the advanced keyless function

▼ Operational Range

The system operates only when the driver is in the vehicle or within operational range while the key is being carried.

Starting the engine

NOTE

- Starting the engine may be possible even if the key is outside of the vehicle and extremely close to a door and window, however, always start the engine from the driver's seat. If the vehicle is started and the key is not in the vehicle, the vehicle will not restart after it is shut off and the ignition is switched off.
- The luggage compartment/trunk is out of the assured operational range, however, if the key (transmitter) is operable the engine will start.

Keys

With the advanced keyless function

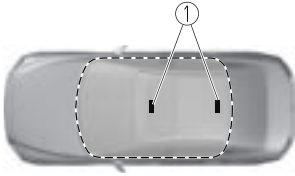

1. Interior antenna
2. Operational range

Without the advanced keyless function

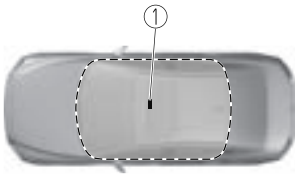

1. Interior antenna
2. Operational range

NOTE

The engine may not start if the key is placed in the following areas:

- Around the dashboard
- In the storage compartments such as the glove compartment or the center console
- On the rear parcel shelf (4-door)

▼ Key Suspend Function

If a key is left in the vehicle, the functions of the key left in the vehicle are temporarily suspended to prevent theft of the vehicle.

To restore the functions, press the unlock button on the functions-suspended key in the vehicle.

Advanced Keyless Entry System*

▼ Advanced Keyless Entry System

WARNING

Radio waves from the key may affect medical devices such as pacemakers:

Before using the key near people who use medical devices, ask the medical device manufacturer or your physician if radio waves from the key will affect the device.

The advanced keyless function allows you to lock/unlock the door, liftgate, and fuel-filler lid, or open the liftgate/trunk lid while carrying the key.

System malfunctions or warnings are indicated by the following warning beeps.

- Touch Sensor Inoperable Warning Beep
Refer to Touch Sensor Inoperable Warning Beep (With the advanced keyless function) on page 7-44.
- Liftgate Door-lock Switch Inoperable Warning Beep
Refer to Liftgate Door-lock Switch Inoperable Warning Beep (With the advanced keyless function) on page 7-44.
- Key Left-in-luggage Compartment/Trunk Warning Beep
Refer to Key Left-in-luggage Compartment/Trunk Warning Beep (With the advanced keyless function) on page 7-44.

- Key Left-in-vehicle Warning Beep
Refer to Key Left-in-vehicle Warning Beep (With the advanced keyless function) on page 7-44.

NOTE

The advanced keyless entry system functions can be deactivated to prevent any possible adverse effect on a user wearing a pacemaker or other medical device. If the system is deactivated, you will be unable to start the engine by carrying the key. Consult an Authorized Mazda Dealer for details. If the advanced keyless entry system has been deactivated, you can start the engine by following the procedure indicated when the key battery goes dead.

Refer to Engine Start Function When Key Battery is Dead on page 4-8.

Advanced Keyless Entry System

Operational Range

▼ Operational Range

The system operates only when the driver is in the vehicle or within operational range while the key is being carried.

NOTE

When the battery power is low, or in places where there are high-intensity radio waves or noise, the operational range may become narrower or the system may not operate. For determining battery replacement, Refer to Keyless Entry System on page 3-4.

▼ Locking/Unlocking Using Touch Sensor

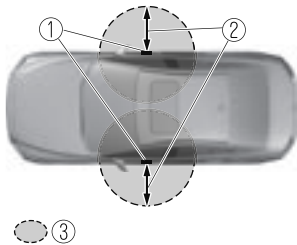

1. Exterior antenna
2. 80 cm (31 in)
3. Operational range

NOTE

- The system may not operate if you are too close to the windows or door handles.
- If the key is left in the following areas and you leave the vehicle, the doors may be locked depending on the radio wave conditions even if the key is left in the vehicle.

- Around the dashboard
- In the storage compartments such as the glove compartment or the center console
- On the rear parcel shelf (4-door)
- Next to a communication device such as a mobile phone

▼ Locking Using Door-Lock Switch (5-door)/Unlocking Using Electric Opener

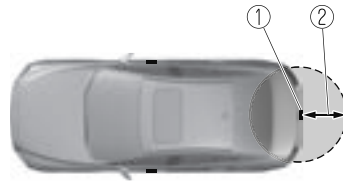

1. Exterior antenna
2. 80 cm (31 in)
3. Operational range

Door Locks

▼ Door Locks

WARNING

Always take all children and pets with you or leave a responsible person with them:

Leaving a child or a pet unattended in a parked vehicle is dangerous. In hot weather, temperatures inside a vehicle can become high enough to cause brain damage or even death.

Do not leave the key in your vehicle with children and keep them in a place where your children will not find or play with them:

Leaving children in a vehicle with the key is dangerous. This could result in someone being badly injured or even killed.

Keep all doors locked when driving:

Unlocked doors in a moving vehicle are dangerous. Passengers can fall out if a door is accidentally opened and can more easily be thrown out in an accident.

Always close all the windows and moonroof, lock the doors, fuel-filler lid, and liftgate and take the key with you when leaving your vehicle unattended:

Leaving your vehicle unlocked is dangerous as children could lock themselves in a hot vehicle, which could result in death. Also, a vehicle left unlocked becomes an easy target for thieves and intruders.

After closing the doors and the liftgate/trunk lid, always verify that they are securely closed:

Doors and the liftgate/trunk lid not securely closed are dangerous, if the vehicle is driven with a door and the liftgate/trunk lid not securely closed, the door and the liftgate/trunk lid could open unexpectedly resulting in an accident.

Always confirm the safety around the vehicle before opening a door and the liftgate/trunk lid:

Suddenly opening a door and the liftgate/trunk lid is dangerous. A passing vehicle or a pedestrian could be hit and cause an accident.

CAUTION

- Always confirm the conditions around the vehicle before opening/closing the doors and the liftgate/trunk lid and use caution during strong winds or when parked on an incline. Not being aware of the conditions around the vehicle is dangerous because fingers could get caught in the door and the liftgate/trunk lid or a passing pedestrian could be hit, resulting in an unexpected accident or injury.

Doors and Locks

NOTE

- Always stop the engine and lock the doors. In addition, to prevent theft of valuables, do not leave them inside the cabin.
- If the key is left in the following areas and you leave the vehicle, the doors may be locked depending on the radio wave conditions even if the key is left in the vehicle.
 - Around the dashboard
 - In the storage compartments such as the glove compartment or the center console
 - On the rear parcel shelf (4-door)
 - Next to a communication device such as a mobile phone
- When the ignition is switched to ACC or ON, the vehicle lock-out prevention feature prevents you from locking yourself out of the vehicle. All doors, fuel-filler lid, and liftgate will automatically unlock if they are locked using the power door locks with any door or the liftgate open. The vehicle lock-out prevention feature does not operate while the ignition is switched off. When all doors, fuel-filler lid, and liftgate are locked using the power door lock with any door or the liftgate/trunk lid open, the closed doors, fuel-filler lid, and liftgate are locked. After that, when all doors and the liftgate/trunk lid are closed, all doors and the liftgate/trunk lid are locked. However, if the key is inside the vehicle, all doors, fuel-filler lid, and liftgate are automatically unlocked.

(With the advanced keyless function)

The beep sound is heard for about 10 seconds to notify the driver that the key has been left in the vehicle.

(Without the advanced keyless function)

The horn sound is heard twice to notify the driver that the key has been left in the vehicle.

· **(Door unlock (control) system with collision detection)**

This system automatically unlocks the doors, fuel-filler lid, and liftgate in the event the vehicle is involved in an accident to allow passengers to get out of the vehicle immediately and prevent being trapped inside. While the ignition is switched ON and in the event the vehicle receives an impact strong enough to inflate the air bags, all the doors, fuel-filler lid, and liftgate are automatically unlocked after about 6 seconds have elapsed from the time of the accident.

The doors, fuel-filler lid, and liftgate may not unlock depending on how an impact is applied, the force of the impact, and other conditions of the accident.

If door-related systems or the battery is malfunctioning, the doors, fuel-filler lid, and liftgate may not unlock depending on your vehicle type.

▼ Unlocking with Auxiliary Key

Only the driver's door can be unlocked using the auxiliary key.

Refer to Keys on page 3-2.

Insert the auxiliary key while the driver's door handle is pulled and turn the key to the unlock side. Turn the auxiliary key back to its original position before removing it.



NOTE

If you attempt to open the driver's door using an unauthorized auxiliary key, the key cylinder will spin around but the door will not unlock.

▼ Locking, Unlocking with Touch Sensor, Door Handle (With the advanced keyless function)

By touching the sensing area of the touch sensor, various locking/unlocking operations can be done without taking the key out of a bag or pocket.

There are two types of touch sensors used for locking and unlocking, and each sensor is built into the outer door handle on the driver and front passenger's doors.

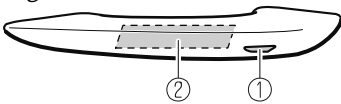

1. Sensing area of door lock touch sensor (Depression on outer side of door handle)

2. Sensing area of door release touch sensor (Inner side of door handle)

NOTE

- When locking/unlocking with the transmitter carried, securely touch the sensing area of the touch sensor as follows.

Locking

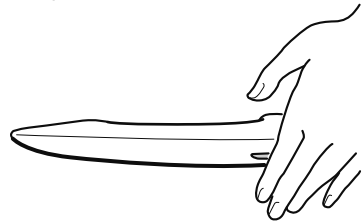

Unlocking

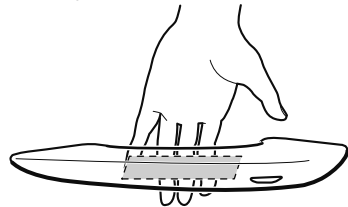

- The system may not operate normally under the following conditions.
 - You touch the sensing area of the door lock touch sensor and the sensing area of the door release touch sensor at the same time.

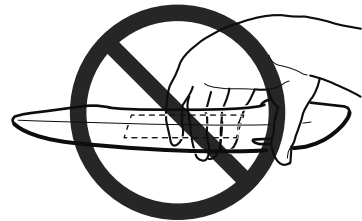

- You touch the sensing area of the touch sensor while wearing gloves.
- Foreign matter such as snow or dirt is stuck on the sensing area of the touch sensor.

Doors and Locks

- You pull the door handle just after touching the sensing area of the touch sensor.
- The system may operate if the outer side door handle of a front door is splashed with water by a car wash or rain while the transmitter is in the operation range.
- If the system does not operate even though you touch the sensing area of the touch sensor correctly, release the touch sensor once, and then touch the sensing area of the touch sensor again after waiting about 3 seconds.

Locking

When locking, touch the sensing area of the door lock touch sensor with all of the following conditions met.

- The ignition is switched OFF.
- All the doors are closed.
- You are carrying the transmitter.

The following locations are locked by touching the sensing area of the door lock touch sensor.

- All doors
- Fuel-filler lid
- Liftgate

When locking, the hazard warning lights and sound operate one time.

Unlocking

When unlocking, touch the sensing area of the door release touch sensor with all of the following conditions met.

- The ignition is switched OFF.
- The driver's door is locked.
- Three seconds or longer have passed since the doors were locked.
- You are carrying the transmitter.

(Unlocking from the driver's door)

The following locations are unlocked by touching the sensing area of the door release touch sensor of the driver's door.

- Driver's door
- Fuel-filler lid

NOTE

- The location to be unlocked can be changed.
Refer to the Settings section in the Mazda Connect Owner's Manual.

When unlocking, the hazard warning lights and sound operate two times.

(Unlocking from the front passenger's door)

The following locations are unlocked by touching the sensing area of the door release touch sensor of the front passenger's door.

- All doors
- Fuel-filler lid
- Liftgate

When unlocking, the hazard warning lights and sound operate two times.

NOTE

- Confirm that all the doors and liftgate/trunk lid are securely locked. For the liftgate/trunk lid, move it without pressing the electric liftgate/trunk lid opener to verify that the liftgate/trunk lid has not been left ajar.

- A beep sound is heard for confirmation when the doors, fuel-filler lid, and liftgate are locked/unlocked using the touch sensor. If you prefer, the beep sound can be turned off.
The volume of the beep sound can also be changed. Refer to the Settings section in the Mazda Connect Owner's Manual.
- **(With theft-deterrent system)**
The hazard warning lights flash when the theft-deterrent system is armed or turned off.
Refer to Theft-Deterrent System on page 3-42.
- The setting can be changed so that the doors, fuel-filler lid, and liftgate are locked automatically without touching the sensing area of the touch sensor.
Refer to the Settings section in the Mazda Connect Owner's Manual.

(Walk-away auto lock function)

A beep sound is heard when all doors and the liftgate/trunk lid are closed while the transmitter is being carried. All the doors, fuel-filler lid, and liftgate are locked automatically when the transmitter is out of the operational range. Also, the hazard warning lights flash once. (Even if the driver is in the operational range, all the doors, fuel-filler lid, and liftgate are locked automatically after about 30 seconds.) If you are out of the operational range before the doors and the liftgate/trunk lid are completely closed or another transmitter is left in the vehicle, the walk-away auto lock function will not work. Always make sure that all doors and the liftgate/trunk lid are closed and locked before leaving the vehicle. The walk-away auto lock function does not close the power windows.

Doors and Locks

· **(Auto re-lock function)**

After unlocking with the touch sensor, all the doors, fuel-filler lid, and liftgate will automatically lock if any of the following operations are not performed within about 60 seconds.

- Opening a door or the liftgate/trunk lid.
- Switching the ignition to any position other than off.

If your vehicle has a theft-deterrent system, the hazard warning lights will flash for confirmation.

The time required for the doors to lock automatically can be changed. Refer to the Settings section in the Mazda Connect Owner's Manual.

▼ **Locking, Unlocking with Transmitter**

The following locations can be locked/unlocked by operating the keyless entry system transmitter. Refer to Keyless Entry System (page 3-4).

- All doors
- Fuel-filler lid
- Liftgate

▼ **Locking, Unlocking with Door-Lock Switch**

Door-lock switch on driver's and front passenger's door

The following locations are locked/unlocked by pressing the door-lock switch.

- All doors
- Fuel-filler lid
- Liftgate

Driver's door

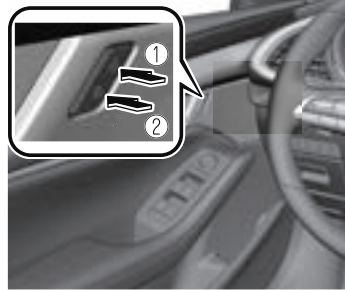

1. Unlock
2. Lock

Front passenger's door



1. Unlock
2. Lock

Locking from the outside using the door-lock switch

When locking from the outside using the door-lock switch, press the lock side of the door-lock switch with all of the following conditions met and then close all the doors.

- The ignition is switched OFF.
- Any door is open.

NOTE

- To prevent the transmitter from being left in the vehicle, make sure that you carry the transmitter before locking.
- After locking by pressing the door-lock switch and when all the doors are closed with the transmitter left in the vehicle, all the doors, liftgate, and fuel-filler lid are unlocked.
- After locking by pressing the door-lock switch and when the liftgate/trunk lid is closed last with the transmitter left in the vehicle, only the liftgate/trunk lid is unlocked.

Door-lock switch on liftgate (With the advanced keyless function)

All doors, fuel-filler lid, and the liftgate can be locked by pressing the door-lock switch.



When locking using the door-lock switch, press the door-lock switch with all of the following conditions met and then close the liftgate.

- You are carrying the transmitter.
- The ignition is switched OFF.
- All the doors are closed.

(With theft-deterrent system)

When locking, a beep sound operates 1 time.

When the liftgate closes, the hazard warning lights operate 1 time.

(Without theft-deterrent system)

When locking, the hazard warning lights and a beep sound operate 1 time.

NOTE

- To prevent the transmitter from being left in the vehicle, make sure that you carry the transmitter before locking.
- After locking by pressing the door-lock switch and when the liftgate is closed with the transmitter left in the vehicle, the liftgate is unlocked.

▼ Auto Lock/Unlock Function**Do not pull the inner handle on a front door:**

Pulling the inner handle on a front door while the vehicle is moving is dangerous. Passengers can fall out of the vehicle if the door opens accidentally, which could result in death or serious injury.

- When the vehicle speed exceeds 20 km/h (12 mph), all the doors, fuel-filler lid, and liftgate lock automatically.
- When the ignition is switched off, all the doors, fuel-filler lid, and liftgate unlock automatically.

The auto lock/unlock function settings can be changed.

Refer to the Settings section in the Mazda Connect Owner's Manual.

Doors and Locks

▼ Locking, Unlocking with Door-Lock Knob

Operation from inside

To lock any door from the inside, press the door-lock knob.

To unlock, pull it outward.

This does not operate the other door locks.

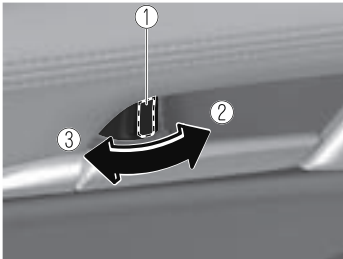

1. Unlocked: Red indicator
2. Lock
3. Unlock

Operation from outside

To lock any door using its door-lock knob from the outside, press the door-lock knob to the lock position and close the door (holding the door handle in the open position is not required).

This does not operate the other door locks.



NOTE

When locking the door this way:

- Be careful not to leave the key inside the vehicle.
- The doors cannot be locked using the driver's door lock knob if any door or liftgate is open when the ignition is switched to ACC or ON.

▼ Rear Door Child Safety Locks

Rear doors that have been locked using the child safety lock switched to the lock side cannot be opened from inside the vehicle.

For child safety, switch the child safety lock on both rear doors to the lock side.

When opening a rear door with the child safety lock switched to the lock side, pull the outer door handle with the lock knob inside the vehicle switched to the unlock side.

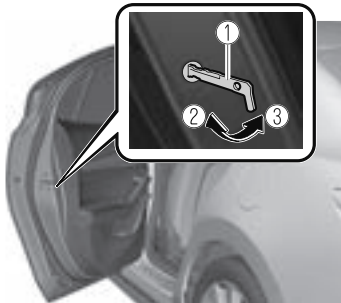

1. Auxiliary key (page 3-2)
2. Lock
3. Unlock

Liftgate/Trunk Lid

▼ Liftgate/Trunk Lid

WARNING

Never allow a person to ride in the luggage compartment/trunk:

Allowing a person to ride in the luggage compartment/trunk is dangerous. The person in the luggage compartment/trunk could be seriously injured or killed during sudden braking or a collision.

Do not drive with the liftgate/trunk lid open:

Exhaust gas in the cabin of a vehicle is dangerous. An open liftgate/trunk lid in a moving vehicle will cause exhaust gas to be drawn into the cabin. This gas contains CO (carbon monoxide), which is colorless, odorless, and highly poisonous, and it can cause loss of consciousness and death. Moreover, an open liftgate/trunk lid could cause occupants to fall out in an accident.

Do not stack or leave loaded luggage unsecured in the luggage compartment:

Otherwise, the luggage may move or collapse, resulting in injury or an accident. In addition, do not load luggage higher than the seatbacks. It may affect the side or rear field of view. Additionally, if the air bags deploy, the cargo may scatter which could result in serious injury or death.

Doors and Locks

CAUTION

- Before opening the liftgate/trunk lid, remove any snow and ice accumulation on it. Otherwise, the liftgate/trunk lid could close under the weight of the snow and ice resulting in injury.
- Be careful when opening/closing the liftgate/trunk lid during strong winds. If a strong gust blows against the liftgate/trunk lid, it could close suddenly resulting in injury.
- Fully open the liftgate/trunk lid and make sure that it stays open. If the liftgate/trunk lid is only opened partially, it could slam shut by vibration or wind gusts resulting in injury.
- When loading or unloading luggage in the luggage compartment/trunk, turn off the engine. Otherwise, you could get burned by the heat of the exhaust gas.
- Be careful not to apply excessive force to the damper stay on the liftgate such as by putting your hand on the stay. Otherwise, the damper stay may bend and affect the liftgate operation.

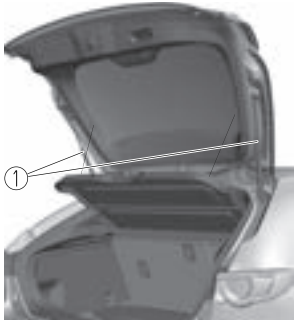

1. Damper stay

- Do not modify or replace the liftgate damper stay. Consult an Authorized Mazda Dealer if a liftgate damper stay is deformed or damaged for reasons such as a collision or if there is some other problem.

▼ Opening and Closing the Liftgate/Trunk Lid

Opening the liftgate (5-door)

Using the electric liftgate opener

Unlock the doors and liftgate, then press the electric liftgate opener on the liftgate and raise the liftgate when the latch releases.

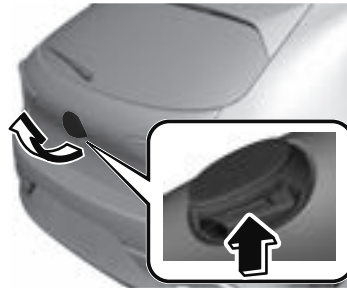

NOTE (With the advanced keyless function)

- A locked liftgate can also be opened while the key is being carried.
- When opening the liftgate with the doors and the liftgate locked, it may require a few seconds for the liftgate latch to release after the electric liftgate opener is pressed.

- The liftgate can be closed when the doors are locked with the key left in the vehicle. However, to prevent locking the key in the vehicle, the liftgate can be opened by pressing the electric liftgate opener. If the liftgate cannot be opened despite doing this procedure, first push the liftgate completely closed, then press the electric liftgate opener to fully open the liftgate.
- When the liftgate latch is released by pressing the electric liftgate opener, the liftgate raises slightly. If the liftgate is not operated for a certain period of time, the liftgate cannot be raised.

To open

Press the electric liftgate opener again.

To close

To close the liftgate from its slightly raised position, open it first by pressing the electric liftgate opener, then close it after waiting at least 1 second.

- If the vehicle battery is dead or there is a malfunction in the electrical system and the liftgate cannot be unlocked, the liftgate can be opened by performing the emergency procedure.

Refer to When Liftgate/Trunk Lid Cannot be Opened on page 7-48.

Opening the trunk lid (4-door)**Using the trunk lid release button**

Push the trunk lid release button.

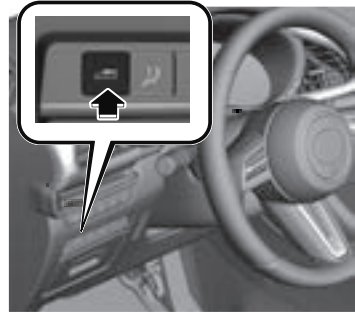
**Using the electric trunk lid opener (With the advanced keyless function)**

A trunk lid can also be opened while the key is being carried.

Press the electric trunk lid opener on the trunk lid, then raise the trunk lid when the latch releases.

**NOTE**

- When opening the trunk lid with the doors locked, it may require a few seconds for the trunk lid latch to release after the electric trunk lid opener is pressed.

Doors and Locks

- The trunk lid can be closed when the doors are locked with the key left in the vehicle. However, to prevent locking the key in the vehicle, the trunk lid can be opened by pressing the electric trunk lid opener. If the trunk lid cannot be opened despite doing this procedure, press the electric trunk lid opener to fully open the trunk lid after pushing the trunk lid completely closed.
- If the vehicle battery is dead or there is a malfunction in the electrical system and the trunk lid cannot be unlocked, the trunk lid can be opened by performing the emergency procedure. Refer to When Liftgate/Trunk Lid Cannot be Opened on page 7-48.

Closing the liftgate/trunk lid

Lower the liftgate/trunk lid slowly using the liftgate/trunk lid grip recess, then push the liftgate/trunk lid closed using both hands.

Do not slam it. Pull up on the liftgate/trunk lid to make sure it is secure.

(5-door)



(4-door)



WARNING

Do not drive the vehicle with the liftgate-ajar warning indication displayed :

Otherwise, the liftgate/trunk lid may open unexpectedly and result in an accident.

NOTE

Confirm that the liftgate/trunk lid is securely closed.

Move the liftgate/trunk lid without pressing the electric liftgate/trunk lid opener to verify that the liftgate/trunk lid has not been left ajar.

▼ Luggage Compartment

Luggage compartment cover (5-door)

WARNING

Do not place anything on top of the cover:

Placing luggage or other cargo on top of the luggage compartment cover is dangerous. During sudden braking or a collision, the cargo could become a projectile that could hit and injure someone.

Make sure luggage and cargo are secured before driving:

Not securing cargo while driving is dangerous as it could move or be crushed during sudden braking or a collision and cause injury.

 **CAUTION**

- Make sure the luggage compartment cover is firmly secured. If it is not firmly secured, it could unexpectedly disengage resulting in injury.

The luggage compartment can be accessed by opening the liftgate when the straps are attached to the sides of the liftgate.

**Removing the luggage compartment cover**

This cover can be removed for more room.

1. Remove the straps from the hooks.
2. Press the luggage compartment cover upward from near the pins and remove the luggage compartment cover from the pins.

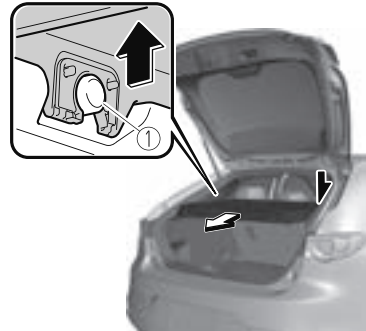

1. Pin
3. Lift the front end of the luggage compartment cover and remove it.

Doors and Locks

Inside Trunk Release Lever (4-door)*

▼ Inside Trunk Release Lever

Your vehicle is equipped with an inside trunk release lever that provides a means of escape for children and adults in the event they become locked inside the trunk.

No matter how careful adults might be with keys and locking their cars, parents should be aware that children may be tempted to play around vehicles and use the trunk as a hiding place.

Adults are advised to familiarize themselves with the operation and location of the inside trunk release lever so that all children can be told about it in an appropriate way, keeping in mind that most vehicles do not have such levers.

WARNING

Close the trunk lid, be sure the seat backs are latched and do not allow children to play inside the vehicle:

Leaving the trunk lid open or leaving children in the vehicle with the keys is dangerous. Children could open the trunk lid and climb inside resulting in possible injury or death from heat exposure.

Always keep the car from being a tempting place to play by latching the rear seats, doors and the trunk, and keeping the keys where children can not play with them:

Leaving children or animals unattended in a parked vehicle is dangerous. Babies left sleeping and children who lock themselves in cars or trunks can die very quickly from heat prostration. Do not leave your children or pets alone in a car at any time. Do not leave the car, the rear folding seats or the trunk unlocked.

▼ Opening the Trunk Lid from the Inside

Slide the inside trunk release lever in the direction of the arrow. The lever is made of material that will glow for hours in the darkness of the trunk following a brief exposure to ambient light.

The inside trunk release lever is located on the inside of the trunk lid.



Fuel and Engine Exhaust Precautions

▼ Fuel Requirements

Vehicles with catalytic converters or oxygen sensors must use **ONLY UNLEADED FUEL**, which will reduce exhaust emissions and keep spark plug fouling to a minimum.

To achieve maximum engine performance, use the specified fuel.

Fuel	Octane Rating* ¹ (Anti-knock index)
Regular unleaded fuel	87 [(R+M)/2 method] or above (91 RON or above)

*¹ U.S. federal law requires that octane ratings be posted on gas station pumps.

Fuel with a rating lower than 87 octane (91 RON) will negatively affect the emission control system performance and could also cause engine knocking and serious engine damage.



➤ USE ONLY UNLEADED FUEL.

Leaded fuel is harmful to the catalytic converter and oxygen sensors and will lead to deterioration of the emission control system and or failures.

- This vehicle can only use oxygenated fuels containing no more than 10 % ethanol by volume. Damage to the vehicle may occur when ethanol exceeds this recommendation, or if the gasoline contains any methanol. Stop using gasohol of any kind if your vehicle engine is performing poorly.
- Never add fuel system additives other than a Mazda genuine product, otherwise the emission control system could be damaged. Consult an Authorized Mazda Dealer for details.

Gasoline blended with oxygenates such as alcohol or ether compounds are generally referred to as oxygenated fuels. The common gasoline blend that can be used with your vehicle is ethanol blended at no more than 10 %. Gasoline containing alcohol, such as ethanol or methanol, may be marketed under the name "Gasohol".

Vehicle damage and drivability problems resulting from the use of the following may not be covered by the warranty.

- Gasohol containing more than 10 % ethanol.
- Gasoline or gasohol containing methanol.
- Leaded fuel or leaded gasohol.

Fuel and Emission

▼ Emission Control System

This vehicle is equipped with an emission control system (the catalytic converter is part of this system) that enables the vehicle to comply with existing exhaust emissions requirements.

WARNING

Never park over or near anything flammable:

Parking over or near anything flammable, such as dry grass, is dangerous. Even with the engine turned off, the exhaust system remains very hot after normal use and could ignite anything flammable. A resulting fire could cause serious injury or death.

CAUTION

Ignoring the following precautions could cause lead to accumulate on the catalyst inside the converter or cause the converter to get very hot. Either condition will damage the converter and cause poor performance.

- USE ONLY UNLEADED FUEL.
- Do not drive your Mazda with any sign of engine malfunction.
- Do not coast with the ignition switched off.
- Do not descend steep grades in gear with the ignition switched off.
- Do not operate the engine at high idle for more than 2 minutes.
- Do not tamper with the emission control system. All inspections and adjustments must be made by a qualified technician.
- Do not push-start or pull-start this vehicle.

NOTE

- Under U.S. federal law, any modification to the original-equipment emission control system before the first sale and registration of a vehicle is subject to penalties. In some states, such modification made on a used vehicle is also subject to penalties.
- While the engine is off, the sound of a valve opening and closing can be heard at the rear of the vehicle, however this does not indicate an abnormality. The vehicle has a self-checking device and it operates while the engine is off.

▼ Engine Exhaust (Carbon monoxide)

WARNING

Do not drive your vehicle if you smell exhaust gas inside the vehicle:

Engine exhaust gas is dangerous. This gas contains carbon monoxide (CO), which is colorless, odorless, and poisonous. When inhaled, it can cause loss of consciousness and death. If you smell exhaust gas inside the vehicle, keep all windows fully open and contact an Authorized Mazda Dealer immediately.

Do not run the engine when inside an enclosed area:

Running the engine inside an enclosed area, such as a garage, is dangerous. Exhaust gas, which contains poisonous carbon monoxide, could easily enter the cabin. Loss of consciousness or even death could occur.

Open the windows or adjust the heating or cooling system to draw fresh air when idling the engine:

Exhaust gas is dangerous. When the vehicle is stopped with the windows closed and the engine running for a long time even in an open area, exhaust gas, which contains poisonous carbon monoxide, could enter the cabin. Loss of consciousness or even death could occur.

Clear snow from underneath and around your vehicle, particularly the tail pipe, before starting the engine:

Running the engine when a vehicle is stopped in deep snow is dangerous. The exhaust pipe could be blocked by the snow, allowing exhaust gas to enter the cabin. Because exhaust gas contains poisonous carbon monoxide, it could cause loss of consciousness or even death to occupants in the cabin.

Fuel-Filler Lid and Cap**▼ Fuel-Filler Lid and Cap**** WARNING****When removing the fuel-filler cap, loosen the cap slightly and wait for any hissing to stop, then remove it:**

Fuel spray is dangerous. Fuel can burn skin and eyes and cause illness if ingested. Fuel spray is released when there is pressure in the fuel tank and the fuel-filler cap is removed too quickly.

Before refueling, stop the engine, and always keep sparks and flames away from the filler neck:

Fuel vapor is dangerous. It could be ignited by sparks or flames causing serious burns and injuries. Additionally, use of the incorrect fuel-filler cap or not using a fuel-filler cap may result in a fuel leak, which could result in serious burns or death in an accident.

Do not continue refueling after the fuel pump nozzle shuts off automatically:

Continuing to add fuel after the fuel pump nozzle has shut off automatically is dangerous because overfilling the fuel tank may cause fuel overflow or leakage. Fuel overflow and leakage could damage the vehicle and if the fuel ignites it could cause a fire and explosion resulting in serious injury or death.

CAUTION

- Always use only a genuine Mazda fuel-filler cap or an approved equivalent, available at an Authorized Mazda Dealer. The wrong cap can result in a serious malfunction of the fuel and emission control systems.

(U.S.A. and Canada)

It may also cause the check engine light in the instrument cluster to illuminate.

- When using an automatic car wash or a high water pressure car washer, lock the driver's door. Otherwise, the fuel-filler lid may open unexpectedly and could be damaged.

▼ Refueling

Before refueling, close all the doors, windows, and liftgate/trunk lid, and switch the ignition OFF.

1. Using the following, unlock the driver's door.
 - Transmitter (page 3-16)
 - Touch sensor (page 3-13)
 - Door-lock switch (page 3-16)
 - Auto lock/unlock function (page 3-17)

NOTE

- When unlocking the driver's door, the fuel lid is also unlocked at the same time.
- When locking the driver's door, the fuel lid is locked after 90 seconds.
- The time until the fuel lid is locked after locking the driver's door can be changed. Refer to the Settings section in the Mazda Connect Owner's Manual.

- However, when the driver's door is locked using the following functions, the fuel lid is also locked at the same time.

- Auto lock/unlock function (page 3-17)
- Auto re-lock function (page 3-5) and (page 3-13)

2. Press the location shown in the illustration and open the fuel lid.

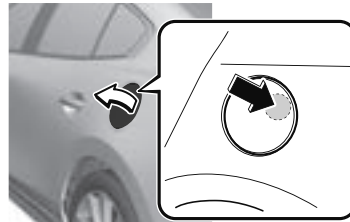

3. To remove the fuel-filler cap, turn it counterclockwise.
4. Attach the removed cap to the inner side of the fuel-filler lid.

4-door

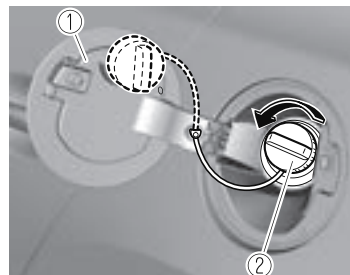

1. Fuel-filler lid
2. Fuel-filler cap

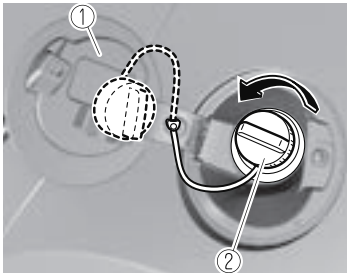
5-door

1. Fuel-filler lid
2. Fuel-filler cap

5. Insert the refueling nozzle all the way and begin refueling. Pull out the refueling nozzle after the refueling stops automatically.
6. To close the fuel-filler cap, turn it clockwise until a click is heard.
7. To close, press the fuel-filler lid until a click sound is heard.

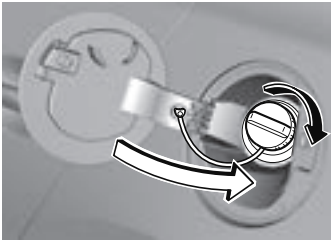
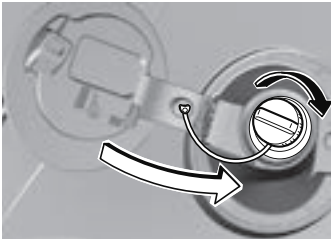
4-door**5-door**

8. Make sure to lock all the doors when leaving the vehicle.

NOTE

Lock the doors after closing the fuel-filler lid.

If the fuel-filler lid is closed after locking the doors, the fuel-filler lid cannot be locked.

CAUTION

(U.S.A. and Canada)

If the check fuel cap warning light illuminates, the fuel-filler cap may not be properly installed. If the warning light illuminates, park your vehicle safely off the right-of-way, remove the fuel-filler cap and reinstall it correctly. After the cap has been correctly installed, the fuel cap warning light may continue to illuminate until a number of driving cycles have been completed. A drive cycle consists of starting the engine (after four or more hours with the engine off) and driving the vehicle on city and highway roads. Continuing to drive with the check fuel cap warning light illuminated could cause the check engine light to illuminate as well.

Mirrors

▼ Mirrors

Before driving, adjust the inside and outside mirrors.

▼ Outside Mirrors

WARNING

Be sure to look over your shoulder before changing lanes:

Changing lanes without taking into account the actual distance of the vehicle in the convex mirror is dangerous. You could have a serious accident. What you see in the convex mirror is closer than it appears.

Mirror type

Flat type (driver's side)

Flat surface mirror.

Convex type (front passenger side)

The mirror has single curvature on its surface.

Power mirror adjustment

The ignition must be switched to ACC or ON position.

To adjust:

1. Press the select switch for the outside mirror to be adjusted to turn on the indicator light.

2. Press the adjustment switch to adjust the angle of the outside mirror.

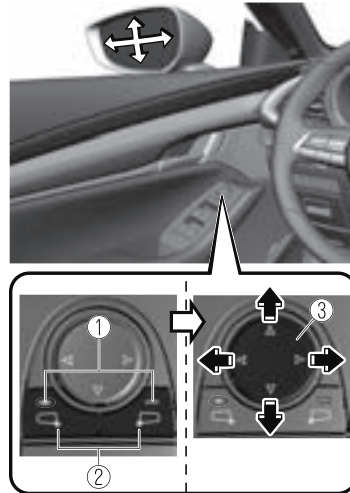

1. Indicator light
2. Select switch
3. Adjustment switch

After adjusting the angle of the outside mirror, press the select switch for the outside mirror to be adjusted to turn off the indicator light.

NOTE

(With driving position memory function)

The on-road outside mirror position can be programmed in conjunction with the driving position memory function.

Refer to Driving Position Memory on page 2-11.

Power mirrors with reverse tilt down function*

The outside mirrors tilt downward to facilitate the view of the lower area on each side of the vehicle.

1. Switch the ignition ON.
2. Press the select switch for the outside mirror to be tilted downward to turn on the indicator light of the select switch.
3. Shift the shift lever/selector lever to the R position to tilt the outer mirror on the side where the select button was pressed downward.

NOTE

When any of the following condition is met, the outer mirrors return to their normal positions.

- The ignition is switched to a position other than ON.
- The shift lever/selector lever is shifted to a position other than R.
- The select switch is pressed again.

Folding outside mirror



Always return the outside mirrors to the driving position before you start driving:

Driving with the outside mirrors folded in is dangerous. Your rear view will be restricted, and you could have an accident.

Manually fold the outside mirror rearward until it is flush with the vehicle.

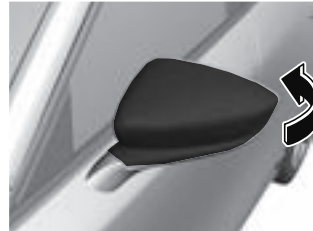

Engine-off outside mirror operation

The outside mirrors can be operated for about 40 seconds after the ignition is switched from ON to off.

Driver's side auto-dimming outside mirror*

The movement of the auto-dimming outside mirror is interlocked with the auto-dimming rearview mirror in the interior to automatically reduce glare from rear on-coming vehicles.

Refer to Rearview Mirror on page 3-32.

NOTE

The front passenger-side outside mirror does not have the auto-dimming feature.

▼ **Rearview Mirror**



Do not stack cargo or objects higher than the seatbacks:

Cargo stacked higher than the seatbacks is dangerous. It can block your view in the rearview mirror, which might cause you to hit another car when changing lanes.

Rearview mirror adjustment

Before driving, adjust the rearview mirror to center on the scene through the rear window.

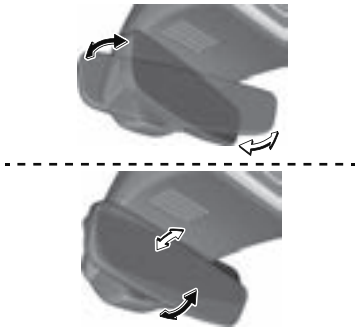

NOTE

For the manual day/night mirror, perform the adjustment with the day/night lever in the day position.

Reducing glare from headlights

Manual day/night mirror

Push the day/night lever forward for day driving. Pull it back to reduce glare of headlights from vehicles at the rear.

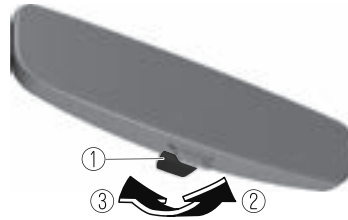

1. Day/Night lever
2. Night
3. Day

Auto-dimming mirror

The auto-dimming mirror automatically reduces the glare of headlights from vehicles at the rear when the ignition is switched ON.

(With ON/OFF button)

Press the ON/OFF button (Ⓞ) to cancel the auto-dimming function. The indicator light will turn off. To reactivate the auto-dimming function, press the ON/OFF button (Ⓞ). The indicator light will illuminate.

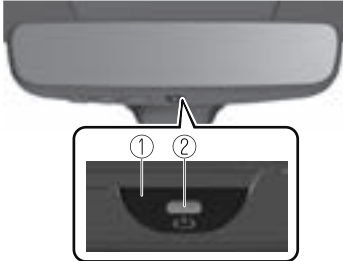

1. ON/OFF button
2. Indicator light

NOTE

- Do not use glass cleaner or suspend objects on or around the light sensor. Otherwise, light sensor sensitivity will be affected and may not operate normally.

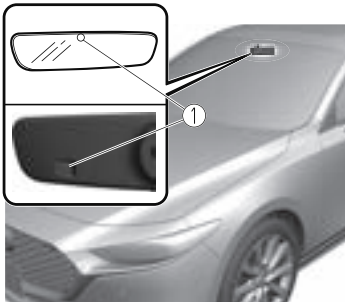

1. Light sensor

· **(With Homelink wireless control system)**

For information regarding the 3 buttons (■,■,■) on the auto-dimming mirror. Refer to Homelink Wireless Control System on page 4-60.

- The auto-dimming function is canceled when the ignition is switched ON and the shift lever/selector lever is in the R position.

Power Windows

▼ Power Windows

The windows can be opened/closed by operating the power window switches.



Make sure the opening is clear before closing a window:

Closing a power window is dangerous. A person's hands, head, or even neck could be caught by the window and result in serious injury or even death. This warning applies especially to children.

Never allow children to play with power window switches:

Power window switches that are not locked with the power window lock switch would allow children to operate power windows unintentionally, which could result in serious injury if a child's hands, head or neck becomes caught by the window.

Make sure nothing blocks the window just before it reaches the fully closed position or while fully holding up the power window switch:

Blocking the power window just before it reaches the fully closed position or while fully holding up the power window switch is dangerous. In this case, the jam-safe function may not prevent the window from closing all the way. If fingers are caught, serious injuries could occur.

Do not let a child put a hand or head out of the window while driving the vehicle:

If the person's hand or head hits something outside the vehicle, or sudden braking is applied, it could result in serious injury or death.

NOTE

When driving with only 1 of the rear windows open, your ears might experience a resonating sound. However, this does not indicate a problem. The sound can be reduced by slightly opening a front window or by changing the size of the rear window opening.

▼ Opening/Closing Windows

The window opens while the switch is pressed and it closes while the switch is pulled up with the ignition switched ON. Do not open or close 3 or more windows at the same time.

The front passenger's window and rear windows can be opened/closed when the power window lock switch on the driver's door is in the unlocked position. Keep this switch in the locked position while children are in the vehicle.

Master control switches

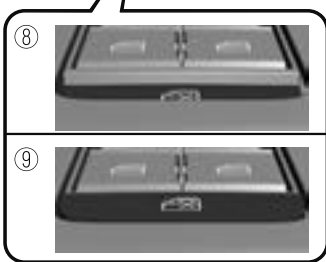
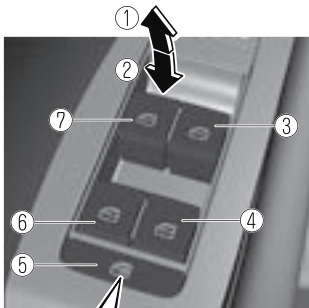

1. Close
2. Open
3. Front passenger's window
4. Right rear window
5. Power window lock switch
6. Left rear window
7. Driver's window
8. Locked position
9. Unlocked position

Front passenger's window switch/ Rear window switches

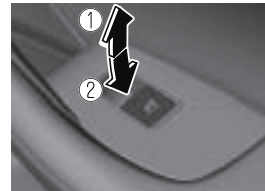

1. Close
2. Open

NOTE

- A power window may no longer open/close if you continue to press the switch for a long time. If the power window does not open/close, wait for a while and then operate the switch again.
- The passenger windows may be opened or closed using the master control switches on the driver's door.
- The power window can be operated for about 40 seconds after the ignition is switched from ON to ACC or off with all doors closed. If any door is opened, the power window will stop operating.

▼ Auto-opening/Closing

To fully open the window automatically, press the switch completely down, then release. The window will fully open automatically.

To fully close the window automatically, pull the switch completely up, then release. The window will fully close automatically.

To stop the window partway, pull or press the switch in the opposite direction and then release it.

NOTE

Power window system initialization procedure

If you operate the switch any number of times with the power window not fully closed, the window may no longer fully open/close automatically.

The power window auto function will only resume on a power window that has been reset.

1. Switch the ignition ON.
2. Make sure that the power window lock switch located on the driver's door is not depressed.
3. Press the switch and fully open the window.
4. Pull up the switch to fully close the window and continue holding the switch for about 2 seconds after the window fully closed.
5. Make sure that the power windows operate correctly using the door switches.

▼ Jam-safe Window

When the window is closing and a foreign object is detected between the window and the window frame, the window stops closing and automatically opens partway.

NOTE

· The jam-safe function may operate under the following conditions:

- A strong impact is detected while the window is closing.
- The window is closing in very low temperatures.

· **(A window cannot be closed)**

If the jam-safe function has operated and the window cannot be closed, check around the window frame for a foreign object.

If there is no foreign object around the window frame, forcibly close a window using the following procedure.

1. After switching the ignition OFF, wait for 45 seconds or longer.
2. Switch the ignition ON.
3. Operate the switch in the direction to close the window until the jam-safe function operates and the window stops. Repeat this operation a total of 5 times.
4. Continue pulling up the switch to fully close the window.

Moonroof*

▼ Moonroof

The moonroof can be opened or closed when operating the overhead tilt/slide switch at the front seats.

WARNING

Do not let passengers stand up or extend part of the body through the open moonroof while the vehicle is moving:

Extending the head, arms, or other parts of the body through the moonroof is dangerous. The head or arms could hit something while the vehicle is moving. This could cause serious injury or death.

Never allow children to play with the tilt/slide switch:

The tilt/slide switch would allow children to operate the moonroof unintentionally, which could result in serious injury if a child's hands, head or neck becomes caught by the moonroof.

Make sure the opening is clear before closing the moonroof:

A closing moonroof is dangerous. The hands, head, or even neck of a person, especially a child, could be caught in it as it closes, causing serious injury or even death.

Make sure nothing blocks the moonroof just before it reaches the fully closed position:

Blocking the moonroof just before it reaches the closed position is dangerous.

In this case, the jam-safe function cannot prevent the moonroof from closing. If fingers are caught, serious injuries could occur.

CAUTION

- Do not sit on or put heavy items on the area where the moonroof opens and closes. Otherwise, the moonroof could be damaged.
- Do not open or close the moonroof forcefully during freezing temperatures or snowfall. Otherwise, the moonroof could be damaged.
- The sunshade does not tilt. To avoid damaging the sunshade, do not push it up.
- Do not close the sunshade while the moonroof is opening. Trying to force the sunshade closed could damage it.

Windows

▼ Tilt/Slide Operation

The moonroof can be opened or closed electrically only when the ignition is switched ON.

- Before leaving the vehicle or washing your Mazda, make sure the moonroof is completely closed so that water does not get inside the cabin area.
- After washing your Mazda or after it rains, wipe the water off the moonroof before operating it to avoid water penetration which could cause rust and water damage to your headliner.

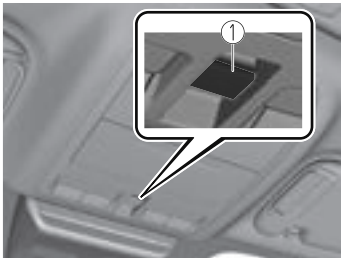

1. Tilt/Slide switch

Tilt Operation

The rear of the moonroof can be tilted open to provide more ventilation.

- To fully tilt automatically, momentarily press the tilt/slide switch.
- To fully close automatically, momentarily press the tilt/slide switch in the forward direction.
- To stop tilting partway, press the tilt/slide switch.

When the moonroof is already slid open and you want to tilt it open, first close the moonroof and then do a tilt operation.

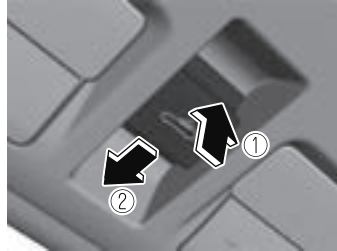

1. Tilt up
2. Close (Tilt down)

Slide Operation

- To fully open automatically, momentarily press the tilt/slide switch in the backward direction.
- To fully close automatically, momentarily press the tilt/slide switch in the forward direction.
- To stop sliding partway, press the tilt/slide switch.

When the moonroof is already tilted open and you want to slide it open, first close the moonroof and then do a slide operation.

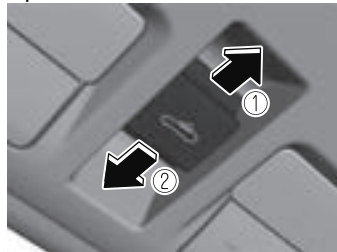

1. Open
2. Close

NOTE

If the moonroof does not operate normally, do the following procedure:

1. Switch the ignition ON.
2. Press the tilt switch, to partially tilt open the rear of the moonroof.
3. Repeat Step 2. The rear of the moonroof tilts open to the fully open position, then closes a little.

If the reset procedure is performed while the moonroof is in the slide position (partially open) it will close before the rear tilt opens.

▼ Jam-safe Moonroof

If a person's hands, head or an object blocks the moonroof while it is closing, the moonroof will stop and move in the open direction.

NOTE

- The jam-safe function may operate under the following conditions:
 - A strong impact is detected while the moonroof is closing automatically.
 - The moonroof is closing automatically during very low temperatures.
- In the event the jam-safe function activates and the moonroof cannot be closed automatically, press the tilt/slide switch and the moonroof will close.
- The jam-safe moonroof function does not operate until the system has been reset.

▼ Sunshade

The sunshade can be opened and closed by hand.

The sunshade opens at the same time as the moonroof slides open, but it must be closed by hand.

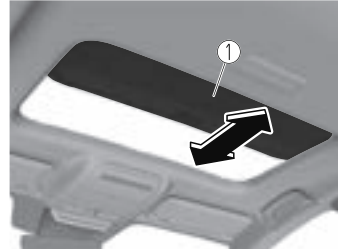

1. Sunshade

Modification and Add-On Equipment

▼ Modification and Add-On Equipment

Mazda cannot guarantee the immobilizer and the theft-deterrent system's operation if the system has been modified or if any add-on equipment has been installed.



To avoid damage to the vehicle, do not modify the system or install any add-on equipment to the immobilizer and the theft-deterrent systems or the vehicle.

Immobilizer System

▼ Immobilizer System

The immobilizer system allows the engine to start only with a key the system recognizes.

If someone attempts to start the engine with an unrecognized key, the engine will not start, thereby helping to prevent vehicle theft.

If you have a problem with the immobilizer system or the key, consult an Authorized Mazda Dealer.



- Radio equipment like this is governed by laws in the United States.
Changes or modifications not expressly approved by the party responsible for compliance could void the user's authority to operate the equipment.
- To avoid damage to the key, do not:
 - Drop the key.
 - Get the key wet.
 - Expose the key to any kind of magnetic field.
 - Expose the key to high temperatures on places such as the dashboard, under direct sunlight.
- If the engine does not start with the correct key, and the security indicator light keeps illuminating or flashing, the system may have a malfunction. Consult an Authorized Mazda Dealer.

NOTE

- The keys carry a unique electronic code. For this reason, and to assure your safety, obtaining a replacement key requires some waiting time. They are only available through an Authorized Mazda Dealer.
- Always keep a spare key in case one is lost. If a key is lost, consult an Authorized Mazda Dealer as soon as possible.
- If you lose a key, an Authorized Mazda Dealer will reset the electronic codes of your remaining keys and immobilizer system. Bring all the remaining keys to an Authorized Mazda Dealer to reset. Starting the vehicle with a key that has not been reset is not possible.

▼ Operation

NOTE

- The engine may not start and security indicator light may illuminate or flash if the key is placed in an area where it is difficult for the system to detect the signal, such as on the dashboard or in the glove compartment. Move the key to a location within the signal range, switch the ignition off, and then restart the engine.
- Signals from a TV or radio station, or from a transceiver or mobile telephone could interfere with your immobilizer system. If you are using the proper key and the engine fails to start, check the security indicator light.

Arming

The system is armed when the ignition is switched from ON to off. The security indicator light in the instrument cluster flashes every 2 seconds until the system is disarmed.



Disarming

The system is disarmed when the ignition is switched ON with the correct programmed key. The security indicator light illuminates for about 3 seconds and then turns off.

If the engine does not start with the correct key, and the security indicator light remains illuminated or flashing, try the following:

Make sure the key is within the operational range for signal transmission. Switch the ignition off, and then restart the engine. If the engine does not start after 3 or more tries, contact an Authorized Mazda Dealer.

Theft-Deterrent System *

▼ Theft-Deterrent System

If the theft-deterrent system detects an inappropriate entry into the vehicle, which could result in the vehicle or its contents being stolen, the alarm alerts the surrounding area of an abnormality by sounding the horn and flashing the hazard warning lights.

The system will not function unless it's properly armed. So when you leave the vehicle, follow the arming procedure correctly.

▼ Operation

System triggering conditions

The horn sounds intermittently and the hazard warning lights flash for about 30 seconds when the system is triggered by any one of the following:

- Unlocking a door with the auxiliary key, door lock switch, or an inside door-lock knob.
- Forcing open a door, the hood or the liftgate/trunk lid.
- Opening the hood by operating the hood release handle.
- Switching the ignition ON without using the push button start.

If the system is triggered again, the lights and horn will activate until the driver's door or the liftgate/trunk lid is unlocked with the transmitter.

(With the advanced keyless function)

The lights and horn can also be deactivated by touching the sensing area of the door release touch sensor.

NOTE

- If the battery goes dead while the theft-deterrent system is armed, the horn will activate and the hazard warning lights will flash when the battery is charged or replaced.

▼ How to Arm the System

1. Close the windows and the moonroof* securely.
2. Switch the ignition OFF.
3. Make sure the hood, the doors, and the liftgate/trunk lid are closed.
4. Press the lock button on the transmitter.

The hazard warning lights will flash once.

The following method will also arm the theft-deterrent system:

Press the door-lock switch “” while any door is open and then close all of the doors.

(With the advanced keyless function)

Touch the sensing area of the door lock touch sensor.

The security indicator light in the instrument cluster flashes twice per second for 20 seconds.



5. After 20 seconds, the system is fully armed.

NOTE

- The theft-deterrent system can also be armed by activating the auto relock function with all the doors, the liftgate/trunk lid and the hood closed.
Refer to Transmitter on page 3-5.
- The system will disarm if one of the following operations takes place within 20 seconds after pressing the lock button:
 - Unlocking any door.
 - Opening any door.
 - Opening the hood.
 - Switching the ignition ON.

To rearm the system, do the arming procedure again.

- When the doors are locked by pressing the lock button on the transmitter while the theft-deterrent system is armed, the hazard warning lights will flash once to indicate that the system is armed.

▼ To Turn Off an Armed System

An armed system can be turned off using any one of the following methods:

- Pressing the unlock button on the transmitter.
- Starting the engine with the push button start.
- **(With the advanced keyless function)**
 - Touching the sensing area of the door release touch sensor.

The hazard warning lights will flash twice.

NOTE

When the doors are unlocked by pressing the unlock button on the transmitter while the theft-deterrent system is turned off, the hazard warning lights will flash twice to indicate that the system is turned off.

▼ To Stop the Alarm

A triggered alarm can be turned off using any one of the following methods:

- Pressing the unlock button or the trunk button (4-door) on the transmitter.
- Starting the engine with the push button start.
- **(With the advanced keyless function)**
 - Touching the sensing area of the door release touch sensor.
 - Pressing the electric liftgate/trunk lid opener while the key is being carried.

The hazard warning lights will flash twice.

Break-In Period

▼ Break-In Period

No special break-in is necessary, but a few precautions in the first 1,000 km (600 miles) may add to the performance, economy, and life of the vehicle.

- Do not race the engine.
- Do not maintain one constant speed, either slow or fast, for a long period of time.
- Do not drive constantly at full-throttle or high engine rpm for extended periods of time.
- Avoid unnecessary hard stops.
- Avoid full-throttle starts.

Saving Fuel and Protection of the Environment

▼ Saving Fuel and Protection of the Environment

How you operate your Mazda determines how far it will travel on a tank of fuel. Use these suggestions to help save fuel and reduce CO₂.

- Avoid long warm-ups. Once the engine runs smoothly, begin driving.
- Avoid fast starts.
- Drive at lower speeds.
- Anticipate when to apply the brakes (avoid sudden braking).
- Follow the maintenance schedule and have an Authorized Mazda Dealer perform inspections and servicing.
Refer to Scheduled Maintenance (U.S.A. and Puerto Rico) on page 6-4.
Refer to Scheduled Maintenance (Canada) on page 6-6.
Refer to Scheduled Maintenance (Mexico) on page 6-9.
- Use the air conditioner only when necessary.
- Slow down on rough roads.
- Keep the tires properly inflated.
- Do not carry unnecessary weight.
- Do not rest your foot on the brake pedal while driving.
- Keep the wheels in correct alignment.
- Keep windows closed at high speeds.
- Slow down when driving in crosswinds and headwinds.

 **WARNING**

Never stop the engine when going down a hill:

Stopping the engine when going down a hill is dangerous. This causes the loss of power steering and power brake control, and may cause damage to the drivetrain. Any loss of steering or braking control could cause an accident.

Hazardous Driving

▼ **Hazardous Driving**

 **WARNING**

Be extremely careful if it is necessary to downshift on slippery surfaces:

Downshifting into lower gear while driving on slippery surfaces is dangerous. The sudden change in tire speed could cause the tires to skid. This could lead to loss of vehicle control and an accident.

When driving on ice or in water, snow, mud, sand, or similar hazards:

- Be cautious and allow extra distance for braking.
- Avoid sudden braking and sudden maneuvering.
- Do not pump the brakes. Continue to press down on the brake pedal. Refer to Antilock Brake System (ABS) on page 4-77.
- If you get stuck, select a lower gear and accelerate slowly. Do not spin the front wheels.
- For more traction in starting on slippery surfaces such as ice or packed snow, use sand, rock salt, chains, carpeting, or other nonslip material under the front wheels.

NOTE

Use snow chains only on the front wheels.

Floor Mat

▼ Floor Mat

We recommend the use of Genuine Mazda floor mats.

WARNING

Make sure the floor mats are hooked on the retention pins to prevent them from bunching up under the foot pedals:

Using a floor mat that is not secured is dangerous as it will interfere with the accelerator and brake pedal operation, which could result in an accident.

Do not install two floor mats, one on top of the other, on the driver's side: Installing two floor mats, one on top of the other, on the driver's side is dangerous as the retention pins can only keep one floor mat from sliding forward.

Loose floor mat(s) will interfere with the foot pedals and could result in an accident.

If using an all-weather mat for winter use always remove the original floor mat.

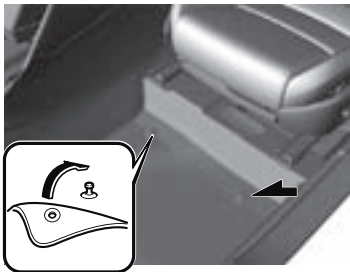

When setting a floor mat, position the floor mat so that its grommets are inserted over the pointed end of the retention posts.

Rocking the Vehicle

▼ Rocking the Vehicle

WARNING

Do not spin the wheels at more than 56 km/h (35 mph), and do not allow anyone to stand behind a wheel when pushing the vehicle:

When the vehicle is stuck, spinning the wheels at high speed is dangerous. The spinning tire could overheat and explode. This could cause serious injuries.

CAUTION

Too much rocking may cause engine overheating, transmission failure, and tire damage.

If you must rock the vehicle to free it from snow, sand or mud, depress the accelerator slightly and slowly move the shift lever/selector lever from 1 (D) to R position.

Winter Driving

▼ Winter Driving

Carry emergency gear, including tire chains, window scraper, flares, a small shovel, jumper cables, and a small bag of sand or salt.

Ask an Authorized Mazda Dealer to check the following:

- Have the proper ratio of antifreeze in the radiator.
Refer to Engine Coolant on page 6-20.
- Inspect the battery and its cables. Cold reduces battery capacity.
- Use an engine oil appropriate for the lowest ambient temperatures that the vehicle will be driven in (page 6-17).
- Inspect the ignition system for damage and loose connections.
- Use washer fluid made with antifreeze—but do not use engine coolant antifreeze for washer fluid (page 6-22).

NOTE

- Remove snow before driving. Snow left on the windshield is dangerous as it could obstruct vision.
- Do not apply excessive force to a window scraper when removing ice or frozen snow on the mirror glass and windshield.
- Never use warm or hot water for removing snow or ice from windows and mirrors as it could result in the glass cracking.

- Drive slowly. Braking performance can be adversely affected if snow or ice adheres to the brake components. If this situation occurs, drive the vehicle slowly, releasing the accelerator pedal and lightly applying the brakes several times until the brake performance returns to normal.

▼ Snow Tires

Use snow tires on all 4 wheels

Do not go faster than 120 km/h (75 mph) while driving with snow tires. Inflate snow tires 30 kPa (0.3 kgf/cm², 4.3 psi) more than recommended on the tire pressure label (driver's door frame), but never more than the maximum cold-tire pressure shown on the tires.

Mexico

The vehicle is originally equipped with summer tires designed for optimum traction on wet and dry roads. If your vehicle is to be used on snow and ice covered roads, Mazda recommends that you replace the tires originally equipped on your vehicle with snow tires during the winter months.

Except Mexico

The vehicle is originally equipped with all season radials designed to be used all year around. In some extreme climates you may find it necessary to replace them with snow tires during the winter months to further improve traction on snow and ice covered roads.

WARNING

Use only the same size and type tires (snow, radial, or non-radial) on all 4 wheels:

Using tires different in size or type is dangerous. Your vehicle's handling could be greatly affected and result in an accident.

CAUTION

Check local regulations before using studded tires.

NOTE

The tire pressure monitoring system may not function correctly when using tires with steel wire reinforcement in the sidewalls (page 4-220).

▼ Tire Chains

Check local regulations before using tire chains.

CAUTION

- Chains may affect handling.
- Do not go faster than 50 km/h (30 mph) or the chain manufacturer's recommended limit, whichever is lower.
- Drive carefully and avoid bumps, holes, and sharp turns.
- Avoid locked-wheel braking.
- Do not use chains on a temporary spare tire; it may result in damage to the vehicle and to the tire.
- Do not use chains on roads that are free of snow or ice. The tires and chains could be damaged.
- Chains may scratch or chip aluminum wheels.

NOTE

- The tire pressure monitoring system may not function correctly when using tire chains.

Install the chains on the front tires only. Do not use chains on the rear tires. Please consult an Authorized Mazda Dealer.

Installing the chains

1. If your vehicle is equipped with wheel covers remove them, otherwise the chain bands will scratch them.
2. Secure the chains on the front tires as tightly as possible. Always follow the chain manufacturer's instructions.
3. Retighten the chains after driving 1/2—1 km (1/4—1/2 mile).

Driving In Flooded Area

▼ Driving In Flooded Area

WARNING

Dry off brakes that have become wet by driving slowly, releasing the accelerator pedal and lightly applying the brakes several times until the brake performance returns to normal: Driving with wet brakes is dangerous. Increased stopping distance or the vehicle pulling to one side when braking could result in a serious accident. Light braking will indicate whether the brakes have been affected.

CAUTION

Do not drive the vehicle on flooded roads as it could cause short circuiting of electrical/electronic parts, or engine damage or stalling from water absorption. If the vehicle has been immersed in water, consult an Authorized Mazda Dealer.

Overloading

▼ Overloading

WARNING

Be careful not to overload your vehicle:

The gross axle weight rating (GAWR) and the gross vehicle weight rating (GVWR) of the vehicle are on the Motor Vehicle Safety Standard Label on the driver's door frame. Exceeding these ratings can cause an accident or vehicle damage. You can estimate the weight of the load by weighing the items (or people) before putting them in the vehicle.

Driving on Uneven Road

▼ Driving on Uneven Road

Your vehicle's suspension and underbody can be damaged if driven on rough/uneven roads or over speed bumps at excessive speeds. Use care and reduce speed when traveling on rough/uneven roads or over speed bumps.

Use care not to damage the vehicle's underbody, bumpers or muffler(s) when driving under the following conditions:

- Ascending or descending a slope with a sharp transition angle
- Ascending or descending a driveway or trailer ramp with a sharp transition angle

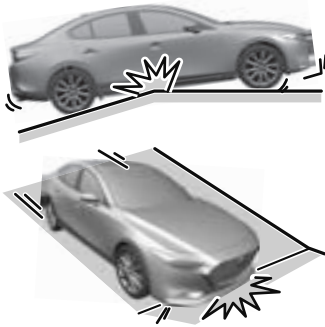

This vehicle is equipped with low profile tires allowing class-leading performance and handling. As a result, the sidewall of the tires are very thin and the tires and wheels can be damaged if driven through potholes or on rough/uneven roads at excessive speeds. Use care and reduce speed when traveling on rough/uneven roads or through potholes.

Turbocharger Information (SKYACTIV-G 2.5T)

▼ Turbocharger Information (SKYACTIV-G 2.5T)

⚠ CAUTION

- After driving at freeway speeds or up a long hill, idle the engine at least 30 seconds before stopping it. Otherwise, the turbocharger could be damaged.
- Racing or over-revving the engine, particularly after it's just been started, can damage the turbocharger.
- To protect the engine from damage, the engine is designed so that it cannot be raced just after starting it in extremely cold weather.

The turbocharger greatly enhances engine power. Its advanced design provides improved operation and requires minimum maintenance.

To get the most from it, observe the following.

1. Change engine oil and filter according to Scheduled Maintenance. Refer to Scheduled Maintenance (U.S.A. and Puerto Rico) on page 6-4. Refer to Scheduled Maintenance (Canada) on page 6-6. Refer to Scheduled Maintenance (Mexico) on page 6-9.
2. Use only recommended engine oil (page 6-17). Extra additives are NOT recommended.

Trailer Towing

▼ Trailer Towing

Your Mazda is not designed for towing. Never tow a trailer with your Mazda.

Recreational Towing

▼ Recreational Towing

An example of "recreational towing" is towing your vehicle behind a motorhome.

The transmission is not designed for towing this vehicle on all 4 wheels.

When doing recreational towing refer to "Towing Description" (page 7-23) and "Tiedown Hooks" (page 7-24) and carefully follow the instructions.

MEMO

4

When Driving

Information concerning safe driving and stopping.

Start/Stop Engine.....	4-4
Ignition Switch.....	4-4
Starting the Engine.....	4-5
Turning the Engine Off.....	4-10
Cylinder Deactivation.....	4-11
Instrument Cluster and Display.....	4-12
Instrument Cluster and Display.....	4-12
Instrument Cluster.....	4-12
Active Driving Display*.....	4-30
Manual Transmission Operation.....	4-33
Manual Transmission Shift Pattern.....	4-33
Automatic Transmission.....	4-35
Automatic Transmission Controls.....	4-35
Shift-Lock System.....	4-36
Transmission Ranges.....	4-37
Manual Shift Mode.....	4-38
Direct Mode*.....	4-44
Driving Tips.....	4-45
Switches and Controls.....	4-46
Lighting Control.....	4-46
Turn and Lane-Change Signals.....	4-52
Windshield Wipers and Washer.....	4-53
Rear Window Wiper and Washer*.....	4-57
Rear Window Defogger.....	4-58
Horn.....	4-59
Hazard Warning Flasher.....	4-60
HomeLink Wireless Control System*.....	4-60
Brake.....	4-65
Brake System.....	4-65
AUTOHOLD.....	4-71
Hill Launch Assist (HLA).....	4-75
ABS/TCS/DSC.....	4-77
Antilock Brake System (ABS).....	4-77
Traction Control System (TCS).....	4-78
Dynamic Stability Control (DSC).....	4-79
Drive Selection.....	4-81
Drive Selection*.....	4-81
i-ACTIV AWD.....	4-83
i-ACTIV AWD Operation*.....	4-83
Power Steering.....	4-84
Power Steering.....	4-84
i-ACTIVSENSE.....	4-85
i-ACTIVSENSE*.....	4-85

*Some models.

Adaptive Front Lighting System (AFS)*	4-90
High Beam Control System (HBC)*	4-90
Lane Departure Warning System (LDWS)*	4-92
Blind Spot Monitoring (BSM)*	4-96
Traffic Sign Recognition System (TSR)*	4-101
Distance & Speed Alert (DSA)*	4-108
Driver Attention Alert (DAA)*	4-109
Driver Monitoring (DM)*	4-111
Front Cross Traffic Alert (FCTA)*	4-113
Rear Cross Traffic Alert (RCTA)*	4-116
Mazda Radar Cruise Control (MRCC) (Manual Transmission)*	4-120
Mazda Radar Cruise Control with Stop & Go function (MRCC with Stop & Go function) (Automatic Transmission)*	4-128
Traffic Jam Assist (TJA)*	4-139
Lane-keep Assist System (LAS)*	4-154
Smart Brake Support (SBS)*	4-158

Smart Brake Support [Rear] (SBS-R)*	4-160
Smart Brake Support [Rear Crossing] (SBS-RC)*	4-164
360° View Monitor*	4-168
Forward Sensing Camera (FSC)*	4-203
Front Radar Sensor*	4-207
Front Side Radar Sensor*	4-209
Rear Side Radar Sensor*	4-211
Rear/Rear corner/Rear Side Ultrasonic Sensor*	4-212
Front Camera/Side Cameras/Rear Camera*	4-213
Driver Monitoring Camera*	4-214

Cruise Control	4-215
Cruise Control*	4-215

Tire Pressure Monitoring System (TPMS)	4-219
Tire Pressure Monitoring System (TPMS).....	4-219

Rear View Monitor	4-223
Rear View Monitor*	4-223

Parking Sensor System	4-238
Parking Sensor System*	4-238

MEMO

Ignition Switch

▼ Push Button Start Positions

The system operates only when the key is within operational range.

Each time the push button start is pressed, the ignition switches in the order of off, ACC, and ON. Pressing the push button start again from ON switches the ignition off.

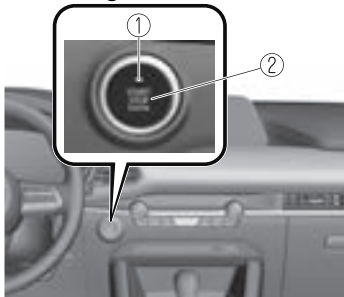

1. Indicator light
2. Push button start

NOTE

- The engine starts by pressing the push button start while depressing the clutch pedal (manual transmission) or the brake pedal (automatic transmission). To switch the ignition position, press the push button start without depressing the pedal.
- Do not leave the ignition switched ON while the engine is not running. Doing so could result in the battery going dead. If the ignition is left in ACC (For automatic transmission, the selector lever is in the P position, and the ignition is in ACC), the ignition switches off automatically after about 25 minutes.

Off

The power supply to electrical devices turns off and the indicator light (amber) also turns off.

WARNING

Before leaving the driver's seat, always switch the ignition off, set the parking brake, and make sure the selector lever is in P (automatic transmission) position or in 1st gear or R (manual transmission):

Leaving the driver's seat without switching the ignition off, setting the parking brake, and shifting the selector lever to P (automatic transmission) position or to 1st gear or R (manual transmission) is dangerous.

Unexpected vehicle movement could occur which could result in an accident.

In addition, if your intention is to leave the vehicle for even a short period, it is important to switch the ignition off, as leaving it in another position will disable some of the vehicle's security systems and run the battery down.

ACC (Accessory)

Some electrical accessories will operate and the indicator light (amber) illuminates.

NOTE

The keyless entry system does not function while the push button start has been pressed to ACC, and the doors will not lock/unlock even if they have been locked manually.

ON

This is the normal running position after the engine is started. The indicator light (amber) turns off. (The indicator light (amber) illuminates when the ignition is switched ON and the engine is not running.)

Some indicator lights/warning lights should be inspected before the engine is started.

Refer to Warning/Indicator Lights on page 4-23.

Refer to Indication/Indicator Lights on page 4-25.

NOTE

When the push button start is pressed to ON, the sound of the fuel pump motor operating near the fuel tank can be heard. This does not indicate an abnormality.

Starting the Engine

▼ Starting the Engine

WARNING

Radio waves from the key may affect medical devices such as pacemakers:

Before using the key near people who use medical devices, ask the medical device manufacturer or your physician if radio waves from the key will affect the device.

NOTE

- The key must be carried because the key carries an immobilizer chip that must communicate with the engine controls at short range.
- The engine can be started when the push button start is pressed from off, ACC, or ON.
- The push button start system functions (function which can start the engine by only carrying the key) can be deactivated to prevent any possible adverse effect on a user wearing a pacemaker or other medical device. If the system is deactivated, you will be unable to start the engine by carrying the key. Consult an Authorized Mazda Dealer for details. If the push button start system functions have been deactivated, you can start the engine by following the procedure indicated when the key battery goes dead. Refer to Engine Start Function When Key Battery is Dead on page 4-8.
- After starting a cold engine, the engine speed increases and a whining sound from the engine compartment can be heard.

Start/Stop Engine

This is for improved exhaust gas purification and does not indicate any parts defect.

- Engine-starting is controlled by the spark ignition system.

This system meets all Canadian Interference-Causing Equipment Standard requirements regulating the impulse electrical field strength of radio noise.

1. Make sure you are carrying the key.
2. Occupants should fasten their seat belts.
3. Make sure the parking brake is on.
4. Continue to depress the brake pedal firmly until the engine has completely started.

5. **(Manual transmission)**

Continue to depress the clutch pedal firmly until the engine has completely started.

(Automatic transmission)

Put the vehicle in park (P). If you must restart the engine while the vehicle is moving, shift into neutral (N).

NOTE

- **(Manual transmission)**

The starter will not operate if the clutch pedal is not depressed sufficiently.

- **(Automatic transmission)**

The starter will not operate if the selector lever is not in P or N position and the brake pedal is not depressed sufficiently.

6. Make sure that the KEY indicator light (green) in the instrument cluster and push button start indicator light (green) turns on.

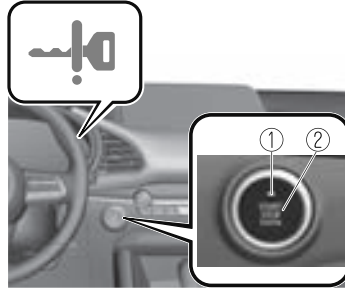

1. Indicator light
2. Push button start

NOTE

- If the push button start indicator light (green) flashes, make sure that the key is being carried.
- If the push button start indicator light (green) flashes with the key being carried, touch the key to the push button start and start the engine.

Refer to Engine Start Function When Key Battery is Dead on page 4-8.

CAUTION

If the KEY warning indication (red) is displayed, or the push button start indicator light (amber) flashes, this could indicate a problem with the engine starting system. This may prevent the engine from starting or from switching the ignition to ACC or ON.

Refer to KEY Warning Indication/Warning Light (Red) on page 7-33.

Have your vehicle inspected at an Authorized Mazda Dealer as soon as possible.

NOTE

- Under the following conditions, the KEY warning indication (red) is displayed after the push button start is pressed. This informs the driver that the push button start will not switch to ACC, even if it is pressed from off (page 7-33).
 - The key battery is dead.
 - The key is out of operational range.
 - The key is placed in areas where it is difficult for the system to detect the signal (page 3-7).
 - A key from another manufacturer similar to the key is in the operational range.
- **(Forced engine starting method)**
If the KEY warning indication (red) is displayed, or the push button start indicator light (amber) flashes, this could indicate that the engine may not start using the usual starting method (page 7-33). Have your vehicle inspected at an Authorized Mazda Dealer as soon as possible. If this occurs, the engine can be force-started. Press and hold the push button start until the engine starts. Other procedures necessary for starting the engine, such as having the key in the cabin, and depressing the clutch pedal (manual transmission) or the brake pedal (automatic transmission) are required.

- When the engine is force-started, the KEY warning indication (red) remains displayed and the push button start indicator light (amber) remains flashing.
- **(Automatic transmission)**
When the selector lever is in the neutral (N) position, the push button start indicator light (green) does not turn on.

7. Press the push button start after the push button start indicator light (green) turns on.

NOTE

- After starting the engine, the push button start indicator light (amber) turns off and the ignition switches to the ON position.
 - After pressing the push button start and before the engine starts, the operation sound of the fuel pump motor from near the fuel tank can be heard, however, this does not indicate a malfunction.
8. After starting the engine, let it idle for about 10 seconds.

NOTE

- Do not use high engine speeds until reaching the operating temperature.
- Whether the engine is cold or warm, it should be started without the use of the accelerator.
- If the engine does not start the first time, refer to Starting a Flooded Engine under Emergency Starting. If the engine still does not start, have your vehicle inspected by an Authorized Mazda Dealer (page 7-20).

Start/Stop Engine

▼ Engine Start Function When Key Battery is Dead



When starting the engine by holding the transmitter over the push button start due to a dead key battery or a malfunctioning key, be careful not to allow the following, otherwise the signal from the key will not be received correctly and the engine may not start.

- Metal parts of other keys or metal objects touch the key.



- Spare keys or keys for other vehicles equipped with an immobilizer system touch or come near the key.



- Devices for electronic purchases, or security passage touch or come near the key.

If the engine cannot be started due to a dead key battery, the engine can be started using the following procedure:

1. Continue to depress the brake pedal firmly until the engine has completely started.
2. **(Manual transmission)** Continue to depress the clutch pedal firmly until the engine has completely started.
(Automatic transmission) Put the vehicle in park (P). If you must restart the engine while the vehicle is moving, shift into neutral (N).
3. Make sure that the push button start indication light (green) flashes.
4. Align the center area of the emblem on the transmitter with the center area of the push button start indicator light (green) flashes.

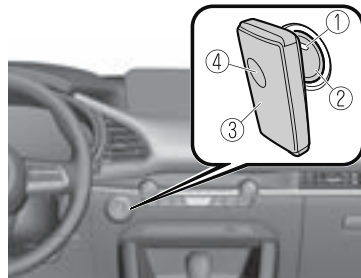

1. Indicator light
2. Push button start
3. Transmitter
4. Emblem
5. Make sure that the push button start indicator light (green) turns on.
6. Press the push button start to start the engine.

NOTE

- The engine cannot be started unless the clutch pedal is fully depressed (manual transmission) or the brake pedal is fully depressed (automatic transmission).
- If there is a malfunction with the push button start function, the push button start indicator light (amber) flashes. In this case, the engine may start, however, have the vehicle checked at an Authorized Mazda Dealer as soon as possible.
- If the push button start indicator light (green) does not illuminate, perform the operation from the beginning again. If it does not illuminate, have the vehicle checked at an Authorized Mazda Dealer.
- To switch the ignition position without starting the engine, perform the following operations after the push button start indicator light (green) turns on.
 1. Release the clutch pedal (manual transmission) or brake pedal (automatic transmission).
 2. Press the push button start to switch the ignition position. The ignition switches in the order of ACC, ON, and off each time the push button start is pressed. To switch the ignition position again, perform the operation from the beginning.

▼ Emergency Operation for Starting the Engine

If the KEY warning indication (red) is displayed, or the push button start indicator light (amber) flashes, this could indicate that the engine may not start using the usual starting method. Have your vehicle inspected at an Authorized Mazda Dealer as soon as possible. If this occurs, the engine can be force-started. Press and hold the push button start until the engine starts. Other procedures necessary for starting the engine such as having the key in the cabin, and depressing the clutch pedal (manual transmission) or the brake pedal (automatic transmission) are required.

Turning the Engine Off

▼ Turning the Engine Off



Do not stop the engine while the vehicle is moving:

Stopping the engine while the vehicle is moving for any reason other than in an emergency is dangerous. Stopping the engine while the vehicle is moving will result in reduced braking ability due to the loss of power braking, which could cause an accident and serious injury.

1. Stop the vehicle completely.
2. **(Manual transmission)**
Shift into neutral and set the parking brake.
(Automatic transmission)
Shift the selector lever to the P position and set the parking brake.
3. Press the push button start to turn off the engine. The ignition position is off.



- When leaving the vehicle, make sure the push button start is off.

NOTE

- **(SKYACTIV-G 2.0, SKYACTIV-G 2.5)**
The cooling fan in the engine compartment could turn on for a few minutes after the ignition is switched from ON to OFF, whether or not the A/C is on or off, to cool the engine compartment quickly.
- If the system detects that the remaining battery power of the key is low when the ignition is switched from ON to ACC or OFF, the following is indicated.
Replace with a new battery before the key becomes unusable.
Refer to Key Battery Replacement on page 6-31.
A message is indicated in the display of the instrument cluster.
Refer to KEY Warning Indication/Warning Light (Red) on page 7-33.
- **(Automatic transmission)**
If the engine is turned off while the selector lever is in a position other than P, the ignition switches to ACC.

▼ Emergency Engine Stop

Continuously pressing the push button start or quickly pressing it any number of times while the engine is running or the vehicle is being driven will turn the engine off immediately. The ignition switches to ACC.

Cylinder Deactivation

▼ Cylinder Deactivation

The cylinder deactivation is a function designed to reduce fuel consumption and improve fuel economy by deactivating 2 out of the 4 cylinders while driving. The function constantly determines which is better for driving; 4 cylinders or 2 cylinders, regardless of the driver's operations, and it performs the switching automatically.

When the cylinder deactivation function does not operate

The cylinder deactivation function does not operate under the following conditions.

- The selector lever is in the P, N, or R position (automatic transmission), or 1st gear (manual transmission).
- The engine oil temperature or engine coolant temperature is low.
- After disconnecting the battery terminals for some reason, such as for battery replacement.

Instrument Cluster and Display

Instrument Cluster and Display

▼ Instrument Cluster and Display

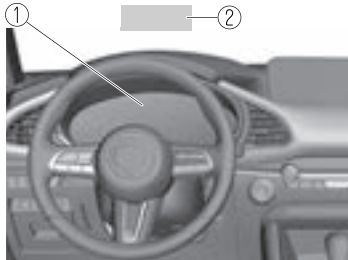

- ① Instrument Cluster..... page 4-12
- ② Active Driving Display..... page 4-30

Instrument Cluster

▼ Instrument Cluster

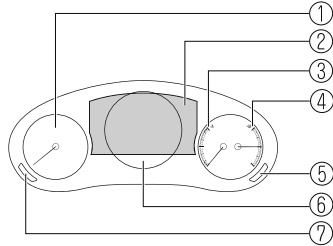

- ① Tachometer..... page 4-13
- ② Multi-information Display.....
..... page 4-14
- ③ Engine Coolant Temperature
Gauge..... page 4-17
- ④ Fuel Gauge..... page 4-17
- ⑤ Dashboard Illumination
Switch..... page 4-18
- ⑥ Speedometer..... page 4-12
- ⑦ TRIP Switch..... page 4-16

▼ Speedometer

The speedometer indicates the speed of the vehicle.

▼ Tachometer

The tachometer shows engine speed in thousands of revolutions per minute (rpm).



Do not run the engine with the tachometer needle in the RED ZONE. This may cause severe engine damage.

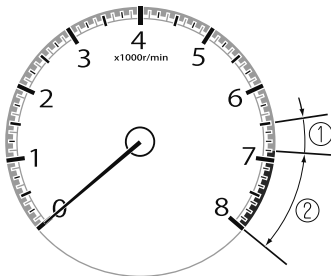

1. STRIPED ZONE*¹
2. RED ZONE*¹

*¹ The range varies depending on the type of gauge.

NOTE

When the tachometer needle enters the STRIPED ZONE, this indicates to the driver that the gears should be shifted before entering the RED ZONE.

Instrument Cluster and Display

▼ Multi-information Display

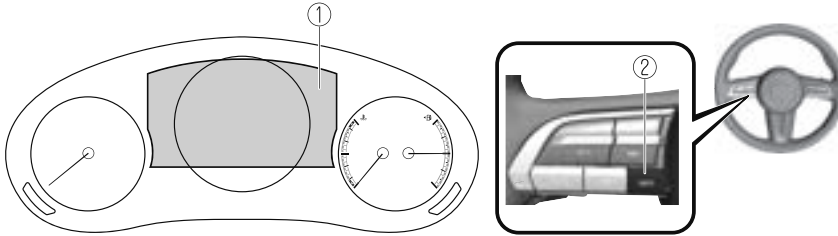

1. Multi-information Display
2. INFO switch

The multi-information display indicates the following information.

- Speedometer
- Odometer
- Trip meter
- Outside temperature
- Distance-to-empty
- Average fuel economy
- Current fuel economy
- i-ACTIVSENSE Display
- Compass Display
- Door-Ajar/Trunk lid-Ajar/Liftgate-Ajar Warning Indication*¹
- Message Display

*¹ Displayed when opening door/trunk lid/liftgate.

The screen content changes each time the INFO switch is pressed.

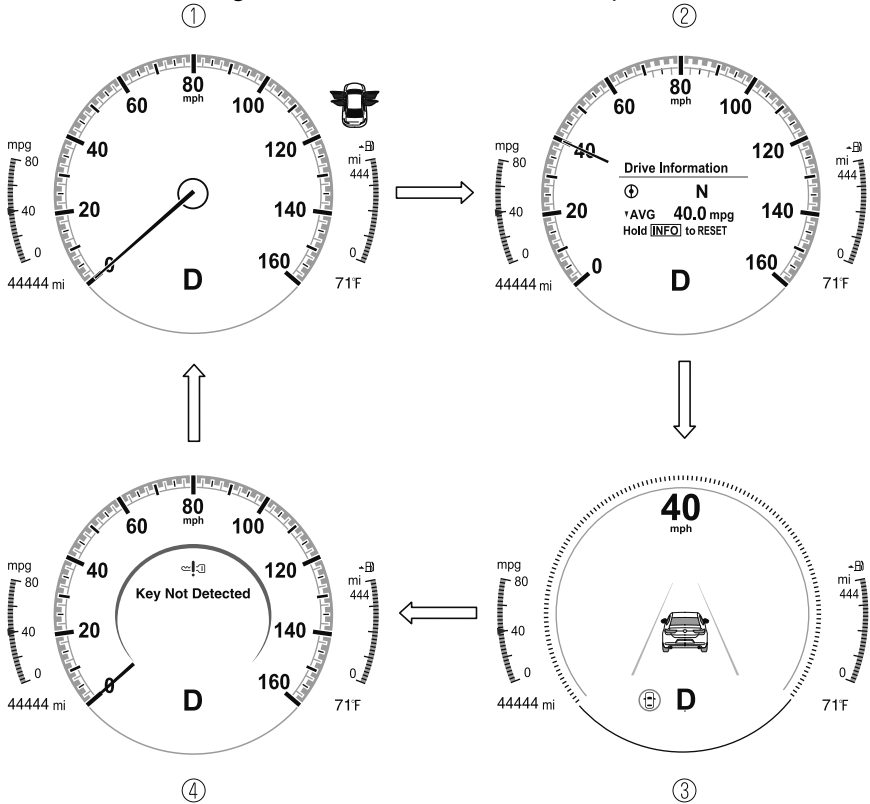

1. Basic display
2. Drive information display
3. i-ACTIVSENSE display
4. Message display*¹

*¹ Displayed only when a warning occurs.

The type of display for the fuel economy and the maximum driving distance can be changed.

Refer to the Settings section in the Mazda Connect Owner's Manual.

Instrument Cluster and Display

▼ Odometer, Trip Meter and Trip Meter Selector

You can switch between the odometer and trip meter display using the TRIP switch.

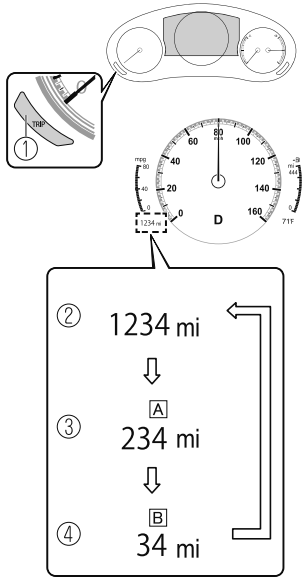

1. TRIP switch
2. Odometer display
3. Trip meter A display
4. Trip meter B display

Odometer

The odometer records the total distance the vehicle has been driven.

Trip meter

The driving distance for a specified interval is indicated. Two types (TRIP A, TRIP B) of interval distance can be measured.

For instance, trip meter A can record the distance from the point of origin, and trip meter B can record the distance from where the fuel tank is filled.

When trip meter A is selected, TRIP A will be displayed. When trip meter B is selected, TRIP B will be displayed.

The trip meter can be reset by pressing the TRIP switch for 1.5 seconds or more while the trip meter is displayed.

NOTE

Only the trip meters record tenths of kilometers (miles).

▼ Engine Coolant Temperature Gauge

Displays the engine coolant temperature. The blue range of the gauge indicates that the engine coolant temperature is low, and the red range of the gauge indicates that the engine coolant temperature is high and overheating.

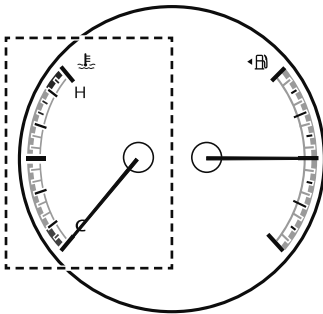

⚠ CAUTION

When the engine coolant temperature gauge needle is in the red range, the engine coolant temperature is extremely high. Drive slowly to reduce engine load. If the engine coolant temperature gauge needle is in the red range, there is the possibility of overheating. Park the vehicle in a safe place immediately and take appropriate measures. Refer to Overheating on page 7-21.

NOTE

- If the engine or engine coolant temperature is high or low, the engine output may be restricted to protect the engine.

▼ Fuel Gauge

The fuel gauge shows approximately how much fuel is remaining in the tank when the ignition is switched ON. We recommend keeping the tank over 1/4 full.

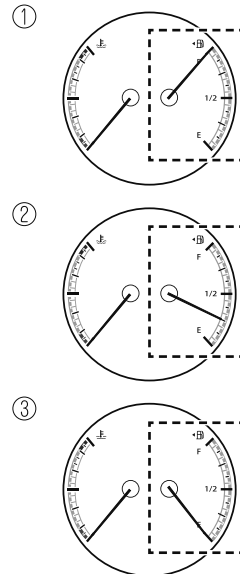

1. Full
2. 1/4 Full
3. Empty

Instrument Cluster and Display

If the low fuel warning light illuminates or the fuel level is very low, refuel as soon as possible.

If inconsistency in engine performance or stalling occurs due to low fuel level conditions, refuel the vehicle as soon as possible and add at least 10 L (2.7 US gal, 2.2 Imp gal) of fuel.

Refer to Low Fuel Warning Indication/Warning Light on page 7-35.

NOTE

- After refueling, it may require some time for the indicator to stabilize. In addition, the indicator may deviate while driving on a slope or curve since the fuel moves in the tank.
- The direction of the arrow (◀ ) indicates that the fuel-filler lid is on the left side of the vehicle.

▼ Dashboard Illumination

(Without auto-light control)

When the lights are turned on with the ignition switched ON, the brightness of the dashboard illumination is dimmed.

(With auto-light control)

When the lights are turned on with the ignition switched ON, the brightness of the dashboard illumination is dimmed. However, when the light sensor detects that the surrounding area is bright such as when the lights are turned on in the daytime, the dashboard illumination does not dim.

NOTE

- **(With auto-light control)**
When the ignition is switched ON in the early evening or at dusk, the dashboard illumination is dimmed for several seconds until the light sensor detects the brightness of the surrounding area, however, the dimming may cancel after the brightness is detected.
- When the lights are turned on, the lights-on indicator light in the instrument cluster turns on.
Refer to Headlights on page 4-46.

The brightness of the instrument panel and dashboard illuminations can be adjusted by pressing the dashboard illumination switch while the dashboard illumination is dimmed.

- The brightness increases by pressing the + switch.
- The brightness decreases by pressing the - switch. If you press the - switch while the instrument cluster is at maximum dimness, a sound is activated to notify you that the current dimmer setting is at maximum dimness.

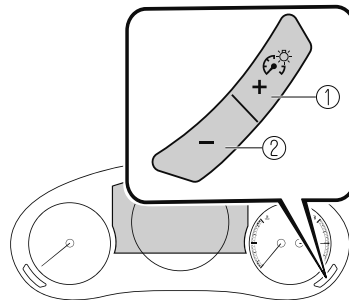

1. Bright
2. Dim

Instrument Cluster and Display

Function for canceling illumination dimmer

The illumination dimmer can be canceled by pressing the + switch while the instrument cluster is at maximum dimness and while the ignition is switched ON. If you press the + switch again while the illumination dimmer is canceled, a sound is activated to notify you that it is canceled. If the instrument cluster's visibility is reduced due to glare from surrounding brightness, cancel the illumination dimmer.

NOTE

- When the illumination dimmer is canceled, the instrument cluster cannot be dimmed even if the lights are turned on.
- When the illumination dimmer is canceled, the screen in the center display switches to constant display of the daytime screen.

▼ Outside Temperature Display

When the ignition is switched ON, the outside temperature is displayed.

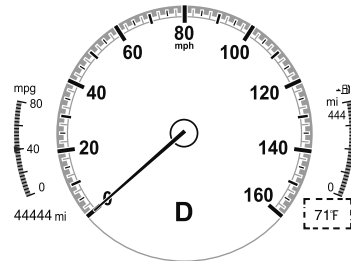

NOTE

- Under the following conditions, the outside temperature display may differ from the actual outside temperature depending on the surroundings and vehicle conditions:
 - Significantly cold or hot temperatures.
 - Sudden changes in outside temperature.
 - The vehicle is parked.
 - The vehicle is driven at low speeds.

Changing the Temperature Unit of the Outside Temperature Display

The outside temperature unit can be switched between Celsius and Fahrenheit.

Settings can be changed by operating the center display screen.

Refer to the Settings section in the Mazda Connect Owner's Manual.

Instrument Cluster and Display

▼ Distance-to-empty

This displays the approximate distance you can travel on the remaining fuel based on the fuel economy. The distance-to-empty will be calculated and displayed every second.

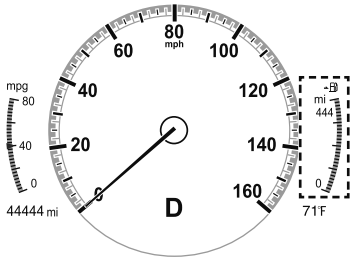

NOTE

- Even though the distance-to-empty display may indicate a sufficient amount of remaining driving distance before refueling is required, refuel as soon as possible if the fuel level is very low or the low fuel warning light illuminates.
- The display will not change unless you add more than approximately 9 L (2.3 US gal, 1.9 Imp gal) of fuel.
- The distance-to-empty is the approximate remaining distance the vehicle can be driven until all the graduation marks in the fuel gauge indicating the remaining fuel supply disappear.
- If there is no past fuel economy information such as after first purchasing your vehicle or the information is deleted when the battery cables are disconnected, the actual distance-to empty/range may differ from the amount indicated.

▼ Average Fuel Economy

The average fuel economy is calculated every 30 seconds from the total traveled distance on the trip meter and the total fuel consumption, and the average fuel economy for either drive information display is displayed. The average fuel economy is also displayed by a red arrow in the instantaneous fuel economy display.

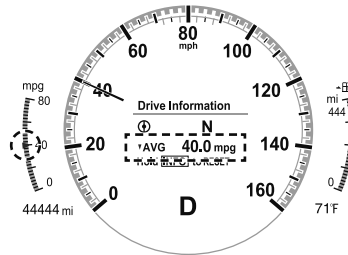

The average fuel economy and trip meters can be reset by pressing the INFO switch for 1.5 seconds or more while in each mode. After the data is cleared, the fuel consumption is recalculated and the - - - L/100 km (- - - mpg) for the 30 seconds prior to it being displayed is indicated.

▼ Current Fuel Economy

This displays the current fuel economy by calculating the amount of fuel consumption and the distance traveled.

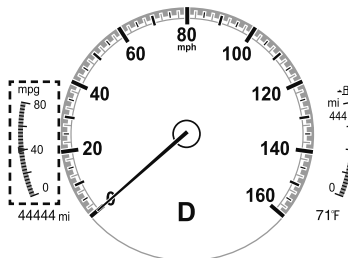

Instrument Cluster and Display

NOTE

- Indicates the 0 position when the vehicle speed is about 5 km/h (3 mph) or slower.
- The red arrow on the scale indicates the average fuel economy.

▼ i-ACTIVSENSE Display*

Displays the system status.

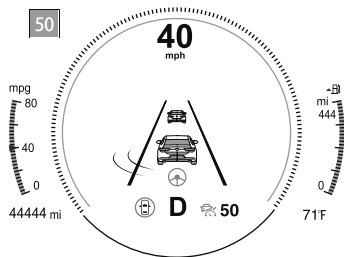

- Refer to Lane Departure Warning System (LDWS) on page 4-95.
- Refer to Blind Spot Monitoring (BSM) on page 4-99.
- Refer to Traffic Sign Recognition System (TSR) on page 4-104.
- Refer to Distance & Speed Alert (DSA) on page 4-109.
- Refer to Driver Attention Alert (DAA) on page 4-111.
- Refer to Driver Monitoring (DM) on page 4-112.
- Refer to Front Cross Traffic Alert (FCTA) on page 4-113.
- Refer to Mazda Radar Cruise Control (MRCC) on page 4-122.
- Refer to Mazda Radar Cruise Control with Stop & Go function (MRCC with Stop & Go function) on page 4-131.
- Refer to Traffic Jam Assist (TJA) on page 4-143.
- Refer to Lane-keep Assist System (LAS) on page 4-157.
- Refer to Smart Brake Support (SBS) on page 4-159.

- Refer to Smart Brake Support [Rear] (SBS-R) on page 4-163.
- Refer to Smart Brake Support [Rear Crossing] (SBS-RC) on page 4-167.
- Refer to Cruise Control on page 4-216.

▼ Compass Display

The direction the vehicle is moving is displayed in one of eight directions while the vehicle is being driven.

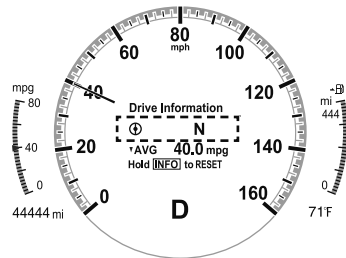

Display	Direction
N	North
S	South
E	East
W	West
NE	Northeast
NW	Northwest
SE	Southeast
SW	Southwest

*Some models.

Instrument Cluster and Display

▼ Message Display

A message such as the system operation status, a malfunction, or an abnormality is indicated.

Warning/indicator light in instrument cluster turns on/flashes or symbol is indicated on display at same time as message

Check the information regarding the warning/indicator light or indicated symbol.

Refer to If a Warning Indication/Warning Lights on page 4-23.

Refer to If a Indication/Indicator Lights on page 4-25.

Message only is indicated on display

Follow the instructions indicated on the display. For the display content, refer to the next page.

Refer to If a Message Indicated on Multi-information Display on page 7-39.

▼ Warning/Indicator Lights

Instrument Cluster varies depending on model and specifications.

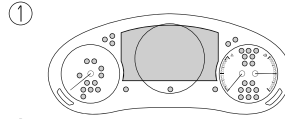











1. Instrument Cluster
2. Front Center of Headliner















Warning lights will appear in any of the highlighted areas



▼ **Warning Indication/Warning Lights**

These lights turn on or flash to notify the user of the system operation status or a system malfunction.

Signal	Warning	Refer to
	Brake System Warning Indication/Warning Light* ¹	7-27
	ABS Warning Indication/Warning Light* ¹	Electronic Brake Force Distribution System Warning 7-28
		ABS warning 7-30
	Charging System Warning Indication/Warning Light* ¹	7-28
	Engine Oil Warning Indication/Warning Light* ¹	7-28
	High Engine Coolant Temperature Warning Indication	7-29
	Power Steering Malfunction Indication/Indicator Light* ¹	7-29
	Master Warning Indication	7-30
	Brake Control System Warning Indication/Warning Light* ¹	7-30
	Brake Override Warning Indication	7-31
	Check Engine Indication/Light* ¹	7-31
AT	*Automatic Transmission Warning Indication/Warning Light* ¹	7-31
AWD	*AWD Warning Indication/Warning Light* ¹	7-31

Instrument Cluster and Display







Signal	Warning	Refer to
	Air Bag/Front Seat Belt Pretensioner System Warning Indication/ Warning Light* ¹	7-32
	Tire Pressure Monitoring System (TPMS) Warning Indication/Warning Light* ¹	Flashing 7-33
		Turns on 7-37
 (Red)	KEY Warning Indication/Warning Light* ¹	7-33
 (Amber)	*High Beam Control System (HBC) Warning Indication/Warning Light* ¹	7-34
	i-ACTIVSENSE Warning Indication/Warning Light* ¹	7-34
	Exterior Light Warning Indication/Warning Light* ¹	7-34
	Low Fuel Warning Indication/Warning Light	7-35
	Check Fuel Cap Warning Indication/Warning Light* ¹	7-35
	Engine Oil Level Warning Indication/Warning Light* ¹	7-35
 PASSENGER	Seat Belt Warning Indication/Warning Light (Front seat)	7-36
REAR  (Red)	Seat Belt Warning Light (Rear seat)	7-36
	*Low Washer Fluid Level Warning Indication/Warning Light	7-36
	Door-Ajar Warning Indication	7-37
	*Trunk lid-Ajar Warning Indication	7-37

Signal	Warning	Refer to
	*Liftgate-Ajar Warning Indication	7-37
	Door-Ajar Warning Light	7-37





*1 The light turns on when the ignition is switched on for an operation check, and turns off a few seconds later or when the engine is started. If the light does not turn on or remains turned on, have the vehicle inspected at an Authorized Mazda Dealer.









▼ Indication/Indicator Lights

These lights turn on or flash to notify the user of the system operation status or a system malfunction.

Signal	Indicator	Refer to
REAR  (Green)	Seat Belt Indicator Light (Rear seat)	2-27
PASS AIRBAG OFF 	*Front Passenger Air Bag Deactivation Indicator Light	2-71
	Security Indicator Light	Immobilizer System 3-41
		Theft-Deterrent System 3-42
		Malfunction 7-34
 (Green)	KEY Indicator Light	4-5
	Wrench Indication/Indicator Light* ¹	4-29
P	*Shift Position Indication	4-38
	Lights-On Indicator Light	4-46

Instrument Cluster and Display

Signal	Indicator	Refer to
	Headlight High-Beam Indicator Light	Headlight High-Low Beam 4-49
		Flashing the Headlights 4-49
	Turn Signal/Hazard Warning Indicator Lights	Turn and Lane-Change Signals 4-52
		Hazard Warning Flasher 4-60
	Electric Parking Brake (EPB) Indication/Indicator Light* ¹ * ²	7-30
HOLD	AUTOHOLD Active Indicator Light* ¹	4-73
	*Mazda Radar Cruise Control with Stop & Go function (MRCC with Stop & Go function) indicator Light	4-138
	*Traffic Jam Assist (TJA) indicator Light	4-153
	TCS/DSC Indication/Indicator Light* ¹	Traction Control System (TCS) 4-78
		Dynamic Stability Control (DSC) 4-79
		Turns on 7-32
	DSC OFF Indicator Light* ¹	4-80
SPORT	*Select Mode Indicator Light	4-82

Signal	Indicator	Refer to
 (White)	i-ACTIVSENSE Status Symbol (Warning/Risk Avoidance Support System)	4-87
 (Green)		
 (Amber)		
 OFF	i-ACTIVSENSE OFF Symbol (Warning/Risk Avoidance Support System)	4-87
 (Green)	*High Beam Control System (HBC) Indicator Light	4-91
 (White)	*Mazda Radar Cruise Control (MRCC) Standby Indication	4-124
	*Mazda Radar Cruise Control with Stop & Go function (MRCC with Stop & Go function) Standby Indication	4-133
	*Traffic Jam Assist (TJA) Standby Indication	4-146
 (Green)	*Mazda Radar Cruise Control (MRCC) Set Indication	4-124
	*Mazda Radar Cruise Control with Stop & Go function (MRCC with Stop & Go function) Set Indication	4-133
	*Traffic Jam Assist (TJA) Set Indication	4-146
 OFF	*Smart Brake Support (SBS) OFF Indicator Light* ¹	Smart Brake Support (SBS) 4-160
		Smart Brake Support [Rear] (SBS-R) 4-163
		Smart Brake Support [Rear Crossing] (SBS-RC) 4-168
 (White)	*Cruise Standby Indication	4-215

Instrument Cluster and Display

Signal	Indicator	Refer to
 (Green)	*Cruise Set Indication	4-215

- *1 The light turns on when the ignition is switched on for an operation check, and turns off a few seconds later or when the engine is started. If the light does not turn on or remains turned on, have the vehicle inspected at an Authorized Mazda Dealer.
- *2 The light turns on continuously when the parking brake is applied.

▼ Wrench Indication/Indicator Light



The wrench indication/indicator light is displayed/turns on under the following conditions.

- When the preset maintenance period has arrived.
Refer to the Information section in the Mazda Connect Owner's Manual.

CAUTION

- When the maintenance period arrives, have your vehicle inspected by an Authorized Mazda Dealer as soon as possible. If maintenance is neglected, a decrease in vehicle performance may occur which could cause damage. Have your vehicle inspected before the maintenance period arrives.
- If the vehicle continues to be driven after the engine oil replacement period has passed, it could cause damage to the engine. Replace the engine oil before the maintenance period arrives.

NOTE

- The wrench indication/indicator light may display/turn on earlier than the preset period depending on vehicle usage conditions.
- Whenever the engine oil is replaced, a reset of the vehicle engine control unit is necessary.
Refer to the Information section in the Mazda Connect Owner's Manual.

Active Driving Display*

▼ Active Driving Display

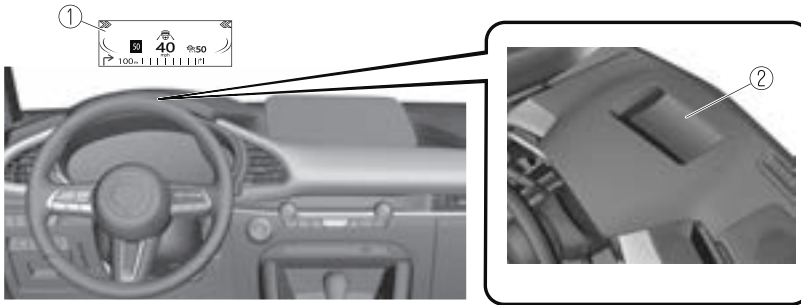

1. Display
2. Dust-proof sheet

WARNING

Always adjust the display brightness and position with the vehicle stopped: Adjusting the display brightness and position while driving the vehicle is dangerous as doing so could distract your attention from the road ahead and lead to an accident.

CAUTION

- Do not place beverages near the dust-proof sheet of the active driving display. If water or other liquids are splashed on the dust-proof sheet, it could cause damage.
- Do not place objects or apply stickers above the active driving display or to the dust-proof sheet as they will cause interference.

NOTE

- Wearing polarized sunglasses will reduce the visibility of the active driving display due to the characteristics of the display.
- If the battery has been removed and re-installed or the battery voltage is low, the adjusted position may deviate.
- The display may be difficult to view or temporarily affected by weather conditions such as rain, snow, light, and temperature.
- If the audio system is removed, the active driving display cannot be operated.

The active driving display indicates the following information:

- Lane Departure Warning System (LDWS) Warnings*
Lane Departure Warning System (LDWS) on page 4-95.
- Blind Spot Monitoring (BSM) Operation Conditions and Warnings*
Refer to Blind Spot Monitoring (BSM) on page 4-96.
- Traffic Sign Recognition System (TSR) traffic signs and Warnings*
Refer to Traffic Sign Recognition System (TSR) on page 4-101.
- Front Cross Traffic Alert (FCTA) Operation Conditions and Warning*
Refer to Front Cross Traffic Alert (FCTA) on page 4-113.
- Mazda Radar Cruise Control (MRCC) Operation Conditions and Warnings*
Refer to Mazda Radar Cruise Control (MRCC) on page 4-120.
- Mazda Radar Cruise Control with Stop & Go function (MRCC with Stop & Go function) Operation Conditions and Warnings*
Refer to Mazda Radar Cruise Control with Stop & Go function (MRCC with Stop & Go function) on page 4-128.
- Traffic Jam Assist (TJA) Operation Conditions and Warnings*
Refer to Traffic Jam Assist (TJA) on page 4-139.
- Lane-keep Assist System (LAS) Warnings*
Lane-keep Assist System (LAS) on page 4-154.
- Smart Brake Support (SBS) Operation Conditions and Warnings*
Refer to Smart Brake Support (SBS) on page 4-158.
- Smart Brake Support [Rear] (SBS-R) Operation Conditions and Warnings*
Refer to Smart Brake Support [Rear] (SBS-R) on page 4-160.
- Smart Brake Support [Rear Crossing] (SBS-RC) Operation Conditions and Warnings*
Refer to Smart Brake Support [Rear Crossing] (SBS-RC) on page 4-164.
- Cruise Control Operation Conditions
Refer to Cruise Control on page 4-215.
- Navigation Guidance (vehicles with navigation system)
- Intersection Name (vehicles with navigation system)
- Street name (vehicles with navigation system)
- Lane Guidance (vehicles with navigation system)
- Speed limit indicator (vehicles with navigation system)
- Vehicle Speed

The active driving display settings can be changed or adjusted.
Refer to the Settings section in the Mazda Connect Owner's Manual.

Instrument Cluster and Display

NOTE

- The desired driving position (display position, brightness level, display information) can be called up after programming the position.
Refer to Driving Position Memory on page 2-11.
- The street name may not be displayed depending on the market and region.

Manual Transmission Operation

Manual Transmission Shift Pattern

▼ Manual Transmission Shift Pattern

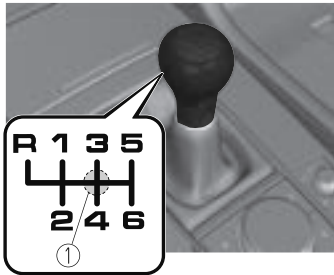

1. Neutral position

The shift pattern of the transmission is conventional, as shown.

Depress the clutch pedal all the way down while shifting; then release it slowly.

Your vehicle is equipped with a device to prevent shifting to R (reverse) by mistake. Push the shift lever downward and shift to R.

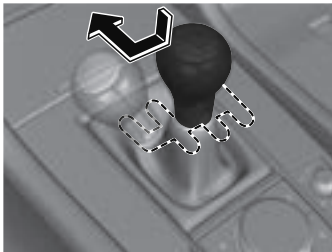

⚠️ WARNING

Do not use sudden engine braking on slippery road surfaces or at high speeds:

Shifting down while driving on wet, snowy, or frozen roads, or while driving at high speeds causes sudden engine braking, which is dangerous. The sudden change in tire speed could cause the tires to skid. This could lead to loss of vehicle control and an accident.

Always leave the shift lever in 1 or R position and set the parking brake when leaving the vehicle unattended: Otherwise the vehicle could move and cause an accident.

⚠️ CAUTION

- Keep your foot off the clutch pedal except when shifting gears. Also, do not use the clutch to hold the vehicle on an upgrade. Riding the clutch will cause needless clutch wear and damage.
- Do not apply any excessive lateral force to the shift lever when changing from 5th to 4th gear. This could lead to the accidental selection of 2nd gear, which could result in damage to the transmission.
- Make sure the vehicle comes to a complete stop before shifting to R. Shifting to R while the vehicle is still moving may damage the transmission.

NOTE

- If shifting to R is difficult, shift back into neutral, release the clutch pedal, and try again.

Manual Transmission Operation

▼ Gear Shift Indicator (GSI)

The GSI supports you to obtain optimum fuel economy and smooth driving. It displays the selected gear position in the instrument cluster as well as notifies the driver to change to the most suitable gear position corresponding to the actual driving condition.

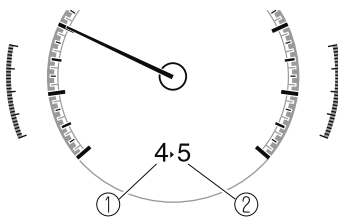

1. Selected gear position
2. Suitable gear position

Indication	Condition
Numeral	The selected gear position is displayed.
▶ and numeral	Shift up or down to the indicated gear position is recommended.

CAUTION

Do not rely solely on the shift-up/shift-down recommendations by indications. The actual driving situation might require shift operations different from indication. To avoid the risk of accidents, the road and traffic conditions have to be judged correctly by the driver before shifting.

NOTE

The GSI turns off when the following operations are performed.

- The vehicle is stopped.
- The vehicle is put in neutral.
- The vehicle is driven in reverse.

- The clutch is not fully engaged when accelerating from a stop.
- The clutch pedal remains depressed for 2 seconds or longer while driving.

▼ Recommendations for Shifting

Upshifting

For normal acceleration, Mazda recommends these shift points: **(U.S.A. and Canada)**

Gear	Vehicle speed
1 to 2	24 km/h (15 mph)
2 to 3	42 km/h (26 mph)
3 to 4	60 km/h (37 mph)
4 to 5	75 km/h (46 mph)
5 to 6	79 km/h (49 mph)

For cruising, Mazda recommends these shift points: **(U.S.A. and Canada)**

Gear	Vehicle speed
1 to 2	13 km/h (8 mph)
2 to 3	29 km/h (18 mph)
3 to 4	49 km/h (30 mph)
4 to 5	63 km/h (39 mph)
5 to 6	70 km/h (43 mph)

Downshifting

When you must slow down in heavy traffic or on a steep **upgrade**, downshift before the engine starts to overwork. This reduces the chance of stalling and gives better acceleration when you need more speed.

On a steep **downgrade**, downshifting helps maintain safe speed and prolongs brake life.

Automatic Transmission Controls

▼ Automatic Transmission Controls

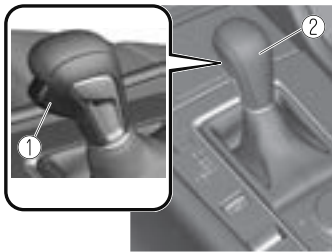

1. Lock-release button
2. Selector lever

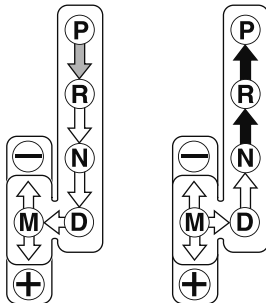

NOTE

The Sport AT has an option that is not included in the traditional automatic transmission that gives the driver the option of selecting each gear instead of leaving it to the transmission to shift gears. Even if you intend to use the automatic transmission functions as a traditional automatic, you should also be aware that you can inadvertently shift into manual shift mode and an inappropriate gear may be retained as the vehicle speed increases. If you notice the engine speed going higher or hear the engine racing, confirm you have not accidentally slipped into manual shift mode (page 4-38).

Indication	Various Lockouts
	Indicates that you must depress the brake pedal and hold in the lock-release button to shift (The ignition must be switched ON).
	Indicates the selector lever can be shifted freely into any position.
	Indicates that you must hold in the lock-release button to shift.

Shift-Lock System

▼ Shift-Lock System

The shift-lock system prevents shifting out of P unless the brake pedal is depressed.

To shift from P:

1. Depress and hold the brake pedal.
2. Start the engine.
3. Press and hold the lock-release button.
4. Move the selector lever.

NOTE

- When the ignition is switched to ACC or the ignition is switched off, the selector lever cannot be shifted from P position.
- The ignition cannot be switched to OFF if the selector lever is not in P position.

▼ Shift-Lock Override

If the selector lever will not move from P position using the proper shift procedure, continue to hold down the brake pedal.

1. Remove the shift-lock override cover using a cloth-wrapped flat head screwdriver.
2. Insert a flat screwdriver and push it down.

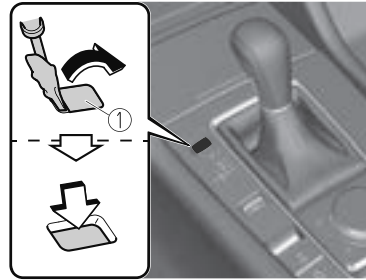

1. Cover

3. Press and hold the lock-release button.
 4. Move the selector lever.
- Take the vehicle to an Authorized Mazda Dealer to have the system checked.

Transmission Ranges

▼ Transmission Ranges

- The shift position indication in the instrument cluster illuminates. Refer to Shift Position Indication on page 4-38.
- Shift the selector lever to the P or N position to start the engine.

P (Park)

P locks the transmission and prevents the front wheels from rotating.



WARNING

Always set the selector lever to P position and set the parking brake: Only setting the selector lever to the P position without using the parking brake to hold the vehicle is dangerous. If P fails to hold, the vehicle could move and cause an accident.



CAUTION

- Shifting into P, N or R while the vehicle is moving can damage your transmission.
- Shifting into a driving gear or reverse when the engine is running faster than idle can damage the transmission.

R (Reverse)

In position R, the vehicle moves only backward. You must be at a complete stop before shifting to or from R, except under rare circumstances as explained in Rocking the Vehicle (page 3-46).

N (Neutral)

In N, the wheels and transmission are not locked. The vehicle will roll freely even on the slightest incline unless the parking brake or brakes are on.



WARNING

If the engine is running faster than idle, do not shift from N or P into a driving gear:

It's dangerous to shift from N or P into a driving gear when the engine is running faster than idle. If this is done, the vehicle could move suddenly, causing an accident or serious injury.

Do not shift into N when driving the vehicle:

Shifting into N while driving is dangerous. Engine braking cannot be applied when decelerating which could lead to an accident or serious injury.



CAUTION

Do not shift into N when driving the vehicle. Doing so can cause transmission damage.

NOTE

Apply the parking brake or depress the brake pedal before moving the selector lever from N position to prevent the vehicle from moving unexpectedly.

D (Drive)

D is the normal driving position. From a stop, the transmission will automatically shift through a 6-gear sequence.

Automatic Transmission

M (Manual)

M is the manual shift mode position. Gears can be shifted up or down by operating the selector lever. Refer to Manual Shift Mode on page 4-38.

▼ Shift Position Indication

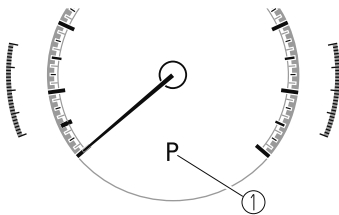

1. Shift position indication

The selector position is indicated when the ignition is switched ON.

Gear position indication

In manual shift mode, the “M” of the shift position indication illuminates and the numeral for the selected gear is displayed.

▼ Active Adaptive Shift (AAS)

Active Adaptive Shift (AAS) automatically controls the transmission shift points to best suit the road conditions and driver input. This improves driving feel. The transmission may switch to AAS mode when driving up and down slopes, cornering, driving at high elevations, or depressing the accelerator pedal quickly while the selector lever is in the D position. Depending on the road and driving conditions/vehicle operations, gear shifting could be delayed or not occur, however, this does not indicate a problem because the AAS mode will maintain the optimum gear position.

Manual Shift Mode

▼ Manual Shift Mode

The manual shift mode gives you the feel of driving a manual transmission vehicle by allowing you to operate the selector lever manually. This allows you to control engine rpm and torque to the drive wheels much like a manual transmission when more control is desired.

To change to manual shift mode, shift the lever from D to M.



NOTE

- Changing to manual shift mode while driving will not damage the transmission.
- If you change to manual shift mode when the vehicle is stopped, the gear will shift to M1.
- If you change to manual shift mode without depressing the accelerator pedal when driving in D range, 5th gear/6th gear, the gear will shift to M4/M5.

To return to automatic shift mode, shift the lever from M to D.

▼ Indications

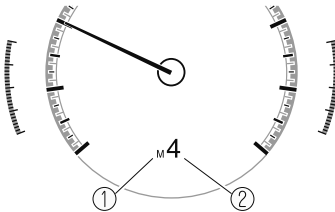

1. Manual shift mode indication
2. Gear position indication

Manual shift mode indication

In manual shift mode, the “M” of the shift position indication in the instrument panel illuminates.

Gear position indication

The numeral for the selected gear illuminates.

NOTE

- If the gears cannot be shifted down when driving at higher speeds, the gear position indication will flash twice to signal that the gears cannot be shifted down (to protect the transmission).
- If the automatic transmission fluid (ATF) temperature becomes too high, there is the possibility that the transmission will switch to automatic shift mode, canceling manual shift mode and turning off the gear position indication illumination. This is a normal function to protect the AT. After the ATF temperature has decreased, the gear position indication illumination turns back on and driving in manual shift mode is restored.

▼ Manually Shifting Up

You can shift gears up by operating the selector lever or the steering shift switches*.

M1 → M2 → M3 → M4 → M5 → M6

Using selector lever

To shift up to a higher gear, tap the selector lever back + once.



Using steering shift switch*

To shift up to a higher gear with the steering shift switches, pull the UP switch (+/OFF) toward you once with your fingers.

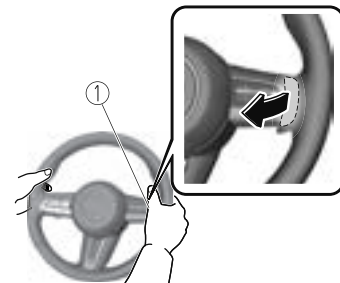

1. UP switch (+/OFF)

Automatic Transmission

WARNING

Keep your hands on the steering wheel rim when using fingers on the steering shift switches:

Putting your hands inside the rim of the steering wheel when using the steering shift switches is dangerous. If the driver's air bag were to deploy in a collision, your hands could be impacted causing injury.

NOTE

- When driving slowly, the gears may not shift up.
- Do not drive the vehicle with the tachometer needle in the RED ZONE while in manual shift mode. In addition, manual shift mode switches to automatic shift mode while the accelerator pedal is completely depressed. This function is canceled while the DSC is turned off. However, if the vehicle is continuously driven at a high rpm, the gears may automatically shift up to protect the engine.
- The steering shift switch can be used temporarily even if the selector lever is in the D position while driving. In addition, it returns to automatic shift mode when the UP switch (+/OFF) is pulled rearward for a sufficient amount of time.

▼ Manually Shifting Down

You can shift gears down by operating the selector lever or the steering shift switches*.

M6 → M5 → M4 → M3 → M2 → M1

Using selector lever

To shift down to a lower gear, tap the selector lever forward – once.



Using steering shift switch*

To shift down to a lower gear with the steering shift switches, pull the DOWN switch (-) toward you once with your fingers.

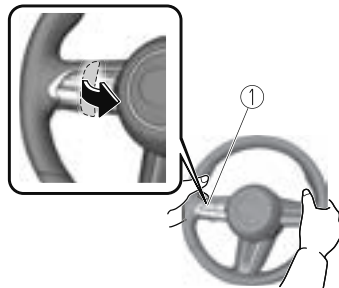

1. DOWN switch (-)

 WARNING**Do not use engine braking on slippery road surfaces or at high speeds:**

Shifting down while driving on wet, snowy, or frozen roads, or while driving at high speeds causes sudden engine braking, which is dangerous. The sudden change in tire speed could cause the tires to skid. This could lead to loss of vehicle control and an accident.

Keep your hands on the steering wheel rim when using fingers on the steering shift switches:

Putting your hands inside the rim of the steering wheel when using the steering shift switches is dangerous. If the driver's air bag were to deploy in a collision, your hands could be impacted causing injury.

NOTE

- When driving at high speeds, the gear may not shift down.
- During deceleration, the gear may automatically shift down depending on vehicle speed.
- When depressing the accelerator fully, the transmission will shift to a lower gear, depending on vehicle speed. However, the gears do not kickdown while the DSC is turned off.

▼ Second Gear Fixed Mode

When the selector lever is moved back + while the vehicle speed is about 10 km/h (6.2 mph) or less, the transmission is set in the second gear fixed mode. The gear is fixed in second while in this mode for easier acceleration from a stop and driving on slippery roads such as snow-covered roads.

If the selector lever is moved back + or forward – while in the second gear fixed mode, the mode will be canceled.

Automatic Transmission

▼ Shift Gear (Shifting) Speed Limit

For each gear position while in the manual mode, the speed limit is set as follows: When the selector lever is operated within the range of the speed limit, the gear is shifted.

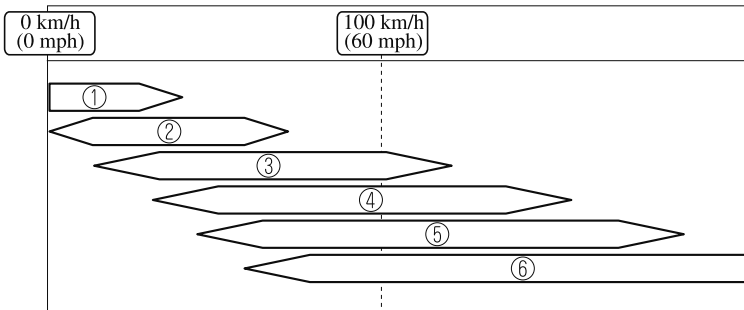

1. 1st
2. 2nd
3. 3rd
4. 4th
5. 5th
6. 6th

Shift up

The gear does not shift up while the vehicle speed is lower than the speed limit.

Shift down

The gear does not shift down while the vehicle speed exceeds the speed limit. If the vehicle speed exceeds the speed limit and the gear does not shift down, the gear position indication flashes 2 times to notify the driver that the gear cannot be shifted.

Kickdown

When the accelerator pedal is depressed fully while driving, the gear shifts down. However, the gears do not kickdown while the DSC is turned off.

NOTE

The gear also shifts down using kickdown while in the second gear fixed mode.

Auto-shift down

The gear shifts down automatically depending on the vehicle speed during deceleration.

NOTE

If the vehicle comes to a stop while in the second gear fixed mode, the gear remains in second.

▼ Recommendations for Shifting

Upshifting

For normal acceleration and cruising, Mazda recommends these shift points:
(U.S.A. and Canada)

Gear	Vehicle speed ^{*1}
M1 to M2	24 km/h (15 mph)
M2 to M3	40 km/h (25 mph)
M3 to M4	65 km/h (40 mph)
M4 to M5	73 km/h (45 mph)
M5 to M6	81 km/h (50 mph)

^{*1} Always observe local speed limit regulations.

Downshifting

When you must slow down in heavy traffic or on a steep upgrade, downshift before the engine starts to overwork. This gives better acceleration when you need more speed.

On a steep downgrade, downshifting helps maintain safe speed and prolongs brake life.

Direct Mode*

▼ Direct Mode

Direct mode can be used for temporarily switching gears by operating the steering shift switch while the vehicle is being driven with the selector lever in the D position. While in direct mode, the D and M indication illuminate and the gear position in use is illuminated.

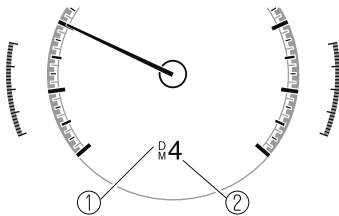

1. Direct mode indication
2. Gear position indication

Direct mode is canceled (released) under the following conditions.

- The UP switch (+/OFF) is pulled rearward for a certain amount of time or longer.
- The vehicle is driven for a certain amount of time or longer (time differs depending on the driving conditions while operating).
- The vehicle is stopped or moving at a slow speed.

NOTE

Shifting up and down while in direct mode may not be possible depending on the vehicle speed. In addition, because direct mode is canceled (released) depending on the rate of acceleration or if the accelerator is fully depressed, use of the manual shift mode is recommended if you need to drive the vehicle in a particular gear for long periods.

Driving Tips

▼ Driving Tips



Do not let the vehicle move in a direction opposite to the direction selected by the selector lever:

Do not let the vehicle move backward with the selector lever in a forward position, or do not let the vehicle move forward with the selector lever in the reverse position. Otherwise, the engine may stop, causing the loss of the power brake and power steering functions, and make it difficult to control the vehicle which could result in an accident.

Passing

For extra power when passing another vehicle or climbing steep grades, depress the accelerator fully. The transmission will shift to a lower gear, depending on vehicle speed.

NOTE

- The accelerator pedal may initially feel heavy as it is being depressed, then feel lighter as it is depressed further. This change in pedal force aids the engine control system in determining how much the accelerator pedal has been depressed for performing kickdown, and functions to control whether or not kickdown should be performed.
- While the selector lever is in the M position and the DSC is turned off, manual shift mode does not switch to automatic shift mode even if the accelerator pedal is completely depressed. Operate the selector lever.

Climbing steep grades from a stop

To climb a steep grade from a stopped position:

1. Depress the brake pedal.
2. Shift to D or M1, depending on the load weight and grade steepness.
3. Release the brake pedal while gradually accelerating.

Descending steep grades

When descending a steep grade, shift to lower gears, depending on load weight and grade steepness. Descend slowly, using the brakes only occasionally to prevent them from overheating.

Switches and Controls

Lighting Control

▼ Headlights

Turn the headlight switch to turn the headlights and other exterior lights on or off. When the taillights, parking lights, license plate lights, and the side-marker lights are turned on, the lights-on indicator light in the instrument cluster turns on.



NOTE

- If the light switch is left on, the lights will automatically switch off approximately 30 seconds after switching the ignition off. The time setting can be changed. Refer to the Settings section in the Mazda Connect Owner's Manual.
- To prevent discharging the battery, do not leave the lights on while the engine is off unless safety requires them.

Without auto-light control



Switch Position	OFF		
Headlights	Off	Off	On ^{*1}
Daytime running lights	On ^{*2}	On ^{*2}	Off
Taillights Parking lights License plate lights Side-marker lights	Off	On ^{*3}	On ^{*1}



^{*1} When the ignition is switched from ON to ACC or OFF, the headlights turn off if the auto headlight off function has been canceled. If the auto headlight off function is enabled, the lights turn on for the set period using the auto headlight off function, and then they turn off.

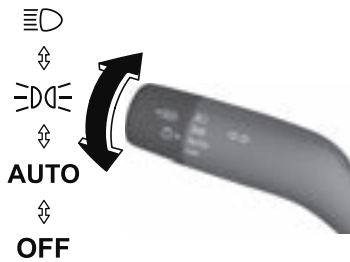

Switches and Controls

- *2 When the light switch is switched to a different position from the OFF,  position while the vehicle is stopped, the daytime running lights turn off. When starting to drive the vehicle, the daytime running lights turn on again.
- *3 When the ignition is switched from ON to ACC or OFF, the headlights remain on if the auto headlight off function has been canceled. If the auto headlight off function is enabled, the lights turn on for the set period using the auto headlight off function, and then they turn off.



With auto-light control



Switch Position	OFF ^{*1}	AUTO				
		Surroundings are bright ^{*2}	Surroundings are dark ^{*3}	Surroundings are bright ^{*2}	Surroundings are dark ^{*3}	
Headlights	Off	Off	On	Off	On ^{*4,5}	On ^{*6}
Daytime running lights	Off	On ^{*7}	Off	On ^{*8}	Off	Off
Taillights Parking lights License plate lights Side-marker lights	Off	Off	On	On ^{*9}	On ^{*9}	On ^{*6}

- *1 When the light switch is switched to OFF while the vehicle is stopped, the lights turn off. The light switch returns automatically to the AUTO position and the headlights change to AUTO operation when you start driving the vehicle.
- *2 The level of brightness around the vehicle is of a sufficient level.
- *3 The level of brightness around the vehicle is of an insufficient level.
- *4 The daytime running lights can be disabled using the personalization features (page 4-51). If the daytime running lights are disabled, the headlights turn off directly after starting the engine. The headlights turn on when you begin driving the vehicle.
- *5 When the light switch is switched from the OFF, AUTO, or  position to the  position while the vehicle is stopped, the headlights turn off. When starting to drive the vehicle, the headlights turn on again.
- *6 When the ignition is switched from ON to ACC or OFF, the headlights turn off if the auto headlight off function has been canceled. If the auto headlight off function is enabled, the lights turn on for the set period using the auto headlight off function, and then they turn off.

Switches and Controls

- *7 When the light switch is switched to a different position from the AUTO position while the vehicle is stopped, the daytime running lights turn off. When starting to drive the vehicle, the daytime running lights turn on again.
- *8 If one of the following operations is done from the  position while the vehicle is stopped, the daytime running lights turn off.
 - Switch the light switch to the OFF position.
 - Switch the light switch to the AUTO position, and then to the  position again.
 - Switch the light switch to the  position.

When starting to drive the vehicle, the daytime running lights turn on again.
- *9 When the ignition is switched from ON to ACC or OFF, the headlights remain on if the auto headlight off function has been canceled. If the auto headlight off function is enabled, the lights turn on for the set period using the auto headlight off function, and then they turn off.

Auto-light control

When the headlight switch is in the AUTO position and the ignition is switched ON, the light sensor senses the surrounding lightness or darkness and automatically turns the headlights and other exterior lights on or off.



- Do not shade the light sensor by adhering a sticker or a label on the windshield. Otherwise the light sensor will not operate correctly.



- The light sensor also works as a rain sensor for the auto-wiper control. Keep hands and scrapers clear of the windshield when the wiper lever is in the AUTO position and the ignition is switched ON as fingers could be pinched or the wipers and wiper blades could be damaged when the wipers activate automatically. If you are going to clean the windshield, be sure the wipers are turned off completely when it is particularly tempting to leave the engine running. This is particularly important when clearing ice and snow.

NOTE

- The headlights and other exterior lights may not turn off immediately even if the surrounding area becomes well-lit because the light sensor determines that it is night time if the surrounding area is continuously dark for several minutes such as inside long tunnels, traffic jams inside tunnels, or in indoor parking lots.
- If the headlight switch and the windshield wiper switch are in AUTO, and the wipers are operated at low or high speed by the auto wiper control for several seconds, bad weather conditions are determined and the headlights may be turned on.
- The sensitivity of the auto-light control may be changed.
Refer to the Settings section in the Mazda Connect Owner's Manual.

▼ Headlight High-Low Beam

The headlights switch between high and low beams by moving the lever forward or backward.

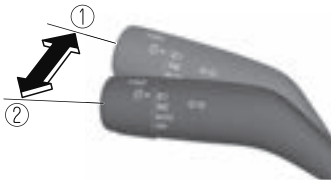

1. High beam
2. Low beam

When the headlight high-beams are on, the headlight high-beam indicator light is turned on.



▼ Flashing the Headlights

The headlights can be flashed with the ignition switched to ON. When the power switch is switched ON, and regardless of the headlight position, the headlights switch to high beams while the lever is being pulled.



1. OFF
2. Headlight flashing

The headlight high-beam indicator light in the instrument cluster illuminates simultaneously. The lever will return to the normal position when released.



Switches and Controls

▼ Coming Home Light

The coming home light turns on the headlights (low beams) when the lever is operated.

To turn on the lights

When the lever is pulled with the ignition switched to ACC or OFF, the low beam headlights turn on. The headlights turn off after a certain period of time has elapsed after all of the doors are closed.



NOTE

- The time until the headlights turn off after all of the doors are closed can be changed. Refer to the Settings section in the Mazda Connect Owner's Manual.
- If no operations are done for 3 minutes after the lever is pulled, the headlights turn off.
- The headlights turn off if the lever is pulled again while the headlights are illuminated.



▼ Leaving Home Light

The leaving home light turns on the lights when the transmitter unlock button is pressed while away from the vehicle.

The following lights turn on when the leaving home light is operated. Low beams, Parking lights, Taillights, License plate lights.

To turn on the lights

When the ignition switch and the headlight switch are in the following conditions, the headlights will illuminate when the transmitter unlock button is pressed and the vehicle receives the transmitter signal. The headlights turn off after a certain period of time has elapsed (30 seconds).

- Ignition switch: off
- Headlight switch: AUTO, , or 

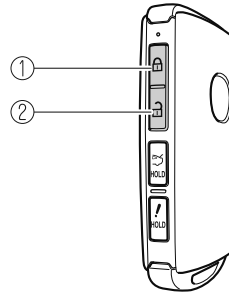

1. Lock button
2. Unlock button

NOTE

- Operation of the leaving home light can be turned on or off. Refer to the Settings section in the Mazda Connect Owner's Manual.
- When the transmitter lock button is pressed and the vehicle receives the transmitter signal, the headlights turn off.
- When the headlight switch is turned to the OFF position, the headlights turn off.

▼ **Headlight Leveling**

The number of passengers and weight of cargo in the luggage compartment change the angle of the headlights.

Auto type

The angle of the headlights will be automatically adjusted when turning on the headlights.

A system malfunction or operation conditions are indicated by a warning. Refer to Exterior Light Warning Indication/Warning Light on page 7-34.

Manual type

When adjusting the illumination angle of the headlights, refer to the Settings section in the Mazda Connect Owner's Manual. Select the proper headlight angle from the following chart.

Front seat		Rear seat	Load	Illumination angle (number)
Driver	Passenger			
x	—	—	—	0
x	x	—	—	0
x	x	x	—	1
x	x	x	x	2
x	—	—	x	3.5

x: Yes
—: No

▼ **Daytime Running Lights**

Some countries require moving vehicles to have their lights on (daytime running lights) during the daytime.

The daytime running lights turn on automatically.

NOTE (Except Canada)

The daytime running lights can be deactivated. Refer to the Settings section in the Mazda Connect Owner's Manual.

Turn and Lane-Change Signals

▼ Turn and Lane-Change Signals

The ignition must be switched ON to use the turn and lane-change signals.

▼ Turn Signals

Move the signal lever down (for a left turn) or up (for a right turn) to the stop position. The signal will self-cancel after the turn is completed.

If the indicator light continues to flash after a turn, manually return the lever to its original position.

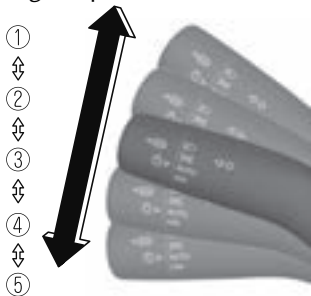

1. Right turn
2. Right lane change
3. OFF
4. Left lane change
5. Left turn

The turn signal indicators in the instrument cluster flash according to the operation of the turn signal lever to show which signal is working.



NOTE

- There may be a problem with the turn signal lights if they do not flash but remain turned on, or they flash abnormally. Have your vehicle inspected by an Authorized Mazda Dealer.
- A personalized function is available to change the turn indicator sound volume. Refer to the Settings section in the Mazda Connect Owner's Manual.

▼ Lane-Change Signals

Move the lever halfway toward the direction of the lane change—until the indicator flashes— and hold it there. It will return to the off position when released.

▼ Three-Flash Turn Signal

After releasing the turn signal lever from the halfway point, the turn signal indicator flashes 3 times. The operation can be canceled by moving the lever in the direction opposite to which it was operated.

NOTE

The three-flash turn signal function can be switched to on/off using the personalization function. Refer to the Settings section in the Mazda Connect Owner's Manual.

Windshield Wipers and Washer

▼ Windshield Wipers and Washer

The ignition must be switched ON to use the wipers.

⚠ WARNING

Use only windshield washer fluid or plain water in the reservoir:

Using radiator antifreeze as washer fluid is dangerous. If sprayed on the windshield, it will dirty the windshield, affect your visibility, and could result in an accident.

Only use windshield washer fluid mixed with anti-freeze protection in freezing weather conditions:

Using windshield washer fluid without anti-freeze protection in freezing weather conditions is dangerous as it could freeze on the windshield and block your vision which could cause an accident. In addition, make sure the windshield is sufficiently warmed using the defroster before spraying the washer fluid.

⚠ CAUTION

- When the wipers are not used during freezing temperatures or for a long time, the wiper rubber may adhere to the glass. If the wipers are operated while adhered to the glass, it could damage the wiper rubber and motor.
- If the wipers are operated while the glass is dry, the glass could be scratched and the wiper rubber damaged. When the glass is dry, spray washer fluid before operating the wipers.

- If the amount of washer fluid spray is insufficient, do not use the washer switch. If the washer switch continues to be operated with no washer fluid being sprayed, it could lead to pump damage.

NOTE

If the windshield wipers are operated under cold weather conditions or during snowfall, they could stop due to accumulated snow on the windshield. If the windshield wipers stop due to accumulated snow on the windshield, park the vehicle in a safe place, turn the wiper switch off, and then remove the accumulated snow. If the wiper switch is turned to another position other than OFF, the wipers will operate. If the wipers do not operate even though the wiper switch is turned to a position other than OFF, consult an Authorized Mazda Dealer as soon as possible.

▼ Windshield Wipers

Turn the wipers on by pressing the lever up or down.

With intermittent wiper

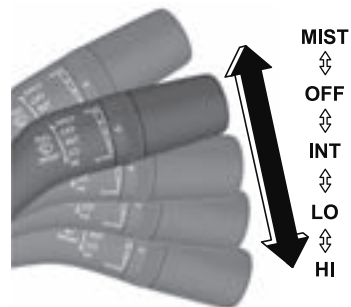

Switches and Controls

Switch Position	Wiper operation
MIST	Operation while pulling up lever
OFF	Stop
INT	Intermittent
LO	Low speed
HI	High speed

Variable-speed intermittent wipers

Set the lever to the intermittent position and choose the interval timing by rotating the switch. Rotate the switch upward (FAST direction) to shorten the interval time of the wiper operation, and rotate the switch downward (SLOW direction) to lengthen it.

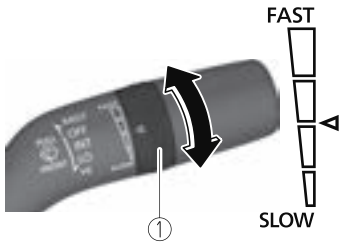

1. Switch

With auto-wiper control

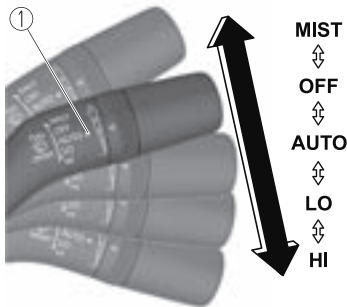

1. Indicator light

Switch Position	Wiper operation
MIST	Operation while pulling up lever
OFF	Stop
AUTO*1	Auto control
LO	Low speed
HI	High speed

*1 When the wiper lever is switched to the AUTO position, the indicator light turns on.

Auto-wiper control*

When the wiper lever is in the AUTO position, the rain sensor senses the amount of rainfall on the windshield and turns the wipers on or off automatically (off—intermittent—low speed—high speed).

The sensitivity of the rain sensor can be adjusted by turning the switch on the wiper lever.

From the center position (normal), rotate the switch upward (+ direction) for higher sensitivity (faster response) or rotate it downward (- direction) for less sensitivity (slower response).

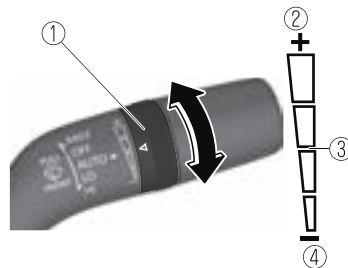

1. Switch
2. Higher sensitivity
3. Center position
4. Less sensitivity

CAUTION

- Do not shade the rain sensor by adhering a sticker or a label on the windshield. Otherwise the rain sensor will not operate correctly.



- When the ignition is switched ON and the wiper lever is in the AUTO position, the windshield wipers may operate automatically in the following cases:
 - The area of the windshield above the rain sensor is touched or wiped with a cloth.
 - The windshield or the rain sensor area in the cabin is hit.

When the ignition is switched ON and the wiper lever is in the AUTO position, do not touch the windshield or the windshield wipers. Otherwise, the windshield wipers will operate automatically which could catch your fingers or damage the windshield wipers.

When removing ice or snow, or cleaning the windshield, always make sure the wiper lever is in the OFF position.

NOTE

- Switching the auto-wiper lever from the OFF to the AUTO position while driving activates the windshield wipers once, after which they operate according to the rainfall amount.
- The auto-wiper control may not operate when the rain sensor temperature is about $-10\text{ }^{\circ}\text{C}$ ($14\text{ }^{\circ}\text{F}$) or lower, or about $85\text{ }^{\circ}\text{C}$ ($185\text{ }^{\circ}\text{F}$) or higher.
- If the windshield is coated with water repellent, the rain sensor may not be able to sense the amount of rainfall correctly and the auto-wiper control may not operate properly.
- If dirt or foreign matter (such as ice or matter containing salt water) adheres to the windshield above the rain sensor, or if the windshield is iced, it could cause the wipers to move automatically. However, if the wipers cannot remove this ice, dirt or foreign matter, the auto-wiper control will stop operation. In this case, set the wiper lever to the low speed position or high speed position for manual operation, or remove the ice, dirt or foreign matter by hand to restore the auto-wiper operation.
- If the auto-wiper lever is left in the AUTO position, the wipers could operate automatically from the effect of strong light sources, electromagnetic waves, or infrared light because the rain sensor uses an optical sensor. It is recommended that the auto-wiper lever be switched to the OFF position other than when driving the vehicle under rainy conditions.

Switches and Controls

- If the headlight switch and the windshield wiper switch are in AUTO, and the wipers are operated at low or high speed by the auto wiper control for several seconds, bad weather conditions are determined and the headlights may be turned on.
- The auto-wiper control functions can be turned off.
Refer to the Settings section in the Mazda Connect Owner's Manual.

▼ Windshield Washer

Pull the wiper lever toward you to spray washer fluid and operate the windshield wipers several times. The washer fluid is sprayed only while the windshield wipers move out of their stowed positions to the point where they start reversing back.



1. OFF
2. Washer

NOTE

- If the windshield washer is turned on when the windshield wipers are not operating, the windshield wipers operate a few times.
- If you pull the wiper lever while the windshield wipers are reversing back to their stowed positions, the next time the washer fluid is sprayed is during the next cycle.

If the washer does not work, inspect the fluid level (page 6-22). If the fluid level is normal, consult an Authorized Mazda Dealer.

Rear Window Wiper and Washer*

▼ Rear Window Wiper and Washer

The ignition must be switched ON to use the wiper.

▼ Rear Window Wiper



Turn the wiper on by turning the rear wiper/washer switch.

Switch Position	Wiper operation
	Spray washer fluid and operate the rear wiper
ON	Normal
INT	Intermittent
OFF	Stop
	Spray washer fluid and operate the rear wiper

▼ Rear Window Washer

To spray washer fluid, turn the rear wiper/washer switch to either of the position. After the switch is released, the washer will stop.

NOTE

While the windshield washers are operating (from the time the wiper lever is pulled until the washer fluid stops spraying), the rear window washer does not spray washer fluid even if you operate the switch.

If the washer does not work, inspect the fluid level (page 6-22). If the fluid level is normal and the washer still does not work, consult an Authorized Mazda Dealer.

Switches and Controls

Rear Window Defogger

▼ Rear Window Defogger

The rear window defogger clears fog from the rear window.

The ignition must be switched ON to use the defogger.

Press the switch to turn on the rear window defogger. The rear window defogger operates for about 15 minutes and then turns off automatically.

The indicator light illuminates when the defogger is operating.

To turn off the rear window defogger before the 15 minutes has elapsed, press the switch again.

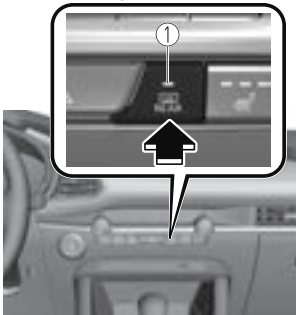

1. Indicator light

⚠ CAUTION

➤ Do not use sharp instruments or window cleaners with abrasives to clean the inside of the rear window surface. They may damage the defogger grid inside the window.

NOTE

- This defogger is not designed for melting snow. If there is an accumulation of snow on the rear window, remove it before using the defogger.
- The rear window defogger operation time can be changed from 15 minutes to continuous operation. When the operation time has been switched to continuous operation, by pressing the switch, the rear window defogger will continue to operate until the ignition is switched OFF.
Refer to the Settings section in the Mazda Connect Owner's Manual.

▼ Windshield Wiper De-icer*

The thermal filaments at the following positions heat up and facilitate the removal of snow accumulated on the windshield.

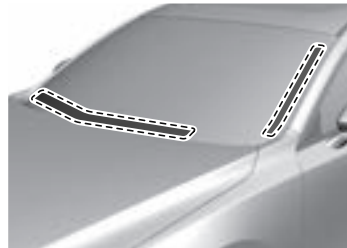

The windshield wiper de-icer operates in conjunction with the rear window defogger.

To turn on the windshield wiper de-icer, switch the ignition ON and press the rear window defogger switch (page 4-58).

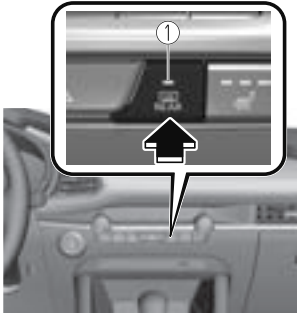

1. Indicator light

▼ **Mirror Defogger***

The mirror defoggers defrost the outside mirrors.

The mirror defoggers operate in conjunction with the rear window defogger.

To turn on the mirror defoggers, switch the ignition ON and press the rear window defogger switch (page 4-58).

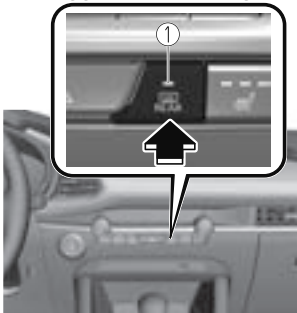

1. Indicator light

Horn

▼ Horn

To sound the horn, press the  mark on the steering wheel.

Switches and Controls

Hazard Warning Flasher

▼ Hazard Warning Flasher

The hazard warning lights should always be used when you stop on or near a roadway in an emergency.



The hazard warning lights warn other drivers that your vehicle is a traffic hazard and that they must take extreme caution when near it.



Depress the hazard warning flasher and all the turn signals will flash. The hazard warning indicator lights in the instrument cluster flash simultaneously.

NOTE

- The turn signals do not work when the hazard warning lights are on.
- Check local regulations about the use of hazard warning lights while the vehicle is being towed to verify that it is not in violation of the law.

HomeLink Wireless Control System*

▼ HomeLink Wireless Control System

NOTE

HomeLink and HomeLink house are registered trademarks of Gentex Corporation.

The HomeLink system replaces up to 3 hand-held transmitters with a single built-in component in the auto-dimming mirror. Pressing the HomeLink button on the auto-dimming mirror activates garage doors, gates and other devices surrounding your home.

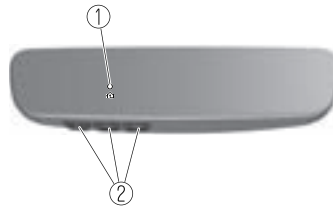

1. Indicator light
2. HomeLink button

WARNING

Do not use the HomeLink system with any garage door opener that lacks the safety stop and reverse feature:

Using the HomeLink system with any garage door opener that lacks the safety stop and reverse feature as required by federal safety standards is dangerous. (This includes garage doors manufactured before April 1, 1982.)

Using these garage door openers can increase the risk of serious injury or death. For further information, contact **HomeLink** at www.homelink.com or www.youtube.com/HomelinkGentex or an Authorized Mazda Dealer.

Always check the areas surrounding garage doors and gates for people or obstructions before programming or during operation of the HomeLink system:

Programming or operating the HomeLink system without verifying the safety of areas surrounding garage doors and gates is dangerous and could result in an unexpected accident and serious injury if someone were to be hit.

NOTE

The programming will not be erased even if the battery is disconnected.

▼ Pre-programming the HomeLink System

NOTE

It is recommended that a new battery be placed in the hand-held transmitter of the device being programmed to HomeLink for quicker training and accurate transmission of the radio-frequency signal.

- Verify that there is a remote control transmitter available for the device you would like to program.

▼ Programming the HomeLink System

The HomeLink system provides 3 buttons which can be individually selected and programmed using the transmitters for current, on-market devices as follows:

1. Press and release the HomeLink button you would like to program. The indicator light flashes slowly in amber when the button is pressed.

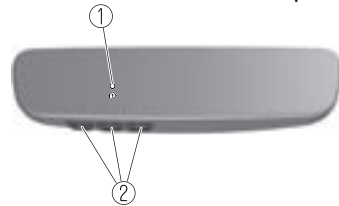

1. Indicator light
2. HomeLink button

2. Hold the hand-held transmitter 2.5 to 7.5 cm (1 to 3 in) away from the HomeLink button you would like to program while keeping the indicator light in view.

NOTE

Depending on the hand-held transmitter, it may be easier to do the programming by holding it 15 to 20 cm (6 to 7.8 in) away from the HomeLink button.

3. Press the hand-held transmitter button continuously until the indicator light changes from amber (flashing) to green (on/flashing).

Switches and Controls

NOTE

Some gate operators and garage door openers may require you to replace this Programming Step 3 with procedures noted in the "Gate Operator/Canadian Programming" section.

4. Press the Homelink button again to check if the programming has been completed.
 - If the indicator light remains on in green, the programming is complete and the device becomes operational.
 - If the indicator light flashes rapidly in green, firmly press and hold the Homelink button and release it after two seconds have passed. Repeat this process up to three times to complete the programming. The device becomes operational and programming is complete. If the device does not operate, go to the next step.
5. At the garage door opener receiver (motor-head unit) in the garage, locate the "learn" or "smart" button. This can usually be found where the hanging antenna wire is attached to the motor-head unit.
6. Firmly press and release the "learn" or "smart" button. (The name and color of the button may vary by manufacturer.)

NOTE

Complete the programming within 30 seconds.

7. Return to the vehicle and firmly **press** and **hold** the Homelink button, and then **release** it after two seconds have passed. Repeat the "**press/hold/release**" sequence a second time, and, depending on the brand of the garage door opener (or other rolling code equipped device), repeat this sequence a third time to complete the programming process. Press the programmed HomeLink button and make sure that the HomeLink System operates.
8. If the status indicator arrows are flashing, refer to Garage Door Two-Way Communication.

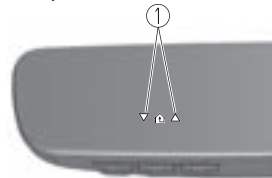

1. Indicator light

NOTE

To program the remaining two HomeLink buttons, go back to **Step 1** of Programming the HomeLink System and repeat the procedure.

For questions or comments, please contact **HomeLink** at www.homelink.com or www.youtube.com/HomeLinkGentex, or the HomeLink toll-free hotline at 1-800-355-3515 (for calls placed outside of the USA, Canada, and Puerto Rico, international rates will apply and may differ based on landline or mobile phone).

▼ Gate operator/Canadian Programming

Canadian radio-frequency laws require transmitter signals to “time-out” (or quit) after several seconds of transmission — which may not be long enough for HomeLink to pick up the signal during programming. Similar to this Canadian law, some U.S. gate operators are designed to “time-out” in the same manner.

If you live in Canada or are having difficulties programming a gate operator by using the programming procedures (regardless of where you live), **replace Step 3 of Programming the HomeLink System** with the following:

NOTE

If programming a garage door opener or gate operator, it is advised to unplug the device during the “cycling” process to prevent possible overheating.

While the indicator light is flashing in amber, press the button on the hand-held transmitter for 2 seconds and release it repeatedly until the indicator light changes from amber to green.

Go back to Step 4 of Programming the HomeLink System to complete the procedure.

▼ Operating the HomeLink System

Press the programmed HomeLink button to operate a programmed device.

▼ Reprogramming the HomeLink system

To program a device to HomeLink using a HomeLink button previously trained, follow these steps:

1. Press and hold the desired HomeLink button. **DO NOT** release the button.
2. After 20 seconds, the indicator light flashes in amber. After the indicator light flashes, release the HomeLink button.
3. Go back to Step 2 of Programming the HomeLink System to complete the procedure.

NOTE

If the programming has not been completed, the system returns to the previous programming.

▼ Erasing Programmed HomeLink Buttons

NOTE

- All of the programmed HomeLink buttons are reset. Individual buttons cannot be reset, however, individual buttons can be reprogrammed. For individual button reprogramming, refer to Reprogramming the HomeLink System (page 4-63).
- Verify that the programming has been erased if you resell the vehicle.

Switches and Controls

1. Press the two outer HomeLink buttons continuously at the same time until the indicator light flashes.

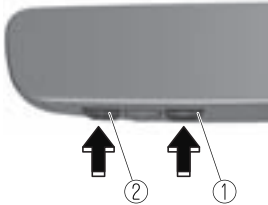

1. HomeLink button 3
2. HomeLink button 1

2. Stop pressing the HomeLink buttons.

▼ Garage Door Two-Way Communication

The garage door two-way communication is a function that communicates with the garage door opener and indicates whether the garage door is open or closed using the indicator lights in the rear view mirror. It can indicate the status of the garage door within a range up-to 250 m (820 ft).

NOTE

The communication range may shorten depending on obstructions.

Programming two-way communication

Within five seconds after programming a new HomeLink button, both of the garage door status indicator lights will flash rapidly in green indicating that the garage door two-way communication has been established. If the garage door status indicator lights flash, the two-way communication programming is complete.

If the garage door status indicator lights do not flash, the two-way communication programming is not completed. For additional HomeLink information and programming videos, refer to the following Websites:

- www.HomeLink.com
- www.youtube.com/HomeLinkGentex

Operating the garage door two-way communication

By pressing HomeLink buttons 1 and 2 at the same time for two seconds, the status of the garage door is indicated for about 3 seconds as follows:

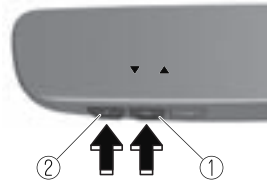

1. HomeLink button 2
2. HomeLink button 1

Garage door status	Indicator light
Closing	Amber flashes
	▼
Opening	Amber flashes
	▲
Closed	Green turns on
	▼
Opened	Green turns on
	▲

NOTE

The programming will not be erased even if the battery is disconnected.

Brake System

▼ Foot Brake

This vehicle has power-assisted brakes that adjust automatically through normal use.

Should power-assist fail, you can stop by applying greater force than normal to the brake pedal. But the distance required to stop will be greater than usual.

WARNING

Do not coast with the engine stalled or turned off, find a safe place to stop:

Coasting with the engine stalled or turned off is dangerous. Braking will require more effort, and the brake's power-assist could be depleted if you pump the brake. This will cause longer stopping distances or even an accident.

Shift to a lower gear when going down steep hills:

Driving with your foot continuously on the brake pedal or steadily applying the brakes for long distances is dangerous. This causes overheated brakes, resulting in longer stopping distances or even total brake failure. This could cause loss of vehicle control and a serious accident. Avoid continuous application of the brakes.

Dry off brakes that have become wet by driving slowly, releasing the accelerator pedal and lightly applying the brakes several times until the brake performance returns to normal:

Driving with wet brakes is dangerous. Increased stopping distance or the vehicle pulling to one side when braking could result in a serious accident. Light braking will indicate whether the brakes have been affected.

CAUTION

- Do not drive with your foot held on the clutch pedal or brake pedal, or hold the clutch pedal depressed halfway unnecessarily. Doing so could result in the following:
 - The clutch and brake parts will wear out more quickly.
 - The brakes can overheat and adversely affect brake performance.
- Always depress the brake pedal with the right foot. Applying the brakes with the unaccustomed left foot could slow your reaction time to an emergency situation resulting in insufficient braking operation.

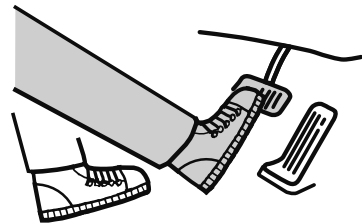

- Wear shoes appropriate for driving in order to avoid your shoe contacting the brake pedal when depressing the accelerator pedal.

▼ **Electric Parking Brake (EPB)**

The EPB system applies the parking brake using an electric motor. The system can operate automatically and manually.

The EPB switch indicator light turns on when applying the parking brake and it turns off when releasing the parking brake.



1. Indicator light

 **WARNING**

Do not drive the vehicle with the parking brake applied:

If the vehicle is driven with the parking brake applied, the brake parts may generate heat and the brake system may not operate, leading to an accident.

Before driving the vehicle, release the parking brake and make sure that the EPB indicator light in the instrument cluster turns off.

Apply the parking brake when leaving the vehicle:

Not applying the parking brake when parking the vehicle is dangerous as the vehicle may move unexpectedly and result in an accident. Before leaving the vehicle, apply the parking brake and make sure that the EPB indicator light in the instrument cluster turns on.

NOTE

- The parking brake cannot be applied or released while the vehicle battery is dead.
Refer to If a Jump-Starting on page 7-17.
- When the charging system warning light in the instrument cluster turns on, the parking brake cannot be applied after switching the ignition OFF. Before switching the ignition OFF, apply the parking brake manually.
- The sound of the parking brake being applied or released can be heard, however, this does not indicate a problem.
- If the EPB is not used for long periods, an automatic inspection of the system is performed while the vehicle is parked. An operation sound can be heard, however, this does not indicate a problem.
- When applying the parking brake and switching OFF the ignition, an operation sound can be heard, however, this does not indicate a problem.
- The brake pedal may move while applying or releasing the parking brake, however, this does not indicate a problem.

- If there is a problem with the brake system (foot brake) while driving the vehicle, continually pulling up the EPB switch will apply the brakes and decelerate or stop the vehicle. The parking brake on-reminder sound is activated while the brake is applied. In addition, when releasing the switch, the brake is released and the sound stops.
- If the parking brake is applied with the ignition switched OFF or in ACC, the EPB indicator light in the instrument cluster and the indicator light in the switch may turn on for 15 seconds.
- When using an automatic car wash which moves the vehicle with the front tires mounted, it is necessary to cancel the parking brake auto operation before the vehicle enters the automatic car wash. For details, refer to Canceling the parking brake automatic operation.

Manual operation

Applying the parking brake manually

When the brake pedal is firmly depressed and the EPB switch is pulled up, the parking brake is applied regardless of the ignition position. When the parking brake is applied, the EPB indicator light in the instrument cluster and the EPB switch indicator light turn on.



Releasing the parking brake manually

When the brake pedal is firmly depressed and the EPB switch is pressed while the ignition is switched ON or the engine is running, the parking brake is released. When the parking brake is released, the EPB indicator light in the instrument cluster and the EPB switch indicator light turn off.



If the EPB switch is pressed without depressing the brake pedal, a message is displayed on the multi-information display to notify the driver to depress the brake pedal.

Refer to Message Indicated on Multi-information Display on page 7-39.

Auto operation

Applying the parking brake automatically

When the ignition is switched from ON to ACC or OFF, the parking brake will be applied automatically. When the parking brake is applied, the EPB indicator light in the instrument cluster and the EPB switch indicator light turn on.

NOTE

To release the parking brake when the ignition is switched OFF, it is necessary to cancel the parking brake auto operation. For details, refer to Canceling the parking brake automatic operation.

Releasing the parking brake automatically

If the accelerator pedal is depressed with the parking brake applied and all of the following conditions met, the parking brake is released automatically. When the parking brake is released, the EPB indicator light in the instrument cluster and the EPB switch indicator light turn off.

- The engine is running.
- The driver's door is closed.
- The driver's seat belt is fastened.
- **(Manual transmission vehicle)**
 - The shift lever is in a position other than neutral.
 - The clutch pedal is depressed halfway.
- **(Automatic transmission vehicle)**
The selector lever is in the D, M, or R position.

NOTE

If something such as the driver's foot contacts the accelerator pedal with the engine running and the parking brake applied, the parking brake might be released automatically. If you do not intend to start driving the vehicle immediately, shift the shift lever to the neutral position for a manual transmission, or shift the selector lever to the P or N position for an automatic transmission.

Canceling the parking brake automatic operation

The parking brake automatic operation can be canceled by doing any of the following after switching the ignition from ON to OFF.

Auto operation cancel method 1

1. Switch the ignition ON.
2. Release the parking brake manually.
3. Turn off the AUTOHOLD.
4. Press the EPB switch continuously for 2 seconds or longer (until a sound is activated).
5. Release the EPB switch and switch the ignition OFF within 5 seconds after the sound was activated.
After the auto operation is canceled, a sound is activated one time, and the EPB switch indicator light switches from illumination to flashing, and then turns off after 3 seconds.

Auto operation cancel method 2

1. Switch the ignition ON.
2. Release the parking brake manually.
3. Turn off the AUTOHOLD.
4. Switch the ignition OFF with the EPB switch pressed while the brake pedal is not depressed.
When the auto operation is canceled, a sound is activated one time, and the EPB switch indicator light goes from normal flashing to faster flashing, and then turns off after 3 seconds.

NOTE

- When canceling the parking brake auto operation and parking the vehicle, shift the shift lever to the 1st gear or the R position for a manual transmission, or shift the selector lever to the P position for an automatic transmission, and then use wheel blocks.
- The auto operation may not cancel if the vehicle is parked on a steep slope.

When the ignition is switched ON, the parking brake auto operation is restored.

▼ **Warning Light**

The warning light turns on when the system has a malfunction. Refer to Brake System Warning Indication/Warning Light on page 7-27.

▼ **Brake Pad Wear Indicator**

When the disc brake pads become worn, the built-in wear indicators contact the disc plates. This causes a screeching noise to warn that the pads should be replaced.



When you hear this noise, consult an Authorized Mazda Dealer as soon as possible.

⚠ WARNING

Do not drive with worn disc pads:

Driving with worn disc pads is dangerous. The brakes could fail and cause a serious accident. As soon as you hear a screeching noise consult an Authorized Mazda Dealer.

NOTE

In high humidity weather conditions, brake noises, such as brake squeak or brake squeal can be heard. It does not indicate a malfunction.

▼ **Brake Assist**

During emergency braking situations when it is necessary to depress the brake pedal with greater force, the brake assist system provides braking assistance, thus enhancing braking performance.

When the brake pedal is depressed hard or depressed more quickly, the brakes apply more firmly.

NOTE

- When the brake pedal is depressed hard or depressed more quickly, the pedal will feel softer but the brakes will apply more firmly. This is a normal effect of the brake assist operation and does not indicate a malfunction.
- When the brake pedal is depressed hard or depressed more quickly, a motor/pump operation noise may be heard. This is a normal effect of the brake assist and does not indicate a malfunction.
- The brake assist equipment does not supersede the functionality of the vehicle's main braking system.

Brake

▼ Brake Override System

The brake override system applies the brake first for safety if the brake pedal and accelerator pedal are depressed at the same time.

NOTE

Operation of the brake override system can be turned on or off.

Refer to the Settings section in the Mazda Connect Owner's Manual.

AUTOHOLD

▼ AUTOHOLD

The AUTOHOLD function automatically holds the vehicle stopped, even if you take your foot off the brake pedal. This function can be best used while stopped in traffic or at a traffic light. The brakes are released when you start driving the vehicle.

WARNING

Do not rely completely on the AUTOHOLD function:

The AUTOHOLD function is only designed to assist the brake operation while the vehicle is stopped. Neglecting to operate the brakes and relying only on the AUTOHOLD system is dangerous and could result in an unexpected accident if the vehicle were to suddenly move. Operate the brakes appropriately in accordance with the road and surrounding conditions.

Do not release your foot from the brake pedal while the vehicle is stopped on a steep grade:

Because there is a possibility of the vehicle not being held in the stopped position by the AUTOHOLD function, the vehicle may move unexpectedly and result in an accident.

Do not use the AUTOHOLD function on slippery roads such as icy or snow-covered roads, or unpaved roads:

Even if the vehicle is held in the stopped position by the AUTOHOLD function, the vehicle may move unexpectedly and result in an accident. Operate the accelerator pedal, brakes, or steering wheel appropriately as necessary.

Immediately depress the brake pedal in the following cases:

Because the AUTOHOLD function is canceled forcibly, the vehicle may move unexpectedly and result in an accident.

- “Depress Brake Pedal. Brake Hold Disabled” is displayed in the multi-information display and the warning sound is activated at the same time.

Always apply the parking brake when parking the vehicle:



Not applying the parking brake when parking the vehicle is dangerous as the vehicle may move unexpectedly and result in an accident. When parking the vehicle, shift the selector lever to the P position (automatic transmission vehicle) and apply the parking brake.

⚠ CAUTION

If you stop operating the accelerator pedal before the vehicle starts moving, the force holding the vehicle in the stopped position may weaken. Firmly depress the brake pedal or depress the accelerator pedal to accelerate the vehicle.

NOTE

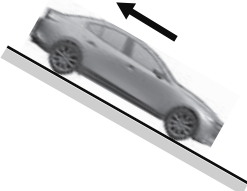
- Under the following conditions, a problem with the AUTOHOLD is occurring. Have your vehicle inspected at an Authorized Mazda Dealer as soon as possible.
 - A message is indicated on the multi-information display and a warning sound is activated for about 5 seconds while the AUTOHOLD is operating or when you press the AUTOHOLD switch.
- If you switch the ignition OFF while the AUTOHOLD is operating, the parking brake is applied automatically to assist you with parking the vehicle.
- The AUTOHOLD is canceled when the selector lever/shift lever is shifted to R position while the vehicle is on level ground, or facing up a hill or grade (as shown below).

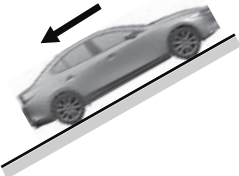
Vehicle posture and road surface gradient		AUTOHOLD operation status
Vehicle tilts forward		Operates
Level ground		Does not operate, canceled
Vehicle tilts rearward		Does not operate, canceled

 : Reverse driving (selector lever/shift lever in the reverse (R) position)

▼ To Turn On AUTOHOLD System

Press the AUTOHOLD switch and when the AUTOHOLD standby indicator light turns on, the AUTOHOLD function turns on.



1. AUTOHOLD standby indicator light

NOTE

When all of the following conditions are met, the AUTOHOLD standby indicator light turns on when the AUTOHOLD switch is pressed and the AUTOHOLD function turns on.

- The ignition is switched ON (engine is running).
- The driver's seat belt is fastened.
- The driver's door is closed.
- There is no problem with the AUTOHOLD function.

To operate AUTOHOLD and hold the brakes

1. Depress the brake pedal and bring the vehicle to a complete stop.
2. The AUTOHOLD active indicator light in the instrument cluster turns on and the brakes are held.

HOLD

3. The vehicle is held in its stopped position even with the brake pedal released.

NOTE

When all of the following conditions are met, the AUTOHOLD operates and the brakes are held.

- The ignition is switched ON (engine is running).
- The vehicle is stopped.
- The brake pedal is being depressed.
- The AUTOHOLD active indicator light turns on.
- The accelerator pedal is not depressed.
- The driver's seat belt is fastened.
- The driver's door is closed.
- There is no problem with the AUTOHOLD function.
- The parking brake is released.
- There is no problem with the Electric Parking Brake (EPB) function.
- **(Automatic transmission vehicle)**
The selector lever is in a position other than R position or the vehicle tilts forward with the selector lever in the R position.

To release AUTOHOLD and start driving the vehicle

If you try to resume driving the vehicle, the brakes will be released automatically and the AUTOHOLD active indicator light turns off.

NOTE

- If the Electric Parking Brake (EPB) switch is pulled while the AUTOHOLD is operating, the parking brake is applied and the AUTOHOLD is released. In addition, if the parking brake is released under this condition, the AUTOHOLD operates to hold the brakes.
- Under the following conditions, the parking brake is automatically applied and the AUTOHOLD is released. The AUTOHOLD is re-enabled when the conditions before the AUTOHOLD is released are restored.
 - The driver's seat belt is unfastened.
 - The driver's door is opened.
- When about 10 minutes or longer have passed since the AUTOHOLD operation started, the parking brake is automatically applied. Because the AUTOHOLD is restored when releasing the parking brake, the hold on the brakes by AUTOHOLD function resumes.
- **(Manual transmission vehicle)** When starting to drive the vehicle forward or in reverse on a down slope, depress the clutch pedal and shift the shift lever to the appropriate position for driving in the desired direction, and then depress the accelerator pedal to release the AUTOHOLD.
- The AUTOHOLD can be canceled forcibly by fully depressing the accelerator pedal for 1 second or longer while the AUTOHOLD is operating. Forcibly cancel the AUTOHOLD only when the AUTOHOLD cannot be canceled due to a system malfunction or it is necessary to cancel the AUTOHOLD in an emergency.

▼ To Turn Off AUTOHOLD System

Depress the brake pedal and press the AUTOHOLD switch. The AUTOHOLD is turned off and the AUTOHOLD standby indicator light turns off.



1. AUTOHOLD standby indicator light

NOTE

- When the brakes are not held such as while driving the vehicle, the AUTOHOLD can be turned off only by pressing the AUTOHOLD switch.
- If the AUTOHOLD switch is pressed without depressing the brake pedal while AUTOHOLD is operating (AUTOHOLD active indicator light in instrument cluster is turned on), the message "Depress Brake Pedal and Operate Switch to Release" is indicated on the multi-information display to notify the driver to depress the brake pedal.

- If any of the following conditions occurs while the AUTOHOLD function is operating (AUTOHOLD active indicator light is turned on), the parking brake is applied automatically and the AUTOHOLD function turns off. For the Electric Parking Brake (EPB) operation, refer to the Electric Parking Brake (EPB) on page 4-66.
- The ignition is switched OFF.
- There is a problem with the AUTOHOLD function.

Hill Launch Assist (HLA)

▼ Hill Launch Assist (HLA)

The HLA functions to assist in accelerating the vehicle from a stop on slopes. When releasing the brake pedal and depressing the accelerator pedal to accelerate the vehicle from a stop while on a slope, the function prevents the vehicle from rolling. The HLA also operates when reversing on a slope. The braking force is maintained automatically after releasing the brake pedal on a steep slope.

For manual transmission vehicles, the HLA operates when the vehicle is tilted rearward with the shift lever in a forward gear, and operates when the vehicle is tilted forward with the shift lever in the R position.

For automatic transmission vehicles, the HLA operates when the vehicle is tilted rearward with the selector lever in a forward gear, and operates when the vehicle is tilted forward with the selector lever in the R position.

WARNING

Do not rely completely on HLA:

HLA is an auxiliary device for accelerating from a stop on a slope. The system only operates for about 2 seconds and therefore, relying only on the system, when accelerating from a stop is dangerous because the vehicle may move (roll) unexpectedly and cause an accident.

The vehicle could roll depending on the vehicle's load or if it is towing something. In addition, for vehicles with a manual transmission, the vehicle could still roll depending on how the clutch pedal or the accelerator pedal is operated.

Always confirm the safety around the vehicle before starting to drive the vehicle.

NOTE

- HLA does not operate on a gentle slope. In addition, the gradient of the slope on which the system will operate changes depending on the vehicle's load.
- HLA does not operate if the parking brake is applied, the vehicle has not stopped completely, or the clutch pedal is released.
- While HLA is operating, the brake pedal may feel stiff and vibrate, however, this does not indicate a malfunction.
- HLA does not operate while the TCS/DSC indicator light is illuminated.
Refer to TCS/DSC Indication/Indicator Light (Turns on) on page 7-32.
- HLA does not turn off even if the DSC OFF switch is pressed to turn off the TCS/DSC.

Antilock Brake System (ABS)

▼ Antilock Brake System (ABS)

The ABS control unit continuously monitors the speed of each wheel. If one wheel is about to lock up, the ABS responds by automatically releasing and reapplying that wheel's brake.

The driver will feel a slight vibration in the brake pedal and may hear a chattering noise from the brake system. This is normal ABS system operation. Continue to depress the brake pedal without pumping the brakes.

The warning light turns on when the system has a malfunction. Refer to ABS Warning Indication/Warning Light on page 7-30.

WARNING

Do not rely on ABS as a substitute for safe driving:

The ABS cannot compensate for unsafe and reckless driving, excessive speed, tailgating (following another vehicle too closely), driving on ice and snow, and hydroplaning (reduced tire friction and road contact because of water on the road surface). You can still have an accident.

NOTE

- Braking distances may be longer on loose surfaces (snow or gravel, for example) which usually have a hard foundation. A vehicle with a normal braking system may require less distance to stop under these conditions because the tires will build up a wedge of surface layer when the wheels skid.
- The sound of the ABS operating may be heard when starting the engine or immediately after starting the vehicle, however, it does not indicate a malfunction.

Traction Control System (TCS)

▼ **Traction Control System (TCS)**

The Traction Control System (TCS) enhances traction and safety by controlling engine torque and braking. When the TCS detects driving wheel slippage, it lowers engine torque and operates the brakes to prevent loss of traction.

This means that on a slick surface, the engine adjusts automatically to provide optimum power to the drive wheels, limiting wheel spin and loss of traction.

The warning light turns on when the system has a malfunction. Refer to TCS/DSC Indication/Indicator Light (Turns on) on page 7-32.

WARNING

Do not rely on the Traction Control System (TCS) as a substitute for safe driving:

The Traction Control System (TCS) cannot compensate for unsafe and reckless driving, excessive speed, tailgating (following another vehicle too closely), and hydroplaning (reduced tire friction and road contact because of water on the road surface). You can still have an accident.

Use snow tires or tire chains and drive at reduced speeds when roads are covered with ice and/or snow:

Driving without proper traction devices on snow and/or ice-covered roads is dangerous. The Traction Control System (TCS) alone cannot provide adequate traction and you could still have an accident.

NOTE

To turn off the TCS, press the DSC OFF switch (page 4-80).

▼ **TCS/DSC Indicator Light**



This indicator light stays on for a few seconds when the ignition is switched ON.

If the TCS or DSC is operating, the indicator light flashes.

If the light stays on, the TCS, DSC or the brake assist system may have a malfunction and they may not operate correctly. Take your vehicle to an Authorized Mazda Dealer.

NOTE

- In addition to the indicator light flashing, a slight lugging sound will come from the engine. This indicates that the TCS/DSC is operating properly.
- On slippery surfaces, such as fresh snow, it will be impossible to achieve high rpm when the TCS is on.

Dynamic Stability Control (DSC)

▼ Dynamic Stability Control (DSC)

The Dynamic Stability Control (DSC) automatically controls braking and engine torque in conjunction with systems such as ABS and TCS to help control side slip when driving on slippery surfaces, or during sudden or evasive maneuvering, enhancing vehicle safety.

Refer to ABS (page 4-77) and TCS (page 4-78).

DSC operation is possible at speeds greater than 20 km/h (12 mph).

The warning light turns on when the system has a malfunction. Refer to TCS/DSC Indication/Indicator Light (Turns on) on page 7-32.

⚠ WARNING

Do not rely on the Dynamic Stability Control as a substitute for safe driving:

The Dynamic Stability Control (DSC) cannot compensate for unsafe and reckless driving, excessive speed, tailgating (following another vehicle too closely), and hydroplaning (reduced tire friction and road contact because of water on the road surface). You can still have an accident.

⚠ CAUTION

- The DSC may not operate correctly unless the following are observed:
 - Use tires of the correct size specified for your Mazda on all 4 wheels.
 - Use tires of the same manufacturer, brand and tread pattern on all 4 wheels.
 - Do not mix worn tires.
- The DSC may not operate correctly when tire chains are used or a temporary spare tire is installed because the tire diameter changes.

NOTE

If there is a problem with the DSC, the Hill Launch Assist (HLA) may not operate. Refer to Hill Launch Assist (HLA) on page 4-75.

▼ TCS/DSC Indicator Light



This indicator light stays on for a few seconds when the ignition is switched ON. If the TCS or DSC is operating, the indicator light flashes.

If the light stays on, the TCS, DSC or the brake assist system may have a malfunction and they may not operate correctly. Take your vehicle to an Authorized Mazda Dealer.

▼ DSC OFF Indicator Light



This indicator light stays on for a few seconds when the ignition is switched ON.

It also illuminates when the DSC OFF switch is pressed and TCS/DSC is switched off.

Refer to DSC OFF Switch on page 4-80.

If the light remains illuminated and the TCS/DSC is not switched off, take your vehicle to an Authorized Mazda Dealer. The DSC may have a malfunction.

▼ DSC OFF Switch

Press the DSC OFF switch to turn off the TCS/DSC. The DSC OFF indicator light in the instrument cluster will illuminate.



Press the switch again to turn the TCS/DSC back on. The DSC OFF indicator light will turn off.

NOTE

- When DSC is on and you attempt to free the vehicle when it is stuck, or drive it out of freshly fallen snow, the TCS (part of the DSC system) will activate. Depressing the accelerator will not increase engine power and freeing the vehicle may be difficult. When this happens, turn off the TCS/DSC.
- If the TCS/DSC is off when the engine is turned off, it automatically activates when the ignition is switched ON.
- Leaving the TCS/DSC on will provide the best traction.
- If the DSC OFF switch is pressed and held for 10 seconds or more, the DSC OFF switch malfunction detection function operates and the DSC system activates automatically. The DSC OFF indicator light turns off while the DSC system is operative.
- **(Vehicles with Smart Brake Support (SBS))**
If the Smart Brake Support (SBS) operates with the TCS/DSC turned off, the TCS/DSC becomes operational automatically.

Drive Selection*

▼ Drive Selection

Drive selection is a system to switch the vehicle's drive mode. When the sport mode is selected, vehicle's response against accelerator operation is enhanced. This provides additional quick acceleration which may be needed to safely make maneuvers such as lane changes, merging onto freeways, or passing other vehicles.

CAUTION

Do not use the sport mode when driving on slippery roads such as wet or snow-covered roads. It may cause tire slipping.

NOTE

- When the sport mode is selected, driving at higher engine speeds increases and it may increase fuel consumption. Mazda recommends that you cancel the sport mode on normal driving.
- Drive mode cannot be switched in the following conditions:
 - ABS/TCS/DSC is operating
 - Cruise control* is operating.
 - The Mazda Radar Cruise Control with Stop & Go function (MRCC with Stop & Go function) System* is operating.
 - Traffic Jam Assist (TJA) is operating.
 - Steering wheel is being operated abruptly

▼ Drive Selection Switch

Press the drive selection switch forward (SPORT) to select the sport mode. Pull the drive selection switch back (OFF) to cancel the sport mode.



NOTE

- In the following cases, the drive selection is canceled.
 - The ignition is switched OFF.
 - Mazda Radar Cruise Control with Stop & Go function (MRCC with Stop & Go function) System/cruise control is set.
 - Traffic Jam Assist (TJA) is set.
- Depending on the driving conditions when sport mode is selected, the vehicle may perform shift-down or slightly accelerate.

Drive Selection

▼ Select Mode Indicator Light

When the sport mode is selected, the select mode indicator light turns on in the instrument cluster.

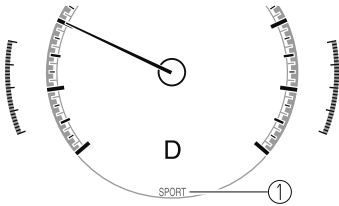

1. Select mode indicator light

NOTE

If the drive selection cannot be switched to sport mode, the select mode indicator light flashes to notify the driver.

i-ACTIV AWD Operation*

▼ i-ACTIV AWD Operation

AWD provides excellent drivability on snow-covered and ice-packed roads, sand and mud, as well as on steep slopes and other slippery surfaces. A system malfunction or operation conditions are indicated by a warning. Refer to AWD Warning Indication/Warning Light on page 7-31.



Never spin a wheel that is off the ground:

Spinning a wheel that is off the ground as a result of the vehicle being stuck or in a ditch is dangerous. The drive assembly could be seriously damaged which could lead to an accident or could even lead to overheating, oil leakage, and a fire.

▼ AWD Driving

This vehicle has not been designed for the purpose of off-road driving or rallies. Do not attempt to drive over uneven or rocky surfaces, or across rivers.

Although this vehicle is equipped with AWD, acceleration, steering and braking operations should be conducted in the same manner as with a non-AWD vehicle, with the emphasis placed on safe driving.

▼ Tires and Tire Chains

The condition of the tires plays a large role in the performance of the vehicle. Moreover, to prevent adverse effects to the drive assembly, please note the following:

Tires

- When replacing tires, always replace all front and rear tires at the same time.
- All tires must be of the same size, manufacture, brand and tread pattern. Pay particular attention when equipping snow or other types of winter tires.
- Do not mix tread-worn tires with normal tires.
- Inspect tire inflation pressures at the specified periods adjust to the specified pressures.

NOTE

Check the tire inflation pressure label attached to driver's door frame for the correct tire inflation pressure.

- Make sure to equip the vehicle with genuine tires of the specified size, on all wheels. With AWD, the system is calibrated for all 4 wheels being of the same dimensions.

Tire chains

- Install tire chains to the front tires.
- Do not use tire chains on the rear wheels.
- Do not drive the vehicle faster than 30 km/h (19 mph) with the tire chains installed.
- Do not drive the vehicle with tire chains on road conditions other than snow or ice.

▼ Towing

If the vehicle requires towing, have it towed with all 4 wheels completely off the ground.

Refer to Towing Description on page 7-23.

Power Steering

▼ Power Steering

- Power steering is only operable when the engine is running. If the engine is off or if the power steering system is inoperable, you can still steer, but it requires more physical effort. If the steering feels stiffer than usual during normal driving or the steering vibrates, consult an Authorized Mazda Dealer.
- The malfunction indication notifies the driver of system abnormalities and operation conditions. Refer to Power Steering Malfunction Indication/Indicator Light on page 7-29.

i-ACTIVSENSE*

▼ i-ACTIVSENSE

i-ACTIVSENSE is a collective term covering a series of advanced safety and driver support systems which make use of cameras and sensors. The systems consist of active safety and pre-crash safety systems.

These systems are designed to assist the driver in safer driving by reducing the load on the driver and helping to avert collisions or reduce their severity. However, because each system has its limitations, always drive carefully and do not rely solely on the systems.

▼ Active Safety Technology

Active Safety Technology supports safer driving by helping the driver to recognize potential hazards and avert accidents.

Driver awareness support systems

Nighttime visibility

Adaptive Front Lighting System (AFS)..... page 4-90
High Beam Control System (HBC).....page 4-90

Left/right side and rear side detection

Lane Departure Warning System (LDWS)..... page 4-92
Blind Spot Monitoring (BSM).....
.....page 4-96

Road sign recognition

Traffic Sign Recognition System (TSR)..... page 4-101

Inter-vehicle distance recognition

Distance & Speed Alert (DSA)
..... page 4-108

Front obstruction detection when approaching a crosswalk

Front Cross Traffic Alert (FCTA)
..... page 4-113

Rear obstruction detection when leaving a parking space

Rear Cross Traffic Alert (RCTA).....
..... page 4-116

Full-surround recognition

360°View Monitor..... page 4-168

Driver fatigue detection

Driver Attention Alert (DAA)
..... page 4-109
Driver Monitoring (DM).... page 4-111

Driver support systems

Inter-vehicle distance

Mazda Radar Cruise Control (MRCC)..... page 4-120
Mazda Radar Cruise Control with Stop & Go function (MRCC with Stop & Go function)..... page 4-128

Lane departure

Lane-keep Assist System (LAS)
..... page 4-154

Inter-vehicle distance and lane keeping

Traffic Jam Assist (TJA).....page 4-139

▼ **Pre-Crash Safety Technology**

Pre-crash safety technology is designed to assist the driver in averting collisions or reducing their severity in situations where they cannot be avoided.

Collision damage reduction

Forward driving

Smart Brake Support (SBS)
..... page 4-158

Reverse driving

Smart Brake Support [Rear] (SBS-R).....page 4-160
Smart Brake Support [Rear Crossing] (SBS-RC)..... page 4-164

▼ **Camera and Sensors**

Forward Sensing Camera (FSC)

The Forward Sensing Camera (FSC) detects lane indications and recognizes headlights, taillights and city lights during nighttime driving. In addition, it also detects the vehicle ahead, pedestrians, or obstructions. The following systems use the Forward Sensing Camera (FSC).

- High Beam Control system (HBC)
- Lane Departure Warning System (LDWS)
- Traffic Sign Recognition System (TSR)
- Distance & Speed Alert (DSA)
- Driver Attention Alert (DAA)
- Mazda Radar Cruise Control (MRCC)
- Mazda Radar Cruise Control with Stop & Go function (MRCC with Stop & Go function)
- Lane-keep Assist System (LAS)
- Traffic Jam Assist (TJA)
- Smart Brake Support (SBS)

The Forward Sensing Camera (FSC) is installed at the top of the windshield near the rearview mirror.

Refer to Forward Sensing Camera (FSC) on page 4-203.

Front radar sensor

The front radar sensor detects radio waves reflected off a vehicle ahead sent from the radar sensor. The following systems use the front radar sensor.

- Distance & Speed Alert (DSA)
- Mazda Radar Cruise Control (MRCC)
- Mazda Radar Cruise Control with Stop & Go function (MRCC with Stop & Go function)
- Traffic Jam Assist (TJA)
- Smart Brake Support (SBS)

The front radar sensor is mounted behind the radiator grille. Refer to Front Radar Sensor on page 4-207.

Front side radar sensor

The front side radar sensors detects radio waves reflected off a vehicle ahead sent from the radar sensor. The following systems use the front side radar sensor.

- Front Cross Traffic Alert (FCTA)

The front side radar sensors are installed inside the front bumper, one on the left side and one on the right side.

Refer to Front Side Radar Sensor on page 4-209.

Rear side radar sensor

The rear side radar sensors emit radio waves and detect the radio waves reflected off a vehicle approaching from the rear or an obstruction. The following systems use the rear side radar sensor.

- Blind Spot Monitoring (BSM)
- Rear Cross Traffic Alert (RCTA)
- Smart Brake Support [Rear Crossing] (SBS-RC)

The rear side radar sensors are installed inside the rear bumper, one on the left side and one on the right side. Refer to Rear Side Radar Sensor on page 4-211.

Rear/rear corner/rear side ultrasonic sensor

The ultrasonic sensor detects ultrasonic waves reflected off obstructions at the rear sent from the ultrasonic sensors. The following systems use the ultrasonic sensor.

- Smart Brake Support [Rear] (SBS-R)
- Smart Brake Support [Rear Crossing] (SBS-RC)

The ultrasonic sensors are mounted in the rear bumper. Refer to Rear/Rear corner/Rear Side Ultrasonic Sensor on page 4-212.

Front camera/side cameras/rear camera

The front camera, side cameras, and rear camera shoot images of the area surrounding the vehicle. The 360°View Monitor uses each camera. Cameras are installed to the front bumper, door mirrors, and rear bumper. Refer to Front Camera/Side Cameras/Rear Camera on page 4-213.

Driver monitoring camera

The driver monitoring camera detects changes in the driver's facial features and estimates the amount of accumulated fatigue and sleepiness of the driver. The following systems use the driver monitoring camera.

- Driver Monitoring (DM)

The driver monitoring camera is mounted in the center display. Refer to Driver Monitoring Camera on page 4-214.

▼ i-ACTIVSENSE Status Symbol (Warning/Risk Avoidance Support System)

The system notifies the driver of any of the following system status using the color or OFF indication of the i-ACTIVSENSE status symbol (Warning/risk avoidance support system).

- Lane Departure Warning System (LDWS)
- Blind Spot Monitoring (BSM)
- Distance & Speed Alert (DSA)
- Front Cross Traffic Alert (FCTA)
- Rear Cross Traffic Alert (RCTA)
- Lane-keep Assist System (LAS)

NOTE

The status of the system turned on using the personalization feature is displayed.

i-ACTIVSENSE status symbol (warning/risk avoidance support system) (white)



i-ACTIVSENSE

System stand-by status

If none of the systems are activated or if there is a problem with the system, the i-ACTIVSENSE status symbol (warning/risk avoidance support system) (white) is displayed.

NOTE

For example, even when the Blind Spot Monitoring (BSM) is operating normally, if the Lane Departure Warning System (LDWS) has a problem, the i-ACTIVSENSE status symbol (warning/risk avoidance support system) (white) is displayed.

i-ACTIVSENSE status symbol (warning/risk avoidance support system) (green)



System activated status

If any one of the systems is activated, the i-ACTIVSENSE status symbol (warning/risk avoidance support system) (green) is displayed.

NOTE

Even if the i-ACTIVSENSE status symbol (warning/risk avoidance support system) (green) is displayed, systems which do not meet the operation conditions will not operate.

i-ACTIVSENSE status symbol (warning/risk avoidance support system) (amber)



System warning status

If any system warning is activated, the i-ACTIVSENSE status symbol (warning/risk avoidance support system) (amber) is displayed.

i-ACTIVSENSE OFF symbol (warning/risk avoidance support system)



System OFF status

If all the systems are canceled using the personalization features or the i-ACTIVSENSE OFF switch, the i-ACTIVSENSE OFF symbol (Warning/risk avoidance support system) is displayed.

▼ i-ACTIVSENSE OFF Switch*

When the i-ACTIVSENSE OFF switch is pressed, the following systems are canceled and the i-ACTIVSENSE OFF symbol (Warning/risk avoidance support system) in the instrument cluster is displayed.

- Lane Departure Warning System (LDWS)
- Blind Spot Monitoring (BSM)
- Distance & Speed Alert (DSA)
- Front Cross Traffic Alert (FCTA)
- Rear Cross Traffic Alert (RCTA)
- Lane-keep Assist System (LAS)

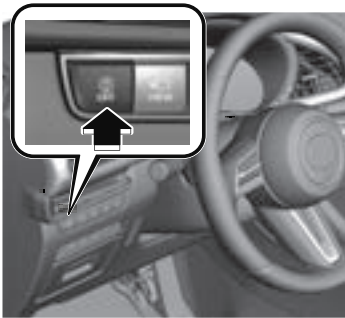

i-ACTIVSENSE OFF symbol (Warning/risk avoidance support system)



If the i-ACTIVSENSE OFF switch is pressed again, the systems return to their original operation status and the i-ACTIVSENSE OFF symbol (Warning/risk avoidance support system) turns off.

If the ignition is switched OFF while you have canceled the systems using the i-ACTIVSENSE OFF switch, the systems are automatically enabled the next time the ignition is switched ON. However, if the systems are canceled using the personalization features, the systems are not automatically enabled.

NOTE

You can select systems you want to cancel using the personalization features.

Refer to the Settings section in the Mazda Connect Owner's Manual.

Adaptive Front Lighting System (AFS)*

▼ Adaptive Front Lighting System (AFS)

The adaptive front lighting system (AFS) automatically adjusts the headlight beams to the left or right in conjunction with the operation of the steering wheel after the headlights have been turned on and the vehicle speed is about 2 km/h (2 mph) or higher.

A system malfunction or operation conditions are indicated by a warning. Refer to Exterior Light Warning Indication/Warning Light on page 7-34.

NOTE

The Adaptive Front Lighting System (AFS) can be switched to on/off using the personalization function. Refer to the Settings section in the Mazda Connect Owner's Manual.

High Beam Control System (HBC)*

▼ High Beam Control System (HBC)

The HBC determines the conditions in front of the vehicle using the Forward Sensing Camera (FSC) while driving in darkness to automatically switch the headlights between high and low beams.

Refer to Forward Sensing Camera (FSC) on page 4-203.

While driving the vehicle at a speed of about 30 km/h (19 mph) or more, the headlights are switched to high beams when there are no vehicles ahead or approaching in the opposite direction. The system switches the headlights to low beams when one of the following occurs:

- The system detects a vehicle or the headlights/lights of a vehicle approaching in the opposite direction.
- The vehicle is driven on roads lined with streetlamps or on roads in well-lit cities and towns.
- The vehicle is driven at less than about 20 km/h (12 mph).
- The headlight high-beam indicator light turns on while the high beams are on.

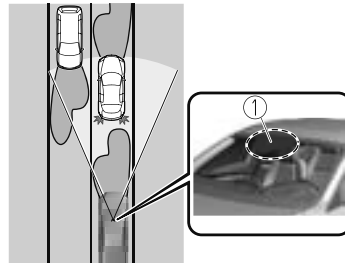

1. Forward Sensing Camera (FSC)*¹

- *1 The recognition distance of the Forward Sensing Camera (FSC) varies according to the surrounding conditions.

The warning light turns on when the system has a malfunction.
Refer to High Beam Control System (HBC) Warning Indication/Warning Light (Amber) on page 7-34.

⚠ CAUTION

- Do not adjust the vehicle height, modify the headlight units, or remove the camera, otherwise the system will not operate normally.
- Do not rely excessively on the HBC and drive the vehicle while paying sufficient attention to safety. Switch the headlights between the high beams and low beams manually if necessary.

NOTE

The timing in which the system switches the headlights changes under the following conditions. If the system does not switch the headlights appropriately, manually switch between high and low beams according to the visibility as well as road and traffic conditions.

- When there are sources of light in the area such as street lamps, illuminated signboards, and traffic signals.
- When there are reflective objects in the surrounding area such as reflective plates and signs.
- When visibility is reduced under rain, snow and foggy conditions.
- When driving on roads with sharp turn or hilly terrain.
- When the headlights/rear lamps of vehicles in front of you or in the opposite lane are dim or not illuminated.

- When there is insufficient darkness such as at dawn or dusk.
- When the trunk/luggage compartment is loaded with heavy objects or the rear passenger seats are occupied.
- When visibility is reduced due to a vehicle in front of you spraying water from its tires onto your windshield.

▼ To Operate the System

The HBC operates to switch the headlights automatically between high and low beams after the ignition is switched ON and the headlight switch is in the AUTO and low beam position. The HBC determines that it is dark based on the brightness of the surrounding area. At the same time, the HBC indicator light (green) in the instrument cluster illuminates.



NOTE

Operation of the HBC function can be disabled.
Refer to the Settings section in the Mazda Connect Owner's Manual.

▼ **Manual Switching**

Switching to low beams

Switch the headlight switch to the  position, or press the high beam control switch.

The HBC indicator light (green) turns off.



1. High beam control switch

If the HBC is turned off using the high beam control switch, press the high beam control switch again to turn the HBC back on.

Switching to high beams

Shift the lever to the high beam position.

The HBC indicator light (green) turns off and the headlight high-beam indicator light is illuminated.

Lane Departure Warning System (LDWS)*

▼ **Lane Departure Warning System (LDWS)**

The LDWS alerts the driver that the vehicle may be deviating from its lane. The system detects the white (yellow) lines on the traffic lane using the forward sensing camera (FSC) and if it determines that the vehicle might be deviating from its lane, it notifies the driver by the LDWS.

Refer to Forward Sensing Camera (FSC) on page 4-203.

Use the LDWS when you drive the vehicle on roads with white (yellow) lines.

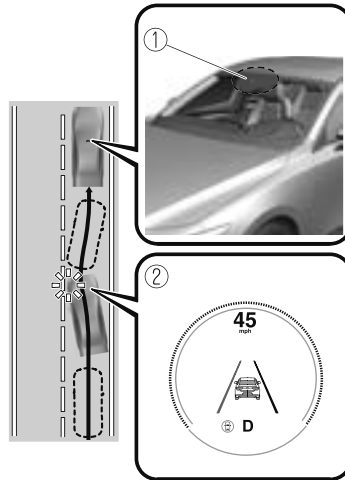

1. Forward sensing camera (FSC)
2. Multi-information display

 **WARNING**

Do not rely completely on the LDWS:

- The LDWS system is not designed to compensate for a driver's lack of caution and relying too much on the system could lead to an accident.
- The functions of the LDWS have limitations. Always stay on course using the steering wheel and drive with care.

 **CAUTION**

Heed the following cautions so that the LDWS can operate normally.

- Do not modify the vehicle's suspensions.
- Always use tires of the specified type and size for the front and rear wheels. Consult an Authorized Mazda Dealer for tire replacement.

NOTE

The system may not operate normally under the following conditions.

- The white (yellow) lane lines are less visible because of dirt or paint flaking.
- White (yellow) lane lines are less visible because of bad weather (rain, fog, or snow).
- The vehicle is driven on a temporary lane or section with a closed lane resulting from construction where there might be multiple white (yellow) lane lines, or they are interrupted.
- The camera picks up an obscure line, such as a temporary line being used for construction, or because of shade, unmelted snow, or grooves filled with water.

- The surrounding brightness suddenly changes such as when entering or exiting a tunnel.
- Back-light is reflected off the road surface.
- The road surface is wet and shiny after rain, or there are puddles on the road.
- The width of a lane is excessively narrow.
- The vehicle is driven on roads with tight curves.
- Heavy luggage is loaded in the trunk/luggage compartment or on the rear seat causing the vehicle to tilt.
- The vehicle is driven through a fork in the road or a junction.
- The shade of a guardrail parallel to a white (yellow) lane line is cast on the road.
- The illumination of the headlights is weakened because of dirt or the optical axis is deviated at night.
- The road is excessively uneven.
- The vehicle is shaken after hitting a road bump.
- A vehicle in front of your vehicle is running near a white (yellow) lane line making it less visible.
- The windshield is dirty or foggy.
- Strong light is directed from the front of the vehicle (such as sunlight, or headlights (high-beam) of on-coming vehicles).
- The vehicle is driven through an intersection or a roundabout.

▼ When the System Operates

When the ignition is switched ON, the i-ACTIVSENSE status symbol (warning/risk avoidance support system) (white) turns on and the system goes on standby.



NOTE

If the i-ACTIVSENSE status symbol (warning/risk avoidance support system) (white) does not turn on, the system is canceled using the i-ACTIVSENSE OFF switch or the personalization feature.

Operation conditions

When all of the following conditions are met, the i-ACTIVSENSE status symbol (warning/risk avoidance support system) on the multi-information display changes from white to green and the system becomes operational.

- The ignition is switched ON.
- The vehicle speed is about 64 km/h (40 mph) or faster.
- The system detects white (yellow) lane lines.



NOTE

When the system does not detect a white (yellow) lane line on one side only, the system does not operate on the side that is not being detected.

When temporarily canceling the system

The LDWS goes on standby in the following cases: The LDWS operation is automatically restored when the system's operation conditions are met.

- The system cannot detect white (yellow) lane lines.
- The vehicle speed is less than about 56 km/h (35 mph).
- The turn signal lever is operated.
- The accelerator pedal is depressed.
- The steering wheel is operated.
- The brake pedal is operated.

The function is temporarily stopped.

The LDWS stops functioning in the following cases:

- The temperature in the forward sensing camera (FSC) is too high or too low.
- The windshield around the forward sensing camera (FSC) is foggy.
- The windshield around the forward sensing camera (FSC) is blocked by an obstruction, causing poor forward visibility.
- Strong light (such as sunlight, or headlights (high-beam) of on-coming vehicles) is directed at the forward sensing camera (FSC).

System malfunction

If there is a problem with the system, the i-ACTIVSENSE status symbol (warning/risk avoidance support system) (white) and the i-ACTIVSENSE warning indication/warning light on the multi-information display turns on and a message is indicated.

Refer to i-ACTIVSENSE Status Symbol (Warning/Risk Avoidance Support System) on page 4-87.

▼ LDWS Warning

If the system determines that the vehicle may deviate from its lane, a warning (beep sound, steering wheel vibration) is activated and the direction in which the system determines that the vehicle may deviate is indicated on the multi-information display.

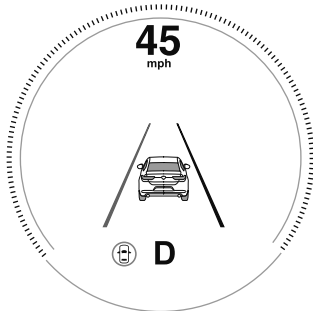

NOTE

- The LDWS settings can be changed. Refer to the Settings section in the Mazda Connect Owner's Manual.
- You may not be able to hear the LDWS warning sound depending on the surrounding conditions such as outside noise.
- If you set the LDWS to vibrate the steering wheel, you may not feel the vibrations depending on the road surface conditions.

▼ Canceling the System

The LDWS can be set to inoperable.

- **(If only the LDWS is turned off)**
Refer to the Settings section in the Mazda Connect Owner's Manual.
- **(If the LDWS is turned off by operating the i-ACTIVSENSE OFF switch)**
Refer to i-ACTIVSENSE OFF Switch on page 4-89.

NOTE

If the ignition is switched OFF while you have canceled the system using the i-ACTIVSENSE OFF switch, the system is automatically enabled the next time the ignition is switched ON. However, if the system is canceled using the personalization features, the system is not automatically enabled.

Blind Spot Monitoring (BSM)*

▼ Blind Spot Monitoring (BSM)

The BSM is designed to assist the driver in checking the area to the rear of the vehicle on both sides during lane changes by notifying the driver of the presence of vehicles approaching from the rear in an adjacent lane.

BSM operation

The BSM detects vehicles approaching from the rear while traveling in the forward direction at a speed of 10 km/h (6.3 mph) or faster and notifies the driver by turning on the BSM warning indicator light and displaying the vehicle detection screen.

If the turn signal lever is operated to signal a turn in the direction in which the BSM warning indicator light is illuminated while the approaching vehicle is detected, the BSM notifies the driver of possible danger flashing on the BSM warning indicator light, and by activating the warning sound and the warning screen indicator display.

The detection area on this system covers the driving lanes on both sides of the vehicle and from the rear part of the front doors to about 50 m (164 ft) behind the vehicle.

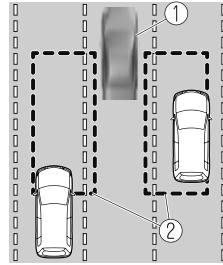

1. Your vehicle
2. Detection areas

⚠ WARNING

Always check the surrounding area visually before making an actual lane change:

The system is only designed to assist you in checking for vehicles at your rear when making a lane change. Due to certain limitations with the operation of this system, the BSM warning indicator light, the warning sound and the warning screen indicator display may not activate or they might be delayed even though a vehicle is in an adjacent driving lane. Always make it your responsibility as a driver to check the rear.

NOTE

- The BSM will operate when all of the following conditions are met:
 - The ignition is switched ON.
 - The i-ACTIVSENSE warning indication/warning light in the instrument cluster is turned off.
 - The vehicle speed is about 10 km/h (6.3 mph) or faster.

- The BSM will not operate under the following circumstances.
 - The vehicle speed falls below about 10 km/h (6.3 mph) even though the i-ACTIVSENSE warning indication/warning light is turned off.
 - The shift lever (manual transmission)/selector lever (automatic transmission) is shifted to reverse (R) and the vehicle is reversing.
 - The turning radius is small (making a sharp turn, turning at intersections).
- In the following cases, the i-ACTIVSENSE warning indication/warning light turns on and operation of the system is stopped. If the i-ACTIVSENSE warning indication/warning light remains illuminated, have the vehicle inspected at an Authorized Mazda Dealer as soon as possible.
 - Some problem with the system including the BSM warning indicator lights is detected.
 - A large deviation in the installation position of a rear side radar sensor on the vehicle has occurred.
 - There is a large accumulation of snow or ice on the rear bumper near a rear side radar sensor. Remove any snow, ice or mud on the rear bumper.
 - Driving on snow-covered roads for long periods.
 - The temperature near the rear side radar sensor becomes extremely hot due to driving for long periods on slopes during the summer.
 - The battery voltage has decreased.
- Under the following conditions, the rear side radar sensor cannot detect target objects or it may be difficult to detect them.
 - The rear bumper around the rear side radar sensor is deformed.
 - Radio wave interference from a radar sensor equipped on a nearby vehicle.
 - The approaching vehicle is any of the following shapes.
 - a) The size of the vehicle body is extremely small.
 - b) The vehicle height is extremely low or high.
 - c) A special type of vehicle with a complex shape.
 - A vehicle is in the detection area at the rear in an adjacent driving lane but it does not approach. The BSM determines the condition based on radar detection data.
 - A vehicle is traveling alongside your vehicle at nearly the same speed for an extended period of time.
 - Vehicles approaching in the opposite direction.
 - A vehicle in an adjacent driving lane is attempting to pass your vehicle.
 - A vehicle is in an adjacent lane on a road with extremely wide driving lanes. The detection area of the rear side radar sensor is set at the road width of expressways.
- In the following case, the flashing of the BSM warning indicator light, and the activation of the warning sound and the warning screen indicator display may not occur or they may be delayed.
 - A vehicle makes a lane change from a driving lane two lanes over to an adjacent lane.
 - Driving on steep slopes.
 - Crossing the summit of a hill or mountain pass.

- When there is a difference in the height between your driving lane and the adjacent lane.
- Directly after the BSM system becomes operable by changing the setting.
- If the road width is extremely narrow, vehicles two lanes over may be detected. The detection area of the rear side radar sensor is set according to the road width of expressways.
- The BSM warning indicator light may turn on and the vehicle detection screen may be displayed in reaction to stationary objects (guardrails, tunnels, sidewalls, and parked vehicles) on the road or the roadside.

①

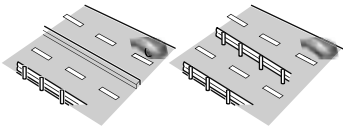

1. Objects such as guardrails and concrete walls running alongside the vehicle.

①

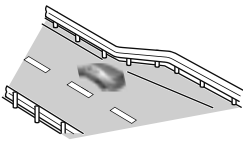

1. Places where the width between guardrails or walls on each side of the vehicle narrows.

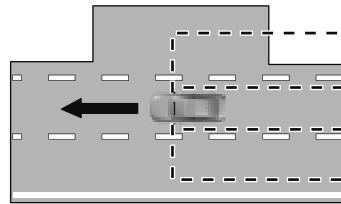
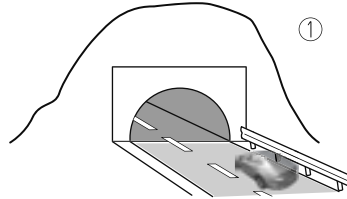

1. The walls at the entrance and exits of tunnels, turnouts.
- A BSM warning indicator light may flash or the warning beep may be activated several times when making a turn at a city intersection.
 - Turn off the BSM while pulling a trailer or while an accessory such as a bicycle carrier is installed to the rear of the vehicle. Otherwise, the radar's radio waves will be blocked causing the system to not operate normally.
 - In the following cases, it may be difficult to view the illumination/ flashing of the BSM warning indicator lights equipped on the door mirrors.
 - Snow or ice is adhering to the door mirrors.
 - The front door glass is fogged or covered in snow, frost or dirt.

- The rear side radar sensor of the BSM may be regulated under the radio wave related laws of the country where the vehicle is driven. If this system is used abroad, it may be necessary to turn off the system. Refer to Rear Side Radar Sensor on page 4-211.
- The system switches to the Rear Cross Traffic Alert (RCTA) function when the shift lever (manual transmission) or the selector lever (automatic transmission) is shifted to the reverse (R) position. Refer to Rear Cross Traffic Alert (RCTA) on page 4-116.

▼ **Blind Spot Monitoring (BSM) Warning Indicator Lights/Display Indicator/Blind Spot Monitoring (BSM) Warning Beep**

The BSM system notifies the driver of the presence of vehicles in adjacent lanes or at the rear of the vehicle using the BSM warning indicator light, the warning sound and the display indicator while the systems are operational.

BSM warning indicator lights

The BSM warning indicator lights are equipped on the left and right door mirrors. The warning indicator lights turn on when a vehicle approaching from the rear in an adjacent lane is detected.

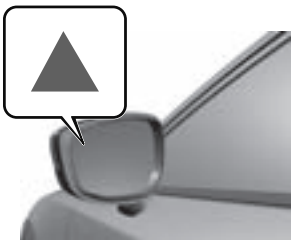

When the ignition is switched ON, the warning indicator light turns on momentarily and then turns off after a few seconds.

Function for canceling illumination dimmer

If the BSM warning indicator lights turn on when the parking lights are turned on, the brightness of the BSM warning indicator lights is dimmed.

If the BSM warning indicator lights are difficult to see due to glare from surrounding brightness when traveling on snow-covered roads or under foggy conditions, press the dimmer cancellation button to cancel the dimmer and increase the brightness of BSM warning indicator lights when they turn on.

Refer to Dashboard Illumination on page 4-18.

Display indicator

The detected approaching vehicle and warning are displayed in the multi-information display and active driving display (vehicles with active driving display).

Multi-information Display

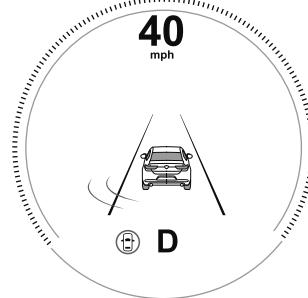

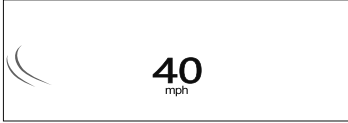
Active Driving Display (vehicles with active driving display)

The detected direction is displayed with a detection indicator (white) when an approaching vehicle is detected. In addition, if the turn signal lever is operated to signal a lane change while the vehicle is detected, the display changes the color (amber) of the warning indicator.

BSM warning beep

The BSM warning beep is activated simultaneously with the flashing of a BSM warning indicator light.

▼ Canceling Operation of Blind Spot Monitoring (BSM)

The BSM system can be set to inoperable.

- **(If only the BSM is turned off)**
Refer to the Settings section in the Mazda Connect Owner's Manual.
- **(If the BSM is turned off by operating the i-ACTIVSENSE OFF switch)**
Refer to i-ACTIVSENSE OFF Switch on page 4-89.

NOTE

If the ignition is switched OFF while you have canceled the system using the i-ACTIVSENSE OFF switch, the system is automatically enabled the next time the ignition is switched ON. However, if the system is canceled using the personalization features, the system is not automatically enabled.

Traffic Sign Recognition System (TSR)*

▼ Traffic Sign Recognition System (TSR)

The TSR helps prevent the driver from overlooking traffic signs, and provides support for safer driving by displaying traffic signs on the active driving display/instrument cluster which are recognized by the Forward Sensing Camera (FSC) or recorded in the navigation system while the vehicle is driven.

The TSR displays the speed limit (including auxiliary signs), do not enter, and traffic stop signs.

If the vehicle speed exceeds the speed limit sign indicated in the active driving display/instrument cluster while the vehicle is driven, the system notifies the driver using the indication in the active driving display/instrument cluster and a warning sound.

Speed limit and do not enter signs

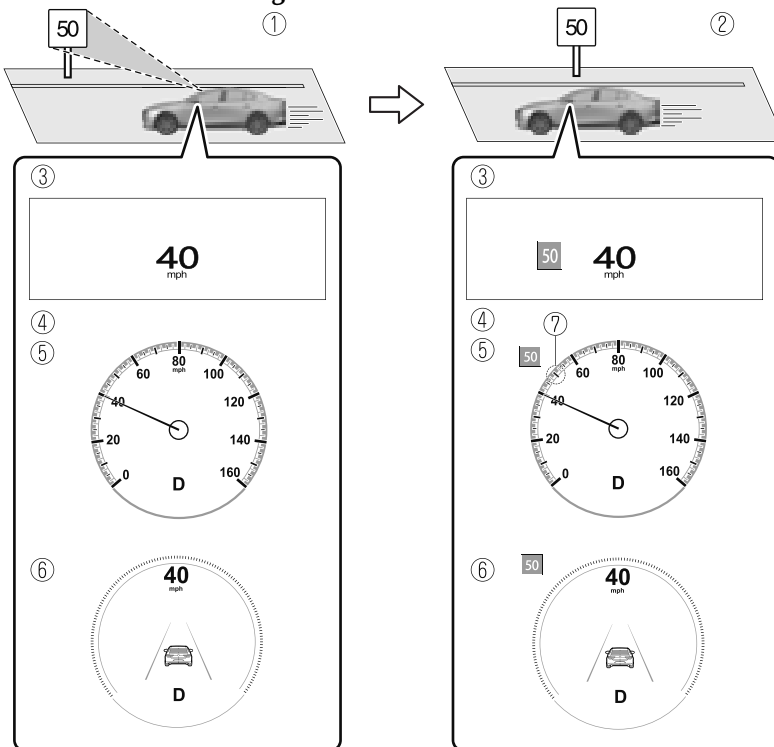

1. Sign recognized
2. Sign displayed
3. Active driving display indication

4. Instrument cluster
5. Basic display
6. i-ACTIVSENSE display
7. Recognized speed limit indication color changes.

Stop sign

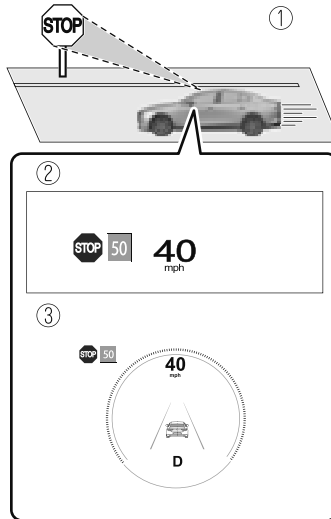

1. Sign recognized and displayed at same time
2. Active driving display indication
3. Instrument cluster

⚠ WARNING

Always check the traffic signs visually while driving:

The TSR helps prevent the driver from overlooking traffic signs and provides support for safer driving. Depending on the weather conditions or problems with traffic signs, a traffic sign may not be recognized or a traffic sign different from the actual traffic sign may be displayed. Always make it your responsibility as a driver to check the actual traffic signs. Otherwise, it could result in an accident.

NOTE

- The TSR is not supported in some countries or regions. For information concerning the supported countries or regions, consult an Authorized Mazda Dealer.
- The TSR operates only if the navigation system SD card (Mazda genuine) is inserted in the SD card slot. Consult an Authorized Mazda Dealer for details.
- The TSR does not operate if there is a malfunction in the Forward Sensing Camera (FSC).
- Under the following conditions, the TSR may not operate normally.
 - An object placed on the dashboard is reflected in the windshield and picked up by the camera.
 - Heavy luggage is loaded in the luggage compartment or on the rear seat and the vehicle is tilted.
 - The tire pressures are not adjusted to the specified pressure.
 - Tires other than standard tires are equipped.
 - The vehicle is driven on the ramp and surrounding area to or from a rest area or a tollgate on a highway.
 - When surrounding brightness suddenly changes such as when entering or exiting a tunnel.
 - The illumination of the headlights is weakened because of dirt or the optical axis is deviated.
 - The windshield is dirty or foggy.
 - The windshield and camera are fogged (water droplets).
 - Strong light is directed at the front of the vehicle (such as backlight or high-beam headlights of on-coming vehicles).
 - The vehicle is making a sharp turn.
 - Strong light reflects off the road.
 - A traffic sign is in a position which makes it difficult to reflect the light from the vehicle's headlights, such as when the vehicle is driven at night or in a tunnel.
 - The vehicle is driven under weather conditions such as rain, fog, or snow.
 - The stored map data for the navigation system is not current.
 - A traffic sign is obscured by mud or snow.
 - A traffic sign is concealed by trees or a vehicle.
 - A traffic sign is partially shaded.
 - A traffic sign is bent or warped.
 - A traffic sign is too low or too high.
 - A traffic sign is too bright or too dark (including electronic traffic signs).
 - A traffic sign is too big or too small.
 - There is an object similar to the traffic sign being read (such as another traffic sign or other signs resembling it).
- The TSR can be set to invisible on the active driving display.
Refer to the Settings section in the Mazda Connect Owner's Manual.

▼ Traffic Sign Display Indication

The following traffic signs are displayed on the active driving display/ instrument cluster.

Speed limit signs



Do not enter signs



Stop signs



NOTE

Speed limit signs

- When the vehicle speed is about 1 km/h (0.6 mph) or faster, the speed limit sign is displayed when any one of the following conditions are met.
 - The Forward Sensing Camera (FSC) recognizes a speed limit sign as a sign targeted for your vehicle and the vehicle passes it.
 - The speed limit sign stored in the navigation system is read.
- In the following cases, display of the speed limit sign stops.
 - Each sensor determines that the vehicle has changed direction of travel.
 - The Forward Sensing Camera (FSC) recognizes a new speed limit sign which differs from the previous one (displays the new speed limit sign).

- The speed limit sign stored in the navigation system is not read within a certain period of time (if the Forward Sensing Camera (FSC) does not recognize a speed limit sign, the speed limit sign stored in the navigation system is displayed).
- The vehicle speed exceeds the displayed speed limit sign by 30 km/h (19 mph) or more after a certain period of time has elapsed since the speed limit sign was displayed. (Except when there is information for the speed limit sign in the navigation system)

Do not enter signs

- A do not enter sign is displayed when all of the following conditions are met.
 - The vehicle speed is about 60 km/h (37 mph) or slower.
 - The Forward Sensing Camera (FSC) recognizes a do not enter sign as a sign targeted for your vehicle and the vehicle passes it.
- When the Forward Sensing Camera (FSC) recognizes the do not enter sign and a certain period of time has elapsed since the vehicle passed the sign, display of the do not enter sign stops.

Stop sign

- A stop sign is displayed when all of the following conditions are met:
 - The vehicle speed is about 65 km/h (40 mph) or slower.
 - The Forward Sensing Camera (FSC) recognizes a stop sign as a sign targeted for your vehicle.

- When a certain period of time has elapsed since the stop sign was displayed, display of the stop sign stops.

▼ Excessive Speed Warning

If the vehicle speed exceeds the speed limit sign displayed in the active driving display/instrument cluster, the area around the speed limit sign flashes in amber and the warning sound is activated at the same time. If the vehicle speed continues to exceed the displayed speed limit sign, the indication stops flashing and remains on. Check the surrounding conditions and adjust the vehicle speed to the legal speed using the appropriate operation such as depressing the brake pedal.

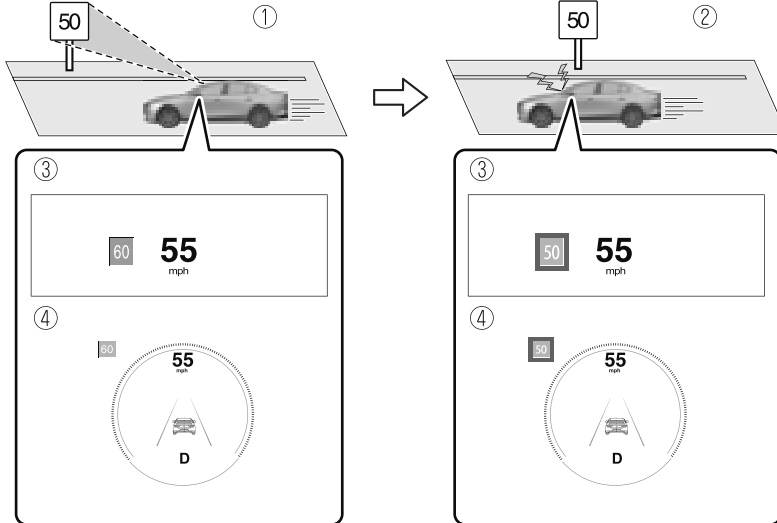

1. Vehicle is doing 55 mph when 50 mph speed limit sign is recognized.
2. Vehicle continues to do 55 mph after 50 mph speed limit sign is recognized.
3. Active driving display indication
4. Instrument cluster

The excessive speed warning is initially set to inoperable. If you want to activate the excessive speed warning, change the setting in the personalization features. In addition, the warning pattern and the warning activation timing differ depending on the setting contents.

Refer to the Settings section in the Mazda Connect Owner's Manual.

Speed Limit Sign Alert setting

- Off: The excessive speed warning is not activated.
- Visual: The area around the speed limit sign displayed in the display flashes in amber, and if the vehicle speed continues to exceed the displayed speed limit sign, the indication stops flashing and remains on.
- Visual + Audible: The area around the speed limit sign displayed in the display flashes in amber and the warning sound is activated at the same time. If the vehicle speed continues to exceed the displayed speed limit sign, the indication stops flashing and remains on. The warning sound is activated continuously until the vehicle speed decreases below the speed limit sign.

Speed Limit Sign Threshold setting

- + 0 km/h (+ 0 mph): If the vehicle speed exceeds the speed limit sign displayed in the display, the excessive speed warning is activated.
- + 5 km/h (+ 3 mph): If the vehicle speed exceeds the speed limit sign displayed in the display by 5 km/h (3 mph), the excessive speed warning is activated.
- + 10 km/h (+ 5 mph): If the vehicle speed exceeds the speed limit sign displayed in the display by 10 km/h (5 mph), the excessive speed warning is activated.

NOTE

- In the following cases, the excessive speed warning stops operating.
 - The vehicle speed is less than the speed of the displayed speed limit sign. (If the activation timing for the excessive speed warning is changed in the personalization features, the excessive speed warning stops operating when the vehicle speed is less than the changed vehicle speed.
 - A speed limit sign indication has been updated and the vehicle speed is lower than the updated indication.
 - Display of the speed limit sign stops.
- The warning indication is displayed at the same time the excessive speed warning sound is activated if the vehicle speed exceeds the speed indicated on the speed limit sign.
Refer to Excessive Speed Warning on page 7-47.
- If the Forward Sensing Camera (FSC) or data recorded in the navigation system incorrectly recognizes the actual speed limit sign at a lower speed, the excessive speed alarm is activated even if the vehicle is driven at the legal speed.

Distance & Speed Alert (DSA)*

▼ Distance & Speed Alert (DSA)

The DSA is a system which provides advice for maintaining the appropriate distance between vehicles and notifies the driver of the recommended, safe distance to maintain with a vehicle ahead. The system measures the distance between your vehicle and a vehicle ahead while the vehicle speed is about 30 km/h (19 mph) or faster. If the distance between your vehicle and a vehicle ahead is close, the system alerts the driver of a possible collision using an indication on the display.

WARNING

Do not rely completely on the DSA:

The ability of the system to detect a vehicle ahead is limited depending on the type of vehicle ahead, weather conditions, or traffic conditions. In addition, the system is not for maintaining the distance between your vehicle and a vehicle ahead. If you neglect to operate the accelerator and brake pedals correctly, it could lead to an accident. Always check the safety of the surrounding area and depress the brake pedal or accelerator pedal while keeping a safe distance from vehicles ahead or on-coming vehicles.

Operation conditions

The DSA operates when the following conditions are all met.

- The ignition is switched ON.
- The DSA is turned on.
- The shift lever (manual transmission vehicle) or the selector lever (automatic transmission vehicle) is in a position other than R.
- The vehicle speed is about 30 km/h (19 mph) or faster.
- i-ACTIVSENSE status symbol (warning/risk avoidance support system) (green) is displayed.

NOTE

- The objects which activate the system are four-wheeled vehicles.
- The DSA may also operate in the presence of motorcycles and bicycles.
- The DSA may not operate normally when the speed of a vehicle ahead is too slow.
- The system does not operate with the following objects.
 - Vehicles approaching in the opposite direction.
 - Stationary objects (stopped vehicles, obstructions)
- The DSA can be set to inoperable.
 - **(If only the DSA is turned off)**
Refer to the Settings section in the Mazda Connect Owner's Manual.
 - **(If the DSA is turned off by operating the i-ACTIVSENSE OFF switch)**
Refer to i-ACTIVSENSE OFF Switch on page 4-89.

- If the ignition is switched OFF while you have canceled the system using the i-ACTIVSENSE OFF switch, the system is automatically enabled the next time the ignition is switched ON. However, if the system is canceled using the personalization features, the system is not automatically enabled.

▼ Vehicle Ahead Close Proximity Warning

When the system determines that the distance between your vehicle and a vehicle ahead is close, the i-ACTIVSENSE status symbol (warning/risk avoidance support system) changes from green to amber and the warning indication is displayed on the multi-information display. While checking the safety of the surrounding area, depress the brake pedal while keeping a safe distance from the vehicle ahead.

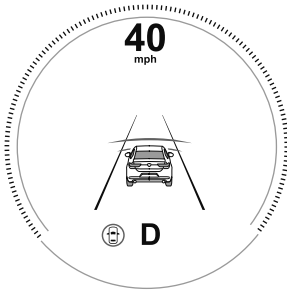

Driver Attention Alert (DAA)*

▼ Driver Attention Alert (DAA)

The DAA is a system which detects driver fatigue and decreased attentiveness, and encourages the driver to take a rest.

When the vehicle is driven inside traffic lane lines at about 65 to 140 km/h (41 to 86 mph), the DAA estimates the amount of accumulated fatigue and decreased attentiveness of the driver based on the information from the Forward Sensing Camera (FSC) and other vehicle information, and encourages the driver to take a rest using an indication on the multi-information display and a warning sound.

Use the DAA on expressways or highways.

Refer to Forward Sensing Camera (FSC) on page 4-203.

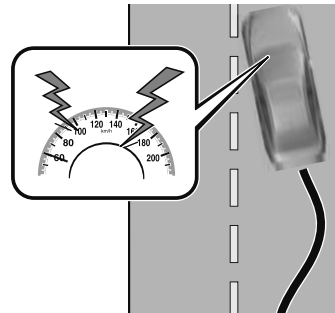

 WARNING**Do not rely completely on DAA and always drive carefully:**

The DAA detects driver fatigue and decreased attentiveness and encourages the driver to take a rest, however, it is not designed to prevent the vehicle from straying. If you rely too much on the DAA it could lead to an accident. Drive carefully and operate the steering wheel appropriately. In addition, the system may not be able to detect driver fatigue and decreased attentiveness correctly depending on the traffic and driving conditions. The driver must take sufficient rest in order to drive safely.

NOTE

- The DAA operates when all of the following conditions are met.
 - The vehicle speed is about 65 to 140 km/h (41 to 86 mph).
 - The system detects white (yellow) lane lines.
 - The system has completed learning of the driver's driving data after 60 minutes have passed since the driver began driving vehicle.
- The DAA does not operate under the following conditions.
 - The vehicle speed is less than about 65 km/h (41 mph).
 - The vehicle speed exceeds about 140 km/h (86 mph).
 - The vehicle is making a sharp turn.
 - The vehicle is changing lanes.
 - The system cannot detect white (yellow) lane lines.
- The DAA may not operate normally under the following conditions.
 - White (yellow) lane lines are less visible because of dirt or fading/patchiness.
 - The vehicle is jolted or swayed continuously by strong winds or rough roads.
 - The vehicle is driven aggressively.
 - When making frequent lane changes.
 - The vehicle is making a curve.
- The DAA detects driver fatigue and decreased attentiveness based on the driving data when the vehicle is driven at about 65 to 140 km/h (41 to 86 mph) for about 20 minutes. The driving data will be reset under the following conditions.
 - The vehicle is stopped for 15 minutes or longer.
 - The vehicle is driven at less than about 65 km/h (41 mph) for about 30 minutes.
 - The ignition is switched off.
- After the DAA has displayed the first message encouraging rest, it does not display the next one until 60 minutes have passed.

▼ Driver Attention Alert (DAA) Display

When the system detects driver fatigue or decreased attentiveness, it activates the warning sound and displays an alert in the multi-information display.

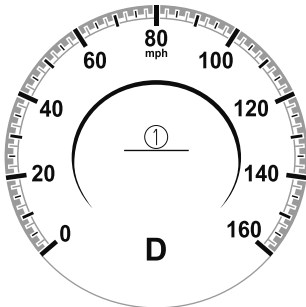

1. "Time for a Break" message is displayed

▼ Canceling Driver Attention Alert (DAA)

The DAA can be set to not activate. Refer to the Settings section in the Mazda Connect Owner's Manual.

Driver Monitoring (DM)*

▼ Driver Monitoring (DM)

The DM is a system which detects driver fatigue and sleepiness, and encourages the driver to take a rest. While driving the vehicle at about 5 km/h (3 mph) or faster, the DM detects changes in the driver's facial features using the driver monitoring camera. The system then estimates the amount of accumulated fatigue and sleepiness of the driver and encourages the driver to take a rest using a warning indication in the instrument cluster and a warning sound.

Two types of warning indication patterns are set for notifying the driver based on the estimated amount of accumulated fatigue and sleepiness of the driver.

- Fatigue and sleepiness are detected: Warning pattern (caution)
- Much more fatigue and sleepiness are detected: Warning pattern (warning)

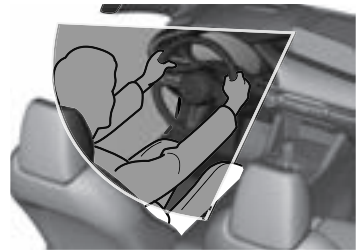

⚠ WARNING

Do not rely completely on the DM and always drive carefully:

The DM is a system which detects driver fatigue and sleepiness, and encourages the driver to take a rest. This is not designed to prevent driver fatigue and sleepiness, and over-reliance on the system could lead to an accident. Drive carefully and turn the steering wheel appropriately. In addition, the system may not be able to detect driver fatigue and sleepiness correctly depending on the traffic and driving conditions. The driver must take sufficient rest in order to drive safely.

Operation conditions

The DM begins monitoring after 20 minutes have passed since the driver began driving the vehicle and when the vehicle speed is about 5 km/h (3 mph) or faster.

NOTE

- If the vehicle speed decreases to less than about 5 km/h (3 mph) while the DM is monitoring, the DM stops monitoring for 6 minutes even if the vehicle speed returns to about 5 km/h (3 mph) or faster.
- If the driver monitoring camera does not recognize the driver correctly, the DM may not monitor correctly. Refer to Driver Monitoring Camera on page 4-214.
- After the DM has displayed the first message encouraging the driver to take a rest, it does not display it again during the following periods.

- After displaying the warning pattern (caution), the next warning pattern (caution) is not displayed until 45 minutes have passed.
- After displaying the warning pattern (warning), the next warning pattern (warning) is not displayed until 15 minutes have passed.
- After displaying the warning pattern (warning), the next warning pattern (caution) is not displayed until 45 minutes have passed.

▼ Driver Monitoring (DM) Display

When the Driver Monitoring (DM) detects driver fatigue or sleepiness, it activates the warning sound and displays an alert in the instrument cluster.

Warning pattern (caution) (white)

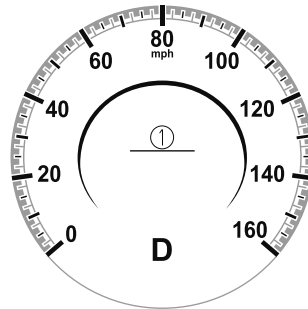

1. "Time for a Break" message is displayed

Warning pattern (warning) (amber)

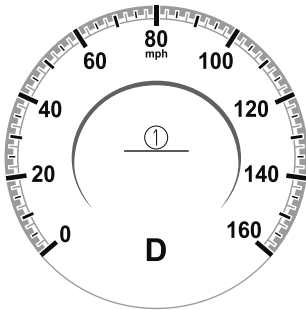

1. "Time for a Break" message is displayed

▼ Canceling Driver Monitoring (DM)

The Driver Monitoring (DM) can be set to inoperable. Refer to the Settings section in the Mazda Connect Owner's Manual.

Front Cross Traffic Alert (FCTA)*

▼ Front Cross Traffic Alert (FCTA)

The FCTA is designed to assist the driver in checking both sides of the vehicle when the vehicle starts to drive at an intersection. The FCTA detects vehicles approaching from the blind spots on the front left and right sides of the vehicle when the vehicle starts to drive at an intersection, and notifies the driver of possible danger using the warning indication on the display and the warning sound.

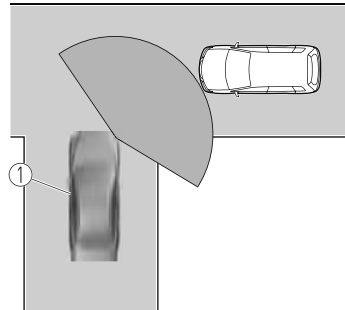

1. Your vehicle

⚠ WARNING

Always check the surrounding area visually when the vehicle starts to drive at an intersection:

Due to certain limitations with the operation of this system, the warning indication on the display or the warning sound might be delayed even though there is a vehicle approaching from a blind spot. Always make it your responsibility as a driver to check the left and right sides.

Operation conditions

The system operates when all of the following conditions are met:

- When your vehicle is driven at less than about 10 km/h (6 mph).
- **(Automatic transmission)**
The selector lever is in the D position.
- **(Manual transmission)**
The shift lever is in a position other than N or R.
- When a vehicle approaches from the front side of your vehicle at a vehicle speed of about 5 km/h (3 mph) or faster.

FCTA operation

When your vehicle is stopped

When a vehicle is approaching, the system notifies the driver that a vehicle is approaching on the following display (white arrow).

Multi-information display

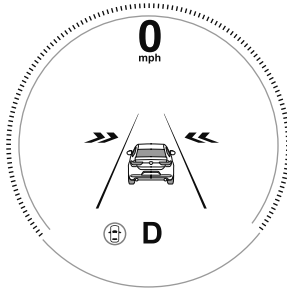

Active driving display (vehicles with active driving display)

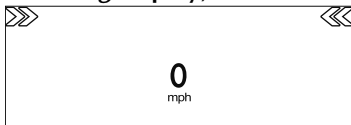

360°view monitor (vehicles with 360°view monitor)



When your vehicle is being driven

If there is a possibility of a collision with an approaching vehicle, a warning indication is displayed on the following display (amber arrow) and the warning sound is activated at the same time.

Multi-information display

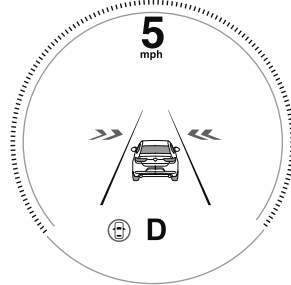

Active driving display (vehicles with active driving display)

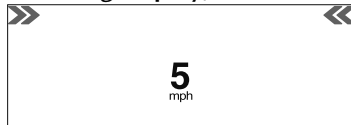

360°view monitor (vehicles with 360°view monitor)

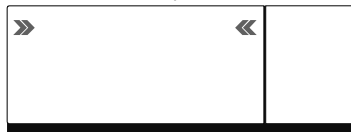

NOTE

- The system may operate under the following conditions even if a vehicle is not approaching.

- An object that reflects the radio waves of the radar such as a parked vehicle, guardrail, or wall is directly next to your vehicle.
- Vehicles are stopped in the area around your vehicle such as during heavy traffic.
- A vehicle approaching from the front or side of your vehicle slows down.
- A vehicle approaching from the front or left side of your vehicle makes a right or left turn directly in front of your vehicle.
- A vehicle or pedestrian moves in the parking lot or on the sidewalk in the area surrounding your vehicle.
- After making a left or right turn, an on-coming vehicle is present.
- When passing an on-coming vehicle.
- A vehicle overtakes your vehicle while it is stopped.
- Your vehicle is in an area where strong radio waves or electrical noise may occur such as near a television tower or power plant.
- Under the following conditions, the front side radar sensor cannot detect approaching vehicles or it might be difficult to detect them, and the system may not operate normally.
 - The front side radar sensor detection area is obstructed by a nearby wall or vehicle.
 - Directly after the system becomes operable.
 - Radio wave interference from a radar sensor equipped on a nearby vehicle.
 - The approaching vehicle has any of the following shapes.
 - a) The size of the vehicle body is extremely small.
 - b) The vehicle height is extremely low or high.
 - c) A special type of vehicle with a complex shape
 - A vehicle suddenly enters the detection area from the front or side of your vehicle.
 - A vehicle that has stopped suddenly starts to move.
 - Multiple objects move at the same time.
 - The vehicle is driven in bad weather conditions such as heavy rain, fog, snow, or sand storms.
 - The vehicle is driven on a sharp curve or on bumpy roads.
 - An object that reflects the radio waves of the radar such as a parked vehicle, guardrail, or wall is directly next to your vehicle.
 - A vehicle approaches while turning (Such as roundabout)
 - The vehicle is driven at an extremely slow speed.
- In the following cases, the system turns on the i-ACTIVSENSE warning indication/warning light and operation of the system is stopped. If the i-ACTIVSENSE warning indication/warning light remains on, have the vehicle inspected by an Authorized Mazda Dealer as soon as possible.
 - Some problem with the system has occurred.
 - The front side radar sensor installation position is greatly deviated.
 - There is a large accumulation of snow or ice on the front bumper near a front side radar sensor.
 - The temperature near the radar sensors becomes extremely hot due to driving for a long time on slopes during the summer.
 - The battery voltage has decreased.

- The front side radar sensor of the FCTA may be regulated under the radio wave related laws of the country where the vehicle is driven. If this system is used abroad, it may be necessary to turn off the system. Refer to Front Side Radar Sensor on page 4-209.

▼ Canceling Operation of Front Cross Traffic Alert (FCTA)

The FCTA can be set to inoperable.

- **(If only the FCTA is turned off)**
Refer to the Settings section in the Mazda Connect Owner's Manual.
- **(If the FCTA is turned off by operating the i-ACTIVSENSE OFF switch)**
Refer to i-ACTIVSENSE OFF Switch on page 4-89.

NOTE

If the ignition is switched OFF while you have canceled the system using the i-ACTIVSENSE OFF switch, the system is automatically enabled the next time the ignition is switched ON. However, if the system is canceled using the personalization features, the system is not automatically enabled.

Rear Cross Traffic Alert (RCTA)*

▼ Rear Cross Traffic Alert (RCTA)

The RCTA system is designed to assist the driver in checking the area to the rear left and right sides of your vehicle while your vehicle is reversing by alerting the driver to the presence of vehicles approaching the rear of your vehicle.

The RCTA system detects vehicles approaching from the rear left and right sides of your vehicle and the rear of your vehicle while your vehicle is being reversed out of a parking space, and notifies the driver of possible danger using the Blind Spot Monitoring (BSM) warning indicator lights and the warning buzzer.

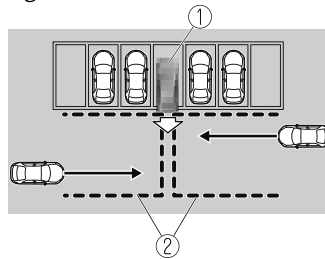

1. Your vehicle
2. Detection areas

⚠ WARNING

Always check the surrounding area visually before actually putting the vehicle in reverse:

The system is only designed to assist you in checking for vehicles at the rear when putting the vehicle in reverse. Due to certain limitations with the operation of this system, the Blind Spot Monitoring (BSM) warning indicator lights may not flash or it might be delayed even though a vehicle is behind your vehicle. Always make it your responsibility as a driver to check the rear.

RCTA operation

1. The RCTA system operates when the shift lever (manual transmission) or the selector lever (automatic transmission) is shifted to the reverse (R) position.
2. If there is the possibility of a collision with an approaching vehicle, the Blind Spot Monitoring (BSM) warning indicator lights flashes and the warning beep is activated simultaneously.

Rear view monitor (vehicles with Rear view monitor)

The RCTA warning indication in the rearview monitor also synchronizes with the Blind Spot Monitoring (BSM) warning indicator light on the door mirrors.

360°view monitor (vehicles with 360°view monitor)

The RCTA warning indication in the 360°view monitor also synchronizes with the Blind Spot Monitoring (BSM) warning indicator light on the door mirrors.

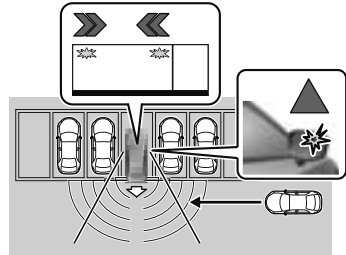

Function for canceling illumination dimmer

If the BSM warning indicator lights turn on when the parking lights are turned on, the brightness of the BSM warning indicator lights is dimmed.

If the BSM warning indicator lights are difficult to see due to glare from surrounding brightness when traveling on snow-covered roads or under foggy conditions, press the dimmer cancellation button to cancel the dimmer and increase the brightness of BSM warning indicator lights when they turn on.

Refer to Dashboard Illumination on page 4-18.

NOTE

- The system may operate under the following conditions even if a vehicle is not approaching.
 - An object that reflects the radio waves of the radar such as a parked vehicle, guardrail, or wall is directly next to your vehicle.
 - A vehicle approaching from the rear left and right side of your vehicle slows down.

- A vehicle approaching from the rear left and right side of your vehicle makes a right or left turn directly in front of your vehicle.
- A vehicle overtakes your vehicle while it is stopped.
- Your vehicle is in an area where strong radio waves or electrical noise may occur such as near a television tower or power plant.
- In the following cases, the i-ACTIVSENSE warning indication/warning light turns on and operation of the system is stopped. If the i-ACTIVSENSE warning indication/warning light remains illuminated, have the vehicle inspected at an Authorized Mazda Dealer as soon as possible.
 - Some problem with the system including the Blind Spot Monitoring (BSM) warning indicator lights has occurred.
 - A large deviation in the installation position of a rear side radar sensor on the vehicle has occurred.
 - There is a large accumulation of snow or ice on the rear bumper near a rear side radar sensor.
 - Driving on snow-covered roads for long periods.
 - The temperature near the radar sensors becomes extremely hot due to driving for long periods on slopes during the summer.
 - The battery voltage has decreased.
- Under the following conditions, the rear side radar sensor cannot detect approaching vehicles or it might be difficult to detect them, and the system may not operate normally.
 - The vehicle speed when reversing is about 15 km/h (9 mph) or faster.

- The rear side radar sensor detection area is obstructed by a nearby wall or parked vehicle. (Reverse the vehicle to a position where the radar sensor detection area is no longer obstructed.)

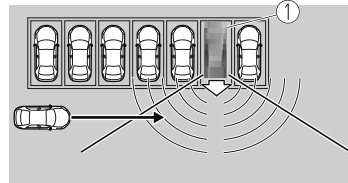

1. Your vehicle

- A vehicle is approaching directly from the rear of your vehicle.

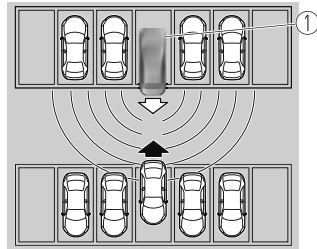

1. Your vehicle

- The vehicle is parked at an angle.

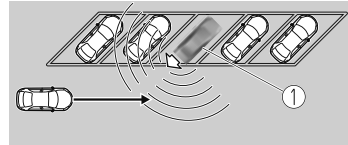

1. Your vehicle

- Directly after the RCTA system becomes operable using the personalization feature.
- Radio wave interference from a radar sensor equipped on a nearby parked vehicle.

- In the following cases, it may be difficult to view the illumination/ flashing of the Blind Spot Monitoring (BSM) warning indicator lights equipped on the door mirrors.
 - Snow or ice adheres to the door mirrors.
 - The front door glass is fogged or covered in snow, frost or dirt.
- Turn off the RCTA system while pulling a trailer or while an accessory such as a bicycle carrier is installed to the rear of the vehicle. Otherwise, the radio waves emitted by the radar will be blocked causing the system to not operate normally.
- The rear side radar sensor of the RCTA may be regulated under the radio wave related laws of the country where the vehicle is driven. If this system is used abroad, it may be necessary to turn off the system. Refer to Rear Side Radar Sensor on page 4-211.

▼ Canceling Operation of Rear Cross Traffic Alert (RCTA)

The RCTA can be set to inoperable.

- **(If only the RCTA is turned off)**
Refer to the Settings section in the Mazda Connect Owner's Manual.
- **(If the RCTA is turned off by operating the i-ACTIVSENSE OFF switch)**
Refer to i-ACTIVSENSE OFF Switch on page 4-89.

NOTE

If the ignition is switched OFF while you have canceled the system using the i-ACTIVSENSE OFF switch, the system is automatically enabled the next time the ignition is switched ON. However, if the system is canceled using the personalization features, the system is not automatically enabled.

Mazda Radar Cruise Control (MRCC) (Manual Transmission)*

▼ Mazda Radar Cruise Control (MRCC)

The MRCC system is designed to maintain headway control*¹ with a vehicle ahead according to your vehicle's speed using a front radar sensor to detect the distance to the vehicle ahead and a preset vehicle speed without you having to use the accelerator or brake pedals.

*¹ Headway Control: Control of the distance between your vehicle and the vehicle ahead detected by the MRCC system.

Additionally, if your vehicle starts closing in on the vehicle ahead such as if the vehicle ahead brakes suddenly, a warning sound and a warning indication in the display are activated simultaneously to alert you to maintain a sufficient distance between the vehicles.

Also refer to the following before using the MRCC.

- Front radar sensor (page 4-207)

WARNING

Do not rely completely on the MRCC:

The MRCC system has detection limitations depending on the type of vehicle ahead and its conditions, the weather conditions, and the road conditions. Additionally, the system may be unable to decelerate sufficiently to avoid hitting the vehicle ahead if the vehicle ahead applies the brakes suddenly or another vehicle cuts into the driving lane, which could result in an accident.

Always drive carefully and verify the surrounding conditions and depress the brake pedal or accelerator pedal while keeping a safe distance from vehicles ahead or on-coming vehicles.

Do not use the MRCC system in the following locations. Using the MRCC system at the following locations may result in an unexpected accident:

- General roads other than highways (Driving under these conditions using the MRCC system is not possible.)
- Roads with sharp curves and where vehicle traffic is heavy with insufficient space between vehicles, or roads where frequent and repetitive acceleration and deceleration occur (Driving under these conditions using the MRCC is not possible.)
- When entering and exiting interchanges, service areas, and parking areas of highways (If you exit a highway while headway control is in use, the vehicle ahead will no longer be tracked and your vehicle may accelerate to the set speed.)

- Slippery roads such as ice or snow-bound roads (Tires could spin causing you to lose vehicle control, or the stop hold control may not operate.)
- Long, descending slopes (to maintain distance between vehicles, the system automatically and continuously applies the brakes which could result in the loss of brake power.)
- Slopes with a steep gradient (The vehicle ahead may not be detected correctly.)
- Two-wheeled vehicles such as motorcycles or bicycles are ahead.

For safety purposes, switch the MRCC system off when it is not being used.

Leaving the MRCC system turned on when it is not in use is dangerous as it could operate unexpectedly, resulting in an accident.



- Turn the system off when the vehicle is running on a chassis roller.
- If your vehicle is towed or you are towing something, switch the MRCC system off to prevent an unexpected operation.

NOTE

- The MRCC system does not detect the following as physical objects.
 - Vehicles approaching in the opposite direction
 - Pedestrians
 - Stationary objects (stopped vehicles, obstructions)
 - If a vehicle ahead is traveling at an extremely low speed, the system may not detect it correctly.

- If there is a structure on the road or an object (such as a monorail) at a low height off the ground in front of the vehicle, the system may operate. Therefore, do not use the MRCC.
- Do not use the MRCC system under conditions in which close proximity warnings are frequently activated.
- During headway control travel, the system accelerates and decelerates your vehicle in conjunction with the speed of the vehicle ahead. However, if it is necessary to accelerate for a lane change or if the vehicle ahead brakes suddenly causing you to close in on the vehicle rapidly, accelerate using the accelerator pedal or decelerate using the brake pedal depending on the conditions.
- While the MRCC system is in use, it does not cancel even if the shift lever is operated and any intended engine braking will not occur. If deceleration is required, lower the vehicle speed setting or depress the brake pedal.
- While braking by the MRCC control is operating, you might hear an operation sound, however, this does not indicate a problem.
- The brake lights turn on while braking by the MRCC control is operating, however, they may not turn on while the vehicle is on a down slope at the set vehicle speed or traveling at a constant speed and following a vehicle ahead.
- Stop the headway control function to switch the system to the cruise control function. Refer to the Settings section in the Mazda Connect Owner's Manual.

▼ **Mazda Radar Cruise Control (MRCC) Display Indication**

The MRCC setting status and operation conditions are indicated on the multi-information display and the active driving display.

Multi-information display (Basic display)

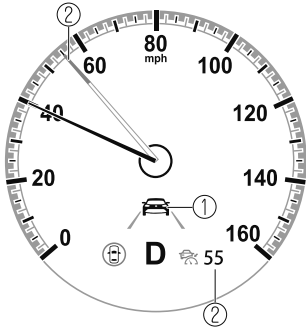

- 1. Vehicle ahead display
- 2. MRCC set vehicle speed

Multi-information display (i-ACTIVSENSE display)

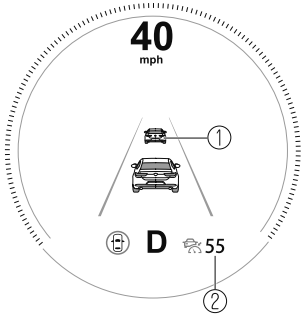

- 1. Vehicle ahead display
- 2. MRCC set vehicle speed

Active driving display



- 1. Vehicle ahead display
- 2. MRCC set vehicle speed

If there is a problem with the MRCC system, a message is displayed on the multi-information display. Check the center display to verify the problem and then have your vehicle inspected by an Authorized Mazda Dealer. Refer to If a Warning Light Turns On or Flashes on page 7-27.

▼ Close Proximity Warning

If your vehicle rapidly closes in on the vehicle ahead because the vehicle ahead applies the brakes suddenly while you are traveling in headway control, the warning sound activates and the brake warning is indicated in the display. Always verify the safety of the surrounding area and depress the brake pedal while keeping a safe distance from the vehicle ahead. Additionally, keep a safe distance from the vehicles behind you.

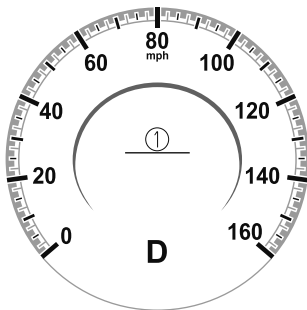

1. "Depress Brake Pedal" message is displayed

NOTE

In the following cases, the warnings and brakes may not operate even if your vehicle starts closing in on the vehicle ahead.

- You are driving your vehicle at the same speed as the vehicle ahead.
- Directly after the MRCC system has been set.
- Directly after the accelerator pedal is released.
- Another vehicle cuts into the driving lane in front of you.

▼ Setting the System

The MRCC system operates when all of the following conditions are met.

- Vehicle speed is 30 km/h (19 mph) to 145 km/h (90 mph)
- The MRCC is turned on.
- The brake pedal is not depressed.
- The parking brake is released (Electric Parking Brake (EPB) indicator light is turned off).
- There is no problem with the DSC.
- All the doors are closed.
- The driver's seat belt is fastened.
- The shift lever is in a position other than reverse (R) or neutral (N).
- The clutch pedal is not depressed.

Turning on the system

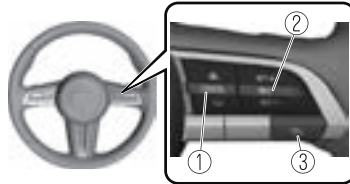

1. CANCEL switch
2. RES switch
3. MRCC switch

When the MRCC switch is pressed once, the MRCC system turns on, and the MRCC standby indication (white) turns on and the vehicle speed and the distance between the vehicles while in headway control can be set.



In addition, the MRCC system display indication is displayed on the multi-information display and the active driving display at the same time.





NOTE

If the ignition is switched off while the MRCC system is operating, the system will be operable when the ignition is switched ON the next time.

How to set the speed

Adjust the vehicle speed to the desired setting using the accelerator pedal and press the RES switch up (SET+) or down (SET-) to start headway control. The set speed is indicated on the display. At the same time, the MRCC standby indication (white) changes to the MRCC set indication (green).



Travel status	Indication on multi-information display	Indication on active driving display
During travel at constant speed		55 mph 
During travel under headway control		



NOTE

- If a vehicle ahead is detected while traveling at a constant speed, the vehicle-ahead indication is displayed and headway control is performed. Additionally, when a vehicle ahead is no longer detected, the vehicle-ahead indication turns off and the system switches back to travel at constant speed.
- The lowest possible speed which can be set on the MRCC system is 30 km/h (19 mph).
- Headway control is not possible if the vehicle ahead is driving faster than your vehicle's set speed. Adjust the system to the desired vehicle speed using the accelerator pedal.

How to set the distance-between-vehicles during headway control

The distance-between-vehicles can be set to 4 levels; Long, medium, short, and extremely short distance.

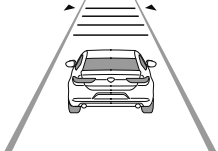
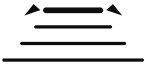
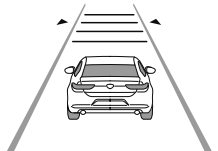
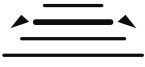
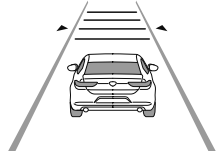
The distance-between-vehicles is set to a shorter distance by pressing the CANCEL switch down. The distance-between-vehicles is set to a longer distance by pressing the CANCEL switch up.

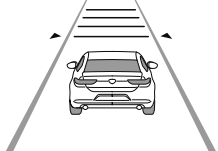
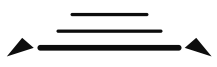
Distance-between-vehicles guideline (at 80 km/h (50 mph) vehicle speed)	Indication on multi-information display	Indication on active driving display ^{*1}
Long (about 50 m (164 ft))		
Medium (about 40 m (131 ft))		
Short (about 30 m (98 ft))		
Extremely short (about 25 m (82 ft))		

^{*1} Displays a pop-up image in the active driving display only when the driver operates the switch.

NOTE

- The distance-between-vehicles differs depending on the vehicle speed, and the slower the vehicle speed, the shorter the distance.
- When the ignition is switched to ACC or OFF and then the engine is started again, the system automatically sets the distance-between-vehicles to the previous setting.

Changing the Set Vehicle Speed

(To accelerate/decelerate using the RES switch)

When the RES switch is pressed up (SET+), the vehicle accelerates and when the RES switch is pressed down (SET-), it decelerates.

- Press and release immediately: 1 km/h (1 mph)
- Press and hold: 10 km/h (5 mph)

(To increase speed using accelerator pedal)

Depress the accelerator pedal and press the RES switch up (SET+) or down (SET-) at the desired speed. If the switch is not operated, the system returns to the set speed after you release your foot from the accelerator pedal.

NOTE

- The warnings and brake control do not operate while the accelerator pedal is depressed.

Canceling the system

When the following operations are performed, the MRCC system is canceled, and the MRCC set indication (green) switches to the MRCC standby indication (white) at the same time.

- The CANCEL switch is pressed.
- The brake pedal is depressed.
- The shift lever is in the reverse (R) position.

Under the following conditions, the MRCC cancel indication is displayed in the multi-information display and a single beep sound is heard.

- The DSC has operated.

- The Smart Brake Support (SBS) has operated.
- When traveling on a downslope for a long period of time.
- There is a problem with the system.
- The vehicle speed decreases to less than 25 km/h (16 mph).
- The shift lever is shifted to neutral (N) for a certain period of time.
- The clutch is depressed for a certain period of time.
- The engine stalls.
- The front radar sensor cannot detect target objects (during rain, fog, snow or other inclement weather conditions, or when the radiator grille is dirty).
- The parking brake is applied.
- Any of the doors is opened.
- The driver's seat belt is unfastened.
- The operation frequency of the braking by the MRCC control is high.

Resuming control

If the MRCC system is canceled, you can resume control at the previously set speed by pressing the RES switch and after all of the operation conditions have been met.

NOTE

If the set speed is not indicated in the display, the control does not resume even if the RES switch is pressed.

Turning off the system

When the MRCC switch is pressed while the MRCC is operating, the MRCC turns off.

▼ Shift-up/Shift-down Request Display

The shift-up or shift-down request display might be displayed while the MRCC is operating. When this occurs, shift gears because the gear position is not appropriate.

Request	Indication on display
Shift up	Shift Up to a Higher Gear
Shift down	Shift Down to a Lower Gear

NOTE

- If the gears are not shifted up even though the shift-up request indication is displayed, load will be applied to the engine and the MRCC might be automatically canceled or engine damage could occur.
- If the gears are not shifted down even though the shift-down request indication is displayed, the MRCC might be automatically canceled or engine stalling could occur.

Mazda Radar Cruise Control with Stop & Go function (MRCC with Stop & Go function) (Automatic Transmission)*

▼ Mazda Radar Cruise Control with Stop & Go function (MRCC with Stop & Go function)

The MRCC with Stop & Go function system is designed to maintain headway control*1 with a vehicle ahead according to your vehicle's speed using a front radar sensor to detect the distance to the vehicle ahead and a preset vehicle speed without you having to use the accelerator or brake pedals.

*1 Headway Control: Control of the distance between your vehicle and the vehicle ahead detected by the Mazda Radar Cruise Control (MRCC) system.

Additionally, if your vehicle starts closing in on the vehicle ahead such as if the vehicle ahead brakes suddenly, a warning sound and a warning indication in the display are activated simultaneously to alert you to maintain a sufficient distance between the vehicles.

If the vehicle ahead stops while you are following behind it, your vehicle will stop and be held stopped automatically (stop hold control), and headway control will resume when you resume driving the vehicle such as by pressing the RES switch.

Also refer to the following before using the MRCC with Stop & Go function.

- AUTOHOLD (page 4-71)
- Forward Sensing Camera (FSC) (page 4-203)
- Front radar sensor (page 4-207)

 WARNING

Do not rely completely on the MRCC with Stop & Go function:

The MRCC with Stop & Go function system has detection limitations depending on the type of vehicle ahead and its conditions, the weather conditions, and the road conditions. Additionally, the system may be unable to decelerate sufficiently to avoid hitting the vehicle ahead if the vehicle ahead applies the brakes suddenly or another vehicle cuts into the driving lane in front of you, which could result in an accident.

Always drive carefully and verify the surrounding conditions and depress the brake pedal or accelerator pedal while keeping a safe distance from vehicles ahead or on-coming vehicles.

Do not use the MRCC with Stop & Go function system in the following locations. Using the MRCC with Stop & Go function system at the following locations may result in an unexpected accident:

- General roads other than highways (Driving under these conditions using the MRCC with Stop & Go function system is not possible.)

- Roads with sharp curves and where vehicle traffic is heavy with insufficient space between vehicles, or roads where frequent and repetitive acceleration and deceleration occur (Driving under these conditions using the MRCC with Stop & Go function is not possible.)
- When entering and exiting interchanges, service areas, and parking areas of highways (If you exit a highway while headway control is in use, the vehicle ahead will no longer be tracked and your vehicle may accelerate to the set speed.)
- Slippery roads such as ice or snow-bound roads (Tires could spin causing you to lose vehicle control, or the stop hold control may not operate.)
- Long, descending slopes (to maintain distance between vehicles, the system automatically and continuously applies the brakes which could result in the loss of brake power.)
- Slopes with a steep gradient (The vehicle ahead may not be detected correctly, your vehicle may slide while stopped by the stop hold control, and it may accelerate suddenly after it starts moving.)
- Two-wheeled vehicles such as motorcycles or bicycles are ahead.

For safety purposes, switch the MRCC with Stop & Go function system off when it is not being used.

Leaving the MRCC with Stop & Go function system turned on when it is not in use is dangerous as it could operate unexpectedly, resulting in an accident.

Do not get out of the vehicle while the stop hold control is operating:

Getting out of the vehicle while the stop hold control is operating is dangerous as the vehicle may move unexpectedly and result in an accident. Before getting out of the vehicle, switch the MRCC with Stop & Go function system off, shift the selector lever to the P position, and apply the parking brake.



- If your vehicle is towed or you are towing something, switch the MRCC with Stop & Go function system off to prevent an unexpected operation.
- Turn the system off when the vehicle is running on a chassis roller.

NOTE

- The MRCC with Stop & Go function system does not detect the following as physical objects.
 - Vehicles approaching in the opposite direction
 - Pedestrians
 - Stationary objects (stopped vehicles, obstructions)
- If a vehicle ahead is traveling at an extremely low speed, the system may not detect it correctly.
- If there is a structure on the road or an object (such as a monorail) at a low height off the ground in front of the vehicle, the system may operate. Therefore, do not use the MRCC with Stop & Go function.
- Do not use the MRCC with Stop & Go function system under conditions in which close proximity warnings are frequently activated.

- During headway control travel, the system accelerates and decelerates your vehicle in conjunction with the speed of the vehicle ahead. However, if it is necessary to accelerate for a lane change or if the vehicle ahead brakes suddenly causing you to close in on the vehicle rapidly, accelerate using the accelerator pedal or decelerate using the brake pedal depending on the conditions.
- While the MRCC with Stop & Go function system is in use, it does not cancel even if the selector lever is operated and any intended engine braking does not occur. If deceleration is required, lower the set speed or depress the brake pedal.
- While braking by the MRCC with Stop & Go function control is operating, you might hear an operation sound, however, this does not indicate a problem.
- The brake lights turn on while braking by the MRCC with Stop & Go function control is operating, however, they may not turn on while the vehicle is on a down slope at the set vehicle speed or traveling at a constant speed and following a vehicle ahead.
- Stop the headway control function to switch the system to the cruise control function.
Refer to the Settings section in the Mazda Connect Owner's Manual.

▼ Mazda Radar Cruise Control with Stop & Go function (MRCC with Stop & Go function) Display Indication

The MRCC with Stop & Go function setting status and operation conditions are indicated on the multi-information display and the active driving display.

Multi-information Display (Basic display)

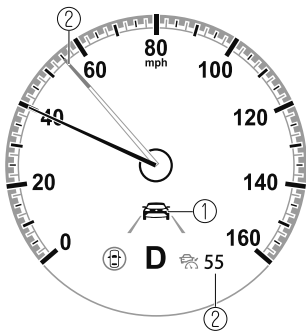

1. Vehicle ahead display
2. MRCC with Stop & Go function set vehicle speed

Multi-information Display (i-ACTIVSENSE display)

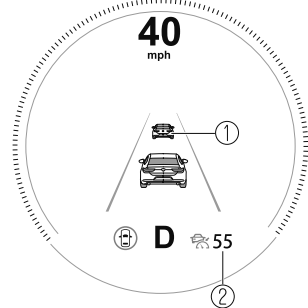

1. Vehicle ahead display
2. MRCC with Stop & Go function set vehicle speed

Active driving display

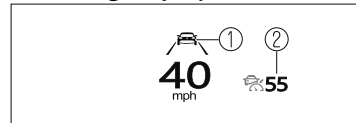

1. Vehicle ahead display
2. MRCC with Stop & Go function set vehicle speed

If there is a problem with the MRCC with Stop & Go function system, a message is displayed on the multi-information display. Check the center display to verify the problem and then have your vehicle inspected by an Authorized Mazda Dealer. Refer to If a Warning Light Turns On or Flashes on page 7-27.

▼ Close Proximity Warning

If your vehicle rapidly closes in on the vehicle ahead because the vehicle ahead applies the brakes suddenly while you are traveling in headway control, the warning sound activates and the brake warning is indicated in the display. Always verify the safety of the surrounding area and depress the brake pedal while keeping a safe distance from the vehicle ahead. Additionally, keep a safe distance from the vehicles behind you.

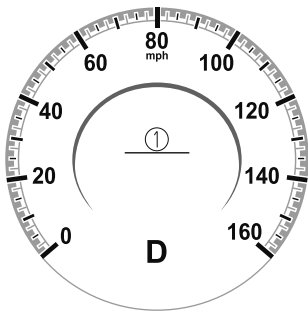

1. “Depress Brake Pedal” message is displayed

NOTE

In the following cases, the warnings and brakes may not operate even if your vehicle starts closing in on the vehicle ahead.

- You are driving your vehicle at the same speed as the vehicle ahead.
- Directly after the MRCC with Stop & Go function system has been set.
- Directly after the accelerator pedal is released.
- Another vehicle cuts into the driving lane in front of you.

▼ Setting the System

The MRCC with Stop & Go function system operates when all of the following conditions are met.

- Vehicle speed is 0 km/h (0 mph) to 145 km/h (90 mph)
- The MRCC with Stop & Go function is turned on.
- The brake pedal is not depressed.
- The parking brake is released (Electric Parking Brake (EPB) indicator light is turned off).
- There is no problem with the DSC.
- All the doors are closed.
- The driver's seat belt is fastened.
- The selector lever is in the drive (D) position or manual (M) position (manual mode).

NOTE

- In the following cases, the MRCC with Stop & Go function system is canceled when the vehicle is traveling at 30 km/h (20 mph) or less and "Mazda Radar Cruise Control Disabled Under 30 km/h" is displayed in the multi-information display.
 - The Forward Sensing Camera (FSC) cannot detect target objects (There is a problem with the Forward Sensing Camera (FSC) or windshield is dirty).
 - There is a problem with the stop hold control function.
 - There is a problem with the Electric Parking Brake (EPB).
- It may not be possible to set the MRCC with Stop & Go function system directly after starting the engine, while the DSC operation is being checked.

Turning on the system

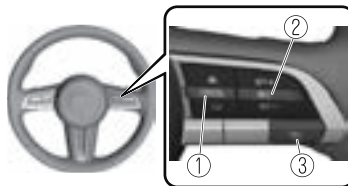

1. CANCEL switch
2. RES switch
3. MRCC switch

When the MRCC switch is pressed once, the MRCC with Stop & Go function system turns on, and the MRCC with Stop & Go function standby indication (white) turns on and the vehicle speed and the distance between the vehicles while in headway control can be set.



In addition, the MRCC with Stop & Go function system display indication is displayed on the multi-information display and the active driving display at the same time.





NOTE

If the ignition is switched off while the MRCC with Stop & Go function system is operating, the system will be operable when the ignition is switched ON the next time.

How to set the speed

Adjust the vehicle speed to the desired setting using the accelerator pedal and press the RES switch up (SET+) or down (SET-) to start headway control. The set speed is indicated on the display. At the same time, the MRCC standby indication (white) changes to the MRCC set indication (green).



Travel status	Indication on multi-information display	Indication on active driving display
During travel at constant speed		
During travel under headway control		



NOTE



- If a vehicle ahead is detected while traveling at a constant speed, the vehicle-ahead indication is displayed and headway control is performed. Additionally, when a vehicle ahead is no longer detected, the vehicle-ahead indication turns off and the system switches back to travel at constant speed.
- The lowest possible speed which can be set on the MRCC with Stop & Go function system is 30 km/h (19 mph).
- Headway control is not possible if the vehicle ahead is driving faster than your vehicle's set speed. Adjust the system to the desired vehicle speed using the accelerator pedal.

How to set the distance-between-vehicles during headway control

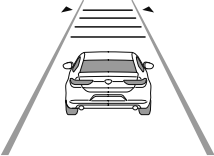
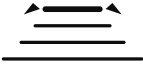
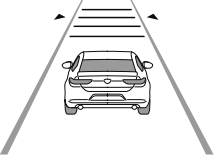
The distance-between-vehicles can be set to 4 levels; Long, medium, short, and extremely short distance.

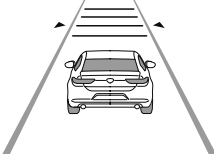
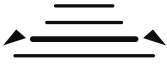
The distance-between-vehicles is set to a shorter distance by pressing the CANCEL switch down. The distance-between-vehicles is set to a longer distance by pressing the CANCEL switch up.

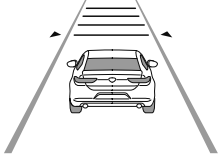
Distance-between-vehicles guideline (at 80 km/h (50 mph) vehicle speed)	Indication on multi-information display	Indication on active driving display ¹
Long (about 50 m (164 ft))		
Medium (about 40 m (131 ft))		
Short (about 30 m (98 ft))		

Distance-between-vehicles guideline (at 80 km/h (50 mph) vehicle speed)	Indication on multi-information display	Indication on active driving display ^{*1}
Extremely short (about 25 m (82 ft))		

^{*1} Displays a pop-up image in the active driving display only when the driver operates the switch.

NOTE

- The distance-between-vehicles differs depending on the vehicle speed, and the slower the vehicle speed, the shorter the distance.
- When the ignition is switched to ACC or OFF and then the engine is started again, the system automatically sets the distance-between-vehicles to the previous setting.

Changing the Set Vehicle Speed

(To accelerate/decelerate using the RES switch)

When the RES switch is pressed up (SET+), the vehicle accelerates and when the RES switch is pressed down (SET-), it decelerates.

- Press and release immediately: 1 km/h (1 mph)
- Press and hold: 10 km/h (5 mph)

(To increase speed using accelerator pedal)

Depress the accelerator pedal and press the RES switch up (SET+) or down (SET-) at the desired speed. If the switch is not operated, the system returns to the set speed after you release your foot from the accelerator pedal.

NOTE

- The warnings and brake control do not operate while the accelerator pedal is depressed.
- The setting speed can be changed by operating the RES switch up (SET+) or down (SET-) during stop hold control.

Canceling the system

When the following operations are performed, the MRCC with Stop & Go function system is canceled, and the MRCC with Stop & Go function set indication (green) switches to the MRCC with Stop & Go function standby indication (white) at the same time.

- The CANCEL switch is pressed.
- The brake pedal is depressed.
- The selector lever is in the P (Park), N (Neutral), or R (Reverse) position.

Under the following conditions, the MRCC with Stop & Go function cancel indication is displayed in the multi-information display and a single beep sound is heard.

- The DSC has operated.
- The Smart Brake Support (SBS) has operated.
- When traveling on a downslope for a long period of time.
- There is a problem with the system.
- The parking brake is automatically applied during stop hold control.
- The front radar sensor cannot detect target objects (during rain, fog, snow or other inclement weather conditions, or when the radiator grille is dirty).
- The parking brake is applied.
- Any of the doors is opened.
- The driver's seat belt is unfastened.
- The operation frequency of the braking by the MRCC with Stop & Go function control is high.

Resuming control

If the MRCC with Stop & Go function system is canceled, you can resume control at the previously set speed by pressing the RES switch and after all of the operation conditions have been met.

NOTE

If the set speed is not indicated in the display, the control does not resume even if the RES switch is pressed.

Turning off the system

When the MRCC switch is pressed while the MRCC is operating, the MRCC turns off.

▼ Stop Hold Control

While in headway control using the MRCC with Stop & Go function system, your vehicle will stop when a vehicle ahead stops. When the vehicle is stopped and the stop hold control operates, the MRCC with Stop & Go function indicator light turns on.

HOLD

NOTE

- If the MRCC with Stop & Go function system is canceled during stop hold control, the vehicle is held in its stopped position.
- The parking brake is automatically applied and the vehicle is held in its stopped position when 10 minutes have elapsed since the stop hold control operated. At this time, the MRCC with Stop & Go function system is canceled.
- The brake lights turn on during stop hold control.

To resume driving

After the vehicle ahead starts moving while your vehicle is stopped under stop hold control, press the RES switch or depress the accelerator pedal to cancel the stop hold control and resume driving.

NOTE

- When you resume driving by pressing the RES switch, your vehicle does not start moving until the distance between your vehicle and the vehicle ahead lengthens to the specified distance or farther.
- If the MRCC with Stop & Go function is temporarily canceled during stop hold control, you cannot resume driving by pressing the RES switch when there are no vehicles in front of your vehicle. Depress the accelerator pedal and resume driving the vehicle.
- If the vehicle ahead starts moving within 3 seconds after your vehicle is stopped by the stop hold control, headway control will resume even if you do not resume driving your vehicle, such as by depressing the accelerator pedal.

Resume driving information

If you do not resume driving within a few seconds after the vehicle ahead starts moving, the multi-information display vehicle-ahead indication flashes to urge the driver to resume driving. If you do not resume driving after the indicator light flashes, a sound is activated to urge you to resume driving.

Traffic Jam Assist (TJA)*

▼ Traffic Jam Assist (TJA)

The TJA is a system which consists of a headway control function and a steering assist function for reducing driver fatigue during traffic jams when driving on expressways or highways. This system performs headway control to maintain a constant distance between your vehicle and a vehicle ahead at a preset vehicle speed without you having to use the accelerator or brake pedal. Even further, with the steering assist function, when vehicle lane lines are detected, the function assists the driver in keeping the vehicle within the lane lines. If lane lines are not detected, the function provides the driver driving assistance in keeping the vehicle along the motion path with the vehicle ahead.

 WARNING

Do not rely completely on TJA:

- The TJA is not an automated driving system. In addition, the functions have limitations. Do not rely completely on the system and always stay on course using the steering wheel.
- Set a vehicle speed within the speed limit according to the road conditions and the weather conditions.

➤ The TJA may not be able to detect a vehicle ahead depending on the type of vehicle ahead and its conditions, the weather conditions, and the road conditions. Additionally, the system might be unable to decelerate sufficiently if a vehicle ahead applies the brakes suddenly, another vehicle cuts into the driving lane, or the difference in vehicle speed between your vehicle and the vehicle ahead is larger, which could result in an accident. Check the surrounding conditions and always drive carefully while keeping a safe distance from vehicles ahead and on-coming vehicles.

For the purposes of safety, switch the TJA off when it is not being used.

Leaving the TJA turned on when it is not in use is dangerous as it could operate unexpectedly, resulting in an accident.

Do not use the TJA under the following conditions. Otherwise, it may result in an accident.

➤ General roads other than expressways or highways (Driving under these conditions using the TJA is not possible.)

➤ Roads with sharp curves and where vehicle traffic is heavy with insufficient space between vehicles, or roads where frequent and repetitive acceleration and deceleration occur (Driving under these conditions using the TJA is not possible).

- When entering and exiting interchanges, service areas, and parking areas of expressways (If you exit an expressway while headway control is in use, the vehicle ahead will no longer be tracked and your vehicle may accelerate to the set speed).
- Slippery roads such as icy or snow-covered roads (Tires could spin causing you to lose vehicle control, or the stop hold control may not operate.)
- Long, descending slopes (to maintain distance between vehicles, the system automatically and continuously applies the brakes which could result in the loss of brake power.)
- Two-wheeled vehicles such as motorcycles or bicycles are ahead.
- **(Automatic transmission vehicle)** Slopes with a steep gradient (The vehicle ahead may not be detected correctly, your vehicle may slip while stopped by the stop hold control, or it may accelerate suddenly after it starts moving.)
- Driving under bad weather conditions (rain, fog, and snow).
- The vehicle is driven on slippery roads such as icy or snow-covered roads and unpaved roads (Tires could spin causing you to lose vehicle control, or the stop hold control may not operate.)
- Tires of a different specified size are used, such as a temporary spare tire.
- Tires with insufficient tread are used.
- The tire pressures are not adjusted to the specified pressure.
- The vehicle is being used to tow a camper or boat trailer.
- Tire chains are used.

- The vehicle is driven on roads with lane lines other than white (yellow) lines, such as an expressway.

Do not get out of the vehicle while the stop hold control is operating.

(Automatic transmission vehicle)

Getting out of the vehicle while the stop hold control is operating is dangerous as the vehicle may move unexpectedly and result in an accident. Before getting out of the vehicle, switch the TJA off, apply the parking brake, and then shift the selector lever to the P position.



Turn the system off when the vehicle is running on a chassis roller. Heed the following cautions so that the TJA can operate normally.

- Turn the system off when the vehicle is running on a chassis roller.
- Do not modify the vehicle's suspensions.
- Always use wheels of the specified size for the front and rear wheels. Consult an Authorized Mazda Dealer for tire replacement.

NOTE

- The headway control does not detect the following as physical objects.
 - Vehicles approaching in the opposite direction
 - Pedestrians
 - Stationary objects (stopped vehicles, obstructions)

- If a vehicle ahead is traveling at an extremely low speed, the system may not detect it correctly.
- If there is a structure on the road or an object (such as a monorail) at a low height off the ground in front of the vehicle, the system may operate. Therefore, do not use the TJA.
- Do not use the TJA under conditions in which close proximity warnings are frequently activated.
- If it is necessary to accelerate for a lane change or the vehicle ahead brakes suddenly causing you to close in on the vehicle rapidly, accelerate using the accelerator pedal or decelerate using the brake pedal depending on the conditions.
- While the TJA is in use, any intended engine braking does not occur even if you shift the shift lever (manual transmission) or the selector lever (automatic transmission). If deceleration is required, lower the vehicle speed setting or depress the brake pedal.
- While braking by the TJA control is operating, you might hear an operation sound, however, this does not indicate a problem.
- The brake lights turn on while braking by the TJA control is operating, however, they may not turn on while the vehicle is on a down slope at the set vehicle speed or traveling at a constant speed and following a vehicle ahead.
- Under the following conditions, the TJA may not be able to detect white (yellow) lines or vehicles ahead correctly and the TJA may not operate normally.
 - The forward sensing camera (FSC) cannot recognize the area in front of the vehicle due to soiling or fog.

- The white (yellow) lane lines are less visible because of dirt or paint flaking.
- White (yellow) lane lines or vehicles ahead are less visible because of bad weather (rain, fog, or snow).
- The vehicle is driven on a temporary lane or section with a closed lane resulting from construction where there might be multiple white (yellow) lane lines, or they are interrupted.
- The camera picks up an obscure line, such as a temporary line being used for construction, or because of shade, unmelted snow, or grooves filled with water.
- The road surface is wet and shiny after rain, or there are puddles on the road.
- Heavy luggage is loaded in the trunk/luggage compartment or on the rear seat causing the vehicle to tilt.
- A vehicle in front of your vehicle is running near a white (yellow) lane line making it less visible.
- The windshield is dirty or foggy.
- The vehicle is driven through an intersection, a junction, or a fork in the road.
- While white (yellow) lane lines cannot be detected due to road or weather conditions.
- The surrounding brightness suddenly changes such as when entering or exiting a tunnel.
- The illumination of the headlights is weakened because of dirt or the optical axis is deviated at night.
- Back-light is reflected off the road surface or the road surface is wet and shiny after rain.

- The shade of a guardrail parallel to a white (yellow) lane line is cast on the road.
- The width of a lane is excessively narrow or wide.
- The road is excessively uneven.
- The vehicle is shaken after hitting a road bump.
- There are various road markings or division lines (lane markings) of various shapes near an intersection.
- The area in front of the camera is soiled or an object that obstructs the field of view is installed.
- Exhaust gas from the vehicle in front, sand, snow, and water vapor rising from manholes and grating, and water splashed into the air.
- The surroundings are dark such as during the early evening or early morning.
- A vehicle ahead with a certain taillight shape.
- A vehicle ahead veers off course from your vehicle's line of travel.
- A vehicle ahead is driving erratically.
- The vehicle is driven on roads with tight curves.

Headway control function

If a vehicle ahead is detected while traveling at a constant speed, the vehicle-ahead indication is displayed and headway control is performed.

Steering assist function

When lane lines are detected, the function assists the driver in keeping the vehicle within the lane lines. If lane lines are not detected, the function provides the driver driving assistance in keeping the vehicle along the motion path with the vehicle ahead.

NOTE

Steering assist limit warning

If the steering assist function cannot keep the vehicle within the lane lines while the steering assist function is operating, a warning sound is activated and a warning is displayed on the multi-information display to urge the driver to operate the steering wheel.

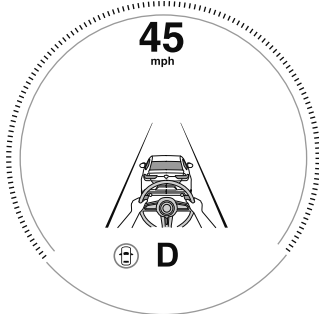

▼ Traffic Jam Assist (TJA) Display Indication

The TJA setting status and operation conditions are indicated on the multi-information display or the active driving display.

Multi-information display (Basic display)

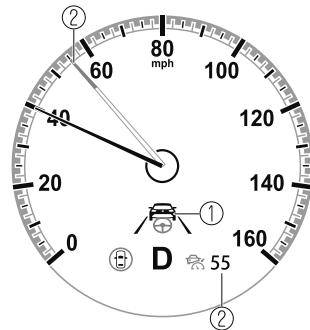

1. Vehicle ahead display
2. TJA set vehicle speed

**Multi-information display
(i-ACTIVSENSE display)**

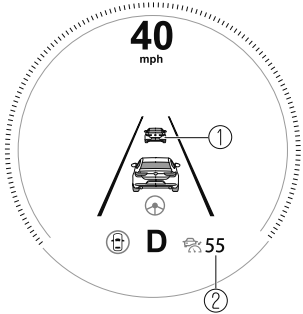

1. Vehicle ahead display
2. TJA set vehicle speed

Active driving display

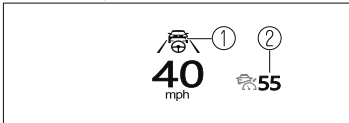

1. Vehicle ahead display
2. TJA set vehicle speed

Steering assist function display

When the steering assist function operates, the steering assist operation display on the display changes from white to green.



NOTE

You can view the multi-information display to check whether the steering assist is performing controls in conjunction with the traffic lane lines or a vehicle ahead.

Inactive



Active (vehicle ahead)



Active (lane line)



If there is a problem with the TJA, a message is displayed on the multi-information display. Check the details of the problem on the center display and then have your vehicle inspected by an Authorized Mazda Dealer.
Refer to If a Warning Light Turns On or Flashes on page 7-27.

▼ Close Proximity Warning

If your vehicle rapidly closes in on the vehicle ahead while you are traveling under headway control, the warning sound is activated and the brake warning is indicated on the display. Keep a safe distance between your vehicle and a vehicle ahead.

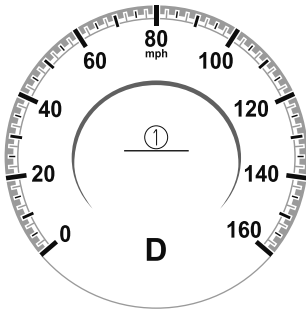

1. "Depress Brake Pedal" message is displayed

NOTE

In the following cases, the warnings and brakes may not operate even if your vehicle starts closing in on the vehicle ahead.

- You are driving your vehicle at the same speed as the vehicle ahead.
- Directly after the TJA operates.
- Directly after the accelerator pedal is released.
- Another vehicle cuts into the driving lane in front of you.

▼ Setting the System

Operation conditions

Headway control function

The TJA operates when all of the following conditions are met.

- **(Automatic transmission vehicle)**
 - The vehicle speed is about 0 km/h (0 mph) to 145 km/h (90 mph).
 - The selector lever is in the D or M position (manual mode).
- **(Manual transmission vehicle)**
 - The vehicle speed is about 30 km/h (19 mph) to 145 km/h (90 mph).
 - The shift lever is in a position other than the R or N position.
 - The clutch pedal is not depressed.
- The TJA is operating.
- The headway control function of the Mazda Radar Cruise Control (MRCC) or Mazda Radar Cruise Control with Stop & Go function (MRCC with Stop & Go function) is set to operable (if it was set to inoperable, set it to operable using the personalization function).
- The brake pedal is not depressed.
- The parking brake is released (Electric Parking Brake (EPB) indicator light is turned off).
- There is no problem with the DSC.
- All the doors are closed.
- The driver's seat belt is fastened.

NOTE

(Automatic transmission vehicle)

- Under the following conditions, the TJA cannot be used when the vehicle speed is 30 km/h (19 mph) or slower.
 - There is a problem with the stop hold control function.
 - There is a problem with the Electric Parking Brake (EPB).
- The TJA may not launch directly after the engine starts.

Steering assist function

The steering assist function operates when all of the following conditions are met.

- Your vehicle is moving and less than about 56 km/h (35 mph).
- White (yellow) lane lines on both sides are detected and you are driving near the center of the lane, or your vehicle detects a vehicle ahead.
- The steering wheel is not turned sharply.
- The turn signal lever is not operated.
- The headway control function is operating.
- **(Manual transmission vehicle)**
The vehicle speed is about 30 km/h (19 mph) or faster.

NOTE

The steering assist function operates so that the vehicle remains near the center of the driving lane, however, depending on conditions such as the road curvature, road slope and undulations, and vehicle speed, the function might not be able to keep the vehicle near the center of the driving lane.

Setting method

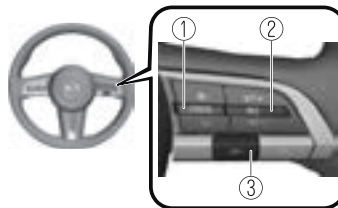

1. CANCEL switch
2. RES switch
3. TJA switch

1. Press the TJA switch.
The TJA standby indication (white) turns on. In addition, the TJA display indication is displayed on the multi-information display at the same time.



- Adjust the vehicle speed to the desired setting using the accelerator pedal and press the RES switch up (SET+) or down (SET-) to start headway control. The set speed is indicated on the display. At the same time, the TJA standby indication (white) changes to the TJA set indication (green).



- The headway control is operable when all of the conditions for it to operate are met, or the steering assist function is operable when all of the conditions for it to operate are met.

NOTE

- If a vehicle ahead is detected while traveling at a constant speed, the vehicle-ahead indication is displayed and headway control is performed. Additionally, when a vehicle ahead is no longer detected, the vehicle-ahead indication turns off and the system switches back to travel at constant speed.
- Headway control is not possible if the vehicle ahead is driving faster than your vehicle's set speed. Adjust the system to the desired vehicle speed using the accelerator pedal.
- When the ignition is switched OFF, the system status before it was turned off is maintained. For example, if the ignition is switched OFF with the TJA operable, the TJA remains operational the next time the ignition is switched ON.
- When the TJA switch is pressed while the Mazda Radar Cruise Control (MRCC) or the Mazda Radar Cruise Control with Stop & Go function (MRCC with Stop & Go function) system is operating, the TJA operates. In addition, when the MRCC switch is pressed while the TJA is operating, the Mazda Radar Cruise Control (MRCC) or the Mazda Radar Cruise Control with Stop & Go function (MRCC with Stop & Go function) system operates.

Changing the set vehicle speed**(To accelerate/decelerate using the RES switch)**

When the RES switch is pressed up (SET+), the vehicle accelerates and when the RES switch is pressed down (SET-), it decelerates.

- Press and release immediately: 1 km/h (1 mph)
- Press and hold: 10 km/h (5 mph)

(To increase speed using accelerator pedal)

Depress the accelerator pedal and press the RES switch up (SET+) or down (SET-) at the desired speed. If the switch is not operated, the system returns to the set speed after you release your foot from the accelerator pedal.

NOTE

- The warnings and brake control do not operate while depressing the accelerator pedal.
- The lowest possible speed which can be set on the TJA is 30 km/h (19 mph).
- **(Automatic transmission vehicle)**
The vehicle speed setting can be changed by operating the RES switch during stop hold control.

Changing the distance between vehicles during headway control

The distance-between-vehicles can be set to 4 levels; Long, medium, short, and extremely short distance.

The distance-between-vehicles is set to a shorter distance by pressing the CANCEL switch down. The distance-between-vehicles is set to a longer distance by pressing the CANCEL switch up.

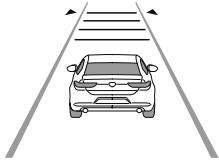
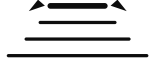
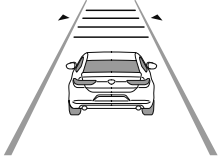
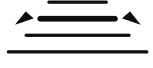
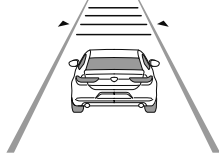
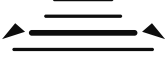
Distance-between-vehicles guideline (at 80 km/h (50 mph) vehicle speed)	Indication on display	
	Indication on multi-information display	Indication on active driving display ^{*1}
Long (about 50 m (164 ft))		
Medium (about 40 m (131 ft))		
Short (about 30 m (98 ft))		

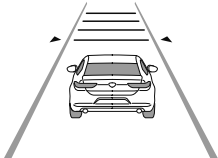
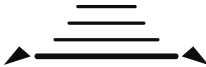
Distance-between-vehicles guideline (at 80 km/h (50 mph) vehicle speed)	Indication on display	
	Indication on multi-information display	Indication on active driving display ^{*1}
Extremely short (about 25 m (82 ft))		

^{*1} Displays a pop-up image when the CANCEL switch is operated.

NOTE

- The distance-between-vehicles differs depending on the vehicle speed, and the slower the vehicle speed, the shorter the distance.
- When the ignition is switched to ACC or OFF, the set distance-between-vehicles is taken over automatically even when the engine is started again.

The function is temporarily canceled.

Headway control function

When the following operations are performed, the headway control function is temporarily canceled and the TJA set indication (green) changes to the TJA standby indication (white) at the same time.

- The CANCEL switch is pressed one time.
- The brake pedal is depressed.
- **(Automatic transmission vehicle)**
The selector lever is in the P, N, or R position.
- **(Manual transmission vehicle)**
The shift lever is in the R position.

In the following cases, the TJA cancel indication is displayed and a sound is activated one time.

- The DSC has operated.
- The Smart Brake Support (SBS) has operated.
- The vehicle is driven on a downslope for a long time.
- There is a problem with the system.
- The front radar sensor cannot detect target objects (during rain, fog, snow or other inclement weather conditions, or when the radiator grille is dirty).
- The parking brake is applied.
- Any of the doors is opened.
- The driver's seat belt is unfastened.
- The operation frequency of the braking by the TJA control is high.
- **(Automatic transmission vehicle)**
The parking brake is automatically applied during stop hold control.
- **(Manual transmission vehicle)**
 - The vehicle speed decreases below 25 km/h (15 mph).
 - The shift lever is in the neutral position for a certain period of time.
 - The clutch pedal is depressed for a certain period of time.
 - The engine has stalled.

Steering assist function

If any of the following conditions occurs, the steering assist function is temporarily canceled.

- The headway control function is canceled.
- White (yellow) lane lines cannot be detected or a vehicle ahead cannot be recognized.
- Your vehicle speed is more than about 64 km/h (40 mph).
- The accelerator pedal is operated.
- The turn signal lever is operated.
- The vehicle is being driven on a sharp curve.
- The width of a lane is excessively narrow or wide.
- The vehicle crosses a lane line.
- The driver takes his/her hands off the steering wheel.
- The steering wheel is operated abruptly.
- There is a problem with the system.
- The temperature in the Forward Sensing Camera (FSC) is too high or too low.
- The windshield around the Forward Sensing Camera (FSC) is foggy.
- The windshield around the Forward Sensing Camera (FSC) is blocked by an obstruction, causing poor forward visibility.

NOTE

If you take your hands off the steering wheel (not holding the steering wheel), the warning sound is activated and an alert is indicated on the multi-information display and the active driving display.

Multi-information display

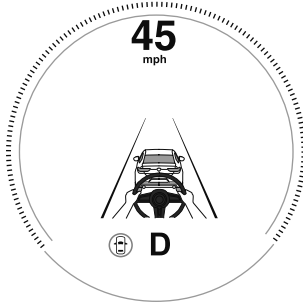

Active driving display



If the steering wheel is held lightly, or depending on the road conditions, the system determines that you have released the steering wheel (not holding the steering wheel) even if you are holding it, and an alert is indicated on the multi-information display and the active driving display.

To resume operation

If the TJA is temporarily canceled, it will resume operation at the previously set speed by pressing the RES switch after all of the operation conditions have been met.

NOTE

- If the set speed is not indicated on the display, the system does not operate even if the RES switch is pressed.
- After the operation, the steering assist operation may not operate for a period of 5 seconds at the most until the lane lines are detected or a vehicle ahead is recognized.

Turning off

When the TJA switch is pressed while the TJA is operating, the TJA turns off.

▼ Shift-up/Shift-down Request Display (Manual Transmission)

The shift-up or shift-down request display might be displayed while the TJA is operating. When this occurs, shift gears because the gear position is not appropriate.

Request	Indication on display
Shift up	Shift Up to a Higher Gear
Shift down	Shift Down to a Lower Gear

NOTE

- If the gears are not shifted up even though the shift-up request indication is displayed, load will be applied to the engine and the TJA might be automatically canceled or engine damage could occur.
- If the gears are not shifted down even though the shift-down request indication is displayed, the TJA might be automatically canceled or engine stalling could occur.

▼ Stop Hold Control (Automatic Transmission)

While in headway control using the TJA, your vehicle will stop when a vehicle ahead stops. When the vehicle is stopped and the stop hold control operates, the TJA indicator light turns on.

HOLD

NOTE

- Even if the TJA is temporarily canceled during stop hold control, the vehicle is held in its stopped position.
- The parking brake is automatically applied and the vehicle is held in its stopped position when 10 minutes or longer have passed since the stop hold control operated. When this occurs, the TJA is temporarily canceled.
- The brake lights turn on during stop hold control.

To resume driving

After the vehicle ahead starts moving while your vehicle is stopped under stop hold control, press the RES switch or depress the accelerator pedal to cancel the stop hold control and start driving.

NOTE

- When you resume driving by pressing the RES switch, your vehicle does not start moving until the distance between your vehicle and the vehicle ahead lengthens to the specified distance or farther.
- If the TJA is temporarily canceled, depress the accelerator pedal and start driving the vehicle. If the TJA is temporarily canceled, you cannot resume driving by pressing the RES switch when there are no vehicles in front of your vehicle.
- If the vehicle ahead starts moving within 3 seconds after your vehicle is stopped by the stop hold control, headway control will continue even if you do not resume driving your vehicle, such as by depressing the accelerator pedal.

Vehicle departure information

If you do not resume driving within a few seconds after the vehicle ahead starts moving during stop hold control, the multi-information display vehicle-ahead indication flashes to urge the driver to resume driving. If you do not resume driving after the indicator light flashes, a sound is activated to urge you to resume driving.

Lane-keep Assist System (LAS)*

▼ Lane-keep Assist System (LAS)

The LAS provides steering assistance to help the driver stay within the vehicle lane if the vehicle might be deviating. The forward sensing camera (FSC) of the vehicle lane in which the vehicle is traveling and if the system determines that the vehicle may deviate from its lane, it operates the electric power steering to assist the driver's steering operation. The system also alerts the driver by displaying an alert on the multi-information display. Use the system when you drive the vehicle on roads with white (yellow) lines such as expressways and highways.

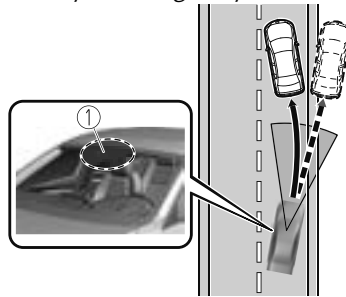

1. Forward sensing camera (FSC)

⚠ WARNING

Do not rely completely on the LAS:

- The LAS is not an automated driving system. In addition, the system is not designed to compensate for a driver's lack of caution, and over-reliance on the system could lead to an accident.

- The functions of the LAS have limitations. Always stay on course using the steering wheel and drive with care.
- Do not use the LAS under the following circumstances, otherwise it may result in an accident.
 - The vehicle is driven on slippery roads such as icy or snow-covered roads, and unpaved roads.
 - Tires of a different specified size are used, such as a temporary spare tire.
 - Tires with insufficient tread are used.
 - The tire pressures are not adjusted to the specified pressure.
 - The vehicle is being used to tow a camper or boat trailer.
 - Tire chains are used.
 - The vehicle is driven on roads with lane lines other than white (yellow) lines, such as an expressway.

⚠ CAUTION

Heed the following cautions so that the LAS can operate normally.

- Do not modify the vehicle's suspensions.
- Always use tires of the specified type and size for the front and rear wheels. Consult an Authorized Mazda Dealer for tire replacement.

NOTE

The system may not operate normally under the following conditions.

- The white (yellow) lane lines are less visible because of dirt or paint flaking.
- White (yellow) lane lines are less visible because of bad weather (rain, fog, or snow).

- The vehicle is driven on a temporary lane or section with a closed lane resulting from construction where there might be multiple white (yellow) lane lines, or they are interrupted.
- The camera picks up an obscure line, such as a temporary line being used for construction, or because of shade, unmelted snow, or grooves filled with water.
- The surrounding brightness suddenly changes such as when entering or exiting a tunnel.
- Back-light is reflected off the road surface.
- The road surface is wet and shiny after rain, or there are puddles on the road.
- The width of a lane is excessively narrow.
- The vehicle is driven on roads with tight curves.
- Heavy luggage is loaded in the trunk/luggage compartment or on the rear seat causing the vehicle to tilt.
- The vehicle is driven through a fork in the road or a junction.
- The shade of a guardrail parallel to a white (yellow) lane line is cast on the road.
- The illumination of the headlights is weakened because of dirt or the optical axis is deviated at night.
- The road is excessively uneven.
- The vehicle is shaken after hitting a road bump.
- A vehicle in front of your vehicle is running near a white (yellow) lane line making it less visible.
- The windshield is dirty or foggy.
- Strong light is directed from the front of the vehicle (such as sunlight, or headlights (high-beam) of on-coming vehicles).

▼ System Operation

When the ignition is switched ON, the i-ACTIVSENSE status symbol (warning/risk avoidance support system) (white) turns on and the system goes on standby.



NOTE

If the i-ACTIVSENSE status symbol (warning/risk avoidance support system) (white) does not turn on, the system is canceled using the i-ACTIVSENSE OFF switch or the personalization feature.

Operation conditions

When all of the following conditions are met, the i-ACTIVSENSE status symbol (warning/risk avoidance support system) on the multi-information display changes from white to green and the system becomes operational.

- The vehicle speed is about 64 km/h (40 mph) or faster.
- The system detects white (yellow) lane lines.



NOTE

When the system does not detect a white (yellow) lane line on one side only, the system does not operate on the side that is not being detected.

When temporarily canceling the system

The LAS goes on standby in the following cases: The LAS operation is automatically restored when the system's operation conditions are met.

- The system cannot detect white (yellow) lane lines.
- The vehicle speed is less than about 56 km/h (35 mph).
- The turn signal lever is operated.
- The accelerator pedal is depressed abruptly.
- The TCS/DSC is operating.
- The DSC is turned off.
- The steering wheel is operated.
- The brake pedal is operated.

The function is temporarily stopped.

The LAS stops functioning in the following cases:

- The temperature in the forward sensing camera (FSC) is too high or too low.
- The windshield around the forward sensing camera (FSC) is foggy.
- The windshield around the forward sensing camera (FSC) is blocked by an obstruction, causing poor forward visibility.
- Strong light (such as sunlight, or headlights (high-beam) of on-coming vehicles) is directed at the forward sensing camera (FSC).

System malfunction

If there is a problem with the system, the i-ACTIVSENSE status symbol (warning/risk avoidance support system) (white) and the i-ACTIVSENSE warning indication/warning light on the multi-information display turns on and a message is indicated.

Refer to i-ACTIVSENSE Status Symbol (Warning/Risk Avoidance Support System) on page 4-87.

▼ Steering Wheel Operation Assist

When the system determines that the vehicle might be deviating from its lane, the steering wheel operation assist operates.

The system notifies the driver of the direction in which the system provided steering wheel operation assistance on the multi-information display.

Multi-information display

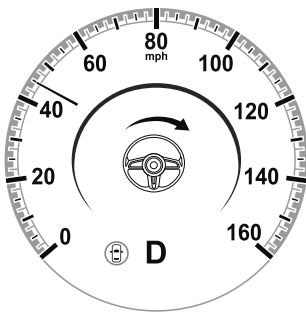

NOTE

When the driver operates the steering wheel while the steering wheel operation assist is operating, the steering wheel operation assistance is canceled.

▼ System Canceling

The LAS can be set to inoperable.

- **(If only the LAS is turned off)**
Refer to the Settings section in the Mazda Connect Owner's Manual.
- **(If the LAS is turned off by operating the i-ACTIVSENSE OFF switch)**
Refer to i-ACTIVSENSE OFF Switch on page 4-89.

NOTE

If the ignition is switched OFF while you have canceled the system using the i-ACTIVSENSE OFF switch, the system is automatically enabled the next time the ignition is switched ON. However, if the system is canceled using the personalization features, the system is not automatically enabled.

Smart Brake Support (SBS)*

▼ Smart Brake Support (SBS)

The SBS alerts the driver of a possible collision using the warning indications in the display and a warning sound if the front radar sensor and Forward Sensing Camera (FSC) determine that there is the possibility of a collision with a vehicle ahead, pedestrian, or a bicycle. Furthermore, if a collision is unavoidable, the automatic brake control is performed to reduce damage in the event of a collision. In addition, when the driver depresses the brake pedal, the brakes are applied firmly and quickly to assist.

(Vehicles with Driver Monitoring (DM))

When the SBS determines that the driver is not paying attention to the road using the driver monitoring camera and it determines that there is the possibility of a collision with an obstruction, the SBS activates the collision warning earlier than normal.

WARNING

Do not rely completely on the SBS:

The SBS is only designed to reduce damage in the event of a collision. The ability to detect obstructions is limited depending on the obstructions, weather conditions, or traffic conditions. Over reliance on the system leading to the accelerator pedal or brake pedal being mistakenly operated could result in an accident.

CAUTION

In the following cases, turn the system off to prevent an unexpected operation.

- The vehicle is being towed or when towing another vehicle.
- The vehicle is on a chassis roller.
- When driving on rough roads such as in areas of dense grass or off-road. See the next page on how to turn off the system. Refer to Stopping the Smart Brake Support (SBS) System Operation on page 4-160.

Operation conditions

The SBS operates when all of the following conditions are met.

- The ignition is switched ON.
- The SBS is on.
- The i-ACTIVSENSE warning indication/warning light is not turned on.
- **(Object is vehicle ahead)**
The vehicle speed is about 4 km/h (2 mph) or higher.
- **(Object is a pedestrian or bicycle)**
The vehicle speed is between about 10 to 80 km/h (6.2 to 50 mph).
- The DSC does not operate.

NOTE

- Under the following conditions, the SBS may not operate.
 - If there is the possibility of hitting only a part of a vehicle or obstruction ahead.
 - You are driving your vehicle at the same speed as the vehicle ahead.
 - When the driver deliberately performs driving operations (accelerator operation, steering wheel operation).

- The accelerator pedal is depressed abruptly.
- The brake pedal is being depressed.
- The steering wheel is being operated.
- The selector lever is being shifted.
- The turn signal lever is being operated.
- When warnings and messages, such as a dirty windshield, related to the Forward Sensing Camera (FSC) or front radar sensor are being displayed on the multi-information display.
- The SBS may operate under the following conditions.
 - There is an object in the road at the entrance to a curve (including guardrails and snow banks).
 - Passing an approaching vehicle while rounding a curve.
 - When crossing a narrow bridge, and passing through low gates, narrow gates, car washing machines, or tunnels.
 - When passing through a toll gate.
 - When entering an underground parking area.
 - There is a metal object, bump, or a protruding object on the road.
 - If you suddenly come close to a vehicle ahead.
 - There is an animal, wall, or tree.
- Notifies the driver with a warning indication on the multi-information display and the active driving display (vehicles with active driving display) while the system is operating.
- If a malfunction is detected or the system temporarily stops the function due to dirty sensors (such as radar sensor or Forward Sensing Camera (FSC)), the i-ACTIVSENSE warning indication/warning light turns on and a message is displayed on the multi-information display.
- On a manual transmission vehicle, the engine stops if the clutch pedal is not depressed when the vehicle is stopped by the SBS brake operation.
- If the vehicle is stopped by the SBS brake operation and the brake pedal is not depressed, the SBS brake is automatically released after about 2 seconds.

▼ Collision Warning

When there is a possibility of a collision with a vehicle ahead, the collision warning sound is activated continuously and a warning is displayed on the multi-information display and the active driving display.

Multi-information display

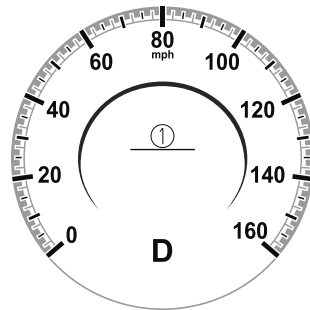

1. "BRAKE!" message is displayed

Active driving display

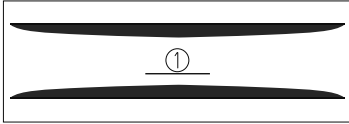

1. "BRAKE!" message is displayed

NOTE

- The collision warning sound is activated intermittently while the SBS brake or brake assist (SBS brake assist) is operating.
- The operation distance and volume of the collision warning can be changed.

Refer to the Settings section in the Mazda Connect Owner's Manual.

▼ Stopping the Smart Brake Support (SBS) System Operation

The SBS can be changed to inoperable. Refer to the Settings section in the Mazda Connect Owner's Manual. When the SBS is canceled, the SBS OFF indicator turns on.



NOTE

When the ignition is switched OFF while the SBS is canceled, the SBS is automatically enabled the next time the ignition is switched ON.

Smart Brake Support [Rear] (SBS-R)*

▼ Smart Brake Support [Rear] (SBS-R)

The SBS-R is a system which is designed to reduce damage in the event of a collision by operating the brake control (SBS brake) when the system's sensors detect an obstruction at the rear of the vehicle while driving at a speed of about 2 to 8 km/h (2 to 4 mph) and the system determines that a collision is unavoidable.

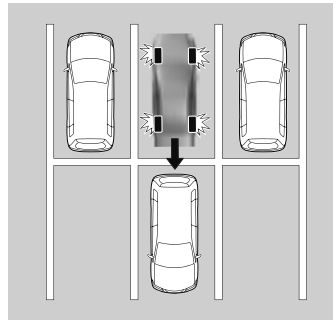

⚠ WARNING

Do not rely completely on the SBS-R system:

- The SBS-R system is only designed to reduce damage in the event of a collision. Over reliance on the system leading to the accelerator pedal or brake pedal being mistakenly operated could result in an accident.
- To assure the correct operation of the SBS-R, heed the following cautions.

- Do not apply a sticker to a rear ultrasonic sensor and rear camera. Otherwise, the rear ultrasonic sensor and rear camera may not be able to detect vehicles or obstructions which could result in an accident.
- Do not disassemble a rear ultrasonic sensor and rear camera.
- If cracks or damage caused by flying gravel or debris is visible around a rear ultrasonic sensor and rear camera, stop using the SBS-R system immediately and have your vehicle inspected by an Authorized Mazda Dealer. If the vehicle continues to be driven with cracks or scratch marks left around an ultrasonic sensor, the system may operate unnecessarily and cause an unexpected accident. Refer to Stopping the Smart Brake Support [Rear] (SBS-R) System Operation on page 4-163.
- Consult an Authorized Mazda Dealer for rear bumper removal.

Do not modify the suspension:

If the vehicle height or inclination is changed, the SBS-R system may not operate correctly because it cannot detect obstructions correctly.

Do not apply a strong force to a rear ultrasonic sensor and rear camera:

When washing the vehicle, do not spray highly pressurized water against a rear ultrasonic sensor and rear camera, or rub it strongly. In addition, do not hit the rear bumper forcefully when loading and unloading cargo. Otherwise, the sensors may not detect obstructions correctly which could cause the SBS-R system to not operate normally, or it could operate unnecessarily.

 **CAUTION**

- When driving off-road in areas where there is grass or foliage, it is recommended that the SBS-R system be turned off.
- Always use tires of the specified size and the same manufacturer, brand, and tread pattern on all 4 wheels. In addition, do not use tires with significantly different wear patterns on the same vehicle. Otherwise, the SBS-R system may not operate normally.
- If ice or snow is stuck on the rear ultrasonic sensor and rear camera they may not be able to detect obstructions correctly depending on the conditions. In such cases, the system may not be able to perform controls correctly. Always drive carefully and pay attention to the rear of the vehicle.

NOTE

- The vehicle posture changes depending on the accelerator pedal, brake pedal and steering wheel operations, which could make it difficult for the system to recognize an obstruction, or it could facilitate unnecessary detection. In such cases, the SBS-R may or may not operate.
- The SBS-R system will operate under the following conditions.
 - The engine is running for 3 seconds or more.
 - The shift lever (manual transmission vehicle) or the selector lever (automatic transmission vehicle) is in the R (reverse) position.
 - i-ACTIVSENSE warning indication/warning light is not displayed in the multi-information display.
 - The vehicle speed is between about 2 to 8 km/h (2 to 4 mph).
 - The SBS-R is not turned off.
 - The DSC is not malfunctioning.
- In the following cases, the rear ultrasonic sensor and rear camera cannot detect obstructions and the SBS-R may not operate.
 - The height of the obstruction is low such as low walls or trucks with low loading platforms.
 - The height of the obstruction is high such as trucks with high loading platforms.
 - The obstruction is small.
 - The obstruction is thin such as a signpost.
 - The surface of the obstruction is not pointed vertically relative to the vehicle.
 - The obstruction is soft such as a hanging curtain or snow stuck to a vehicle.
 - The obstruction is shaped irregularly.
 - The obstruction is extremely close.
- In the following cases, the rear ultrasonic sensor and rear camera cannot detect obstructions correctly and the SBS-R may not operate.
 - Something is stuck on the bumper near a rear ultrasonic sensor.
 - The brake or accelerator pedal is operated.
 - There is another obstruction near one obstruction.
 - During inclement weather such as rain, fog and snow.
 - High or low humidity.
 - High or low temperatures
 - Strong winds.
 - The path of travel is not flat.
 - Heavy luggage is loaded in the luggage compartment or on the rear seat.
 - Objects such as a wireless antenna, fog light, or illuminated license plate is installed near a rear ultrasonic sensor.
 - The orientation of a rear ultrasonic sensor has deviated for reasons such as a collision.
 - The vehicle is affected by other sound waves such as the horn, engine noise, ultrasonic sensor of another vehicle.
- In the following cases, a rear ultrasonic sensor and rear camera may detect something as a target obstruction which could cause the SBS-R system to operate.
 - There is a steep slope or bump.
 - There are wheel blocks or a curbstone.
 - There are hanging curtains, gate poles such as at toll gates and railroad crossing.

- When traveling near objects such as foliage, barriers, vehicles, walls, and fences along a road.
- When driving off-road in areas where there is grass and forage.
- When passing through low gates, narrow gates, car washing machines, and tunnels.
- A trailer is connected.
- An exterior accessory such as a bicycle carrier is installed around a rear ultrasonic sensor.
- **(Manual transmission)**
If the vehicle is stopped by the SBS-R operation and the clutch pedal is not depressed, the engine stops.
- When the system operates, the user is notified by the multi-information display.
- The collision warning beep sounds intermittently while the SBS-R brake is operating.
- If the vehicle is stopped by the SBS-R operation and the brake pedal is not depressed, displaying in meter "Emergency Braking Activated. Depress Brake Pedal to Hold Stop", after about 2 seconds and the SBS-R brake is automatically released.
- Turn off the SBS-R system while pulling a trailer or while an accessory such as a bicycle carrier is installed to the rear of the vehicle.

▼ Collision Warning

If there is a possibility of a collision, the collision warning sound is activated continuously and a warning is displayed on the active driving display and the multi-information display.

Multi-information display

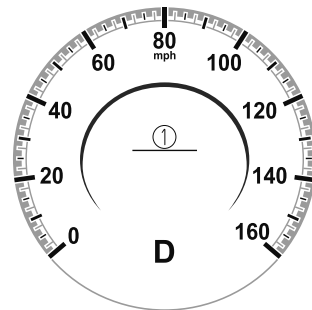

1. "BRAKE!" message is displayed

Active driving display

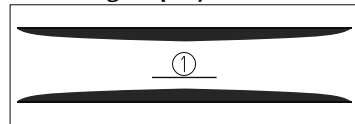

1. "BRAKE!" message is displayed

▼ Stopping the Smart Brake Support [Rear] (SBS-R) System Operation

The SBS-R can be changed to inoperable.

Refer to the Settings section in the Mazda Connect Owner's Manual.

When the SBS-R is canceled, the SBS OFF indicator light turns on.



NOTE

When the SBS-R is canceled, the Smart Brake Support [Rear Crossing] (SBS-RC) is also canceled.

Smart Brake Support [Rear Crossing] (SBS-RC)*

▼ Smart Brake Support [Rear Crossing] (SBS-RC)

The SBS-RC is a system designed to assist the driver in avoiding collisions and to reduce damage in the event of a collision by applying the brakes if there is the possibility of collision with a vehicle approaching from the rear while you are reversing out of parking space.

The SBS-RC system detects vehicles approaching from the rear left and right sides of the vehicle, and the rear of the vehicle while the vehicle is being reversed out of a parking space, the system reduces damage in the event of a collision by operating the brake control when the system determines that a collision is unavoidable.

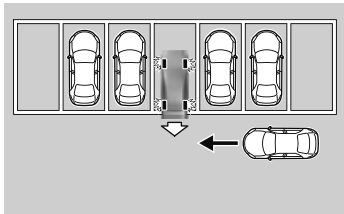

SBS-RC operation

1. The SBS-RC system operates when the shift lever (manual transmission) or the selector lever (automatic transmission) is shifted to the reverse (R) position.
2. If there is the possibility of a collision with an approaching vehicle, the SBS-RC system applies brake and displays "BRAKE!" on the active driving display and the multi-information display.

⚠ WARNING

Always check the surrounding area visually before actually putting the vehicle in reverse:

The system is only designed to assist you in backing out of the lot when putting the vehicle in reverse. Due to certain limitations with the operation of this system, the SBS-RC system may not operate brake or it might be delayed even though a vehicle is behind your vehicle. Always make it your responsibility as a driver to check the rear.

Do not rely completely on the SBS-RC system:

- The SBS-RC system is only designed to reduce damage in the event of a collision. Over reliance on the system leading to the accelerator pedal or brake pedal being mistakenly operated could result in an accident.
- The SBS-RC system operates in response to a vehicle. The system does not operate in response to obstructions such as a wall, pedestrians, or animals.

To assure the correct operation of the SBS-RC, heed the following cautions.

- Do not apply a sticker to a rear radar and rear camera. Otherwise, the rear radar and rear camera may not be able to detect vehicles or obstructions which could result in an accident.
- Do not disassemble a rear radar and rear camera.
- If cracks or damage caused by flying gravel or debris is visible around a rear radar and rear camera, stop using the SBS-RC system immediately and have your vehicle inspected by an Authorized Mazda Dealer. If the vehicle continues to be driven with cracks or scratch marks left around an ultrasonic sensor, the system may operate unnecessarily and cause an unexpected accident. Refer to Stopping the Smart Brake Support [Rear Crossing] (SBS-RC) System Operation on page 4-168.
- Consult an Authorized Mazda Dealer for rear bumper removal.

Do not modify the suspension:

If the vehicle height or inclination is changed, the SBS-RC system may not operate correctly because it cannot detect obstructions correctly.

Do not apply a strong force to a rear radar and rear camera:

When washing the vehicle, do not spray highly pressurized water against a rear radar and rear camera, or rub it strongly. In addition, do not hit the rear bumper forcefully when loading and unloading cargo. Otherwise, the sensors may not detect obstructions correctly which could cause the SBS-RC system to not operate normally, or it could operate unnecessarily.

NOTE

- The SBS-RC system will operate under the following conditions.
 - The engine is running for 3 seconds or more.
 - The shift lever (manual transmission vehicle) or the selector lever (automatic transmission vehicle) is in the R (reverse) position.
 - i-ACTIVSENSE warning indication/warning light is not displayed in the multi-information display.
 - The vehicle speed is under about 10 km/h (6 mph).
 - The vehicle speed of an approaching vehicle is about 3 km/h (2 mph) or faster.
 - The SBS-R is not turned off.
 - The DSC is not malfunctioning.
- In the following cases, the i-ACTIVSENSE warning indication/warning light turns on and operation of the system is stopped. If the i-ACTIVSENSE warning indication/warning light remains illuminated, have the vehicle inspected at an Authorized Mazda Dealer as soon as possible.
 - Some problem with the system including the SBS-RC system.

- A large deviation in the installation position of a rear side radar sensor on the vehicle has occurred.
- There is a large accumulation of snow or ice on the rear bumper near a rear side radar sensor.
- Driving on snow-covered roads for long periods.
- The temperature near the radar sensors becomes extremely hot due to driving for long periods on slopes during the summer.
- The battery voltage has decreased.
- Under the following conditions, the rear side radar sensor cannot detect target objects or it may be difficult to detect them.
 - The rear side radar sensor detection area is obstructed by a nearby wall or parked vehicle. (Reverse the vehicle to a position where the radar sensor detection area is no longer obstructed.)

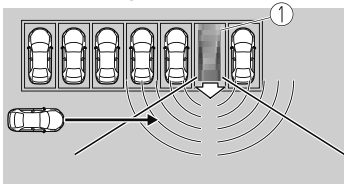

1. Your vehicle

- A vehicle is approaching directly from the rear of your vehicle.

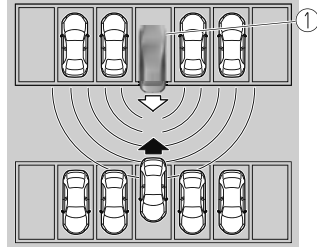

1. Your vehicle

- The vehicle is parked on a slant.

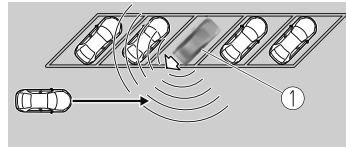

1. Your vehicle

- A vehicle is approaching from the opposite direction on a steep gradient.

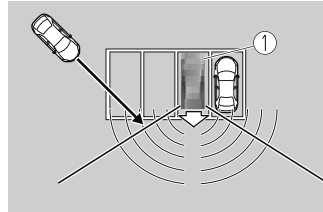

1. Your vehicle

- Directly after the SBS-RC system becomes operable using the personalization feature.
- Radio wave interference from a radar sensor equipped on a nearby parked vehicle.

- Turn off the SBS-RC system while pulling a trailer or while an accessory such as a bicycle carrier is installed to the rear of the vehicle. Otherwise, the radio waves emitted by the radar will be blocked causing the system to not operate normally.
- In the following cases, a rear radar and rear camera may detect something as a target obstruction which could cause the SBS-RC system to operate.
 - There are hanging curtains, gate poles such as at toll gates and railroad crossing.
 - When traveling near objects such as foliage, barriers, vehicles, walls, and fences along a road.
 - When driving off-road in areas where there is grass and forage.
 - When passing through low gates, narrow gates, car washing machines, and tunnels.
 - A trailer is connected.
 - When a rear-mounted bike rack (towbar bike carrier) is installed.
- **(Manual transmission)**
If the vehicle is stopped by the SBS-RC operation and the clutch pedal is not depressed, the engine stops.
- When the system operates, the user is notified by the multi-information display.
- The collision warning beep sounds intermittently while the SBS-RC brake is operating.
- If the vehicle is stopped by the SBS-RC operation and the brake pedal is not depressed, displaying in meter "Emergency Braking Activated. Depress Brake Pedal to Hold Stop", after about 2 seconds and the SBS-RC brake is automatically released.

▼ Collision Warning

If there is a possibility of a collision, the collision warning sound is activated continuously and a warning is displayed on the active driving display and the multi-information display.

Multi-information display

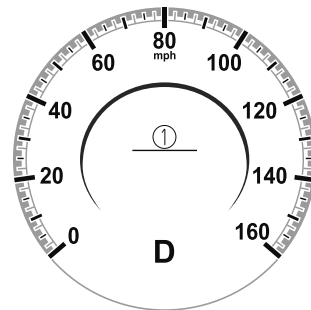

1. "BRAKE!" message is displayed

Active driving display

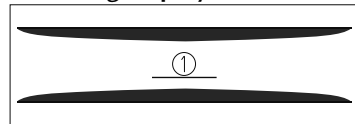

1. "BRAKE!" message is displayed

▼ Stopping the Smart Brake Support [Rear Crossing] (SBS-RC) System Operation

The SBS-RC can be changed to inoperable.

Refer to the Settings section in the Mazda Connect Owner's Manual.

When the SBS-RC is canceled, the SBS OFF indicator light turns on.



NOTE

When the SBS-RC is canceled, the Smart Brake Support [Rear] (SBS-R) is also canceled.

360° View Monitor*

▼ 360° View Monitor

The 360°View Monitor consists of the following functions which assist the driver in checking the area surrounding the vehicle using various indications in the center display and a warning sound while the vehicle is being driven at low speeds or while parking.

• Top view

The top view displays an image of the vehicle from directly above on the center display by combining the images taken from the 4 cameras set on all sides of the vehicle. The top view displays on the right side of the screen when the front view or rear view screen is being displayed. The top view assists the driver in checking the area surrounding the vehicle when the vehicle is moving forward or in reverse.

• Front view/front wide view

The image from the front of the vehicle is displayed on the center display.

The view from the front assists the driver in checking the front of the vehicle by displaying guide lines on the displayed image taken from the front of the vehicle.

• Side view

The images taken from the front left and right sides of the vehicle are displayed on the center display.

The side view assists the driver in checking the front sides of the vehicle by displaying guide lines on the displayed image taken from the front left and right sides of the vehicle.

• **Rear view/rear wide view**

The image from the rear of the vehicle is displayed on the center display.

The image from the rear assists the driver in checking the rear of the vehicle by displaying guide lines on the displayed image taken from the rear of the vehicle.

• **Parking sensor**

If there are any obstructions near the vehicle while the top view/side view is displayed, an obstruction detection indication turns on around the bumper in the center display.

The parking sensors use ultrasonic sensors to detect obstructions around the vehicle when the vehicle is driven at low speeds, such as during garage or parallel parking, and notifies the driver of the approximate distance from the vehicle to the surrounding obstruction using sound and an obstruction detection indication. Refer to Parking Sensor System on page 4-238.

• **Front Cross Traffic Alert (FCTA)**

If there is the possibility of a collision with an approaching vehicle while the front view/front wide view/side view is displayed, a warning is displayed on the center display.

The Front Cross Traffic Alert (FCTA) is designed to assist the driver in checking both sides of the vehicle when the vehicle starts to drive at an intersection.

Refer to Front Cross Traffic Alert (FCTA) on page 4-113.

• **Rear Cross Traffic Alert (RCTA)**

If there is the possibility of a collision with an approaching vehicle while the rear view/rear wide view is displayed, a warning is displayed on the center display.

The Rear Cross Traffic Alert (RCTA) uses rear side radar sensor to detect vehicles approaching from the rear left and right sides of the vehicle, and it assists the driver in checking the rear of the vehicle while reversing by flashing the Blind Spot Monitoring (BSM) warning lights and activating the warning sound.

Refer to Rear Cross Traffic Alert (RCTA) on page 4-116.

360°View Monitor Range

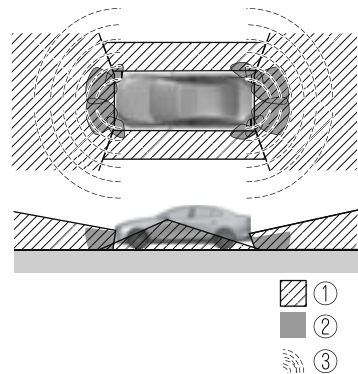

1. Cameras
2. Ultrasonic sensors
3. Front/Rear side radar sensors

 **WARNING**

Always confirm the safety of the area around the vehicle with the mirrors and directly with your eyes when driving:

The 360°View Monitor is an auxiliary device which assists the driver in checking the safety of the area around the vehicle.

The shooting range of the cameras and detection range of the sensors are limited. For example, the areas in black at the front and rear of the vehicle image and the seams where each of the camera images merge are blind spots where an obstruction may not be visible. In addition, the extended vehicle width lines and projected vehicle path lines are only to be used as references, and the images on the screen may differ from the actual conditions.

 **CAUTION**

- Do not use the 360°View Monitor under any of the following conditions.
 - Icy or snow-covered roads.
 - Tire chains or a temporary spare tire is installed.
 - The front or rear doors are not fully closed.
 - The vehicle is on a road incline.
 - The door mirrors are retracted.
- Do not hit the front/rear camera, front/rear bumper, and door mirrors forcefully. The camera position or installation angle may shift.
- The cameras are waterproof. Do not disassemble, modify, or remove a camera.

- The camera cover is made of hard plastic, therefore do not apply oil film remover, organic solvents, wax, or coating agents. If any such agent gets on the camera cover, wipe it off using a soft cloth immediately.
- Do not rub the camera lens forcefully, or clean it with an abrasive or hard brush. Otherwise, it could scratch the camera lens and negatively affect the images.
- Consult an Authorized Mazda Dealer for repair, painting, or replacement of the front/rear camera, front/rear bumper and door mirrors.
- Heed the following cautions to assure that the 360°View Monitor operates normally.
 - Do not modify the vehicle suspensions or lower/raise the vehicle body, or both.
 - Always use tires of the specified type and size for the front and rear wheels. Consult an Authorized Mazda Dealer for tire replacement.
- When the display is cold, images may leave trails or the screen might be darker than usual, making it difficult to check the vehicle surroundings. Always confirm the safety at the front and around the vehicle visually when driving.

➤ The method for parking/stopping the vehicle using the 360°View Monitor differs depending on the road circumstances/conditions and the vehicle conditions. When and how much you turn the steering wheel will differ depending on the situation, , therefore always check the vehicle surroundings directly with your eyes while using the system. Also, before using the system, always make sure that the vehicle can be parked/stopped in the parking/ stopping space.

NOTE

- If there are water droplets, snow, or mud on the camera lens, wipe it off using a soft cloth. If the camera lens is especially dirty, wash it off with mild detergent.
- If the camera lens is touched or there is any dirt on it, it could affect the screen image. Wipe the lens using a soft cloth.
- If the area where the camera is installed, such as the front/rear bumper or door mirrors, has been damaged in a vehicle accident, the camera (position, installation angle) may have shifted. Always consult an Authorized Mazda Dealer to have the vehicle inspected.
- If the camera is subjected to excessive changes in temperature such as by pouring hot water on the camera during cold weather, the 360°View Monitor may not operate normally.

- If the vehicle is driven during cold temperatures and the camera temperature decreases, the top view and the side view may become unclear. However, this does not indicate a problem. If the vehicle is stopped for a while and the camera temperature increases, the top view and the side view will return to the normal condition.
- If the battery voltage is low, the screen might be temporarily difficult to view, however, this does not indicate a problem.
- The 360°View Monitor has limitations. Objects under the bumper or near both ends of the bumper cannot be displayed.
- Obstructions above the upper image range of the camera are not displayed.
- Under the following conditions, the screen might be difficult to view, however this does not indicate a problem.
 - The temperature near the lens is high/low.
 - Rainy conditions, water droplets on the camera, or high humidity.
 - Mud or foreign matter near the camera.
 - Extremely bright light such as sunlight or headlights hitting the camera lens directly.
 - The surroundings are illuminated by vehicle lights, fluorescent lights, or LED lights (display may flicker).
 - Extremely small dark or white dots appear on the screen (dots may flicker).
- Because the 360°View Monitor camera uses a special lens, the distance displayed on the screen differs from the actual distance.

- Obstructions displayed on the screen may appear differently than in actuality. (Obstructions may appear fallen, larger, or longer than they actually are.)
- Do not apply stickers to a camera or the area around it. In addition, do not install accessories or an illuminated number/character license plate to the area around a camera. Otherwise, the camera may not correctly display the surrounding conditions.
- Images displayed on the monitor from the 360° view monitor camera are reversed images (mirror images).

- **Free/open source software information**

This product includes free/open sources. Information about the licensing and source code is available at the following URL.

<https://www.denso.com/global/en/opensource/svss/mazda/>

▼ Types of Images Displayed on the Screen

Top view/Front view

Displays the image of the area around the vehicle and the vehicle front.

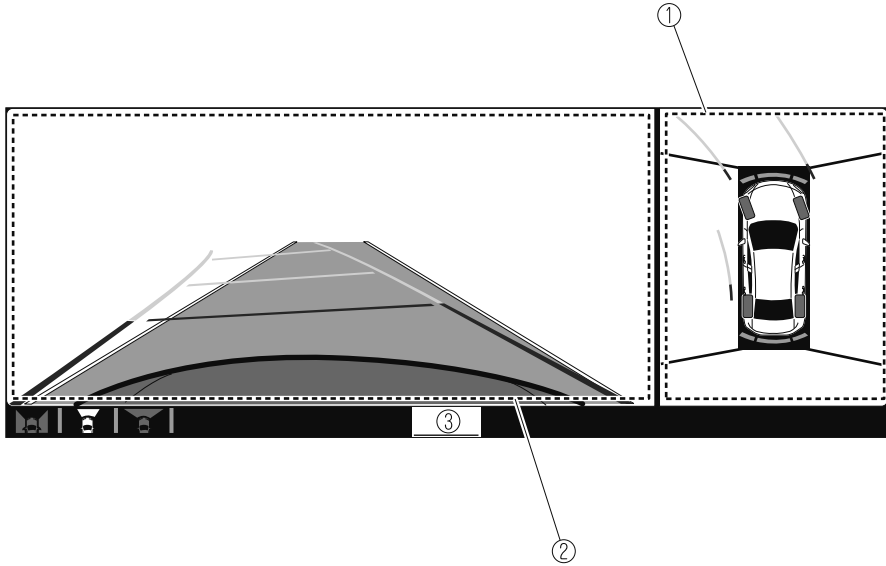

1. Top view screen
2. Front view screen
3. "Check surroundings for safety." message is displayed

Top view/Front wide view

Displays the image of the area around the vehicle and the front of the vehicle (wide-area).

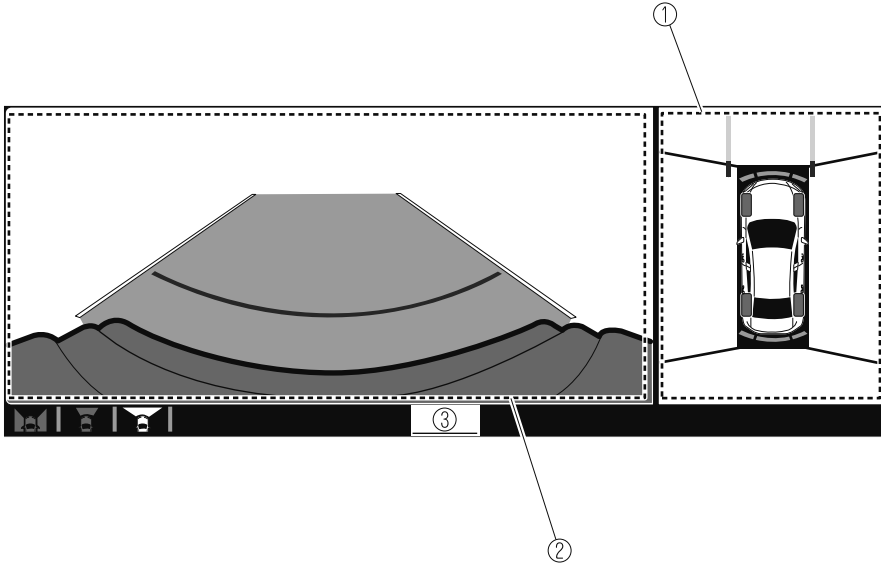

1. Top view screen
2. Front wide view screen
3. "Check surroundings for safety." message is displayed

Side view

Displays the image of the left and right sides of the vehicle.

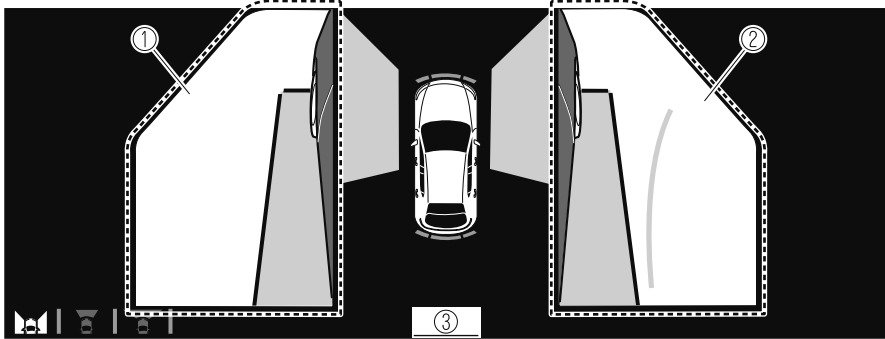

1. Left side view screen
2. Right side view screen
3. "Check surroundings for safety." message is displayed

Top view/Rear view

Displays the image of the area around the vehicle and the rear of the vehicle.

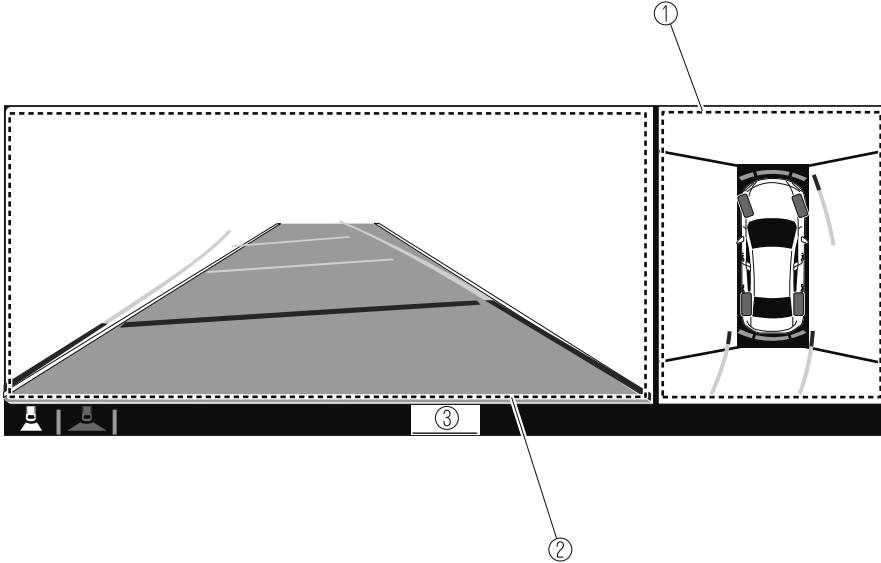

1. Top view screen
2. Rear view screen
3. "Check surroundings for safety." message is displayed

Top view/Rear wide view

Displays the image of the area around the vehicle and the rear of the vehicle (wide-area).

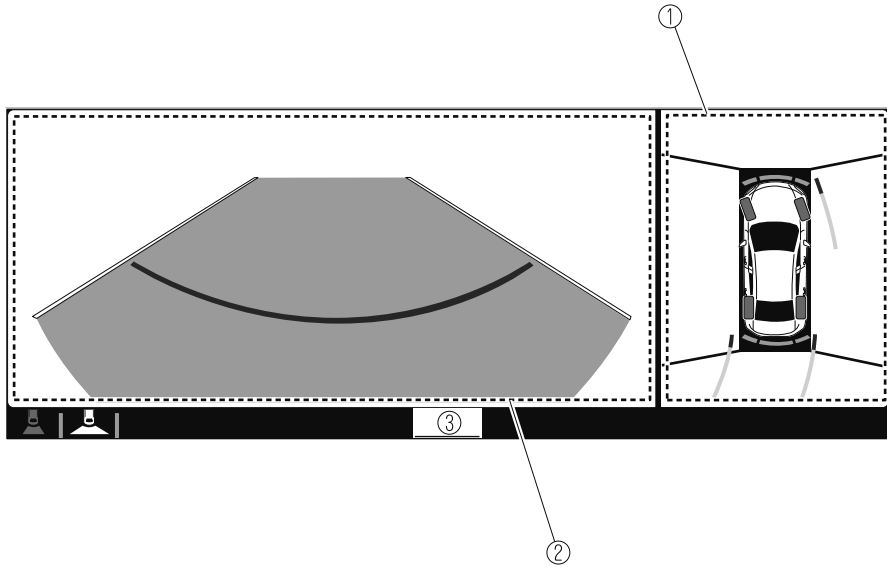

1. Top view screen
2. Rear wide view screen
3. "Check surroundings for safety." message is displayed

▼ **How to Use the System**

Top view/Front view, Top view/Front wide view, Side view

Indication

Images are displayed on the screen when the 360°View Monitor switch is pressed with all of the following conditions met.

- The ignition is switched ON.
- The shift lever/selector lever is in a position other than R.

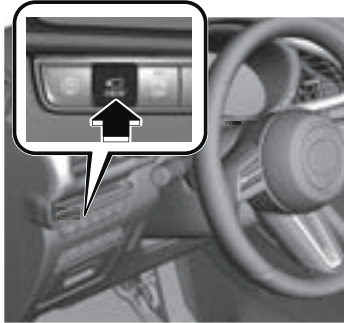

Display switching

The displayed screen can be changed each time the 360°view monitor switch is pressed.

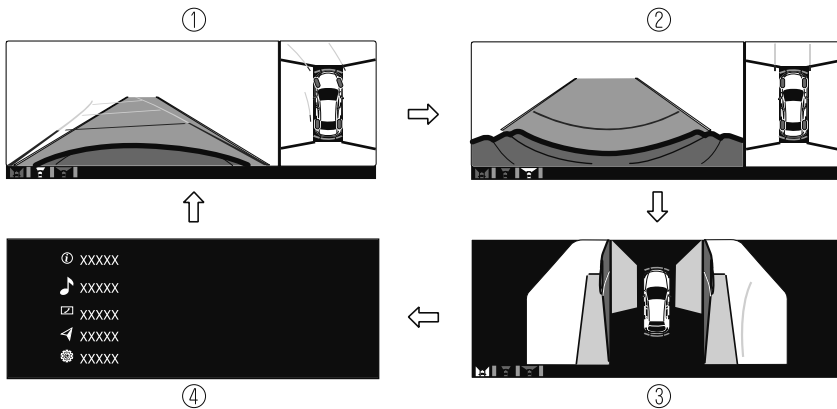

1. Top view/Front view
2. Top view/Front wide view
3. Side view
4. Home screen

NOTE

- When the shift lever/selector lever is in R position, the displayed screen does not switch to the top view/front view, top view/front wide view, or the side view.
- Display of the top view/front view, top view/front wide view, or the side view stops even with the display conditions met if any of the following conditions occurs.
 - When a switch around the commander knob is pressed.
 - **(Manual transmission)**
The parking brake is applied.
 - **(Automatic transmission)**
The selector lever is shifted to P position (displayed when the selector lever is in a position other than P).
 - **(Displayed when vehicle speed is less than 15 km/h (9.3 mph))**
 - 4 minutes and 30 seconds have passed.
 - The vehicle speed is about 15 km/h (9.3 mph) or faster.
 - **(Displayed when the vehicle speed is about 15 km/h (9.3 mph) or faster)**
 - The vehicle speed is about 15 km/h (9.3 mph) or faster after 8 seconds have passed since pressing the 360°View Monitor switch.
 - Four minutes and 22 seconds have passed from the point when the vehicle speed was less than 15 km/h (9.3 mph) after 8 seconds have passed since pressing the 360°View Monitor switch.

- The 360°View Monitor settings can be changed as follows.
Refer to the Settings section in the Mazda Connect Owner's Manual.
- Automatic display of the 360°View Monitor when the ultrasonic sensor detects an obstruction.
- Automatic display of the 360°View Monitor when the ignition is switched ON.
- Screen priority level when the system launches.

Top view/Rear view, Top view/Rear wide view

The top view/rear view, top view/rear wide view displays when all of the following conditions are met.

- The ignition is switched ON.
- Shift lever/selector lever is in R position.

Display switching

The displayed screen can be changed each time the 360°view monitor switch is pressed.

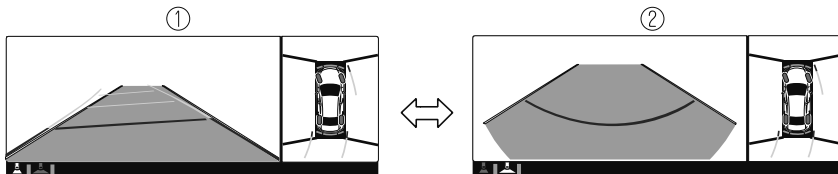

1. Top view/Rear view
2. Top view/Rear wide view

NOTE

- The top view/rear view and top view/rear wide view automatically display whether or not the 360°View Monitor switch is turned on or off when shifting the shift lever/selector lever to R position.
- The top view/rear view and top view/rear wide view displays the previously displayed screen.
- The setting can be changed to display the top view/front view when shifting from reverse to a forward gear without operating the 360°View Monitor switch to check the front of the vehicle while parallel parking.
Refer to the Settings section in the Mazda Connect Owner's Manual.

Screen operation/icon

⚠ WARNING

Always stop the vehicle when adjusting the 360°View Monitor image quality. Do not adjust the 360°View Monitor image quality while driving. If you adjust the 360°View Monitor image quality (such as brightness, contrast, tone, and color density) while driving, it could lead to an unexpected accident.

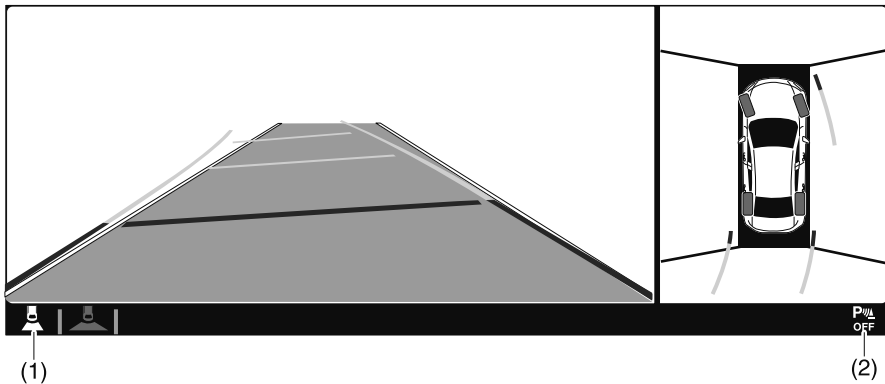

	Display/Icon	Content
(1)	View status icon	Indicates which image is displayed among the front view/front wide view/side view/rear view/rear wide view.
(2)	Parking sensor status icon	Indicates that the parking sensor has a problem or it is switched off.

▼ **Top View/Front View**

Use the top view/front view to assist in checking the safety of the surrounding area when accelerating from a stop, parking, or stopping the vehicle.

Display range

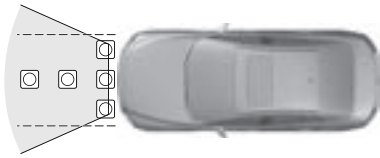
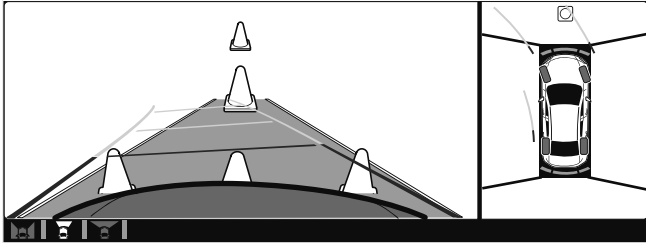

1. Target object

NOTE

- In the top view screen, the areas in black at the front and rear of the vehicle image and the seams where each of the camera images merge are blind spots.
- Because images displayed in the top view screen are processed from each camera, the top view screen may display in the following ways.
 - If an image containing an object with a conspicuous color is picked up by any of the cameras, the screen area for each camera may be affected and it may display in that color.
 - Obstructions displayed in the front view may not display on the top view screen.
 - If the position or angle of each camera changes due to tilting of the vehicle, the image may appear distorted.
 - Lines on the road may appear distorted at the seams where each of the camera images merge.
 - The screen area for each camera may appear bright/dark depending on the illumination level around any of the cameras.

Viewing the screen

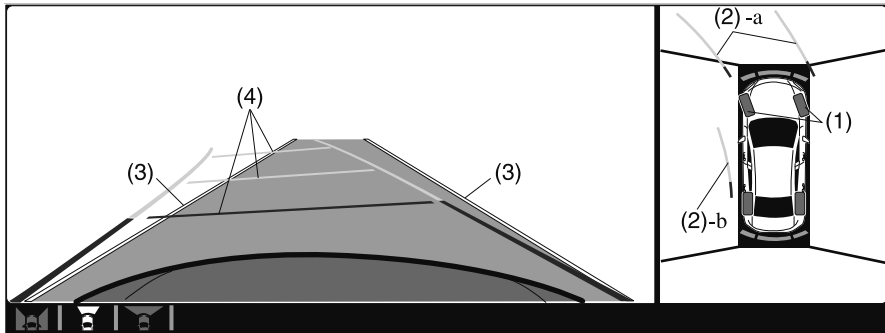

	Display/Icon	Content
(1)	Tire icon	Indicates the tire direction. Moves in conjunction with the steering wheel operation.
(2)	Projected vehicle path lines (yellow & red)	Indicates the approximate projected path of the vehicle. Moves in conjunction with the steering wheel operation. a) Indicates the path where the edge of the front bumper is expected to travel. b) Indicates the path where the inner side of the vehicle is expected to travel.
(3)	Extended vehicle width lines (blue)	Indicates the approximate width of the vehicle.
(4)	Projected vehicle path distance guide lines (yellow & red)	Indicates the distance (from front end of bumper) in front of the vehicle. <ul style="list-style-type: none"> • The red line indicates the point about 0.5 m (19 in) from the front end of the bumper. • The yellow lines indicate the points about 1.0 m (39 in) and 2.0 m (78 in) from the front end of the bumper.

! CAUTION

The parking sensor detection range has limitations. For example, obstructions closing in from the side and objects short in height may not be detected. Always confirm the safety around the vehicle visually when driving.

For details, refer to the parking sensor obstruction detection indication and warning sound.

Refer to Parking Sensor System on page 4-238.

NOTE

The setting can be changed so that the projected vehicle path lines are not displayed.

Refer to the Settings section in the Mazda Connect Owner's Manual.

How to use the projected vehicle path line function

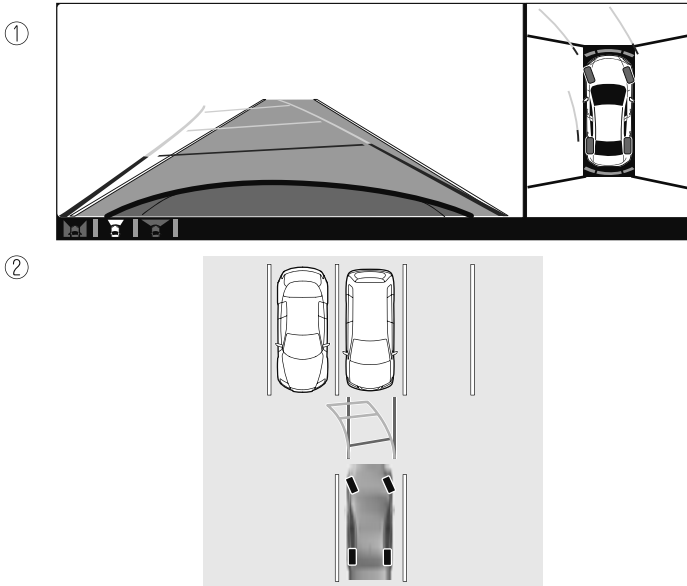

1. (Screen display)
2. (Actual condition)

Make sure that there are no obstructions within the projected vehicle path lines. Drive the vehicle forward while turning the steering wheel so that no obstructions come within the projected vehicle path lines.

▼ Top View/Front Wide View

Use the top view/front wide view to assist in checking the safety of the surrounding area when accelerating from a stop or entering a T-shaped intersection and intersection.

Display range

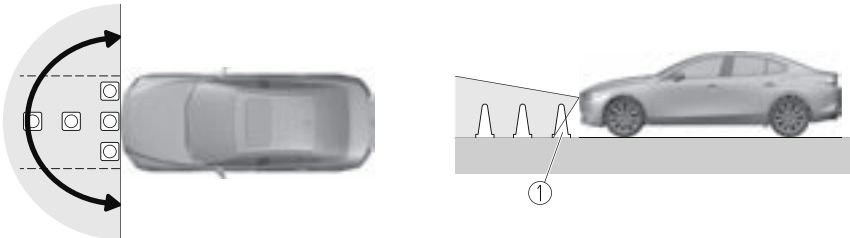
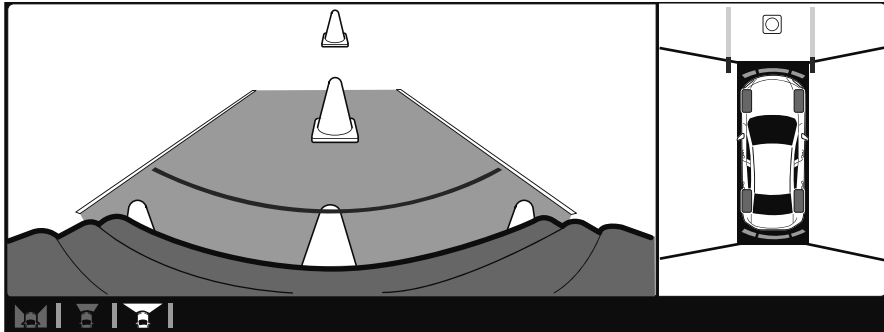

1. Target object

NOTE

- In the top view screen, the areas in black at the front and rear of the vehicle image and the seams where each of the camera images merge are blind spots.
- Because images displayed in the top view screen are processed from each camera, the top view screen may display in the following ways.
 - If an image containing an object with a conspicuous color is picked up by any of the cameras, the screen area for each camera may be affected and it may display in that color.
 - Obstructions displayed in the front view may not display on the top view screen.
 - If the position or angle of each camera changes due to tilting of the vehicle, the image may appear distorted.
 - Lines on the road may appear distorted at the seams where each of the camera images merge.
 - The screen area for each camera may appear bright/dark depending on the illumination level around any of the cameras.

Viewing the screen

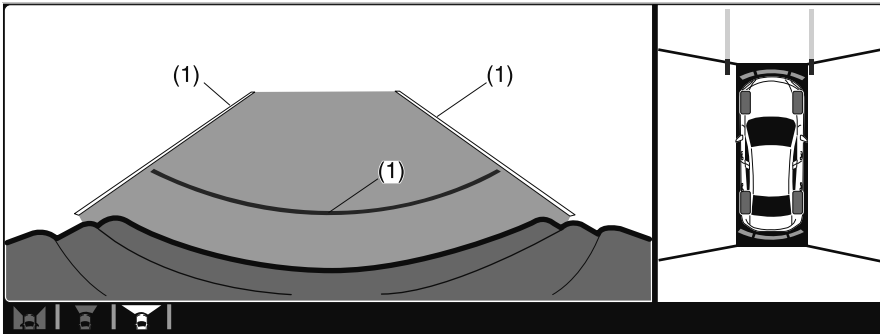

	Display/Icon	Content
(1)	Extended vehicle width lines and distance guide lines (blue & red)	Indicates the approximate width of the vehicle and the distance (from front end of bumper) in front of the vehicle. <ul style="list-style-type: none"> • The red lines indicate the points up to about 0.5 m (19 in) from the front end of the bumper.

NOTE

The front wide view screen displays the image in front of the vehicle at a wide angle and corrects the image to help detect approaching obstructions from the side. Therefore, it differs from the actual view.

▼ **Side View**

Use the side view to assist in checking the safety of the surrounding area when accelerating from a stop, parking, or stopping the vehicle.

Display range

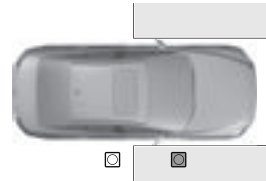
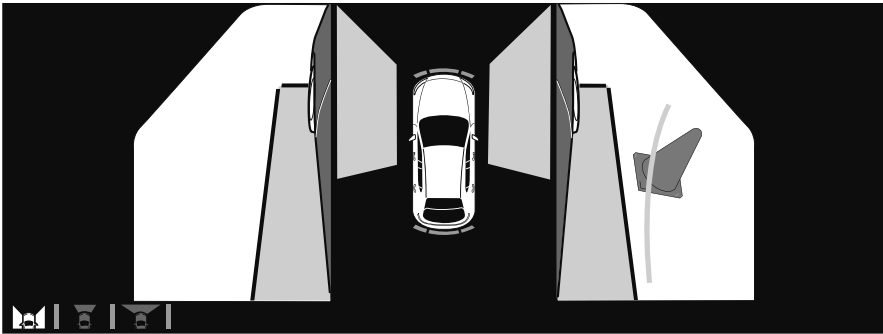

1. Target object

Viewing the screen

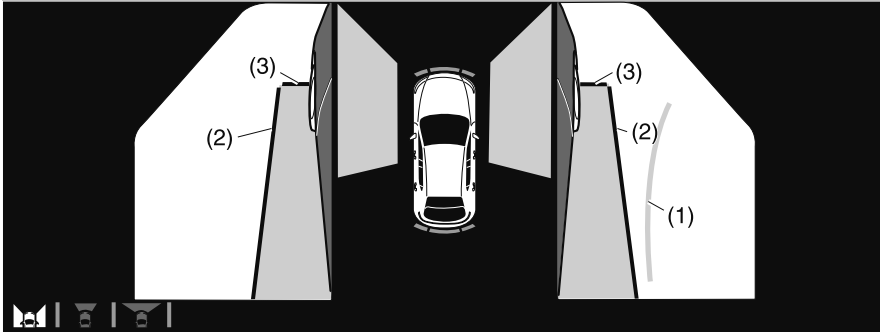

	Display/Icon	Content
(1)	Projected vehicle path lines (yellow)	Indicates the approximate projected path of the vehicle. Moves in conjunction with the steering wheel operation. The projected vehicle path lines (yellow) indicate the path the inner side of the vehicle is expected to travel.
(2)	Vehicle parallel guide lines (blue)	Indicates the approximate vehicle width including the door mirrors.
(3)	Vehicle front end guide lines (blue)	Indicates the point about 0.25 m (9.84 in) from the front edge of the vehicle (front edge of the bumper).

NOTE

The setting can be changed so that the projected vehicle path lines are not displayed.

Refer to the Settings section in the Mazda Connect Owner's Manual.

How to use the projected vehicle path line function

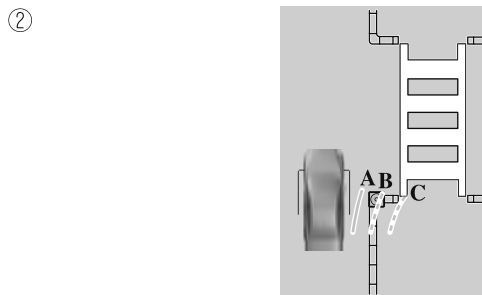
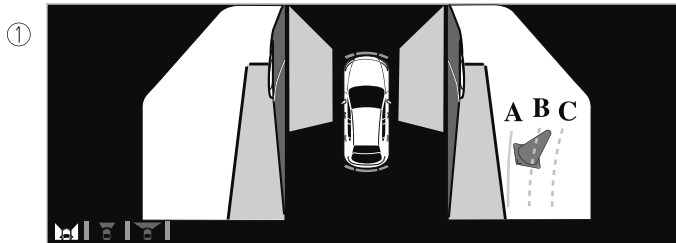

1. (Screen display)
2. (Actual condition)

Make sure that there are no obstructions within the projected vehicle path lines. Turn the steering wheel so that the projected vehicle path lines travel inside of the obstruction (A), and drive the vehicle forward until it passes the obstruction. If the projected vehicle path lines are on an obstruction (B) or outside of the obstruction (C), the vehicle may contact the obstruction when turning the vehicle sharply.

CAUTION

- The parking sensor detection range has limitations. For example, obstructions closing in from the side and objects short in height may not be detected. Always confirm the safety around the vehicle visually when driving. For details, refer to the parking sensor obstruction detection indication and warning sound. Refer to Parking Sensor System on page 4-238.
- Do not turn the steering wheel any more until the vehicle has passed the obstruction, even if the obstruction is not visible on the side view image. If the steering wheel is turned even more, the vehicle may contact the obstruction if it is turned sharply.

NOTE

- Because there might be a difference between the image displayed on the screen and the actual conditions, always check the safety of the surrounding area using the mirrors and directly with your eyes when driving.
- Even though the object displayed on the screen, such as a road curb or a division line of a parking space, and the vehicle parallel guide lines appear parallel, they may not actually be parallel.

▼ Top View/Rear View

Use the top view/rear view to assist in checking the safety of the surrounding area when accelerating from a stop, parking, or stopping the vehicle.

Range of displayed screen image

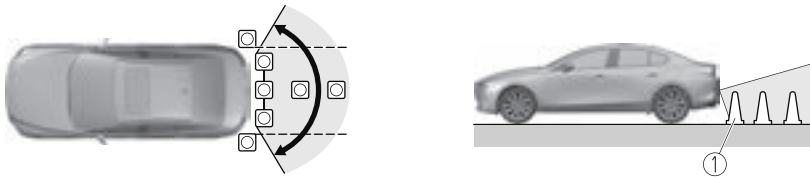
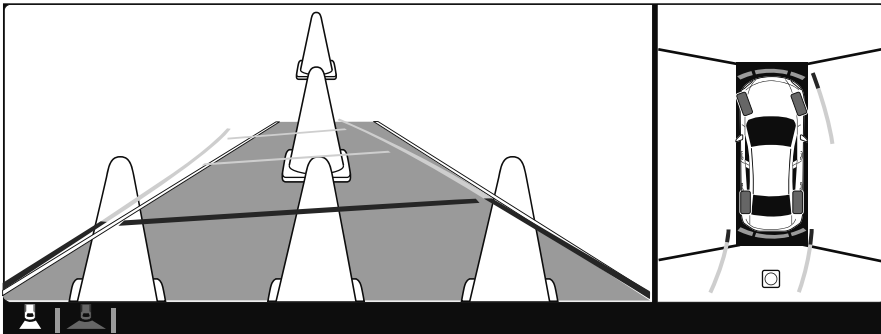

1. Target object

NOTE

- In the top view screen, the areas in black at the front and rear of the vehicle image and the seams where each of the camera images merge are blind spots.
- Because images displayed in the top view screen are processed from each camera, the top view screen may display in the following ways.
 - If an image containing an object with a conspicuous color is picked up by any of the cameras, the screen area for each camera may be affected and it may display in that color.
 - Obstructions displayed in the rear view may not display on the top view screen.
 - If the position or angle of each camera changes due to tilting of the vehicle, the image may appear distorted.

- Lines on the road may appear distorted at the seams where each of the camera images merge.
- The screen area for each camera may appear bright/dark depending on the illumination level around any of the cameras.

Viewing the screen

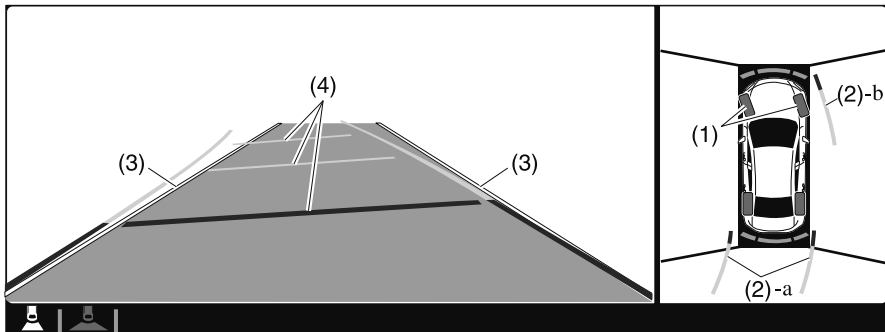

	Display/Icon	Content
(1)	Tire icon	Indicates the tire direction. Moves in conjunction with the steering wheel operation.
(2)	Projected vehicle path lines (yellow & red)	Indicates the approximate projected path of the vehicle. Moves in conjunction with the steering wheel operation. a) Indicates the path where the edge of the rear bumper is expected to travel. b) Indicates the path where the outer side of the vehicle is expected to travel.
(3)	Extended vehicle width lines (blue)	These guide lines indicate the approximate width of the vehicle.
(4)	Projected vehicle path distance guide lines (yellow & red)	These guide lines indicate the approximate distance to a point measured from the rear of the vehicle (from the end of the bumper). <ul style="list-style-type: none"> · The red line indicates the point about 0.5 m (19 in) from the rear end of the bumper. · The yellow lines indicate the points about 1.0 m (39 in) and 2.0 m (78 in) from the rear end of the bumper.

NOTE

The setting can be changed so that the projected vehicle path lines are not displayed.

Refer to the Settings section in the Mazda Connect Owner's Manual.

How to use the projected vehicle path line function



- The front of the vehicle swings out wide when turning the steering wheel while reversing. Maintain sufficient distance between the vehicle and an obstruction.
- The parking sensor detection range has limitations. For example, obstructions closing in from the side and objects short in height may not be detected. Always confirm the safety around the vehicle visually when driving.
For details, refer to the parking sensor obstruction detection indication and warning sound.
Refer to Parking Sensor System on page 4-238.

NOTE

- Because there might be a difference between the image displayed on the screen, such as indicated in the following, and the actual conditions when parking, always check the safety at the rear of the vehicle and the surrounding area directly with your eyes.
 - Even though the back end of the parking space (or garage) displayed on the screen and distance guide lines appear parallel, they may not actually be parallel.
 - When parking in a space with a division line on only one side of the parking space, even though the division line and the vehicle width guide line appear parallel, they may not actually be parallel.
- The following shows an example of vehicle parking with the steering wheel turned to the left while backing up the vehicle. When backing into a parking space from the opposite direction, the steering operation is reversed.

1. Back the vehicle into the parking space by turning the steering wheel so that the vehicle enters the center of the parking space.

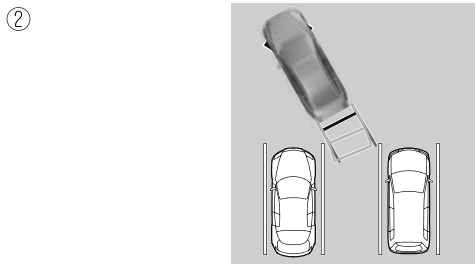
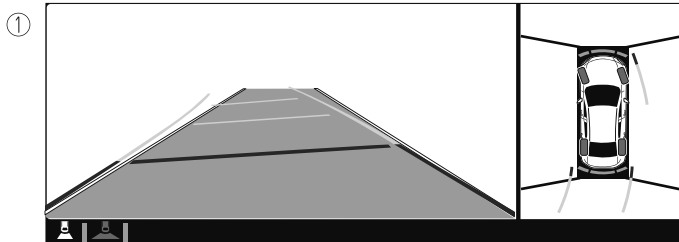

1. (Screen display)
 2. (Actual condition)
2. After the vehicle starts entering the parking space, stop and adjust the steering wheel so that the distance between the vehicle width lines and the sides of the parking space on the left and right are roughly equal, and then continue backing up slowly.

3. Once the vehicle width lines and the sides of the parking space on the left and right are parallel, straighten the wheels and back the vehicle slowly into the parking space. Continue checking the vehicle's surroundings and then stop the vehicle in the best possible position. (If the parking space has division lines, check whether the vehicle width guide lines are parallel to them.)

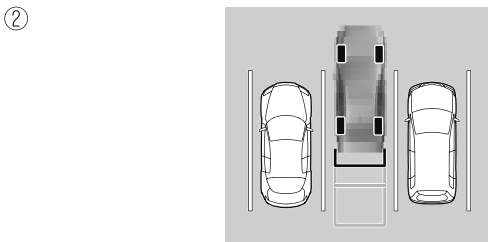
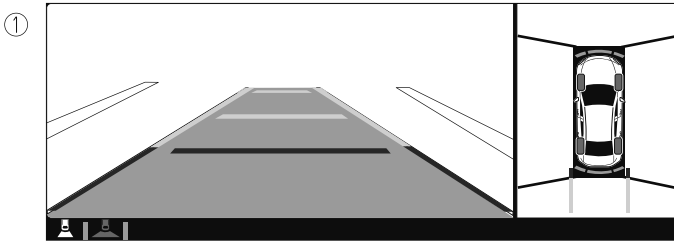

1. (Screen display)
2. (Actual condition)

▼ Top View/Rear Wide View

Use the top view/rear wide view to assist in checking the safety of the surrounding area when accelerating from a stop, parking, or stopping the vehicle.

Range of displayed screen image

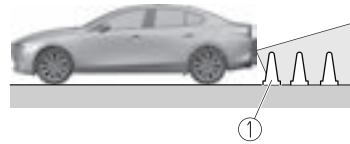
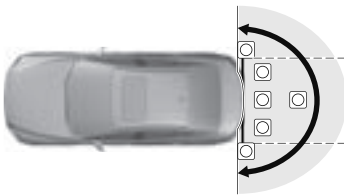
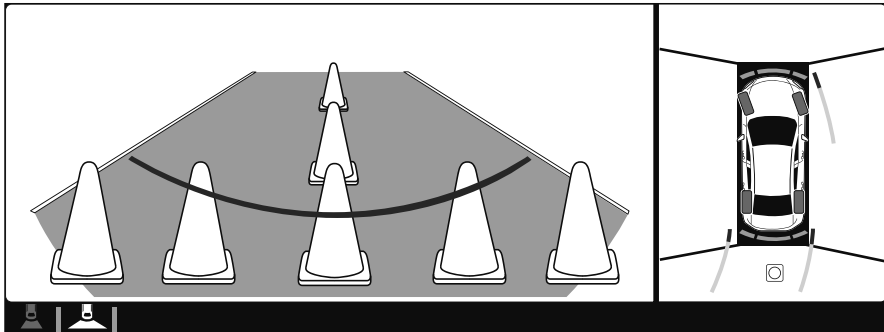

1. Target object

NOTE

- In the top view screen, the areas in black at the front and rear of the vehicle image and the seams where each of the camera images merge are blind spots.
- Because images displayed in the top view screen are processed from each camera, the top view screen may display in the following ways.
 - If an image containing an object with a conspicuous color is picked up by any of the cameras, the screen area for each camera may be affected and it may display in that color.
 - Obstructions displayed in the front view may not display on the top view screen.
 - If the position or angle of each camera changes due to tilting of the vehicle, the image may appear distorted.
 - Lines on the road may appear distorted at the seams where each of the camera images merge.
 - The screen area for each camera may appear bright/dark depending on the illumination level around any of the cameras.

Viewing the screen

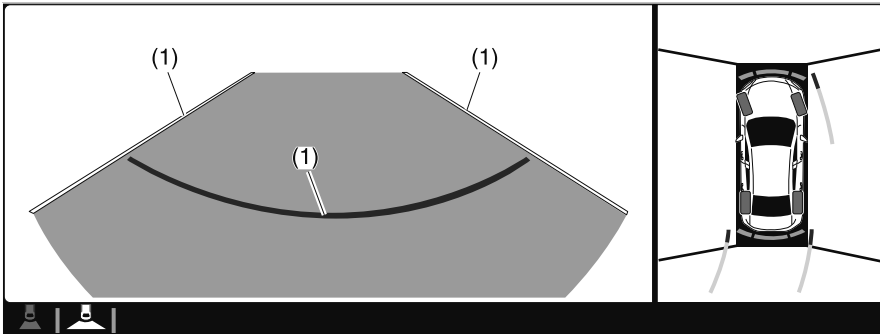

	Display/Icon	Content
(1)	Extended vehicle width lines and distance guide lines (blue & red)	<p>These guide lines indicate the approximate width of the vehicle and distance to a point measured from the rear of the vehicle (from the end of the bumper).</p> <ul style="list-style-type: none"> • The red lines indicate the points up to about 0.5 m (19 in) from the rear end of the bumper.

NOTE

The top view/rear wide view screen displays the image at the rear of the vehicle at a wide angle and corrects the image to help detect approaching obstructions from the side. Therefore, it differs from the actual view.

▼ **Margin of Error Between Road Surface on Screen and Actual Road Surface**

There might be some margin of error between the road surface appearing on the screen and the actual road surface. A margin of error in the perceived distance could lead to an accident, therefore be aware of the following conditions which can more easily produce errors in the perceived distance.

The vehicle tilts due to weight of passengers and cargo.

If the vehicle is tilted, obstructions picked up by a camera can appear farther or closer than the actual distance from the vehicle.

Front camera



1. Obstruction
2. Margin of error

Side camera

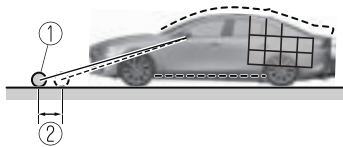

1. Obstruction
2. Margin of error

Rear camera



1. Obstruction
2. Margin of error

There is a steep up or down grade in the road at the front or rear of the vehicle

If there is a steep up or down grade in the road at the front or rear of the vehicle, obstructions picked up by the camera can appear farther or closer than the actual distance from the vehicle.

Front camera

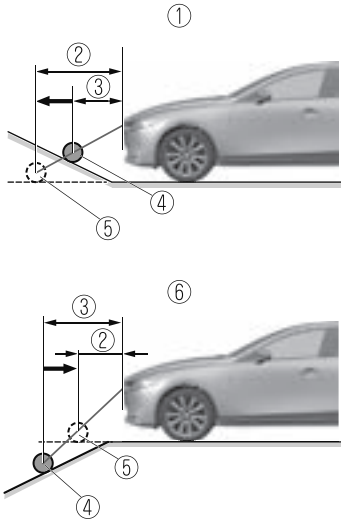

1. Appears further than actual distance
2. Distance of obstruction being viewed on screen
3. Actual distance of obstruction from vehicle
4. Actual obstruction
5. Obstruction appearing on screen
6. Appears closer than actual distance

Side camera

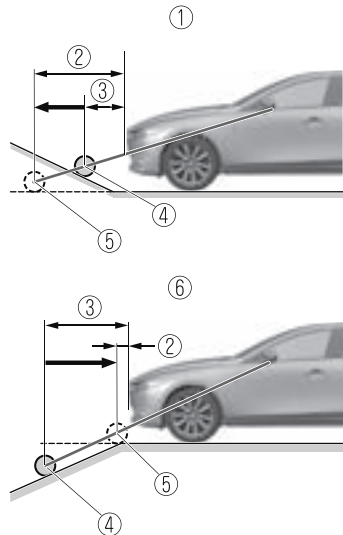

1. Appears further than actual distance
2. Distance of obstruction being viewed on screen
3. Actual distance of obstruction from vehicle
4. Actual obstruction
5. Obstruction appearing on screen
6. Appears closer than actual distance

Rear camera

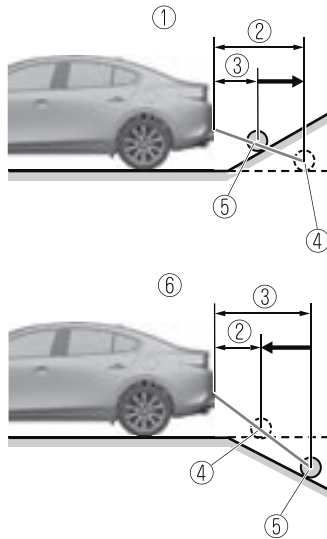

1. Appears further than actual distance
2. Distance of obstruction being viewed on screen
3. Actual distance of obstruction from vehicle
4. Obstruction appearing on screen
5. Actual obstruction
6. Appears closer than actual distance

NOTE

If the vehicle is on a slope, obstructions taken by the camera can appear farther or closer than the actual distance from the vehicle.

Three-dimensional object at vehicle front or rear

Because the vehicle front end guide lines (side camera) or the distance guide lines (rear camera) are displayed based on a flat surface, the distance to the three-dimensional object displayed on the screen is different from the actual distance.

Side camera

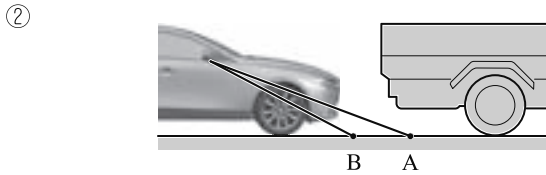
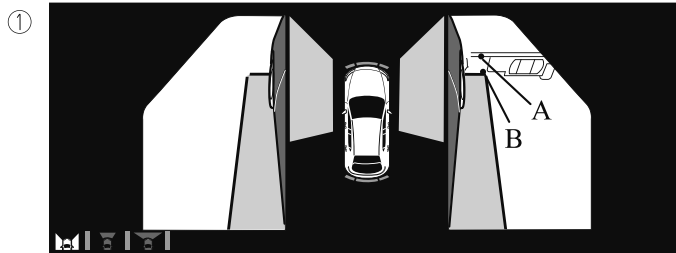

1. (Screen display)
2. (Actual condition)

Rear camera

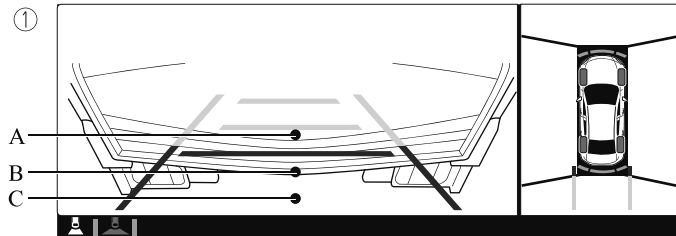

③



④

1. (Screen display)
2. (Actual condition)
3. Sensed distance on screen $A > B > C$
4. Actual distance $B > C = A$

▼ **System Problem Indication**

Center display indication	Cause	Action to be taken
"No camera signal." is displayed	The control unit might be damaged.	Have your vehicle inspected by an Authorized Mazda Dealer.
Screen is pitch-black and blank	The camera might be damaged.	

Forward Sensing Camera (FSC)*

▼ Forward Sensing Camera (FSC)

Your vehicle is equipped with a Forward Sensing Camera (FSC). The Forward Sensing Camera (FSC) is positioned near the rearview mirror and used by the following systems.

- High Beam Control System (HBC)
- Lane Departure Warning System (LDWS)
- Traffic Sign Recognition System (TSR)
- Distance & Speed Alert (DSA)
- Driver Attention Alert (DAA)
- Mazda Radar Cruise Control (MRCC)
- Mazda Radar Cruise Control with Stop & Go function (MRCC with Stop & Go function)
- Lane-keep Assist System (LAS)
- Traffic Jam Assist (TJA)
- Smart Brake Support (SBS)

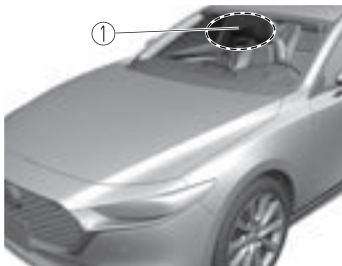

1. Forward Sensing Camera (FSC)

The Forward Sensing Camera (FSC) determines the conditions ahead of the vehicle while traveling at night and detects traffic lanes. The distance in which the Forward Sensing Camera (FSC) can detect objects varies depending on the surrounding conditions.

⚠ WARNING

Do not modify the suspension:

If the vehicle height or inclination is changed, the system will not be able to correctly detect vehicles ahead. This will result in the system not operating normally or mistakenly operating, which could cause a serious accident.

⚠ CAUTION

- Do not apply accessories, stickers or film to the windshield near the Forward Sensing Camera (FSC). If the area in front of the Forward Sensing Camera (FSC) lens is obstructed, it will cause the system to not operate correctly. Consequently, each system may not operate normally which could lead to an unexpected accident.
- Do not disassemble or modify the Forward Sensing Camera (FSC). Disassembly or modification of the Forward Sensing Camera (FSC) will cause a malfunction or mistaken operation. Consequently, each system may not operate normally which could lead to an unexpected accident.
- Heed the following cautions to assure the correct operation of the Forward Sensing Camera (FSC).
 - Be careful not to scratch the Forward Sensing Camera (FSC) lens or allow it to get dirty.

- Do not remove the Forward Sensing Camera (FSC) cover.
- Do not place objects on the dashboard which reflect light.
- Always keep the windshield glass around the camera clean by removing dirt or fogging. Use the windshield defroster to remove fogging on the windshield.
- Consult an Authorized Mazda Dealer regarding cleaning the interior side of the windshield around the Forward Sensing Camera (FSC).
- Consult an Authorized Mazda Dealer before performing repairs around the Forward Sensing Camera (FSC).
- The Forward Sensing Camera (FSC) is installed to the windshield. Consult an Authorized Mazda Dealer for windshield repair and replacement.
- When cleaning the windshield, do not allow glass cleaners or similar cleaning fluids to get on the Forward Sensing Camera (FSC) lens. In addition, do not touch the Forward Sensing Camera (FSC) lens.
- When performing repairs around the rearview mirror, consult an Authorized Mazda Dealer.
- Consult an Authorized Mazda Dealer regarding cleaning of the camera lens.
- Do not hit or apply strong force to the Forward Sensing Camera (FSC) or the area around it. If the Forward Sensing Camera (FSC) is severely hit or if there are cracks or damage caused by flying gravel or debris in the area around it, stop using the following systems and consult an Authorized Mazda Dealer.
 - High Beam Control System (HBC)
 - Lane Departure Warning System (LDWS)
 - Traffic Sign Recognition System (TSR)
 - Distance & Speed Alert (DSA)
 - Driver Attention Alert (DAA)
 - Mazda Radar Cruise Control (MRCC)
 - Mazda Radar Cruise Control with Stop & Go function (MRCC with Stop & Go function)
 - Lane-keep Assist System (LAS)
 - Traffic Jam Assist (TJA)
 - Smart Brake Support (SBS)
- The direction in which the Forward Sensing Camera (FSC) is pointed has been finely adjusted. Do not change the installation position of the Forward Sensing Camera (FSC) or remove it. Otherwise, it could result in damage or malfunction.
- Always use tires for all wheels that are of the specified size, and the same manufacturer, brand, and tread pattern. In addition, do not use tires with significantly different wear patterns on the same vehicle as the system may not operate normally.
- The Forward Sensing Camera (FSC) includes a function for detecting a soiled windshield and informing the driver, however, depending on the conditions, it may not detect plastic shopping bags, ice or snow on the windshield. In such cases, the system cannot accurately determine a vehicle ahead and may not be able to operate normally. Always drive carefully and pay attention to the road ahead.

NOTE

- In the following cases, the Forward Sensing Camera (FSC) cannot detect target objects correctly, and each system may be unable to operate normally.
 - The height of the vehicle ahead is low.
 - You drive your vehicle at the same speed as the vehicle ahead.
 - Headlights are not turned on during the night or when going through a tunnel.
- In the following cases, the Forward Sensing Camera (FSC) may not be able to detect target objects correctly.
 - Under bad weather condition, such as rain, fog and snow.
 - The window washer is being used or the windshield wipers are not used when it's raining.
 - Ice, fog, snow, frost, rainfall, dirt, or foreign matter such as a plastic bag is stuck on the windshield.
 - Trucks with low loading platforms and vehicles with an extremely low or high profile.
 - When driving next to walls with no patterning (including fences and longitudinally striped walls).
 - The taillights of the vehicle ahead are turned off.
 - A vehicle is outside the illumination range of the headlights.
 - The vehicle is making a sharp turn, or ascending or descending a steep slope.
 - Entering or exiting a tunnel.
 - Heavy luggage is loaded causing the vehicle to tilt.
- Strong light is shone at the front of the vehicle (back light or high-beam light from on-coming vehicles).
- There are many light emitters on the vehicle ahead.
- When the vehicle ahead is not equipped with taillights or the taillights are turned off at nighttime.
- Elongated luggage or cargo is loaded onto installed roof rails and covers the Forward Sensing Camera (FSC).
- Exhaust gas from the vehicle in front, sand, snow, and water vapor rising from manholes and grating, and water splashed into the air.
- When towing a malfunctioning vehicle.
- The vehicle is driven with tires having significantly different wear.
- The vehicle is driven on down slopes or bumpy roads.
- There are water puddles on the road.
- The surroundings are dark such as during the night, early evening, or early morning, or in a tunnel or indoor parking lot.
- The illumination brightness of the headlights is reduced or the headlight illumination is weakened due to dirt or a deviated optical axis.
- The target object enters the blind spot of the Forward Sensing Camera (FSC).
- A person or object bursts onto the road from the shoulder or cuts right in front of you.
- You change lanes and approach a vehicle ahead.
- When driving extremely close to the target object.

- Tire chains or a temporary spare tire is installed.
- The vehicle ahead has a special shape. For example, a vehicle towing a trailer house or a boat, or a vehicle carrier carrying a vehicle with its front pointed rearward.
- If the Forward Sensing Camera (FSC) cannot operate normally due to rain, backlight, or fog, the system functions related to the Forward Sensing Camera (FSC) are temporarily stopped and the following warning lights turn on. However, this does not indicate a malfunction.
 - High Beam Control System (HBC) warning indication/warning light (amber)
 - i-ACTIVSENSE warning indication/warning light
- If the Forward Sensing Camera (FSC) cannot operate normally due to high temperatures, the system functions related to the Forward Sensing Camera (FSC) are temporarily stopped and the following warning lights turn on. However, this does not indicate a malfunction. Cool down the area around the Forward Sensing Camera (FSC) such as by turning on the air conditioner.
 - High Beam Control System (HBC) warning indication/warning light (amber)
 - i-ACTIVSENSE warning indication/warning light
- If the Forward Sensing Camera (FSC) detects that the windshield is dirty or foggy, the system functions related to the Forward Sensing Camera (FSC) are temporarily stopped and the following warning lights turn on. However, this does not indicate a problem. Remove the dirt from the windshield or press the defroster switch and defog the windshield.
 - High Beam Control System (HBC) warning indication/warning light (amber)
 - i-ACTIVSENSE warning indication/warning light
- If there are recognizable cracks or damage caused by flying gravel or debris on the windshield, always have the windshield replaced. Consult an Authorized Mazda Dealer for replacement.
- The Forward Sensing Camera (FSC) recognizes pedestrians when all of the following conditions are met:
 - The height of a pedestrian is about 1 to 2 meters.
 - An outline such as the head, both shoulders, or the legs can be determined.
- In the following cases, the Forward Sensing Camera (FSC) may not be able to detect target objects correctly:
 - Multiple pedestrians are walking, or there are groups of people.
 - A pedestrian is close to a separate object.
 - A pedestrian is crouching, lying, or slouching.
 - A pedestrian suddenly jumps into the road right in front of the vehicle.
 - A pedestrian opens an umbrella, or is carrying large baggage or articles.

- A pedestrian is in a dark location such as during the night, or blends into the background by wearing clothes matching the background color.

Front Radar Sensor*

▼ Front Radar Sensor

Your vehicle is equipped with a front radar sensor.

The following systems also use the front radar sensor.

- Distance & Speed Alert (DSA)
- Mazda Radar Cruise Control (MRCC)
- Mazda Radar Cruise Control with Stop & Go function (MRCC with Stop & Go function)
- Traffic Jam Assist (TJA)
- Smart Brake Support (SBS)

The front radar sensor functions by detecting the radio waves reflected off a vehicle ahead or an obstruction sent from the radar sensor.

The front radar sensor is mounted behind the front emblem.

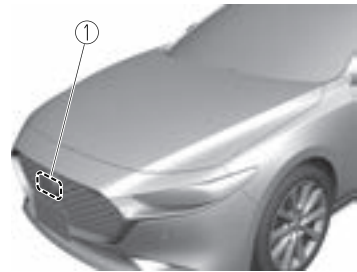

1. Front radar sensor

If "Safety and Driver Support Systems Temporarily Disabled. Front Radar Obscured. Drive Safely" is displayed on the multi-information display of the instrument cluster, clean the area around the front radar sensor.

⚠ CAUTION

Heed the following precautions to assure correct operation of each system.

- Do not adhere stickers (including transparent stickers) to the surface of the radiator grille and front emblem in and around the front radar sensor, and do not replace the radiator grille and front emblem with any product that is not a genuine product designed for use with the front radar sensor.
- The front radar sensor includes a function for detecting soiling of the radar sensor's front surface and informing the driver, however, depending on the conditions, it may require time to detect or it may not detect plastic shopping bags, ice or snow. If this occurs, the system may not operate correctly, therefore always keep the front radar sensor clean.
- Do not install a grille guard.
- If the front part of the vehicle has been damaged in a vehicle accident, the position of the front radar sensor may have moved. Stop the system immediately and always have the vehicle inspected at an Authorized Mazda Dealer.
- Do not use the front bumper to push other vehicles or obstructions such as when pulling out of a parking space. Otherwise, the front radar sensor could be hit and its position deviated.
- Do not remove, disassemble, or modify the front radar sensor.
- For repairs, replacement or paint work around the front radar sensor, consult an Authorized Mazda Dealer.
- Do not modify the suspensions. If the suspensions are modified, the vehicle's posture could change and the front radar sensor may not be able to correctly detect a vehicle ahead or an obstruction.

NOTE

- Under the following conditions, the front radar sensor may not be able to detect vehicles ahead or obstructions correctly and each system may not operate normally.
 - The rear surface of a vehicle ahead does not reflect radio waves effectively, such as an unloaded trailer or an automobile with a loading platform covered by a soft top, vehicles with a hard plastic tailgate, and round-shaped vehicles.
 - Vehicles ahead with low vehicle height and thus less area for reflecting radio waves.
 - Visibility is reduced due to a vehicle ahead casting off water, snow, or sand from its tires and onto your windshield.
 - The trunk/luggage compartment is loaded with heavy objects or the rear passenger seats are occupied.
 - Ice, snow, or soiling is on the front surface of the front emblem.
 - During inclement weather such as rain, snow, or sand storms.
 - When driving near facilities or objects emitting strong radio waves.
- Under the following conditions, the front radar sensor may not be able to detect vehicles ahead or obstructions.
 - The beginning and end of a curve.
 - Roads with continuous curves.
 - Narrow lane roads due to road construction or lane closures.
 - The vehicle ahead enters the radar sensor's blind spot.
 - The vehicle ahead is running abnormally due to accident or vehicle damage.

- Roads with repeated up and down slopes
- Driving on poor roads or unpaved roads.
- The distance between your vehicle and the vehicle ahead is extremely short.
- A vehicle suddenly comes close, such as by cutting into your lane.
- To prevent incorrect operation of the system, use tires of the same specified size, manufacturer, brand, and tread pattern on all four wheels. In addition, do not use tires with significantly different wear patterns or tire pressures on the same vehicle (Including the temporary spare tire).
- If the battery power is weak, the system may not operate correctly.
- When driving on roads with little traffic and few vehicles ahead or obstructions for the front radar sensor to detect, "Safety and Driver Support Systems Temporarily Disabled. Front Radar Obscured. Drive Safely" may be temporarily displayed, however, this does not indicate a problem.
- The radar sensors are regulated by the relevant radio wave laws of the country in which the vehicle is driven. If the vehicle is driven abroad, authorization from the country in which the vehicle is driven may be required.

Front Side Radar Sensor*

▼ Front Side Radar Sensor

Your vehicle is equipped with front side radar sensor. The following systems also use the front side radar sensor.

- Front Cross Traffic Alert (FCTA)

The front side radar sensor function by detecting the radio waves reflected off a vehicle approaching from the front or an obstruction sent from the radar sensor.



1. Front side radar sensor

The front side radar sensors are installed inside the front bumper, one on each side.

Always keep the surface of the front bumper near the front side radar sensors clean so that they operate normally. Also, do not apply items such as stickers.

Refer to Exterior Care on page 6-48.

⚠ CAUTION

If the front bumper receives a severe impact, the system may no longer operate normally. Stop the system immediately and have the vehicle inspected at an Authorized Mazda Dealer.

NOTE

- The detection ability of the front side radar sensor has limitations. In the following cases, the detection ability may lower and the system may not operate normally.
 - The front bumper near the front side radar sensor has become deformed.
 - Snow, ice or mud adheres to the front side radar sensor on the front bumper.
 - Under bad weather conditions such as rain, snow and fog.
 - Under the following conditions, the front side radar sensor cannot detect target objects or it may be difficult to detect them.
 - Small motorcycles, bicycles, pedestrians, animals, shopping carts, and stationary objects on a road or a road side.
 - Vehicle shapes which do not reflect radar waves well such as empty trailers with a low vehicle height and sports cars.
 - Vehicles are shipped with the direction of the front side radar sensor adjusted for each vehicle to a loaded vehicle condition so that the front side radar sensor detect approaching vehicles correctly. If the direction of the front side radar sensor has deviated for some reason, have the vehicle inspected at an Authorized Mazda Dealer.
 - For repairs or replacement of the front side radar sensor, or bumper repairs, paintwork, and replacement near the radar sensors, consult an Authorized Mazda Dealer.
- The radar sensors are regulated by the relevant radio wave laws of the country in which the vehicle is driven. If the vehicle is driven abroad, authorization from the country in which the vehicle is driven may be required.

Rear Side Radar Sensor*

▼ Rear Side Radar Sensor

Your vehicle is equipped with rear side radar sensor. The following systems also use the rear side radar sensor.

- Blind Spot Monitoring (BSM)
- Rear Cross Traffic Alert (RCTA)
- Smart Brake Support [Rear Crossing] (SBS-RC)

The rear side radar sensors emit radio waves and detect the radio waves reflected off a vehicle approaching from the rear or an obstruction.

4-Door



1. Rear side radar sensor

5-Door



1. Rear side radar sensor

The rear side radar sensors are installed inside the rear bumper, one on each side.

Always keep the surface of the rear bumper near the rear side radar sensors clean so that they operate normally. Also, do not apply items such as stickers.

Refer to Exterior Care on page 6-48.

⚠ CAUTION

If the rear bumper receives a severe impact, the system may no longer operate normally. Stop the system immediately and have the vehicle inspected at an Authorized Mazda Dealer.

NOTE

- The detection ability of the rear side radar sensor has limitations. In the following cases, the detection ability may lower and the system may not operate normally.
 - The rear bumper near the rear side radar sensor has become deformed.
 - Snow, ice or mud adheres to the rear side radar sensor on the rear bumper.
 - Under bad weather conditions such as rain, snow and fog.
- Under the following conditions, the rear side radar sensor cannot detect target objects or it may be difficult to detect them.
 - Small motorcycles, bicycles, pedestrians, animals, shopping carts, and stationary objects on a road or a road side.
 - Vehicle shapes which do not reflect radar waves well such as empty trailers with a low vehicle height and sports cars.

- Vehicles are shipped with the direction of the rear side radar sensor adjusted for each vehicle to a loaded vehicle condition so that the rear side radar sensor detect approaching vehicles correctly. If the direction of the rear side radar sensor has deviated for some reason, have the vehicle inspected at an Authorized Mazda Dealer.
- For repairs or replacement of the rear side radar sensor, or bumper repairs, paintwork, and replacement near the radar sensors, consult an Authorized Mazda Dealer.
- The radar sensors are regulated by the relevant radio wave laws of the country in which the vehicle is driven. If the vehicle is driven abroad, authorization from the country in which the vehicle is driven may be required.

Rear/Rear corner/Rear Side Ultrasonic Sensor*

▼ Rear/Rear corner/Rear Side Ultrasonic Sensor

The ultrasonic sensors function by emitting ultrasonic waves which are reflected off obstructions at the rear and the returning ultrasonic waves are picked up by the ultrasonic sensors.

4-Door

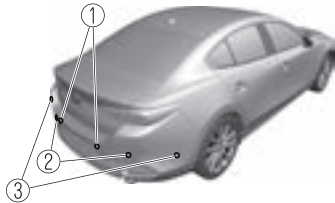

1. Rear ultrasonic sensor
2. Rear corner ultrasonic sensor
3. Rear side ultrasonic sensor

5-Door

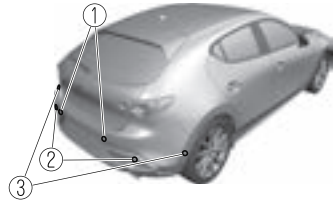

1. Rear ultrasonic sensor
2. Rear corner ultrasonic sensor
3. Rear side ultrasonic sensor

The ultrasonic sensors are mounted in the rear bumper.

Front Camera/Side Cameras/Rear Camera*

▼ Front Camera/Side Cameras/Rear Camera

Your vehicle is equipped with a front camera, side cameras, and a rear camera. The 360°View Monitor uses each camera.

Refer to 360°View Monitor on page 4-168.

The front camera, side cameras, and rear camera shoot images of the area surrounding the vehicle.

Each camera is installed to the following positions.

4-Door

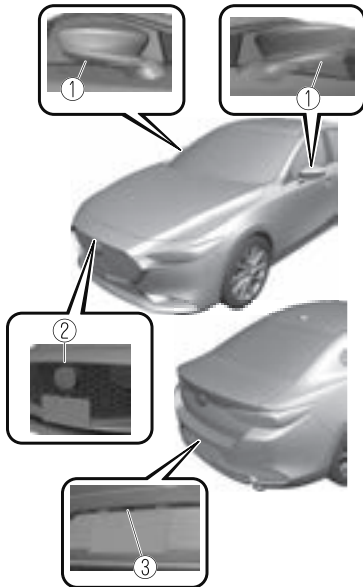

1. Side cameras
2. Front camera
3. Rear camera

5-Door

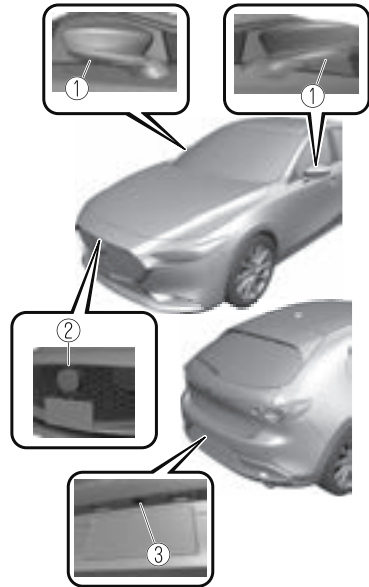

1. Side cameras
2. Front camera
3. Rear camera

Driver Monitoring Camera*

▼ Driver Monitoring Camera

The driver monitoring camera detects changes in the driver's facial features and estimates the amount of accumulated fatigue and sleepiness of the driver.



1. Driver monitoring camera

NOTE

- Driver Monitoring (DM) and the earlier collision warning may not operate normally under the following conditions.
 - The driver monitoring camera is covered with something.
 - You are driving the vehicle while leaning on the steering wheel.
 - You are wearing glasses or sunglasses.
 - A cap or hat you are wearing partially blocks the driver monitoring camera's view of your eyes, you have long bangs partially covering your eyes, or a part of your face is invisible due to a face mask.
 - The lighting conditions change significantly (such as backlight, light from the side, or direct light from the setting sun, and the headlights of on-coming vehicles).

- You are driving the vehicle with your head excessively tilted to one side or the other.
- You are moving around extensively.
- Your face or your eyes frequently turn in direction other than straight ahead (direction of travel).
- Your line of sight moves or directly after it has moved.
- There is a large difference between your line of sight and the direction your face is pointed.
- You are driving the vehicle with your head largely tilted to one side.

Cruise Control*

▼ Cruise Control

With cruise control, you can set and automatically maintain any speed of more than about 30 km/h (19 mph).

WARNING

Do not use the cruise control under the following conditions:

Using the cruise control under the following conditions is dangerous and could result in loss of vehicle control.

- Hilly terrain
- Steep inclines
- Heavy or unsteady traffic
- Slippery or winding roads
- Similar restrictions that require inconsistent speed

▼ Cruise Control Switch

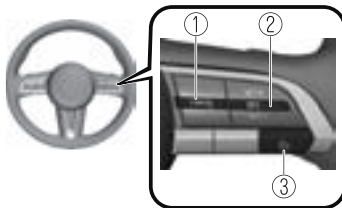

1. CANCEL switch
2. RES switch
3. Cruise switch

NOTE

If your Mazda has the following steering switch, your Mazda is equipped with the Mazda Radar Cruise Control (MRCC) system, the Mazda Radar Cruise Control with Stop & Go function (MRCC with Stop & Go function) system.

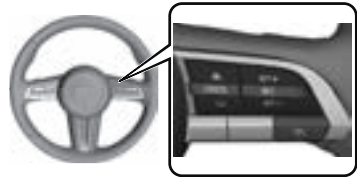

Refer to Mazda Radar Cruise Control (MRCC) on page 4-120.

Refer to Mazda Radar Cruise Control with Stop & Go function (MRCC with Stop & Go function) on page 4-128.

If the Mazda Radar Cruise Control (MRCC) or Mazda Radar Cruise Control with Stop & Go function (MRCC with Stop & Go function) is set to inoperable using the personalization feature, the system switches to the cruise control function. In this case, the MRCC functions as the cruise switch. In addition, this personalization feature setting is initialized by switching the ignition OFF, and it turns back on when the ignition is switched ON the next time.

▼ Cruise Standby Indication (White)/Cruise Set Indication (Green)

Cruise standby Indication (White)

The indication turns on (white) when the cruise control system is activated.



Cruise Control

Cruise Set Indication (Green)

The indication turns on (green) when a cruising speed has been set.



▼ Activation/Deactivation



Always turn off the cruise control system when it is not in use:

Leaving the cruise control system in an activation-ready state while the cruise control is not in use is dangerous as the cruise control could unexpectedly activate if the activation button is accidentally pressed, and result in loss of vehicle control and an accident.

NOTE

When the ignition is switched OFF, the system status before it was turned off is maintained. For example, if the ignition is switched OFF with the cruise control system operable, the system will be operable when the ignition is switched ON the next time.

Activation

To activate the system, press the cruise switch. The cruise standby indication (white) turns on.

Deactivation

To deactivate the system, press the cruise switch again.
The cruise standby indication (white) turns off.

▼ **To Set Speed**

1. Activate the cruise control system by pressing the cruise switch. The cruise standby indication (white) turns on.
2. Accelerate to the desired speed, which must be more than 25 km/h (16 mph).
3. Adjust the system to the desired vehicle speed using the accelerator pedal. Press the RES switch up (SET +) or down (SET-) to start cruise control. The cruise control indication (green) in the instrument cluster turns on at the same time. Quickly release the switch when the cruise control indication (green) turns on.

NOTE

- If the RES switch is operated up (SET +) or down (SET-) while the vehicle speed is between 25 and 30 km/h (16 to 19 mph), the set speed is set to 30 km/h (19 mph).
- The cruise control speed setting cannot be performed under the following conditions:
 - Any of the doors is opened.
 - The driver's seat belt is unfastened.
 - The brake pedal is depressed.
 - The parking brake is applied.
 - **(Automatic transmission)**
The selector lever is in the P, N, or R position.
 - **(Manual transmission)**
The shift lever is in the neutral position.
- On a steep grade, the vehicle may momentarily slow down while ascending or speed up while descending.

- The cruise control will cancel if the vehicle speed decreases below 20 km/h (12 mph) when the cruise control is activated, such as when climbing a steep grade.

The vehicle speed preset using the cruise control is displayed in the instrument cluster and the active driving display (vehicles with active driving display).

Instrument cluster (Basic display)

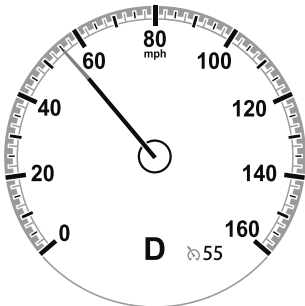

Instrument cluster (i-ACTIVSENSE display)

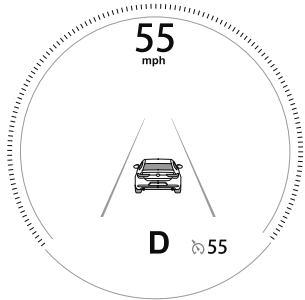

Active driving display

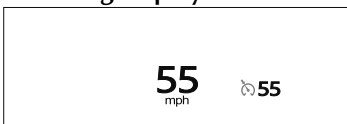

▼ Changing the Set Vehicle Speed

Follow either of these procedures.

To increase/decrease speed using cruise control switch

When the RES switch is pressed up (SET+), the vehicle accelerates and when the RES switch is pressed down (SET-), it decelerates.

- Press and release immediately: 1 km/h (1 mph)
- Press and hold: 10 km/h (5 mph)

NOTE

Even after releasing the RES switch, the cruise control accelerates/decelerates continuously until the set speed displayed in the instrument cluster and on the active driving display is reached. If you want to stop accelerating/decelerating, change the set speed or cancel the system (such as by depressing the brake pedal).

To increase speed using accelerator pedal

Depress the accelerator pedal and press the RES switch up (SET+) or down (SET-) at the desired speed. If the switch is not operated, the system returns to the set speed after you release your foot from the accelerator pedal.

NOTE

Accelerate if you want to speed up temporarily when the cruise control is on. Greater speed will not interfere with or change the set speed. Take your foot off the accelerator to return to the set speed.

Cruise Control

▼ To Resume Cruising Speed at More Than 30 km/h (19 mph)

If the cruise control system is temporarily canceled (such as by applying the brake pedal) and the system is still activated, the most recent set speed will automatically resume when the RES switch is pressed.

If vehicle speed is below 30 km/h (19 mph), increase the vehicle speed up to 30 km/h (19 mph) or more and press the RES switch.

▼ To Temporarily Cancel

To temporarily cancel the system, use one of these methods:

- Slightly depress the brake pedal.
- Press the CANCEL switch.
- **(Manual transmission)**
Depress the clutch pedal.

If the RES switch is pressed when the vehicle speed is 30 km/h (19 mph) or higher, the system reverts to the previously set speed.

NOTE

- If any of the following conditions occur, the cruise control system is temporarily canceled.
 - Even when the brake pedal is slightly depressed.
 - The DSC is operating.
 - There is a problem in the system.
 - Any of the doors is opened.
 - The driver's seat belt is unfastened.
 - The parking brake is applied.
 - **(Automatic transmission)**
The selector lever is in the P, N, or R position.
 - **(Manual transmission)**
The shift lever is in the neutral position.
- When the cruise control system is temporarily canceled by even one of the applicable cancel conditions, the speed cannot be re-set.
- **(Automatic transmission)**
The cruise control cannot be canceled while driving in manual mode (selector lever shifted from D to M position). Therefore, engine braking will not be applied even if the transmission is shifted down to a lower gear. If deceleration is required, lower the set speed or depress the brake pedal.

▼ To Deactivate

Press the cruise switch again.

Tire Pressure Monitoring System (TPMS)

Tire Pressure Monitoring System (TPMS)

▼ Tire Pressure Monitoring System (TPMS)

The TPMS monitors the air pressure of each tire and if it decreases below the specified value, the system notifies the driver by turning on the TPMS warning light in the instrument cluster and indicating a message on the multi-information display.

For the TPMS, the air pressure data sent from the tire pressure sensors installed on each wheel via radio signal is received by the receiver unit in the vehicle to monitor the tire pressures.

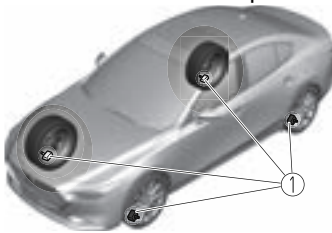

1. Tire pressure sensors

In addition, the current tire pressures can be checked using the center display.

Refer to the Vehicle Status Monitor section in the Mazda Connect Owner's Manual.

NOTE

- When the ambient temperature is low, the tire temperatures also decrease. If the tire temperatures decrease, the air pressure in the tires will also decrease which could turn on the TPMS warning light.

- Before driving, visually inspect the tires for abnormalities. Additionally, inspect the tire pressures monthly. A digital type air pressure gauge is recommended for inspecting the tire pressures.

The TPMS is not a substitute for your own periodic inspection of the tires. Always inspect the tires yourself periodically.

⚠ CAUTION

- Each tire, including the spare (if provided), should be checked monthly when cold and inflated to the inflation pressure recommended by the vehicle manufacturer on the vehicle placard or tire inflation pressure label. (If your vehicle has tires of a different size than the size indicated on the vehicle placard or tire inflation pressure label, you should determine the proper tire inflation pressure for those tires.) As an added safety feature, your vehicle has been equipped with a tire pressure monitoring system (TPMS) that illuminates a low tire pressure telltale when one or more of your tires is significantly under-inflated. Accordingly, when the low tire pressure telltale illuminates, you should stop and check your tires as soon as possible, and inflate them to the proper pressure. Driving on a significantly under-inflated tire causes the tire to overheat and can lead to tire failure. Under-inflation also reduces fuel efficiency and tire tread life, and may affect the vehicle's handling and stopping ability.

Tire Pressure Monitoring System (TPMS)

Please note that the TPMS is not a substitute for proper tire maintenance, and it is the driver's responsibility to maintain correct tire pressure, even if under-inflation has not reached the level to trigger illumination of the TPMS low tire pressure telltale.

Your vehicle has also been equipped with a TPMS malfunction indicator to indicate when the system is not operating properly.

The TPMS malfunction indicator is combined with the low tire pressure telltale. When the system detects a malfunction, the telltale will flash for approximately one minute and then remain continuously illuminated.

This sequence will continue upon subsequent vehicle start-ups as long as the malfunction exists. When the malfunction indicator is illuminated, the system may not be able to detect or signal low tire pressure as intended. TPMS malfunctions may occur for a variety of reasons, including the installation of replacement or alternate tires or wheels on the vehicle that prevent the TPMS from functioning properly. Always check the TPMS malfunction telltale after replacing one or more tires or wheels on your vehicle to ensure that the replacement or alternate tires and wheels allow the TPMS to continue to function properly.

- To avoid false readings, the system samples for a little while before indicating a problem. As a result it will not instantaneously register a rapid tire deflation or blow out.

▼ If there is a problem with the Tire Pressure Monitoring System (TPMS)

If the TPMS warning light flashes, there may be a problem with the system. Consult an Authorized Mazda Dealer to have the system inspected.

Refer to Tire Pressure Monitoring System (TPMS) Warning Indication/Warning Light (Flashing) on page 7-33.

In the following cases, the system cannot recognize the tire pressures correctly and the TPMS warning light may flash.

- There is equipment or a device nearby emitting radio signals the same as a tire pressure sensor.
- A metallic object such as a non-genuine electronic device is installed near the center of the dashboard (obstructs the radio signals from the tire pressure sensors to the receiver).
- A device such as one of the following is used in the cabin.
 - Electronic devices such as a computer.
 - Converter devices such as a DC-AC converter.
- There is a large accumulation of snow or ice around the vehicle tires.
- The battery in a tire pressure sensor is dead.
- A wheel not equipped with a tire pressure sensor is used.
- Tires employing steel in the sidewall of the tire are installed.
- Tire chains are used.

Tire Pressure Monitoring System (TPMS)

▼ When a tire pressure decreases

If the TPMS warning light turns on, a tire pressure may be low. Inspect the tire pressures and adjust them to the correct inflation pressure.

Refer to Tire Pressure Monitoring System (TPMS) Warning Indication/Warning Light (Turns on) on page 7-37.

▼ Tires and Wheels



When inspecting/adjusting the tire pressures, do not apply excessive force to the air valve of the tire pressure sensor. Otherwise, the tire pressure sensor could be damaged.

When changing tires and wheels

When changing the tires or wheels (such as installing winter tires), it will be necessary to register the ID signal code of the tire pressure sensor to the TPMS.

Have an Authorized Mazda Dealer do the registration or register the ID signal codes of the tire pressure sensors using the following procedure.

NOTE

The tire pressure sensors on each wheel have a unique ID signal code. For the TPMS to operate correctly, the ID signal codes of the tire pressure sensors need to be registered to the system.

1. Wait more than 19 minutes after changing a tire or wheel.

2. After more than 19 minutes have passed, drive the vehicle at a speed of about 25 km/h (16 mph) or faster for 3 minutes or longer. While driving, the ID signal codes of the tire pressure sensors are automatically registered.

NOTE

If you drive the vehicle within 19 minutes of changing a tire or wheel, the TPMS warning light will flash because the ID signal codes for the tire pressure sensors were not registered. In this case, stop the vehicle and register the ID signal codes of the tire pressure sensors following the procedure.

When replacing tires and wheels



- When replacing the tires and wheels, consult an Authorized Mazda Dealer. Otherwise, the tire pressure sensors could be damaged when replacing them.
- Do not install non-genuine wheels. If wheels other than genuine ones are installed, it may not be possible to install the tire pressure sensors.

When replacing a tire or wheel, always install the tire pressure sensor. The following combinations of tires, wheels, or tires and wheels are possible.

- The tire pressure sensor from the old wheel is removed and it is installed to the new wheel.
- Only a tire is replaced without replacing the tire pressure sensor and wheel.
- A new tire pressure sensor is installed to a new wheel.

Tire Pressure Monitoring System (TPMS)

NOTE

When installing a new tire pressure sensor, the ID signal code for the tire pressure sensor needs to be registered. For details on purchasing a tire pressure sensor and registering the ID signal of the tire pressure sensor, consult an Authorized Mazda Dealer.

Rear View Monitor*

▼ Rear View Monitor

The rear view monitor provides visual images of the rear of the vehicle when reversing.

WARNING

Always drive carefully confirming the safety of the rear and the surrounding conditions by looking directly with your eyes:

Reversing the vehicle by only looking at the screen is dangerous as it may cause an accident or a collision with an object. The rear view monitor is only a visual assist device when reversing the vehicle. The images on the screen may be different from the actual conditions.

CAUTION

- Do not use the rear view monitor under the following conditions:
Using the rear view monitor under the following conditions is dangerous and could result in injury or vehicle damage or both.
 - Icy or snow-covered roads.
 - Tire chains or a temporary spare tire is installed.
 - The vehicle is on a road incline.
- When the display is cold, images may course across the monitor or the screen and may be dimmer than usual, which could cause difficulty in confirming the surrounding conditions of the vehicle. Always drive carefully confirming the safety of the rear and the surrounding conditions by looking directly with your eyes.

- Do not apply excessive force to the camera. The camera position and angle may deviate.
- Do not disassemble, modify, or remove it as it may no longer be waterproof.
- The camera cover is made of plastic. Do not apply degreasing agents, organic solvents, wax, or glass coating agents to the camera cover. If any are spilled on the cover, wipe off with a soft cloth immediately.
- Do not rub the camera cover forcefully with an abrasive or hard brush. The camera cover or lens may be scratched which might affect the images.

NOTE

- If water, snow, or mud is stuck on the camera lens, wipe it off using a soft cloth. If it cannot be wiped off, use a mild detergent.
- If the camera temperature changes rapidly (Hot to cold, cold to hot), the rear view monitor may not operate correctly.
- When replacing the tires, consult an Authorized Mazda Dealer. Replacing the tires could result in deviation of the guide lines which appear on the display.
- If the vehicle's front, side, or rear has been involved in a collision, the alignment of the rear view parking camera (location, installation angle) may have deviated. Always consult an Authorized Mazda Dealer to have the vehicle inspected.
- If "No camera signal." is indicated in the display, there could be a problem with the camera. Have your vehicle inspected at an Authorized Mazda Dealer.

Rear View Monitor

· **(Predicted vehicle path assist lines display type)**

If force is applied to the steering wheel, the guide lines may not display. Loosen your grip on the steering wheel to allow the guide lines to display.

▼ **Rear View Parking Camera Location**

4-Door



1. Rear view parking camera

5-Door



1. Rear view parking camera

▼ Switching to the Rear View Monitor Display

Shift the shift lever (manual transmission) or the selector lever (automatic transmission) to reverse (R) position with the ignition switched ON to switch the display to the rear view monitor display.

NOTE

When the shift lever (manual transmission) or the selector lever (automatic transmission) is shifted from reverse (R) position to another shift lever (manual transmission) or the selector lever (automatic transmission) position, the screen returns to the previous display.

▼ Displayable Range on the Screen

The images on the screen may be different from the actual conditions.

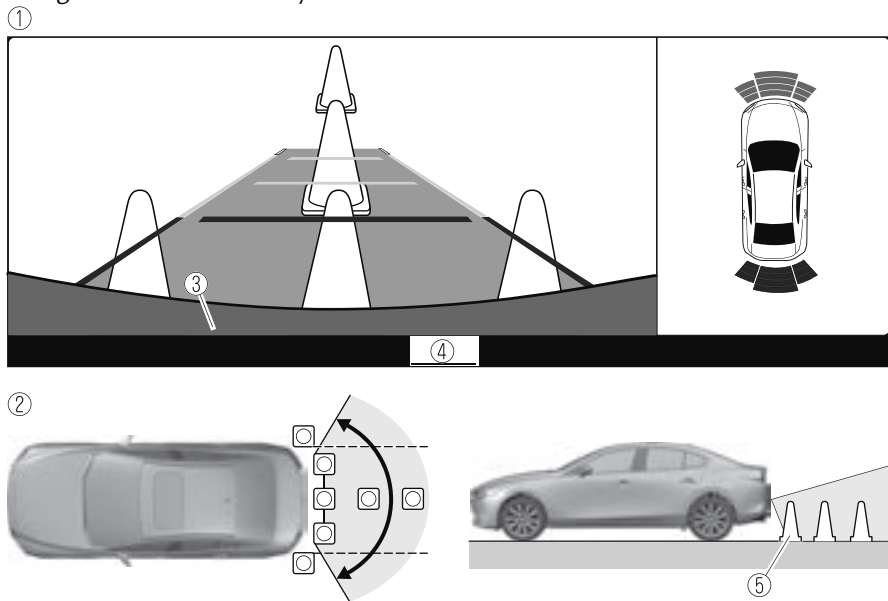

1. (Screen display)
2. (Actual view)
3. Bumper
4. "Check surroundings for safety." message is displayed
5. Object

NOTE

- The displayable range varies depending on the vehicle and road conditions.
- If the camera lens is touched or there is any dirt on it, it could affect the screen image. Wipe the lens using a soft cloth.
- The displayable range is limited. Objects under the bumper or around the bumper ends cannot be displayed.

Rear View Monitor

- The distance appearing in the displayed image is different from the actual distance because the rear view parking camera is equipped with a specific lens.
- Images displayed on the monitor from the rear view parking camera are reversed images (mirror images).
- Some optionally installed vehicle accessories may be picked up by the camera. Do not install any optional parts that can interfere with the camera view, such as illuminating parts or parts made of reflective material.
- It may be difficult to see the display under the following conditions, however, it does not indicate a malfunction.
 - In darkened areas.
 - When the temperature around the lens is high/low.
 - When the camera is wet such as on a rainy day or during periods of high humidity.
 - When foreign material such as mud is stuck around the camera.
 - When the camera lens reflects sunlight or headlight beams.
 - The surroundings are illuminated by vehicle lights, fluorescent lights, or LED lights (display may flicker).
 - Extremely small dark or white dots appear on the screen (dots may flicker).
- Image display may be delayed if the temperature around the camera is low.

▼ Viewing the Display

Predicted vehicle path assist lines display type

The projected path guidance mode displays the predicted path of the vehicle after you turn the steering wheel.

Use this mode for parking your vehicle in a parking space or garage.

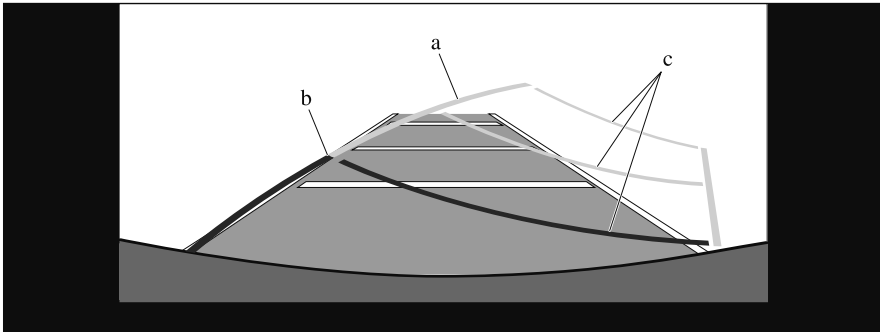

- a) Projected vehicle path (yellow)
These lines are displayed as a reference for the projected path of the vehicle. The lines displaying the projected vehicle path change after you turn the steering wheel.
- b) Extended vehicle width lines (blue)
These lines indicate the vehicle's extended width. These lines are not displayed when the vehicle's wheels are in the straight-ahead position.

c) Distance guide lines (red)

These lines indicate the approximate distance to a point measured from the vehicle's rear (from the end of the bumper).

The blue line indicates the point about 0.5 m (19 in) from the rear bumper.

The red and yellow lines, which change position after you turn the steering wheel, indicate the points about 0.5 m (19 in) for the red line and 1.0 m (39 in) and 2.0 m (78 in) for the yellow lines from the rear bumper (at the center point of each of the lines).

A degree of error occurs when the wheels are not in the straight-ahead position.

In the above illustration, the right side of the vehicle is in a position closer to the actual distance displayed by the distance guide lines (red: about 0.5 m (19 in) point, yellow: about 1.0 m (39 in), and yellow: about 2.0 m (78 in) point behind the rear bumper), whereas the left side is in a position farther away.

⚠ CAUTION

The indicated position of the guide lines on the display changes depending on the vehicle conditions (such as the number of occupants/cargo load) and the road conditions (such as a steep gradient to the rear of the vehicle).

Always check the area to the vehicle's rear and the surrounding area directly with your eyes while backing up.

Fixed assist lines display type

Guide lines which indicate the width of the vehicle are displayed on the screen as a reference to the approximate width of the vehicle in comparison to the width of the parking space you are about to back into.

Use this display view for parking your vehicle in a parking space or garage.

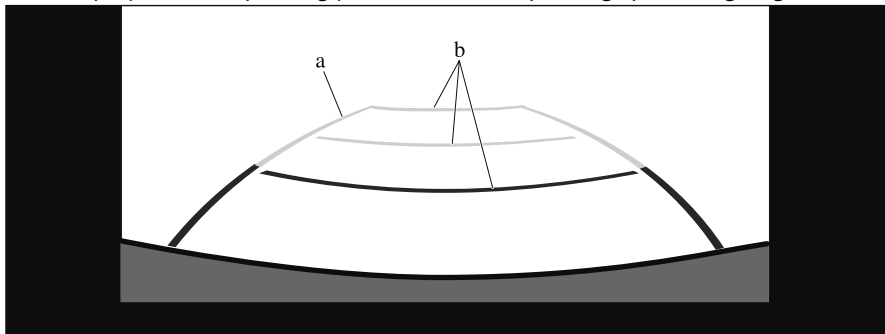

a) Vehicle width guide lines

Guide lines serve as a reference to the approximate width of the vehicle.

Rear View Monitor

b) Distance guide lines

These guide lines indicate the approximate distance to a point measured from the vehicle's rear (from the end of the bumper).

The red line indicates the point about 0.5 m (19 in) from the rear bumper.

The yellow lines indicate the points about 1.0 m (39 in) and 2.0 m (78 in) from the rear bumper.



The guide lines on the screen are fixed lines. They are not synced to the driver's turning of the steering wheel. Always be careful and check the area to the vehicle's rear and the surrounding area directly with your eyes while backing up.

▼ Rear View Monitor Operation

The operation of the rear view monitor when reversing the vehicle varies depending on the traffic, road, and vehicle conditions. The amount of steering and the timing also varies depending on conditions, so confirm the surrounding conditions directly with your eyes and steer the vehicle in accordance with the conditions.

Be well aware of the above cautions prior to using the rear view monitor.

Predicted vehicle path assist lines display type

NOTE

The following shows an example of vehicle parking in which the steering wheel is turned to the right when backing up the vehicle. The operation is reversed when backing up the vehicle from the opposite direction.

1. Shift the shift lever (manual transmission) or the selector lever (automatic transmission) to reverse (R) position to switch the display to the rear view monitor display.

2. Before backing the vehicle into the parking space, turn the steering wheel while referring to the projected vehicle path display so that the vehicle enters the center of the parking space.

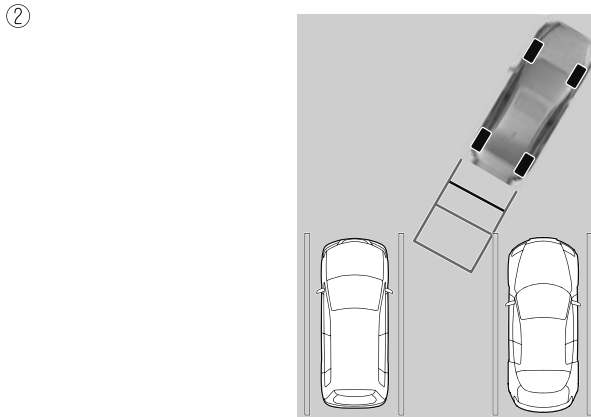
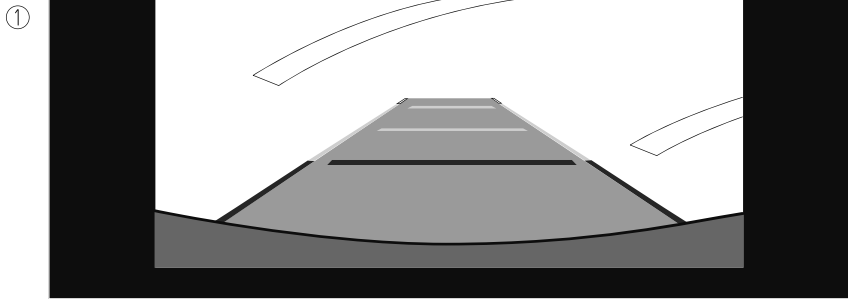

1. (Display condition)
2. (Vehicle condition)

Rear View Monitor

3. After your vehicle begins entering the parking space, continue backing up slowly so that the distance between the vehicle width lines and the sides of the parking space on the left and right are roughly equal.

①

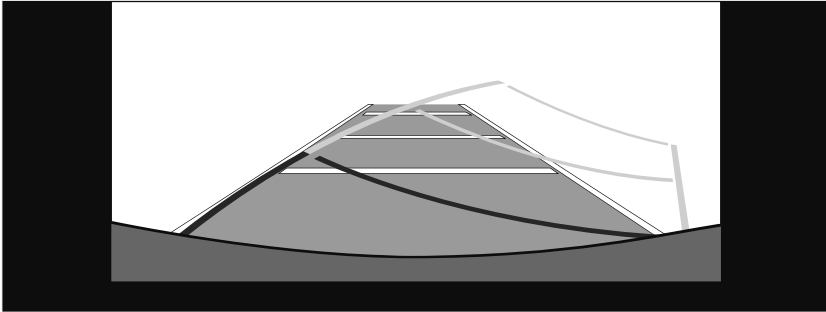

②

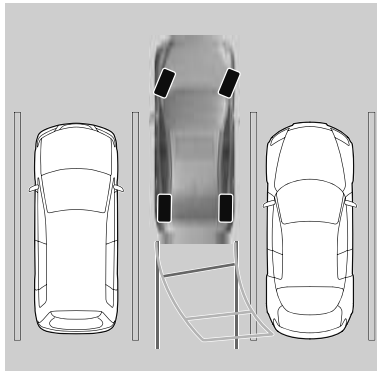

1. (Display condition)
 2. (Vehicle condition)
4. Continue to adjust the steering wheel until the vehicle width guide lines are parallel to the left and right sides of the parking space.

5. Once they are parallel, straighten the wheels and back your vehicle slowly into the parking space. Continue checking the vehicle's surroundings and then stop the vehicle in the best possible position. (If the parking space has division lines, check whether the vehicle width guide lines are parallel to them.)

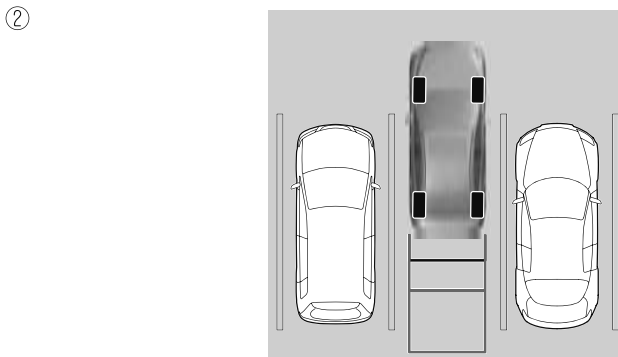
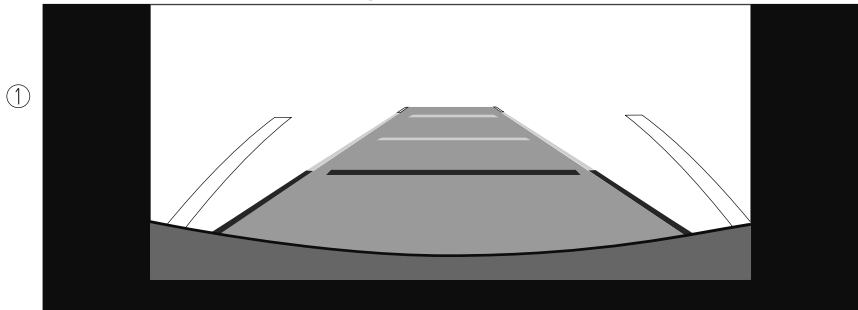

1. (Display condition)
 2. (Vehicle condition)
6. When the shift lever (manual transmission) or the selector lever (automatic transmission) is shifted from reverse (R) position to another shift lever (manual transmission) or the selector lever (automatic transmission) position, the screen returns to the previous display.

NOTE

Because there may be a difference between the displayed image, such as indicated below, and the actual conditions when parking, always verify the safety at the rear of the vehicle and the surrounding area directly with your eyes.

- In the image of the parking space (or garage) displayed on the screen, the back end and distance guide lines may appear aligned in the monitor, but they may not actually be aligned on the ground.

Rear View Monitor

- When parking in a space with a division line on only one side of the parking space, the division line and the vehicle width guide line appear aligned in the monitor, but they may not actually be aligned on the ground.

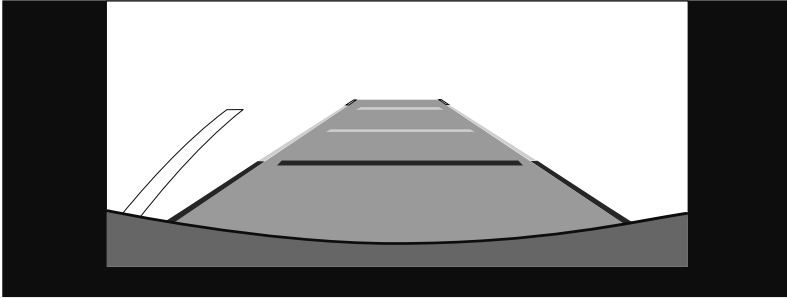

Fixed assist lines display type

NOTE

Images displayed on the monitor from the rear view parking camera are reversed images (mirror images).

1. Shift the shift lever (manual transmission) or the selector lever (automatic transmission) to reverse (R) position to switch the display to the rear view monitor display.
2. Confirming the surrounding conditions, reverse the vehicle.

3. After your vehicle begins entering the parking space, continue backing up slowly so that the distance between the vehicle width lines and the sides of the parking space on the left and right are roughly equal.

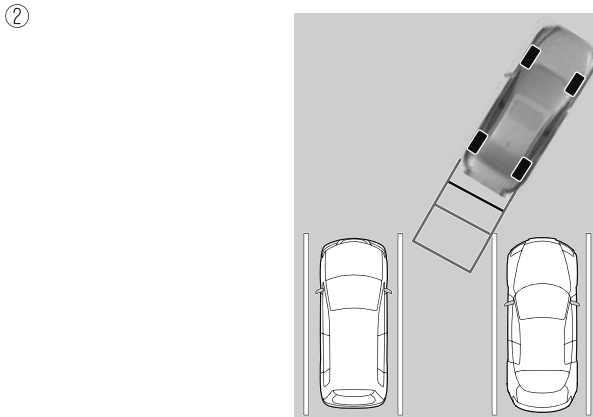
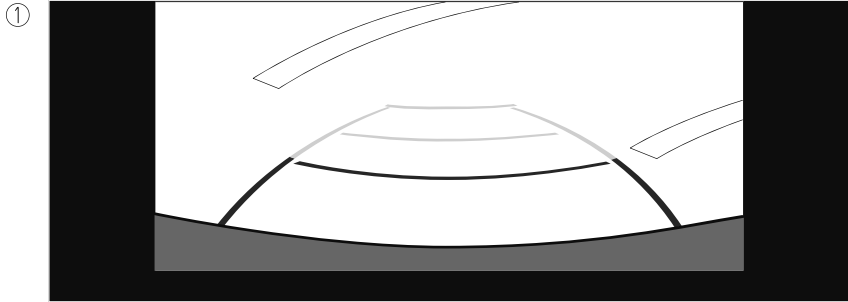

1. (Display condition)
2. (Vehicle condition)
4. Continue to adjust the steering wheel until the vehicle width guide lines are parallel to the left and right sides of the parking space.

Rear View Monitor

5. Once they are parallel, straighten the wheels and back your vehicle slowly into the parking space. Continue checking the vehicle's surroundings and then stop the vehicle in the best possible position. (If the parking space has division lines, check whether the vehicle width guide lines are parallel to them.)

①

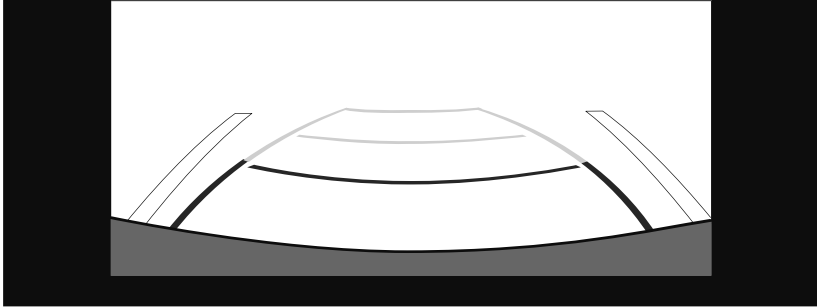

②

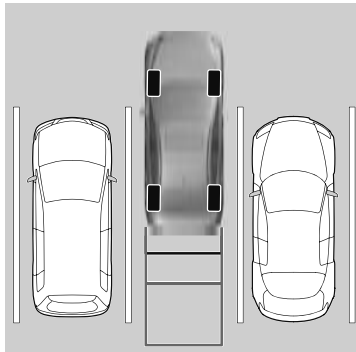

1. (Display condition)
2. (Vehicle condition)

6. When the shift lever (manual transmission) or the selector lever (automatic transmission) is shifted from reverse (R) position to another shift lever (manual transmission) or the selector lever (automatic transmission) position, the screen returns to the previous display.

NOTE

Because there may be a difference between the displayed image, such as indicated below, and the actual conditions when parking, always verify the safety at the rear of the vehicle and the surrounding area directly with your eyes.

- In the image of the parking space (or garage) displayed on the screen, the back end and distance guide lines may appear aligned in the monitor, but they may not actually be aligned on the ground.

- When parking in a space with a division line on only one side of the parking space, the division line and the vehicle width guide line appear aligned in the monitor, but they may not actually be aligned on the ground.

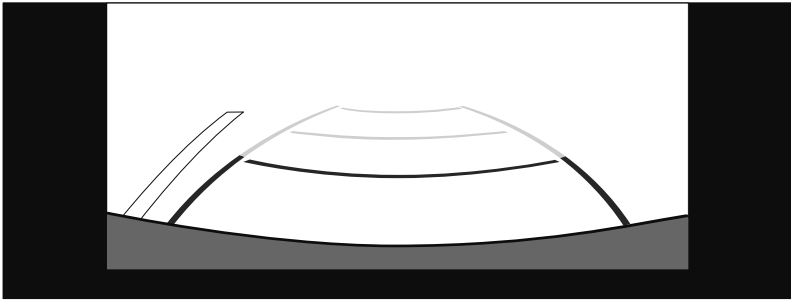

▼ Variance Between Actual Road Conditions and Displayed Image

Some variance occurs between the actual road and the displayed road. Such variance in distance perspective could lead to an accident. Note the following conditions that may cause a variance in distance perspective.

When the vehicle is tilted due to the weight of passengers and load

When the vehicle rear is lowered, the object displayed on the screen appears farther than the actual distance.

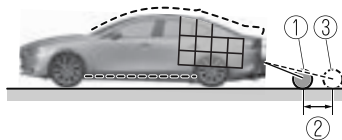

1. Object
2. Variance
3. Object on screen

Rear View Monitor

When there is a steep grade behind the vehicle

When there is a steep upgrade (downgrade) behind the vehicle, the object displayed on the screen appears farther (downgrade: closer) than the actual distance.

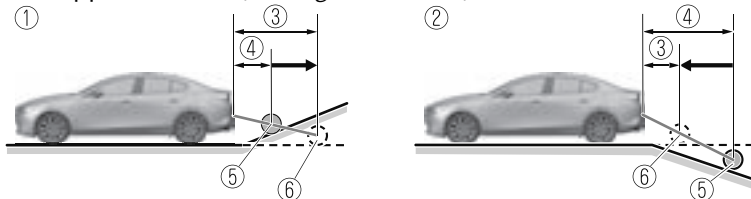

1. Appears farther than actual distance
2. Appears closer than actual distance
3. Distance between the vehicle and object displayed on the screen.
4. Actual distance between the vehicle and object.
5. Object at actual position
6. Object on screen

Three-dimensional object on vehicle rear

Because the distance guide lines are displayed based on a flat surface, the distance to the three-dimensional object displayed on the screen is different from the actual distance.

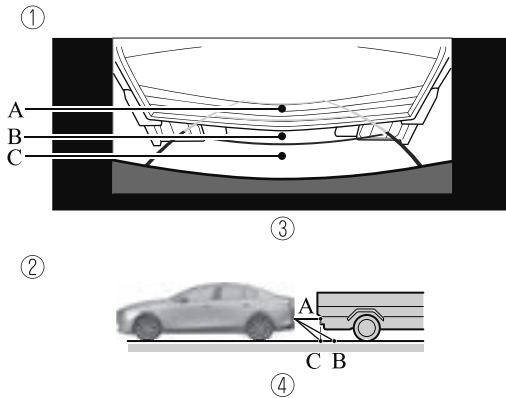

1. (Screen display)
2. (Actual condition)
3. Sensed distance on screen $A > B > C$
4. Actual distance $B > C = A$

(Predicted vehicle path assist lines display type)

When reversing near a three-dimensional object

When reversing near an overhanging object, the vehicle may hit the object even if the anticipated course line does not contact the object on the screen. The position of the object displayed on the screen is different from the actual position because the anticipated course lines on the screen are displayed based on a horizontal road surface. When backing up near an overhanging object, confirm the rear and surrounding conditions directly with your eyes.

①

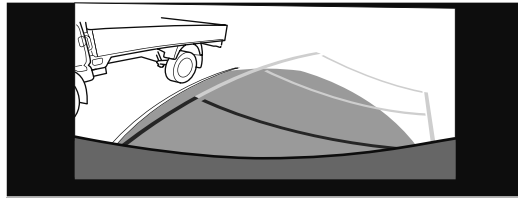

②

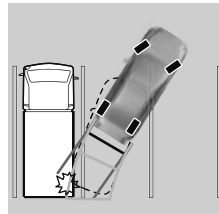

1. (Screen display)
2. (Actual view)

Parking Sensor System

Parking Sensor System*

▼ Parking Sensor System

The parking sensors use ultrasonic sensors which detect obstructions around the vehicle when the vehicle is driven at low speeds, such as during garage or parallel parking, and a buzzer sound and detection indicator notify the driver of the approximate distance from the vehicle to the surrounding obstruction.

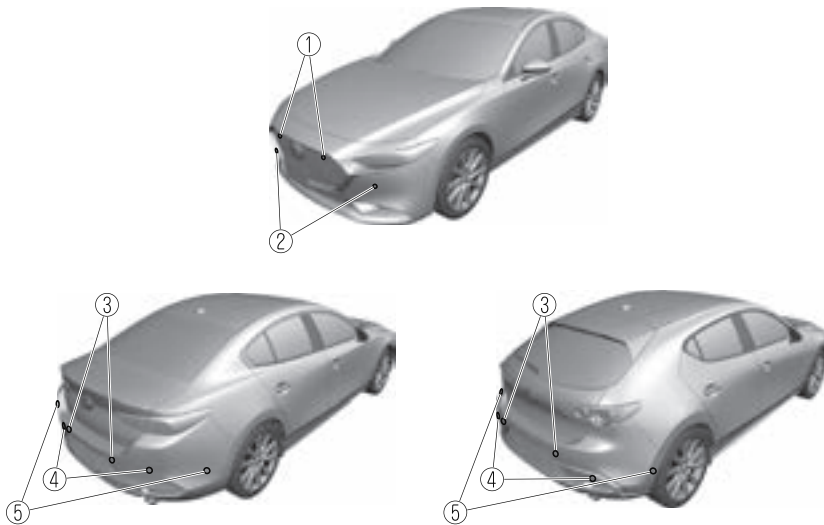

- 1. Front ultrasonic sensor*
- 2. Front corner ultrasonic sensor*
- 3. Rear ultrasonic sensor
- 4. Rear corner ultrasonic sensor
- 5. Rear side ultrasonic sensor*

WARNING

Do not rely completely on the parking sensor system and be sure to confirm the safety around your vehicle visually when driving:

This system can assist the driver in operating the vehicle in the forward and backward directions while parking. The detection ranges of the sensors are limited, therefore, driving the vehicle while relying only on the system may cause an accident. Always confirm the safety around your vehicle visually when driving.

⚠ CAUTION

- Do not install any accessories within the detection ranges of the sensors. It may affect the system operation.
- Depending on the type of obstruction and the surrounding conditions, the detection range of a sensor may narrow, or the sensors may not be able to detect obstructions.

NOTE

- When the ignition is switched OFF, the system status before it was turned off is maintained. For example, if the ignition is switched OFF while the parking sensor is activated, the system will be activated when the ignition is switched ON the next time.
- The system may not operate normally under the following conditions:
 - Mud, ice, or snow is adhering to the sensor area (Returns to normal operation when removed).
 - The sensor area is frozen (Returns to normal operation when the ice is thawed).
 - The sensor is covered by a hand.
 - The sensor is excessively shocked.
 - The vehicle is excessively tilted.
 - Under extremely hot or cold weather conditions.
 - The vehicle is driven on bumps, inclines, gravel, grating, or grass covered roads.
 - Anything which generates ultrasonic waves such as another vehicle's horn, the engine sound of a motorcycle, the air brake sound of a large-sized vehicle, or another vehicle's sensors approaches the vehicle.
 - The vehicle is driven in heavy rain or in road conditions causing water-splash.
 - A commercially-available fender pole or an antenna for a radio transmitter is installed to the vehicle.
 - The vehicle is moving towards a tall or square curbstone, or a steep grade.
 - An obstruction is too close to the sensor.
 - The vehicle is moving towards an uneven wall or stairs.
 - There are multiple obstructions.
 - The vehicle is driven in a place with low ceilings.
- Obstructions under the bumper cannot be detected. Obstructions which are lower than the sensor or thin may not be detected even though they were detected once.
- The following types of obstructions may not be detected:
 - Thin objects such as wire, rope or poles
 - Things which absorb sonic waves easily such as cotton or snow
 - Angular shaped objects
 - Very tall objects, and those which are wide at the top
 - Small, short objects
- Always have the system inspected at an Authorized Mazda Dealer if any shock is applied to the bumpers, even in a minor accident. If the sensors are deviated, they cannot detect obstructions.

Parking Sensor System

- The system may have a malfunction if a sound is not activated or the detection indication is not displayed even when the parking sensor OFF switch is pressed and the parking sensor is operable. Have your vehicle inspected by an Authorized Mazda Dealer.
- The system may have a malfunction if the indicator light does not turn on even when the parking sensor OFF switch is turned on. Have your vehicle inspected by an Authorized Mazda Dealer.
- The system may have a malfunction if a message indicating a system malfunction is displayed. Have your vehicle inspected by an Authorized Mazda Dealer.
- A message may be displayed even when the ambient temperature is extremely cold, or mud, ice, or snow adheres to the sensor area. Remove any foreign matter from the sensor area.





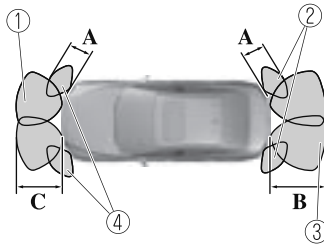

▼ Sensor Detection Range

The sensors detect obstructions within the following range.

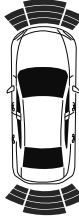

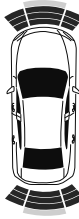

1. Front ultrasonic sensor detection range
 2. Rear corner/Rear side ultrasonic sensor detection range
 3. Rear ultrasonic sensor detection range
 4. Front corner ultrasonic sensor detection range
- A: About 55.0 cm (About 21.6 in)
B: About 150 cm (About 59.0 in)
C: About 100 cm (About 39.3 in)

Viewing distance display

Display			Distance between vehicle and obstruction	
Without 360° view monitor		With 360° view monitor	Front ultrasonic sensor*/Front corner ultrasonic sensor*	Rear ultrasonic sensor/Rear corner ultrasonic sensor/Rear side ultrasonic sensor*
Without front ultrasonic sensor and front corner ultrasonic sensor	With front ultrasonic sensor and front corner ultrasonic sensor			
		Green 	Front ultrasonic sensor: Approx. 100—60.0 cm (39.3—23.6 in)	Rear ultrasonic sensor: Approx. 150—60.0 cm (59.0—23.6 in)
		Yellow 	Front ultrasonic sensor: Approx. 60.0—45.0 cm (23.6—17.7 in) Front corner ultrasonic sensor: Approx. 55.0—38.0 cm (21.6—14.9 in)	Rear ultrasonic sensor: Approx. 60.0—45.0 cm (23.6—17.7 in) Rear corner ultrasonic sensor/Rear side ultrasonic sensor: Approx. 55.0—38.0 cm (21.6—14.9 in)
		Amber 	Front ultrasonic sensor: Approx. 45.0—35.0 cm (17.7—13.7 in) Front corner ultrasonic sensor: Approx. 38.0—25 cm (14.9—9.8 in)	Rear ultrasonic sensor: Approx. 45.0—35.0 cm (17.7—13.7 in) Rear corner ultrasonic sensor/Rear side ultrasonic sensor: Approx. 38.0—25 cm (14.9—9.8 in)

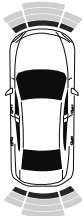
Parking Sensor System

Display			Distance between vehicle and obstruction	
Without 360° view monitor		With 360° view monitor	Front ultrasonic sensor* / Front corner ultrasonic sensor*	Rear ultrasonic sensor / Rear corner ultrasonic sensor / Rear side ultrasonic sensor*
Without front ultrasonic sensor and front corner ultrasonic sensor	With front ultrasonic sensor and front corner ultrasonic sensor			
		Red 	Front ultrasonic sensor: Within approx. 35.0 cm (13.7 in) Front corner ultrasonic sensor: Within approx. 25 cm (9.8 in)	Rear ultrasonic sensor: Within approx. 35.0 cm (13.7 in) Rear corner ultrasonic sensor / Rear side ultrasonic sensor: Within approx. 25 cm (9.8 in)

▼ Parking Sensor OFF Switch

When the switch is pressed, the parking sensor is stopped and the indicator light turns on. If the switch is pressed again, the parking sensor becomes operational and the indicator light turns off.

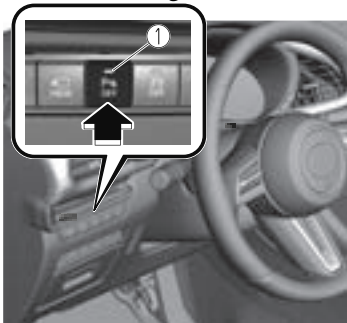

1. Indicator light

NOTE

- **(Automatic vehicle)**
The detection indicator and buzzer of the front ultrasonic sensors / front corner ultrasonic sensors do not operate when the selector lever is in the P position.
- The detection indicator and buzzer sound do not activate when the parking brake is applied.

▼ **Obstruction Detection Indication**

The position of a sensor which has detected an obstruction is indicated. The gauge illuminates in different areas depending on the distance to an obstruction detected by the sensor. As the vehicle approaches closer to an obstruction, the zone in the gauge closer to the vehicle illuminates.

Without 360° view monitor

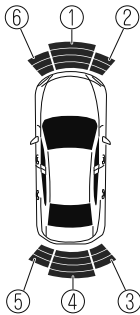

1. Front ultrasonic sensor gauge*
2. Right front corner ultrasonic sensor gauge*
3. Right rear corner ultrasonic sensor gauge/Right rear side ultrasonic sensor gauge*
4. Rear ultrasonic sensor gauge
5. Left rear corner ultrasonic sensor gauge/Left rear side ultrasonic sensor gauge*
6. Left front corner ultrasonic sensor gauge*

With 360° view monitor

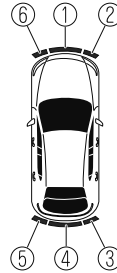

1. Front ultrasonic sensor gauge
2. Right front corner ultrasonic sensor gauge
3. Right rear corner ultrasonic sensor gauge/Right rear side ultrasonic sensor gauge*
4. Rear ultrasonic sensor gauge
5. Left rear corner ultrasonic sensor gauge/Left rear side ultrasonic sensor gauge*
6. Left front corner ultrasonic sensor gauge

NOTE

The detection indicator can be switched between display and non-display and the buzzer volume can be changed.

Refer to the Settings section in the Mazda Connect Owner's Manual.

(Vehicles with 360° View Monitor)

When the detection indicator is set to "Display", even with the 360° view monitor not displayed, if a front sensor or a front corner sensor detects an obstruction, the 360° view monitor switches automatically to display. When an obstruction is no longer detected, the display switches to the display before the obstruction was detected. However, while the 360° view monitor is displayed, it continues to display no matter if an obstruction is detected or not.

Parking Sensor System

System problem notification

The indication displays if the system has a malfunction.

Without 360°view monitor



With 360°view monitor



Check the reason for the indication displaying on the center display or multi-information display. Refer to If a Warning Light Turns On or Flashes on page 7-27.

▼ **Parking Sensor Warning Beep**

Informs the driver of the approximate distance from the vehicle to the obstruction using warning beeps depending on the distance. If multiple obstructions are detected at the same time, warning beeps are activated according to the distance to the nearest obstruction. The warning beeps are activated as follows while the system is operating. However, the warning beeps are not activated while the seat belt reminder is operating.

Front ultrasonic sensor*, Rear ultrasonic sensor

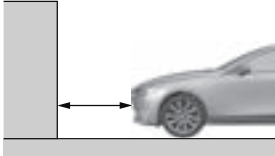
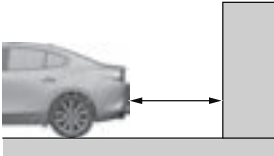
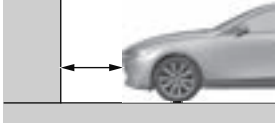
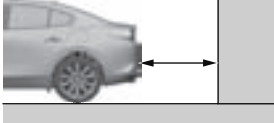
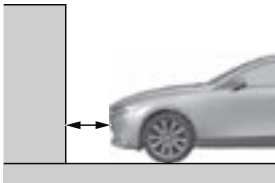
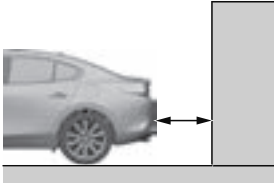
Distance De- tection area	Distance between vehicle and obstruction		Beeper sound ^{*1}
	Front ultrasonic sensor	Rear ultrasonic sensor	
Farthest distance	Approx. 100—60.0 cm (39.3—23.6 in) 	Approx. 150—60.0 cm (59.0—23.6 in) 	Slow intermittent sound
Far distance	Approx. 60.0—45.0 cm (23.6—17.7 in) 	Approx. 60.0—45.0 cm (23.6—17.7 in) 	Medium intermittent sound
Middle distance	Approx. 45.0—35.0 cm (17.7—13.7 in) 	Approx. 45.0—35.0 cm (17.7—13.7 in) 	Fast intermittent sound

Parking Sensor System

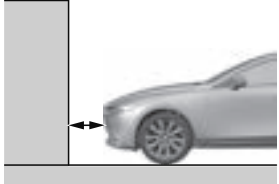
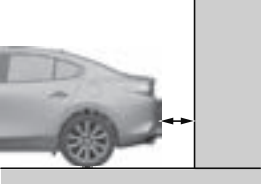
Distance De-tection area	Distance between vehicle and obstruction		Beeper sound ^{*1}
	Front ultrasonic sensor	Rear ultrasonic sensor	
Close distance	Within approx. 35.0 cm (13.7 in) 	Within approx. 35.0 cm (13.7 in) 	Continuous sound

^{*1} The rate at which the intermittent sound beeps increases as the vehicle approaches the obstruction.

Front corner ultrasonic sensor^{*}, Rear corner/Rear side^{*} ultrasonic sensor

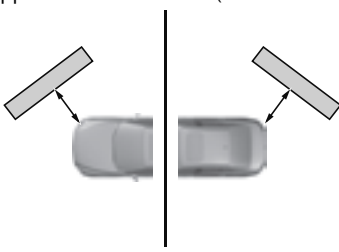
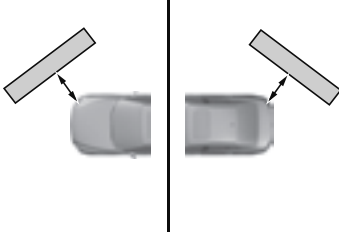
Distance Detection area	Distance between vehicle and obstruction	Beeper sound ^{*1}
	Front corner ultrasonic sensor/Rear corner, Rear side ultrasonic sensor	
Far distance	Approx. 55.0—38.0 cm (21.6—14.9 in) 	Medium intermittent sound
Middle distance	Approx. 38.0—25 cm (14.9—9.8 in) 	Fast intermittent sound

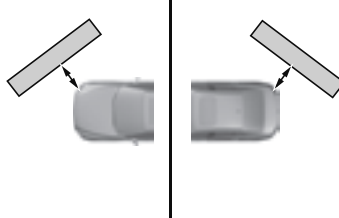
Distance Detection area	Distance between vehicle and obstruction	Beeper sound ^{*1}
	Front corner ultrasonic sensor/Rear corner, Rear side ultrasonic sensor	
Close distance	<p style="text-align: center;">Within approx. 25 cm (9.8 in)</p> 	Continuous sound

*1 The rate at which the intermittent sound beeps increases as the vehicle approaches the obstruction.

NOTE

- If an obstruction in the same area excluding the close area is detected continuously for 6 seconds or longer, only the warning beeps stop activating. (Detection is indicated) If the detection area changes to the close side, the warning beeps resumes. (If the detection area changes to the far side, the warning beeps remain off)
- The sound volume (each of front and rear) can be changed. Refer to the Settings section in the Mazda Connect Owner's Manual.

▼ When Warning Indicator/Beep is Activated

The system notifies the driver of an abnormality by activating the beep sound and the indicator light.

Indicator/Beep	How to check
A message indicating a system malfunction or sensor malfunction is displayed.	There may be a problem with the system. Have your vehicle inspected by an Authorized Mazda Dealer as soon as possible.
A message indicating that the sensor is dirty is displayed.	Remove any foreign matter from the sensor area. If the system does not recover, have the vehicle inspected by an Authorized Mazda Dealer.
A certain obstruction detection indication is continuously displayed.	Foreign matter may have gotten on the sensor area corresponding to the detection indicator. If the system does not recover, have the vehicle inspected by an Authorized Mazda Dealer.

MEMO

5

Interior Features

Use of various features for ride comfort, including air-conditioning system and audio system.

Climate Control System..... 5-2

- Operating Tips..... 5-2
- Vent Operation..... 5-3
- Manual Type..... 5-5
- Fully Automatic Type..... 5-10

Mazda Connect..... 5-15

- What is Mazda Connect ?..... 5-15
- Mazda Connect Basic
Operations..... 5-19
- Connected Service (U.S.A
only)..... 5-37

Interior Equipment..... 5-38

- Sunvisors..... 5-38
- Interior Lights..... 5-39
- Accessory Socket..... 5-41
- Cup Holder..... 5-42
- Bottle Holder..... 5-44
- Assist Grips..... 5-44
- Rear Coat Hooks..... 5-45
- Storage Compartments..... 5-45

Climate Control System

Operating Tips

▼ Operating Tips

- Operate the climate control system with the engine running.
- To prevent the battery from being discharged, do not leave the fan control switch on for a long period of time with the ignition switched ON when the engine is not running.
- Clear all obstructions such as leaves, snow and ice from the hood and the air inlet in the cowl grille to improve the system efficiency.
- Use the climate control system to defog the windows and dehumidify the air.
- The recirculate mode should be used when driving through tunnels or while in a traffic jam, or when you would like to shut off outside air for quick cooling of the interior.
- Use the outside air position for ventilation or windshield defrosting.
- If the vehicle has been parked in direct sunlight during hot weather, open the windows to let warm air escape, then run the climate control system.

(With A/C switch)

- Run the air conditioner about 10 minutes at least once a month to keep internal parts lubricated.
- Have the air conditioner checked before the weather gets hot. Lack of refrigerant may make the air conditioner less efficient.

The refrigerant specifications are indicated on a label attached to the inside of the engine compartment. If the wrong type of refrigerant is used, it could result in a serious malfunction of the air conditioner. Consult a professional, government certified repairer for the inspection or repair because a special device is required for the air conditioner maintenance.

For details, consult an Authorized Mazda Dealer.

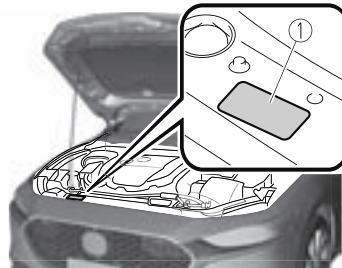

1. Label

Vent Operation

▼ Adjusting the Vents

Directing airflow

To adjust the direction of airflow, move the adjustment knob.

NOTE

- When using the air conditioner under humid ambient temperature conditions, the system may blow fog from the vents. This is not a sign of trouble but a result of humid air being suddenly cooled.
- The air vents can be fully opened and closed by operating the knob.

Driver's Side Vents

Air vent open/close

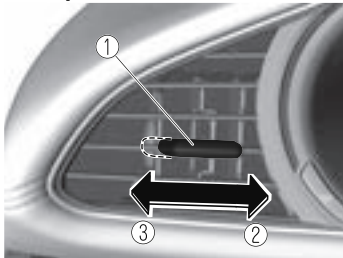

1. Knob
2. Open
3. Close

NOTE

The figure indicates the air vent on the left side of the instrument cluster. The operation direction for the air vent on the right side of the instrument cluster is symmetrical with the air vent on the left side.

Airflow direction adjustment

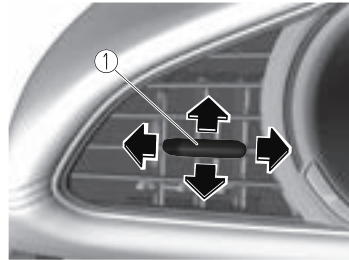

1. Knob

Passenger's Side Vents

Air vent open/close

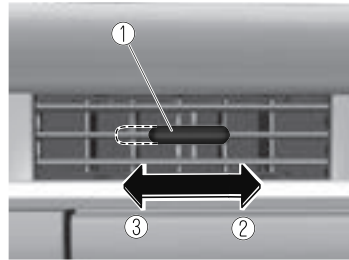

1. Knob
2. Open
3. Close

Airflow direction adjustment

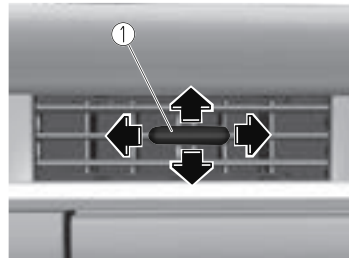

1. Knob

Climate Control System

▼ Selecting the Airflow Mode

Dashboard Vents

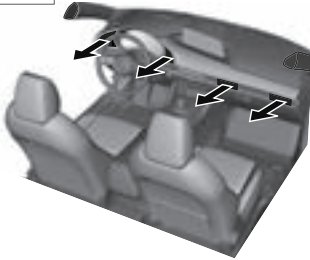

Dashboard and Floor Vents

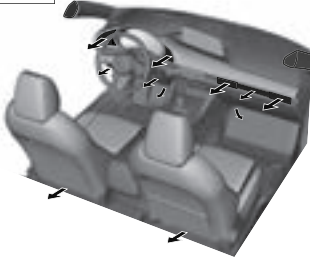

Floor Vents

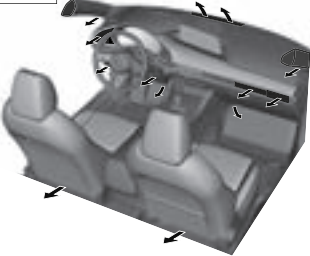

Defroster and Floor Vents

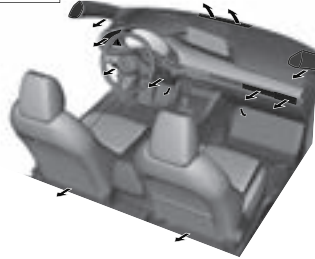

Defroster Vents

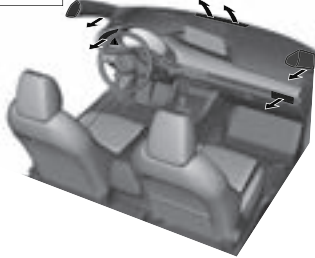

NOTE

The location airflow exits the air vents and the airflow amount may change depending on the open or close status of the air vents.

Manual Type

▼ Manual Type

With A/C switch

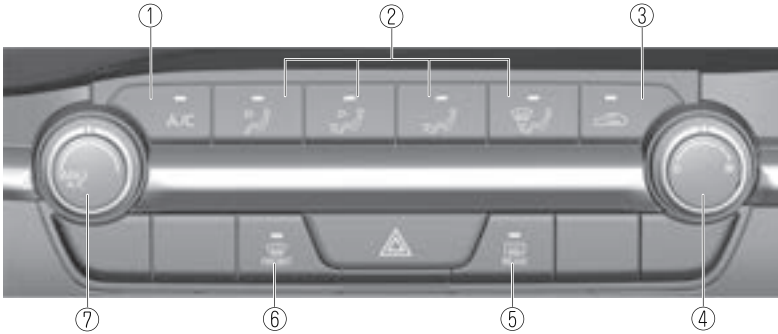

1. A/C switch
2. Mode selector switch
3. Air intake selector switch
4. Fan control dial
5. Rear window defogger switch
6. Windshield defroster switch
7. Temperature control dial

Climate Control System

Without A/C switch

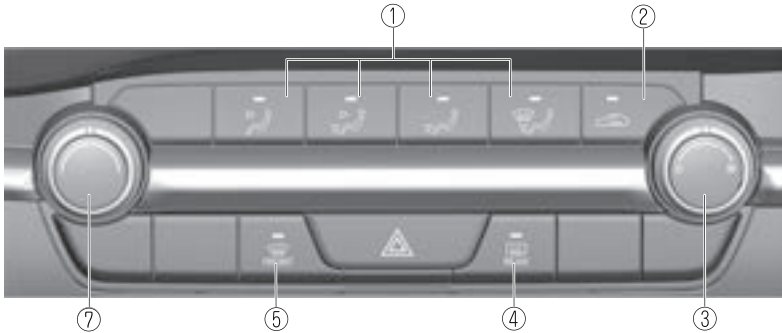

1. Mode selector switch
2. Air intake selector switch
3. Fan control dial
4. Rear window defogger switch
5. Windshield defroster switch
6. Temperature control dial

▼ Control Switches



Temperature control dial

This dial controls temperature. Turn it clockwise for hot and counterclockwise for cold.

MAX A/C (With A/C switch)

Fully turn the temperature control dial counterclockwise for MAX A/C (maximum cooling).

NOTE

When the mode is set to  or  with the fan control dial in a position other than 0 and the temperature control dial in the MAX A/C position, the air intake selector switches to the recirculated air position and the A/C turns on automatically. If A/C is not desired, press the A/C switch to turn it off.

Fan control dial

This dial allows variable fan speeds. The fan has seven speeds.

Mode selector switches

The desired airflow mode can be selected (page 5-4).

A/C switch*

Press the A/C switch to turn the air conditioner on. The indicator light on the switch will illuminate when the fan control dial is in any position except OFF.

Press the switch once again to turn the air conditioner off.

NOTE

The air conditioner may not function when the outside temperature approaches 0 °C (32 °F).

Air intake selector switch

This switch controls the source of air entering the vehicle.

Outside or recirculated air positions can be selected. Press the switch to select outside/recirculated air positions.

Recirculated air position (indicator light illuminated)

Outside air is shut off. Use this position when going through tunnels, driving in congested traffic (high engine exhaust areas) or when quick cooling is desired.

Outside air position (indicator light turned off)

Outside air is allowed to enter the cabin. Use this mode for ventilation or windshield defrosting.

**Do not use the  position (indicator light turns on) in cold or rainy weather:**

Using the  position (indicator light turns on) in cold or rainy weather is dangerous as it will cause the windows to fog up. Your vision will be hampered, which could lead to a serious accident.

Windshield defroster switch

Press the switch to defrost the windshield and front door windows. Refer to Windshield Defrosting and Defogging on page 5-8.



Rear window defogger switch

Press the rear window defogger switch to defrost the rear window. Refer to Rear Window Defogger on page 4-58.

▼ Heating

1. Press the  switch.
2. Set the air intake selector to the outside air position (indicator light turns off).
3. Set the temperature control dial to the hot position.
4. Set the fan control dial to the desired speed.
5. If dehumidified heating is desired, turn on the air conditioner.

NOTE

- If the windshield fogs up easily, press the  switch.
- **(With A/C switch)**
If cooler air is desired at face level, press the  switch and adjust the temperature control dial to maintain maximum comfort.
- The air to the floor is warmer than air to the face (except when the temperature control dial is set at the extreme hot or cold position).

Climate Control System

▼ Cooling (With A/C switch)

1. Press the  switch.
2. Set the temperature control dial to the cold position.
3. Set the fan control dial to the desired speed.
4. Turn on the air conditioner by pressing the A/C switch.
5. After cooling begins, adjust the fan control dial and temperature control dial as needed to maintain maximum comfort.

CAUTION

If the air conditioner is used while driving up long hills or in heavy traffic, monitor the high engine coolant temperature warning indication to see if it is displayed (page 7-29).

The air conditioner may cause engine overheating. If the warning indication is displayed, turn the air conditioner off (page 7-21).

NOTE

- When maximum cooling is desired, set the temperature control dial to the extreme cold position and set the air intake selector to the recirculated air position, then turn the fan control dial fully clockwise.
- If warmer air is desired at floor level, press the  switch and adjust the temperature control dial to maintain maximum comfort.
- The air to the floor is warmer than air to the face (except when the temperature control dial is set at the extreme hot or cold position).

▼ Ventilation



1. Press the  switch.
2. Set the air intake selector to the outside air position (indicator light turns off).
3. Set the temperature control dial to the desired position.
4. Set the fan control dial to the desired speed.

▼ Windshield Defrosting and Defogging

1. Press the  switch.
2. Set the temperature control dial to the desired position.
3. Set the fan control dial to the desired speed.
4. If dehumidified heating is desired, turn on the air conditioner.

WARNING

Do not defog the windshield using the  switch with the temperature control set to the cold position:

Using the  switch with the temperature control set to the cold position is dangerous as it will cause the outside of the windshield to fog up. Your vision will be hampered, which could lead to a serious accident. Set the temperature control to the hot or warm position when using the  switch.

NOTE

- **(With A/C switch)**
Fogging on the windows clears up more easily while the air conditioner is on, but they will fog up more easily if the air conditioner is turned off.





- **(With A/C switch)**

Be careful that the windows do not fog up when doing any of the following:

- Switching to recirculate mode
- Turning off the air conditioner

- **(With A/C switch)**

For maximum defrosting, turn on the air conditioner, set the temperature control dial to the extreme hot position, and turn the fan control dial fully clockwise.

- If warm air is desired at the floor, press the  switch.
- With the  or  switch, the air conditioner is automatically turned on and the outside air position is automatically selected to defrost the windshield. In the  switch, the outside air position cannot be changed to the recirculated air position.

*1 Depending on the market.

▼ Dehumidifying (With A/C switch)

Operate the air conditioner in cool or cold weather to help defog the windshield and side windows.

1. Press the desired mode switch you want to set.
2. Set the air intake selector to the outside air position (indicator light turns off).
3. Set the temperature control dial to the desired position.
4. Set the fan control dial to the desired speed.
5. Turn on the air conditioner by pressing the A/C switch.

NOTE

One of the functions of the air conditioner is dehumidifying the air and, to use this function, the temperature does not have to be set to cold. Therefore, set the temperature control dial to the desired position (hot or cold) and turn on the air conditioner when you want to dehumidify the cabin air.

Climate Control System

Fully Automatic Type

▼ Fully Automatic Type

Climate control system information is displayed on the display.

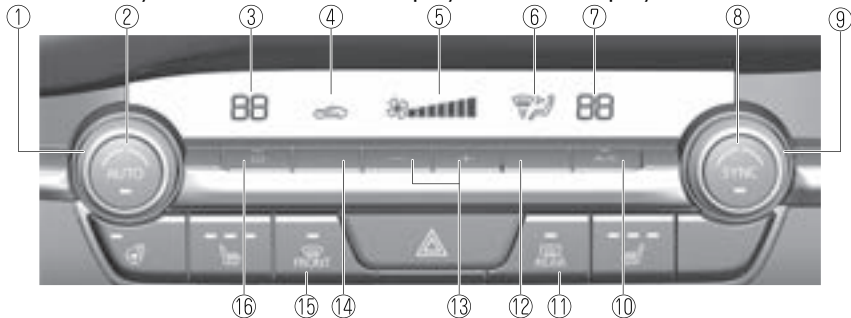

1. Driver temperature control dial
2. AUTO switch
3. Temperature setting display (driver's side)
4. Air intake display
5. Airflow display
6. Mode selector display
7. Temperature setting display (passenger's side)
8. SYNC (synchronized temperature) switch
9. Passenger temperature control dial
10. A/C switch
11. Rear window defogger switch
12. Mode selector switch
13. Fan control switch
14. Air intake selector switch
15. Windshield defroster switch
16. Power switch

▼ Control Switches

AUTO switch

By pressing the AUTO switch the following functions will be automatically controlled in accordance with the selected set temperature:

- Airflow temperature
- Amount of airflow
- Selection of airflow mode
- Outside/Recirculated air selection
- Air conditioner operation

- Seat warmer level selection*
- Heated steering wheel operation*

Climate Control System

NOTE

AUTO switch indicator light

- When the AUTO switch indicator light is on, it indicates auto operation, and the system will function automatically.
- If any of the following switches are operated while in auto control, the AUTO switch indicator turns off.
 - Mode selector switch
 - Fan control switch
 - Windshield defroster switch
 The functions for switches other than those operated continue to operate in auto control.

Power switch (System On/Off)

The climate control system turns on or off by pressing the power switch.

Temperature control dial

This dial controls temperature. Turn it clockwise for hot and counterclockwise for cold.

Turn the temperature control dial to adjust the temperature between 15 °C (60 °F) and 29 °C (84 °F).

- When the SYNC switch is on: Turn the driver temperature control dial to control the temperature throughout the entire cabin.
- When the SYNC switch is off: Turn the driver or front passenger temperature control dial to independently control the temperature on each side of the cabin.

NOTE

- The climate control system changes to the individual operation mode (SYNC switch indicator light turns off) by turning the front passenger temperature control dial even when the SYNC switch is on, which allows individual control of the set temperature for the driver and front passenger.
- When you set the temperature to the lower or upper limit, “Lo” or “Hi” is displayed.
- The temperature units for the temperature setting display can be changed in conjunction with the temperature units for the outside temperature display. Refer to Outside Temperature Display on page 4-19.



Fan control switch

The fan has 7 speeds. The selected speed will be displayed.

Mode selector switch

The desired airflow mode can be selected (page 5-4).

NOTE

- With the airflow mode set to the  position and the temperature control dial set at a medium temperature, heated air is directed to the feet and air at a comparably lower temperature will flow through the central, left and right vents.
- To set the air vent to , press the windshield defroster switch.
- In the  position, the outside air position is automatically selected.

Climate Control System

A/C switch

Pressing the A/C switch while the AUTO switch is turned on will turn off the air conditioner (cooling/dehumidifying functions). The on/off of the air conditioner switches each time the A/C switch is pressed.

NOTE

- The air conditioner operates when the A/C switch is pressed while the air conditioner is turned off.
- The air conditioner may not function when the outside temperature approaches 0 °C (32 °F).

Air intake selector switch

Outside or recirculated air positions can be selected. Press the switch to select outside/recirculated air positions.

Recirculated air position (↻)

Outside air is shut off. Use this position when going through tunnels, driving in congested traffic (high engine exhaust areas) or when quick cooling is desired.

Outside air position (↻)

Outside air is allowed to enter the cabin. Use this mode for ventilation or windshield defrosting.



Do not recirculate the air in the cabin during cold or rainy weather:

Recirculating the air in the cabin during cold and rainy weather is dangerous as it will cause the windows to fog up. Your vision will be hampered, which could lead to a serious accident.

SYNC (Synchronized Temperature) switch

Use the SYNC switch to change the mode between the individual operation (driver and passenger) and interconnection (simultaneous) modes.

Interconnection mode (indicator light turns on)

The set temperature for the driver and front passenger is controlled simultaneously.

Individual operation mode (indicator light turns off)

The set temperature can be controlled individually for the driver and front passenger.

Windshield defroster switch

Press the switch to defrost the windshield and front door windows. Refer to Windshield Defrosting and Defogging on page 5-13.

Rear window defogger switch

Press the rear window defogger switch to defrost the rear window. Refer to Rear Window Defogger on page 4-58.

▼ Operation of Automatic Air Conditioner

1. Press the AUTO switch. Selection of the airflow mode, air intake selector and amount of airflow will be automatically controlled.
2. Use the temperature control dial to select a desired temperature. If you want to set the temperature on the front passenger's side separately from the driver's side, turn the front passenger temperature control dial to switch the mode automatically to the individual operation mode and set the temperature for the front passenger's side.

To turn off the system, press the power switch.

NOTE

- Set the control dial to the recommended temperature of 22 °C (72 °F), and then adjust it as desired.
- Setting the temperature to maximum hot or cold will not provide the desired temperature at a faster rate.
- When selecting heat, the system will restrict airflow until the engine has warmed to prevent cold air from blowing out of the vents.

▼ Windshield Defrosting and Defogging

Press the windshield defroster switch. In this position, the outside air position is automatically selected, and the air conditioner automatically turns on. The air conditioner will directly dehumidify the air to the front windshield and side windows on page 5-4. Airflow amount will be increased.



Set the temperature control to the hot or warm position when defogging

(position):

Using the position with the temperature control set to the cold position is dangerous as it will cause the outside of the windshield to fog up. Your vision will be hampered, which could lead to a serious accident.

NOTE

- Fogging on the windows clears up more easily while the air conditioner is on, but they will fog up more easily if the air conditioner is turned off.
- Be careful that the windows do not fog up when doing any of the following:
 - Switching to recirculate mode
 - Turning off the air conditioner
- Use the temperature control dial to increase the air flow temperature and defog the windshield more quickly.

Climate Control System

▼ Sunlight/Temperature Sensor

The climate control system measures inside and outside temperatures, humidity and sunlight using the sunlight/temperature sensor. It sets temperatures inside the cabin accordingly.



Do not obstruct both sensors, otherwise the climate control system will not operate properly.

Sunlight sensor

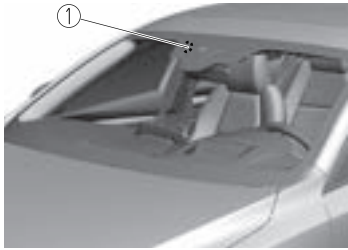

1. Sunlight sensor

Interior temperature sensor

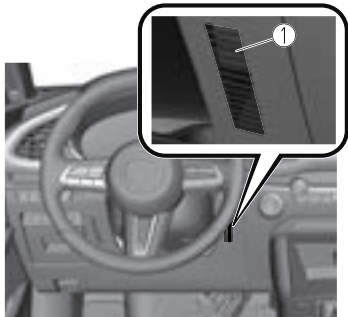

1. Interior temperature sensor

What is Mazda Connect ?

▼ What is Mazda Connect ?

This manual only indicates a part of the information for Mazda Connect. For details, check the Web owner's manual at the Mazda site for each country and region.

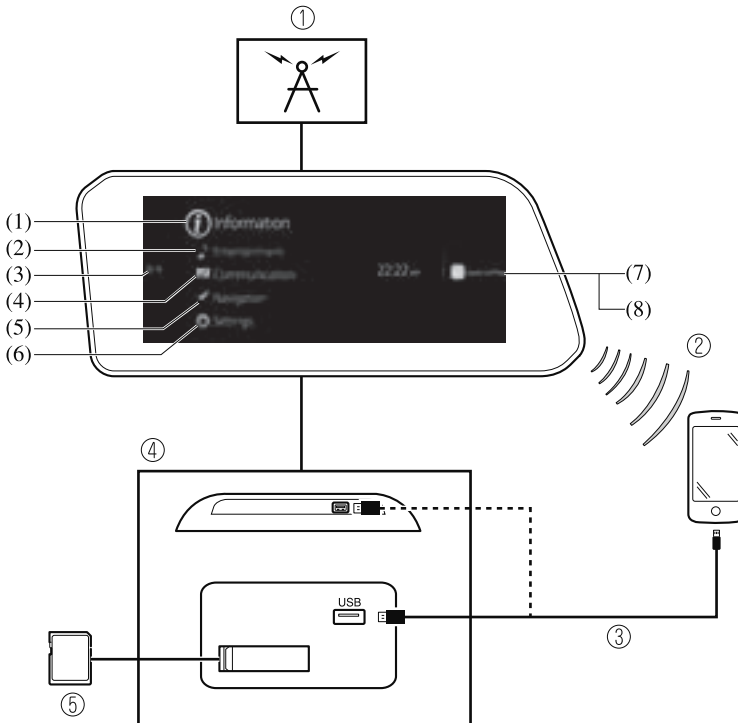

1. Radio
2. Bluetooth® Audio/Hands-Free Call/SMS (Short Message Service)
3. USB Audio/USB Video
4. USB port*¹/SD card slot*²
5. SD card (Navigation system)*

*¹ The location of the USB slot differs depending on the specifications.

*² The SD card slot is for the navigation system only. For vehicles with the navigation system, the SD card (Mazda genuine) with stored map data is inserted into the SD card slot and used.

Mazda Connect

No.	Menu	Explanation
(1)	Information	<p><u>Fuel Efficiency Monitor:</u> Monitor fuel efficiency in real time and view fuel efficiency history.</p> <p><u>SiriusXM Travel Link[†]:</u> Access traffic information, weather, fuel prices, parking information and sports scores.</p> <p><u>Vehicle Status Monitor:</u> View important vehicle maintenance messages, information, and intervals.</p> <p><u>Owner's Manual:</u> Learn about Mazda features, safety information, maintenance, and more.</p>
(2)	Entertainment	FM AM SiriusXM* Pandora* Bluetooth USB1 Audio/USB2 Audio USB1 Video/USB2 Video
(3)	Notifications	Displays text messages received by the mobile device paired to Mazda Connect and notifications from the vehicle.
(4)	Communication	By connecting your mobile device, such as a Smartphone, to Mazda Connect via Bluetooth®, you can use the hands-free call and short message functions.
(5)	Navigation	<p>The navigation system (vehicles with navigation system) can be used when the SD card for the navigation system is inserted.</p> <p>If the SD card for the navigation system is not inserted, the compass indicating the direction in which the vehicle is moving is displayed. The compass may not indicate the correct bearing when the vehicle is stopped or traveling at a slow speed.</p> <p>For the navigation system operation, refer to the navigation system manual.</p>

No.	Menu	Explanation
(6)	Settings	<p>You can change the settings for the Mazda Connect screen, sound settings, and the vehicle functions.</p> <p><u>In-Vehicle Displays:</u> Configures settings and content for all in-vehicle displays.</p> <p><u>Sound Settings:</u> Configures the in-vehicle listening experience.</p> <p><u>Safety Settings:</u> Configures safety and driver assistance features.</p> <p><u>Vehicle Settings:</u> Configures vehicle convenience features.</p> <p><u>Connectivity Settings:</u> Configures Bluetooth and other device connectivity settings.</p> <p><u>System Settings:</u> Configures language, time, and other general settings.</p>
(7)	Apple CarPlay	You can use Apple CarPlay™ by connecting an iPhone® compatible with Apple CarPlay™ to the USB slot.
(8)	Android Auto	You can use Android Auto™ by connecting an Android™ Smartphone compatible with Android Auto™ to the USB port.

 **WARNING**

Always adjust Mazda Connect while the vehicle is stopped:

Do not adjust Mazda Connect with the Commander switch while driving the vehicle. Adjusting Mazda Connect with the Commander switch while driving the vehicle is dangerous as it could distract your attention from the vehicle operation which could lead to a serious accident.

Even if the audio remote control switches are equipped on the steering wheel, learn to use the switches without looking down at them so that you can keep your maximum attention on the road while driving the vehicle.

Do not allow the connection plug cord to get tangled with the shift lever (manual transmission)/selector lever (automatic transmission):

Allowing the plug cord to become tangled with the shift lever (manual transmission)/selector lever (automatic transmission) is dangerous as it could interfere with driving, resulting in an accident.

Do not adjust a mobile device or a similar product while driving the vehicle:

Adjusting a mobile device or a similar product while driving the vehicle is dangerous as it could distract your attention from the vehicle operation which could lead to a serious accident. Always adjust a mobile device or a similar product while the vehicle is stopped.



For the purposes of safe driving, adjust the audio volume to a level that allows you to hear sounds outside of the vehicle including car horns and particularly emergency vehicle sirens.

NOTE

- Do not use Mazda Connect for a long time with the engine stopped. Otherwise, the battery power could be depleted.
- If a mobile phone or CB radio is used in or near the vehicle, it could cause noise to occur from the audio system. However, this does not indicate a problem.

Mazda Connect Basic Operations

▼ Mazda Connect Basic Operations

NOTE

The explanation of functions described in this manual may differ from the actual operation, and the shapes of screens and buttons and the letters and characters displayed may also differ from the actual appearance. Additionally, depending on future software updates, the content may successively change without notice.

▼ Commander Switch Operation

The commander switch can be used to switch to each function and to operate each function.

Set the palm of your hand on the commander knob so that your fingers can touch each of the switches.



You can switch the screens without having to look down at your hand.

NOTE

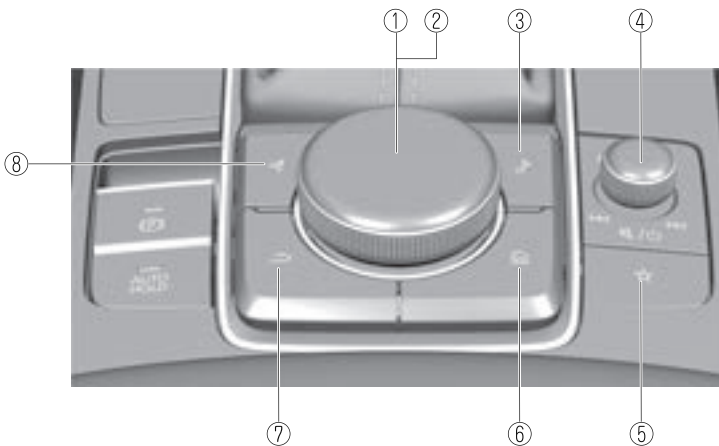
For safety reasons, some operations are disabled while driving the vehicle.







The shape of the switches varies depending on the specifications.

No.	Item	Explanation
1		<p><u>Commander knob (selection):</u> Rotate or slide the commander knob to highlight/select the on-screen functions you want to use.</p>
2		<p><u>Commander knob (select):</u> Depress the commander knob to select the desired on-screen function you want to use.</p>
3		<p><u>Entertainment button:</u> The audio source screen last used is displayed.</p> <p>(During Apple CarPlay™ or Android Auto™ music playback) Displays the Apple CarPlay™ or Android Auto™ now playing screen.</p>

No.	Item	Explanation
4		<p><u>Volume knob:</u></p> <p>Volume adjustment</p> <p>Adjust the volume by turning the volume knob. If you adjust the volume during voice guidance, the volume of the voice guidance will change. If you adjust the volume during a hands-free call, the conversation volume will change. Press the volume knob to mute/pause the audio. Press the knob again to resume.</p> <p>Power off/on</p> <p>Press and hold to turn off the Mazda Connect power and turn off the screen. Press and hold again to turn on the Mazda Connect power.</p> <p>NOTE</p> <p>If you press the volume knob to mute an audio source which can be paused, such as Apple CarPlay™, USB audio, or Bluetooth® audio, while it is playing, the song playback pauses. Press the volume knob again to cancel the mute and the pause at the same time.</p> <p>Selecting a radio station</p> <p>Radio stations saved to your Favorites can be selected by sliding the volume knob left (SEEK DOWN)/right (SEEK UP) while listening to FM/AM/SiriusXM®*. The station will change each time you slide the volume knob. If you want to manually tune to the next available station before or after the currently selected station, slide and hold the volume knob left (SEEK DOWN) or right (SEEK UP) until you hear a beep and the tuner will select the next available station.</p> <p>Playback Control</p> <p>Music and video files can be cued when listening to stored content via USB, Bluetooth®, and SiriusXM®, audio, or video. Slide the volume knob right to skip to the next track or slide it to the left to go back to the previous track. You can also slide and hold the volume knob to fast forward or rewind the track.</p>

Mazda Connect

No.	Item	Explanation
5		<p><u>Favorites button:</u> Displays the favorites screen. Press and hold to register AM/FM/SiriusXM® stations, contacts, navigation destinations, or any highlighted menu items to create easily accessible shortcuts.</p>
6		<p><u>Home button:</u> Displays the home screen.</p> <p>(While Apple CarPlay™ or Android Auto™ is displayed) Displays the Apple CarPlay™ or Android Auto™ home screen.</p> <p>(While Apple CarPlay™ or Android Auto™ is connected) Press and hold while the Mazda Connect screen is displayed to switch the screen from Mazda Connect to Apple CarPlay™ or Mazda Connect to Android Auto™. In addition, press and hold while the Apple CarPlay™ or Android Auto™ screen is displayed to switch to the Mazda Connect screen.</p>
7		<p><u>Back button:</u> Returns to previous screen.</p>
8		<p><u>Map button:</u> Displays the navigation screen (vehicles with navigation system). In order for the navigation system to function, the SD card for the navigation system is required. If the SD card for the navigation system is not inserted, the compass indicating the direction in which the vehicle is moving is displayed. For the navigation system operation, refer to the navigation system manual.</p> <p>(During Apple CarPlay™ or Android Auto™ route guidance) Displays the Apple CarPlay™ or Android Auto™ map screen.</p> <p>NOTE With an active Mazda Navigation route, pressing the Map button will repeat the navigation voice guidance.</p>

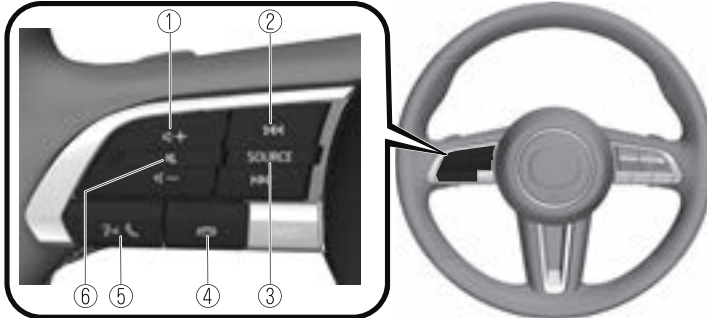

▼ Audio Remote Control Switch Operation

The audio remote control switch is on the left side of the steering wheel. You can operate basic audio functions, pick up/hang up the phone, or activate voice control using the switch.



The shape of the switches may differ depending on the specifications.

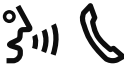

No.	Item	Explanation
1		<p>Volume adjustment button:</p> <p>Press the (+) or (-) button to adjust the volume.</p> <p>If you adjust the volume during voice guidance, the volume of the voice guidance will change.</p> <p>If you adjust the volume during a hands-free call, the conversation volume will change.</p>
2	 (SEEK UP)	<p>Seek Switch:</p> <p>Selecting a radio station</p> <p>Radio stations saved to your Favorites can be selected by pressing the seek switch while listening to FM/AM/SiriusXM[®]. The station will change to the previous or next favorite station each time you press the seek switch. If you want to manually tune to the next available station before or after the currently selected station, press and hold the seek switch until it beeps and the tuner will select the next available station.</p> <p>Playback Control</p> <p>Music and video files can be cued when listening to stored content via USB, Bluetooth[®], and SiriusXM[®], audio, or video. Slide the volume knob right to skip to the next track or slide it to the left to go back to the previous track. You can also slide and hold the volume knob to fast forward or rewind the track.</p>
	 (SEEK DOWN)	

No.	Item	Explanation
3	SOURCE	<p><u>SOURCE button:</u></p> <p>The audio source can be switched each time the button is pressed. In addition, when the button is pressed and held, the current audio source is muted and the audio source selection screen is displayed.</p> <p>(During Apple CarPlay™ or Android Auto™ playback) Press and hold the SOURCE button to mute the current audio source.</p>
4		<p><u>Hang-up button:</u></p> <p>(During a call) Press the button to end the call.</p> <p>(While receiving a call) Press the button to refuse a call.</p>
5		<p><u>Talk/Pick-up button:</u></p> <p>(While receiving a call) Press the button to answer the call.</p>
6		<p><u>Mute button:</u></p> <p>Press the button to mute. Press it again to cancel the mute.</p> <p>NOTE If you press the mute button to mute an audio source which can be paused, such as Apple CarPlay™, USB audio, or Bluetooth® audio, while it is playing, the song playback pauses. Press the mute button again to cancel the mute and the pause at the same time.</p>

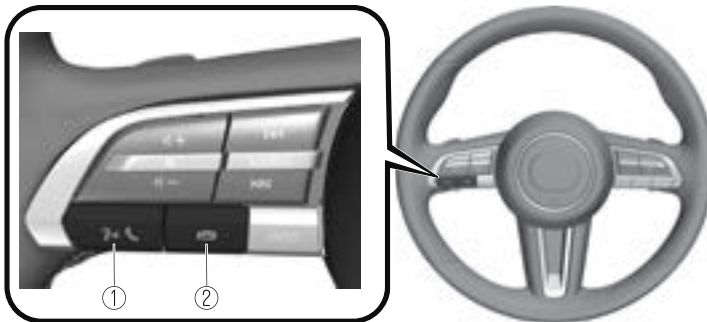
▼ **Operation Using Voice Recognition Function**



The shape of the switches may differ depending on the specifications.

No.	Item	Explanation
1		<p><u>Talk/Pick-up button:</u> When the button is pressed, the voice recognition top screen is displayed and the voice recognition is activated.</p> <p>(While voice guidance is being announced) Press the button to skip the voice guidance.</p>
2		<p><u>Hang-up button:</u> Press the button to end the voice recognition.</p>

Voice recognition activation

When the talk/pick-up button on the audio remote control switch is pressed, top screen of the voice recognition will be displayed.

NOTE

When an Apple CarPlay™ or Android Auto™ compatible device is connected, the Mazda Connect voice recognition system is disabled to allow the use of Siri® or Android Auto™ voice recognition at any time with the talk/pick-up button.

Commands usable at any time

“Help” - Can be used to check for usable voice commands.

“Back” - Returns to the previous screen. When a voice command is spoken while on the telephone number input screen, the content that was previously input is deleted.

“Cancel” - The voice recognition is ended.

To learn more on how to operate Mazda Connect

“Owner's Manual” - The operation guide screen is displayed.

Mazda Connect

Ending voice recognition

Do any one of the following operations:

- Press the hang-up button.
- Press and hold the talk/Pick-up button.
- Say the word, "Cancel".

Convenient operating tips for using the voice recognition function

Examples of effective voice commands in various categories are displayed on top screen of the voice recognition.

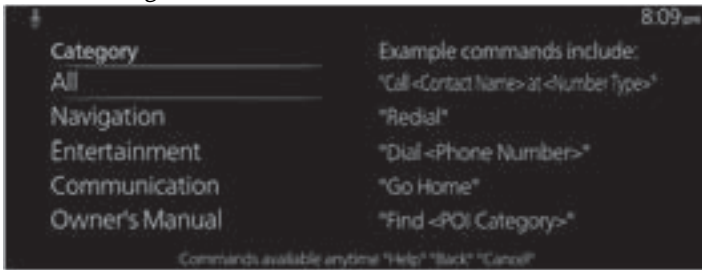

NOTE

- The voice command examples shown in this manual are only a partial list of the available commands. Some commands may be unusable depending on the specifications.
- Some commands cannot be used depending on the device connection conditions and the use conditions.
- When the Barge-In setting is on, voice commands can be made even while the voice guidance is being announced. For details on Barge-In, refer to the System Settings section in the Mazda Connect Owner's Manual.
- For details on voice commands which can be used on the navigation screen, refer to the navigation system manual.

To prevent misunderstood voice commands, be aware of the following points:

- Connect your mobile phone to Bluetooth® before operating the mobile phone using voice recognition.
- After pressing the talk/pick-up button, wait for the beep before speaking a command.
- Speaking in a slightly louder voice will improve voice recognition, but an excessively loud voice is unnecessary. Try to speak in a slightly louder voice than when talking to other passengers in the vehicle.
- You do not need to speak slowly. Speak at a normal speed.
- When calling a person in the device's phone book, the recognition rate increases the longer the name is. Errors may occur with names that are short such as "Mama", "Home", or "wife".
- Speak clearly, without pausing between words or numbers.
- Voice commands other than those specified, cannot be recognized. Speak in the wording specified by the voice commands.
- It is not necessary to face the microphone or approach it. Speak the voice commands while maintaining a safe driving position.
- Close the windows and the moonroof* to reduce loud noises from outside the vehicle and to prevent the airflow of the air-conditioning system from being a disturbance when using Bluetooth® Hands-Free.
- Make sure that the air flow from the air conditioner is not blowing on the microphone.
- If the voice recognition is poor with the guidance volume set to high, set the Barge-In to OFF.

Examples of available voice commands

The specified name and number are put into the {}.

Common

- Back
- Help (You can listen to help guidance at each screen.)
- {Line Number} (You can select the line number on the screen.)
- Next Page
- Previous Page
- Cancel

Menu

- All
- Navigation
- Entertainment

Mazda Connect

- Communication
- Owner's Manual (the In-vehicle Digital Owner's Manual voice recognition can be displayed.)

Setting

- Voice Recognition Settings
- Owner's Manual (the In-vehicle Digital Owner's Manual voice recognition can be displayed.)
- Display Off

Music

- Play Artist (You can also use "Play Artist {Artist name}").)
- Play Album (You can also use "Play Album {Album Name}").)
- Play Playlist (You can also use "Play Playlist {Playlist Name}").)
- Play Song (You can also use "Play Song {Song Name}").)
- Play Audiobook (You can also use "Play Audiobook {Audiobook Name}").)
- Play Podcast (You can also use "Play Podcast {Podcast Name}").)

Radio

- Tune to {Frequency} AM
- Tune to {Frequency} FM
- Tune to {Frequency} HD {Sub Channel}
- SiriusXM Channel {Channel Number}
- SiriusXM {Station Name}
- SiriusXM Genre (You can also use "SiriusXM {Genre Name}").)

Source

- Change Source (You can also use "Change Source to USB"*1 and "USB"*1.)
- Audio OFF (You can also use "Change Source to Audio OFF".)

Phone

- Dial Phone Number (You can also use "Dial {Phone Number}").)
- Call History
- Call a Contact (You can also use "Call {Contact Name}" and "Call {Contact Name} at {Number Type}").)
- Redial

*1 : Audio source names other than "USB" can also be used as follows:
Bluetooth/AM/FM/SiriusXM/Pandora/USB1 Audio/USB2 Audio/USB1 Video/
USB2 Video

▼ Appendix

Gracenote® Database

When connecting a USB audio device or Bluetooth® audio device to this unit and playing audio, the unit searches the database stored in the vehicle for the album art. If there is a match in the vehicle's database compilation to the music being played, the album art is displayed. The database information stored in this device uses database information in the Gracenote® music recognitions service.

SiriusXM Travel Link®*



ADVISORY ONLY

The weather information is subject to service interruptions and may contain errors or inaccuracies and consequently should not be relied upon exclusively. You are urged to check alternate weather information sources prior to making safety related decisions. You acknowledge and agree that you shall be solely responsible for use of the information and all decisions taken with respect thereto. By using this weather service, you release and waive any claims against Sirius XM Radio Inc. and Mazda Motor Corporation and all of their respective affiliates with regard to this service.

SiriusXM® Satellite Radio*



Products/applications shall display "Call [Appropriate Phone Number] to Enable Services" for any unsubscribed SiriusXM Data Service(s).

This shall be shown on the same screen as the Radio ID and the service subscription status:

Contact your SiriusXM Representative for the appropriate call center phone number.

- U.S.A.: 1-877-447-0011
- Canada: 1-877-438-9677

SiriusXM® All Access Subscription

Hopefully, you're already loving SiriusXM in your new Mazda. But don't stop there — you can also listen on the app and online. All Access is the very best subscription package — with the most channels and the most flexibility. With All Access, you get every channel available on your vehicle, plus you can listen on the app, online, and in your home on a variety of connected devices. — so you can enjoy SiriusXM wherever you are. Here's what's included:

- Over 150 satellite channels to enjoy in your car, coast-to-coast, 24/7.
- All kinds of commercial-free music, plus every major sport, world-class news and the biggest names in talk & entertainment.
- All of our premium programming, including Howard Stern, every NFL, MLB®, and NBA game, NHL® games, every NASCAR® race, 24/7 talk channels dedicated to the biggest leagues, and much more.

All SiriusXM services require a subscription, sold separately or as a package by SiriusXM Radio Inc. (or, in Canada, SiriusXM Canada Inc.), after any trial subscription which may be included with your vehicle purchase or lease. To subscribe after your trial subscription, call 1-877-447-0011 (U.S.A.) or 1-877-438-9677 (Canada).



It is prohibited to copy, decompile, disassemble, reverse engineer, hack, manipulate, or otherwise make available any technology or software incorporated in receivers compatible with the SiriusXM satellite radio service or that support the SiriusXM website, the online service or any of its content. Furthermore, the AMBE® voice compression software included in this product is protected by intellectual property rights including patent rights, copyrights, and trade secrets of Digital Voice Systems, Inc. The SiriusXM Service may include traffic, weather and other content and emergency alert information and data. Such information and data is not for “safety for life”, but is merely supplemental and advisory in nature and, therefore, cannot be relied upon as safety critical. Neither SiriusXM nor Mazda is responsible for any errors in accuracies in the SiriusXM data services or its use in applications. The SiriusXM content is subject to change without notice.

NOTE

SiriusXM Satellite Radio Service is available in the 48 contiguous United States and the District of Columbia. The service is not available in Alaska, Hawaii or Puerto Rico.

HD Radio™

What is HD Radio™ Technology and how does it work?

HD Radio™ Technology is the digital evolution of analog AM/FM radio. Your radio product has a special receiver which allows it to receive digital broadcasts (where available) in addition to the analog broadcasts it already receives. Digital broadcasts have better sound quality than analog broadcasts as digital broadcasts provide free, crystal clear audio. For more information, and a guide to available radio stations and programming, please visit www.hdradio.com.

Benefits of HD Radio™ Technology

(Information)

The song title, artist name, album name will appear on the screen when available by the radio station.

(Multicast)

On the FM radio frequency most digital stations have “multiple” or supplemental programs on each FM station.

HD Radio Technology manufactured under license from iBiquity Digital Corporation. U.S. and Foreign Patents.

For patents see <http://dts.com/patents>.

Apple CarPlay™



- YOU EXPRESSLY ACKNOWLEDGE AND AGREE THAT USE OF APPLE CARPLAY™ (“THE APPLICATION”) IS AT YOUR SOLE RISK AND THAT THE ENTIRE RISK AS TO SATISFACTORY QUALITY, PERFORMANCE, ACCURACY AND EFFORT IS WITH YOU TO THE MAXIMUM EXTENT PERMITTED BY APPLICABLE LAW, AND THAT THE APPLICATION AND INFORMATION ON THE APPLICATION IS PROVIDED “AS IS” AND “AS AVAILABLE”, WITH ALL FAULTS AND WITHOUT WARRANTY OF ANY KIND, AND MAZDA HEREBY DISCLAIMS ALL WARRANTIES AND CONDITIONS WITH RESPECT TO THE APPLICATION AND INFORMATION ON THE APPLICATION, EITHER EXPRESS, IMPLIED OR STATUTORY, INCLUDING, BUT NOT LIMITED TO, THE IMPLIED WARRANTIES AND/OR CONDITIONS OF MERCHANTABILITY, SATISFACTORY QUALITY, FITNESS FOR A PARTICULAR PURPOSE, ACCURACY, QUIET ENJOYMENT, AND NONINFRINGEMENT OF THIRD PARTY RIGHTS.

Mazda Connect

AS EXAMPLES, AND WITHOUT LIMITATION, MAZDA DISCLAIMS ANY WARRANTY REGARDING THE ACCURACY OF DATA PROVIDED BY THE APPLICATION, SUCH AS THE ACCURACY OF DIRECTIONS, ESTIMATED TRAVEL TIME, SPEED LIMITS, ROAD CONDITIONS, NEWS, WEATHER, TRAFFIC, OR OTHER CONTENT PROVIDED BY APPLE, ITS AFFILIATES, OR THIRD PARTY PROVIDERS; MAZDA DOES NOT GUARANTEE AGAINST LOSS OF APPLICATION DATA, WHICH MAY BE LOST AT ANY TIME; MAZDA DOES NOT GUARANTEE THAT THE APPLICATION OR ANY SERVICES PROVIDED THROUGH THEM WILL BE PROVIDED AT ALL TIMES OR THAT ANY OR ALL SERVICES WILL BE AVAILABLE AT ANY PARTICULAR TIME OR LOCATION. FOR EXAMPLE, SERVICES MAY BE SUSPENDED OR INTERRUPTED WITHOUT NOTICE FOR REPAIR, MAINTENANCE, SECURITY FIXES, UPDATES, ETC., SERVICES MAY BE UNAVAILABLE IN YOUR AREA OR LOCATION, ETC.

IN ADDITION, YOU UNDERSTAND THAT CHANGES IN THIRD PARTY TECHNOLOGY OR GOVERNMENT REGULATION MAY RENDER THE SERVICES AND/OR APPLICATIONS OBSOLETE AND/OR UNUSABLE. TO THE EXTENT NOT PROHIBITED BY LAW, IN NO EVENT SHALL MAZDA OR ITS AFFILIATES BE LIABLE FOR PERSONAL INJURY, OR ANY INCIDENTAL, SPECIAL, INDIRECT OR CONSEQUENTIAL DAMAGES WHATSOEVER, INCLUDING, WITHOUT LIMITATION, DAMAGES FOR LOSS OF PROFITS, CORRUPTION OR LOSS OF DATA, FAILURE TO TRANSMIT OR RECEIVE ANY DATA, BUSINESS INTERRUPTION OR ANY OTHER COMMERCIAL DAMAGES OR LOSSES, ARISING OUT OF OR RELATED TO THE APPLICATION OR YOUR USE OF OR INABILITY TO USE THE APPLICATION OR INFORMATION ON THE APPLICATION.

- When using Apple CarPlay™, please avoid distraction and use Apple CarPlay™ responsibly.
Stay fully aware of driving conditions and always obey applicable laws.

NOTE

- Apple CarPlay™ is provided by Apple® and its use is subject to your agreement to the Apple CarPlay™ terms of use, which are included as part of the Apple iOS terms of use.
- When using Apple CarPlay™, location, speed, and other vehicle data is transferred to your iPhone®. For further details, refer to Apple®'s Privacy Policy.

Android Auto™

CAUTION

➤ YOU EXPRESSLY ACKNOWLEDGE AND AGREE THAT USE OF ANDROID AUTO™ (“THE APPLICATION”) IS AT YOUR SOLE RISK AND THAT THE ENTIRE RISK AS TO SATISFACTORY QUALITY, PERFORMANCE, ACCURACY AND EFFORT IS WITH YOU TO THE MAXIMUM EXTENT PERMITTED BY APPLICABLE LAW, AND THAT THE APPLICATION AND INFORMATION ON THE APPLICATION IS PROVIDED “AS IS” AND “AS AVAILABLE,” WITH ALL FAULTS AND WITHOUT WARRANTY OF ANY KIND, AND MAZDA HEREBY DISCLAIMS ALL WARRANTIES AND CONDITIONS WITH RESPECT TO THE APPLICATION AND INFORMATION ON THE APPLICATION, EITHER EXPRESS, IMPLIED OR STATUTORY, INCLUDING, BUT NOT LIMITED TO, THE IMPLIED WARRANTIES AND/OR CONDITIONS OF MERCHANTABILITY, SATISFACTORY QUALITY, FITNESS FOR A PARTICULAR PURPOSE, ACCURACY, QUIET ENJOYMENT, AND NONINFRINGEMENT OF THIRD PARTY RIGHTS.

AS EXAMPLES, AND WITHOUT LIMITATION, MAZDA DISCLAIMS ANY WARRANTY REGARDING THE ACCURACY OF DATA PROVIDED BY THE APPLICATION, SUCH AS THE ACCURACY OF DIRECTIONS, ESTIMATED TRAVEL TIME, SPEED LIMITS, ROAD CONDITIONS, NEWS, WEATHER, TRAFFIC, OR OTHER CONTENT PROVIDED BY GOOGLE, ITS AFFILIATES, OR THIRD PARTY PROVIDERS; MAZDA DOES NOT GUARANTEE AGAINST LOSS OF APPLICATION DATA, WHICH MAY BE LOST AT ANY TIME; MAZDA DOES NOT GUARANTEE THAT THE APPLICATION OR ANY SERVICES PROVIDED THROUGH THEM WILL BE PROVIDED AT ALL TIMES OR THAT ANY OR ALL SERVICES WILL BE AVAILABLE AT ANY PARTICULAR TIME OR LOCATION. FOR EXAMPLE, SERVICES MAY BE SUSPENDED OR INTERRUPTED WITHOUT NOTICE FOR REPAIR, MAINTENANCE, SECURITY FIXES, UPDATES, ETC., SERVICES MAY BE UNAVAILABLE IN YOUR AREA OR LOCATION, ETC.

IN ADDITION, YOU UNDERSTAND THAT CHANGES IN THIRD PARTY TECHNOLOGY OR GOVERNMENT REGULATION MAY RENDER THE SERVICES AND/OR APPLICATIONS OBSOLETE AND/OR UNUSABLE. TO THE EXTENT NOT PROHIBITED BY LAW, IN NO EVENT SHALL MAZDA OR ITS AFFILIATES BE LIABLE FOR PERSONAL INJURY, OR ANY INCIDENTAL, SPECIAL, INDIRECT OR CONSEQUENTIAL DAMAGES WHATSOEVER, INCLUDING, WITHOUT LIMITATION, DAMAGES FOR LOSS OF PROFITS, CORRUPTION OR LOSS OF DATA, FAILURE TO TRANSMIT OR RECEIVE ANY DATA, BUSINESS INTERRUPTION OR ANY OTHER COMMERCIAL DAMAGES OR LOSSES, ARISING OUT OF OR RELATED TO THE APPLICATION OR YOUR USE OF OR INABILITY TO USE THE APPLICATION OR INFORMATION ON THE APPLICATION.

- When using Android Auto™, please avoid distraction and use Android Auto™ responsibly.
Stay fully aware of driving conditions and always obey applicable laws.

Mazda Connect

NOTE

- Android Auto™ is provided by Google and its use is subject to your agreement to the Android Auto™ terms of use.
- When using Android Auto™, location, speed, and other vehicle data is transferred to your smart phone. For further details, refer to Google Privacy Policy.

Trademark

- Pandora®, the Pandora® logo, and the Pandora® trade dress are trademarks or registered trademarks of Pandora Media, Inc., used with permission.
- HD Radio™ and the HD, HD Radio, and “Arc” logos are proprietary trademarks of iBiquity Digital Corp.



- iPhone, iPod touch, iPod nano, Siri and Apple Music are registered trademarks of Apple Inc.
- Apple CarPlay is trademarks of Apple Inc.
- iOS is a trademark or registered trademark of Cisco in the U.S. and other countries and is used under license.
- “Made for iPhone” and “Made for iPod” mean that an accessory has been designed to connect specifically to iPhone or iPod, and has been certified by the developer to meet Apple performance standards. Apple is not responsible for the operation of this device or its compliance with safety and regulatory standards. Please note that the use of this accessory with iPhone or iPod may affect wireless performance.

Made for
iPhone 7 Plus
iPhone 7
iPhone SE
iPhone 6s Plus
iPhone 6s
iPhone 6 Plus
iPhone 6
iPhone 5s
iPhone 5c
iPhone 5
iPhone 4s
iPod touch (6th generation)
iPod touch (5th generation)

iPod nano (7th generation)



- Google, Android, Android Auto and other related marks are trademarks of Google LLC.
- AudioPilot is a registered trademark of Bose Corporation.
- Centerpoint is a registered trademark of Bose Corporation.
- Windows Media and Microsoft are registered trademarks of Microsoft Corporation U.S. in the United States and other countries.
This product is protected by certain intellectual property rights of Microsoft Corporation and third parties.
Use or distribution of such technology outside of this product is prohibited without a license from Microsoft or an authorized Microsoft subsidiary and third parties.
- The Bluetooth® word mark and logos are registered trademarks owned by Bluetooth SIG, Inc. and any use of such marks by Panasonic Corporation is under license. Other trademarks and trade names are those of their respective owners.



- SDHC Logo is a trademark of SD-3C, LLC.



- Gracenote, the Gracenote logo and logotype are either a registered trademark or a trademark of Gracenote, Inc. in the United States and/or other countries.



Regarding the license for the audio amplifier (except vehicles with Bose audio)

License for CMSIS-RTOS RTX Implementation

Copyright (c) 1999-2009 KEIL, 2009-2015 ARM Germany GmbH, 2013-2016 ARM Ltd All rights reserved.

Redistribution and use in source and binary forms, with or without modification, are permitted provided that the following conditions are met:

- Redistributions of source code must retain the above copyright notice, this list of conditions and the following disclaimer
- Redistributions in binary form must reproduce the above copyright notice, this list of conditions and the following disclaimer in the documentation and/or other materials provided with the distribution.
- Neither the name of ARM nor the names of its contributors may be used to endorse or promote products derived from this software without specific prior written permission.

THIS SOFTWARE IS PROVIDED BY THE COPYRIGHT HOLDERS AND CONTRIBUTORS "AS IS" AND ANY EXPRESS OR IMPLIED WARRANTIES, INCLUDING, BUT NOT LIMITED TO, THE IMPLIED WARRANTIES OF MERCHANTABILITY AND FITNESS FOR A PARTICULAR PURPOSE ARE DISCLAIMED. IN NO EVENT SHALL COPYRIGHT HOLDERS AND CONTRIBUTORS BE LIABLE FOR ANY DIRECT, INDIRECT, INCIDENTAL, SPECIAL, EXEMPLARY, OR CONSEQUENTIAL DAMAGES (INCLUDING, BUT NOT LIMITED TO, PROCUREMENT OF SUBSTITUTE GOODS OR SERVICES; LOSS OF USE, DATA, OR PROFITS; OR BUSINESS INTERRUPTION) HOWEVER CAUSED AND ON ANY THEORY OF LIABILITY, WHETHER IN CONTRACT, STRICT LIABILITY, OR TORT (INCLUDING NEGLIGENCE OR OTHERWISE) ARISING IN ANY WAY OUT OF THE USE OF THIS SOFTWARE, EVEN IF ADVISED OF THE POSSIBILITY OF SUCH DAMAGE.

Connected Service (U.S.A only)

▼ Connected Service Overview

There are several types of connected services available via Mazda Connect. Some services may require you to download the MyMazda app to your smartphone and subscribe to the services, while others may require you to pair your smartphone to the vehicle via Bluetooth®. In addition, on a regular basis and unless you opt-out, your vehicle will automatically transmit certain geo-location, driving behavior data, and vehicle health information to Mazda for product quality, data analysis, research, and product development. Using the QR codes or URLs below, refer to the Connected Service Owner's Manual and Privacy Policy for more details and opt-out options.

- Connected Service Owner's Manual
<https://www.mazdausa.com/static/manuals/mazda-connected-service/index.html>



Privacy

Mazda maintains a Privacy Statement which describes how we collect, use, share, store and secure data from your vehicle equipped with connected services. We provide you with connected services by collecting and using your personal information and vehicle location, health and driving data. To learn more about our Privacy Statement, please visit: <https://www.mazdausa.com/site/privacy-connectedservices>



Interior Equipment

Sunvisors

▼ Sunvisors

Lower the sunvisor to block sunlight from the front.
To block sunlight from the side, lower and unhook the sunvisor, and then swing it to the side.

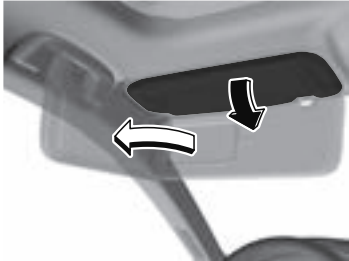

▼ Side Extension Sunvisors*

The visor extender extends the sunvisor's range of sun shading. To use, pull it out.

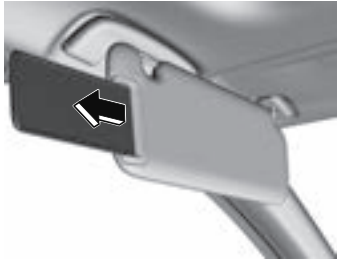

When moving the sunvisor, retract the visor extender to its original position. Otherwise, the visor extender could hit the rearview mirror.

▼ Vanity Mirrors

To use the vanity mirror, lower the sunvisor.
If your vehicle is equipped with a vanity mirror light, it will illuminate when you open the cover. The vanity mirror will only illuminate in the tilt range shown in the figure.

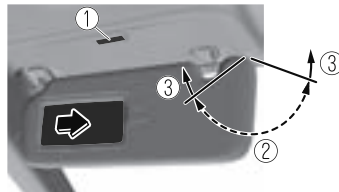

- 1. Vanity mirror light
- 2. On
- 3. Off

NOTE

If a vanity mirror light is left on with the ignition switched OFF, the light is turned off automatically to prevent the battery from being discharged.

The vanity mirror light can be turned on again by doing any of the following operations:

- Opening/closing any door.
- Unlocking any door.
- Switching the ignition to ACC or ON.
- Switching an overhead light/front map light on.

Interior Lights

▼ Interior Lights

NOTE

Do not leave the lights on for long periods while the engine is turned off. Otherwise the battery power could be depleted.

Overhead lights

Front

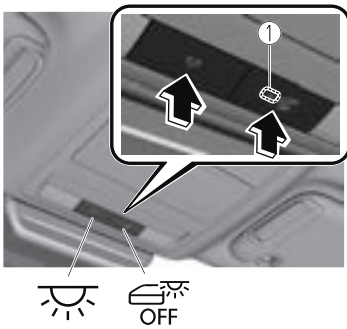

1. Indicator light

Switch	Overhead Lights
 ON/OFF	Press the switch to turn it on. Press the switch again to turn off the lights.

Switch	Overhead Lights
 DOOR OFF	<p>The door interlock can be switched ON/OFF. When the door interlock is OFF, the indicator light in the switch turns on.</p> <p>Door interlock ON (indicator light in switch is off)</p> <ul style="list-style-type: none"> • The lights turn on when any of the doors is opened. • The lights turn on/off in conjunction with the illuminated entry system. <p>Door interlock OFF (indicator light in switch is on)</p> <ul style="list-style-type: none"> • The lights do not turn on even if any of the doors is opened. • The lights do not turn on/off in conjunction with the illuminated entry system.

Rear

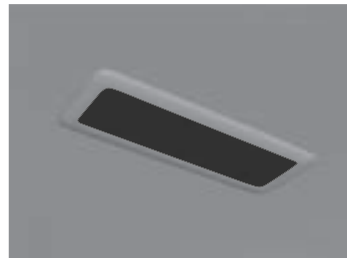

NOTE

The rear overhead light also turn on and off when the front overhead light switch is operated.

Interior Equipment

Map lights

Press the switch to illuminate the map lights, and then press the switch again to turn them off.



NOTE

The map lights will not turn off even if the switch is pressed in the following cases:

- The overhead lights turn on by operating the overhead light ON/OFF switch ().
- The overhead lights turn on in conjunction with a door opening/closing.
- The illuminated entry system is on.

Trunk light (4-door)

The trunk light is on when the trunk is open and off when it is closed.



NOTE

Do not leave the trunk open for long periods while the engine is turned off. Otherwise the battery power could be depleted.

Luggage compartment light (5-door)

The luggage compartment light is on when the liftgate is open and off when it is closed.



NOTE

Do not leave the liftgate open for long periods while the engine is turned off. Otherwise the battery power could be depleted.

▼ Illuminated Entry System

The overhead lights turn on when any of the following operations is done with the overhead light switch in the DOOR position.

- The driver's door is unlocked with the ignition is switched OFF.
- The ignition is switched OFF with all doors closed.

NOTE

- The illumination time differs depending on the operation.
- The vehicle is equipped with a battery saver. If an interior light is left on with the ignition switched OFF, the light turns off automatically after a certain period of time has passed to prevent battery depletion.
- The operation of the illuminated entry system can be changed. Refer to the Settings section in the Mazda Connect Owner's Manual.
- The illuminated entry system does not operate in conjunction with the overhead lights when the overhead lights are turned on using the overhead light ON/OFF switch.

Accessory Socket

▼ Accessory Socket

Only use genuine Mazda accessories or the equivalent requiring no greater than 120 W (DC 12 V, 10 A).

The accessory socket can be used regardless of whether the ignition is on or off.



⚠ CAUTION

- To prevent accessory socket damage or electrical failure, pay attention to the following:
 - Do not use accessories that require more than 120 W (DC 12 V, 10 A).
 - Do not use accessories that are not genuine Mazda accessories or the equivalent.
 - Close the cover when the accessory socket is not in use to prevent foreign objects and liquids from getting into the accessory socket.
 - Correctly insert the plug into the accessory socket.
 - Do not insert the cigarette lighter into the accessory socket.
- Noise may occur on the audio playback depending on the device connected to the accessory socket.

Interior Equipment

➤ Depending on the device connected to the accessory socket, the vehicle's electrical system may be affected, which could cause the warning light to illuminate. Disconnect the connected device and make sure that the problem is resolved. If the problem is resolved, disconnect the device from the socket and switch the ignition off. If the problem is not resolved, consult an Authorized Mazda Dealer.

NOTE

To prevent discharging of the battery, do not use the socket for long periods with the engine off or idling.

Connecting the accessory socket

1. Open the lid.
2. Pass the connection plug cord through the cutout of the console and insert the plug into the accessory socket.

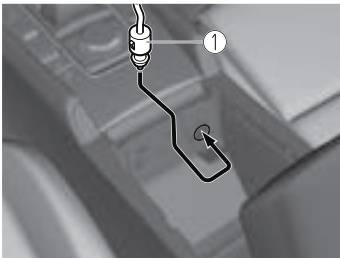

1. Plug

Cup Holder

▼ Cup Holder

⚠ WARNING

Never use a cup holder to hold hot liquids while the vehicle is moving: Using a cup holder to hold hot liquids while the vehicle is moving is dangerous. If the contents spill, you could be scalded.

Do not put anything other than cups or drink cans in cup holders:

Putting objects other than cups or drink cans in a cup holder is dangerous.

During sudden braking or maneuvering, occupants could be hit and injured, or objects could be thrown around the vehicle, causing interference with the driver and the possibility of an accident. Only use a cup holder for cups or drink cans.

▼ **Front**

Type A



Type B

To use the cup holder, push the release button.



▼ **Rear***

The rear cup holder is on the rear center armrest.



Interior Equipment

Bottle Holder

▼ Bottle Holder

Bottle holders are on the inside of the doors.

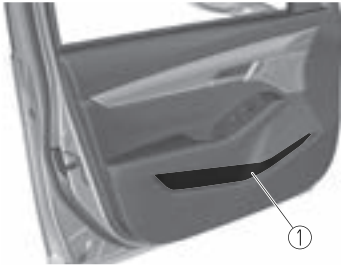

1. Bottle holder

! CAUTION

Do not use the bottle holders for containers without caps. The contents may spill when opening/closing the door or while driving the vehicle.

Assist Grips

▼ Assist Grips

! WARNING

Never hang heavy or sharp objects on the assist grips and coat hooks:

Hanging heavy or sharp-ended objects such as a coat hanger from the assist grips or coat hooks is dangerous as they can fly off and hit an occupant in the cabin if a curtain air bag was to deploy, which could result in serious injury or death.

Do not use the assist grips when getting in and out of the vehicle or getting out of a seat:

An assist grip could break under a heavy load resulting in injury.

Use the assist grips to support your body while seated in the vehicle and while the vehicle is moving.



Rear Coat Hooks

▼ Rear Coat Hooks

WARNING

Never hang heavy or sharp objects on the assist grips and coat hooks:

Hanging heavy or sharp-ended objects such as a coat hanger from the assist grips or coat hooks is dangerous as they can fly off and hit an occupant in the cabin if a curtain air bag was to deploy, which could result in serious injury or death.

Always hang clothes on the coat hooks and the assist grips without hangers.



Storage Compartments

▼ Storage Compartments

WARNING

Keep storage boxes closed when driving:

Driving with the storage boxes open is dangerous. To reduce the possibility of injury in an accident or a sudden stop, keep the storage boxes closed when driving.

When loading cargo, make sure that it is completely secured:

If the cargo is not completely secured, it may move or collapse while driving or during sudden braking, resulting in injury or an accident.

Do not put articles in storage spaces with no lid:

Putting articles in storage spaces with no lid is dangerous as they could be thrown around the cabin during sudden braking, maneuvering, or acceleration and cause an accident depending on how the article is stored.

CAUTION

Do not leave lighters or eyeglasses in the storage boxes while parked under the sun. A lighter could explode or the plastic material in eyeglasses could deform and crack from high temperature.

Interior Equipment

▼ Overhead Console*

This console box is designed to store eyeglasses or other accessories. Push and release to open.

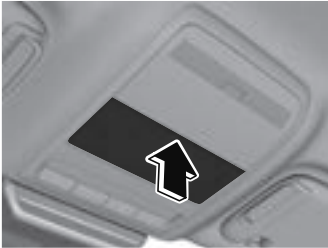

▼ Storage Pocket

To use, open the lid.



▼ Glove Compartment

To open the glove compartment, pull the knob toward you.



To close the glove compartment, firmly press in the center of the glove compartment lid.

▼ Center Console

To slide the console lid, pull the knob and slide it rearward.

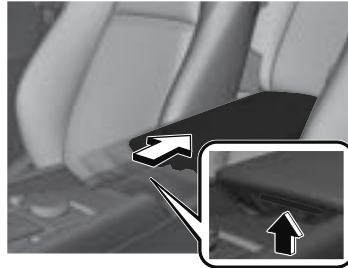

To open the lid, pull the knob, slide the lid rearward, and then lift up the lid.



⚠ CAUTION

Do not put your hands or fingers around the moving parts of the lid when using the lid. Otherwise, your hand or finger could get caught, resulting in an injury.

NOTE

The lid can be opened/closed while it is slid to the 1st and 2nd stages, but if the rear seatback is folded, the lid cannot be opened/closed while it is slid to the 2nd stage because the rear seat (head restraint) will contact it.

Center console divider



Small items can be placed using the center console divider.

▼ Luggage Compartment

NOTE

Loading golf bags (4-door)

(Some golf bags may not fit using the following methods depending on their sizes.)

Up to two golf bags can be carried in the trunk.

First golf bag: Place the golf bag in the luggage compartment with its bottom pointed to the left and fit it into the front of the compartment.

Second golf bag: Place the golf bag in the luggage compartment with its bottom pointed to the left and fit it into the back of the compartment.

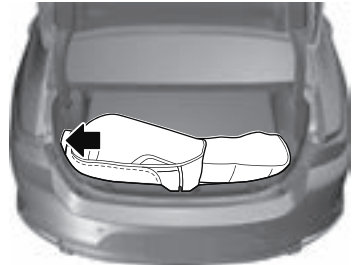

- The arrows indicate the bottoms of the golf bags.

MEMO

6

Maintenance and Care

How to keep your Mazda in top condition.

Essential Information.....	6-2	Brake/Clutch Fluid.....	6-21
Introduction.....	6-2	Washer Fluid.....	6-22
Scheduled Maintenance.....	6-4	Body Lubrication.....	6-23
Scheduled Maintenance.....	6-4	Wiper Blades.....	6-23
Owner Maintenance.....	6-12	Battery.....	6-29
Owner Maintenance		Key Battery Replacement.....	6-31
Precautions.....	6-12	Tires.....	6-33
Hood.....	6-13	Light Bulbs.....	6-37
Engine Compartment		Fuses.....	6-40
Overview.....	6-15	Appearance Care.....	6-48
Engine Oil.....	6-17	Exterior Care.....	6-48
Engine Coolant.....	6-20	Interior Care.....	6-54

Introduction

▼ Introduction

Be careful not to hurt yourself when inspecting your vehicle, replacing a tire, or doing some kind of maintenance such as changing the oil and filter. In particular, wear thick work gloves such as cotton gloves when touching areas that are difficult to see while inspecting or working on your vehicle. Doing inspections or procedures with your bare hands could cause injury.

If you are unsure about any procedure this manual describes, we strongly urge you to have a reliable and qualified service shop perform the work, preferably an Authorized Mazda Dealer.

Factory-trained Mazda technicians and genuine Mazda parts are best for your vehicle. Without this expertise and the parts that have been designed and made especially for your Mazda, inadequate, incomplete, and insufficient servicing may result in problems. This could lead to vehicle damage or an accident and injuries.

For expert advice and quality service, consult an Authorized Mazda Dealer.

To continue warranty eligibility and to protect your investment, it is your responsibility to properly maintain your vehicle according to factory recommended schedules outlined in this manual. As part of this you must keep your maintenance records, receipts, repair orders and any other documents as evidence this maintenance was performed. You must present these documents, should any warranty coverage disagreement occur. Failure to do so can result in your warranty being voided either in whole or in part.

This evidence may consist of the following:

- The Mazda Scheduled Maintenance Record, refer to the Warranty Booklet, must be completely filled out showing mileage, repair order number, date for each service, and signed by a qualified automotive service technician who service vehicles.
- Original copies of repair orders or other receipts that include the mileage and date the vehicle was serviced. Each receipt should be signed by a qualified automotive service technician.
- For self maintenance, a statement that you completed the maintenance yourself, displaying mileage and the date the work was performed. Also, receipts for the replacement parts (fluid, filters, etc.) indicating the date and mileage must accompany this statement.

NOTE

If you elect to perform maintenance yourself or have your vehicle serviced at a location other than an Authorized Mazda Dealer, Mazda requires that all fluids, parts and materials must meet Mazda standards for durability and performance as described in this manual.

Claims against the warranty resulting from lack of maintenance, as opposed to defective materials or authorized Mazda workmanship, will not be honored.

Any auto repair shop using parts equivalent to your Mazda's original equipment may perform maintenance.

But we recommend that it always be done by an Authorized Mazda Dealer using genuine Mazda parts.

Selecting "Vehicle Status Monitor" enables the system to notify you of your vehicle's approaching inspection/servicing period. Refer to the Information section in the Mazda Connect Owner's Manual.

The malfunction diagnosis connector is designed exclusively for connecting the specially designed device to perform on-board diagnosis.

Do not connect any devices other than the specially designed malfunction diagnosis devices for servicing. If any device other than the malfunction diagnosis device is connected, it may affect the vehicle's electrical devices or lead to damage such as battery depletion.

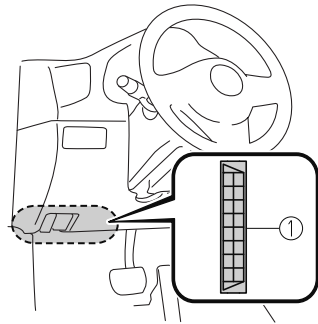

1. Malfunction diagnosis connector

Scheduled Maintenance

Scheduled Maintenance

▼ Scheduled Maintenance (U.S.A. and Puerto Rico)

Vehicles utilizing the vehicle status monitor feature:

The vehicle status monitor feature alerts you of maintenance needs by turning on the wrench indicator light or displaying a message in the instrument panel, or both.

Every maintenance must be done when the display/wrench indication comes on.

The display/wrench indication will come on before reaching the maximum interval of 16,000 km (10,000 miles), or 12 months (after the previous maintenance).

If you drive your vehicle under any of the following conditions, follow the Severe Driving Scheduled Maintenance and replace the engine oil and filter every 8,000 km (5,000 miles) or 6 months, whichever comes first.

Otherwise, follow the Normal Driving Scheduled Maintenance intervals.

1. The vehicle is idled for long periods or driven at low speeds, such as with police cars, taxis, or driver's education school car.
2. Driving under dusty conditions.
3. Driving for long periods in cold temperatures or driving regularly for short distances only.
4. Driving under extremely high temperature conditions.
5. Driving continuously in mountainous regions.

If you are following the Severe Driving Scheduled Maintenance (8,000 km (5,000 miles) or 6 months oil replacement interval), set the vehicle status monitor manually. Refer to the Information section in the Mazda Connect Owner's Manual. Please contact an Authorized Mazda Dealer if necessary.

USA and Puerto Rico Residents (Normal Driving Scheduled Maintenance):

Maintenance Item		Number of times, maintenance was performed.							
		1	2	3	4	5	6	7	8
Engine oil & filter* ¹		R	R	R	R	R	R	R	R
Spark plugs	SKYACTIV-G 2.5T	Replace every 64,000 km (40,000 miles).							
	Except SKY-ACTIV-G 2.5T	Replace every 120,000 km (75,000 miles).							
Air filter				R			R		
Drive belts		I	I	I	I	I	I	I	I
Engine coolant level		I	I	I	I	I	I	I	I
Engine coolant* ²		Replace at first 192,000 km (120,000 miles) or 120 months; after that, every 96,000 km (60,000 miles) or 60 months.							
Fuel lines & hoses* ³			I		I		I		I
Hoses and tubes for emission* ³					I				I

Maintenance Item		Number of times, maintenance was performed.							
		1	2	3	4	5	6	7	8
Brake lines, hoses and connections			I		I		I		I
Vacuum brake booster and hose	With vacuum booster		I		I		I		I
Brake and clutch fluid level		I	I	I	I	I	I	I	I
Brake fluid	With electrical booster		R		R		R		R
Disc brakes		I	I	I	I	I	I	I	I
Tire rotation		Rotate every 16,000 km (10,000 miles).							
Tire inflation pressure and tire wear ^{*4}		I	I	I	I	I	I	I	I
Steering operation and linkages			I		I		I		I
Front and rear suspension, ball joints and wheel bearing axial play			I		I		I		I
Driveshaft dust boot			I		I		I		I
Bolts and nuts on chassis and body			T		T		T		T
Exhaust system and heat shields					I				I
Emergency flat tire repair kit (if equipped) ^{*5}		Inspect annually.							
Cabin air filter		Replace every 48,000 km (30,000 miles) or 24 months.							
Function of all lights		I	I	I	I	I	I	I	I

Chart symbols:

- I:** Inspect: Inspect and clean, repair, adjust, fill up, or replace if necessary.
- R:** Replace
- T:** Tighten

Remarks:

- ^{*1} Reset the engine oil data whenever replacing the engine oil regardless of the message/wrench indicator light display.
- ^{*2} Use of FL-22 is recommended when replacing engine coolant. Using engine coolant other than FL-22 may cause serious damage to the engine and cooling system.
- ^{*3} According to state/provincial and federal regulations, failure to perform maintenance on these items will not void your emissions warranties. However, Mazda recommends that all maintenance services be performed at the recommended time or mileage/kilometer period to ensure long-term reliability.
- ^{*4} Inspect a spare tire if equipped.
- ^{*5} Check the tire repair fluid expiration date every year when performing the periodic maintenance. Replace the tire repair fluid bottle with new one before the expiration date.

Scheduled Maintenance

USA and Puerto Rico Residents (Severe Driving Scheduled Maintenance):

Number of months or kilometers (miles), whichever comes first.								
Months	6	12	18	24	30	36	42	48
× 1000 km	8	16	24	32	40	48	56	64
× 1000 miles	5	10	15	20	25	30	35	40
Engine oil & filter ^{*1}	R	R	R	R	R	R	R	R
Maintenance Interval (other than engine oil & filter replacement) ^{*2}		1st		2nd		3rd		4th

Chart symbols:

R: Replace

Remarks:

^{*1} Reset the engine oil data whenever replacing the engine oil regardless of the message/wrench indicator light display.

^{*2} Follow Maintenance Interval listed in Normal Driving Scheduled Maintenance.

▼ Scheduled Maintenance (Canada)

Vehicles utilizing the vehicle status monitor feature:

The vehicle status monitor feature alerts you of engine oil replacement by turning on the wrench indicator light or displaying a message in the instrument panel, or both. Every engine oil replacement must be done when the display/wrench indication comes on. The display/wrench indication will come on before reaching the maximum interval of 16,000 km (10,000 miles), or 12 months (after the previous maintenance).

If you are following 8,000 km (5,000 miles) or 6 months maintenance interval, set the vehicle status monitor manually.

Refer to the owner's manual section of mazda.ca for the Mazda Connect owner's manual or contact an Authorized Mazda Dealer if necessary.

Canada residents

Maintenance Interval	Number of months or kilometers (miles), whichever comes first.												
	Months	6	12	18	24	30	36	42	48	54	60	66	72
	× 1000 km	8	16	24	32	40	48	56	64	72	80	88	96
	× 1000 miles	5	10	15	20	25	30	35	40	45	50	55	60
Engine oil & filter ^{*1*2}	Replace when the wrench indicator light is ON. (Upper limit interval is 16,000 km (10,000 miles) or 12 months.)												

Maintenance and Care
Scheduled Maintenance

Maintenance Interval	Number of months or kilometers (miles), whichever comes first.												
	Months	6	12	18	24	30	36	42	48	54	60	66	72
	×1000 km	8	16	24	32	40	48	56	64	72	80	88	96
	×1000 miles	5	10	15	20	25	30	35	40	45	50	55	60
Spark plugs	SKYACTIV-G 2.5T	Replace every 64,000 km (40,000 miles).											
	Except SKYACTIV-G 2.5T	Replace every 120,000 km (75,000 miles).											
Air filter	Replace every 56,000 km (35,000 miles) or 36 months.												
Drive belts ^{*3}							I						I
Engine coolant level		I	I	I	I	I	I	I	I	I	I	I	I
Engine coolant ^{*4}	Replace at first 192,000 km (120,000 miles) or 120 months; after that, every 96,000 km (60,000 miles) or 60 months.												
Fuel lines & hoses ^{*5}				I					I				I
Hoses and tubes for emission ^{*5}									I				
Brake lines, hoses and connections				I					I				I
Vacuum brake booster and hose	With vacuum booster		I		I			I			I		I
Brake fluid	With electrical booster				R				R				R
Disc brakes			I	C/L	I			I/C/L		I	C/L	I	I/C/L
Tire rotation	Rotate every 8,000 km (5,000 miles).												
Tire inflation pressure and tire wear ^{*6}	I	I	I	I	I	I	I	I	I	I	I	I	I
Steering operation and linkages				I					I				I
Front and rear suspension, ball joints and wheel bearing axial play				I					I				I
Body condition inspection for rust, corrosion and perforation		I		I			I		I		I		I
Driveshaft dust boot				I					I				I
Bolts and nuts on chassis and body				T					T				T
Exhaust system and heat shields									I				
Emergency flat tire repair kit (if equipped) ^{*7}	Inspect annually.												
Cabin air filter	Replace every 40,000 km (25,000 miles) or 24 months.												

Scheduled Maintenance

Chart symbols:

I: Inspect and clean, repair, adjust, fill up, or replace if necessary.

R: Replace

C: Clean

L: Lubricate

T: Tighten

Remarks:

- *1 Reset the engine oil data whenever replacing the engine oil regardless of the message/wrench indicator light display.
- *2 If you drive your vehicle under any of the following conditions, replace the engine oil & filter every 8,000 km (5,000 miles) or 6 months, whichever comes first.
 - 1. The vehicle is idled for long periods or driven at low speeds, such as with police cars, taxis, or driver's education school vehicles.
 - 2. Driving under dusty conditions.
 - 3. Driving for long periods in cold temperatures or driving regularly for short distances only.
 - 4. Driving under extremely high temperature conditions.
 - 5. Driving continuously in mountainous regions.
- *3 Also inspect the air conditioner drive belts, if equipped.
If the vehicle is operated primarily under any of the following conditions, inspect the drive belts more often than the recommended intervals.
 - a) Driving under dusty conditions.
 - b) The vehicle is idled for long periods or driven at low speeds.
 - c) Driving for long periods in cold temperatures or driving regularly for short distances only.
 - d) Driving under extremely high temperature conditions.
 - e) Driving continuously in mountainous regions.
 - f) Driving for long period in extremely wet or heavy rain condition.
- *4 Use of FL-22 is recommended when replacing engine coolant. Using engine coolant other than FL-22 may cause serious damage to the engine and cooling system.
- *5 According to state/provincial and federal regulations, failure to perform maintenance on these items will not void your emissions warranties. However, Mazda recommends that all maintenance services be performed at the recommended time or mileage/kilometer period to ensure long-term reliability.
- *6 Inspect a spare tire if equipped.
- *7 Check the tire repair fluid expiration date every year when performing the periodic maintenance. Replace the tire repair fluid bottle with a new one before the expiration date.

▼ Scheduled Maintenance (Mexico)

Vehicles utilizing the vehicle status monitor feature:

The vehicle status monitor feature alerts you of maintenance needs by turning on the wrench indicator light or displaying a message in the instrument panel, or both.

Every maintenance must be done when the display/wrench indication comes on.

The display/wrench indication will come on before reaching the maximum interval of 10,000 km, or 6 months (after the previous maintenance).

If you drive your vehicle under any of the following conditions, follow the Severe Driving Scheduled Maintenance and replace the engine oil and filter every 5,000 km or 3 months, whichever comes first.

Otherwise, follow the Normal Driving Scheduled Maintenance intervals.

1. The vehicle is idled for long periods or driven at low speeds, such as with police cars, taxis, or driver's education school car.
2. Driving under dusty conditions.
3. Driving for long periods in cold temperatures or driving regularly for short distances only.
4. Driving under extremely high temperature conditions.
5. Driving continuously in mountainous regions.

If you are following the Severe Driving Scheduled Maintenance (5,000 km or 3 months oil replacement interval), set the vehicle status monitor manually.

Refer to the Information section in the Mazda Connect Owner's Manual. Please contact an Authorized Mazda Dealer if necessary.

Mexico Residents (Normal Driving Scheduled Maintenance):

Maintenance Item		Number of times, maintenance was performed.							
		1	2	3	4	5	6	7	8
Engine oil & filter* ¹		R	R	R	R	R	R	R	R
Spark plugs	SKYACTIV-G 2.5T	I	I	I	I	I	I	I	I
	Replace every 64,000 km								
Spark plugs	Except SKYACTIV-G 2.5T	I	I	I	I	I	I	I	I
	Replace every 120,000 km.								
Air filter			R		R		R		R
Drive belts		I	I	I	I	I	I	I	I
Engine coolant level		I	I	I	I	I	I	I	I
Engine coolant* ²		Replace at first 192,000 km or 120 months; after that, every 96,000 km or 60 months.							
Fuel lines & hoses* ³					I				I
Hoses and tubes for emission* ³					I				I
Fuel filter		Replace every 60,000 km.							

Scheduled Maintenance

Maintenance Item		Number of times, maintenance was performed.							
		1	2	3	4	5	6	7	8
Brake lines, hoses and connections			I		I		I		I
Vacuum brake booster and hose	With vacuum booster		I		I		I		I
Brake and clutch fluid level		I	I	I		I	I	I	
Brake fluid					R				R
Disc brakes		I	I	I	I	I	I	I	I
Tire rotation		Rotate every 10,000 km.							
Tire inflation pressure and tire wear* ⁴		I	I	I	I	I	I	I	I
Steering operation and linkages		I	I	I	I	I	I	I	I
Front and rear suspension, ball joints and wheel bearing axial play			I		I		I		I
Driveshaft dust boot			I		I		I		I
Bolts and nuts on chassis and body			T		T		T		T
Exhaust system and heat shields			I		I		I		I
Emergency flat tire repair kit (if equipped)* ⁵		Inspect annually.							
Cabin air filter		Replace every 40,000 km or 24 months.							
Function of all lights		I	I	I	I	I	I	I	I

Chart symbols:

I: Inspect: Inspect and clean, repair, adjust, fill up, or replace if necessary.

R: Replace

T: Tighten

Remarks:

- *1 Reset the engine oil data whenever replacing the engine oil regardless of the message/wrench indicator light display.
- *2 Use of FL-22 is recommended when replacing engine coolant. Using engine coolant other than FL-22 may cause serious damage to the engine and cooling system.
- *3 According to state/provincial and federal regulations, failure to perform maintenance on these items will not void your emissions warranties. However, Mazda recommends that all maintenance services be performed at the recommended time or mileage/kilometer period to ensure long-term reliability.
- *4 Inspect a spare tire if equipped.
- *5 Check the tire repair fluid expiration date every year when performing the periodic maintenance. Replace the tire repair fluid bottle with new one before the expiration date.

Mexico Residents (Severe Driving Scheduled Maintenance):

Number of months or kilometers , whichever comes first.								
Months	3	6	9	12	15	18	21	24
× 1000 km	5	10	15	20	25	30	35	40
Engine oil & filter* ¹	R	R	R	R	R	R	R	R
Maintenance Interval (other than engine oil & filter replacement)* ²		1st		2nd		3rd		4th

Chart symbols:

R: Replace

Remarks:

- *1 Reset the engine oil data whenever replacing the engine oil regardless of the message/wrench indicator light display.
- *2 Follow Maintenance Interval listed in Normal Driving Scheduled Maintenance.

Owner Maintenance Precautions

▼ Owner Maintenance Precautions

The owner or a qualified service technician should make these vehicle inspections at the indicated intervals to ensure safe and dependable operation.

Bring any problem to the attention of an Authorized Mazda Dealer or qualified service technician as soon as possible.

When Refueling

- Brake and clutch fluid level (page 6-21)
- Engine coolant level (page 6-20)
- Engine oil level (page 6-19)
- Washer fluid level (page 6-22)

At Least Monthly

- Tire inflation pressures (page 6-34)

At Least Twice a Year (For Example, Every Spring and Fall)

You can do the following scheduled maintenance items if you have some mechanical ability and a few basic tools and if you closely follow the directions in this manual.

- Engine coolant (page 6-20)
- Engine oil (page 6-19)

Improper or incomplete service may result in problems. This section gives instructions only for items that are easy to perform.

As explained in the Introduction (page 6-2), several procedures can be done only by a qualified service technician with special tools.

Improper owner maintenance during the warranty period may affect warranty coverage. Refer to Introduction (page 6-2) for owner's responsibility in protecting your investment. For details, read the separate Mazda Warranty statement provided with the vehicle. If you are unsure about any servicing or maintenance procedure, have it done by an Authorized Mazda Dealer.

There are strict environmental laws regarding the disposal of waste oil and fluids. Please dispose of your waste properly and with due regard to the environment.

We recommend that you entrust the oil and fluid changes of your vehicle to an Authorized Mazda Dealer.

WARNING

Do not perform maintenance work if you lack sufficient knowledge and experience or the proper tools and equipment to do the work. Have maintenance work done by a qualified technician:

Performing maintenance work on a vehicle is dangerous if not done properly. You can be seriously injured while performing some maintenance procedures.

If you must run the engine while working under the hood, make certain that you remove all jewelry (especially rings, bracelets, watches, and necklaces) and all neckties, scarves, and similar loose clothing before getting near the engine or cooling fan which may turn on unexpectedly:

Working under the hood with the engine running is dangerous. It becomes even more dangerous when you wear jewelry, loose clothing or have long hair or a long beard. Either can become entangled in moving parts and result in injury.



Pull over to a safe location, then switch the ignition off and make sure the fan is not running before attempting to work near the cooling fan:

Working near the cooling fan when it is running is dangerous. The fan could continue running indefinitely even if the engine has stopped and the engine compartment temperature is high. You could be hit by the fan and seriously injured.

Do not leave items in the engine compartment:

After you have finished checking or doing servicing in the engine compartment, do not forget and leave items such as tools or rags in the engine compartment. Tools or other items left in the engine compartment could cause engine damage or a fire leading to an unexpected accident.

Hood

▼ Hood

WARNING

Always check that the hood is closed and securely locked:

A hood that is not closed and securely locked is dangerous as it could fly open while the vehicle is moving and block the driver's vision which could result in a serious accident.

▼ Opening the Hood

1. With the vehicle parked, pull the release handle to unlock the hood.



2. Insert your hand into the hood opening, slide the latch lever in the direction of the arrow as shown in the illustration, and lift up the hood.

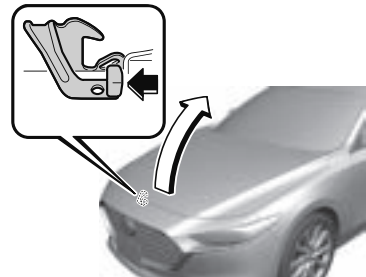

Owner Maintenance

3. Grasp the support rod in the padded area and secure it in the support rod hole indicated by the arrow to hold the hood open.

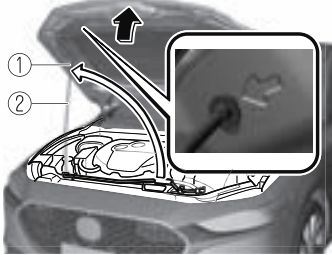

1. Pad
2. Support rod

▼ Closing the Hood

1. Check under the hood area to make certain all filler caps are in place and all loose items (e.g. tools, oil containers, etc.) have been removed.

2. Lift the hood, grasp the padded area on the support rod, and secure the support rod in the clip. Verify that the support rod is secured in the clip before closing the hood.

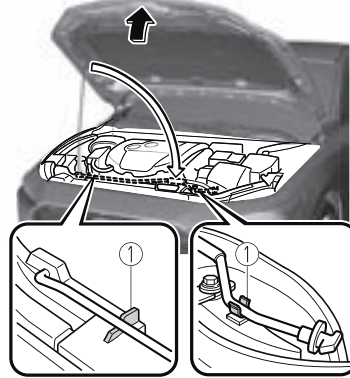

1. Clip

3. Lower the hood slowly to a height of about 20 cm (7.9 in) above its closed position and then let it drop.

CAUTION

When closing the hood, do not push it excessively such as by applying your weight. Otherwise, the hood could be deformed.

Engine Compartment Overview

▼ Engine Compartment Overview

SKYACTIV-G 2.0 and SKYACTIV-G 2.5

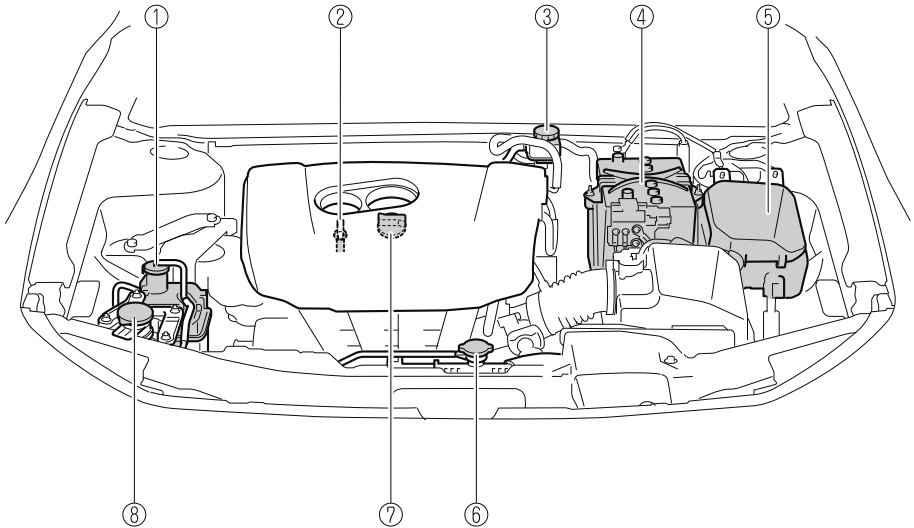

1. Engine coolant reservoir
2. Engine oil dipstick
3. Brake/Clutch fluid reservoir
4. Battery
5. Fuse block
6. Cooling system cap
7. Engine oil-filler cap
8. Windshield washer fluid reservoir

SKYACTIV-G 2.5T

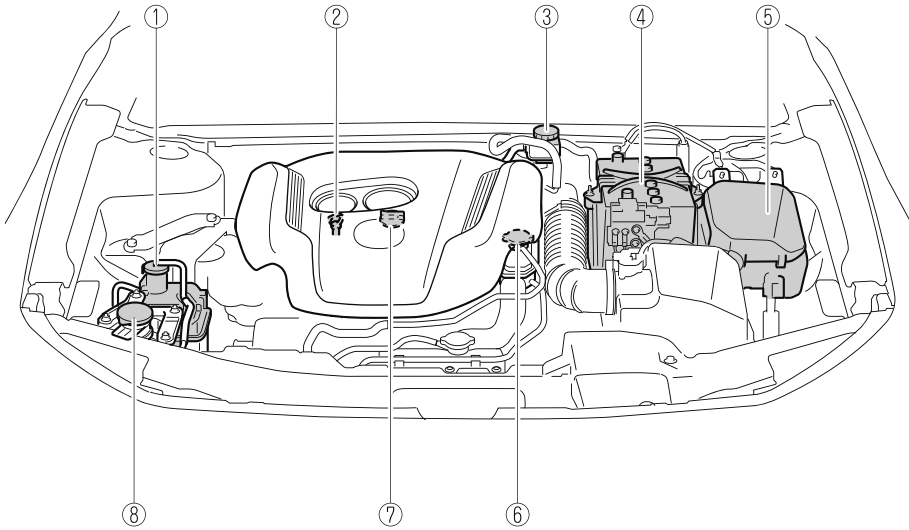

1. Engine coolant reservoir
2. Engine oil dipstick
3. Brake fluid reservoir
4. Battery
5. Fuse block
6. Cooling system cap
7. Engine oil-filler cap
8. Windshield washer fluid reservoir

Engine Oil

▼ Engine Oil

NOTE

Changing the engine oil should be performed by an Authorized Mazda Dealer. Refer to Introduction on page 6-2 for owner's responsibility in protecting your investment.

▼ Recommended Oil

U.S.A., Canada

SKYACTIV-G 2.0 and SKYACTIV-G 2.5

Use ILSAC GF-V or higher/ SAE 0W-20 engine oil.

Mazda Genuine Oil is used in your Mazda vehicle. Mazda Genuine 0W-20 Oil is required to achieve optimum fuel economy.

For maintenance service, Mazda recommends Mazda Genuine Parts and Oil.



(ILSAC)

Only use SAE 0W-20 oil "Certified For Gasoline Engines" by the American Petroleum Institute (API). Oil with this trademark symbol conforms to the current engine and emission system protection standards and fuel economy requirements of the International Lubricant Standardization and Approval Committee (ILSAC), comprised of U.S. and Japanese automobile manufacturers.

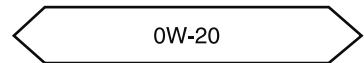
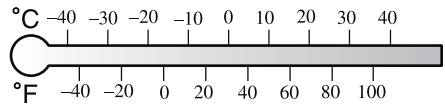

SKYACTIV-G 2.5T

Use SAE 5W-30 engine oil.

Mazda Genuine Oil is used in your Mazda vehicle. Mazda Genuine 5W-30 Oil is required to achieve optimum fuel economy.

For maintenance service, Mazda recommends Mazda Genuine Parts and Oil.



(ILSAC)

Owner Maintenance

Only use SAE 5W-30 oil "Certified For Gasoline Engines" by the American Petroleum Institute (API).

Oil with this trademark symbol conforms to the current engine and emission system protection standards and fuel economy requirements of the International Lubricant Standardization and Approval Committee (ILSAC), comprised of U.S. and Japanese automobile manufacturers.

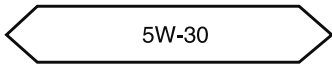
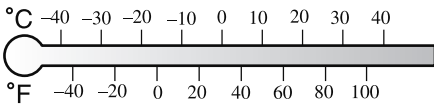

Except U.S.A., Canada

Use SAE 5W-30 engine oil.

Oil container labels provide important information.

A chief contribution this type of oil makes to fuel economy is reducing the amount of fuel necessary to overcome engine friction.

For maintenance service, Mazda recommends Mazda Genuine Parts.

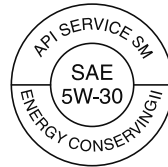

(ILSAC)

(Mexico)

SKYACTIV-G 2.0 and SKYACTIV-G 2.5

Use API SM or higher, or ILSAC GF-IV or higher/SAE 5W-30 engine oil. If SAE 5W-30 engine oil is not available, use SAE 5W-20 engine oil.

The quality designation SM, or ILSAC must be on the label.

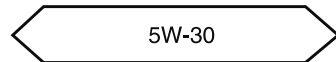
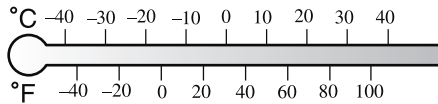

SKYACTIV-G 2.5T

Use SAE 5W-30 engine oil. If SAE 5W-30 engine oil is not available, use SAE 0W-30 or SAE 10W-30 engine oil.

The quality designation SM or SN, or ILSAC must be on the label.

▼ Inspecting Engine Oil Level

NOTE

· If the engine oil level warning indication/warning light turns on, add 1 L (0.26 US gal, 0.22 Imp gal) of engine oil.

1. Be sure the vehicle is on a level surface.
2. Warm up the engine to normal operating temperature.
3. Turn it off and wait at least 5 minutes for the oil to return to the oil pan.
4. Pull out the dipstick, wipe it clean, and reinsert it fully.

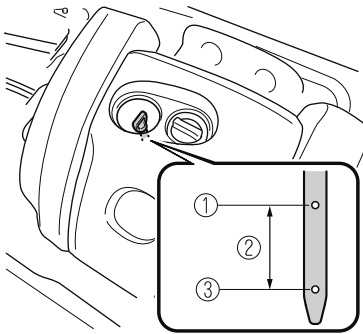

1. MAX
2. OK
3. MIN

5. Pull it out again and examine the level.
The level is normal if it is between the MIN and MAX marks.
If it is near or below MIN, add enough oil to bring the level to MAX.

CAUTION

Do not overfill the engine oil. This may cause engine damage.

6. Make sure the O-ring on the dipstick is positioned properly before reinserting the dipstick.
7. Reinsert the dipstick fully.

Engine Coolant

▼ Inspecting Coolant Level

WARNING

Do not use a match or live flame in the engine compartment. DO NOT ADD COOLANT WHEN THE ENGINE IS HOT:

A hot engine is dangerous. If the engine has been running, parts of the engine compartment can become very hot. You could be burned. Carefully inspect the engine coolant in the coolant reservoir, but do not open it.



 **Pull over to a safe location, then switch the ignition off and make sure the fan is not running before attempting to work near the cooling fan:**

Working near the cooling fan when it is running is dangerous. The fan could continue running indefinitely even if the engine has stopped and the engine compartment temperature is high. You could be hit by the fan and seriously injured.



Do not remove either cooling system cap when the engine and radiator are hot:

When the engine and radiator are hot, scalding coolant and steam may shoot out under pressure and cause serious injury.

NOTE

Changing the coolant should be done by an Authorized Mazda Dealer.

Inspect the antifreeze protection and coolant level in the coolant reservoir at least once a year—at the beginning of the winter season—and before traveling where temperatures may drop below freezing.

Inspect the condition and connections of all cooling system and heater hoses. Replace any that are swollen or deteriorated.

The coolant should be at full in the radiator and between the FULL and LOW marks on the coolant reservoir when the engine is cool.

SKYACTIV-G 2.0 and SKYACTIV-G 2.5

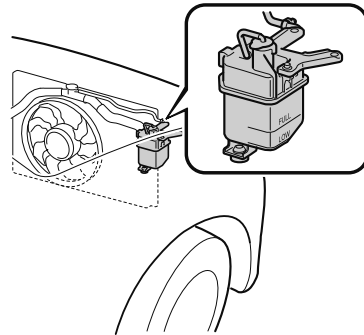

SKYACTIV-G 2.5T

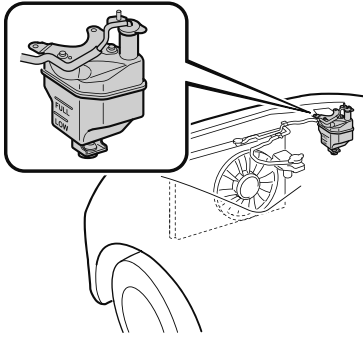

If it is at or near LOW, add enough coolant to the coolant reservoir to provide freezing and corrosion protection and to bring the level to FULL.

Securely tighten the coolant reservoir tank cap after adding coolant.

CAUTION

- Radiator coolant will damage paint. Rinse it off quickly if spilled.
- If the "FL22" mark is shown on or near the cooling system cap, use of FL-22 is recommended when replacing engine coolant. Using engine coolant other than FL-22 may cause serious damage to the engine and cooling system.

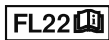

If the coolant reservoir is empty or new coolant is required frequently, consult an Authorized Mazda Dealer.

Brake/Clutch Fluid

▼ Inspecting Brake/Clutch Fluid Level

WARNING

If the brake/clutch fluid level is low, have the brakes inspected:

A low brake/clutch fluid level is dangerous.

A low level could indicate brake lining wear or a brake system leak which could cause the brakes to fail and lead to an accident.

The brakes and clutch draw fluid from the same reservoir.

Inspect the fluid level in the reservoir regularly. It should be kept between the MAX and MIN lines.

The level normally drops with accumulated distance, a condition associated with wear of brake and clutch linings. If it is excessively low, have the brake/clutch system inspected by an Authorized Mazda Dealer.

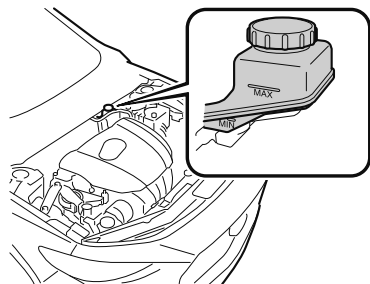

Washer Fluid

▼ Inspecting Washer Fluid Level

WARNING

Use only windshield washer fluid or plain water in the reservoir:

Using radiator antifreeze as washer fluid is dangerous. If sprayed on the windshield, it will dirty the windshield, affect your visibility, and could result in an accident.

Using Washer Fluid Without Anti-freeze Protection in Cold Weather:

Operating your vehicle in temperatures below 4 °C (40 °F) using washer fluid without anti-freeze protection is dangerous as it could cause impaired windshield vision and result in an accident. In cold weather, always use washer fluid with anti-freeze protection.

NOTE

State or local regulations may restrict the use of volatile organic compounds (VOCs), which are commonly used as anti-freeze agents in washer fluid. A washer fluid with limited VOC content should be used only if it provides adequate freeze resistance for all regions and climates in which the vehicle will be operated.

Inspect fluid level in the washer fluid reservoir; add fluid if necessary.

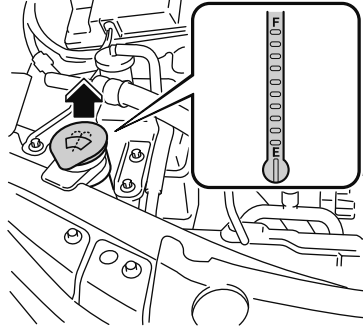

The top of the float should be between F and E.

Use plain water if washer fluid is unavailable. But use only washer fluid in cold weather to prevent it from freezing.

NOTE

Front and rear washer fluid is supplied from the same reservoir.

Body Lubrication

▼ Body Lubrication

All moving points of the body, such as door and hood hinges and locks, should be lubricated each time the engine oil is changed. Use a nonfreezing lubricant on locks during cold weather.

Make sure the hood's secondary latch keeps the hood from opening when the primary latch is released.

Wiper Blades

▼ Wiper Blades



- Hot waxes applied by automatic car washers have been known to affect the wiper's ability to clean windows.
- To prevent damage to the wiper blades, do not use gasoline, kerosene, paint thinner, or other solvents on or near them.
- When the wiper lever is in the AUTO position and the ignition is switched ON, the wipers may move automatically in the following cases:
 - If the windshield above the rain sensor is touched.
 - If the windshield above the rain sensor is wiped with a cloth.
 - If the windshield is struck with a hand or other object.
 - If the rain sensor is struck with a hand or other object from inside the vehicle.

Be careful not to pinch hands or fingers as it may cause injury, or damage the wipers. When washing or servicing the vehicle, make sure the wiper lever is in the OFF position.

- Before lifting the windshield wiper blades off the windshield, always follow the procedure for moving the windshield wiper blades. Otherwise, a wiper blade, wiper arm, or the hood could be damaged. Refer to the Replacing Windshield Wiper Blades (page 6-24) section for the procedure on how to move the windshield wiper blades to the service position.

Contamination of either the windshield or the blades with foreign matter can reduce wiper effectiveness. Common sources are insects, tree sap, and hot wax treatments used by some commercial car washes.

If the blades are not wiping properly, clean the window and blades with a good cleaner or mild detergent; then rinse thoroughly with clean water. Repeat if necessary.

▼ Replacing Windshield Wiper Blades

When the wipers no longer clean well, the blades are probably worn or cracked. Replace them.



- To prevent damaging a windshield wiper blade, wiper arm, or the hood, perform the following procedure.
 - Before lifting the windshield wiper blades off the windshield, always move them to the service position.
 - When putting the windshield wiper blades back on the windshield, make sure that they are in the service position before switching the ignition ON and operating the windshield wipers.
- Replace with Mazda genuine wiper blades. If they are replaced with wiper blades other than a Mazda genuine product, they may not wipe with the same efficiency as the genuine product.
- To prevent damage to the wiper arms and other components, do not try to sweep the wiper arm by hand.
- Do not bend the blade rubber unnecessarily when replacing it. Otherwise, the metal stiffener in the blade may deform and the windshield wiper operation may be adversely affected.
- Do not hold a wiper blade by its end when raising the wiper arm. Otherwise, the part may deform and the wiping performance may lower.

NOTE

- You can replace the wiper blades yourself, however you cannot replace the wiper arms.
If you want to replace the wiper arms, consult an Authorized Mazda Dealer.
- Forcefully lowering the wiper arms could damage the wiper arm and blade, and may scratch or crack the windshield.

Replace the wiper blades using the following procedure.

1. Move the wipers to the service positions using the following procedure.
 - a) Switch the ignition ON.
 - b) Switch the ignition OFF.
 - c) Press up the wiper switch to the MIST position 2 times within 30 seconds after switching the ignition OFF.
When the procedure is completed, the wipers operate and they stop at the service positions.
2. Raise the wiper arms.

⚠ CAUTION

To prevent damage to the windshield let the wiper arm down easily, do not let it slap down on the windshield.

3. Slide the blade component in the direction of the arrow while pressing the wiper arm tab to remove the blade component from the wiper arm.

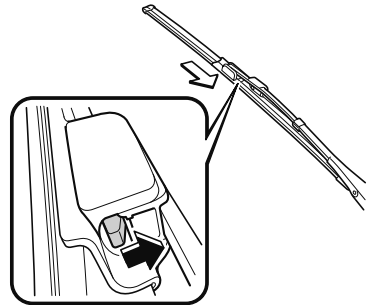

4. Pull the blade rubber in the direction of the arrow and slide it to a position where the blade holder groove can be checked.

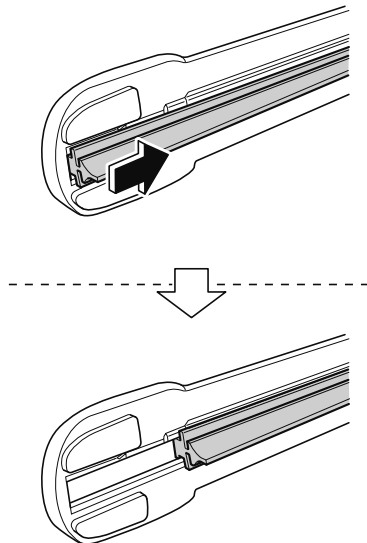

Owner Maintenance

5. Pull the end of the blade rubber from the blade holder groove in the direction of the arrow and remove the blade rubber from the blade holder.

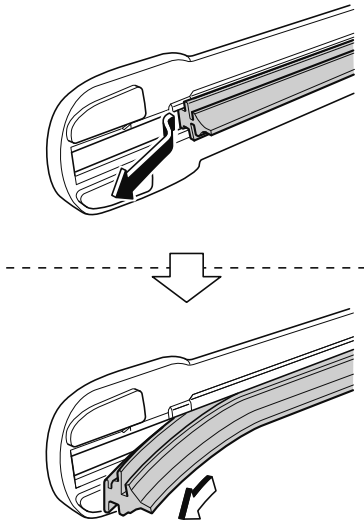

6. Insert the end of the new blade rubber into the groove of the blade holder until it contacts the end of the blade holder.

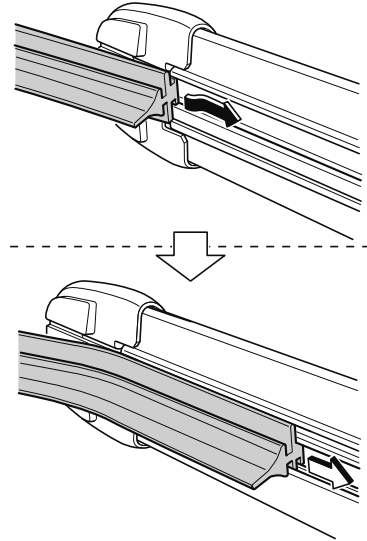

7. After pulling the blade rubber in the direction of the arrow and sliding the blade rubber to a position to check the blade holder groove, slide the blade rubber end in the opposite direction.

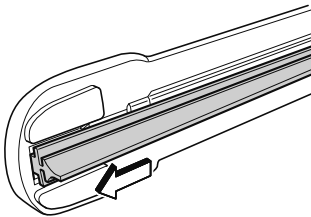
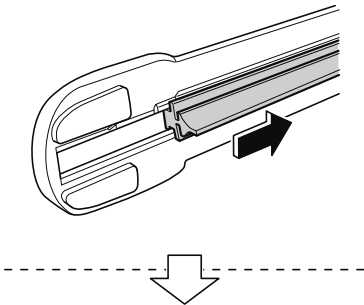

8. Make sure that the blade rubber is correctly installed to the blade holder.
9. Slide the blade component and install it to the wiper arm.

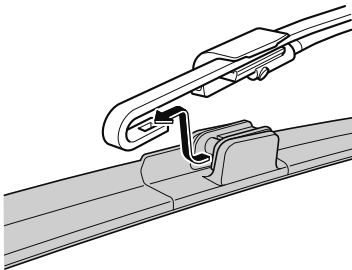

10. Slowly lower the wiper arms onto the windshield.

11. Move the wipers to their initial positions using the following procedure.
- Make sure that the wipers are set on the windshield.
 - Switch the ignition ON.
 - Press up the wiper switch to the MIST position 1 time.
When the procedure is completed, the wipers operate and they stop at the initial positions.

▼ Replacing Rear Window Wiper Blade (5-Door)

When the wiper no longer cleans well, the blade is probably worn or cracked. Replace it.

⚠ CAUTION

To prevent damage to the wiper arm and other components, do not move the wiper by hand.

1. Remove the cover.

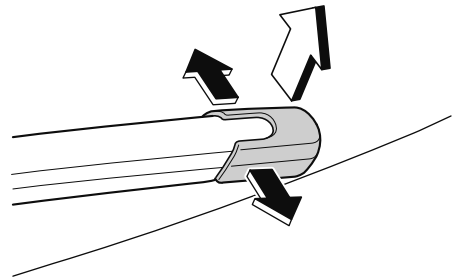

Owner Maintenance

2. Remove the stopper and raise the wiper arm.

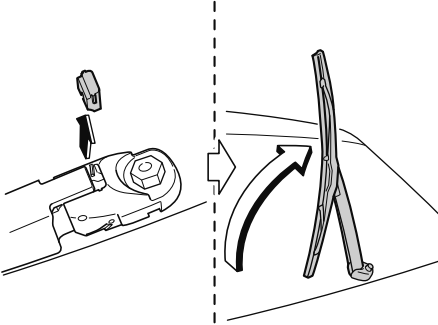

3. Firmly rotate the wiper blade to the right until it unlocks, then remove the blade.

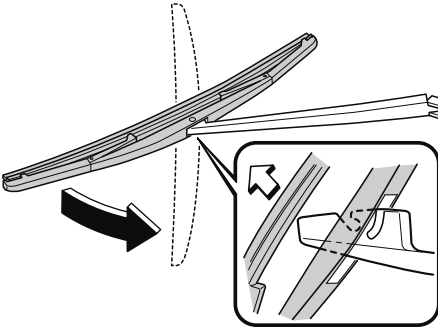

⚠ CAUTION

To prevent damage to the rear window, do not let the wiper arm fall on it.

4. Pull down the blade rubber and slide it out of the blade holder.

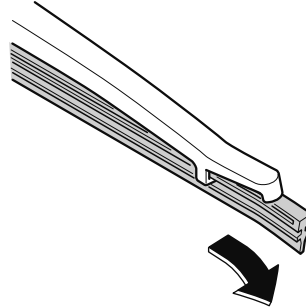

5. Remove the metal stiffeners from the blade rubber and install them in the new blade.

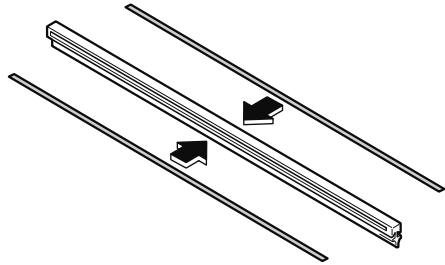

⚠ CAUTION

Do not bend or discard the stiffeners. You need to use them again.

6. Carefully insert the new blade rubber. Then install the blade assembly in the reverse order of removal.

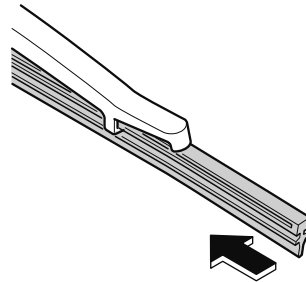

Battery

▼ Battery

WARNING

Wash hands after handling the battery and related accessories:

Battery posts, terminals and related accessories contain lead and lead compounds, chemicals known to the State of California to cause cancer and reproductive harm.



Read the following precautions carefully before using the battery or inspecting to ensure safe and correct handling:



Always wear eye protection when working near the battery: Working without eye protection is dangerous. Battery fluid contains SULFURIC ACID which could cause blindness if splashed into your eyes. Also, hydrogen gas produced during normal battery operation, could ignite and cause the battery to explode.



Wear eye protection and protective gloves to prevent contact with battery fluid:

Spilled battery fluid is dangerous. Battery fluid contains SULFURIC ACID which could cause serious injuries if it gets in eyes, or on the skin or clothing. If this happens, immediately flush your eyes with water for 15 minutes or wash your skin thoroughly and get medical attention.



Always keep batteries out of the reach of children:

Allowing children to play near batteries is dangerous. Battery fluid could cause serious injuries if it gets in the eyes or on the skin.



Keep flames and sparks away from open battery cells and do not allow metal tools to contact the positive (+) or negative (-) terminal of the battery when working near a battery. Do not allow the positive (+) terminal to contact the vehicle body:

Flames and sparks near open battery cells are dangerous. Hydrogen gas, produced during normal battery operation, could ignite and cause the battery to explode. An exploding battery can cause serious burns and injuries. Keep all flames including cigarettes and sparks away from open battery cells.



Keep all flames and sparks away from open battery cells because hydrogen gas is produced from open battery cells while charging the battery or adding battery fluid:

Flames and sparks near open battery cells are dangerous. Hydrogen gas, produced during normal battery operation, could ignite and cause the battery to explode. An exploding battery can cause serious burns and injuries. Keep all flames including cigarettes and sparks away from open battery cells.

NOTE

Before performing battery maintenance, remove the battery cover.

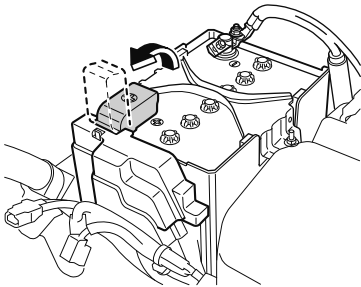

▼ Battery Maintenance

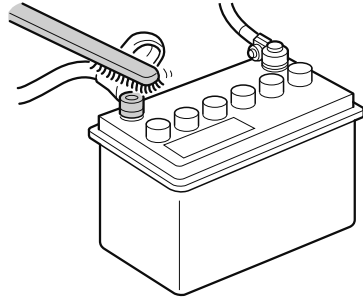

To get the best service from a battery:

- Keep it securely mounted.
- Keep the top clean and dry.
- Keep terminals and connections clean, tight, and coated with petroleum jelly or terminal grease.
- Rinse off spilled electrolyte immediately with a solution of water and baking soda.
- If the vehicle will not be used for an extended time, disconnect the battery cables and charge the battery every 6 weeks.

▼ Battery Replacement

Contact an Authorized Mazda Dealer for battery replacement.

Key Battery Replacement

▼ Key Battery Replacement

If the buttons on the transmitter are inoperable and the operation indicator light does not flash, the battery may be dead.

Replace with a new battery before the transmitter becomes unusable.

⚠ CAUTION

- Make sure the battery is installed correctly. Battery leakage could occur if it is not installed correctly.
- When replacing the battery, be careful not to touch any of the internal circuitry and electrical terminals, bend the electrical terminals, or get dirt in the transmitter as the transmitter could be damaged.
- There is the danger of explosion if the battery is not correctly replaced.
- Dispose of used batteries according to the following instructions.
 - Insulate the plus and minus terminals of the battery using cellophane or equivalent tape.
 - Never disassemble.
 - Never throw the battery into fire or water.
 - Never deform or crush.
- Replace only with the same type battery (CR2032 or equivalent).

The following conditions indicate that the battery power is low:

- A message, "Low Key Fob Battery. Replace Battery" is displayed on the multi-information display when the ignition is switched OFF.
- The system does not operate and the operation indicator light on the transmitter does not flash when the buttons are pressed.
- The system's operational range is reduced.

Incorrect battery replacement operation may damage the key. Replacing the battery at an Authorized Mazda Dealer is recommended. If replacing the battery by yourself, follow the instruction.

Replacing the key battery

1. Remove the lower cover while pressing the knob in the direction of the arrow.

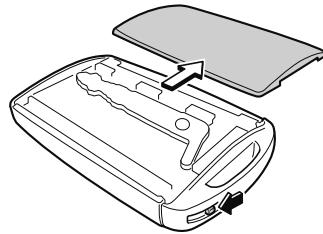

Owner Maintenance

2. Press in the tab to unlock the upper cover.

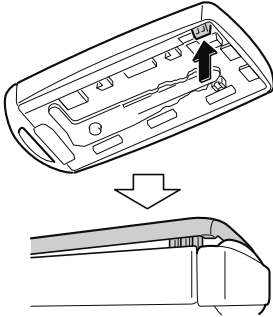

3. Insert a tape-wrapped flathead screwdriver into the gap and slide it in the direction of the arrow.

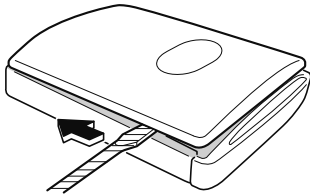

4. Twist the flathead screwdriver in the direction of the arrow and remove the upper cover.

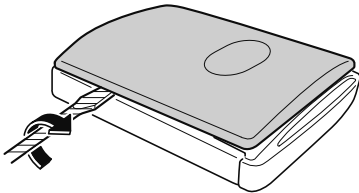

5. Remove the cap using the tape-wrapped flathead screwdriver.

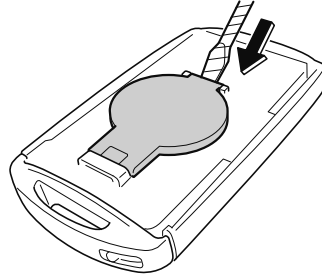

6. Remove the battery using tape-wrapped flathead screwdriver.

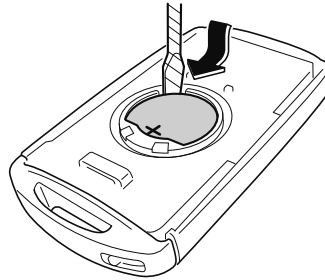

7. Insert a new battery into the transmitter so that the positive pole is facing up.

8. Install the cap.

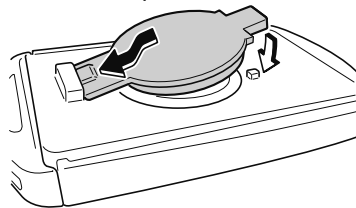

9. Install the upper cover.

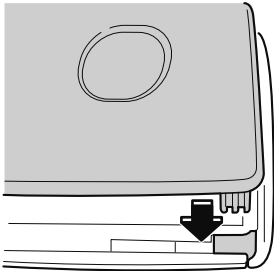

10. Insert the tabs of the lower cover into the slots of the transmitter and install the lower cover.

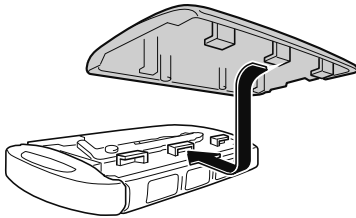

Tires

▼ Tires

For reasons of proper performance, safety, and better fuel economy, always maintain recommended tire inflation pressures and stay within the recommended load limits and weight distribution.

WARNING

Using Different Tire Types:

Driving your vehicle with different types of tires is dangerous. It could cause poor handling and poor braking; leading to loss of control.

Except for the limited use of the temporary spare tire, use only the same type tires (radial, bias-belted, bias-type) on all four wheels.

Using Wrong-Sized Tires:

Using any other tire size than what is specified for the vehicle (page 9-10) is dangerous. It could seriously affect ride, handling, ground clearance, tire clearance, and speedometer calibration. This could cause you to have an accident. Use only tires that are the correct size specified for the vehicle.

▼ Tire Inflation Pressure



Always inflate the tires to the correct pressure:

Overinflation or underinflation of tires is dangerous. Adverse handling or unexpected tire failure could result in a serious accident.

Refer to Tires on page 9-10.

Use only a Mazda-genuine tire valve cap:

Use of a non-genuine part is dangerous as the correct tire air pressure cannot be maintained if the tire valve becomes damaged. If the vehicle is driven under this condition, the tire air pressure will decrease which could result in a serious accident. Do not use any part for the tire valve cap that is not a Mazda-genuine part.

Inspect all tire pressures monthly (including the spare) when the tires are cold. Maintain recommended pressures for the best ride, handling, and minimum tire wear.

Refer to the specification charts (page 9-10).

NOTE

- Always check tire pressure when tires are cold.
- Warm tires normally exceed recommended pressures. Do not release air from warm tires to adjust the pressure.
- Underinflation can cause reduced fuel economy, uneven and accelerated tire wear, and poor sealing of the tire bead, which will deform the wheel and cause separation of tire from rim.

- Overinflation can produce a harsh ride, uneven and accelerated tire wear, and a greater possibility of damage from road hazards. Keep your tire pressure at the correct levels. If one frequently needs inflating, have it inspected.

▼ Tire Rotation



Rotate tires periodically:

Irregular tire wear is dangerous. To equalize tread wear for maintaining good performance in handling and braking, rotate the tires periodically or sooner if irregular wear develops. Please refer to Scheduled maintenance for your tire rotation interval.

During rotation, inspect them for correct balance.

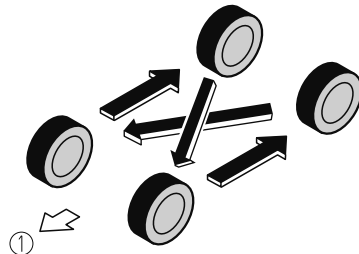

1. Forward

Do not include (TEMPORARY USE ONLY) spare tire in rotation.

Also, inspect them for uneven wear and damage. Abnormal wear is usually caused by one or a combination of the following:

- Incorrect tire pressure
- Improper wheel alignment
- Out-of-balance wheel
- Severe braking

After rotation, inflate all tire pressures to specification on page 9-10 and inspect the lug nuts for tightness.

⚠ CAUTION

Rotate unidirectional tires and radial tires that have an asymmetrical tread pattern or studs only from front to rear, not from side to side. Tire performance will be reduced if rotated from side to side.

▼ **Replacing a Tire**

⚠ WARNING

Always use tires that are in good condition:

Driving with worn tires is dangerous. Reduced braking, steering, and traction could result in an accident.

Replace all four tires at the same time:

Replacing just one tire is dangerous. It could cause poor handling and poor braking resulting in loss of vehicle control. Mazda strongly recommends that you replace all four tires at the same time.

If a tire wears evenly, a wear indicator will appear as a solid band across the tread.

Replace the tire when this happens.

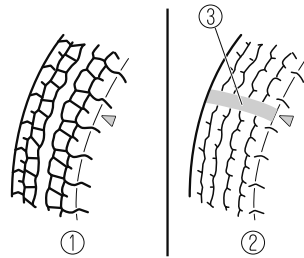

1. New tread
2. Worn tread
3. Tread wear indicator

You should replace the tire before the band crosses the entire tread.

NOTE

Tires degrade over time, even when they are not being used on the road. It is recommended that tires generally be replaced when they are 6 years or older. Heat caused by hot climates or frequent high loading conditions can accelerate the aging process. You should replace the spare tire when you replace the other road tires due to the aging of the spare tire. The period in which the tire was manufactured (both week and year) is indicated by a 4-digit number.

Refer to Tire Labeling on page 8-23.

▼ Temporary Spare Tire

Inspect the temporary spare tire at least monthly to make sure it is properly inflated and stored.

NOTE

The temporary spare tire condition gradually deteriorates even if it has not been used.

The temporary spare tire is easier to handle because of its construction which is lighter and smaller than a conventional tire. This tire should be used only for an emergency and only for a short distance.

Use the temporary spare tire only until the conventional tire is repaired, which should be as soon as possible.

Refer to Tires on page 9-10.

CAUTION

- Do not use your temporary spare tire rim with a snow tire or a conventional tire. Neither will properly fit and could damage both tire and rim.
- The temporary spare tire has a tread life of less than 5,000 km (3,000 miles). The tread life may be shorter depending on driving conditions.
- The temporary spare tire is for limited use, however, if the tread wear solid-band indicator appears, replace the tire with the same type of temporary spare (page 6-35).

NOTE

Tires degrade over time, even when they are not being used on the road. It is recommended that tires generally be replaced when they are 6 years or older. Heat caused by hot climates or frequent high loading conditions can accelerate the aging process. You should replace the spare tire when you replace the other road tires due to the aging of the spare tire. The period in which the tire was manufactured (both week and year) is indicated by a 4-digit number.

Refer to Tire Labeling on page 8-23.

▼ Replacing a Wheel

⚠ WARNING

Always use wheels of the correct size on your vehicle:

Using a wrong-sized wheel is dangerous. Braking and handling could be affected, leading to loss of control and an accident.

⚠ CAUTION

A wrong-sized wheel may adversely affect:

- Tire fit
- Wheel and bearing life
- Ground clearance
- Snow-chain clearance
- Speedometer calibration
- Headlight aim
- Bumper height
- Tire Pressure Monitoring System

NOTE

- When replacing a wheel, make sure the new one is the same as the original factory wheel in diameter, rim width, and offset (inset/outset).
- For details, contact an Authorized Mazda Dealer.

Proper tire balancing provides the best riding comfort and helps reduce tread wear. Out-of-balance tires can cause vibration and uneven wear, such as cupping and flat spots.

Light Bulbs

▼ Light Bulbs

Front
 Type A

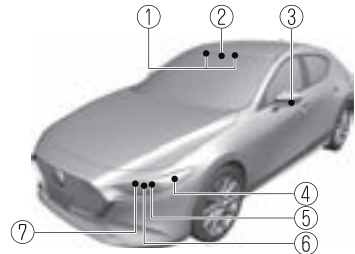

1. Vanity mirror lights*
2. Overhead lights/ Front map lights
3. Side turn signal lights*
4. Front side-marker lights
5. Parking lights
6. Headlights (High/Low beam)/ Daytime running lights
7. Front turn signal lights

Type B

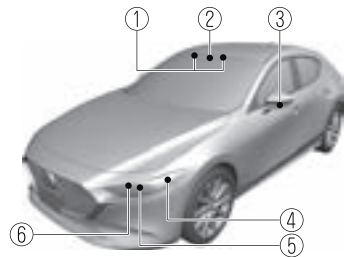

1. Vanity mirror lights*
2. Overhead lights/ Front map lights
3. Side turn signal lights*
4. Parking lights/Front side-marker lights
5. Headlights (High/Low beam)/ Daytime running lights
6. Front turn signal lights

Rear

4-Door

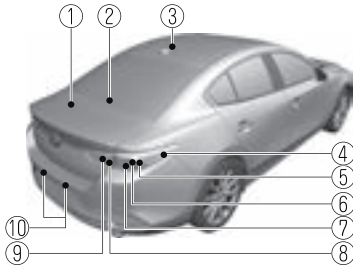

1. Trunk light
2. High-mount brake light
3. Overhead light (Rear)
4. Rear side-marker lights
5. Brake lights/Taillights*
6. Rear turn signal lights
7. Brake lights/Taillights
8. Taillights*
9. Reverse lights
10. License plate lights

5-Door

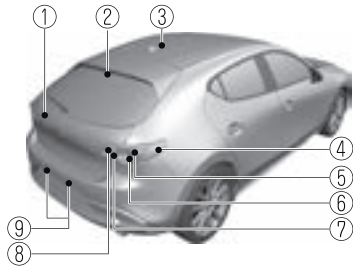

1. Luggage compartment light
2. High-mount brake light
3. Overhead light (Rear)
4. Rear side-marker lights
5. Rear turn signal lights
6. Brake lights/Taillights
7. Taillights*
8. Reverse lights
9. License plate lights

CAUTION

When removing the lens or lamp unit using a flathead screwdriver, make sure that the flathead screwdriver does not contact the interior terminal. If the flathead screwdriver contacts the terminal, a short circuit may occur.

NOTE

- When replacing a bulb, contact an Authorized Mazda Dealer if necessary.
- Use the protective cover and carton for the replacement bulb to dispose of the old bulb promptly and out of the reach of children.
- For details regarding the installation positions of the interior lights, refer to the following:
 - Vanity mirror lights
Refer to Vanity Mirrors on page 5-38.
 - Overhead Lights/front map lights, overhead light (rear), trunk light, and luggage compartment light
Refer to Interior Lights on page 5-39.

▼ Replacing Exterior Light Bulbs

The exterior lights have either LEDs or normal bulbs. Only the bulb for a parking lights/front side-marker lights (type B) can be replaced.

LED type

- Headlights
- Daytime running lights
- Parking lights (Type A)
- Front turn signal lights
- Front side-marker lights (Type A)
- Side turn signal lights*
- High-mount brake light
- Rear turn signal lights

- Rear side-marker lights
- Brake lights
- Taillights
- Reverse lights
- License plate lights

The LED bulb cannot be replaced as a single unit because it is an integrated unit.

The LED bulb has to be replaced with the unit. We recommend an Authorized Mazda Dealer when the replacement is necessary.

Bulb type

Parking lights/Front side-marker lights (Type B)

1. Make sure the ignition is switched off, and the headlight switch is off.
2. If you are changing the left bulb, start the engine, turn the steering wheel all the way to the right, and turn off engine. If you are changing the right bulb, turn the steering wheel to the left.
3. Pull the center of each plastic retainer and remove the retainers.

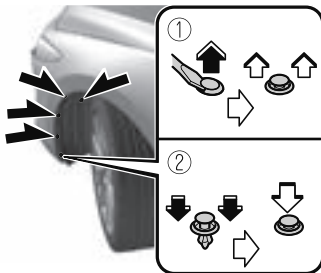

1. Removal
2. Installation

4. Pull the center of each plastic retainer and remove the retainers.

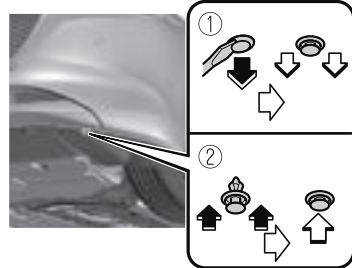

1. Removal
2. Installation

5. Turn the screw counterclockwise and remove it, and then partially peel back the mudguard.

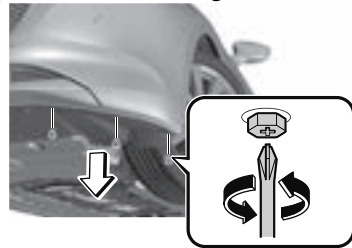

6. Turn the socket and bulb assembly counterclockwise and remove it.

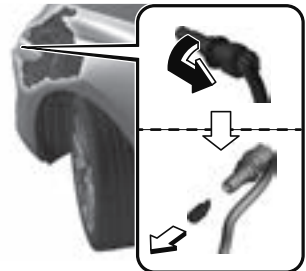

7. Disconnect the bulb from the socket.
8. Install the new bulb in the reverse order of the removal procedure.

▼ Replacing Interior Light Bulbs

Overhead lights/Front map lights, Overhead light (Rear), Vanity mirror lights, Luggage compartment light (5-Door)

The LED bulb cannot be replaced as a single unit because it is an integrated unit.

The LED bulb has to be replaced with the unit. We recommend an Authorized Mazda Dealer when the replacement is necessary.

Trunk light (4-Door)

1. Press both sides of the lens cap to remove it.
2. Disconnect the bulb by pulling it out.

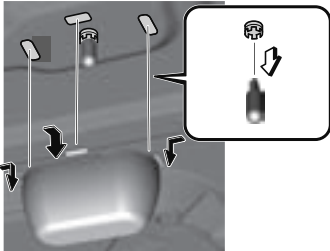

3. Install the new bulb in the reverse order of the removal procedure.

Fuses

▼ Fuses

Your vehicle's electrical system is protected by fuses.

If any lights, accessories, or controls do not work, inspect the appropriate circuit protector. If a fuse has blown, the inside element will be melted.

If the same fuse blows again, avoid using that system and consult an Authorized Mazda Dealer as soon as possible.

▼ Fuse Replacement

Replacing the fuses on the vehicle's left side

If the electrical system does not work, first inspect the fuses on the vehicle's left side.

1. Make sure the ignition is switched off, and other switches are off.
2. Open the fuse panel cover.

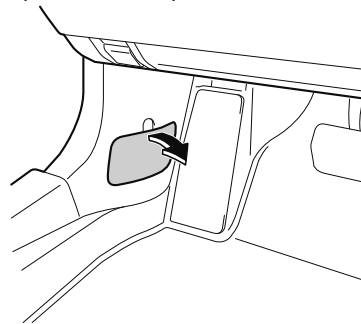

3. Pull the fuse straight out with the fuse puller provided on the fuse block located in the engine compartment.

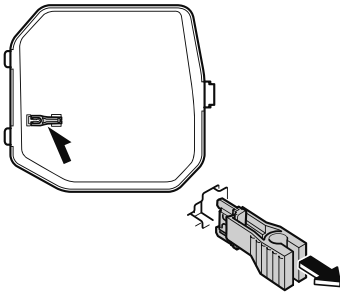

4. Inspect the fuse and replace it if it is blown.

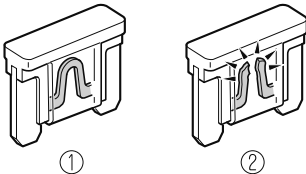

1. Normal
2. Blown

5. Insert a new fuse of the same amperage rating, and make sure it fits tightly. If it does not fit tightly, have an expert install it. Consult an Authorized Mazda Dealer. If you have no spare fuses, borrow one of the same rating from a circuit not essential to vehicle operation, such as the audio or accessory socket circuit.

⚠ CAUTION

Always replace a fuse with a genuine Mazda fuse or equivalent of the same rating. Otherwise, you may damage the electric system.

6. Reinstall the cover and make sure that it is securely installed.

Replacing the fuses under the hood

If the headlights or other electrical components do not work and the fuses in the cabin are normal, inspect the fuse block under the hood. If a fuse is blown, it must be replaced. Follow these steps:

1. Make sure the ignition is switched off, and other switches are off.
2. Remove the fuse block cover.

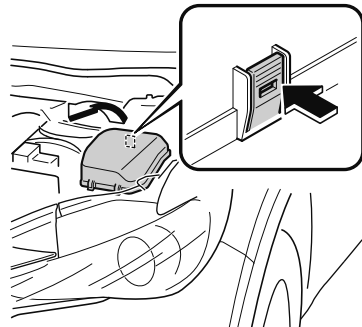

3. If any fuse but the MAIN fuse is blown, replace it with a new one of the same amperage rating.

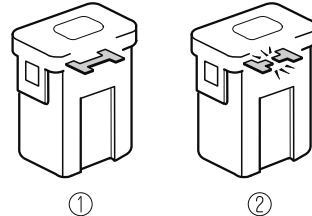

1. Normal
2. Blown

 **WARNING**

Do not replace the main fuse by yourself. Have an Authorized Mazda Dealer perform the replacement:

Replacing the fuse by yourself is dangerous because the MAIN fuse is a high current fuse. Incorrect replacement could cause an electrical shock or a short circuit resulting in a fire.

4. Reinstall the cover and make sure that it is securely installed.

▼ **Fuse Panel Description**

Fuse block (Engine compartment)

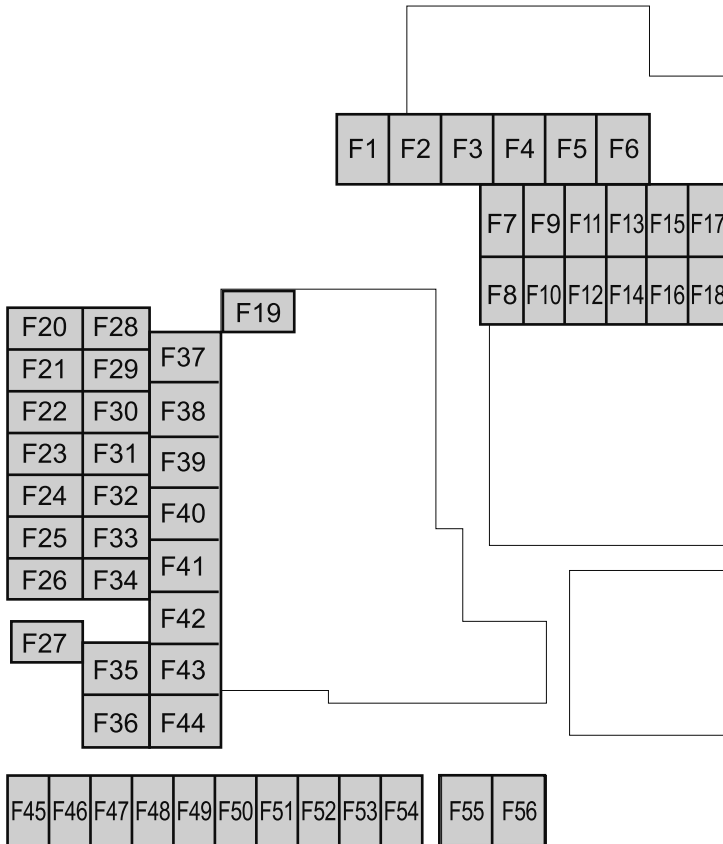

No.	FUSE RAT- ING	PROTECTED COMPONENT
F1	—	—
F2	20 A	Windshield wiper de-icer*
F3	30 A	Engine control system
	20 A	—
F4	20 A	S-VT
F5	40 A	Engine control system
F6	20 A	—

*Some models.

Owner Maintenance

No.	FUSE RAT- ING	PROTECTED COMPONENT
F7	15 A	—
	20 A	Fuel pump
F8	15 A	Engine control system
F9	15 A	Transmission control system*
F10	15 A	Engine control system
F11	7.5 A	Air conditioner
F12	15 A	Engine control system
F13	15 A	—
F14	20 A	Front seat warmer*
F15	20 A	—
F16	15 A	For protection of various circuits
F17	—	—
F18	15 A	For protection of various circuits
F19	60 A	Power steering system
F20	15 A	Headlight (LH) 1
F21	15 A	Headlight (RH) 1
F22	15 A	Keyless system
F23	30 A	ABS, Dynamic stability control system
F24	15 A	Headlight (LH) 2
F25	15 A	Headlight (RH) 2
F26	7.5 A	On board diagnostics
F27	25 A	For protection of various circuits
F28	25 A	For protection of various circuits
F29	15 A	Windshield washer
F30	15 A	Accessory sockets
F31	15 A	Horn
F32	—	—
F33	—	—
F34	—	—
F35	50A	ABS, Dynamic stability control system
F36	—	—
F37	40 A	Rear window defogger
F38	50 A	For protection of various circuits

No.	FUSE RAT- ING	PROTECTED COMPONENT
F39	—	—
F40	40 A	Air conditioner
F41	—	—
F42	20 A	Windshield wipers
F43	30 A	Cooling fan
F44	30 A	Starter
F45	10 A	Engine control system
F46	15 A	Audio
F47	15 A	For protection of various circuits
F48	7.5 A	Air bag
F49	15 A	Instrument cluster
F50	15 A	Room light
F51	25 A	Audio
F52	10 A	Moonroof*
F53	15 A	Engine control system
F54	15 A	i-ACTIVSENSE
F55	50 A	—
F56	50 A	—
	15 A	Electric water pump*

Owner Maintenance

Fuse block (Left side)

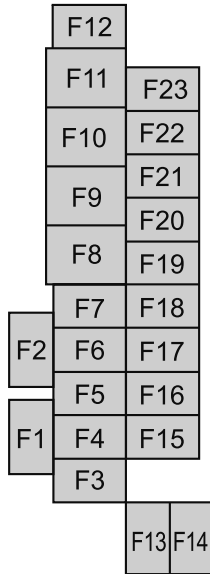

No.	FUSE RAT- ING	PROTECTED COMPONENT
F1	—	—
F2	—	—
F3	—	—
F4	15 A	Power door locks (Driver)
F5	15 A	Power door locks (Passenger)
F6	—	—
F7	—	—
F8	—	—
F9	30 A	Power windows (Driver)
F10	30 A	Power windows (Passenger)
F11	30 A	Power seat (Driver)*
F12	—	—
F13	15 A	Audio
F14	—	—
F15	15 A	Liftgate lock

No.	FUSE RAT- ING	PROTECTED COMPONENT
F16	15 A	Illumination
F17	10 A	Brake lights
F18	10 A	Reverse lights
F19	10 A	Rear turn signal lights
F20	10 A	Taillights
F21	10 A	Taillights
F22	7.5 A	Air bag*
F23	—	—

Exterior Care

▼ Exterior Care

The paintwork on your Mazda represents the latest technical developments in composition and methods of application.

Environmental hazards, however, can harm the paint's protective properties, if proper care is not taken.

Here are some examples of possible damage, with tips on how to prevent them.

Etching Caused by Acid Rain or Industrial Fallout

Occurrence

Industrial pollutants and vehicle emissions drift into the air and mix with rain or dew to form acids. These acids can settle on a vehicle's finish. As the water evaporates, the acid becomes concentrated and can damage the finish.

And the longer the acid remains on the surface, the greater the chance is for damage.

Prevention

It is necessary to wash and wax your vehicle to preserve its finish according to the instructions in this section. These steps should be taken immediately after you suspect that acid rain has settled on your vehicle's finish.

Damage Caused by Bird Dropping, Insects, or Tree Sap

Occurrence

Bird droppings contain acids. If these are not removed they can eat away the clear and color base coat of the vehicle's paintwork.

When insects stick to the paint surface and decompose, corrosive compounds form. These can erode the clear and color base coat of the vehicle's paintwork if they are not removed.

Tree sap will harden and adhere permanently to the paint finish. If you scratch the sap off while it is hard, some vehicle paint could come off with it.

Prevention

It is necessary to have your Mazda washed and waxed to preserve its finish according to the instructions in this section. This should be done as soon as possible.

Bird droppings can be removed with a soft sponge and water. If you are traveling and these are not available, a moistened tissue may also take care of the problem. The cleaned area should be waxed according to the instructions in this section.

Insects and tree sap are best removed with a soft sponge and water or a commercially available chemical cleaner.

Another method is to cover the affected area with dampened newspaper for 1 to 2 hours. After removing the newspaper, rinse off the loosened debris with water.

Water Marks

Occurrence

Rain, fog, dew, and even tap water can contain harmful minerals such as salt and lime. If moisture containing these minerals settles on the vehicle and evaporates, the minerals will concentrate and harden to form white rings. The rings can damage your vehicle's finish.

Prevention

It is necessary to wash and wax your vehicle to preserve its finish according to the instructions in this section. These steps should be taken immediately after you find water marks on your vehicle's finish.

Paint Chipping

Occurrence

Paint chipping occurs when gravel thrown in the air by another vehicle's tires hits your vehicle.

How to avoid paint chipping

Keeping a safe distance between you and the vehicle ahead reduces the chances of having your paint chipped by flying gravel.

NOTE

- The paint chipping zone varies with the speed of the vehicle. For example, when traveling at 90 km/h (56 mph), the paint chipping zone is 50 m (164 ft).
- In low temperatures a vehicle's finish hardens. This increases the chance of paint chipping.

- Chipped paint can lead to rust forming on your Mazda. Before this happens, repair the damage by using Mazda touch-up paint according to the instructions in this section. Failure to repair the affected area could lead to serious rusting and expensive repairs.

Follow **all** label and container directions when using a chemical cleaner or polish. Read all warnings and cautions.

▼ Maintaining the Finish

Washing



- Before lifting the windshield wiper blades off the windshield, always follow the procedure for moving the windshield wiper blades. Otherwise, a wiper blade, wiper arm, or the hood could be damaged. Refer to the Replacing Windshield Wiper Blades (page 6-24) section for the procedure on how to move the windshield wiper blades to the service position.
- When the ignition is switched ON and the wiper lever is in the AUTO position and the position, the windshield wipers may operate automatically in the following cases:
 - The area of the windshield above the rain sensor is touched or wiped with a cloth.
 - The windshield or the rain sensor area in the cabin is hit.

Appearance Care

When the ignition is switched ON and the wiper lever is in the AUTO position, do not touch the windshield or the windshield wipers. Otherwise, the windshield wipers will operate automatically which could catch your fingers or damage the windshield wipers.

When removing ice or snow, or cleaning the windshield, always make sure the wiper lever is in the OFF position.

- Do not spray water in the engine compartment. Otherwise, it could result in engine-starting problems or damage to electrical parts.
- When washing and waxing the vehicle, be careful not to apply excessive force to any single area of the vehicle roof or the antenna. Otherwise, you could dent the vehicle or damage the antenna.
- Make sure that the fuel-filler lid is closed and lock the doors. Otherwise, the fuel-filler lid may be forcefully opened by water pressure causing damage to the vehicle or fuel-filler lid.

To help protect the finish from rust and deterioration, wash your Mazda thoroughly and frequently, at least once a month, with lukewarm or cold water.

If the vehicle is washed improperly, the paint surface could be scratched. Here are some examples of how scratching could occur.

Scratches occur on the paint surface when:

- The vehicle is washed without first rinsing off dirt and other foreign matter.

- The vehicle is washed with a rough, dry, or dirty cloth.
- The vehicle is washed at a car wash that uses brushes that are dirty or too stiff.
- Cleansers or wax containing abrasives are used.

NOTE

- Mazda is not responsible for scratches caused by automatic car washes or improper washing.
- Scratches are more noticeable on vehicles with darker paint finishes.

To minimize scratches on the vehicle's paint finish:

- Rinse off any dirt or other foreign matter using lukewarm or cold water before washing.
- Use plenty of lukewarm or cold water and a soft cloth when washing the vehicle. Do not use a nylon cloth.
- Rub gently when washing or drying the vehicle.
- Take your vehicle only to a car wash that keeps its brushes well maintained.
- Do not use abrasive cleansers or wax that contain abrasives.

CAUTION

- Do not use steel wool, abrasive cleaners, or strong detergents containing highly alkaline or caustic agents on chrome-plated or anodized aluminum parts. This may damage the protective coating; also, cleaners and detergents may discolor or deteriorate the paint.

Pay special attention to removing salt, dirt, mud, and other foreign material from the underside of the fenders, and make sure the drain holes in the lower edges of the doors and rocker panels are clean.

Insects, tar, tree sap, bird droppings, industrial fallout, and similar deposits can damage the finish if not removed immediately. When prompt washing with plain water is ineffective, use a mild soap made for use on vehicles.

Thoroughly rinse off all soap with lukewarm or cold water. Do not allow soap to dry on the finish.

After washing the vehicle, dry it with a clean chamois to prevent water spots from forming.



Dry off brakes that have become wet by driving slowly, releasing the accelerator pedal and lightly applying the brakes several times until the brake performance returns to normal:

Driving with wet brakes is dangerous. Increased stopping distance or the vehicle pulling to one side when braking could result in a serious accident. Light braking will indicate whether the brakes have been affected.

When using an automatic car wash

- Retract the door mirrors.
- The automatic car wash brushes could reduce the paint lustre or hasten paint deterioration.

When using a high water pressure car wash

High water temperature and high water pressure car washers are available depending on the type of car wash machine. If the car washer nozzle is put too close to the vehicle, the force of the spray could damage or deform the molding, affect the sealability of parts, and allow water to penetrate the interior. Keep a sufficient space (30 cm (12 in) or more) between the nozzle and the vehicle. In addition, do not spend too much time spraying the same area of the vehicle, and be very careful when spraying between gaps in doors and around windows.

Waxing

Your vehicle needs to be waxed when water no longer beads on the finish. Always wash and dry the vehicle before waxing it. In addition to the vehicle body, wax the metal trim to maintain its luster.

1. Use wax which contains no abrasives.
Wax containing abrasives will remove paints and could damage bright metal parts.
2. Use a good grade of natural wax for metallic, mica, and solid colors.
3. When waxing, coat evenly with the sponge supplied or a soft cloth.
4. Wipe off the wax with a soft cloth.

NOTE

A spot remover to remove oil, tar, and similar materials will usually also take off the wax. Rewax these areas even if the rest of the vehicle does not need it.

Appearance Care

▼ Repairing Damage to the Finish

Deep scratches or chips on the finish should be repaired promptly. Exposed metal quickly rusts and can lead to major repairs.



If your Mazda is damaged and needs metal parts repaired or replaced, make sure the body shop applies anti-corrosion materials to all parts, both repaired and new. This will prevent them from rusting.

▼ Bright-Metal Maintenance

- Use tar remover to remove road tar and insects. Never do this with a knife or similar tool.
- To prevent corrosion on bright-metal surfaces, apply wax or chrome preservative and rub it to a high luster.
- During cold weather or in coastal areas, cover bright-metal parts with a coating of wax or preservative heavier than usual. It would also help to coat them with noncorrosive petroleum jelly or some other protective compound.



Do not use steel wool, abrasive cleaners, or strong detergents containing highly alkaline or caustic agents on chrome-plated or anodized aluminum parts. This may result in damage to the protective coating and cause discoloration or paint deterioration.

▼ Underbody Maintenance

Road chemicals and salt used for ice and snow removal and solvents used for dust control may collect on the underbody. If not removed, they will speed up rusting and deterioration of such underbody parts as fuel lines, frame, floor pan, and exhaust system, even though these parts may be coated with anti-corrosive material.

Thoroughly flush the underbody and wheel housings with lukewarm or cold water at the end of each winter. Try also to do this every month.

Pay special attention to these areas because they easily hide mud and dirt. **It will do more harm than good to wet down the road grime without removing it.**

The lower edges of doors, rocker panels, and frame members have drain holes that should not be clogged. Water trapped there will cause rusting.



Dry off brakes that have become wet by driving slowly, releasing the accelerator pedal and lightly applying the brakes several times until the brake performance returns to normal: Driving with wet brakes is dangerous. Increased stopping distance or the vehicle pulling to one side when braking could result in a serious accident. Light braking will indicate whether the brakes have been affected.

▼ Aluminum Wheel Maintenance*

A protective coating is provided over the aluminum wheels. Special care is needed to protect this coating.



Do not use any detergent other than mild detergent. Before using any detergent, verify the ingredients. Otherwise, the product could discolor or stain the aluminum wheels.

NOTE

- Do not use a wire brush or any abrasive cleaner, polishing compound, or solvent on aluminum wheels. They may damage the coating.
- Always use a sponge or soft cloth to clean the wheels. Rinse the wheels thoroughly with lukewarm or cold water. Also, be sure to clean the wheels after driving on dusty or salted roads to help prevent corrosion.
- Avoid washing your vehicle in an automatic car wash that uses high-speed or hard brushes.

▼ Plastic Part Maintenance

- When cleaning the plastic lenses of the lights, do not use gasoline, kerosene, rectified spirit, paint, thinner, highly acidic detergents, or strongly alkaline detergents. Otherwise, these chemical agents can discolor or damage the surfaces resulting in a significant loss in functionality. If plastic parts become inadvertently exposed to any of these chemical agents, flush with water immediately.
- If plastic parts such as the bumpers become inadvertently exposed to chemical agents or fluids such as gasoline, oil, engine coolant, or battery fluid, it could cause discoloration, staining, or paint peeling. Wipe off any such chemical agents or fluids using a soft cloth immediately.
- High water temperature and high water pressure car washers are available depending on the type of high pressure car washer device. If the car washer nozzle is put too close to the vehicle or aimed at one area for an extended period of time, it could deform plastic parts or damage the paint.
- Do not use wax containing compounds (polish). Otherwise, it could result in paint damage.
- In addition, do not use an electrical or air tool to apply wax. Otherwise, the frictional heat generated could result in deformation of plastic parts or paint damage.

Interior Care

▼ Interior Care

WARNING

Do not spray water into the vehicle cabin:

Spraying water into the vehicle cabin is dangerous as electrical devices such as the audio and switches could get wet resulting in a malfunction or vehicle fire.

NOTE

- Do not wipe the interior using alcohol, chlorine bleach, or organic solvents such as thinner, benzene, and gasoline. Otherwise, it may cause discoloration or stains.
- Rubbing hard with a stiff brush or cloth may cause damage.

If the vehicle interior becomes soiled by any of the following, wipe it off immediately using a soft cloth. Leaving it uncleaned could cause discoloration, stains, cracks, or peeling of the coating, and it will make it hard to wipe off later.

- Beverage or fragrance
- Grease or oil
- Soiling

▼ Seat Belt Maintenance

1. Clean the soiled area by lightly dabbing it with a soft cloth soaked in a mild detergent (approx. 5%) diluted with water.
2. Wipe off the remaining detergent using a cloth soaked in clean water and wrung out well.

3. Before retracting seat belts which have been pulled out for cleaning, dry them off thoroughly and make sure there is no remaining moisture on them.

WARNING

If a seat belt appears frayed or has abrasions, have it replaced by an Authorized Mazda Dealer:

If a seat belt is used under such a condition, it cannot function at its full capacity which could result in serious injury or death.

Use a mild detergent to remove soiling from a seat belt:

If organic solvents are used for cleaning the seat belts or they become stained or bleached, there is the possibility of them becoming weakened and as a result, they may not function at their full capacity which could cause serious injury or death.

NOTE

Clean seat belts diligently if they get dirty. Leaving them uncleaned will make it difficult to clean them later, and it may affect the smooth retracting of the seat belt.

▼ Vinyl Upholstery Maintenance

Remove dust and dirt from the vinyl upholstery using a brush or vacuum. Remove soiling from vinyl upholstery using a leather and vinyl upholstery cleaner.

▼ Upholstery Maintenance

1. Clean the soiled area by lightly dabbing it with a soft cloth soaked in a mild detergent (approx. 5%) diluted with water.
2. Wipe off the remaining detergent using a cloth soaked in clean water and wrung out well.

▼ Leather Upholstery Maintenance*

1. Remove dust and sand using a vacuum cleaner.
2. Wipe off the soiled area with a soft cloth and a suitable, special cleaner or a soft cloth soaked in a mild detergent (about 5%) diluted with water.
3. Wipe off the remaining detergent using a cloth soaked in clean water and wrung out well.
4. Remove moisture with a dry, soft cloth and allow the leather to further dry in a well-ventilated, shaded area. If the leather gets wet such as from rain, remove the moisture and dry it as soon as possible.

NOTE

- Because genuine leather is a natural material, its surface is not uniform and it may have natural scars, scratches, and wrinkles.
- To maintain the quality for as long as possible, periodical maintenance, about twice a year, is recommended.
- If the leather upholstery comes into contact with any of the following, clean it immediately. Leaving it uncleaned could cause premature wear, mold, or stains.
 - Sand or dirt
 - Grease or oil, such as hand cream
 - Alcohol, such as in cosmetic or hair dressing items

- If the leather upholstery gets wet, promptly remove moisture with a dry cloth. Remaining moisture on the surface may cause deterioration such as hardening and shrinkage.
- Exposure to direct sunlight for long periods may cause deterioration and shrinkage. When parking the car under direct sunlight for long periods, shade the interior using sunshades.
- Do not leave vinyl products on the leather upholstery for long periods. They may affect the leather quality and coloring. If the cabin temperature becomes hot, the vinyl may deteriorate and adhere to the genuine leather.

▼ Plastic Part Maintenance



Do not use polishing agents. Depending on the product ingredients, they could cause discoloration, stains, cracks or peeling of the coating.

▼ Instrument Panel Top (Soft pad) Maintenance

Extremely soft material is used for the soft pad surface. If the soft pad surface is rubbed harshly with a dry cloth, it could result in the surface being damaged and leaving white scratch marks.

1. Wipe the soiled area with a soft cloth soaked in a mild detergent (approx. 5%) diluted with water.
2. Wipe off the remaining detergent using a cloth soaked in clean water and wrung out well.

Appearance Care

▼ Active Driving Display Maintenance

The dust-proof sheet has a coating. When cleaning, do not use a hard or rough-surface cloth, or cleaning detergent. In addition, if a chemical solvent gets on the active driving display, wipe it off immediately. The dust-proof sheet could be damaged and the surface coating could be scratched. Use a fine, soft cloth such as those used for cleaning eyeglasses.

NOTE

Use of compressed air when cleaning the dust-proof sheet is recommended.

▼ Panel Maintenance

If a panel becomes soiled, wipe it off with a soft cloth soaked in clean water and thoroughly wrung out.

If some areas require further cleaning, use the following procedure:

1. Wipe the soiled area with a soft cloth soaked in a mild detergent (approx. 5 %) diluted with water.
2. Wipe off the remaining detergent using a cloth soaked in clean water and wrung out well.

NOTE

Be particularly careful when cleaning shiny surface panels and metallic parts such as plating as they can be scratched easily.

▼ Cleaning the Window Interiors

If the windows become covered with an oily, greasy, or waxy film, clean them with glass cleaner. Follow the directions on the container.

CAUTION

- Do not scrape or scratch the inside of the window glass. It could damage the thermal filaments and the antenna lines.
- When washing the inside of the window glass, use a soft cloth dampened in lukewarm water, gently wiping the thermal filaments and the antenna lines.
Use of glass cleaning products could damage the thermal filaments and the antenna lines.

▼ Cleaning the Floor Mats

Rubber floor mats should be cleaned with mild soap and water only.

WARNING

Do not use rubber cleaners, such as tire cleaner or tire shine, when cleaning rubber floor mats:

Cleaning the rubber floor mats with rubber cleaning products makes the floor mats slippery.

This may cause an accident when depressing the accelerator, brake, or clutch (Manual transmission) pedal or when getting in or out of the vehicle.

After removing the floor mats for cleaning, always reinstall them securely (page 3-46).

7

If Trouble Arises

Helpful information on what to do if a problem arises with the vehicle.

Parking in an Emergency..... 7-2

Parking in an Emergency..... 7-2

Flat Tire..... 7-3

Spare Tire and Tool Storage.....

..... 7-3

Changing a Flat Tire.....7-7

Battery Runs Out.....7-17

Jump-Starting..... 7-17

Emergency Starting..... 7-20

Starting a Flooded Engine..... 7-20

Push-Starting..... 7-20

Overheating..... 7-21

Overheating..... 7-21

Emergency Towing..... 7-23

Towing Description..... 7-23

Tiedown Hooks* 7-24

Warning/Indicator Lights and

Warning Sounds..... 7-27

If a Warning Light Turns On or

Flashes..... 7-27

Message Indicated on Multi-

information Display..... 7-39

Warning Sound is

Activated.....7-42

When Liftgate/Trunk Lid Cannot be Opened..... 7-48

When Liftgate/Trunk Lid Cannot
be Opened.....7-48

Active Driving Display Does Not Operate..... 7-50

If the Active Driving Display Does
Not Operate* 7-50

Windshield Wipers Operate at High Speed..... 7-51

Windshield Wipers Operate at
High Speed..... 7-51

Parking in an Emergency

Parking in an Emergency

▼ Parking in an Emergency

The hazard warning lights should always be used when you stop on or near a roadway in an emergency.



The hazard warning lights warn other drivers that your vehicle is a traffic hazard and that they must take extreme caution when near it.



Depress the hazard warning flasher and all the turn signals will flash. The hazard warning indicator lights in the instrument cluster flash simultaneously.

NOTE

- The turn signals do not work when the hazard warning lights are on.
- Check local regulations about the use of hazard warning lights while the vehicle is being towed to verify that it is not in violation of the law.

Spare Tire and Tool Storage

▼ Spare Tire and Tool Storage

Spare tire and tools are stored in the locations illustrated in the diagram.

4-Door

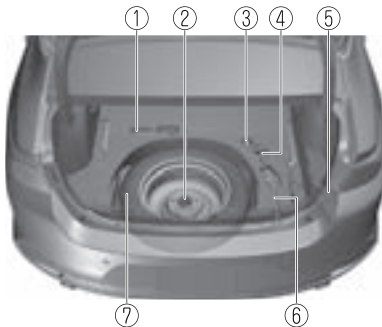

1. Tiedown eyelet*
2. Spare tire hold-down bolt
3. Jack lever
4. Flat tire hold-down bolt*
5. Jack
6. Lug wrench
7. Spare tire

5-Door

Type A

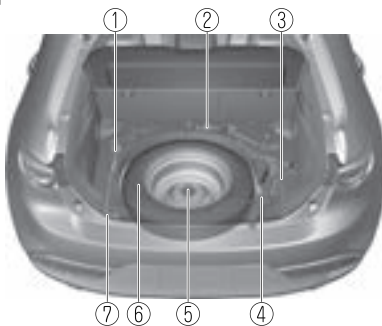

1. Tiedown eyelet*
2. Flat tire hold-down bolt*
3. Jack lever

4. Jack
5. Spare tire hold-down bolt
6. Spare tire
7. Lug wrench

Type B

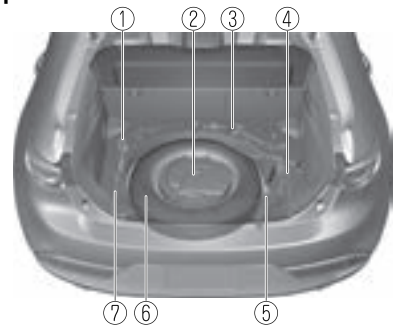

1. Tiedown eyelet*
2. Spare tire hold-down bolt
3. Flat tire hold-down bolt
4. Jack lever
5. Jack
6. Spare tire
7. Lug wrench

▼ Jack

To remove the jack

4-Door

1. Remove the trunk mat.



*Some models.

2. Remove the cover.



3. Turn the wing bolt and jack screw counterclockwise.

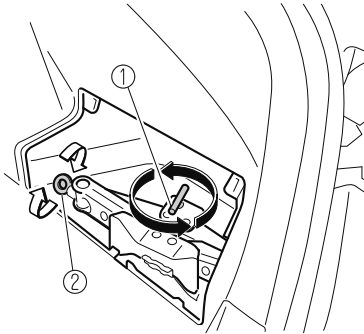

1. Wing bolt
2. jack screw

5-Door

1. Remove the luggage mat.

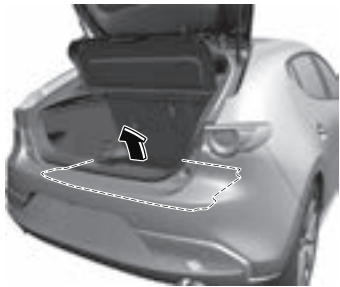

2. Remove the jack.



To secure the jack

4-Door

1. Insert the wing bolt into the jack with the jack screw pointing to the front and turn the wing bolt clockwise to temporarily tighten it.
2. Turn the jack screw clockwise.

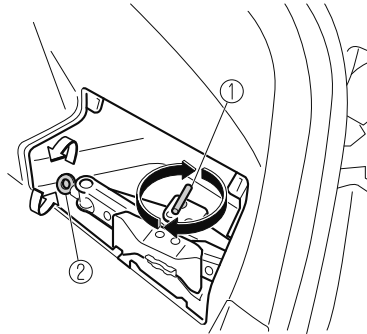

1. Wing bolt
2. jack screw

3. Turn the wing bolt completely to secure the jack.

NOTE

If the jack is not completely secured, it could rattle while driving. Make sure the jack screw is sufficiently tightened.

5-Door

Perform the removal procedure in reverse.

Maintenance

- Always keep the jack clean.
- Make sure the moving parts are kept free from dirt or rust.
- Make sure the screw thread is adequately lubricated.

▼ Spare Tire

Your Mazda has a temporary spare tire. The temporary spare tire is lighter and smaller than a conventional tire, and is designed only for emergency use and should be used only for VERY short periods. Temporary spare tires should NEVER be used for long drives or extended periods.

⚠ WARNING

Do not install the temporary spare tire on the front wheels (driving wheels):

Driving with the temporary spare tire on one of the front driving wheels is dangerous. Handling will be affected. You could lose control of the vehicle, especially on ice or snow bound roads, and have an accident. Move a regular tire to the front wheel and install the temporary spare tire to the rear.

⚠ CAUTION

- When using the temporary spare tire, driving stability may decrease compared to when using only the conventional tire. Drive carefully.
- To avoid damage to the temporary spare tire or to the vehicle, observe the following precautions:
 - Do not exceed 80 km/h (50 mph).
 - Avoid driving over obstacles. Also, do not drive through an automatic car wash. This tire's diameter is smaller than a conventional tire, so the ground clearance is reduced.
 - Do not use a tire chain on this tire because it will not fit properly.
 - Do not use your temporary spare tire on any other vehicle, it has been designed only for your Mazda.
 - Use only one temporary spare tire on your vehicle at the same time.

To remove the spare tire

4-Door

1. Remove the trunk mat.



2. Turn the spare tire hold-down bolt counterclockwise and remove the spare tire.



1. Spare tire hold-down bolt

NOTE

If the spare tire hold-down bolt cannot be loosened, hold the edge of the tire and turn it counterclockwise until the spare tire hold-down bolt rotates.

5-Door

1. Remove the luggage mat.

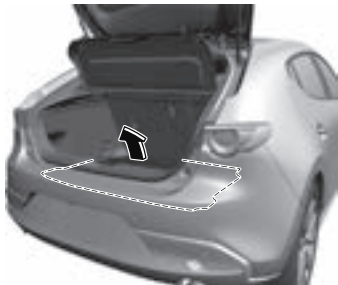

2. **(Vehicles with sub-woofer)**
Uncouple the sub-woofer connector.

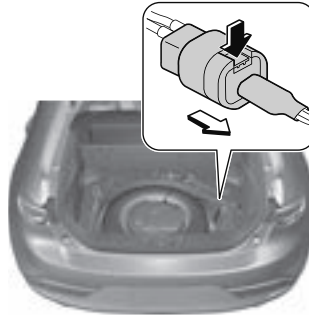

NOTE

Extra strength may be required to uncouple the connector. Be sure to squeeze the tab firmly.

3. **(Vehicles with sub-woofer)**
Turn the spare tire hold-down bolt counterclockwise and remove the sub-woofer and the spare tire.



(Vehicles without sub-woofer)

Turn the spare tire hold-down bolt counterclockwise and remove the spare tire.



1. Spare tire hold-down bolt

NOTE

If the spare tire hold-down bolt cannot be loosened, hold the edge of the tire and turn it counterclockwise until the spare tire hold-down bolt rotates.

To secure the spare tire

Store the spare tire in the reverse order of removal. After storing, verify that the spare tire is stored securely.

Changing a Flat Tire

▼ Changing a Flat Tire

NOTE

If the following occurs while driving, it could indicate a flat tire.

- Steering becomes difficult.
- The vehicle begins to vibrate excessively.
- The vehicle pulls in one direction.

If you have a flat tire, drive slowly to a level spot that is well off the road and out of the way of traffic to change the tire.

Stopping in traffic or on the shoulder of a busy road is dangerous.

WARNING

Be sure to follow the directions for changing a tire:

Changing a tire is dangerous if not done properly. The vehicle can slip off the jack and seriously injure someone. No person should place any portion of their body under a vehicle that is supported by a jack.

Never allow anyone inside a vehicle supported by a jack:

Allowing someone to remain in a vehicle supported by a jack is dangerous. The occupant could cause the vehicle to fall resulting in serious injury.

NOTE

Make sure the jack is well lubricated before using it.

Flat Tire

1. Park on a hard, level surface off the right-of-way and firmly set the parking brake.
2. Put a vehicle with an automatic transmission in Park (P), a manual transmission in Reverse (R) or 1, and turn off the engine.
3. Turn on the hazard warning flasher.
4. Have passengers get out of the vehicle and away from the vehicle and traffic.
5. Remove any luggage, the jack, tools, and spare tire (page 7-3).
6. Block the wheel diagonally opposite the flat tire. When blocking a wheel, place a tire block both in front and behind the tire.



NOTE

When blocking a tire, use rocks or wood blocks of sufficient size if possible to hold the tire in place.

▼ Removing a Flat Tire



When jacking-up a vehicle, always shift the shift lever to 1st or R position (manual transmission vehicle) or shift the selector lever to P position (automatic transmission vehicle), apply the parking brake, and place wheel blocks in the position diagonally opposed to the jack:

Changing a flat tire without using wheel blocks is dangerous because the vehicle may move and fall off the jack even with the shift lever in 1st or R position, or the selector lever is in P position, which could result in an accident.

1. If your vehicle is equipped with a wheel cover, pry off the wheel cover with the beveled end of the jack lever.



NOTE

Force the end of the jack lever firmly between wheel and cover, or removal will be difficult.

⚠ CAUTION

Align the notch on the wheel cover with the valve stem when installing it.

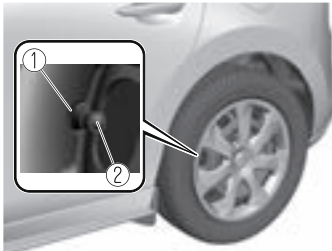

1. Notch
2. Tire valve

Damage could occur during installation if the wheel cover is not properly aligned.

2. Loosen the lug nuts by turning them counterclockwise one turn each, but do not remove any lug nuts until the tire has been raised off the ground.

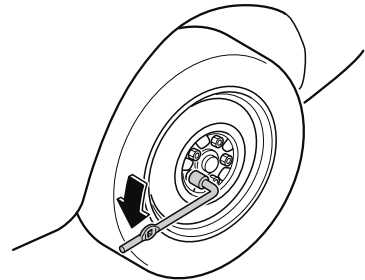

NOTE

If your Mazda is equipped with the optional antitheft wheel lug nuts, a special key must be used to unlock the locking lug nut for each wheel. For details, refer to the Locking Lug Nuts on page 7-11.

3. Place the jack on the ground.
4. Turn the jack screw in the direction shown in the figure and adjust the jack head so that it is close to the jack-up position.

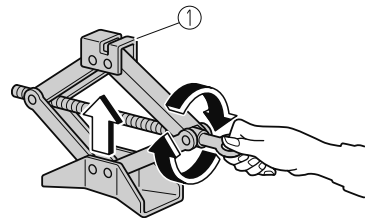

1. Jack head

5. Place the jack under the jack-up position closest to the tire being changed with the jack head squarely under the jack-up point.

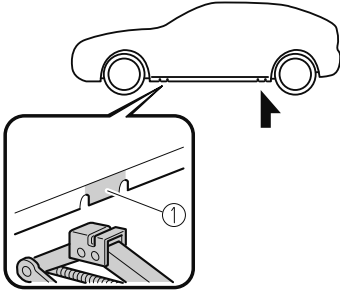

1. Jacking position

6. Continue raising the jack head gradually by rotating the screw with your hand until the jack head is inserted into the jack-up position.

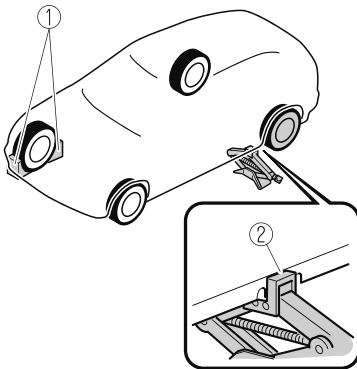

1. Tire blocks
2. Jacking position

⚠ WARNING

Use only the front and rear jacking positions recommended in this manual:

Attempting to jack the vehicle in positions other than those recommended in this manual is dangerous. The vehicle could slip off the jack and seriously injure or even kill someone. Use only the front and rear jacking positions recommended in this manual.

Do not jack up the vehicle in a position other than the designated jack-up position or place any objects on or under the jack:

Jacking up the vehicle in a position other than the designated jack-up position or placing objects on or under the jack is dangerous as it could deform the vehicle body or the vehicle could fall off the jack resulting in an accident.

Use only the jack provided with your Mazda:

Using a jack that is not designed for your Mazda is dangerous. The vehicle could slip off the jack and seriously injure someone.

Never place objects under the jack:

Jacking the vehicle with an object under the jack is dangerous. The jack could slip and someone could be seriously injured by the jack or the falling vehicle.

NOTE

When raising the jack head into the jacking position and aligning the groove in the jack head with the rail under the vehicle body, the top of the jack head contacts the vehicle's underbody without the rail contacting the bottom of the groove.

7. Insert the jack lever and attach the lug wrench to tire jack.

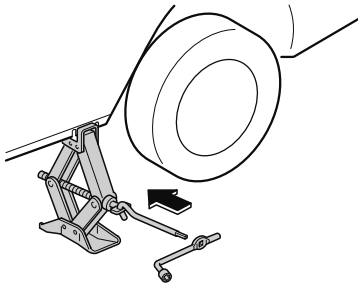

8. Turn the jack handle clockwise and raise the vehicle high enough so that the spare tire can be installed. Before removing the lug nuts, make sure your Mazda is firmly in position and that it cannot slip or move.

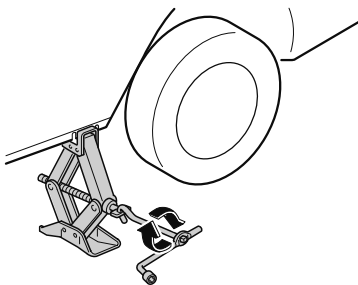

⚠ WARNING

Do not jack up the vehicle higher than is necessary:

Jacking up the vehicle higher than is necessary is dangerous as it could destabilize the vehicle resulting in an accident.

Do not start the engine or shake the vehicle while it is jacked up:

Starting the engine or shaking the vehicle while it is jacked up is dangerous as it could cause the vehicle to fall off the jack resulting in an accident.

Never go under the vehicle while it is jacked up:

Going under the vehicle while it is jacked up is dangerous as it could result in death or serious injury if the vehicle were to fall off the jack.

9. Remove the lug nuts by turning them counterclockwise; then remove the wheel and center cap.

▼ Locking Lug Nuts

If your Mazda is equipped with the optional antitheft wheel lug nuts, a special key must be used to unlock the locking lug nut for each wheel. The key is stored in the glove compartment, center console storage, storage box, or trunk. Register the key and lug nuts with the lock manufacturer by filling out the registration card and mailing it in using the accompanying envelope. If the key is lost, consult an Authorized Mazda Dealer or use the lock manufacturer's order form to order a new key.

Flat Tire

Antitheft wheel lug nuts cannot be installed on a steel wheel spare tire. When installing a temporary spare tire, use one of the original lug nuts in place of the locking lug nut. The original lug nuts are stored inside your Mazda.

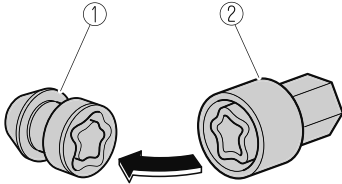

1. Antitheft lug nut
2. Special key

To remove an antitheft lug nut

1. Obtain the special key for the antitheft lug nut.
2. Place the special key on top of the antitheft lug nut, and be sure to hold the key square to it. If you hold the key at an angle, you may damage both key and nut. Do not use a power impact wrench.
3. Place the lug wrench on top of the key and apply pressure. Turn the wrench counterclockwise.

To install the antitheft lug nut

1. Place the special key on top of the nut, and be sure to hold the key square to it. If you hold the key at an angle, you may damage both key and nut. Do not use a power impact wrench.
2. Place the lug wrench on top of the special key, apply pressure, and turn it clockwise.

Nut tightening torque	
N·m (kgf·m, ft·lbf)	108—147 (12—14, 80—108)

▼ Mounting the Spare Tire

1. Remove dirt and grime from the mounting surfaces of the wheel and hub, including the hub bolts, with a cloth.

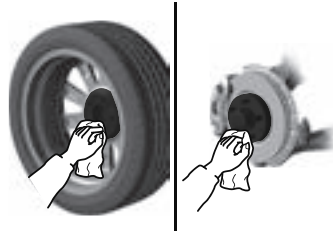

⚠ WARNING

Make sure the mounting surfaces of the wheel, hub and lug nuts are clean before changing or replacing tires:

When changing or replacing a tire, not removing dirt and grime from the mounting surfaces of the wheel, hub and hub bolts is dangerous. The lug nuts could loosen while driving and cause the tire to come off, resulting in an accident.

2. Mount the spare tire.
3. Install the lug nuts with the beveled edge inward; tighten them by hand.

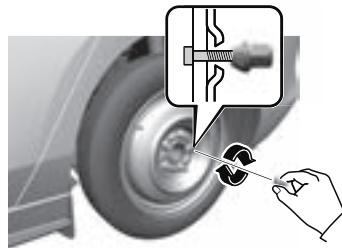

⚠ WARNING

Do not apply oil or grease to lug nuts and bolts and do not tighten the lug nuts beyond the recommended tightening torque:

Applying oil or grease to lug nuts and bolts is dangerous. The lug nuts could loosen while driving and cause the tire to come off, resulting in an accident. In addition, lug nuts and bolts could be damaged if tightened more than necessary.

4. Turn the jack handle counterclockwise using the lug wrench and lower the vehicle.
5. Use the lug wrench to tighten the nuts in the order shown.



If you are unsure of how tight the nuts should be, have them inspected at an Authorized Mazda Dealer.

Nut tightening torque	
N·m (kgf·m, ft·lbf)	108—147 (12—14, 80—108)

⚠ WARNING

Always securely and correctly tighten the lug nuts:

Improperly or loosely tightened lug nuts are dangerous. The wheel could wobble or come off. This could result in loss of vehicle control and cause a serious accident.

Be sure to reinstall the same nuts you removed or replace them with metric nuts of the same configuration:

Because the wheel studs and lug nuts on your Mazda have metric threads, using a non-metric nut is dangerous. On a metric stud, it would not secure the wheel and would damage the stud, which could cause the wheel to slip off and cause an accident.

6. **(Aluminum wheel equipped vehicle)**

Remove the center cap by tapping it from the backside of the wheel using the lug wrench.

7. Store the damaged tire in the trunk (4-door) or luggage compartment (5-door).



8. Secure the damaged tire to the vehicle using the following method.

(Vehicles with flat tire hold-down bolt (excluding vehicles with sub-woofer for 5-door))

1. Spread apart the tabs on the spare tire hold-down bolt that was removed when removing the spare tire and remove the bolt for securing the spare tire.

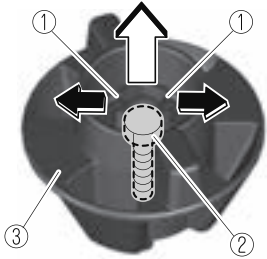

1. Tabs
2. Bolt for securing spare tire
3. Spare tire hold-down bolt

2. Remove the bolt for securing the flat tire from its stored position and install it in place of the removed spare tire hold-down bolt.

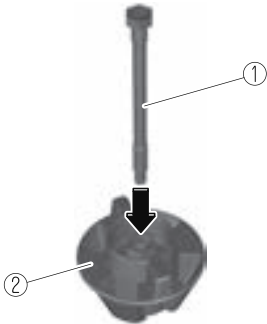

1. Bolt for securing the flat tire
2. Spare tire hold-down bolt

NOTE

The longer bolt is used as the bolt for securing the flat tire, and the shorter one is used as the bolt for securing the spare tire. When installing a bolt, check the bolt's length.

3. Secure the damaged tire to the vehicle using the flat tire hold-down bolt.



(Vehicles with flat tire hold-down bolt and with sub-woofer for 5-door))

1. Remove the bolt for securing the flat tire from its stored position.
2. Secure the damaged tire to the vehicle using the flat tire hold-down bolt.

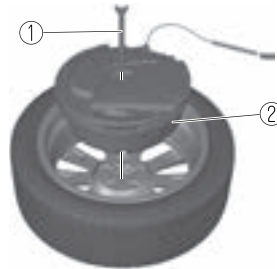

1. Flat tire hold-down bolt
2. Sub-woofer

(Vehicles without flat tire hold-down bolt)

1. Secure the damaged tire to the vehicle using the spare tire hold-down bolt removed when removing the spare tire.



9. Place the trunk mat (4-door) or luggage mat (5-door) on the damaged tire.



10. Remove the tire blocks and store the tools and jack.
11. Check the inflation pressure. Refer to Tires on page 9-10.
12. Have the flat tire repaired or replaced as soon as possible.
13. After repairing or replacing the flat tire, install the wheel cover (vehicles with steel wheels) or center cap (vehicles with aluminum wheels) using the following procedure.

(Wheel cover)

1. Align the notch on the wheel cover with the tire valve of the wheel and install the wheel cover to the wheel.

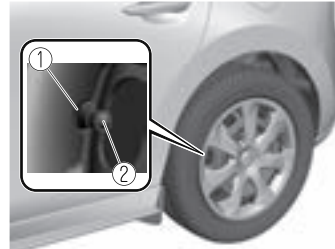

1. Notch
2. Tire valve



Always align the notch on the wheel cover with the tire valve of the wheel. Otherwise, it could cause damage to the wheel cover and the tire valve.

(Center cap)

1. Align the center cap with the center hole of the wheel and install the center cap to the wheel.



Flat Tire

WARNING

Do not drive with any tires that have incorrect air pressure:

Driving on tires with incorrect air pressure is dangerous. Tires with incorrect pressure could affect handling and result in an accident. When you check the regular tires' air pressure, check the spare tire, too.

NOTE

To prevent the jack and tool from rattling, store them properly.

Jump-Starting

▼ Jump-Starting

Jump-starting is dangerous if done incorrectly. So follow the procedure carefully. If you feel unsure about jump-starting, we strongly recommend that you have a competent service technician do the work.



Follow These Precautions Carefully:

To ensure safe and correct handling of the battery, read the following precautions carefully before using the battery or inspecting it.



Keep flames and sparks away from open battery cells and do not allow metal tools to contact the positive (+) or negative (-) terminal of the battery when working near a battery. Do not allow the positive (+) terminal to contact the vehicle body:

Flames and sparks near open battery cells are dangerous. Hydrogen gas, produced during normal battery operation, could ignite and cause the battery to explode. An exploding battery can cause serious burns and injuries. Keep all flames including cigarettes and sparks away from open battery cells.



Keep all flames and sparks away from open battery cells because hydrogen gas is produced from open battery cells while charging the battery or adding battery fluid:

Flames and sparks near open battery cells are dangerous. Hydrogen gas, produced during normal battery operation, could ignite and cause the battery to explode. An exploding battery can cause serious burns and injuries. Keep all flames including cigarettes and sparks away from open battery cells.

Do not jump-start a frozen battery or one with a low fluid level:

Jump-starting a frozen battery or one with a low fluid level is dangerous. It may rupture or explode, causing serious injury.

Battery Runs Out

Connect the negative cable to a good ground point away from the battery:

Connecting the end of the second jumper cable to the negative (–) terminal of the discharged battery is dangerous.

A spark could cause the gas around the battery to explode and injure someone.

Route the jumper cables away from parts that will be moving:

Connecting a jumper cable near or to moving parts (cooling fans, belts) is dangerous. The cable could get caught when the engine starts and cause serious injury.



Use only a 12 V booster system. You can damage a 12 V starter, ignition system, and other electrical parts beyond repair with a 24 V power supply (two 12 V batteries in series or a 24 V motor generator set).

1. Move the booster vehicle so that its battery is as close as possible to your vehicle's battery.
2. Make sure that the power such as for the headlights and air conditioner is turned off.
3. Remove the battery cover.

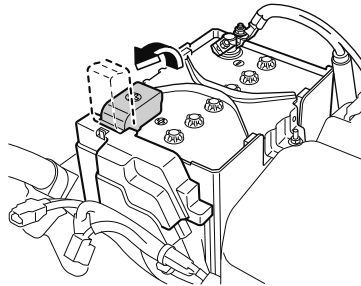

4. Turn off the booster vehicle's engine and connect the jumper cables in the following order.
Make sure that the jumper cables are securely connected so that they do not disconnect due to engine vibrations.

1st lead

① Positive (+) terminal on the discharged battery

② Positive (+) terminal on booster vehicle's battery

2nd lead

③ Negative (-) terminal on booster vehicle's battery

④ Location shown in the figure (do not connect to the negative (-) terminal of the battery)

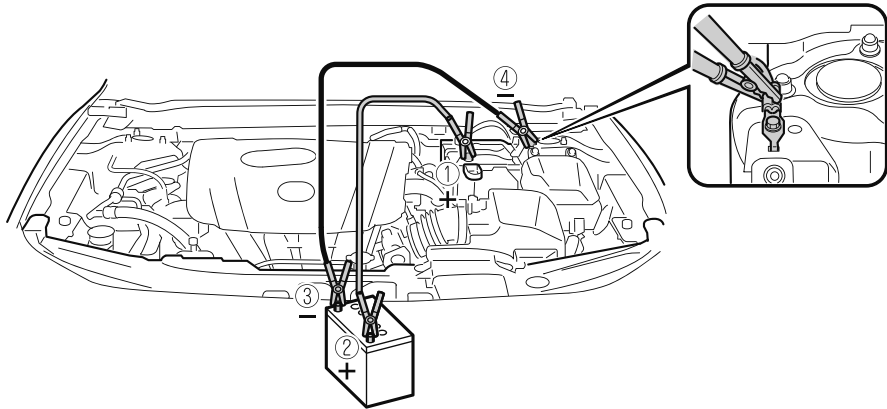

5. Start the booster vehicle's engine and rev the engine.
6. Start the engine of your vehicle. Run the engines for about 3 minutes to temporarily charge the battery of your vehicle.
7. Disconnect the jumper cables in the reverse order of their connection.
8. Install the battery cover.
9. Have your vehicle inspected by an Authorized Mazda Dealer as soon as possible.

Emergency Starting

Starting a Flooded Engine

▼ Starting a Flooded Engine

If the engine fails to start, it may be flooded (excessive fuel in the engine).

Follow this procedure:

1. If the engine does not start within 5 seconds on the first try, wait 10 seconds and try again.
2. Make sure the parking brake is on.
3. Depress the accelerator all the way and hold it there.
4. Depress the clutch pedal (manual transmission) or the brake pedal (automatic transmission), then press the push button start. If the engine starts, release the accelerator immediately because the engine will suddenly rev up.
5. If the engine fails to start, crank it without depressing the accelerator.

If the engine still does not start using the previous procedure, have your vehicle inspected by an Authorized Mazda Dealer.

Push-Starting

▼ Push-Starting

Do not push-start your Mazda.



Never tow a vehicle to start it:

Towing a vehicle to start it is dangerous. The vehicle being towed could surge forward when its engine starts, causing the 2 vehicles to collide. The occupants could be injured.



Do not push-start a vehicle that has a manual transmission. It can damage the emission control system.

NOTE

You cannot start a vehicle with an automatic transmission by pushing it.

Overheating

▼ Overheating

If the engine coolant temperature gauge indicates overheating and the high engine coolant temperature warning indication is displayed, the vehicle loses power or you hear a loud knocking or pinging noise, the engine is probably too hot.

WARNING



Pull over to a safe location, then switch the ignition off and make sure the fan is not running before attempting to work near the cooling fan:

Working near the cooling fan when it is running is dangerous. The fan could continue running indefinitely even if the engine has stopped and the engine compartment temperature is high. You could be hit by the fan and seriously injured.

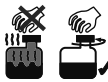

Do not remove either cooling system cap when the engine and radiator are hot:

When the engine and radiator are hot, scalding coolant and steam may shoot out under pressure and cause serious injury.

Open the hood ONLY after steam is no longer escaping from the engine: Steam from an overheated engine is dangerous. The escaping steam could seriously burn you.

If the engine coolant temperature gauge indicates overheating and the high engine coolant temperature warning indication is displayed:

1. Drive safely to the side of the road and park off the right-of-way.
2. Put a vehicle with an automatic transmission in park (P), a manual transmission in neutral.
3. Apply the parking brake.
4. Turn off the air conditioner.
5. Check whether coolant or steam is escaping from the engine compartment.

If steam is coming from the engine compartment:

Do not go near the front of the vehicle. Stop the engine.

Wait until the steam dissipates, then open the hood and start the engine.

If neither coolant nor steam is escaping:

Open the hood and idle the engine until it cools.

CAUTION

If the cooling fan does not operate while the engine is running, the engine temperature will increase. Stop the engine and call an Authorized Mazda Dealer.

Overheating

6. Make sure the cooling fan is operating, then turn off the engine after the temperature has decreased.
7. When cool, check the coolant level. If it is low, look for coolant leaks from the radiator and hoses.

If you find a leak or other damage, or if coolant is still leaking:

Stop the engine and call an Authorized Mazda Dealer.

SKYACTIV-G 2.0 and SKYACTIV-G 2.5

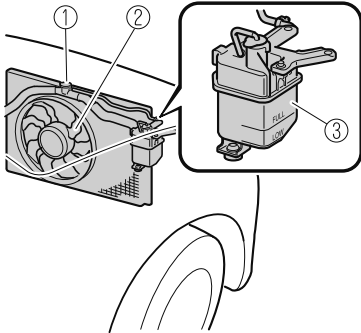

1. Cooling system cap
2. Cooling fan
3. Coolant reservoir

SKYACTIV-G 2.5T

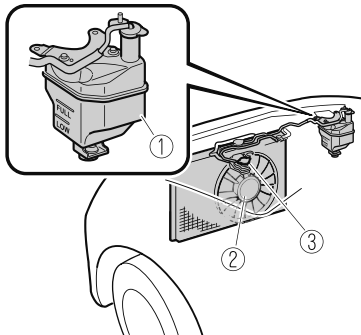

1. Coolant reservoir

2. Cooling fan
3. Cooling system cap

If you find no problems, the engine is cool, and no leaks are obvious:

Carefully add coolant as required (page 6-20).

⚠ CAUTION

If the engine continues to overheat or frequently overheats, have the cooling system inspected. The engine could be seriously damaged unless repairs are made. Consult an Authorized Mazda Dealer.

Towing Description

▼ Towing Description

We recommend that towing be done only by an Authorized Mazda Dealer or a commercial tow-truck service.

Proper lifting and towing are necessary to prevent damage to the vehicle. Particularly when towing an AWD vehicle, where all the wheels are connected to the drive train, proper transporting of the vehicle is absolutely essential to avoid damaging the drive system. Government and local laws must be followed.

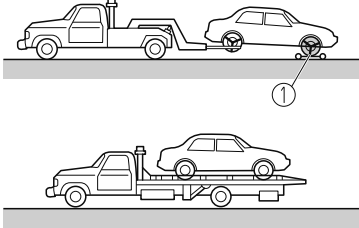

1. Wheel dollies

A towed FWD vehicle should have its drive wheels (front wheels) off the ground. If excessive damage or other conditions prevent this, use wheel dollies.

When towing a FWD vehicle with the rear wheels on the ground, release the parking brake. Refer to Electric Parking Brake (EPB) on page 4-66.

A towed AWD vehicle must have all its wheels off the ground.

WARNING

Always tow an AWD vehicle with all four wheels off the ground:

Towing an AWD vehicle with either the front or rear wheels on the ground is dangerous as the drive train could be damaged, or the vehicle could trail away from the tow truck and cause an accident. If the drive train has been damaged, transport the vehicle on a flatbed truck.

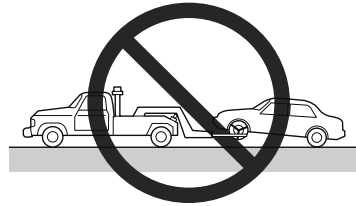

CAUTION

➤ Do not tow the vehicle pointed backward with driving wheels on the ground. This may cause internal damage to the transmission.

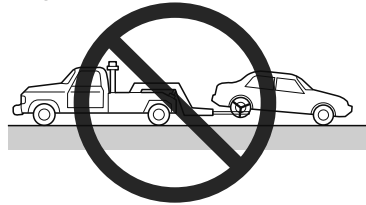

Emergency Towing

- Do not tow with sling-type equipment. This could damage your vehicle. Use wheel-lift or flatbed equipment.



- If the parking brake cannot be released when towing the vehicle, transport the vehicle with all front and rear wheels raised off the ground as shown in the figure. If the vehicle is towed without raising the wheels off the ground, the brake system could be damaged.

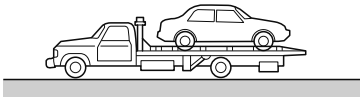
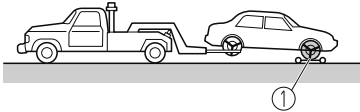

1. Wheel dollies

Tiedown Hooks*

▼ Tiedown Hooks



Do not use the front and rear tiedown eyelets for towing the vehicle. They have been designed only for securing the vehicle to a transport vessel during shipping. Using the eyelets for any other purpose could result in the vehicle being damaged.

1. Remove the tiedown eyelet and the lug wrench from the luggage compartment (page 7-3).
2. Wrap a flathead screwdriver or similar tool with a soft cloth to prevent damage to a painted bumper, and open the cap located on the front or rear bumper.

Front (4-Door)

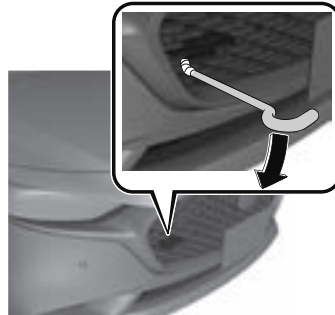

(5-Door)

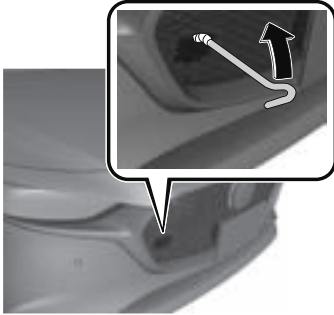

Rear
(4-Door)



(5-Door)



⚠ CAUTION

Do not use excessive force as it may damage the cap or scratch the painted bumper surface.

NOTE

Remove the cap completely and store it so as not to lose it.

3. Securely install the tiedown eyelet using the lug wrench.

Front

(4-Door)



1. Lug wrench
2. Tiedown eyelet

(5-Door)



1. Lug wrench
2. Tiedown eyelet

Emergency Towing

Rear (4-Door)

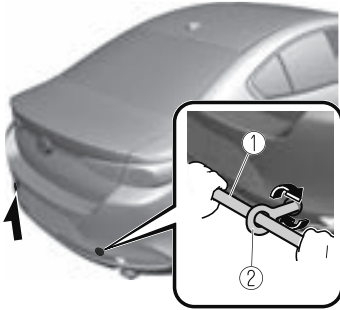

1. Lug wrench
2. Tiedown eyelet

(5-Door)

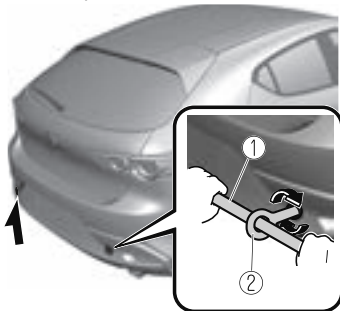

1. Lug wrench
2. Tiedown eyelet
4. Hook the tying rope to the tiedown eyelet.

CAUTION

If the tiedown eyelet is not securely tightened, it may loosen or disengage from the bumper when tying the vehicle. Make sure that the tiedown eyelet is securely tightened to the bumper.

Warning/Indicator Lights and Warning Sounds

If a Warning Light Turns On or Flashes

▼ If a Warning Light Turns On or Flashes

If any warning light turns on/flashes, take appropriate action for each light. There is no problem if the light turns off, however if the light does not turn off or turns on/flashes again, consult an Authorized Mazda Dealer. The details for some warnings can be viewed on the center display or multi-information display in the instrument cluster.

Center display

1. Select "Information" on the home screen.
2. Select "Vehicle Status Monitor".
3. Select the applicable warning to view the warning details.

NOTE

You can also display the currently occurring warning by sliding the commander knob to the left while on the home screen of the center display.

Multi-information display

1. Press the INFO switch on the steering switch to display the warning indication screen. Refer to Multi-information Display on page 4-14.

▼ Brake System Warning Indication/Warning Light



This warning has the following functions:

Warning light inspection

For an operation check, make sure that the light turns on when the ignition is switched on, and turns off a few seconds later or when the engine is started.

When the light turns on

If the brake system warning light remains illuminated the brake fluid may be low or there could be a problem with the brake system. Park the vehicle in a safe place immediately and contact an Authorized Mazda Dealer.

Refer to Inspecting Brake/Clutch Fluid Level on page 6-21.



Do not drive with the brake system warning light illuminated. Contact an Authorized Mazda Dealer to have the brakes inspected as soon as possible: Driving with the brake system warning light illuminated is dangerous. It indicates that your brakes may not work at all or that they could completely fail at any time. If this light remains illuminated, after checking that the parking brake is fully released, have the brakes inspected immediately.

Warning/Indicator Lights and Warning Sounds

CAUTION

- In addition, the effectiveness of the braking may diminish so you may need to depress the brake pedal more strongly than normal to stop the vehicle.

▼ Electronic Brake Force Distribution System Warning



If the electronic brake force distribution control unit determines that some components are operating incorrectly, the control unit may illuminate the brake system warning light and the ABS warning light simultaneously. The problem is likely to be the electronic brake force distribution system.

WARNING

Do not drive with both the brake system warning light and ABS warning light illuminated. Have the vehicle towed to an Authorized Mazda Dealer to have the brakes inspected as soon as possible:

Driving when the brake system warning light and ABS warning light are illuminated simultaneously is dangerous.

When both lights are illuminated, the rear wheels could lock more quickly in an emergency stop than under normal circumstances.

▼ Charging System Warning Indication/Warning Light



If the warning light illuminates while driving, it indicates a malfunction of the alternator or of the charging system.

Drive to the side of the road and park off the right-of-way. Consult an Authorized Mazda Dealer.

CAUTION

Do not continue driving when the charging system warning light is illuminated because the engine could stop unexpectedly.

▼ Engine Oil Warning Indication/Warning Light



This warning light indicates low engine oil pressure.

CAUTION

Do not run the engine if the oil pressure is low. Otherwise, it could result in extensive engine damage.

If the light illuminates or the warning indication is displayed while driving:

1. Drive to the side of the road and park off the right-of-way on level ground.
2. Turn off the engine and wait 5 minutes for the oil to drain back into the oil pan.

Warning/Indicator Lights and Warning Sounds

- Inspect the engine oil level (page 6-19). If it's low, add the appropriate amount of engine oil while being careful not to overfill.



Do not run the engine if the oil level is low. Otherwise, it could result in extensive engine damage.

- Start the engine and check the warning light.

If the light remains illuminated even though the oil level is normal or after adding oil, stop the engine immediately and have your vehicle towed to an Authorized Mazda Dealer.

▼ High Engine Coolant Temperature Warning Indication



Displays if the engine coolant temperature has increased excessively.

“Elevated Engine Coolant Temp. Drive Slowly” displayed

Drive slowly to reduce engine load until you can find a safe place to stop the vehicle and wait for the engine to cool down.

“Excessive Engine Coolant Temp. Stop the Vehicle in a Safe Location” displayed

This indicates the possibility of overheating. Park the vehicle in a safe place immediately and stop the engine.

Refer to Overheating on page 7-21.



Do not drive the vehicle with the high engine coolant temperature warning light illuminated. Otherwise, it could result in damage to the engine.

▼ Power Steering Malfunction Indication/Indicator Light



The message is displayed if the electric power steering has a malfunction. If the message is displayed, stop the vehicle in a safe place and do not operate the steering wheel. There is no problem if the indication turns off when the engine is restarted after some time has passed. If the indication displays even after the engine is restarted, contact an Authorized Mazda Dealer if the message is displayed continuously.

NOTE

- If the message is displayed, the power steering will not operate normally. In this case, the steering wheel can still be operated, however, the operation may feel heavy compared to normal, or the steering wheel could vibrate when turning.
- Repeatedly jerking the steering wheel left and right while the vehicle is stopped or moving extremely slowly will cause the power steering system to go into protective mode which will make the steering feel heavy, but this does not indicate a problem. If this occurs, park the vehicle safely and wait several minutes for the system to return to normal.

Warning/Indicator Lights and Warning Sounds

▼ ABS Warning Indication/Warning Light



If the ABS warning light stays on while you're driving, the ABS control unit has detected a system malfunction. If this occurs, your brakes will function normally as if the vehicle had no ABS. Should this happen, consult an Authorized Mazda Dealer as soon as possible.

NOTE

- When the engine is jump-started to charge the battery, uneven rpm occurs and the ABS warning light may illuminate. If this occurs, it is the result of the weak battery and does not indicate an ABS malfunction. Recharge the battery.
- The brake assist system does not operate while the ABS warning light is illuminated.

▼ Master Warning Indication



The indication displays if the system has a malfunction. Check the reason for the indication displaying on the center display or multi-information display. Refer to If a Warning Light Turns On or Flashes on page 7-27.

▼ Brake Control System Warning Indication/Warning Light



The warning light illuminates when the system has a malfunction. Have your vehicle inspected at an Authorized Mazda Dealer.

▼ Electric Parking Brake (EPB) Indication/Indicator Light



This warning has the following functions:

Parking brake warning/Indicator light inspection

The light illuminates when the parking brake is applied with the ignition switched to START or ON. It turns off when the parking brake is released.

When the light is flashing

The light flashes if the Electric Parking Brake (EPB) has a malfunction. If the light remains flashing even if the Electric Parking Brake (EPB) switch is operated, consult an Authorized Mazda Dealer as soon as possible.

Warning/Indicator Lights and Warning Sounds

▼ Brake Override Warning Indication



This message is displayed when the accelerator pedal and brake pedal are depressed at the same time while driving.

Release the accelerator pedal and depress the brake pedal.

▼ Check Engine Indication/Light



If this light illuminates while driving, the vehicle may have a problem. It is important to note the driving conditions when the light illuminated and consult an Authorized Mazda Dealer.

The check engine light may illuminate in the following cases:

- The engine's electrical system has a problem.
- The emission control system has a problem.
- The fuel-filler cap is missing or not tightened securely.
- The fuel tank level being very low or approaching empty.

If the check engine light remains on, or it flashes continuously, do not drive at high speeds and consult an Authorized Mazda Dealer as soon as possible.

WARNING

If the check engine light turns on, do not disconnect the battery cables.

If the battery cables are disconnected and then reconnected, the engine could be damaged and catch on fire.

▼ Automatic Transmission Warning Indication/Warning Light*

AT

The indication/light illuminates when the transmission has a problem.

CAUTION

If the automatic transmission warning indication/light illuminates, the transmission has an electrical problem. Continuing to drive your Mazda in this condition could cause damage to your transmission. Consult an Authorized Mazda Dealer as soon as possible.

▼ AWD Warning Indication/Warning Light*

AWD

“AWD Malfunction. Front Wheel Drive Only. Have the Vehicle Inspected” is displayed/When the light is turned on

The indication is displayed/the light turns on under the following conditions. The system may have a malfunction. Have the vehicle checked at an Authorized Mazda Dealer.

Warning/Indicator Lights and Warning Sounds

- When there is a malfunction in the AWD system.

“Excessive AWD System Load. Drive Slowly Until Warning Light Turns Off. Vehicle Now in Front Wheel Drive” is displayed/When the light is flashing

The indication is displayed/the light flashes under the following conditions. Park the vehicle in a safe place and check that the warning indication light turns off/ the warning light stops flashing, and then drive the vehicle. Contact an Authorized Mazda Dealer if the indication is continuously displayed.

- When the differential oil temperature is excessively high.
- When there is a large difference between the front and rear wheel rotation, such as when trying to remove the vehicle from mud.

“Mismatched Tire Diameters. Vehicle Now in Front Wheel Drive” is displayed/When the light is turned on

The indication is displayed/the light turns on under the following conditions. Inspect the tire sizes or tire pressures on all 4 wheels. Contact an Authorized Mazda Dealer if the indication remains on or the warning light remains illuminated.

- When any of the tire diameter is different.
- When any of the tire pressure is incorrect.

▼ TCS/DSC Indication/Indicator Light (Turns on)



If the light stays on, the TCS, DSC or the brake assist system may have a malfunction and they may not operate correctly. Take your vehicle to an Authorized Mazda Dealer.

▼ Air Bag/Front Seat Belt Pretensioner System Warning Indication/Warning Light



A system malfunction is indicated if the warning light constantly flashes, constantly illuminates or does not illuminate at all when the ignition is switched ON. If any of these occur, consult an Authorized Mazda Dealer as soon as possible. The system may not operate in an accident.

⚠ WARNING

Never tamper with the air bag/pretensioner systems and always have an Authorized Mazda Dealer perform all servicing and repairs:

Self-servicing or tampering with the systems is dangerous. An air bag/pretensioner could accidentally activate or become disabled causing serious injury or death.

Warning/Indicator Lights and Warning Sounds

▼ Tire Pressure Monitoring System (TPMS) Warning Indication/Warning Light (Flashing)



If there is a problem with the TPMS or the voltage of a tire pressure sensor decreases, the TPMS warning light flashes and a message is displayed on the multi-information display. Have your vehicle inspected by an Authorized Mazda Dealer.



Do not drive the vehicle at high speeds if the TPMS warning light turns on or flashes:

Driving the vehicle at high speeds while the TPMS warning light is turned on or flashing is dangerous because the brake performance and the steering wheel operability will be reduced. If the vehicle is driven at high speeds or the brakes are suddenly applied, it could lead to an accident. Gradually apply the brakes to lower the vehicle's speed.

Do not ignore the TPMS warning light when it is turned on or flashing:

Continuing to drive the vehicle while ignoring the illumination/flashing of the TPMS warning light is dangerous because a tire may burst which could lead to an accident. Take appropriate measures as soon as possible.

▼ KEY Warning Indication/Warning Light (Red)



“Keyless Entry System Malfunction. Have the Vehicle Inspected” is displayed

This message is displayed if the advanced keyless entry & push button start system has a problem. Contact an Authorized Mazda Dealer.



If the message is indicated, or the push button start indicator light (amber) flashes, the engine may not start. If the engine cannot be started, try starting it using the emergency operation for starting the engine, and have the vehicle inspected at an Authorized Mazda Dealer as soon as possible. Refer to Emergency Operation for Starting the Engine on page 4-9.

Warning/Indicator Lights and Warning Sounds

“Key Not Detected” is displayed

- If the presence of the key cannot be detected (dead battery, battery malfunction, no key), it is displayed when the driver attempts to start the engine (push button start operation, brake pedal depression).
- Displayed when it is determined that a key that was in the vehicle has been removed from the vehicle. (Key taken out warning. Other than IG-OFF).

▼ Security Indicator Light



If the security indicator light flashes continuously while you are driving, do not shut off the engine. Go to an Authorized Mazda Dealer and have it checked. If the engine is shut off while the indicator light is flashing, you will not be able to restart it. Make sure the key is within the operational range for signal transmission. Switch the ignition off, and then restart the engine. If the engine does not start after 3 or more tries, contact an Authorized Mazda Dealer.

NOTE

Because the electronic codes are reset when the immobilizer system is repaired, the keys are needed. Make sure to bring all the keys to an Authorized Mazda Dealer so that they can be programmed.

▼ High Beam Control System (HBC) Warning Indication/Warning Light (Amber)*



The light remains turned on if there is a problem with the system. Have your vehicle inspected at an Authorized Mazda Dealer.

▼ i-ACTIVSENSE Warning Indication/Warning Light*



The indication displays if the system has a malfunction. Check the reason for the indication displaying on the center display or multi-information display. Refer to If a Warning Light Turns On or Flashes on page 7-27.

▼ Exterior Light Warning Indication/Warning Light



This light illuminates if there is a malfunction in the exterior lights (except license plate lights). Have your vehicle inspected by an Authorized Mazda Dealer.

Warning/Indicator Lights and Warning Sounds

CAUTION

Do not drive the vehicle while an exterior light has a malfunction. Poor visibility, and not being able to signal braking and turns may cause an accident. In addition, if the vehicle is driven with the lights not turned on, it may conflict with laws and regulations due to poor maintenance.

▼ Low Fuel Warning Indication/ Warning Light



The warning indication/warning light displays/turns on when the ignition is switched ON and the remaining fuel is about 9 L (2.3 US gal, 1.9 Imp gal) or the remaining distance to empty is 50 km (31 miles) or shorter. The warning light flashes when the vehicle continues to be driven with the warning indication/warning light displayed/turned on and the remaining fuel in the tank is near empty.

NOTE

The light illumination timing may vary because fuel inside the fuel tank moves around according to the driving conditions and the vehicle posture.

Action to be taken

Add fuel. If the light is flashing, refuel as soon as possible.

▼ Check Fuel Cap Warning Indication/Warning Light



If the check fuel cap warning light illuminates while driving, the fuel-filler cap may not be installed properly.

Action to be taken

Stop the engine and reinstall the fuel-filler cap.
Refer to Refueling on page 3-28.

▼ Engine Oil Level Warning Indication/Warning Light



This warning light indicates that the engine oil level is around the MIN mark (page 6-19).

CAUTION

Do not continue to drive the vehicle with the engine oil level warning indication/warning light displayed/turned on. If the vehicle continues to be driven with an insufficient amount of engine oil, it could cause damage to the engine.

Action to be taken

Add 1 L (0.26 US gal, 0.22 Imp gal) of engine oil (page 6-17).

Warning/Indicator Lights and Warning Sounds

▼ Seat Belt Warning Indication/ Warning Light (Front seat)



The seat belt warning light turns on if the driver or front passenger's seat is occupied and the seat belt is not fastened with the ignition switched ON.

If the driver or front passenger's seat belt is unfastened (only when the front passenger's seat is occupied) and if the vehicle is driven at about 20 km/h (12 mph) or faster, or about 10 km/h (6 mph) or faster for a continuous 30 seconds, with the seat belt unfastened, the warning light flashes for a certain period. After a short time, the warning light stops flashing, but remains illuminated.

NOTE

- The warning light flashes for about 6 seconds if the driver or front passenger's seat is not fastened when the ignition is switched ON. (Except Mexico)
- Placing heavy items on the front passenger's seat may cause the front passenger's seat belt warning function to operate depending on the weight of the item.
- To allow the front passenger occupant classification sensor to function properly, do not place and sit on an additional seat cushion on the front passenger's seat. The sensor may not function properly because the additional seat cushion could cause sensor interference.
- If a small child is seated on the front passenger's seat, the warning light may not operate.

Action to be taken

Fasten the seat belts.

▼ Seat Belt Warning Light (Rear seat) (Red)



If the rear seat belts are not fastened while the ignition is switched ON, the driver and the passenger are alerted by the warning light.

The warning light operates even if there is no passenger on the rear seat.

NOTE

If a rear seat belt is not fastened by a certain period of time after the engine has been started, the warning light turns off.

Action to be taken

Fasten the seat belts.

▼ Low Washer Fluid Level Warning Indication/Warning Light*



This warning light indicates that little washer fluid remains.

Action to be taken

Add washer fluid (page 6-22).

Warning/Indicator Lights and Warning Sounds

▼ Door-Ajar/Trunk lid-Ajar/ Liftgate-Ajar Warning Indication/ Warning Light

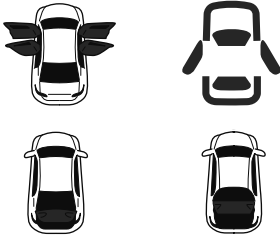

The light turns on if any door/trunk lid/liftgate is not closed securely.

Action to be taken

Close the door/trunk lid/liftgate securely.

▼ Tire Pressure Monitoring System (TPMS) Warning Indication/ Warning Light (Turns on)



If a tire pressure decreases below the specified air pressure, the TPMS warning light turns on. At the same time, a message and the tire pressure of each tire are displayed on the multi-information display alternately. In addition, the tire (s) with low air pressure is displayed in yellow.

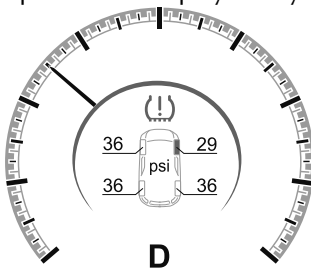

⚠ WARNING

Do not drive the vehicle at high speeds if the TPMS warning light turns on or flashes:

Driving the vehicle at high speeds while the TPMS warning light is turned on or flashing is dangerous because the brake performance and the steering wheel operability will be reduced. If the vehicle is driven at high speeds or the brakes are suddenly applied, it could lead to an accident. Gradually apply the brakes to lower the vehicle's speed.

Do not ignore the TPMS warning light when it is turned on or flashing:

Continuing to drive the vehicle while ignoring the illumination/flashing of the TPMS warning light is dangerous because a tire may burst which could lead to an accident. Take appropriate measures as soon as possible.

NOTE

While the TPMS is learning the tire positions, such as immediately after a tire position has been changed, the tire pressure at the tire position prior to it being changed is displayed until the system completes the learning. For this reason, the tire pressures displayed for the tire positions may be different from the actual tire pressures at the tire positions.

Action to be taken

Adjust the tire pressures to the appropriate pressures. Refer to Tire Inflation Pressure on page 6-34.

Warning/Indicator Lights and Warning Sounds

CAUTION

- Adjust the tire pressures while the tires are cool. Because the air pressure in the tires fluctuates depending on the temperature, before adjusting the tire pressures, let the vehicle sit for an hour or drive it only within a 1.6 km (1 mile) distance. If the tire pressures are adjusted while the tires are warm, the tire pressures may decrease below the specified air pressure after cooling down which could turn on the warning light. In addition, because the air pressure in the tires decreases when the ambient temperature is low, if the ambient temperature increases, an illuminated TPMS warning light may turn off. Under any circumstances, always adjust the tire pressures while the tires are cool.
- After adjusting the tire pressures, the TPMS warning light turns off. If the TPMS warning light does not turn off, drive the vehicle at a speed of about 25 km (16 mph) or faster for 3 minutes or longer and make sure the warning light turns off.

If the TPMS warning light remains on even after adjusting the tire pressures, one of the tires may have a puncture.

▼ KEY Indicator Light (Green) (Flashing)



“Low Key Fob Battery. Replace Battery” is displayed/When the light is flashing

When the key battery is low, the indication is displayed when the ignition is switched OFF.

Action to be taken

Replace the key battery.

Warning/Indicator Lights and Warning Sounds

Message Indicated on Multi-information Display

▼ Message Indicated on Multi-information Display

If there is a notification from the vehicle, a message is displayed on the multi-information display. Check the information and take the necessary action.

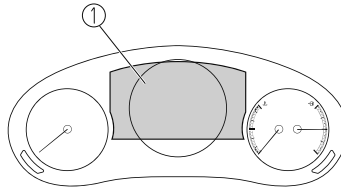

1. Multi-information display

If the warning light turns on/flashes simultaneously or a symbol is indicated on the display, check the information regarding the warning light or symbol. Refer to If a Warning Light Turns On or Flashes on page 7-27.

Display ^{1,2}	Content	Action to be taken
Depress Brake Pedal. Brake Hold Disabled	This message is indicated when there is a problem with the brake related system while the vehicle is being held in a stop position by the AUTOHOLD function.	Depress the brake pedal. Cancel the AUTOHOLD function and have your vehicle inspected at an Authorized Mazda Dealer.
Steep Slope. Continue Pressing Brake Pedal to Hold Stopped Position	This message indicates the possibility of the vehicle not being held in the stopped position by the AUTOHOLD function, such as on steep slopes.	Depress and hold your foot on the brake pedal.
Depress Brake Pedal and Operate Switch to Release Elec. Parking Brake	This message is indicated when the Electric Parking Brake (EPB) switch is operated without depressing the brake pedal.	Operate the Electric Parking Brake (EPB) switch while depressing the brake pedal.
Depress Brake Pedal and Operate Switch to Release	This message is indicated when the cancel operation is done without depressing the brake pedal while the vehicle is being held in the stopped position by the AUTOHOLD function.	Cancel the AUTOHOLD function stop hold control while depressing the brake pedal.

Warning/Indicator Lights and Warning Sounds

Display ^{*1,2}	Content	Action to be taken
Mazda Radar Cruise Control Canceled. Drive Safely	This message is indicated when the Mazda Radar Cruise Control (MRCC), Mazda Radar Cruise Control with Stop & Go function (MRCC with Stop & Go function), and the Traffic Jam Assist (TJA) have been canceled other than by the driver.	Have your vehicle inspected by an Authorized Mazda Dealer.
Distance & Speed Alert Operation Canceled Drive Safely	This message is indicated when the Distance & Speed Alert (DSA) have been canceled other than by the driver.	Have your vehicle inspected by an Authorized Mazda Dealer.
Cruise Control Operation Canceled. Drive Safely	This message is indicated when the Cruise Control have been canceled other than by the driver.	Have your vehicle inspected by an Authorized Mazda Dealer.
Emergency Braking Activated. Depress Brake Pedal to Hold Stop	This message is indicated after the Smart Brake Support (SBS) brakes operate and when the Smart Brake Support (SBS) is canceled.	Depress the brake pedal.
Touch Key Fob to Push Button Start Switch	This message is indicated when the key battery is weak (battery dead or damaged key).	Touch the key against push button start to start the engine. Refer to Engine Start Function When Key Battery is Dead on page 4-8.
Depress Brake Pedal to Start Vehicle	This message is indicated when the push button start is pressed without depressing the brake pedal.	When starting the engine, press the push button start with the brake pedal depressed.
Depress Clutch Pedal to Start Vehicle	This message is indicated when the push button start is pressed without depressing the clutch pedal.	When starting the engine, press the push button start with the clutch pedal depressed.
Check Gear Selector Lever Position	This message is indicated when the selector lever is shifted to the P or R position while driving.	Check the selector lever position.
Close Door and Fasten Seat Belt	This message is indicated when AUTOHOLD is about to operate and a door is opened or a seat belt is unfastened.	When the AUTOHOLD is turned on, close the doors and fasten seat belts.
Wiper Blades Must Be on Windshield Before Operating	This message is indicated when the ignition is switched ON with the wiper arms at the service positions.	Return the wiper arms to the initial positions.

Warning/Indicator Lights and Warning Sounds

Display ^{*1*2}	Content	Action to be taken
Windshield Wiper Range of Motion Reduced. Remove Obstruction(s)	This message is indicated when there is snow or dirt accumulation on the windshield and the wiper operation range is narrowed.	Remove foreign matter from the windshield.
Vehicle Not Switched Off	This message is indicated when the driver's door is opened without switching the ignition OFF.	Switch the ignition OFF before leaving the vehicle.
Gear Selector Lever Not in Park	Displays when the push button start is pressed while the selector lever is in a position other than P, and the ignition is switched to ACC.	Shift the selector lever to the P position and then switch the ignition OFF.
Excessive Transmission Temperature. Drive Slowly	This message is indicated when the internal temperature of the automatic transmission is high.	Drive slowly to reduce load on the automatic transmission.
Excessive Transmission Temp. Stop Vehicle in a Safe Location	This message is indicated when the automatic transmission fluid temperature is abnormally high.	Park the vehicle in a safe place immediately and contact an Authorized Mazda Dealer.

*1 A pop-up is displayed when a warning occurs.

*2 One screen displays four rows. If the entire message cannot be displayed on the screen, it switches to another screen.

Warning/Indicator Lights and Warning Sounds

Warning Sound is Activated

▼ Lights-On Reminder

The lights-on reminder is operable when the time setting*1 of the auto headlight off function is off.

If the ignition is switched OFF with the exterior lights turned on and the driver's door is opened, a sound is activated.

Operate the headlight switch to turn off the exterior lights.

*1 If the light switch is left on, the auto headlight off function automatically turns off the lights about 30 seconds after switching the ignition off. The time setting can be changed.
Refer to the Settings section in the Mazda Connect Owner's Manual.

NOTE

- When the ignition is switched to ACC, the "Ignition Not Switched OFF (STOP) Warning Beep" (page 7-43) overrides the lights-on reminder.
- A personalized function is available to change the sound volume for the lights-on reminder.
Refer to the Settings section in the Mazda Connect Owner's Manual.

▼ Seat Belt Warning Beep

Front seat

Except Mexico

If the driver's seat belt is not fastened when the ignition is switched ON, a beep sound will be heard for about 6 seconds. If the driver or the front passenger's seat belt is not fastened and if the vehicle is driven at about 20 km/h (12 mph) or faster, or about 10 km/h (6 mph) or faster for a continuous 30 seconds, with the seat belt unfastened, a sound is activated continuously for a certain period.

Until a seat belt is fastened or a given period of time has elapsed, the beep sound will not stop even if the vehicle speed falls below 20 km/h (12 mph).

NOTE

- To allow the front passenger occupant classification sensor to function properly, do not place and sit on an additional seat cushion on the front passenger's seat. The sensor may not function properly because the additional seat cushion could cause sensor interference.
- If a small child is seated on the front passenger's seat, the warning beep may not operate.

Warning/Indicator Lights and Warning Sounds

Mexico

If the vehicle speed exceeds about 20 km/h (12 mph) with the driver or front passenger's seat belt unfastened, a warning beep sounds continuously. If the seat belt remains unfastened, the beep sound stops once and then continues for about 90 seconds. The beep stops after the driver or front passenger's seat belt is fastened. Until a seat belt is fastened or a given period of time has elapsed, the beep sound will not stop even if the vehicle speed falls below 20 km/h (12 mph).

NOTE

- Placing heavy items on the front passenger's seat may cause the front passenger's seat belt warning function to operate depending on the weight of the item.
- To allow the front passenger seat weight sensor to function properly, do not place and sit on an additional seat cushion on the front passenger's seat. The sensor may not function properly because the additional seat cushion could cause sensor interference.
- If a small child is seated on the front passenger's seat, the warning beep may not operate.

Rear seat

The warning beep only sounds if a seat belt is unfastened after being fastened.

▼ Ignition Not Switched Off (STOP) Warning Beep

If the driver's door is opened with the ignition switched to ACC, a beep will be heard continuously in the cabin to notify the driver that the ignition has not been switched OFF (STOP). Under this condition, the keyless entry system will not operate, the vehicle cannot be locked, and the battery voltage will be depleted.

▼ Key Removed from Vehicle Warning Beep

Vehicles with advanced keyless function

If the key is taken out of the vehicle while the ignition is switched to ACC or ON, and all the doors are closed, a sound is activated 6 times outside of the vehicle and a sound is activated 1 time in the vehicle.

Vehicles without advanced keyless function

If the key is taken out of the vehicle while the ignition is switched to ACC or ON, and all the doors are closed, a sound is activated 1 time in the vehicle.

NOTE

Make sure that you leave the vehicle while carrying the key, or switch the ignition OFF.

Warning/Indicator Lights and Warning Sounds

▼ Touch Sensor Inoperable Warning Beep (With the advanced keyless function)

A warning beep is activated to notify the driver that the doors are not locked when all of the following conditions are met:

- The ignition is switched OFF.
- All the doors and liftgate are not fully closed.
- The lock is operated 3 times within 5 seconds.

Check the ignition and whether the doors and liftgate are open or closed, and then operate the lock again.

▼ Liftgate Door-lock Switch Inoperable Warning Beep*

When the door-lock switch on the liftgate is pressed under any of the following conditions, a warning sound is activated.

- The ignition is switched to a position other than OFF.
- Any door is open.

Make sure that none of the above conditions are present, and then press the door-lock switch again.

▼ Key Left-in-luggage Compartment/Trunk Warning Beep (With the advanced keyless function)

If the key is left in the luggage compartment/trunk with all the doors locked and the liftgate/trunk lid closed, a beep will be heard outside for about 10 seconds to notify the driver that the key is in the luggage compartment/trunk. In this case, take out the key by pressing the electric liftgate/trunk lid opener and opening the liftgate/trunk lid. The key taken out of the luggage compartment/trunk may not operate because its functions have been temporarily stopped. To restore the key's functions, perform the applicable procedure (page 3-8).

▼ Key Left-in-vehicle Warning Beep (With the advanced keyless function)

If all the doors and luggage compartment/trunk are locked using another key while the key is left in the cabin, the beep which sounds outside of the vehicle will be heard for about 10 seconds to notify the driver that the key is in the cabin. In this case, take out the key by opening the door. A key taken out of the vehicle using this method may not operate because its functions have been temporarily stopped. To restore the key's functions, perform the applicable procedure (page 3-8).

Warning/Indicator Lights and Warning Sounds

▼ Low Fuel Warning Beep

When the low fuel warning light flashes, a warning beep is activated once at the same time.

▼ Brake Override Warning Beep

A warning beep is activated when the accelerator pedal and brake pedal are depressed at the same time while driving. Only depress the brake pedal.

▼ Shift Position Warning Beep

A sound is activated when the push button start is pressed while the selector lever is in a position other than P, and the ignition is switched to ACC. Check the selector lever position.

▼ Electric Parking Brake (EPB) Warning Beep

The warning buzzer is activated under the following conditions:

- The vehicle is driven with the parking brake applied.
- The Electric Parking Brake (EPB) switch is pulled while the vehicle is driven.
- You attempt to start driving the vehicle while the conditions for releasing the Electric Parking Brake (EPB) automatically have not been met.

▼ AUTOHOLD Warning Beep

Warning light flashes/message is displayed and beep sound is activated simultaneously for about 5 seconds when using AUTOHOLD function or when AUTOHOLD switch is operated. Because a problem with AUTOHOLD function has occurred, AUTOHOLD function does not operate even if AUTOHOLD switch is operated.

If the warning light flashes/message is displayed and the beep sound is activated simultaneously, have your vehicle inspected at an Authorized Mazda Dealer.

▼ Vehicle Problem Warning Beep

If any of the following problems occur, a warning beep is activated. Check the information regarding the warning indication in the instrument cluster or on the center display.

- Automatic transmission problem
- Increase in automatic transmission internal temperature
- Brake fluid amount decrease
- Engine oil level sensor problem
- Electric Parking Brake (EPB) problem
- Engine hydraulic pressure decrease
- Engine coolant temperature increase
- Engine system problem

Warning/Indicator Lights and Warning Sounds

▼ Blind Spot Monitoring (BSM) System Warning Beep

The Blind Spot Monitoring (BSM) warning beep operates when the turn signal lever is operated to the side where the Blind Spot Monitoring (BSM) warning light is illuminated.

▼ Front Cross Traffic Alert (FCTA) Warning Beep*

The Front Cross Traffic Alert (FCTA) warning beep is activated if there is a possibility of collision with a vehicle approaching from the front on the left and right sides of the vehicle.

▼ Rear Cross Traffic Alert (RCTA) Warning Beep*

The Rear Cross Traffic Alert (RCTA) warning beep is activated if there is a possibility of collision with a vehicle approaching from the rear on the left and right sides of the vehicle.

▼ Lane Departure Warning Sound*

While the system is operating, if the system determines that the vehicle may depart from the lane, it sounds a warning sound.

NOTE

The volume of the Lane Departure Warning System (LDWS) warning sound can be changed. Refer to the Settings section in the Mazda Connect Owner's Manual.

▼ Mazda Radar Cruise Control (MRCC) System Warnings*

The Mazda Radar Cruise Control (MRCC) system warnings notify the driver of system malfunctions and cautions on use when required. Check based on the beep sound.

Warning beep type	Notification content
The beep sounds 1 time while the Mazda Radar Cruise Control (MRCC) is operating	The vehicle speed is slower than 25 km/h (16 mph) and the Mazda Radar Cruise Control (MRCC) system has been canceled.
The beep sounds intermittently while the Mazda Radar Cruise Control (MRCC) is operating.	The distance between your vehicle and the vehicle ahead is too close. Check the safety of the surrounding area and reduce vehicle speed.

▼ Mazda Radar Cruise Control with Stop & Go function (MRCC with Stop & Go function) System Warnings*

The Mazda Radar Cruise Control with Stop & Go function (MRCC with Stop & Go function) system warnings notify the driver of system malfunctions and cautions on use when required. Check based on the beep sound.

Warning beep type	Notification content
The beep sounds 1 time while the Mazda Radar Cruise Control with Stop & Go function (MRCC with Stop & Go function) is operating	If a malfunction occurs in the system, make sure that the Mazda Radar Cruise Control with Stop & Go function (MRCC with Stop & Go function) has been canceled.

Warning/Indicator Lights and Warning Sounds

Warning beep type	Notification content
The beep sounds intermittently while the Mazda Radar Cruise Control with Stop & Go function (MRCC with Stop & Go function) is operating.	The distance between your vehicle and the vehicle ahead is too close. Check the safety of the surrounding area and reduce vehicle speed.

▼ Excessive Speed Warning*

If the vehicle speed exceeds the speed limit sign displayed in the active driving display/instrument cluster, the area around the speed limit sign flashes in amber and the warning sound is activated at the same time. If the vehicle speed continues to exceed the displayed speed limit sign, the indication stops flashing and remains on.

▼ Collision warning*

If there is a possibility of a collision with a vehicle ahead, a warning sound is activated at the same time as the warning indications are displayed in the instrument cluster or active driving display.

▼ Door-ajar Warning Beep

A warning beep is activated if the vehicle is driven with any door or liftgate ajar. Drive the vehicle after closing the doors and liftgate.

When Liftgate/Trunk Lid Cannot be Opened

When Liftgate/Trunk Lid Cannot be Opened

▼ When Liftgate/Trunk Lid Cannot be Opened

If the battery is dead, the liftgate/trunk lid cannot be unlocked and opened. In this case, the liftgate/trunk lid can be unlocked by taking care of the dead battery situation.

Refer to Jump-Starting on page 7-17. If the liftgate/trunk lid cannot be unlocked even if the dead battery situation has been resolved, the electrical system may have a malfunction.

In this case, the liftgate/trunk lid can be opened using the following procedure as an emergency measure.

(5-door)

1. Wrap the end of a flathead screwdriver in a cloth and remove the cover on the interior surface of the liftgate using it.



2. Turn the lever to the right to unlock the liftgate.

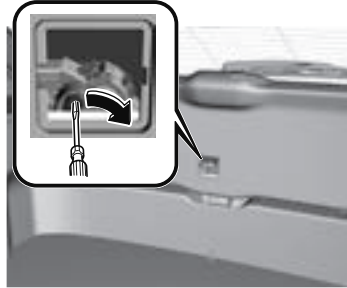

(4-door)

1. Open the cover.



2. (With theft-prevention cover) Open the cap.

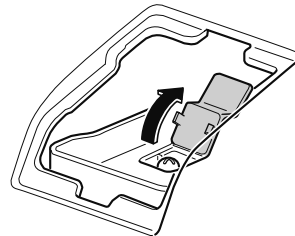

When Liftgate/Trunk Lid Cannot be Opened

3. **(With theft-prevention cover)**
Turn the screw counterclockwise and remove it.

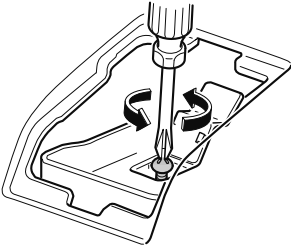

4. **(With theft-prevention cover)**
Remove the theft-prevention cover.

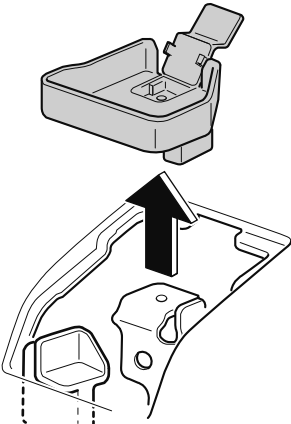

5. Move the lever to the left to fold the seatback.

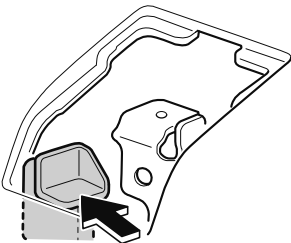

6. Move the lever to the left to open the trunk lid.

(Type A)



(Type B)



After performing this emergency measure, have the vehicle inspected at an Authorized Mazda Dealer as soon as possible.

Active Driving Display Does Not Operate

If the Active Driving Display Does Not Operate*

▼ If the Active Driving Display Does Not Operate

If the active driving display does not operate, switch the ignition off and then restart the engine. If the active driving display does not operate even with the engine restarted, have the vehicle inspected at an Authorized Mazda Dealer.

Windshield Wipers Operate at High Speed

Windshield Wipers Operate at High Speed

▼ Windshield Wipers Operate at High Speed

The windshield wipers may operate at high speed if there is a problem with the wiper control. If the windshield wipers operate at high speed regardless of the wiper switch operation, have your vehicle inspected by an Authorized Mazda Dealer.

MEMO

8

Customer Information and Reporting Safety Defects

Important consumer information including warranties and add-on equipment.

Customer Assistance.....	8-2	Cell Phones.....	8-18
Customer Assistance		Cell Phones Warning.....	8-18
(U.S.A.).....	8-2	Event Data Recorder.....	8-19
Customer Assistance		Event Data Recorder (U.S.A. and	
(Canada).....	8-6	Canada).....	8-19
Customer Assistance (Puerto		Recording of Vehicle Data.....	8-20
Rico).....	8-9	Recording of Vehicle Data....	8-20
Customer Assistance		Uniform Tire Quality Grading System	
(Mexico).....	8-10	(UTQGS).....	8-21
Mazda Importer/Distributors	8-11	Uniform Tire Quality Grading	
.....		System (UTQGS).....	8-21
Importer/Distributor.....	8-11	Tire Information (U.S.A.).....	8-23
Reporting Safety Defects.....	8-12	Tire Labeling.....	8-23
Reporting Safety Defects		Location of the Tire Label	
(U.S.A.).....	8-12	(Placard).....	8-27
Reporting Safety Defects		Tire Maintenance.....	8-29
(Canada).....	8-14	Vehicle Loading.....	8-31
Warranty.....	8-15	Steps for Determining the Correct	
Warranties for Your Mazda		Load Limit.....	8-34
.....	8-15	Declaration of Conformity.....	8-35
Outside the United States/		Declaration of Conformity	
Canada.....	8-15	8-35
Registering Your Vehicle in A			
Foreign Country (Except United			
States and Canada).....	8-16		
Add-On Non-Genuine Parts and			
Accessories.....	8-17		

Customer Assistance

Customer Assistance (U.S.A.)

▼ Customer Assistance

Your complete and permanent satisfaction is our business. We are here to serve you. All Authorized Mazda Dealers have the knowledge and the tools to keep your Mazda vehicle in top condition.

If you have any questions or recommendations for improvement regarding the service of your Mazda vehicle or servicing by Mazda Dealer personnel, we recommend that you take the following steps:

NOTE

If it becomes necessary to have the components or wiring system for the supplementary restraint system modified to accommodate a person with certain medical conditions in accordance with a certified physician, contact an Authorized Mazda Dealer. For more information, go to NHTSA website www.safercar.gov (VEHICLE SHOPPERS > Air Bags > Air Bag FAQs > Air Bag Deactivation).

▼ STEP 1: Contact Your Mazda Dealer

Discuss the matter with an Authorized Mazda Dealer. This is the quickest and best way to address the issue.

- If your concern has not been resolved by the CUSTOMER RELATIONS, SALES, SERVICE, or PARTS MANAGER, then please contact the GENERAL MANAGER of the dealership or the OWNER.

- If it becomes necessary to have the components or wiring system for the supplementary restraint system modified to accommodate a person with certain medical conditions in accordance with a certified physician, go to STEP 2.

▼ STEP 2: Contact Mazda North American Operations

If for any reason you feel the need for further assistance after contacting your dealership management or it becomes necessary to have the components or wiring system for the supplementary restraint system modified to accommodate a person with certain medical conditions in accordance with a certified physician, you can reach Mazda North American Operations by one of the following ways.

Log on: at www.MazdaUSA.com

Answers to many questions, including how to locate or contact a local Mazda dealership in the U.S., can be found here.

E-mail: click on "Contact Us" located on the bottom of the page at www.mazdausa.com under "Help"

By phone at: 1 (800) 222-5500

By letter at:

ATTN: Customer Experience Center
Mazda North American Operations
200 Spectrum Center Drive Suite 100
Irvine, California 92618
P.O. Box 19734
Irvine, CA 92623-9734

In order to serve you efficiently and effectively, please help us by providing the following information:

1. Your name, address, and telephone number
2. Year and model of vehicle
3. Vehicle Identification Number (17 digits, noted on your registration or title or located on the upper driver's side corner of the dash)
4. Purchase date and current mileage
5. Your dealer's name and location
6. Your question(s)

If you live outside the U.S.A., please contact your nearest Mazda Distributor.

▼ **STEP 3: Contact Better Business Bureau (BBB)**

Mazda North American Operations realizes that mutual agreement on some issues may not be possible. As a final step to ensure that your concerns are being fairly considered, Mazda North American Operations has agreed to participate in a dispute settlement program administered by the Better Business Bureau (BBB) system, at no cost to you the consumer.

BBB AUTO LINE works with consumers and the manufacturer in an attempt to reach a mutually acceptable resolution of any warranty related concerns. If the BBB is not able to facilitate a settlement they will provide an informal hearing before an arbitrator.

You are required to resort to BBB AUTO LINE before exercising rights or seeking remedies under the Federal Magnuson-Moss Warranty Act, 15 U.S.C. § 2301 et seq. To the extent permitted by the applicable state "Lemon Law", you are also required to resort to BBB AUTO LINE before exercising any rights or seeking remedies under the "Lemon Law". If you choose to seek remedies that are not created by the Magnuson-Moss Warranty Act or the applicable state "Lemon Law", you are not required to first use BBB AUTO LINE.

The whole process normally takes 40 days or less. The arbitration decision is not binding on you or Mazda unless you accept the decision. For more information about BBB AUTO LINE, including current eligibility standards, please call 1-800-955-5100 or visit the BBB website at www.bbb.org/autoline.

Being truly committed to customer satisfaction is more than a phrase with Mazda. We hope to satisfy every customer directly, but if there is ever a question about our decision, Mazda believes in providing a fast, fair and free method such as the BBB AUTO LINE to ensure Mazda delivers on our commitment to do the right thing for our customers!

Customer Assistance

▼ California Customers

1. Mazda North American Operations participates in BBB AUTO LINE, a mediation/arbitration program administered by the Council of Better Business Bureaus [3033 Wilson Boulevard, Arlington, Virginia 22201] through local Better Business Bureaus. BBB AUTO LINE and Mazda have been certified by the Arbitration Certification Program of the California Department of Consumer Affairs.
2. If you have a problem arising under a Mazda written warranty, we encourage you to bring it to our attention. If we are unable to resolve it, you may file a claim with BBB AUTO LINE. Claims must be filed with BBB AUTO LINE within six (6) months after the expiration of the warranty.
3. To file a claim with BBB AUTO LINE, call 1-800-955-5100. There is no charge for the call.
4. In order to file a claim with BBB AUTO LINE, you will have to provide your name and address, the brand name and vehicle identification number (VIN) of your vehicle, and a statement of the nature of your problem or complaint. You will also be asked to provide: the approximate date of your acquisition of the vehicle, the vehicle's current mileage, the approximate date and mileage at the time any problem(s) were first brought to the attention of Mazda or one of our dealers, and a statement of the relief you are seeking.
5. BBB AUTO LINE staff may try to help resolve your dispute through mediation. If mediation is not successful, or if you do not wish to participate in mediation, claims within the program's jurisdiction may be presented to an arbitrator at an informal hearing. The arbitrator's decision should ordinarily be issued within 40 days from the time your complaint is filed; there may be a delay of 7 days if you did not first contact Mazda about your problem, or a delay of up to 30 days if the arbitrator requests an inspection/report by an impartial technical expert or further investigation and report by BBB AUTO LINE.
6. You are required to use BBB AUTO LINE before asserting in court any rights or remedies conferred by California Civil Code Section 1793.22. You are also required to use BBB AUTO LINE before exercising rights or seeking remedies created by Title I of the Magnuson-Moss Warranty Act, 15 U.S.C. sec. 2301 et seq. If you choose to seek redress by pursuing rights and remedies not created by California Civil Code Section 1793.22 or Title I of the Magnuson-Moss Warranty Act, resort to BBB AUTO LINE is not required by those statutes.

7. California Civil Code Section 1793.2 (d) requires that, if Mazda or its representative is unable to repair a new motor vehicle to conform to the vehicle's applicable express warranty after a reasonable number of attempts, Mazda may be required to replace or repurchase the vehicle. California Civil Code Section 1793.22 (b) creates a presumption that Mazda has had a reasonable number of attempts to conform the vehicle to its applicable express warranties if, within 18 months from delivery to the buyer or 18,000 miles on the vehicle's odometer, whichever occurs first, one or more of the following occurs:
- The same nonconformity [a failure to conform to the written warranty that substantially impairs the use, value or safety of the vehicle] results in a condition that is likely to cause death or serious bodily injury if the vehicle is driven **AND** the nonconformity has been subject to repair two or more times by Mazda or its agents **AND** the buyer or lessee has directly notified Mazda of the need for the repair of the nonconformity; OR
 - The same nonconformity has been subject to repair 4 or more times by Mazda or its agents **AND** the buyer has notified Mazda of the need for the repair of the nonconformity; OR
 - The vehicle is out of service by reason of repair of nonconformities by Mazda or its agents for a cumulative total of more than 30 calendar days after delivery of the vehicle to the buyer.
- NOTICE TO Mazda AS REQUIRED ABOVE SHALL BE SENT TO THE FOLLOWING ADDRESS:**
Mazda North American Operations
200 Spectrum Center Drive Suite 100
Irvine, California 92618
ATTN: Customer Mediation
8. The following remedies may be sought in BBB AUTO LINE: repairs, reimbursement for money paid to repair a vehicle or other expenses incurred as result of a vehicle nonconformity, repurchase or replacement of your vehicle, and compensation for damages and remedies available under Mazda's written warranty or applicable law.
9. The following remedies may **not** be sought in BBB AUTO LINE: punitive or multiple damages, attorneys' fees, or consequential damages other than as provided in California Civil Code Section 1794 (a) and (b).
10. You may reject the decision issued by a BBB AUTO LINE arbitrator. If you reject the decision, you will be free to pursue further legal action. The arbitrator's decision and any findings will be admissible in a court action.

Customer Assistance

11. If you accept the arbitrator's decision, Mazda will be bound by the decision, and will comply with the decision within a reasonable time not to exceed 30 days after we receive notice of your acceptance of the decision.
12. Please call BBB AUTO LINE at 1-800-955-5100 for further details about the program.

Customer Assistance (Canada)

▼ Satisfaction Review Process

Your complete and permanent satisfaction is of primary concern to Mazda. All Authorized Mazda Dealers have both the knowledge and tools to keep your Mazda in top condition. In our experience, any questions, problems, or complaints regarding the operation of your Mazda or any other general service transactions are most effectively resolved by your dealer. If the cause of your dissatisfaction cannot adequately be addressed by normal dealership procedures, we recommend that you take the following steps:

▼ STEP 1: Contact the Mazda Dealer

Discuss the matter with a member of dealership management. If the Service Manager has already reviewed your concerns, contact the owner of the dealership or its General Manager.

▼ STEP 2: Contact the Mazda Regional Office

If you feel that you still require assistance, ask the dealer Service Manager to arrange for you to meet the local Mazda Service Representative. If more expedient, contact Mazda Canada Inc. Regional Office nearest you for such arrangements. Regional Office address and phone numbers are shown (page 8-8).

▼ STEP 3: Contact the Mazda Customer Relations Department

If still not substantially satisfied, contact the Customer Relations Department, Mazda Canada Inc., 55 Vogell Road, Richmond Hill, Ontario, L4B 3K5 Canada TEL: 1 (800) 263-4680.

Provide the Department with the following information:

1. Your name, address and telephone number
2. Year and model of vehicle
3. Vehicle Identification Number (VIN). Refer to the Vehicle Identification Number on page 9-2 for the location of the VIN.
4. Purchase date
5. Present odometer reading
6. Your dealer's name and location
7. The nature of your problem and/or cause of dissatisfaction

The Department, in cooperation with the local Mazda Service Representative, will review the case to determine if everything possible has been done to ensure your satisfaction.

Please recognize that the resolution of service problems in most cases requires the use of your Mazda dealer's service facilities, personnel and equipment. We urge you to follow the above three steps in sequence for most effective results.

▼ Mediation/Arbitration Program

Occasionally a customer concern cannot be resolved through Mazda's Customer Satisfaction Program. If after exhausting the procedures in this manual your concern is still not resolved, you have another option.

Mazda Canada Inc. participates in an arbitration program administered by the Canadian Motor Vehicle Arbitration Plan (CAMVAP). CAMVAP will advise you about how your concern may be reviewed and resolved by an independent third party through binding arbitration.

Your complete satisfaction is the goal of Mazda Canada Inc. and our dealers. Mazda's participation in CAMVAP makes a valuable contribution to our achieving that goal. There is no charge for using CAMVAP. CAMVAP results are fast, fair and final as the award is binding on both you and Mazda Canada Inc.

▼ Canadian Motor Vehicle Arbitration Plan (CAMVAP)

If a specific item of concern arises, where a solution cannot be reached between an owner, Mazda, and/or one of its dealers (that all parties cannot agree upon), the owner may wish to use the services offered by the Canadian Motor Vehicle Arbitration Plan (CAMVAP).

Customer Assistance

CAMVAP uses the services of Provincial Administrators to assist consumers in scheduling and preparing for their arbitration hearings. However, before you can proceed with CAMVAP you must follow your Mazda dispute resolution process as outlined previously.

CAMVAP is fully implemented in all provinces and territories. Consumers wishing to obtain further information about the Program should contact the Provincial Administrator at 1 (800) 207-0685, or by contacting the Canadian Motor Vehicle Arbitration Plan Office at:

Canadian Motor Vehicle Arbitration Plan
 235 Yorkland Boulevard, suite 300
 North York, Ontario
 M2J 4Y8
<http://camvap.ca>
 Provincial Administrators may be reached locally:

Province/Territory	CAMVAP Number
British Columbia & Yukon Territories	1 (800) 207-0685
Alberta & Northwest Territories	1 (800) 207-0685
Saskatchewan	1 (800) 207-0685
Manitoba	1 (800) 207-0685
Ontario	1 (800) 207-0685
Atlantic Canada	1 (800) 207-0685
Quebec	1 (800) 207-0685

▼ Regional Offices

REGIONAL OFFICES	COVERING AREAS
MAZDA CANADA INC. WESTERN REGION 5011 275 STREET LANGLEY, BRITISH COLUMBIA V4W 0A8 (778) 369-2100 1 (800) 663-0908	ALBERTA, BRITISH COLUMBIA, MANITOBA, SASKATCHEWAN, YUKON
MAZDA CANADA INC. CENTRAL REGION 55 VOGELL ROAD, RICHMOND HILL, ONTARIO, L4B 3K5 1 (800) 263-4680	ONTARIO, NEW BRUNSWICK, NOVA SCOTIA, PRINCE EDWARD ISLAND, NEWFOUNDLAND
MAZDA CANADA INC. QUEBEC REGION 6111 ROUTE TRANS-CANADIENNE POINTE CLAIRE, QUEBEC H9R 5A5 (514) 694-6390	QUEBEC

Customer Assistance (Puerto Rico)

▼ Customer Assistance

Your complete and permanent satisfaction is our business. That is why all Authorized Mazda Dealers have the knowledge and the tools to keep your Mazda vehicle in top condition.

If you have any questions or recommendations for improvement regarding the service of your Mazda vehicle or servicing by Mazda Dealer personnel, we recommend that you take the following steps:

▼ STEP 1

Discuss the matter with an Authorized Mazda Dealer. This is the quickest and best way to address the issue. If your concern has not been resolved by the CUSTOMER RELATIONS, SALES, SERVICE, or PARTS MANAGER, then please contact the GENERAL MANAGER of the dealership or the OWNER.

▼ STEP 2

If, after following STEP 1, you feel the need for further assistance, please contact your area's Mazda representative.

Refer to PUERTO RICO/U.S. Virgin Island on page 8-11.

Please help us by providing the following information:

1. Your name, address, and telephone number
2. Year and model of vehicle
3. Vehicle Identification Number (17 digits, noted on your registration or title or located on the upper driver's side corner of the dash)

4. Purchase date and current mileage
5. Your dealer's name and location
6. Your question(s)

Customer Assistance

Customer Assistance (Mexico)

▼ Customer Assistance

Your complete and permanent satisfaction is our business. We are here to serve you. All Authorized Mazda Dealers have the knowledge and the tools to keep your Mazda vehicle in top condition.

If you have any questions or recommendations for improvement regarding the service of your Mazda vehicle or servicing by Mazda Dealer personnel, we recommend that you take the following steps:

▼ Contact Your Mazda Dealer

Discuss the matter with an Authorized Mazda Dealer. This is the quickest and best way to address the issue.

- If your concern has not been resolved by the CUSTOMER RELATIONS, SALES, SERVICE, or PARTS MANAGER, then please contact the GENERAL MANAGER of the dealership or the OWNER.
- If it becomes necessary to have the components or wiring system for the supplementary restraint system modified to accommodate a person with certain medical condition in accordance with a certified physician you must contact your dealership in order to avoid the potential loss of the warranty of your vehicle which may occur if some third party is hired by the customer to make any modifications to this system.

Log on: at
www.mazdamexico.com.mx

Answers to many questions, including how to locate or contact a local Mazda dealership in Mexico, can be found here.

E-mail: click on "Contactanos" at the top of the page at
www.mazdamexico.com.mx

By phone at: 01 800 01 MAZDA
(62932)

By letter at:
Attn: Customer Assistance
Mazda Motor de Mexico
Mario Pani 400 PB, Col. Santa Fe
Cuajimalpa, Delegación Cuajimalpa
de Morelos, Ciudad de México, CP
05348

Tel: Customer Assistance
01 800 01 MAZDA(62932).

In order to serve you efficiently and effectively, please help us by providing the following information:

1. Your name, address, and telephone number
2. Year and model of vehicle
3. Vehicle Identification Number (17 digits, noted on your registration or title or located on the upper driver's side corner of the dash)
4. Purchase date and current mileage
5. Your dealer's name and location
6. Your question(s)

Importer/Distributor

▼ U.S.A.

Mazda North American Operations
200 Spectrum Center Drive Suite 100
Irvine, California 92618
P.O. Box 19734
Irvine, CA 92623-9734 U.S.A.
TEL: 1 (800) 222-5500 (in U.S.A.)
(949) 727-1990 (outside U.S.A.)

▼ CANADA

Mazda Canada Inc.
55 Vogell Road, Richmond Hill,
Ontario, L4B 3K5 Canada
TEL: 1 (800) 263-4680 (in Canada)
(905) 787-7000 (outside Canada)

▼ PUERTO RICO/U.S. Virgin Island

**International Automotive Distributor
Group, LLC. (Mazda de Puerto Rico)**
P.O. Box 191850, San Juan, Puerto
Rico 00919-1850
TEL: (787) 641-1777

▼ MEXICO

Mazda Motor de Mexico
Mario Pani 400 PB, Col. Santa Fe
Cuajimalpa, Delegación Cuajimalpa
de Morelos, Ciudad de México, CP
05348
TEL: Center of Attention to Clients:
01 (800) 016 2932. in Mexico

▼ GUAM

Triple J Motors
157 South Marine Drive, Tamuning,
GUAM 96911 USA
P.O. Box 6066 Tamuning, Guam
96931
TEL: (671) 649-6555

▼ SAIPAN

**Pacific International Marianas, Inc.
(d.b.a. Midway Motors)**
P.O. Box 887 Saipan, MP 96950
TEL: (670) 234-7524

**Triple J Saipan, Inc.
(d.b.a. Triple J Motors)**
P.O. Box 500487 Saipan, MP
96950-0487
TEL: (670) 234-7133/3051

▼ AMERICAN SAMOA

Polynesia Motors, Inc.
P.O. Box 1120, Pago Pago, American
Samoa 96799
TEL: (684) 699-9347

Reporting Safety Defects

Reporting Safety Defects (U.S.A.)

▼ Reporting Safety Defects

If you believe that your vehicle has a defect which could cause a crash or could cause injury or death, you should immediately inform the National Highway Traffic Safety Administration (NHTSA) in addition to notifying Mazda Motor Corporation (Your Mazda Importer/Distributor).

If NHTSA receives similar complaints, it may open an investigation, and if it finds that a safety defect exists in a group of vehicles, it may order a recall and remedy campaign. However, NHTSA cannot become involved in individual problems between you, your dealer, or Mazda Motor Corporation (Your Mazda Importer/Distributor).

To contact NHTSA, you may call the Vehicle Safety Hotline toll-free at 1-888-327-4236 (TTY:1-800-424-9153); go to <http://www.safercar.gov>; or write to: Administrator, NHTSA, 1200 New Jersey Avenue, SE., Washington, DC, 20590. You can also obtain other information about motor vehicle safety from <http://www.safercar.gov>.

Reporting Safety Defects

NOTE

If you live in the U.S.A., all correspondence to Mazda Motor Corporation should be forwarded to:

Mazda North American Operations
200 Spectrum Center Drive Suite 100
Irvine, California 92618

or

P.O. Box 19734

Irvine, CA 92623-9734

Customer Experience Center or toll free at 1 (800) 222-5500

If you live outside of the U.S.A., please contact the nearest Mazda Distributor shown in this manual.

- Refer to CANADA on page 8-11.
- Refer to PUERTO RICO/U.S. Virgin Island on page 8-11.
- Refer to MEXICO on page 8-11.
- Refer to GUAM on page 8-11.
- Refer to SAIPAN on page 8-11.
- Refer to AMERICAN SAMOA on page 8-11.

Reporting Safety Defects

Reporting Safety Defects (Canada)

▼ Reporting Safety Defects

Canadian customers who wish to report a safety-related defect and concern to Transport Canada, Defect Investigations and Recalls, may telephone the toll free hotline 1-800-333-0510, or go to the Road Safety website at:
<https://www.tc.gc.ca/en/services/road.html>

Warranties for Your Mazda

▼ Warranties for Your Mazda

- New Vehicle Limited Warranty
- Powertrain Limited Warranty
- Safety Restraint System Limited Warranty
- Anti-perforation Limited Warranty
- Federal Emission Control Warranty/
California Emission Control Warranty
 - Emission Defect Warranty
 - Emission Performance Warranty
- Emission Control Warranty
- Replacement Parts and Accessories Limited Warranty
- Tire Warranty

NOTE

Warranty information varies depending on the country. Refer to the Warranty Booklet for detailed warranty information.

Outside the United States/Canada

▼ Outside the United States/Canada

Government regulations in the United States/Canada require that automobiles meet specific emission regulations and safety standards. Therefore, vehicles built for use in the United States/Canada may differ from those sold in other countries.

The differences may make it difficult or even impossible for your vehicle to receive satisfactory servicing in other countries. We strongly recommend that you NOT take your Mazda outside the United States/Canada.

United States

However, in the event that you are moving to Canada permanently, Mazda vehicles built for use in the United States could be eligible for exportation to Canada with specific vehicle modifications to comply with the Canadian Motor Vehicle Safety Standards (CMVSS).

Canada

However, in the event that you are moving to the United States permanently, Mazda vehicles built for use in Canada could be eligible for exportation to the United States with specific vehicle modifications to comply with the United States Federal Motor Vehicle Safety Standards (FMVSS).

Warranty

NOTE

The above is applicable for a permanent import/export situation and not related to travelers on vacation.

You may have the following problems if you do take your vehicle outside of the United States/Canada:

- Recommended fuel may be unavailable. Any kind of leaded fuel or low-octane fuel will affect vehicle performance and damage the emission controls and engine.
- Proper repair facilities, tools, testing equipment, and replacement parts may not be available.

Please refer to your Manufacturer's Warranty Booklet for more information.

Registering Your Vehicle in A Foreign Country (Except United States and Canada)

▼ Registering Your Vehicle in A Foreign Country

Registering your vehicle in a foreign country may be problematic depending on whether it meets the specific emission and safety standards of the country in which the vehicle will be driven. Consequently, your vehicle may require modifications at personal expense in order to meet the regulations.

In addition, you should be aware of the following issues:

Satisfactory vehicle servicing may be difficult or impossible in another country.

The fuel specified for your vehicle may be unavailable.

Parts, servicing techniques, and tools necessary to maintain and repair your vehicle may be unavailable.

There might not be an Authorized Mazda Dealer in the country you plan to take your vehicle.

The Mazda warranty is valid only in certain countries.

Add-On Non-Genuine Parts and Accessories

▼ Add-On Non-Genuine Parts and Accessories

Non-genuine parts and accessories for Mazda vehicles can be found in stores. These may fit your vehicle, but they are not approved by Mazda for use with Mazda vehicles. When you install non-genuine parts or accessories, they could affect your vehicle's performance or safety systems; the Mazda warranty doesn't cover this. Before you install any non-genuine parts or accessories, consult an Authorized Mazda Dealer.

WARNING

Always consult an Authorized Mazda Dealer before you install non-genuine parts or accessories:

Improperly designed parts or accessories could seriously affect your vehicle's performance or safety systems. This could cause you to have an accident or increase your chances of injuries in an accident.

Be very careful in choosing and installing add-on electrical equipment, such as mobile telephones, two-way radios, stereo systems, and car alarm systems:

Incorrectly choosing or installing improper add-on equipment or choosing an improper installer is dangerous. Essential systems could be damaged, causing engine stalling, air-bag (SRS) activation, ABS/TCS/DSC inactivation, or a fire in the vehicle.

Mazda assumes no responsibility for death, injury, or expenses that may result from the installation of add-on non-genuine parts or accessories.

Cell Phones

Cell Phones Warning

▼ Cell Phones Warning



Please comply with the legal regulations concerning the use of communication equipment in vehicles in your country:

Use of any electrical devices such as cell phones, computers, portable radios, vehicle navigation or other devices by the driver while the vehicle is moving is dangerous. Dialing a number on a cell phone while driving also ties-up the driver's hands. Use of these devices will cause the driver to be distracted and could lead to a serious accident. If a passenger is unable to use the device, pull off the right-of-way to a safe area before use. If use of a cell phone is necessary despite this warning, use a hands-free system to at least leave the hands free to drive the vehicle. Never use a cell phone or other electrical devices while the vehicle is moving and, instead, concentrate on the full-time job of driving.

Event Data Recorder (U.S.A. and Canada)

▼ Event Data Recorder

This vehicle is equipped with an event data recorder (EDR). The main purpose of an EDR is to record, in certain crash or near crash-like situations, such as an air bag deployment or hitting a road obstacle, data that will assist in understanding how a vehicle's systems performed. The EDR is designed to record data related to vehicle dynamics and safety systems for a short period of time, typically 30 seconds or less. The EDR in this vehicle is designed to record such data as:

- How various systems in your vehicle were operating;
- Whether or not the driver and passenger safety belts were buckled/ fastened;
- How far (if at all) the driver was depressing the accelerator and/or brake pedal; and,
- How fast the vehicle was traveling.

These data can help provide a better understanding of the circumstances in which crashes and injuries occur.

NOTE:

EDR data are recorded by your vehicle only if a non-trivial crash or near crash-like situation occurs; no data are recorded by the EDR under normal driving conditions and no personal data (e.g., name, gender, age, and crash location) are recorded. However, other parties, such as law enforcement, could combine the EDR data with the type of personally identifying data routinely acquired during a crash investigation.

To read data recorded by an EDR, special equipment is required, and access to the vehicle or the EDR is needed. In addition to the vehicle manufacturer, other parties, such as law enforcement, that have the special equipment, can read the information if they have access to the vehicle or the EDR.

Mazda will not disclose any of the data recorded in an EDR to a third party unless:

- A written agreement from the vehicle owner or the lessee is obtained
- Officially requested by the police or other law enforcement authorities
- Used as a defense for Mazda in a lawsuit, claim, or arbitration
- Ordered by a judge or court

However, if necessary Mazda will:

- Use the data for research on Mazda vehicle performance, including safety.
- Disclose the data or the summarized data to a third party for research purposes without disclosing vehicle or owner identification information.

Recording of Vehicle Data

Recording of Vehicle Data

▼ Recording of Vehicle Data

This vehicle is equipped with a computer which records the following main vehicle data related to vehicle controls, operation, and other driving conditions.

Recorded data

- Vehicle conditions such as engine speed and vehicle speed
- Driving operation conditions such as accelerator and brake pedals, and information related to the environmental circumstances while the vehicle is driven
- Malfunction diagnosis information from each on-vehicle computer
- Information related to controls of other on-vehicle computers

NOTE

The recorded data may vary depending on the vehicle grade and optional equipment. Voice and images are not recorded.

Data handling

Mazda and its subcontracting parties may obtain and use the recorded data for vehicle malfunction diagnosis, research and development, and quality improvement.

Mazda will not disclose or provide any of the obtained data to a third party unless:

- An agreement from the vehicle owner (agreements from lessor and lessee for leased vehicle) is obtained

- Officially requested by the police or other law enforcement authorities
- For statistical processing by a research institution after processing the data so that identification of the owner or the vehicle is impossible

Uniform Tire Quality Grading System (UTQGS)

Uniform Tire Quality Grading System (UTQGS)

▼ Uniform Tire Quality Grading System (UTQGS)

This information relates to the tire grading system developed by the U.S. National Highway Traffic Safety Administration for grading tires by tread wear, traction, and temperature performance.

▼ Tread Wear

The tread wear grade is a comparative rating based on the wear rate of the tire when tested under controlled conditions on a specified government test course.

For example, a tire graded 150 would wear one-and-a-half times as well on the government course as a tire graded 100.

The relative performance of tires depends upon the actual conditions of their use, however, and may depart significantly from the norm because of variations in driving habits, service practices and differences in road characteristics and climate.

▼ Traction-AA, A, B, C

The traction grades, from highest to lowest, are AA, A, B, and C. These grades represent the tire's ability to stop on wet pavement as measured under controlled conditions on specified government test surfaces of asphalt and concrete. A tire marked C may have poor traction performance.

WARNING

The traction grade assigned to this tire is based on braking (straight ahead) traction tests and does not include acceleration cornering (turning), hydroplaning, or peak traction characteristics.

▼ Temperature-A, B, C

The temperature grades A (the highest), B, and C, represent the tire's resistance to the generation of heat and its ability to dissipate heat when tested under controlled conditions on a specified indoor laboratory test wheel.

Sustained high temperature can cause the material of the tire to degenerate and reduce tire life, and excessive temperatures can lead to sudden tire failure.

Grade C corresponds to a level of performance which all passenger vehicle tires must meet under the Federal Motor Vehicle Safety Standard No. 109. Grades B and A represent higher levels of performance on the laboratory test wheel than the minimum required by law.

Uniform Tire Quality Grading System (UTQGS)

WARNING

Keep your vehicle's tires properly inflated and not overloaded:

Driving with improperly inflated or overloaded tires is dangerous. Excessive speed, underinflation, or excessive loading, either separately or in combination, can cause heat buildup and possible tire failure. The temperature grade for this tire is established for a tire that is properly inflated and not overloaded.

These grades will be added to the sidewalls of passenger vehicle tires over the next several years according to a schedule established by the NHTSA and the tire manufacturers.

The grade of tires available as standard or optional equipment on Mazda vehicles may vary with respect to grade.

ALL PASSENGER VEHICLE TIRES MUST CONFORM TO THESE GRADES AND TO ALL OTHER FEDERAL TIRE-SAFETY REQUIREMENTS.

▼ UNIFORM TIRE QUALITY GRADING

Quality grades can be found where applicable on the tire sidewall between tread shoulder and maximum section width.

For example:

**TREADWEAR 200 TRACTION AA
TEMPERATURE A
UTQGS MARK (example)**

TREADWEAR 200 TRACTION AA
TEMPERATURE A



Tire Labeling

▼ Tire Labeling

Federal law requires tire manufacturers to place standardized information on the sidewall of all tires. This information identifies and describes the fundamental characteristics of the tire and also provides a tire identification number for safety standard certification and in case of a recall.

▼ Information on Passenger Vehicle Tires

Please refer to the sample below.

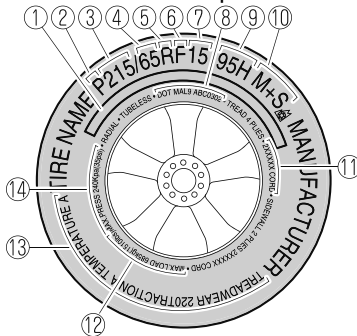

1. SAFETY WARNING
2. Passenger car tire
3. Nominal width of tire in millimeters
4. Ratio of height to width (aspect ratio)
5. Radial
6. Run-flat tire
7. Rim diameter code
8. TIN: U.S. DOT tire identification number
9. Load index & speed symbol
10. Severe snow conditions
11. Tire ply composition and materials used
12. Max. load rating
13. Tread wear, traction and temperature grades

14. Max. permissible inflation pressure

P215/65R15 95H is an example of a tire size and load index rating. Here is an explanation of the various components of that tire size and load index rating. Note that the tire size and load index rating may be different from the example.

P

Indicates a tire that may be installed on cars, SUVs, minivans and light trucks as designated by the Tire and Rim Association (T&RA).

NOTE

If your tire size does not begin with a letter this may mean it is designated by either ETRTO (European Tire and Rim Technical Organization) or JATMA (Japan Tire Manufacturing Association).

215

"215" is the nominal width of the tire in millimeters. This three-digit number gives the width in millimeters of the tire from sidewall edge to sidewall edge. In general, the larger the number, the wider the tire.

65

"65" is the aspect ratio. This two-digit number indicates the tire's ratio of height to width.

R

"R" is the tire construction symbol. R indicates "Radial ply construction".

15

"15" is the wheel rim diameter in inches.

Tire Information (U.S.A.)

95

“95” is the Load Index. This two-or three-digit number indicates how much weight each tire can support.

H

“H” is the speed rating. The speed rating denotes the maximum speed for which the use of the tire is rated.

Letter Rating	Speed Rating
Q	99 mph
R	106 mph
S	112 mph
T	118 mph
U	124 mph
H	130 mph
V	149 mph
W	168* mph
Y	186* mph

* For tires with a maximum speed capability over 149 mph, tire manufacturers sometimes use the letters ZR. For tires with a maximum speed capability over 186 mph, tire manufacturers always use the letters ZR.

M+S or M/S: Mud and Snow

AT: All Terrain.

AS: All Season. The “M+S” or “M/S” indicates that the tire has some functional use in mud and snow.

U.S. DOT Tire Identification Number (TIN)

This begins with the letters “DOT” which indicates the tire meets all federal standards. The next two numbers or letters are the plant code where it was manufactured, and the last four numbers represent the week and year the tire was manufactured. For example, the numbers 457 means the 45st week of 1997. After 2000 the numbers go to four digits. For example, the number 2102 means the 21th week of 2002. The other numbers are marketing codes used at the manufacturer's discretion. This information is used to contact consumers if a tire defect requires a recall.

Tire Ply Composition and Materials Used

The number of plies indicates the number of layers of rubber-coated fabric in the tire. In general, the greater the number of plies, the more weight a tire can support. Tire manufacturers also must indicate the tire materials, which include steel, nylon, polyester, and other.

Maximum Load Rating

This number indicates the maximum load in kilograms and pounds that can be carried by the tire.

Maximum Permissible Inflation Pressure

This number is the greatest amount of air pressure that should ever be put in the tire under normal driving conditions.

Tread Wear, Traction and Temperature Grades

Tread wear: The tread wear grade is a comparative rating based on the wear rate of the tire when tested under controlled conditions on a specified government test course. For example, a tire graded 150 would wear one and one-half (1 1/2) times as well on the government course as a tire graded 100.

Traction: The traction grades, from highest to lowest are AA, A, B, and C. The grades represent the tire's ability to stop on wet pavement as measured under controlled conditions on specified government test surfaces of asphalt and concrete. A tire marked C may have poor traction performance.

Temperature: The temperature grades are A (the highest), B and C, representing the tire's resistance to the generation of heat and its ability to dissipate heat when tested under controlled conditions on a specified indoor laboratory test wheel.

Snow Tires

In some heavy snow areas, local governments may require true snow tires, those with very deeply cut tread. These tires should only be used in pairs or placed on all four wheels. Make sure you purchase snow tires that are the same size and construction type as the other tires on your vehicle.

SAFETY WARNING

The following safety warning appears on the tire's sidewall.
SERIOUS INJURY MAY RESULT FROM:

- EXPLOSION OF TIRE/RIM ASSEMBLY DUE TO IMPROPER MOUNTING-MATCH TIRE DIAMETER TO RIM DIAMETER; NEVER EXCEED 40 psi (275 kPa) TO SEAT BEADS-ONLY SPECIALLY TRAINED PERSONS SHOULD MOUNT TIRES.
- TIRE FAILURE DUE TO UNDER-INFLATION/ OVERLOADING/DAMAGE-FOLLOW OWNER'S MANUAL AND PLACARD IN VEHICLE-FREQUENTLY CHECK INFLATION PRESSURE AND INSPECT FOR DAMAGE.

▼ Information on Temporary Tires

Please refer to the sample below.

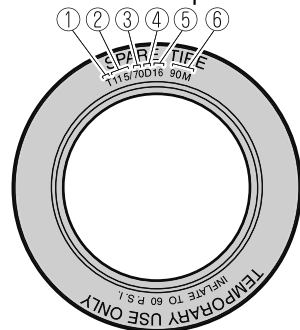

1. Temporary tires
2. Nominal width of tire in millimeters
3. Ratio of height to width (aspect ratio)
4. Diagonal
5. Rim diameter code
6. Load index & speed symbol

Tire Information (U.S.A.)

T115/70D16 90M is an example of a tire size and load index rating. Here is an explanation of the various components of that tire size and load index rating. Note that the tire size and load index rating may be different from the example.

T

Indicates a tire that may be installed on cars, SUVs, minivans and light trucks as designated by the Tire and Rim Association (T&RA).

115

"115" is the nominal width of the tire in millimeters. This three-digit number gives the width in millimeters of the tire from sidewall edge to sidewall edge. In general, the larger the number, the wider the tire.

70

"70" is the aspect ratio. This two-digit number indicates the tire's ratio of height to width.

D

"D" is the tire construction symbol. D indicates "diagonal ply construction".

16

"16" is the wheel rim diameter in inches.

90

"90" is the Load Index. This two-or three-digit number indicates how much weight each tire can support.

M

"M" is the speed rating. The speed rating denotes the maximum speed for which the use of the tire is rated.

Letter Rating	Speed Rating
M	81 mph

Location of the Tire Label (Placard)

▼ Location of the Tire Label (Placard)

You will find the tire label containing tire inflation pressure by tire size and other important information on the driver's side B-pillar or on the edge of the driver's door frame.

SAMPLE

TIRE AND LOADING INFORMATION RENSEIGNEMENTS SUR LES PNEUS ET LE CHARGEMENT			
SEATING CAPACITY NOMBRE DE PLACES		TOTAL 5	FRONT 2 REAR 3
The combined weight of occupants and cargo should never exceed 1400 kg or 3000 lbs. Le poids total des occupants et du chargement ne doit jamais dépasser			
TIRE PNEU	SIZE DIMENSIONS	COLD TIRE PRESSURE PRESSION DES PNEUS À FROID	SEE OWNER'S MANUAL FOR ADDITIONAL INFORMATION
FRONT AVANT	195/70R14	200 kPa, 29 psi	VOIR LE MANUEL DE L'USAGER POUR PLUS DE RENSEIGNEMENTS
REAR ARRIERE	195/70R14	200 kPa, 29 psi	
SPARE DE SECOURS	T125/70D15	420 kPa, 60 psi	

▼ Recommended Tire Inflation Pressure

On the tire label you will find the recommended tire inflation pressure in both kPa and psi for the tires installed as original equipment on the vehicle. It is very important that the inflation pressure of the tires on your vehicle is maintained at the recommended pressure. You should check the tire pressure regularly to insure that the proper inflation pressure is maintained. Refer to Tires on page 9-10.

NOTE

Tire pressures listed on the vehicle placard or tire information label indicate the recommended cold tire inflation pressure, measured when the tires are cold, after the vehicle has been parked for at least 3 hours. As you drive, the temperature in the tire warms up, increasing the tire pressure.

⚠ WARNING

Always check the tire inflation pressures on a regular basis according to the recommended tire inflation pressure on the tire label and in conjunction with the information in this owner's manual:

Driving your vehicle with under-inflated tires is dangerous. Under-inflation is the most common cause of failures in any kind of tire and may result in severe cracking, tread separation or "blowout", with unexpected loss of vehicle control and increased risk of injury. Under-inflation increases sidewall flexing and rolling resistance, resulting in heat buildup and internal damage to the tire. It results in unnecessary tire stress, irregular wear, loss of control and accidents. A tire can lose up to half of its air pressure and not appear to be flat!

It is impossible to determine whether or not tires are properly inflated just by looking at them.

▼ Checking Tire Pressure

1. When you check the air pressure, make sure the tires are cold —meaning they are not hot from driving even a mile.
2. Remove the cap from the valve on one tire.
3. Firmly press a tire gauge onto the valve.
4. Add air to achieve recommended air pressure.
5. If you overfill the tire, release air by pushing on the metal stem in the center of the valve. Then recheck the pressure with your tire gauge.
6. Replace the valve cap.

Tire Information (U.S.A.)

7. Repeat with each tire, including the spare.

NOTE

Some spare tires require higher inflation pressure.

8. Visually inspect the tires to make sure there are no nails or other objects embedded that could poke a hole in the tire and cause an air leak.
9. Check the sidewalls to make sure there are no gouges, cuts, bulges, cracks or other irregularities.

▼ Glossary of Terms

Tire Placard: A label indicating the OE tire sizes, recommended inflation pressure, and the maximum weight the vehicle can carry.

Tire Identification Number (TIN): A number on the sidewall of each tire providing information about the tire brand and manufacturing plant, tire size, and date of manufacture.

Inflation Pressure: A measure of the amount of air in a tire.

kPa: Kilopascal, the metric unit for air pressure.

psi: Pounds per square inch, the English unit for air pressure.

B-pillar: The structural member at the side of the vehicle behind the front door.

Original Equipment (OE): Describes components originally equipped on the vehicle.

Vehicle Load Limit: The maximum value of the combination weight of occupants and cargo.

Bead Area of the Tire: Area of the tire next to the rim.

Sidewall Area of the Tire: Area between the bead area and the tread.

Tread Area of the Tire: Area on the perimeter of the tire that contacts the

road when it's mounted on the vehicle.

Seating capacity means the total allowable number of vehicle occupants. Seating capacity is described on the tire label.

Production options weight is the combination weight of installed regular production options weighing over 2.3 kilograms in excess of the standard items which they replace, and not previously considered in the curb weight or accessory weight, including heavy duty brakes, ride levelers, roof rack, heavy duty battery, and special trim.

Rim is the metal support (wheel) for a tire or a tire and tube assembly upon which the tire beads are seated.

Tire Maintenance

▼ Tire Maintenance

Improper or inadequate vehicle maintenance can cause tires to wear abnormally. Here are some important maintenance points:

▼ Tire Inflation Pressure

Inspect all tire pressure monthly (including the spare) when the tires are cold. Maintain recommended pressures for the best ride, top handling, and minimum tire wear. Use the pressures specified on the vehicle tire information placard or tire label for optimum service.

▼ Tire Rotation

To equalize tread wear, rotate the tires every 16,000 km (10,000 miles) at the latest or sooner if irregular wear develops. Mazda recommends to rotate every 8,000 km (5,000 miles) to help increase tire life and distribute wear more evenly.

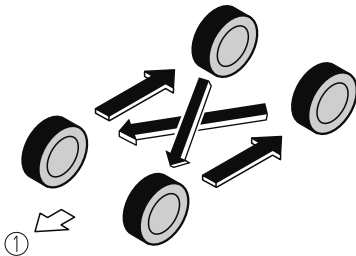

1. Forward

Do not include (TEMPORARY USE ONLY) spare tire in rotation.

Inspect the tires for uneven wear and damage. Abnormal wear is usually caused by one or a combination of the following:

- Incorrect tire pressure

- Improper wheel alignment
- Out-of-balance wheel
- Severe braking

After rotation, inflate all tire pressures to specification on page 9-10 and inspect the lug nuts for tightness.

⚠ CAUTION

Rotate unidirectional tires and radial tires that have an asymmetrical tread pattern or studs only from front to rear, not from side to side. Tire performance will be weakened if rotated from side to side.

▼ Replacing a Tire

⚠ WARNING

Always use tires that are in good condition:

Driving with worn tires is dangerous. Reduced braking, steering, and traction could result in an accident.

If a tire wears evenly, a wear indicator will appear as a solid band across the tread.

Replace the tire when this happens.

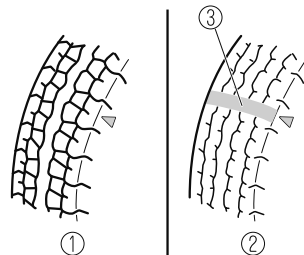

1. New tread
2. Worn tread
3. Tread wear indicator

You should replace the tire before the band crosses the entire tread.

Tire Information (U.S.A.)

NOTE

Tires degrade over time, even when they are not being used on the road. It is recommended that tires generally be replaced when they are 6 years or older. Heat caused by hot climates or frequent high loading conditions can accelerate the aging process. You should replace the spare tire when you replace the other road tires due to the aging of the spare tire. The period in which the tire was manufactured (both week and year) is indicated by a 4-digit number.

Refer to Tire Labeling on page 8-23.

▼ Safety Practices

The way you drive has a great deal to do with your tire mileage and safety. So cultivate good driving habits for your own benefit.

- Observe posted speed limits and drive at speeds that are safe for the existing weather conditions
- Avoid fast starts, stops and turns
- Avoid potholes and objects on the road
- Do not run over curbs or hit the tire against the curb when parking

CAUTION

If you feel a sudden vibration or ride disturbance while driving or you suspect your tire or vehicle has been damaged, immediately reduce your speed. Drive with caution until you can safely pull off the road. Stop and inspect the tire for damage. If the tire is under-inflated or damaged, deflate it, remove the tire and rim and replace it with your spare tire. If you cannot detect a cause, have the vehicle towed to the nearest vehicle or tire dealer to have the vehicle inspected.

Vehicle Loading

▼ Vehicle Loading



Do not tow a trailer with this vehicle:

Towing a trailer with this vehicle is dangerous because it has not been designed to tow a trailer and doing so will affect the drive system which could result in vehicle damage.

This section will guide you in the proper loading of your vehicle, to keep your loaded vehicle weight within its design rating capability. Properly loading your vehicle will provide maximum return of vehicle design performance. Before loading your vehicle, familiarize yourself with the following terms for determining your vehicle's weight ratings, from the vehicle's Safety Certification Label and Tire and Load Information Label:



Overloaded Vehicle:

Overloading a vehicle is dangerous. The results of overloading can have serious consequences in terms of passenger safety. Too much weight on a vehicle's suspension system can cause spring or shock absorber failure, brake failure, handling or steering problems, irregular tire wear, tire failure or other damage.

Overloading makes a vehicle harder to drive and control. It also increases the distance required for stopping. In cases of serious overloading, brakes can fail completely, particularly on steep grades. The load a tire will carry safely is a combination of the size of the tire, its load range, and corresponding inflation pressure.

Never overload the vehicle and always observe the vehicle's weight ratings from the vehicle's Safety Certification and Tire and Load Information labels.

Base Curb Weight is the weight of the vehicle including a full tank of fuel and all standard equipment. It does not include passengers, cargo, or optional equipment.

Vehicle Curb Weight is the weight of your new vehicle when you picked it up from your dealer plus any aftermarket equipment.

PAYLOAD

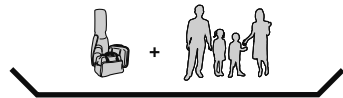

Payload is the combination weight of cargo and passengers that the vehicle is designed to carry. The maximum payload for your vehicle can be found on the Tire and Load Information label on the driver's door frame or door pillar. Look for "THE COMBINATION WEIGHT OF OCCUPANTS AND CARGO SHOULD NEVER EXCEED XXX kg or XXX lbs" for your maximum payload. The payload listed on the tire label is the maximum payload for the vehicle as built by the assembly plant. If any aftermarket or dealer installed equipment has been installed on the vehicle, the weight of the equipment must be subtracted from the payload listed on the tire label in order to be accurate.

SAMPLE

TIRE AND LOADING INFORMATION RENSEIGNEMENTS SUR LES PNEUS ET LE CHARGEMENT				
SEATING CAPACITY NOMBRE DE PLACES		TOTAL 5	FRONT 2 AVANT 2	REAR 3 ARRIERE 3
The combined weight of occupants and cargo should never exceed XXX kg or XXX lbs. Le poids total des occupants et du chargement ne doit jamais dépasser xxx kg ou xxx lb.*				
TIRE PNEU	SIZE DIMENSIONS	COLD TIRE PRESSURE PRESSION DES PNEUS A FROID	SEE OWNERS MANUAL FOR ADDITIONAL INFORMATION VOIR LE MANUEL DE L'USAGER POUR PLUS DE RENSEIGNEMENTS	
FRONT AVANT	195/70R14	200 kPa, 29 psi		
REAR ARRIERE	195/70R14	200 kPa, 29 psi		
SPARE DE SECOURS	T125/70D15	420 kPa, 60 psi		

CARGO

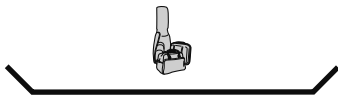

Cargo Weight includes all weight added to the Base Curb Weight, including cargo and optional equipment.

The cargo weight limit decreases depending on the number of vehicle occupants. The cargo weight limit can be calculated by subtracting the total weight of the vehicle occupants from the "combination weight of occupants and cargo should never exceed" value on the tire label.

Examples: Based on a single occupant weight of 68 kg (150 lbs), and a value of 385 kg (849 lbs) for the "combination weight of occupants and cargo should never exceed":

The cargo weight limit with one occupant is 385 kg (849 lbs) – 68 kg (150 lbs) = 317 kg (699 lbs)

The cargo weight limit with two occupants is 385 kg (849 lbs) – (68 × 2) kg ((150 × 2) lbs) = 249 kg (549 lbs)

If the weight of the occupant increases, the cargo weight limit decreases by that much.

GAW (Gross Axle Weight) is the total weight placed on each axle (front and rear) - including vehicle curb weight and all payload.

GAWR (Gross Axle Weight Rating) is the maximum allowable weight that can be carried by a single axle (front or rear). **These numbers are shown on the Safety Compliance Certification Label located on the driver's door frame or door pillar. The total load on each axle must never exceed its GAWR.**

GVW



GVW (Gross Vehicle Weight) is the Vehicle Curb Weight + cargo + passengers.

GVWR (Gross Vehicle Weight Rating) is the maximum allowable weight of the fully loaded vehicle (including all options, equipment, passengers and cargo). **The GVWR is shown on the Safety Compliance Certification Label located on the driver's door frame or door pillar. The GVW must never exceed the GVWR.**

SAMPLE

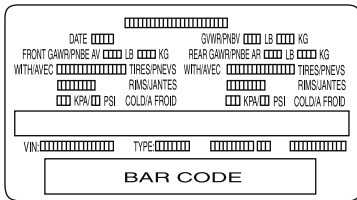

⚠ WARNING

Never Exceed Axle Weight Rating Limits:

Exceeding the Safety Certification Label axle weight rating limits is dangerous and could result in death or serious injury as a result of substandard vehicle handling, performance, engine, transmission and/or structural damage, serious damage to the vehicle, or loss of control. Always keep the vehicle within the axle weight rating limits.

GCW

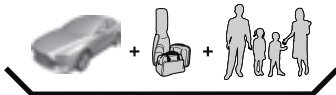

GCW (Gross Combination Weight) is the weight of the loaded vehicle (GVW).

GCWR (Gross Combination Weight Rating) is the maximum allowable weight of the vehicle - including all cargo and passengers - that the vehicle can handle without risking damage. **The GCW must never exceed the GCWR.**

⚠ WARNING

Never Exceed GVWR or GAWR Specifications:

Exceeding the GVWR or the GAWR specified on the certification label is dangerous. Exceeding any vehicle rating limitation could result in a serious accident, injury, or damage to the vehicle.

Do not use replacement tires with lower load carrying capacities than the originals because they may lower the vehicle's GVWR and GAWR limitations. Replacement tires with a higher limit than the originals do not increase the GVWR and GAWR limitations.

Never exceed the GVWR or the GAWR specified on the certification label.

Steps for Determining the Correct Load Limit

▼ Steps for Determining the Correct Load Limit

Steps for Determining Correct Load Limit-

- (1) Locate the statement "The combined weight of occupants and cargo should never exceed XXX kg or XXX lbs." on your vehicle's placard.
- (2) Determine the combined weight of the driver and passengers that will be riding in your vehicle.
- (3) Subtract the combined weight of the driver and passengers from XXX kg or XXX lbs.
- (4) The resulting figure equals the available amount of cargo and luggage load capacity. For example, if the "XXX" amount equals 1400 lbs. and there will be five 150 lb passengers in your vehicle, the amount of available cargo and luggage load capacity is 650 lbs. ($1400 - 750 (5 \times 150) = 650$ lbs.)
- (5) Determine the combined weight of luggage and cargo being loaded on the vehicle. That weight may not safely exceed the available cargo and luggage load capacity calculated in Step 4.
- (6) If your vehicle will be towing a trailer, load from your trailer will be transferred to your vehicle. Consult this manual to determine how this reduces the available cargo and luggage load capacity of your vehicle.

Declaration of Conformity

▼ Keyless Entry System/Immobilizer System

FCC CAUTION

Changes or modifications not expressly approved by the party responsible for compliance could void the user's authority to operate the equipment.

FCC/IC

This device complies with Part 15 of FCC Rules and Industry Canada's licence-exempt RSSs. Operation is subject to the following two conditions: (1) this device may not cause harmful interference, and (2) this device must accept any interference received, including interference that may cause undesired operation.

Le présent appareil est conforme à la partie 15 des règles de la FCC et aux normes des CNR d'Industrie Canada applicables aux appareils radio exempts de licence. L'exploitation est autorisée aux deux conditions suivantes : (1) l'appareil ne doit pas produire de brouillage, et (2) l'appareil doit accepter tout brouillage subi, même si le brouillage est susceptible d'en compromettre le fonctionnement.

(MEXICO)

La operación de este equipo está sujeta a las siguientes dos condiciones: (1) es posible que este equipo o dispositivo no cause interferencia perjudicial y (2) este equipo o dispositivo debe aceptar cualquier interferencia, incluyendo la que pueda causar su operación no deseada.

Declaration of Conformity

▼ Tire Pressure Monitoring System

USA

This device complies with Part 15 of the FCC Rules. Operation is subject to the following two conditions: (1) this device may not cause harmful interference, and (2) this device must accept any interference received, including interference that may cause undesired operation.

Changes or modifications not expressly approved by the party responsible for compliance could void the user's authority to operate the equipment.

Canada

This device complies with Industry Canada licence-exempt RSS standard(s). Operation is subject to the following two conditions: (1) this device may not cause interference, and (2) this device must accept any interference, including interference that may cause undesired operation of the device.

Le présent appareil est conforme aux CNR d'Industrie Canada applicables aux appareils radio exempts de licence. L'exploitation est autorisée aux deux conditions suivantes : (1) l'appareil ne doit pas produire de brouillage, et (2) l'utilisateur de l'appareil doit accepter tout brouillage radioélectrique subi, même si le brouillage est susceptible d'en compromettre le fonctionnement.

Mexico

La operación de este equipo está sujeta a las siguientes dos condiciones: (1) es posible que este equipo o dispositivo no cause interferencia perjudicial y (2) este equipo o dispositivo debe aceptar cualquier interferencia, incluyendo la que pueda causar su operación no deseada.

▼ HomeLink Wireless Control System

FCC (U.S.A) and ISED (Canada)

This device complies with FCC rules part 15 and Innovation, Science, and Economic Development Canada RSS-210. Operation is subject to the following two conditions: (1) This device may not cause harmful interference, and (2) This device must accept any interference that may be received including interference that may cause undesired operation. **WARNING:** The transmitter has been tested and complies with FCC and ISED rules. Changes or modifications not expressly approved by the party responsible for compliance could void the user's authority to operate the device.

This equipment complies with FCC and ISED radiation exposure limits set forth for an uncontrolled environment. End Users must follow the specific operating instructions for satisfying RF exposure compliance. This transmitter must be at least 20 cm from the user and must not be co-located or operating in conjunction with any other antenna or transmitter.

FCC (États-Unis) et ISED (Canada)

Cet appareil est conforme aux règlements de la FCC, section 15, et au CNR-210 d'Innovation, Sciences et Développement économique Canada. Le fonctionnement est assujéti aux deux conditions suivantes : (1) cet appareil ne doit pas causer d'interférences nuisibles et (2) cet appareil doit accepter toute interférence reçue, y compris celle qui pourrait entraîner un dysfonctionnement. **MISE EN GARDE :** L'émetteur a subi des tests et est conforme aux règlements de la FCC et d'ISDE. Les changements ou modifications non approuvés explicitement par la partie responsable de la conformité pourraient rendre caduque l'autorisation de l'utilisateur de se servir du dispositif.

Cet appareil est conforme aux limites d'exposition aux radiations de la FCC et d'ISDE établies pour un environnement non contrôlé. Les utilisateurs finaux doivent respecter les instructions d'utilisation spécifiques pour satisfaire aux exigences de conformité aux expositions de RF. L'émetteur doit se trouver à 20 cm au minimum de l'utilisateur et ne doit pas être situé au même endroit que tout autre émetteur ou antenne ni fonctionner avec un autre émetteur ou antenne.

Mexico

La operación de este equipo está sujeta a las siguientes dos condiciones: (1) es posible que este equipo o dispositivo no cause interferencia perjudicial y (2) este equipo o dispositivo debe aceptar cualquier interferencia, incluyendo la que pueda causar su operación no deseada.



Declaration of Conformity

▼ Radio System

FCC

NOTE :

Properly shielded and grounded cables and connectors must be used for connection to host computers and / or peripherals in order to meet FCC emission limits.

CAUTION :

Changes or modifications not expressly approved by the party responsible for compliance could void the user's authority to operate the equipment.

▼ Audio System

USA/FCC

NOTE

Properly shielded and grounded cables and connectors must be used for connection to host computers and / or peripherals in order to meet FCC emission limits.

⚠ WARNING

RF Exposure

This equipment complies with FCC radiation exposure limits set forth for an uncontrolled environment and meets the FCC radio frequency (RF) Exposure Guidelines. This equipment should be installed and operated keeping the radiator at least 20cm or more away from person's body.

This transmitter must not be co-located or operated in conjunction with any other antenna or transmitter.

⚠ CAUTION

Changes or modifications not expressly approved by the party responsible for compliance could void the user's authority to operate the equipment.

Canada

NOTE

This device complies with Industry Canada's applicable licence-exempt RSS.

Operation is subject to the following two conditions:

- (1) This device may not cause interference; and
- (2) This device must accept any interference, including interference that may cause undesired operation of the device.

Le présent appareil est conforme aux CNR d'industrie Canada applicables aux appareils radio exempts de licence.

L'exploitation est autorisée aux deux conditions suivantes :

- 1) l'appareil ne doit pas produire de brouillage;
- 2) l'utilisateur de l'appareil doit accepter tout brouillage radioélectrique subi, même si le brouillage est susceptible d'en compromettre le fonctionnement.

⚠ CAUTION

This equipment complies with IC radiation exposure limits set forth for an uncontrolled environment and meets RSS-102 of the IC radio frequency (RF) Exposure rules. This equipment should be installed and operated keeping the radiator at least 20cm or more away from person's body.

Cet équipement est conforme aux limites d'exposition aux rayonnements électro-magnétiques pour un environnement non contrôlé et respecte les règles d'exposition aux fréquences radioélectriques (RF) CNR-102 de l'IC. Cet équipement doit être installé et utilisé en gardant une distance de 20 cm ou plus entre le radiateur et le corps humain.

Mexico

La operación de este equipo está sujeta a las siguientes dos condiciones:

- (1) es posible que este equipo o dispositivo no cause interferencia perjudicial y
- (2) este equipo o dispositivo debe aceptar cualquier interferencia, incluyendo la que pueda causar su operación no deseada.



Declaration of Conformity

▼ Data Communication System

 **CAUTION**

Radio Frequency Radiation Exposure

This equipment complies with FCC radiation exposure limits set forth for an uncontrolled environment and meets the FCC radio frequency (RF) Exposure Guidelines. This equipment should be installed and operated keeping the radiator at least 20cm or more away from person's body in normal use position.

Co-location

This transmitter must not be co-located or operated in conjunction with any other antenna or transmitter.

This device complies with part 15 of the FCC Rules. Operation is subject to the following two conditions: (1) This device may not cause harmful interference, and (2) this device must accept any interference received, including interference that may cause undesired operation.

FCC

 **WARNING**

Changes or modifications not expressly approved by the party responsible for compliance could void the user's authority to operate the equipment.

▼ Front Radar Sensor System

-USA/Puerto Rico/Guam/Saipan/Canada

Model: ARS4-B
IC: 4135A-ARS4B
FCC ID: OX1MS4B

This device complies with Part 15 of the FCC Rules and with Industry Canada licence-exempt RSS standard(s).

Operation is subject to the following two conditions:

- (1) This device may not cause harmful interference, and
- (2) This device must accept any interference received, including interference that may cause undesired operation.

Le présent appareil est conforme aux CNR d'Industrie Canada applicables aux appareils radio exempts de licence.

L'exploitation est autorisée aux deux conditions suivantes:

- (1) L'appareil ne doit pas produire de brouillage, et
- (2) l'utilisateur de l'appareil doit accepter tout brouillage radioélectrique subi, même si le brouillage est susceptible d'en compromettre le fonctionnement.

Radiofrequency radiation exposure information:

This equipment complies with FCC and IC radiation exposure limits set forth for an uncontrolled environment.

This equipment should be installed and operated with minimum distance of 30 cm between the radiator and your body.

This transmitter must not be co-located or operating in conjunction with any other antenna or transmitter.

Cet équipement est conforme aux limites d'exposition aux rayonnements IC établies pour un environnement non contrôlé.

Cet équipement doit être installé et utilisé avec un minimum de 30 cm de distance entre la source de rayonnement et votre corps.

FCC Notice

Changes or modifications not expressly approved by the party responsible for compliance could void the user's authority to operate the equipment.

-Mexico

Certificado de homologación: RVLCOAR15-0008
Continental ARS 4-B

Este equipo opera a título secundario, consecuentemente, debe aceptar interferencias perjudiciales incluyendo equipos de la misma clase y puede no causar interferencias a sistemas operando a título primario.

Declaration of Conformity

▼ Front Side Radar/Rear Side Radar System

-USA/Puerto Rico/Guam/Saipan

FCC ID: DAY5RR3A

This device complies with Part 15 of the FCC Rules.

Operation is subject to the following two conditions:

- (1) this device may not cause harmful interference, and
- (2) this device must accept any interference received, including interference that may cause undesired operation.

CAUTION TO USERS

Changes or modifications not expressly approved by the party responsible for compliance could void the user's authority to operate the equipment.

-Canada

C: 4135A-5333A

This device contains licence-exempt transmitter(s)/receiver(s) that comply with Innovation, Science and Economic Development Canada's licence-exempt RSS(s).

Operation is subject to the following two conditions:

- (1) This device may not cause harmful interference.
- (2) This device must accept any interference, including interference that may cause undesired operation of the device.

L'émetteur/récepteur exempt de licence contenu dans le présent appareil est conforme aux CNR d'Innovation, Sciences et Développement économique Canada applicables aux appareils radio exempts de licence.

L'exploitation est autorisée aux deux conditions suivantes:

1. L'appareil ne doit pas produire de brouillage;
2. L'appareil doit accepter tout brouillage radioélectrique subi, même si le brouillage est susceptible d'en compromettre le fonctionnement.

Radiofrequency radiation exposure information:

This equipment complies with radiation exposure limits set forth for an uncontrolled environment.

This equipment should be installed and operated with minimum distance of 20 cm between the radiator and your body.

Informations sur l'exposition aux rayonnements radiofréquences:

Cet équipement est conforme aux limites d'exposition aux rayonnements définies pour un environnement non contrôlé.

Cet équipement doit être installé et utilisé avec un minimum de 20 cm de distance entre la source de rayonnement et votre corps.

Declaration of Conformity

-Mexico

Certificado de homologacion: RLVCSR15-0442

Continental SRR3-A

Este equipo opera a titulo secundario, consecuentemente,
debe aceptar interferencias perjudiciales
incluyendo equipos de la misma clase y puede no causar interferencias
a sistemas operando a titulo primario.

MEMO

9

Specifications

Technical information about your Mazda.

Identification Numbers.....	9-2	Specifications.....	9-4
Vehicle Information Labels.....		Specifications.....	9-4
.....	9-2		



Identification Numbers

Vehicle Information Labels

▼ Vehicle Identification Number

The vehicle identification number legally identifies your vehicle. The number is on a plate attached to the cowl panel located on the left corner of the dashboard. This plate can easily be seen through the windshield.



▼ Motor Vehicle Safety Standard Label (U.S.A. and Canada)



▼ Chassis Number

Open the cover shown in the figure to check the chassis number.

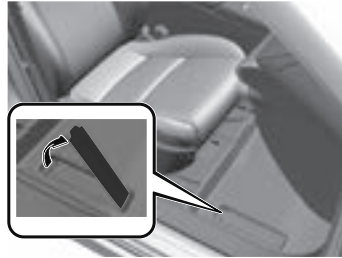

▼ Vehicle Emission Control Information Label (U.S.A. and Canada)

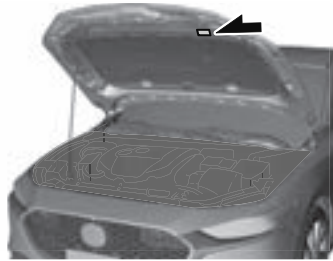

▼ Tire Pressure Label



▼ Engine Number

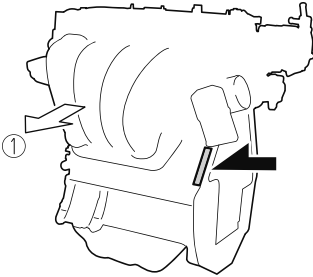

1. Forward

Specifications

▼ Engine

Item	Specification		
	SKYACTIV-G 2.0	SKYACTIV-G 2.5	SKYACTIV-G 2.5T
Type	DOHC-16V in-line, 4-cylinder		
Bore × Stroke	83.5 × 91.2 mm (3.29 × 3.59 in)	89.0 × 100 mm (3.50 × 3.94 in)	
Displacement	1,997.6 ml (1,997.6 cc)	2,488.5 ml (2,488.5 cc)	
Compression ratio	13.0		10.5

▼ Electrical System

Item	Classification		
Battery ^{*1}	12V-60Ah/20HR or 12V-65Ah/20HR		
Spark-plug number	SKYACTIV-G 2.0, SKYACTIV-G 2.5	Mazda Genuine spark plug ^{*2}	PE5R-18-110 or PE5S-18-110
	SKYACTIV-G 2.5T	Mazda Genuine spark plug ^{*2}	PY8V-18-110

^{*1} Check the battery installed on the vehicle and use a battery with an equal or higher performance. However, the performance of the battery may vary even among the same battery types, consult an Authorized Mazda Dealer for replacement.

^{*2} This spark plug provides the SKYACTIV-G engine with optimum performance. Contact an Authorized Mazda Dealer for details.



When cleaning the iridium plugs, do not use a wire brush. The fine particulate coating on the iridium alloy and platinum tips could be damaged.

▼ **Lubricant Quality**

Lubricant	Classification
Engine oil	Refer to Recommended Oil on page 6-17.
Coolant	FL-22 type
Manual transmission oil	Mazda Long Life Gear Oil G7
Automatic transmission fluid	Mazda Genuine ATF FZ
Transfer case oil	Mazda Long Life Hypoid Gear Oil SG1
Rear differential oil	Mazda Long Life Hypoid Gear Oil SG1
Brake/Clutch fluid	SAE J1703 or FMVSS116 DOT-3

NOTE

Refer to Introduction on (page 6-2) for owner's responsibility in protecting your investment.

▼ **Capacities**

(Approximate Quantities)

		Item	Capacity
Engine oil	SKYAC-TIV-G 2.0	With oil filter replacement	4.2 L (4.4 US qt, 3.7 Imp qt)
		Without oil filter replacement	4.0 L (4.2 US qt, 3.5 Imp qt)
	SKYAC-TIV-G 2.5	With oil filter replacement	4.5 L (4.8 US qt, 4.0 Imp qt)
		Without oil filter replacement	4.3 L (4.5 US qt, 3.8 Imp qt)
	SKYAC-TIV-G 2.5T	With oil filter replacement	4.8 L (5.1 US qt, 4.2 Imp qt)
		Without oil filter replacement	4.6 L (4.9 US qt, 4.0 Imp qt)
Coolant	SKYAC-TIV-G 2.0	Manual transmission	6.3 L (6.7 US qt, 5.5 Imp qt)
		Automatic transmission	6.5 L (6.9 US qt, 5.7 Imp qt)
	SKYAC-TIV-G 2.5	Manual transmission	6.3 L (6.7 US qt, 5.5 Imp qt)
		Automatic transmission	6.6 L (7.0 US qt, 5.8 Imp qt)
	SKYAC-TIV-G 2.5T	For engine	8.3 L (8.8 US qt, 7.3 Imp qt)
		For water-cooled charge air cooler	1.6 L (1.7 US qt, 1.4 Imp qt)
Manual transmission oil	SKYACTIV-G 2.0		1.70 L (1.80 US qt, 1.50 Imp qt)
	SKYACTIV-G 2.5		1.65 L (1.74 US qt, 1.45 Imp qt)
Automatic transmission fluid	SKYACTIV-G 2.0		7.6 L (8.0 US qt, 6.7 Imp qt)
	SKYAC-TIV-G 2.5	With Cylinder Deactivation	7.9 L (8.3 US qt, 7.0 Imp qt)
		Without Cylinder Deactivation	7.6 L (8.0 US qt, 6.7 Imp qt)
	SKYACTIV-G 2.5T		8.0 L (8.5 US qt, 7.0 Imp qt)
Transfer case oil			0.35 L (0.37 US qt, 0.31 Imp qt)

Specifications

Item		Capacity	
Rear differential oil		0.35 L (0.37 US qt, 0.31 Imp qt)	
Fuel tank	U.S.A. and Canada	FWD	50.0 L (13.2 US gal, 11.0 Imp gal)
		AWD	48.0 L (12.7 US gal, 10.6 Imp gal)
	Mexico	FWD	51.0 L (13.5 US gal, 11.2 Imp gal)
		AWD	48.0 L (12.7 US gal, 10.6 Imp gal)

Check oil and fluid levels with dipsticks or reservoir gauges.

▼ Dimensions

4-Door

Item	Vehicle specification	
Overall length	4,662 mm (183.5 in)	
Overall width	1,797 mm (70.7 in)	
Overall height	1,445 mm (56.9 in)	
Front tread	1,568 mm (61.7 in)	
Rear tread	FWD	1,581 mm (62.2 in)
	AWD	1,580 mm (62.2 in)
Wheelbase	2,726 mm (107.3 in)	

5-Door

Item	Vehicle specification	
Overall length	4,459 mm (175.6 in)	
Overall width	1,797 mm (70.7 in)	
Overall height	1,440 mm (56.7 in)	
Front tread	1,568 mm (61.7 in)	
Rear tread	FWD	1,581 mm (62.2 in)
	AWD	1,580 mm (62.2 in)
Wheelbase	2,726 mm (107.3 in)	

▼ **Weights**

U.S.A. and Canada

**SKYACTIV-G 2.0
(4-Door)**

Item		Weight	
		Manual transmission	Automatic transmission
GVWR (Gross Vehicle Weight Rating)		1,804 kg (3,977 lbs)	1,825 kg (4,023 lbs)
GAWR (Gross Axle Weight Rating)	Front	966 kg (2,130 lbs)	989 kg (2,180 lbs)
	Rear	843 kg (1,858 lbs)	841 kg (1,854 lbs)

(5-Door)

Item		Weight	
		Manual transmission	Automatic transmission
GVWR (Gross Vehicle Weight Rating)		1,810 kg (3,990 lbs)	1,833 kg (4,041 lbs)
GAWR (Gross Axle Weight Rating)	Front	965 kg (2,127 lbs)	989 kg (2,180 lbs)
	Rear	848 kg (1,870 lbs)	847 kg (1,867 lbs)

**SKYACTIV-G 2.5
(4-Door)**

Item		Weight	
		FWD	AWD
GVWR (Gross Vehicle Weight Rating)		1,850 kg (4,079 lbs)	1,910 kg (4,211 lbs)
GAWR (Gross Axle Weight Rating)	Front	1,016 kg (2,240 lbs)	1,030 kg (2,271 lbs)
	Rear	839 kg (1,850 lbs)	885 kg (1,951 lbs)

(5-Door)

Item		Weight		
		FWD		AWD
		Manual transmission	Automatic transmission	
GVWR (Gross Vehicle Weight Rating)		1,822 kg (4,017 lbs)	1,849 kg (4,076 lbs)	1,915 kg (4,222 lbs)
GAWR (Gross Axle Weight Rating)	Front	987 kg (2,176 lbs)	1,016 kg (2,240 lbs)	1,046 kg (2,306 lbs)
	Rear	838 kg (1,847 lbs)	836 kg (1,843 lbs)	872 kg (1,922 lbs)

Specifications

SKYACTIV-G 2.5T (4-Door)

Item		Weight
GVWR (Gross Vehicle Weight Rating)		1,950 kg (4,299 lbs)
GAWR (Gross Axle Weight Rating)	Front	1,066 kg (2,350 lbs)
	Rear	889 kg (1,960 lbs)

(5-Door)

Item		Weight
GVWR (Gross Vehicle Weight Rating)		1,950 kg (4,299 lbs)
GAWR (Gross Axle Weight Rating)	Front	1,085 kg (2,392 lbs)
	Rear	868 kg (1,914 lbs)

Mexico

SKYACTIV-G 2.5 (4-Door)

Item	Weight	
	Manual transmission	Automatic transmission
GVW (Gross Vehicle Weight)	1,861 kg (4,103 lbs)	1,870 kg (4,123 lbs)

(5-Door)

Item	Weight	
	Manual transmission	Automatic transmission
GVW (Gross Vehicle Weight)	1,848 kg (4,074 lbs)	1,870 kg (4,123 lbs)

SKYACTIV-G 2.5T

Item	Weight
GVW (Gross Vehicle Weight)	1,950 kg (4,299 lbs)

▼ Light Bulbs

Exterior light

Light bulb	Category	
	Wattage	UN-R ^{*1} (SAE)
Headlights	LED	— (—)
Daytime running lights	LED	— (—)
Parking lights	LED type	— (—)
	Bulb type	5 WY5W (—)
Front turn signal lights	LED	— (—)
Front side-marker lights	LED type	— (—)
	Bulb type	5 WY5W (—)
Side turn signal lights [*]	LED	— (—)
High-mount brake light	LED	— (—)
Rear turn signal lights	LED	— (—)
Rear side-marker lights	LED	— (—)
Brake lights	LED	— (—)
Taillights	LED	— (—)
Reverse lights	LED	— (—)
License plate lights	LED	— (—)

*1 UN-R stands for United Nations Regulation.

Interior light

Light bulb	Category	
	Wattage	UN-R ^{*1}
Overhead light (Front)/Map lights	LED	—
Overhead light (Rear)	LED	—
Vanity mirror lights [*]	LED	—
Trunk light (4-Door)	5	—
Luggage compartment light (5-Door)	LED	—

*1 UN-R stands for United Nations Regulation.

Specifications

▼ Tires

NOTE

The tires have been optimally matched with the chassis of your vehicle. When replacing tires, Mazda recommends that you replace tires of the same type originally fitted to your vehicle. For details, contact an Authorized Mazda Dealer.

Check the tire pressure label for tire size and inflation pressure.

- Refer to Tire Pressure Label on page 9-2.
- Refer to Tire Inflation Pressure on page 6-34.

Standard tire

(U.S.A. and Canada)

Tire size		Inflation pressure	
		Front	Rear
205/60R16 92H M+S		250 kPa (36 psi)	250 kPa (36 psi)
215/45R18 89V M+S	SKYACTIV-G 2.0, SKYACTIV-G 2.5	250 kPa (36 psi)	250 kPa (36 psi)
	SKYACTIV-G 2.5T	260 kPa (38 psi)	250 kPa (36 psi)

(Mexico)

Tire size		Inflation pressure	
		Up to 3 persons	—Full load
205/60R16 92V	Front	250 kPa (2.5 bar, 36 psi)	260 kPa (2.6 bar, 38 psi)
	Rear	250 kPa (2.5 bar, 36 psi)	290 kPa (2.9 bar, 42 psi)
215/45R18 89W	SKYACTIV-G 2.5	Front	250 kPa (2.5 bar, 36 psi)
		Rear	250 kPa (2.5 bar, 36 psi)
	SKYACTIV-G 2.5T	Front	260 kPa (2.6 bar, 38 psi)
		Rear	250 kPa (2.5 bar, 36 psi)

1 person's weight: About 75 kg

Temporary spare tire

Tire size	Inflation pressure
T125/70D16 96M ^{*1}	420 kPa (60 psi)
T125/80D16 97M ^{*2}	420 kPa (60 psi)

*1 FWD

*2 AWD

Lug nut tightening torque

When installing a tire, tighten the lug nut to the following torque.
108—147 N·m (12—14 kgf·m, 80—108 ft·lbf)

▼ Fuses

Refer to Fuses on page 6-40.

MEMO

10 Index



Index

A

- Accessory Socket..... 5-41
- Active Driving Display..... 4-30
- Adaptive Front Lighting System (AFS)..... 4-90
- Add-On Non-Genuine Parts and Accessories..... 8-17
- Advanced Key
 - Advanced keyless entry system..... 3-9
 - Operational range..... 3-10
- Advanced Keyless Entry System..... 3-9
- Antilock Brake System (ABS)..... 4-77
- Assist Grips..... 5-44
- AUTOHOLD..... 4-71
- AUTOHOLD Warning Beep..... 7-45
- Automatic Transmission
 - Active Adaptive Shift (AAS)... 4-38
 - Automatic transmission controls..... 4-35
 - Direct mode..... 4-44
 - Driving tips..... 4-45
 - Manual shift mode..... 4-38
 - Shift-lock system..... 4-36
 - Transmission ranges..... 4-37

B

- Battery..... 6-29
 - Maintenance..... 6-30
 - Replacement..... 6-30
 - Specifications..... 9-4
- Battery Runs Out..... 7-17
 - Jump-starting..... 7-17
- Blind Spot Monitoring (BSM).... 4-96
 - Canceling operation of Blind Spot Monitoring (BSM)..... 4-100
- Blind Spot Monitoring (BSM) Warning Beep..... 7-46
- Body Lubrication..... 6-23

- Bottle Holder..... 5-44
- Brakes
 - Brake assist..... 4-69
 - Brake override system..... 4-70
 - Electric Parking Brake (EPB).... 4-66
 - Foot brake..... 4-65
 - Pad wear indicator..... 4-69
 - Parking brake..... 4-66
 - Warning light..... 4-69
- Brake Override System..... 4-70
- Brake Override Warning Beep..... 7-45
- Break-In Period..... 3-44

C

- Capacities..... 9-5
- Cell Phones..... 8-18
- Center Console..... 5-46
- Child Restraint
 - Categories of child-restraint systems..... 2-37
 - Child-restraint precautions.... 2-32
 - Child-restraint system installation..... 2-37
 - Child-restraint system suitability for various seat positions table..... 2-39
 - Installing child-restraint systems..... 2-42
 - ISOFIX child-restraint systems (Mexico)..... 2-50
 - LATCH child-restraint systems (Except Mexico)..... 2-50
- Climate Control System
 - Fully automatic type..... 5-10
 - Manual type..... 5-5
 - Operating tips..... 5-2
 - Vent operation..... 5-3
- Collision warning..... 7-47
- Coming Home Light..... 4-50
- Cruise Control..... 4-215

Cruise control switch..... 4-215
 Cruise standby indication (white)/
 cruise set indication (green).....
 4-215
 Cup Holder..... 5-42
 Customer Assistance (Canada)..... 8-6
 Customer Assistance (Mexico)... 8-10
 Customer Assistance (Puerto
 Rico)..... 8-9
 Customer Assistance (U.S.A.)..... 8-2
 Cylinder Deactivation..... 4-11

D

Daytime Running Lights..... 4-51
 Defogger..... 4-58
 Mirror..... 4-59
 Rear window..... 4-58
 Dimensions..... 9-6
 Display..... 4-12
 Distance & Speed Alert (DSA).. 4-108
 Indication on display..... 4-109
 Door Locks..... 3-11
 Door-ajar Warning Beep..... 7-47
 Driver Attention Alert (DAA)... 4-109
 Driver Monitoring Camera..... 4-214
 Driver Monitoring (DM)..... 4-111
 Drive Selection..... 4-81
 Driving In Flooded Area..... 3-49
 Driving on Uneven Road..... 3-50
 Driving Position Memory..... 2-11
 Driving Tips..... 3-44
 Automatic transmission..... 4-45
 Break-in period..... 3-44
 Driving in flooded area..... 3-49
 Driving on uneven road..... 3-50
 Floor mat..... 3-46
 Hazardous driving..... 3-45
 Overloading..... 3-49
 Rocking the vehicle..... 3-46

Saving fuel and protection of the
 environment..... 3-44
 Turbocharged vehicles (SKYACTIV-
 G 2.5T)..... 3-50
 Winter driving..... 3-47
 Dynamic Stability Control
 (DSC)..... 4-79
 DSC OFF indicator light..... 4-80
 DSC OFF switch..... 4-80
 TCS/DSC indicator light..... 4-79

E

Electric Parking Brake (EPB)..... 4-66
 Electric Parking Brake (EPB) Warning
 Beep..... 7-45
 Emergency Starting
 Push-starting..... 7-20
 Starting a flooded engine..... 7-20
 Emergency Towing
 Tiedown hooks..... 7-24
 Towing description..... 7-23
 Emission Control System..... 3-26
 Engine
 Coolant..... 6-20
 Engine compartment
 overview..... 6-15
 Exhaust gas..... 3-26
 Hood release..... 6-13
 Oil..... 6-17
 Starting..... 4-5
 Essential Information..... 6-2
 Event Data Recorder..... 8-19
 Excessive Speed Warning..... 7-47
 Exterior Care..... 6-48
 Aluminum wheel
 maintenance..... 6-53
 Bright-metal maintenance.... 6-52
 Maintaining the finish..... 6-49
 Plastic part maintenance..... 6-53

Index

F

- Flasher
 - Hazard warning..... 4-60
 - Headlights..... 4-46
- Flat Tire
 - Changing a flat tire..... 7-7
 - Mounting the spare tire..... 7-12
 - Removing a flat tire..... 7-8
- Floor Mat..... 3-46
- Fluids
 - Brake/Clutch..... 6-21
 - Classification..... 9-5
 - Washer..... 6-22
- Foot Brake..... 4-65
- Forward Sensing Camera (FSC) 4-203
- Front Camera/Side Cameras/Rear Camera..... 4-213
- Front Cross Traffic Alert (FCTA) 4-113
- Front Cross Traffic Alert (FCTA) Warning Beep..... 7-46
- Front Radar Sensor..... 4-207
- Front Side Radar Sensor..... 4-209
- Fuel
 - Filler lid and cap..... 3-27
 - Requirements..... 3-25
 - Tank capacity..... 9-5
- Fuses..... 6-40
 - Panel description..... 6-43
 - Replacement..... 6-40

G

- Gauges..... 4-12
- Glove Compartment..... 5-46

H

- Hazardous Driving..... 3-45
- Hazard Warning Flasher..... 4-60

Headlights

- Coming home light..... 4-50
- Flashing..... 4-49
- High-low beam..... 4-49
- Leaving home light..... 4-50
- Leveling..... 4-51
- Head Restraint..... 2-17
- High Beam Control System (HBC)..... 4-90
 - High Beam Control System (HBC) indicator light (green)..... 4-91
- Hill Launch Assist (HLA)..... 4-75
- HomeLink Wireless Control System..... 4-60
- Hood Release..... 6-13
- Horn..... 4-59

I

- If a Warning Light Turns On or Flashes..... 7-27
- If the Active Driving Display Does Not Operate..... 7-50
- Ignition Not Switched Off (STOP) Warning Beep..... 7-43
- Ignition Switch..... 4-4
- Illuminated Entry System..... 5-41
- Immobilizer System..... 3-40
- Inside Trunk Release Lever..... 3-24
- Inspecting Brake/Clutch Fluid Level..... 6-21
- Inspecting Coolant Level..... 6-20
- Inspecting Engine Oil Level..... 6-19
- Inspecting Washer Fluid Level..... 6-22
- Instrument Cluster..... 4-12
 - Average fuel economy..... 4-20
 - Compass display..... 4-21
 - Current fuel economy..... 4-20
 - Dashboard illumination..... 4-18
 - Distance-to-empty..... 4-20

Engine coolant temperature gauge.....	4-17	Adaptive Front Lighting System (AFS).....	4-90
Fuel gauge.....	4-17	Blind Spot Monitoring (BSM).....	4-96
Indication/indicator lights.....	4-25	Camera and sensors.....	4-86
i-ACTIVSENSE display.....	4-21	Distance & Speed Alert (DSA).....	4-108
Message Display.....	4-22	Driver Attention Alert (DAA).....	4-109
Message indicated on multi-information display.....	7-39	Driver monitoring camera....	4-214
Multi-information display.....	4-14	Driver Monitoring (DM).....	4-111
Odometer.....	4-16	Forward Sensing Camera (FSC).....	4-203
Outside temperature display.....	4-19	Front camera/side cameras/rear camera.....	4-213
Speedometer.....	4-12	Front Cross Traffic Alert (FCTA).....	4-113
Tachometer.....	4-13	Front radar sensor.....	4-207
Trip meter.....	4-16	Front side radar sensor.....	4-209
Warning indication/warning lights.....	4-23	High Beam Control System (HBC).....	4-90
Interior Care.....	6-54	i-ACTIVSENSE OFF Switch....	4-89
Active driving display maintenance.....	6-56	i-ACTIVSENSE status symbol (warning/risk avoidance support system).....	4-87
Cleaning the floor mats.....	6-56	Lane Departure Warning System (LDWS).....	4-92
Cleaning the window interiors.....	6-56	Lane-keep Assist System (LAS).....	4-154
Instrument panel top (Soft pad) maintenance.....	6-55	Mazda Radar Cruise Control with Stop & Go function (MRCC with Stop & Go function).....	4-128
Leather upholstery maintenance.....	6-55	Mazda Radar Cruise Control (MRCC).....	4-120
Panel maintenance.....	6-56	Pre-crash safety technology...	4-86
Plastic part maintenance.....	6-55	Rear Cross Traffic Alert (RCTA).....	4-116
Seat belt maintenance.....	6-54	Rear side radar sensor.....	4-211
Upholstery maintenance.....	6-55	Smart Brake Support (SBS)...	4-158
Vinyl upholstery maintenance.....	6-54	Smart Brake Support [Rear Crossing] (SBS-RC).....	4-164
Interior Lights.....	5-39		
Luggage compartment light...	5-39		
Map lights.....	5-39		
Overhead lights.....	5-39		
Trunk light.....	5-39		
i-ACTIVSENSE.....	4-85		
Active safety technology.....	4-85		

Index

- Smart Brake Support [Rear] (SBS-R)..... 4-160
- Traffic Jam Assist (TJA)..... 4-139
- Traffic Sign Recognition System (TSR)..... 4-101
- Ultrasonic sensor..... 4-212
- 360°view monitor.....4-168
- i-ACTIV AWD Operation..... 4-83

J

- Jack..... 7-3
- Jump-Starting..... 7-17

K

- Keyless Entry System..... 3-4
- Keys..... 3-2
 - Key suspend function.....3-8
 - Transmitter..... 3-5
- Key Left-in-luggage Compartment/Trunk Warning Beep (With the advanced keyless function)..... 7-44
- Key Left-in-vehicle Warning Beep (With the advanced keyless function)..... 7-44
- Key Removed from Vehicle Warning Beep..... 7-43
- Key Suspend Function..... 3-8

L

- Label Information
 - Chassis number..... 9-2
 - Engine number..... 9-3
 - Motor vehicle safety standard label..... 9-2
 - Tire pressure label..... 9-2
 - Vehicle emission control information label..... 9-2
 - Vehicle identification number..... 9-2
- Lane Departure Warning sound.. 7-46

- Lane Departure Warning System (LDWS).....4-92
- Lane-change Signals..... 4-52
- Lane-keep Assist System (LAS) 4-154
- Leaving Home Light..... 4-50
- Liftgate..... 3-19
 - Luggage compartment..... 3-22
 - When liftgate/trunk lid cannot be opened..... 7-48
- Liftgate Door-lock Switch Inoperable Warning Beep..... 7-44
- Lights-on Reminder..... 7-42
- Light Bulbs
 - Replacement..... 6-37
 - Specifications..... 9-9
- Low Fuel Warning Beep..... 7-45
- Lubricant Quality..... 9-5
- Luggage Compartment..... 5-47
- Luggage Compartment Light..... 5-39

M

- Maintenance
 - Information..... 6-2
 - Scheduled (Canada)..... 6-6
 - Scheduled (Mexico)..... 6-9
 - Scheduled (U.S.A. and Puerto Rico)..... 6-4
- Manual Transmission Shift Pattern..... 4-33
- Map Lights..... 5-39
- Mazda Connect..... 5-15
 - Appendix..... 5-29
 - Connected Service..... 5-37
 - Mazda Connect Basic Operations..... 5-19
- Mazda Radar Cruise Control with Stop & Go function (MRCC with Stop & Go function)..... 4-128
 - Close proximity warning..... 4-132

Display indication.....4-131
 Setting the system.....4-133
 Stop hold control..... 4-138
 Mazda Radar Cruise Control with
 Stop & Go function (MRCC with Stop
 & Go function) System
 Warnings..... 7-46
 Mazda Radar Cruise Control
 (MRCC).....4-120
 Close proximity warning.....4-123
 Display indication.....4-122
 Setting the system.....4-124
 Shift-up/shift-down request
 display..... 4-128
 Mazda Radar Cruise Control (MRCC)
 System Warnings..... 7-46
 Message Indicated on Multi-
 information Display..... 7-39
 Meters.....4-12
 Mirrors
 Outside mirrors..... 3-30
 Rearview mirror.....3-32
 Mirror Defogger.....4-59
 Moonroof.....3-37
 Multi-information Display.....4-14

O

Outside Mirrors.....3-30
 Overhead Console..... 5-46
 Overhead Lights..... 5-39
 Overheating.....7-21
 Overloading.....3-49
 Owner Maintenance
 Closing the hood.....6-14
 Engine compartment
 overview..... 6-15
 Key battery replacement.....6-31
 Opening the hood.....6-13
 Owner maintenance
 precautions..... 6-12

P

Parking Brake..... 4-66
 Parking Sensor System..... 4-238
 Parking Sensor OFF Switch...4-242
 Sensor detection range.....4-240
 Power Steering.....4-84
 Power Windows..... 3-34

R

Rearview Mirror..... 3-32
 Rear Coat Hooks.....5-45
 Rear Cross Traffic Alert (RCTA).....
 4-116
 Rear Cross Traffic Alert (RCTA)
 Warning Beep..... 7-46
 Rear Door Child Safety Locks.... 3-19
 Rear Side Radar Sensor.....4-211
 Rear View Monitor.....4-223
 Displayable range on the
 screen.....4-225
 Rear view monitor
 operation.....4-228
 Rear view parking camera
 location..... 4-224
 Switching to the rear view monitor
 display..... 4-225
 Variance between actual road
 conditions and displayed
 image..... 4-235
 Viewing the display.....4-226
 Rear Window Defogger..... 4-58
 Rear Window Washer.....4-57
 Rear Window Wiper.....4-57
 Recommended Oil..... 6-17
 Recording of Vehicle Data.....8-20
 Recreational Towing..... 3-51
 Registering Your Vehicle in A Foreign
 Country..... 8-16
 Replacement

Index

Fuse.....	6-40
Key battery.....	6-31
Light bulbs.....	6-37
Tires.....	6-35
Wheel.....	6-37
Wiper.....	6-23
Rocking the Vehicle.....	3-46

S

Safety Defects, Reporting (Canada).....	8-14
Safety Defects, Reporting (U.S.A.).....	8-12
Saving Fuel and Protection of the Environment.....	3-44
Scheduled Maintenance	
Canada.....	6-6
Mexico.....	6-9
U.S.A. and Puerto Rico.....	6-4
Seats	
Driver's seat.....	2-5
Front passenger's seat.....	2-13
Front seat.....	2-5
Head restraint.....	2-17
Rear seat.....	2-14
Seat warmer.....	2-20
Seat Belt System	
Automatic locking.....	2-25
Emergency locking.....	2-25
Extender.....	2-30
Pregnant women.....	2-25
Seat belt precautions.....	2-23
Seat Belt Warning Beep.....	7-42
Security System	
Immobilizer system.....	3-40
Theft-deterrent system.....	3-42
Shift Position Warning Beep.....	7-45
Smart Brake Support (SBS).....	4-158
Collision warning.....	4-159

Stopping the Smart Brake Support (SBS) system operation.....	4-160
Smart Brake Support [Rear Crossing] (SBS-RC).....	4-164
Collision warning.....	4-167
Stopping the Smart Brake Support [Rear Crossing] (SBS-RC) system operation.....	4-168
Smart Brake Support [Rear] (SBS-R).....	4-160
Collision warning.....	4-163
Stopping the Smart Brake Support [Rear] (SBS-R) system operation.....	4-163
Spare Tire.....	7-5
Spare Tire and Tool Storage.....	7-3
Specifications	
Capacities.....	9-5
Dimensions.....	9-6
Electrical system.....	9-4
Engine.....	9-4
Light bulbs.....	9-9
Lubricant quality.....	9-5
Tires.....	9-10
Weights.....	9-7
SRS Air Bags	
Driver and front passenger occupant classification system.....	2-70
How the SRS air bags work....	2-63
Limitations to SRS air bag.....	2-69
Monitoring.....	2-75
SRS air bag deployment criteria.....	2-67
Supplemental restraint system components.....	2-61
Supplemental restraint system (SRS) precautions.....	2-55
Starting the Engine.....	4-5
Steering Wheel	
Heated steering wheel.....	2-21

Horn.....	4-59
Storage Compartments.....	5-45
Center console.....	5-46
Glove compartment.....	5-46
Overhead console.....	5-46
Storage pocket.....	5-46
Storage Pocket.....	5-46
Sunshade.....	3-39
Sunvisors.....	5-38

T

Theft-Deterrent System.....	3-42
Three-flash Turn Signal.....	4-52
Tiedown Hook.....	7-24
Tires.....	6-33
Replacing a tire.....	6-35
Replacing a wheel.....	6-37
Snow tires.....	3-47
Specifications.....	9-10
Temporary spare tire.....	6-36
Tire chains.....	3-48
Tire inflation pressure.....	6-34
Tire rotation.....	6-34
Uniform tire quality grading system (UTQGS).....	8-21
Tire Information	
Location of the tire label (placard).....	8-27
Steps for determining the correct load limit.....	8-34
Tire labeling.....	8-23
Tire maintenance.....	8-29
Vehicle loading.....	8-31
Tire Pressure Monitoring System.....	4-219
Touch Sensor Inoperable Warning Beep (With the advanced keyless function).....	7-44
Towing	
Recreational towing.....	3-51
Trailer towing.....	3-51
Towing Description.....	7-23
Traction Control System (TCS)....	4-78
TCS/DSC indicator light.....	4-78
Traffic Jam Assist (TJA).....	4-139
Close proximity warning.....	4-145
Display indication.....	4-143
Setting the system.....	4-146
Shift-up/shift-down request display.....	4-153
Stop hold control.....	4-153
Traffic Sign Recognition System (TSR).....	4-101
Trouble	
Battery runs out.....	7-17
Emergency starting.....	7-20
Flat tire.....	7-7
Overheating.....	7-21
Parking in an emergency.....	7-2
When liftgate/trunk lid cannot be opened.....	7-48
Trunk Lid.....	3-19
Inside trunk release lever.....	3-24
When liftgate/trunk lid cannot be opened.....	7-48
Trunk Light.....	5-39
Turn and Lane-Change Signals....	4-52
Turn Signals.....	4-52

U

Ultrasonic Sensor.....	4-212
------------------------	-------

V

Vehicle Information Labels	
Chassis number.....	9-2
Engine number.....	9-3
Motor vehicle safety standard label.....	9-2
Tire pressure label.....	9-2

Index

- Vehicle emission control information label..... 9-2
- Vehicle identification number..... 9-2
- Vehicle Problem Warning Beep... 7-45

W

- Warning Sound is Activated
 - AUTOHOLD warning beep.... 7-45
 - Blind Spot Monitoring (BSM) warning beep..... 7-46
 - Brake override warning beep..... 7-45
 - Collision warning..... 7-47
 - Door-ajar warning beep..... 7-47
 - Electric Parking Brake (EPB) warning beep..... 7-45
 - Excessive speed warning..... 7-47
 - Front Cross Traffic Alert (FCTA) Warning Beep..... 7-46
 - Ignition not switched off (STOP) warning beep..... 7-43
 - Key left-in-luggage compartment/trunk warning beep (With the advanced keyless function).... 7-44
 - Key left-in-vehicle warning beep (With the advanced keyless function)..... 7-44
 - Key removed from vehicle warning beep..... 7-43
 - Lane departure warning sound..... 7-46
 - Liftgate Door-lock Switch Inoperable Warning Beep..... 7-44
 - Lights-on reminder..... 7-42
 - Low fuel warning beep..... 7-45
 - Mazda Radar Cruise Control with Stop & Go function (MRCC with Stop & Go function) system warnings..... 7-46

- Mazda Radar Cruise Control (MRCC) system warnings..... 7-46
- Rear Cross Traffic Alert (RCTA) Warning Beep..... 7-46
- Seat belt warning beep..... 7-42
- Shift position warning beep... 7-45
- Touch sensor inoperable warning beep (With the advanced keyless function)..... 7-44
- Vehicle problem warning beep..... 7-45
- Warranty..... 8-15
- Weights..... 9-7
- Windows
 - Power windows..... 3-34
- Windshield Washer..... 4-56
- Windshield Wipers..... 4-53
- Windshield Wipers Operate at High Speed..... 7-51
- Windshield Wiper De-icer..... 4-58
- Winter Driving..... 3-47
- Wiper
 - Replacing Rear Window Wiper Blade (5-Door)..... 6-27
 - Replacing windshield wiper blades..... 6-24

0-9

- 360°View Monitor..... 4-168
 - How to use the system..... 4-178
 - Margin of error between road surface on screen and actual road surface..... 4-197
 - Side view..... 4-187
 - Top view/front view..... 4-182
 - Top view/front wide view... 4-185
 - Top view/rear view..... 4-190
 - Top view/rear wide view.... 4-195
 - Types of images displayed on the screen..... 4-173