

OGKE20E1



ECLIPSE CROSS

ECLIPSE CROSS

Owner's Manual



ECLIPSE CROSS - ENGLISH - OGKE20E1
Printed in the Netherlands
MITSUBISHI MOTORS

Foreword

Thank you for selecting an ECLIPSE CROSS as your new vehicle. This owner's manual will add to your understanding and full enjoyment of the many fine features of this vehicle. It contains information prepared to acquaint you with the proper way to operate and maintain your vehicle for the utmost in driving pleasure.

MITSUBISHI MOTORS Europe B.V. reserves the right to make changes in design and specifications and/or to make additions to or improvements in this product without obligation to install them on products previously manufactured.

It is an absolute requirement for the driver to strictly observe all laws and regulations concerning vehicles.

This owner's manual has been written in compliance with such laws and regulations, but some of the contents may become contradictory with later amendment of the laws and regulations.

Please leave this owner's manual in the vehicle at time of resale. The next owner will appreciate having access to the information contained in this owner's manual.

Repairs to your vehicle:
Vehicles in the warranty period:
All warranty repairs must be carried out by a MITSUBISHI MOTORS Authorized Service Point.

Vehicles outside the warranty period:
Where the vehicle is repaired is at the discretion of the owner.

Throughout this owner's manual the words **WARNING** and **CAUTION** appear. These serve as reminders to be especially careful. Failure to follow instructions could result in personal injury or damage to your vehicle.

WARNING

Indicates a strong possibility of severe personal injury or death if instructions are not followed.

CAUTION

Means hazards or unsafe practices that could cause minor personal injury or damage to your vehicle.

You will see another important symbol:

NOTE

Gives helpful information.

***: Indicates optional equipment.**

It may differ according to the sales classification; refer to the sales catalogue.

Abbreviations used in this owner's manual:

M/T: Manual transmission **LHD: Left-Hand Drive**
A/T: Automatic Transmission **RHD: Right-Hand Drive**
CVT: Continuously Variable Transmission

The symbol used on the vehicles:



. See owner's manual

Information for station service

	Capacity	2WD models	63 litres
		4WD models	60 litres
Fuel	Recommended fuel	Unleaded petrol octane number (EN228) [Except for vehicles for Russia, Kazakhstan, Belarus, Ukraine and Moldova] 95 RON or higher [Vehicles for Russia, Kazakhstan, Belarus, Ukraine and Moldova] 90 RON or higher Refer to the "General information" section for the fuel selection.	
Engine oil		Refer to the "Maintenance" section for the selection of engine oil.	
Tyre inflation pressure		Refer to the "Maintenance" section for the tyre inflation pressure.	

 **MITSUBISHI MOTORS Europe B.V.**

© 2019 Mitsubishi Motors Corporation

OGKE20E1
BLO-19-000298

20

Table of contents

Overview/Quick guide	1
General information	2
Locking and unlocking	3
Seats and seat belts	4
Instruments and controls	5
Starting and driving	6
For pleasant driving	7
For emergencies	8
Vehicle care	9
Maintenance	10
Specifications	11
Alphabetical index	12
Declaration of Conformity	13

1

Instruments and controls

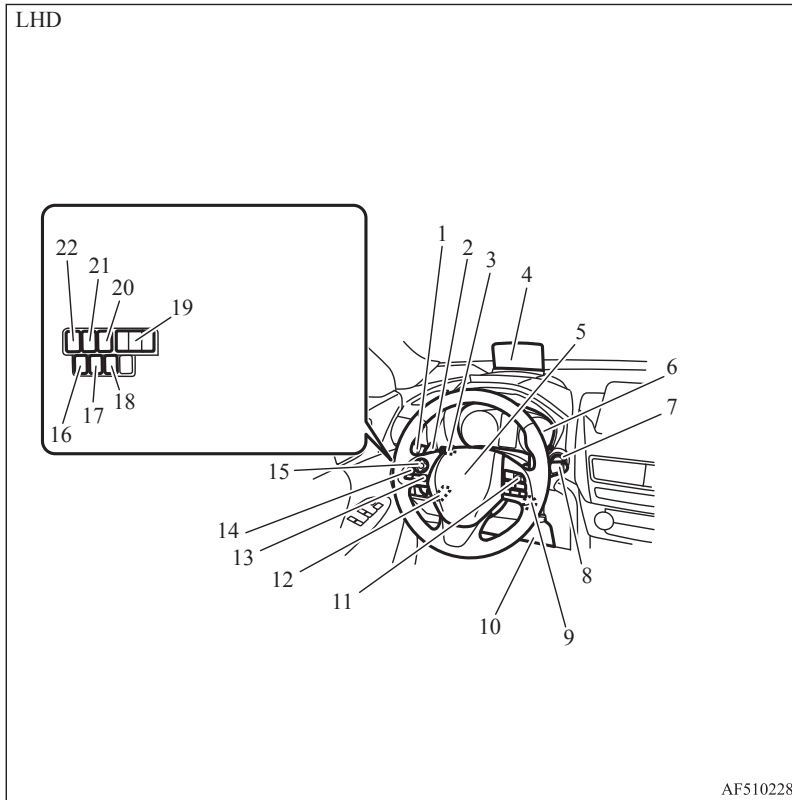

1. Combination headlamps and dipper switch p. 5-56
Automatic High-Beam (AHB) switch* p. 5-59
Turn-signal lever p. 5-65
Front fog lamp switch* p. 5-67
Rear fog lamp switch p. 5-67
2. Shift paddles* p. 6-46
3. Multi-information display switches p. 5-04
4. Head Up Display (HUD)* p. 5-51
5. Supplemental restraint system (SRS) - airbag (for driver's seat) p. 4-26, 4-31
Horn switch p. 5-74
6. Instruments p. 5-02
7. Engine switch* p. 6-15
8. Windscreen wiper and washer switch p. 5-68
Rear window wiper and washer switch p. 5-71
Headlamp washer switch* p. 5-72
9. Ignition switch* p. 6-14
10. Supplemental restraint system (SRS) - front knee airbag (for driver's seat)* p. 4-26, 4-31
11. Cruise control switches* p. 6-69, 6-78
Speed Limiter* p. 6-73
12. Steering wheel height and reach adjustment lever p. 6-09
13. Bluetooth® 2.0 interface* p. 7-56
14. Camera switch* p. 6-134
15. Steering wheel audio remote control switches* p. 7-34
[For DISPLAY AUDIO, Smartphone Link Display Audio and MITSUBISHI Multi-Communication System (MMCS), refer to the separate owner's manual.]
16. Headlamp levelling switch* p. 5-63
17. Auto Stop & Go (AS&G) OFF switch* p. 6-30
18. Sonar switch* p. 6-126
19. Head Up Display (HUD) switches* p. 5-51
20. Active stability control (ASC) OFF switch p. 6-67
21. Lane Departure Warning (LDW) switch* p. 6-113
22. Forward Collision Mitigation system (FCM) and Ultrasonic mis-acceleration Mitigation System (UMS) ON/OFF switch* p. 6-96

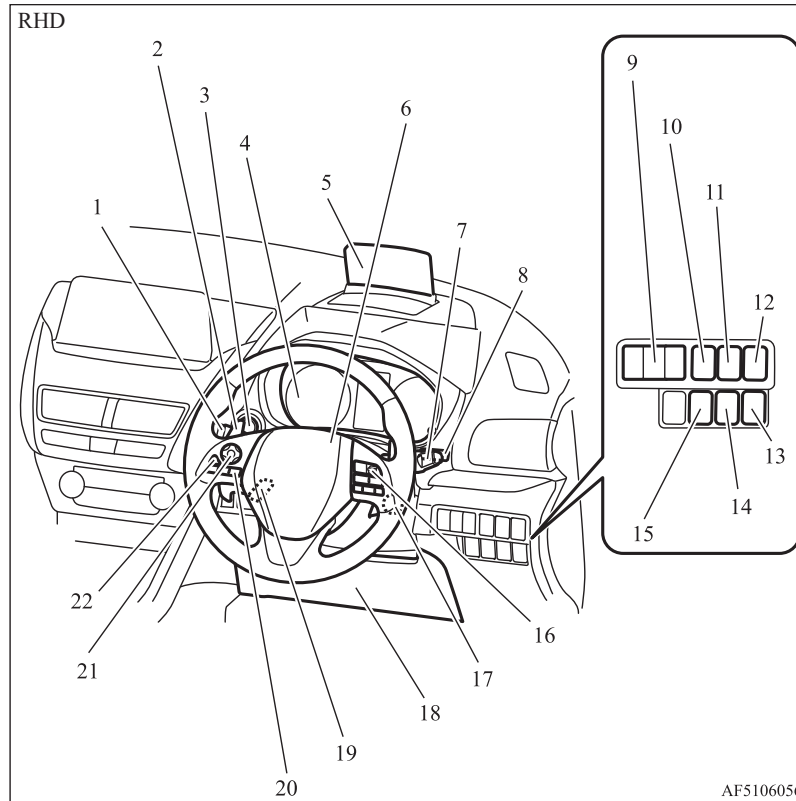

1. Combination headlamps and dipper switch p. 5-56
Automatic High-Beam (AHB) switch p. 5-59
Turn-signal lever p. 5-65
Front fog lamp switch* p. 5-67
Rear fog lamp switch p. 5-67
2. Shift paddles* p. 6-46
3. Engine switch* p. 6-15
4. Instruments p. 5-02
5. Head Up Display (HUD)* p. 5-51
6. Supplemental restraint system (SRS) - airbag (for driver's seat) p. 4-26, 4-31
Horn switch p. 5-74
7. Windscreen wiper and washer switch p. 5-68
Rear window wiper and washer switch p. 5-71
Headlamp washer switch* p. 5-72
8. Multi-information display switches p. 5-04
9. Head Up Display (HUD) switches* p. 5-51
10. Active stability control (ASC) OFF switch p. 6-67
11. Lane Departure Warning (LDW) switch* p. 6-113
12. Forward Collision Mitigation system (FCM) ON/OFF switch p. 6-96
13. Headlamp levelling switch* p. 5-63
14. Auto Stop & Go (AS&G) OFF switch p. 6-30
15. Sonar switch* p. 6-126,
16. Cruise control switches p. 6-69, 6-78
Speed Limiter* p. 6-73
17. Ignition switch p. 6-14
18. Supplemental restraint system (SRS) - front knee airbag (for driver's seat) p. 4-26, 4-31
19. Steering wheel height and reach adjustment lever p. 6-09
20. Bluetooth® 2.0 interface p. 7-56
21. Steering wheel audio remote control switches p. 7-34
[For DISPLAY AUDIO, Smartphone Link Display Audio and MITSUBISHI Multi-Communication System (MMCS), refer to the separate owner's manual.]
22. Camera switch* p. 6-134

Instruments and controls

1

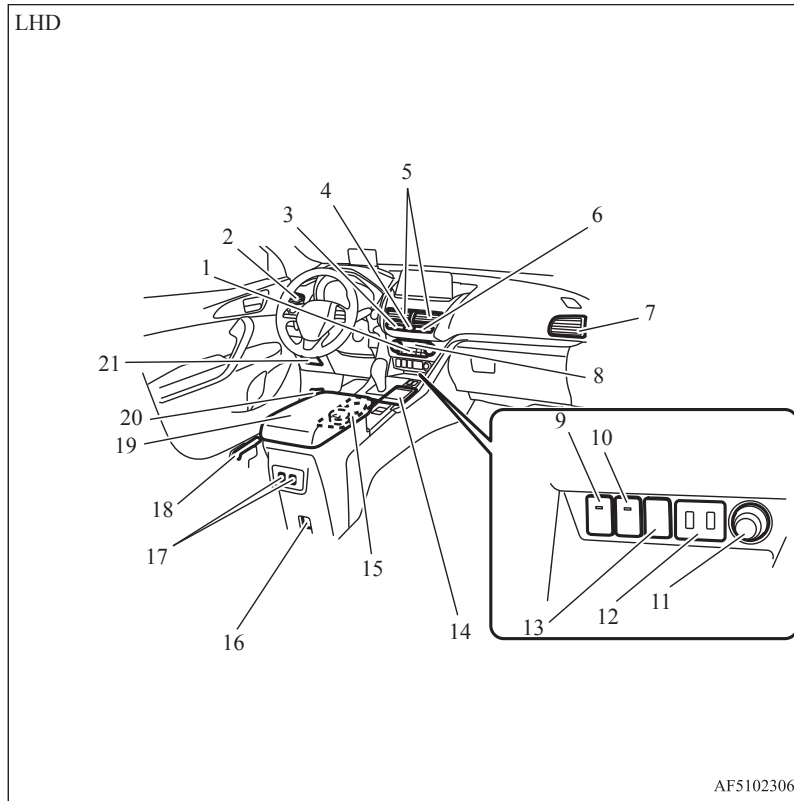

1. Rear window demister switch p. 5-72
2. Side ventilators p. 7-02
3. Seat belt reminder p. 4-10
4. Hazard warning flasher switch p. 5-65
5. Centre ventilators p. 7-02
6. Front passenger's airbag indicator p. 4-30
Security indicator* p. 3-23
7. Side ventilators p. 7-02
8. Air conditioning p. 7-05, 7-10
9. Heated steering wheel switch* p. 5-74
10. Heated windscreen switch* p. 5-73
11. Accessory socket p. 7-80
12. USB input terminal* p. 7-76
13. ECO mode switch* p. 5-66
14. Touchpad controller* [refer to the separate owner's manual.]
15. Front drink holder p. 7-85
Ashtray* p. 7-79
16. Accessory socket p. 7-80
17. Heated seat switches (rear seats)* p. 4-04
18. Fuel tank filler door release lever p. 2-03
19. Floor console box p. 7-84
Armrest p. 4-03
20. Bonnet release lever p. 10-03
21. Fuses p. 10-20

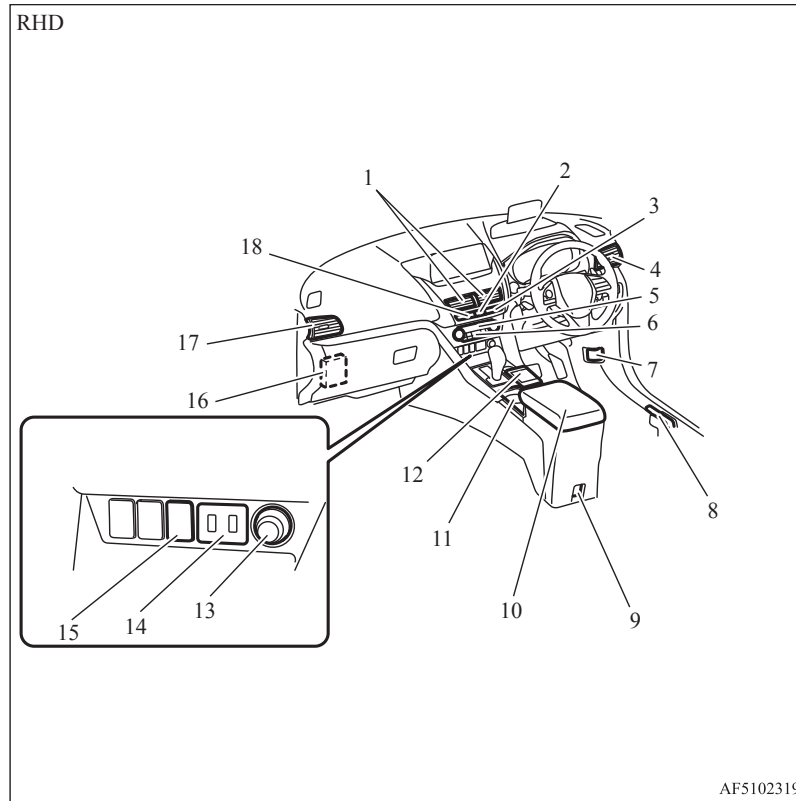

1. Centre ventilators p. 7-02
2. Hazard warning flasher switch p. 5-65
3. Front passenger's airbag indicator p. 4-30
Security indicator* p. 3-23
4. Side ventilators p. 7-02
5. Air conditioning p. 7-05, 7-10
6. Rear window demister switch p. 5-72
7. Bonnet release lever p. 10-03
8. Fuel tank filler door release lever p. 2-03
9. Accessory socket p. 7-80
10. Floor console box p. 7-84
Armrest p. 4-03
11. Front drink holder p. 7-85
12. Touchpad controller* [refer to the separate owner's manual.]
13. Accessory socket p. 7-80
14. USB input terminal p. 7-76
15. ECO mode switch p. 5-66
16. Fuses p. 10-20
17. Side ventilators p. 7-02
18. Seat belt reminder p. 4-10

Instruments and controls

1

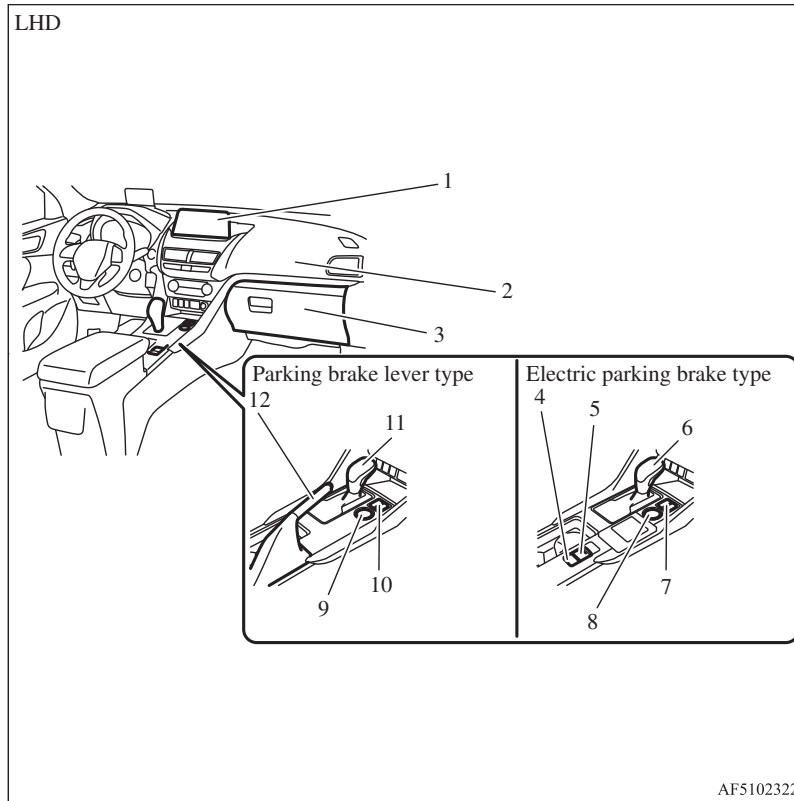

1. Audio* p. 7-22
DISPLAY AUDIO*
Smartphone Link Display Audio*
MITSUBISHI Multi-Communication System (MMCS)*
Multi Around Monitor* p. 6-131
[For DISPLAY AUDIO, Smartphone Link Display Audio and MITSUBISHI Multi-Communication System (MMCS), refer to the separate owner's manual.]
2. Supplemental restraint system (SRS) - airbag (for front passenger's seat) p. 4-26, 4-31
3. Glove box p. 7-84
Card holder p. 7-84
4. Brake auto hold switch p. 6-57
5. Electric parking brake switch p. 6-05
6. Selector lever p. 6-43
7. Heated seat switches (front seats)* p. 4-04
8. S-AWC drive mode-selector* p. 6-51
9. S-AWC drive mode-selector* p. 6-51
10. Heated seat switches (front seats)* p. 4-04
11. Gearshift lever* p. 6-35
Selector lever* p. 6-43
12. Parking brake lever p. 6-04

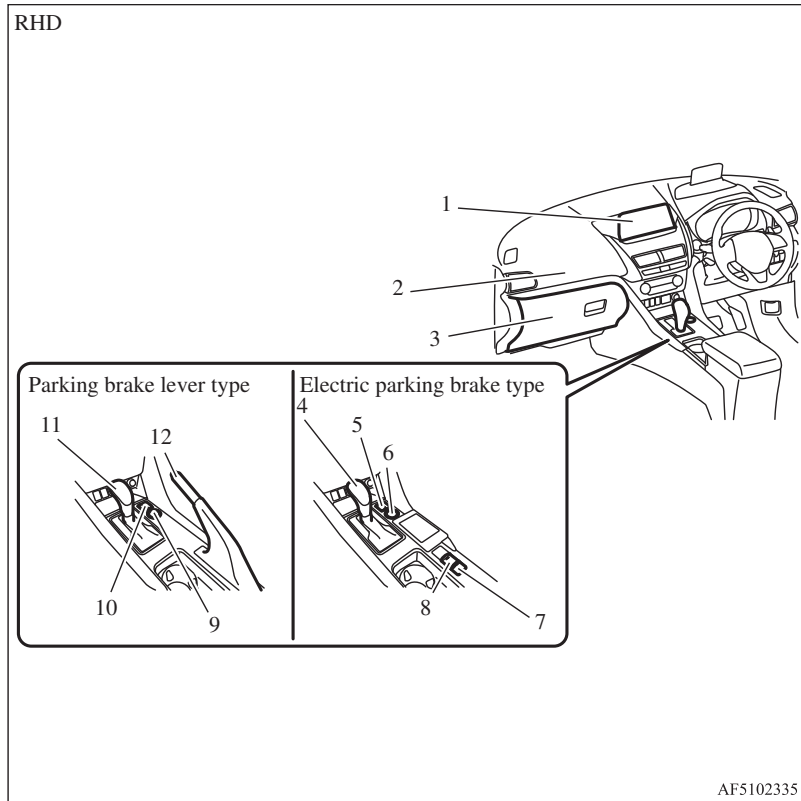

1. Audio* p. 7-22
 DISPLAY AUDIO*
 Smartphone Link Display Audio*
 MITSUBISHI Multi-Communication System (MMCS)*
 Multi Around Monitor* p. 6-131
 [For DISPLAY AUDIO, Smartphone Link Display Audio and
 MITSUBISHI Multi-Communication System (MMCS), refer to
 the separate owner's manual.]
2. Supplemental restraint system (SRS) - airbag (for front passenger's seat) p. 4-26, 4-31
3. Glove box p. 7-84
 Card holder p. 7-84
4. Selector lever p. 6-43
5. Heated seat switches (front seats)* p. 4-04
6. S-AWC drive mode-selector* p. 6-51
7. Brake auto hold switch p. 6-57
8. Electric parking brake switch p. 6-05
9. S-AWC drive mode-selector* p. 6-51
10. Heated seat switches (front seats)* p. 4-04
11. Gearshift lever* p. 6-35
 Selector lever* p. 6-43
12. Parking brake lever p. 6-04

1 Interior

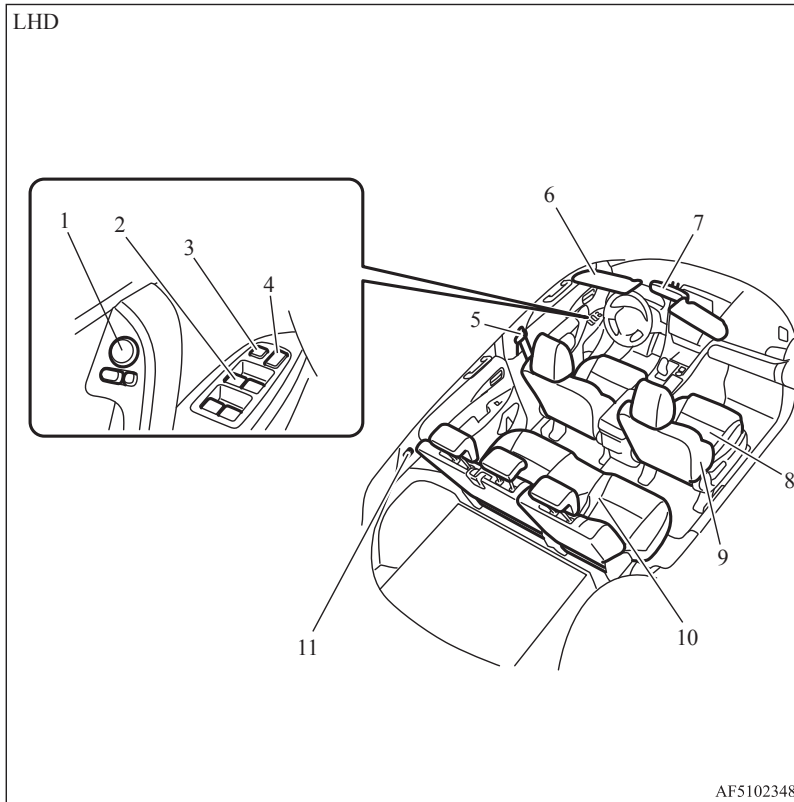

- 1. Electric remote-controlled outside rear-view mirrors switch p. 6-11
- 2. Electric window control switch p. 3-30
- 3. Lock switch p. 3-32
- 4. Central door lock switch p. 3-18
- 5. Adjustable seat belt anchor p. 4-11
Seat belts p. 4-08
- 6. Sun visors p. 7-78
Vanity mirror p. 7-78
Ticket holder p. 7-78
- 7. Inside rear-view mirror p. 6-10
- 8. Front seat p. 4-02
- 9. Supplemental restraint system (SRS) -side airbag (for front seat)*
p. 4-26, 4-34
- 10. Rear seat p. 4-03
- 11. Seat belt plate storage p. 4-13

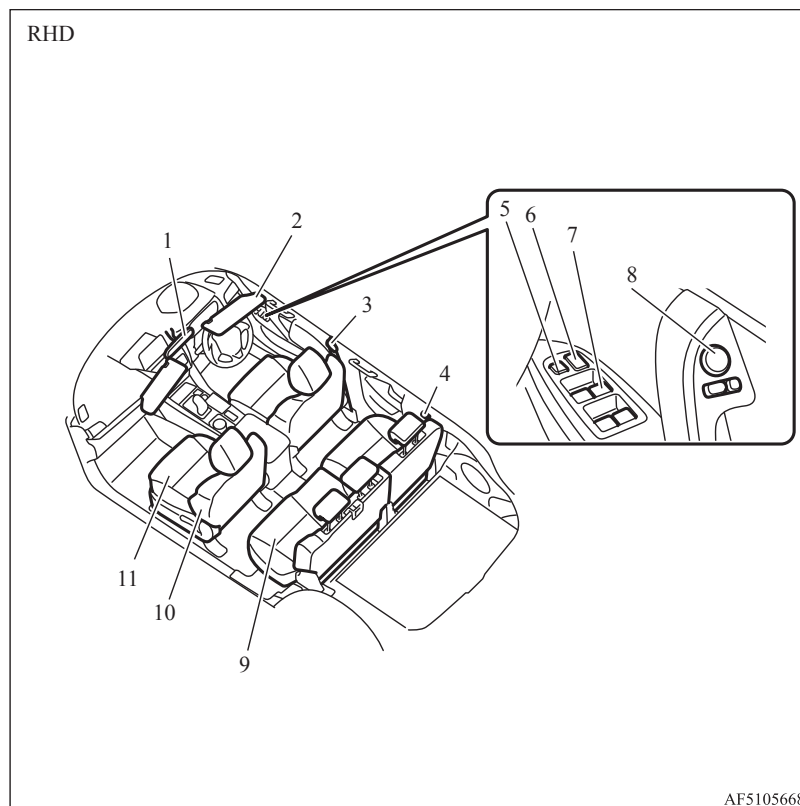

1. Inside rear-view mirror p. 6-10
2. Sun visors p. 7-78
Vanity mirror p. 7-78
Ticket holder p. 7-78
3. Adjustable seat belt anchor p. 4-11
Seat belts p. 4-08
4. Seat belt plate storage p. 4-13
5. Lock switch p. 3-32
6. Central door lock switch p. 3-18
7. Electric window control switch p. 3-30
8. Electric remote-controlled outside rear-view mirrors switch p. 6-11
9. Rear seat p. 4-03
10. Supplemental restraint system (SRS) -side airbag (for front seat) p. 4-26, 4-34
11. Front seat p. 4-02

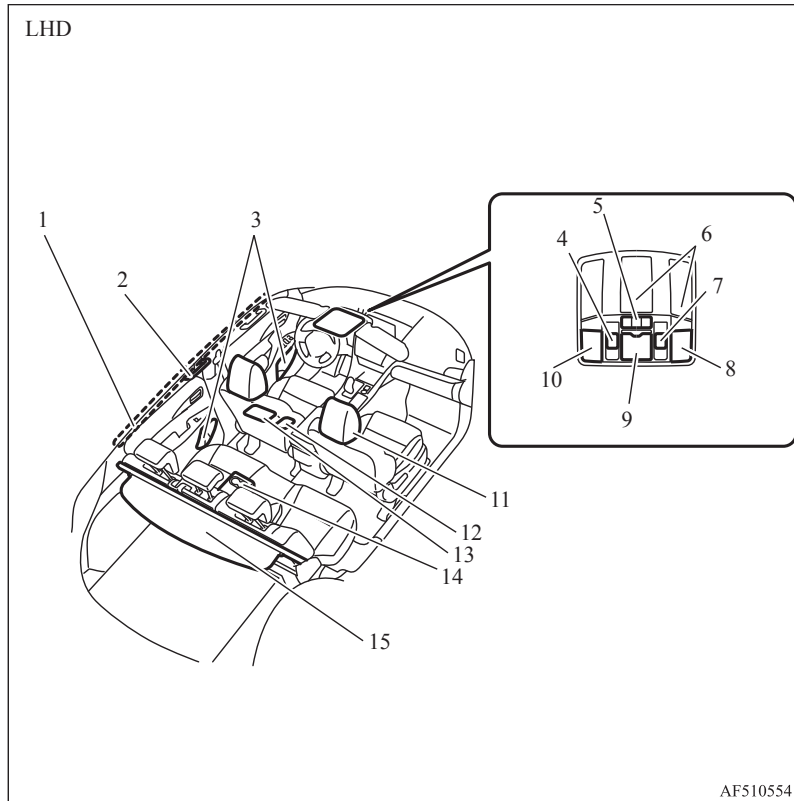

1. Supplemental restraint system (SRS) -curtain airbag* p. 4-26, 4-34
2. Assist grips p. 7-87
Coat hook p. 7-88
3. Bottle holder p. 7-85
4. Front sunroof switch* p. 3-33
5. Room lamp switch p. 7-81
6. Hands-free microphone* p. 7-57
7. Front shade switch* p. 3-33
8. Map & room lamps (front) p. 7-81, 7-82
9. Telematics Control Unit (TCU)* p. 2-05
ERA-GLONASS* p. 8-02
10. Map & room lamps (front) p. 7-81, 7-82
11. Head restraints p. 4-05
12. Rear shade switch* p. 3-33
13. Room lamp (rear) p. 7-81
14. Armrest* p. 4-03
Rear drink holder* p. 7-85
15. Cargo area cover* p. 7-86

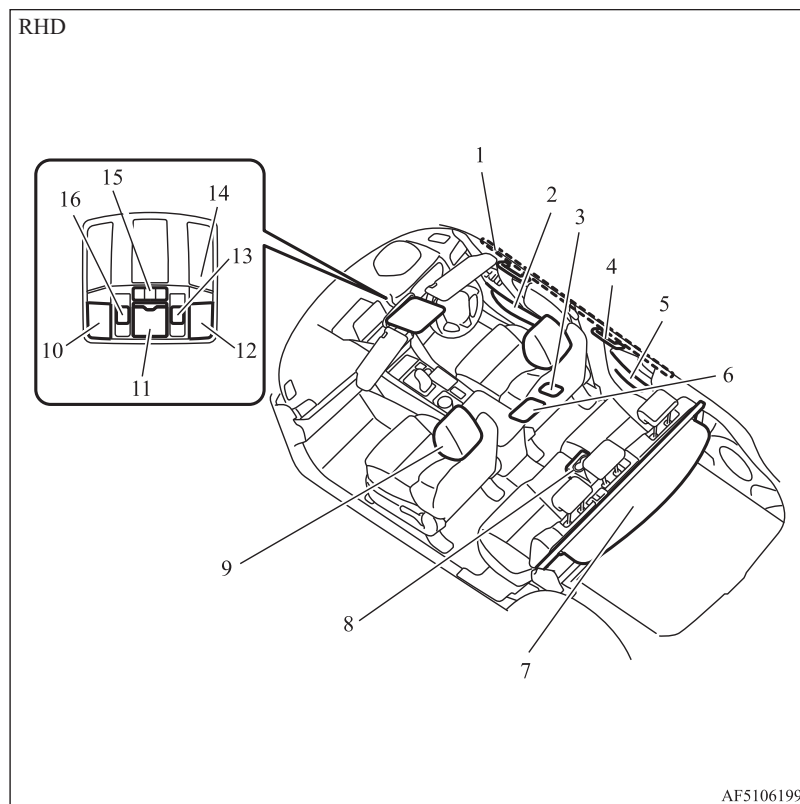

1. Supplemental restraint system (SRS) -curtain airbag p. 4-26, 4-34
2. Bottle holder p. 7-85
3. Rear shade switch* p. 3-33
4. Assist grips p. 7-87
Coat hook p. 7-88
5. Bottle holder p. 7-85
6. Room lamp (rear) p. 7-81
7. Cargo area cover* p. 7-86
8. Armrest* p. 4-03
Rear drink holder* p. 7-85
9. Head restraints p. 4-05
10. Map & room lamps (front) p. 7-81, 7-82
11. Telematics Control Unit (TCU)* p. 2-05
12. Map & room lamps (front) p. 7-81, 7-82
13. Front shade switch* p. 3-33
14. Hands-free microphone* p. 7-57
15. Room lamp switch p. 7-81
16. Front sunroof switch* p. 3-33

Luggage area

1 Luggage area

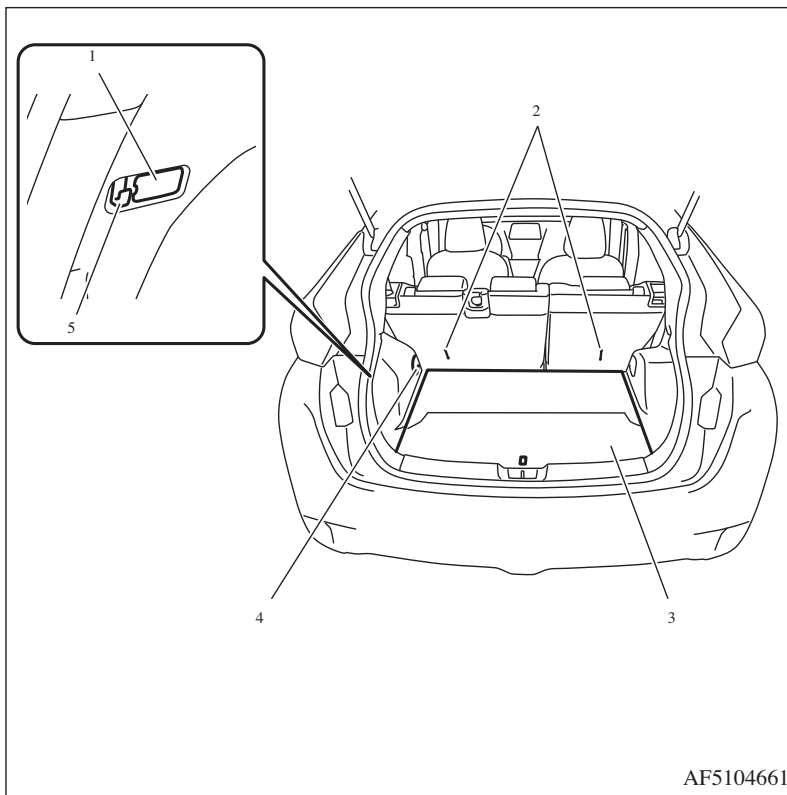

1. Luggage room lamp p. 7-82
2. Tether anchorages for child restraint system p. 4-23
3. Luggage floor board p. 7-89
Jack* p. 8-11
Tools* p. 8-11
Tyre repair kit* p. 8-13
4. Luggage hooks p. 7-88
5. Convenient hook p. 7-88

Outside (Front)

1

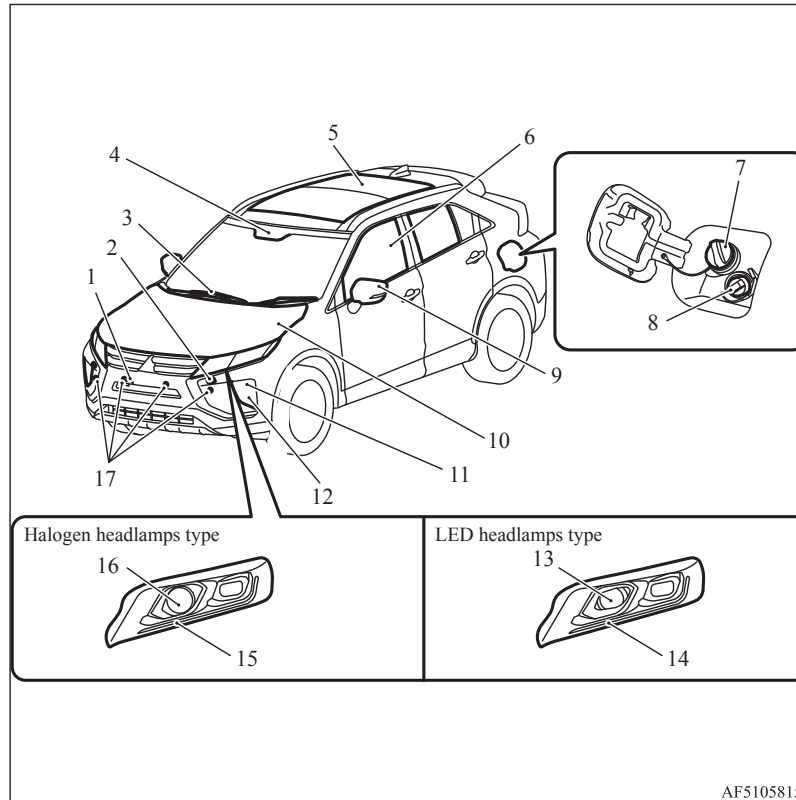

1. Front view camera* p. 6-131
2. Headlamp washer* p. 5-72
3. Windscreen wipers p. 5-68, 10-17
4. Sensor* [for Automatic High-Beam (AHB), Forward Collision Mitigation System (FCM) and Lane Departure Warning (LDW)] p. 5-59, 6-91, 6-113
Rain sensor p. 5-68
5. Power panoramic sunroof* p. 3-33
6. Electric window control p. 3-30
7. Fuel tank filler cap p. 2-03
8. AdBlue™ tank filler cap* p. 10-11
9. Outside rear-view mirrors p. 6-11
Side turn-signal lamps p. 5-65, 10-25
Side-view camera* p. 6-131
10. Bonnet p. 10-03
11. Front turn-signal lamps p. 5-65, 10-25, 10-28
12. Front fog lamps* p. 5-67, 10-25, 10-29
13. Headlamps, high/low beam p. 5-56, 10-25
14. Position lamps/Daytime running lamps p. 5-56, 5-58, 10-25
15. Position lamps/Daytime running lamps p. 5-56, 5-58, 10-25
16. Headlamps, high/low beam p. 5-56, 10-25, 10-27
17. Sensors* [for Ultrasonic misacceleration Mitigation System (UMS)] p. 6-106
Parking sensors* p. 6-124

Outside (Rear)

1 Outside (Rear)

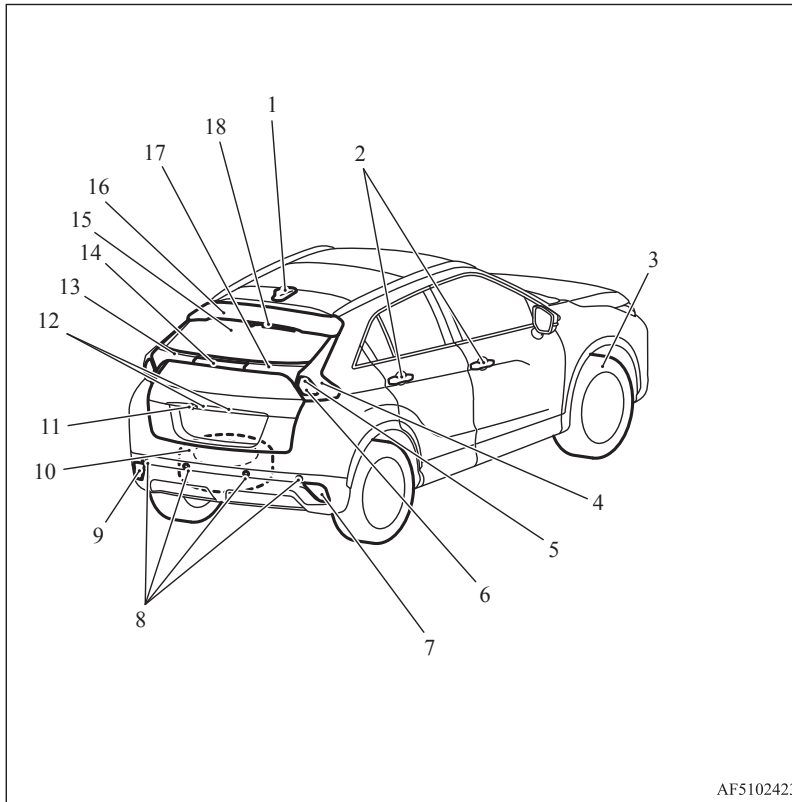

1. Antenna
2. Keyless entry system p. 3-04
Keyless operation system* p. 3-08
Locking and unlocking the doors p. 3-10
3. Tyre pressure monitoring system (TPMS)* p. 6-119
Changing tyres p. 8-19
Tyre p. 10-13
Tyre inflation pressures p. 10-13
Tyre rotation p. 10-15
Snow traction device (tyre chains) p. 10-16
Size of tyres and wheels p. 11-11
4. Tail lamps p. 5-56, 10-25
5. Stop lamps p. 10-25, 10-32
6. Rear turn-signal lamps p. 5-65, 10-25, 10-32
7. Rear fog lamp (RHD vehicles) p. 5-67, 10-25, 10-30
Reversing lamp (LHD vehicles) p. 10-25, 10-30
8. Sensors* [for Ultrasonic misacceleration Mitigation System (UMS)] p. 6-106
Parking sensors* p. 6-124
9. Reversing lamp (RHD vehicles) p. 10-25, 10-30
Rear fog lamp (LHD vehicles) p. 5-67, 10-25, 10-30
10. Spare wheel* p. 8-20
11. Rear-view camera* p. 6-128, 6-131
12. Licence plate lamps p. 10-25, 10-33
13. Rear spoiler
14. High-mounted stop lamp p. 10-25
15. Tailgate p. 3-21
16. Roof spoiler
17. Tail lamps* p. 10-25
18. Rear window wiper p. 5-71, 10-17

Quick guide

Locking and unlocking the doors and tailgate

Keyless entry system

Press the key switch, and all doors and the tailgate will be locked or unlocked as desired. The key switch will operate within approximately 4 m from the vehicle.

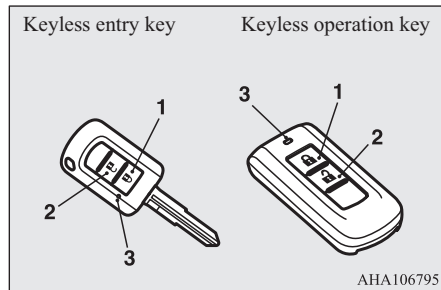

- 1- LOCK switch
- 2- UNLOCK switch
- 3- Indication lamp

Refer to “Keyless entry system” on page 3-04.

Keyless operation system*

When you are carrying the keyless operation key and within the operating range, if you press the driver’s or front passenger’s door lock/unlock switch (A), or the tailgate lock switch (B) (when locking) and the tailgate open switch (C) (when unlocking), the doors and the tailgate are locked/unlocked. The operating range is approximately 70 cm from the driver’s door lock/unlock switch, front passenger’s door lock/unlock switch, tailgate switches.

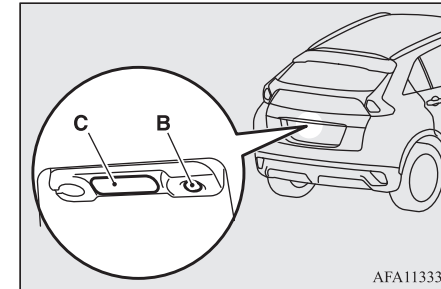
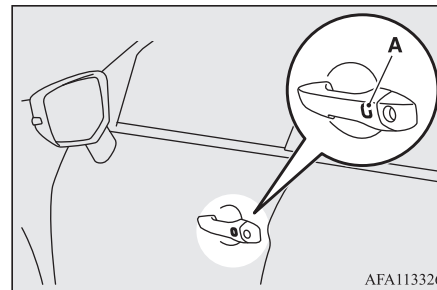

Refer to “Keyless operation system*” on page 3-08.

1 Around the driver's seat

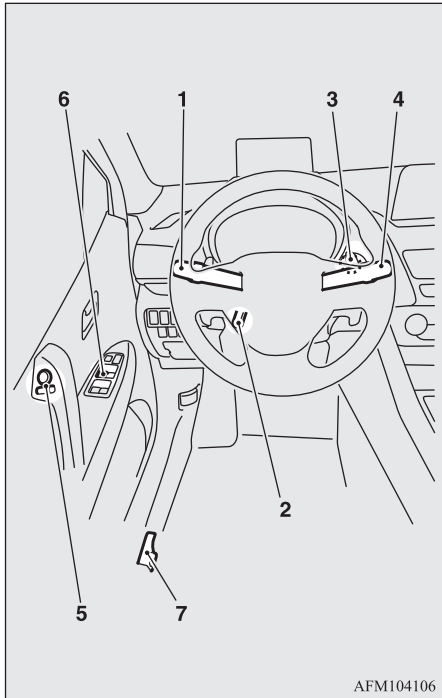

1-Combination headlamps

Rotate the switch to turn on the lamps.

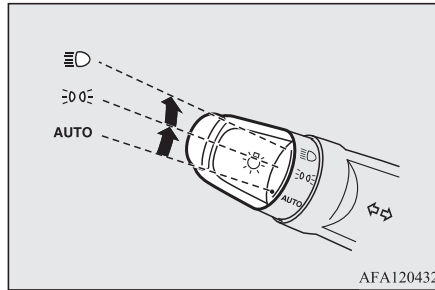

<p>AUTO</p>	<p>With the ignition switch or the operation mode is in ON, headlamps, position, tail, licence plate and instrument panel lamps turn on and off automatically in accordance with outside light level. (Daytime running lamps will be turned on while the tail lamps are off.) All lamps turn off automatically when the ignition switch is turned to the "LOCK" position or the operation mode is put in OFF.</p>
	<p>Position, tail, licence plate and instrument panel lamps on</p>



Headlamps and other lamps go on

Refer to "Combination headlamps and dipper switch" on page 5-56.

1-Turn-signal lever

The turn-signal lamps flash when the lever is operated

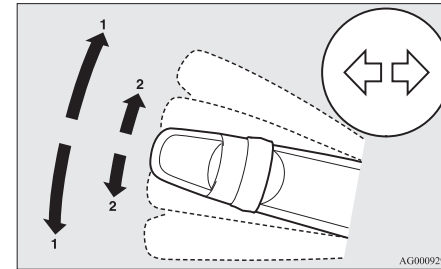

- 1- Turn-signals
- 2- Lane-change signals

Refer to "Turn-signal lever" on page 5-65.

2-Steering wheel height and reach adjustment

- 1. Release the lever while holding the steering wheel up.
- 2. Adjust the steering wheel to the desired position.

3. Securely lock the steering wheel by pulling the lever fully upward.

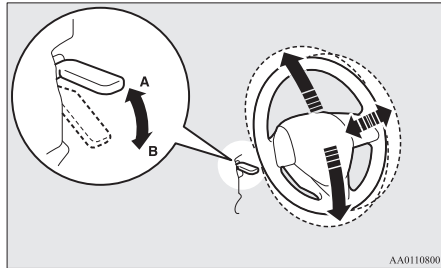

- A- Locked
- B- Release

Refer to “Steering wheel height and reach adjustment” on page 6-09.

3-Engine switch*

If you are carrying the keyless operation key, you can start the engine. If you press the engine switch without depressing the brake pedal (A/T or CVT) or the clutch pedal (M/T), you can change the operation mode in the order of OFF, ACC, ON, OFF.

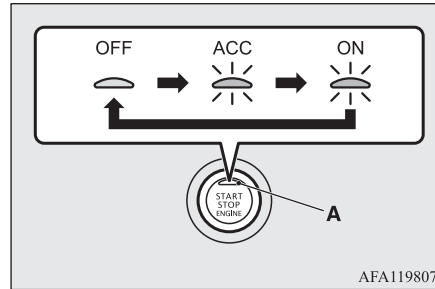

- OFF- The indication lamp (A) on the engine switch turns off.
- ACC- The indication lamp on the engine switch illuminates orange.
- ON- The indication lamp on the engine switch illuminates green.

Refer to “Engine switch” on page 6-15.

4-Wiper and washer switch

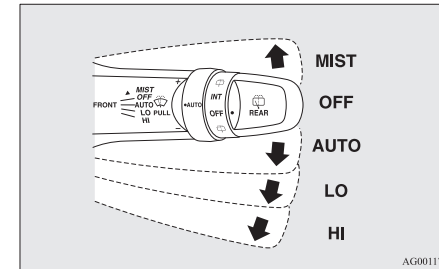

- MIST- Misting function
The wipers will operate once.
- OFF- Off
- AUTO- Auto-wiper control
Rain sensor
The wipers will automatically operate depending on the degree of wetness on the windscreen.
- LO- Slow
- HI- Fast

The washer fluid will be sprayed onto the windscreen by pulling the lever towards you.

Refer to “Wiper and washer switch” on page 5-68.

Quick guide

1 5-Outside rear-view mirrors

To adjust the mirror position

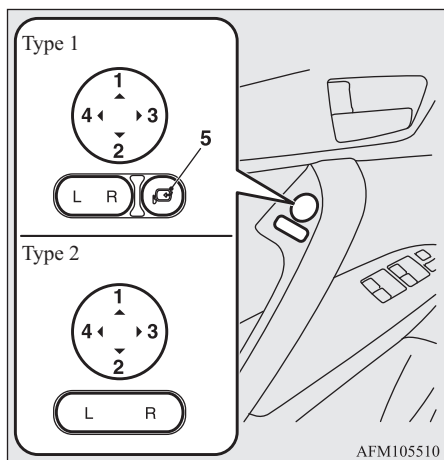

- L- Left outside mirror adjustment
- R- Right outside mirror adjustment
- 1- Up
- 2- Down
- 3- Right
- 4- Left
- 5- Mirror retractor switch

Refer to “Outside rear-view mirrors” on page 6-11.

6-Electric window control

Press the switch down for opening the window, and pull the switch for closing.

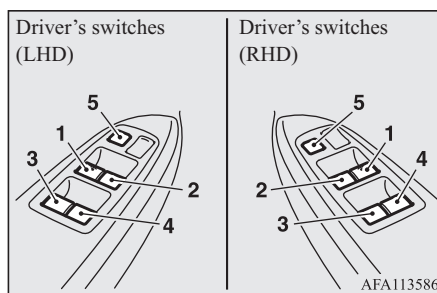

- 1- Driver's door window
- 2- Front passenger's door window
- 3- Rear left door window
- 4- Rear right door window
- 5- Lock switch

Lock switch

If you press the switch (5), the passenger's switches cannot be operated. To unlock, press it once again.

Refer to “Electric window control” on page 3-30.

7-Fuel tank filler door release lever

Open the fuel tank filler door. The fuel tank filler is located on the rear left side of your vehicle.

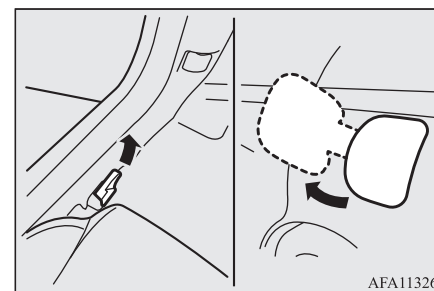

Refer to “Filling the fuel tank” on page 2-03.

8-speed Automatic transmission with Sports Mode* and INVECS-III CVT with 8-step Sports Mode*

Selector lever operation

The automatic transmission selects the optimum gear automatically and the CVT selects the optimum gear ratio automatically, depending on the speed of the vehicle and the position of the accelerator pedal.

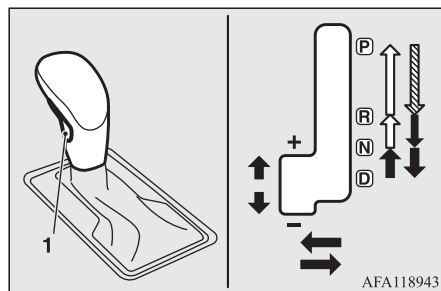

AFA118943

1. Lock button

	The lock button must be pushed while the brake pedal is depressed to move the selector lever.
	The lock button must be pushed to move the selector lever.
	The lock button need not be pushed to move the selector lever.

Selector lever positions

“P” PARK

This position locks the transmission to prevent the vehicle from moving. The engine can be started in this position.

“R” REVERSE

This position is to back up.

“N” NEUTRAL

At this position the transmission is disengaged.

“D” DRIVE

This position is for normal driving.

Refer to “8-speed Automatic transmission with Sports Mode” on page 6-36.

Refer to “INVECS-III CVT with 8-step Sports Mode” on page 6-43.

Multi information display

Always stop the vehicle in a safe place before operating.

The following information is included on the multi-information display: warnings, odometer, tripmeter, average and instant fuel consumption, average speed, etc.

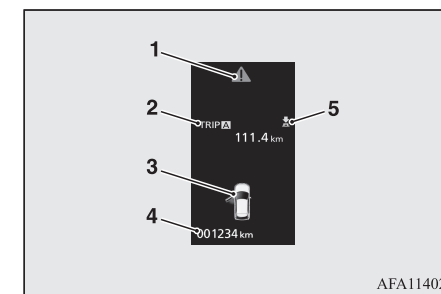

AFA114020

- 1- mark display screen → p. 5-06
- 2- Information screen → p. 5-04
Interrupt display screen → p. 5-06
- 3- Door ajar warning display screen → p. 5-07
- 4- Odometer → p. 5-08
- 5- "" mark indicator → p. 5-06

Refer to “Multi-information display” on page 5-02.

Quick guide

1 Head Up Display (HUD)*

The Head Up Display (HUD) shows information on a transparent display so that you can easily check meter information (vehicle speed, navigation instructions, etc.) while looking ahead when driving.

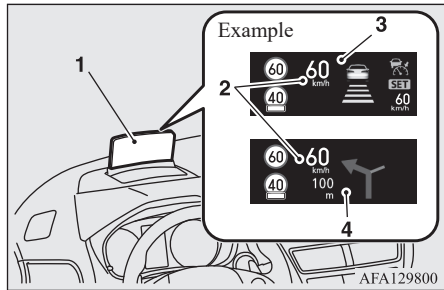

- 1- Display
- 2- Speed display screen
- 3- Information display screen
- 4- Navigation information display screen*

Refer to “Head Up Display (HUD)” on page 5-51.

S-AWC (Super-All Wheel Control)*

S-AWC is an integrated vehicle dynamics control system that helps enhance driving performance, cornering performance, and vehicle stability over a wide range of driving conditions through integrated management of the electronically controlled 4WD, the AYC, the ABS and the ASC.

S-AWC control mode	Function
AUTO	AUTO mode applied to dry pavement road and wet road, etc. This mode controls driving/ braking torque between front right and front left wheel and between front and rear wheel according to the driving condition, and achieves low fuel consumption and agile driving.
SNOW	This mode is chiefly suitable for the snow road. Stability improves on a slippery road.

S-AWC control mode	Function
GRAVEL	This mode is suitable mainly for driving on unpaved or rough roads. This mode provides 4WD high driving performance and stable cornering performance.

S-AWC drive mode-selector

The drive mode can be switched by pressing the switch while the ignition switch is in the “ON” position or the operation mode is in ON.

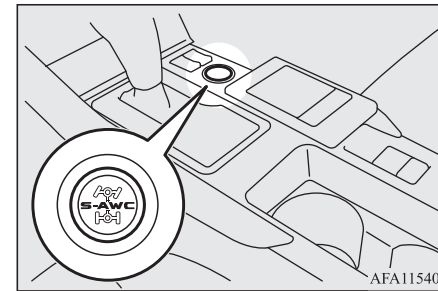

Refer to “S-AWC (Super-All Wheel Control)” on page 6-50.

General information

2

Fuel selection.....	2-02
Filling the fuel tank.....	2-03
Telematics Control Unit (TCU)*.....	2-05
Installation of accessories.....	2-11
Modification/alterations to the electrical or fuel systems.....	2-12
Genuine parts.....	2-12
Safety and disposal information for used engine oil.....	2-12
Disposal information for used batteries.....	2-12
Event Data Recording.....	2-13

OGKE20E1

Fuel selection

2

Fuel selection

Recommended
fuel

Petrol-powered vehicles

Unleaded petrol octane number (EN228)

[Except for vehicles for Russia, Kazakhstan, Belarus, Ukraine and Moldova]

95 RON or higher

[Vehicles for Russia, Kazakhstan, Belarus, Ukraine and Moldova]

90 RON or higher

Diesel-powered vehicles

Cetane number (EN590)
51 or higher

CAUTION

- For petrol-powered vehicles, the use of leaded fuel can result in serious damage to the engine and catalytic converter. Do not use leaded fuel.
- Diesel-powered vehicles are designed to use only diesel fuel that meets the EN 590 standard.
Use of any other type of diesel fuel (bio diesel, methyl ester, etc.) would adversely affect the engine's performance and durability.

NOTE

- Vehicles labelled "95 + OCTANE" have the knock control system so that you can use unleaded petrol 90 RON as an emergent measure in case unleaded petrol 95 RON or higher is not available on journey, etc.
In such a case, you don't need to adjust the engine specially. In case of using unleaded petrol 90 RON, the engine performance level is reduced.
- Due to the separation of paraffin, the fluidity of the fuel decreases considerably as the temperature falls.
Because of this fact there are two kinds of fuel: "summer" and "winter".
This must be considered in winter use.
Select either of the two kinds of fuel in accordance with ambient temperature.
Above -5 °C: "Summer" diesel
Below -5 °C: "Winter" diesel
When travelling abroad, find out in advance about the fuels served in local service stations.

NOTE

- In petrol-powered vehicles, repeatedly driving short distances at low speeds can cause deposits to form in the fuel system and engine, resulting in poor starting and poor acceleration. If these problems occur, you are advised to add a detergent additive to the petrol when you refuel the vehicle. The additive will remove the deposits, thereby returning the engine to a normal condition. Be sure to use a MITSUBISHI MOTORS GENUINE FUEL SYSTEM CLEANER. Using an unsuitable additive could make the engine malfunction. For details, please contact your MITSUBISHI MOTORS Authorized Service Point.
- Poor quality petrol can cause problems such as difficult starting, stalling, engine noise and hesitation. If you experience these problems, try another brand and/or grade of petrol.
If the check engine warning lamp flashes, have the system checked as soon as possible at a MITSUBISHI MOTORS Authorized Service Point.

NOTE

- In diesel-powered vehicles, poor-quality diesel fuel can cause deposits form in the injector, resulting in black smoke and rough idling.
If these problems occur, you are advised to add a cleaning additive to the diesel fuel when you refuel the vehicle. The additive will break up and remove the deposits, thereby returning the engine to a normal condition.
Be sure to use a MITSUBISHI MOTORS GENUINE DIESEL FUEL SYSTEM CLEANER. Using an unsuitable additive could make the engine malfunction. For details, please contact your MITSUBISHI MOTORS Authorized Service Point.

Graphical expression for consumer information

Identifier for petrol-type fuels



E5: Petrol fuel containing up to 2.7 % (m/m) oxygen or up to 5.0 % (V/V) ethanol – Eg. EN 228 compliant unleaded petrol

E10: Petrol fuel containing up to 3.7 % (m/m) oxygen or up to 10.0 % (V/V) ethanol – Eg. EN 228 compliant unleaded petrol
The petrol engine are compatible with E5 type petrol (containing 5 % ethanol) and E10 type petrol (containing 10 % ethanol) conforming to European standards EN 228.

CAUTION

- Do not use more than 10 % concentration of ethanol (grain alcohol) by volume. Use of more than 10 % concentration may lead to damage to your vehicle fuel system, engine, engine sensors and exhaust system.

Identifier for diesel-type fuels



B7: Diesel fuel containing up to 7.0 % (V/V) Fatty Acid Methyl Esters – Eg. EN 590 compliant diesel
The diesel engine are compatible with B7 type diesel (containing 7 % fatty acid methyl esters) conforming to European standards EN 590.

CAUTION

- Do not use more than 7 % concentration of fatty acid methyl esters (bio diesel) by volume. Use of more than 7 % concentration would adversely affect the engine's performance and durability.

Filling the fuel tank

WARNING

- When handling fuel, comply with the safety regulations displayed by garages and filling stations.
- Petrol is highly flammable and explosive. You could be burned or seriously injured when handling it. When refueling your vehicle, always turn the engine off and keep away from flames, sparks, and smoking materials. Always handle fuel in wellventilated outdoor areas.
- Before removing the fuel cap, be sure to get rid of your body's static electricity by touching a metal part of the vehicle or fuel pump. Any static electricity on your body could create a spark that ignites fuel vapour.

Filling the fuel tank

2

⚠ WARNING

- Perform the whole refueling process (opening the fuel tank filler door, removing the fuel cap, etc.) by yourself. Do not let any other person come near the fuel tank filler. If you allowed a person to help you and that person was carrying static electricity, fuel vapour could be ignited.
- Do not move away from the fuel tank filler until refueling is finished. If you moved away and did something else (for example, sitting on a seat) part-way through the refueling process, you could pick up a fresh charge of static electricity.
- If the tank cap must be replaced, use only a MITSUBISHI MOTORS genuine part.

Fuel tank capacity

2WD models: 63 litres

4WD models: 60 litres

Refueling

1. Before filling with fuel, stop the engine.
2. The fuel tank filler is located on the rear left side of your vehicle.

Open the fuel tank filler door by pulling the release lever located on the side of the driver's seat.

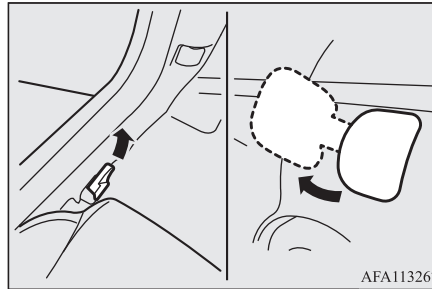

3. Open the fuel tank filler tube by slowly turning the cap anticlockwise.

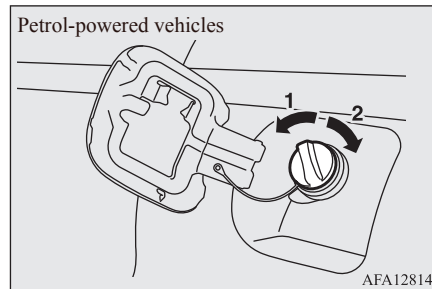

Diesel-powered vehicles

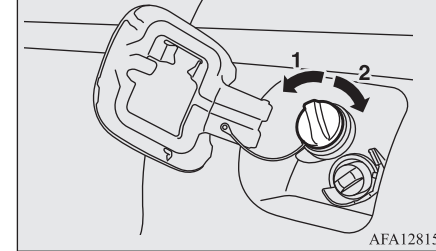

- 1- Remove
- 2- Close

⚠ CAUTION

- Since the fuel system may be under pressure, remove the fuel tank filler tube cap slowly. This relieves any pressure or vacuum that might have built up in the fuel tank. If you hear a hissing sound, wait until it stops before removing the cap. Otherwise, fuel may spray out, injuring you or others.

NOTE

- While filling with fuel, store the fuel cap in the cap holder (A) or hang it on the hook (B) located on the inside of the fuel tank filler door.

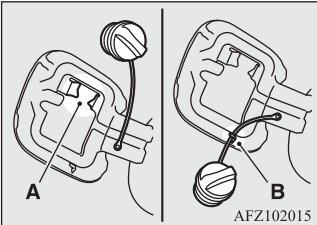

AFZ102015

- The cap shown in the illustration is the AdBlue™ tank filler cap. To replenish AdBlue™, refer to “Urea SCR system (AdBlue™-related system)*” on page 6-28 and “AdBlue™ replenishment*” on page 10-11. AdBlue™: trademark of the Verband der Automobilindustrie e.V. (VDA).

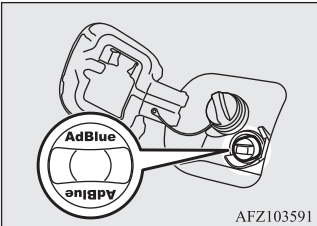

AFZ103591

4. Insert the gun in the tank port as far as it goes.

CAUTION

- Do not tilt the gun.

5. When the gun stops automatically, do not fill with fuel any more.
6. To close, turn the fuel cap slowly clockwise until you hear clicking sounds, then gently push the fuel tank filler door closed.

Telematics Control Unit (TCU)*

The Telematics Control Unit (TCU) uses a mobile communication network to transmit notifications (SOS emergency assistance/ Information assistance) in case of emergency and vehicle information. The TCU also allows you to use your smartphone to operate some vehicle functions remotely.

NOTE

- To use the TCU, a user service agreement is necessary. In addition, you must install the smartphone app, agree to the terms of service, and register as a user before using the TCU. For details including system limitations, contact a MITSUBISHI MOTORS Authorized Service Point.
- Some of the remote operations can be performed from the owner portal as well. You must register as a user beforehand. <https://www.mitsubishi-connect.eu/>
- After you sign a user service agreement for the TCU, you will be able to use the telematics features on the smartphone app and call centre service.

2

SOS emergency assistance/ Information assistance

SOS emergency assistance

If a collision is detected or you press the SOS switch (A), the system automatically transmits the vehicle information to an emergency call centre, and will call the emergency call centre. If necessary, the telephone call is forwarded to a PSAP (Public Safety Answering Point).

Telematics Control Unit (TCU)*

2

● Information assistance

If you press the information switch (B), you will be connected to the call centre and your vehicle information will automatically be transmitted to the call centre. In the case of a breakdown, your telephone call will be forwarded to roadside assistance.

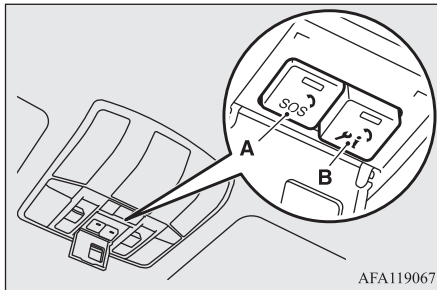

- A- SOS switch
- B- Information switch

⚠ WARNING

- In a country or area where no emergency call centre is available for the TCU, or where radio waves for the emergency call cannot be transmitted or received normally, the system will not operate. In this case, use a cellular phone, etc., to call directly for an emergency vehicle or road service.

⚠ WARNING

- If an emergency occurs and you smell fuel or another unusual odour, do not stay inside the vehicle. Exit the vehicle immediately and move to a safe location.
- While waiting for rescue after making the emergency call, take actions to prevent a rear-end collision or other secondary accident and move to a safe location away from the vehicle and traffic.
- In the following cases, use a cellular phone, etc., to call directly for an emergency vehicle or road service.
 - When the system does not operate due to a malfunction because of a collision, etc.
 - When the vehicle is in a place where radio waves cannot be transmitted or received, such as indoors, in an underground parking structure, in a mountainous area, or in a tunnel.
 - When the line to the emergency call centre is busy and the call cannot reach the emergency call centre.

📖 NOTE

- This system transmits a notification to an emergency call centre, but it does not directly arrange for an emergency vehicle or road service.

Flow of the SOS emergency assistance/Information assistance

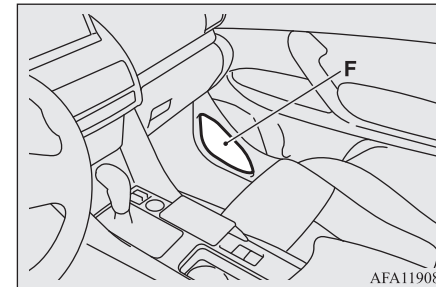
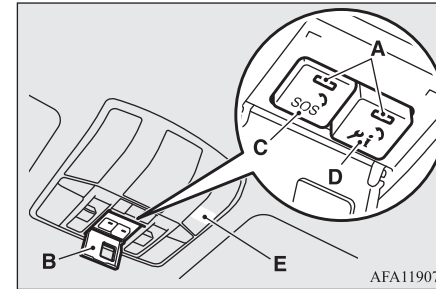

- A- Indication lamp (red/green)
- B- Cover
- C- SOS switch
- D- Information switch
- E- Microphone
- F- Door speaker (only front passenger side)

⚠ WARNING

- Do not remove or modify the above parts. This can cause the system to not operate.

📖 NOTE

- Although the information switch (D) is not for use in emergencies, the operation is the same as the operation of the SOS switch (C) for SOS emergency assistance.

1. After setting the operation mode to ON, the indication lamps (A) illuminate for approximately 10 seconds. When approximately 10 seconds have elapsed after the lamps extinguish, the system is in the standby state.

⚠ WARNING

- If the indication lamps (A) do not illuminate after setting the operation mode to ON, there is a possible problem in the system. Have the system inspected by a MITSUBISHI MOTORS Authorized Service Point.

⚠ WARNING

- If the indication lamps (A) remain illuminated or illuminate again after setting the operation mode to ON, there is a possible problem in the system or the battery for exclusive use of the TCU may be exhausted. The battery life is approximately 3 years. Have the system inspected or the battery replaced at a MITSUBISHI MOTORS Authorized Service Point.
- When the system is not in the standby state, the system does not operate. When you drive, make sure to check that the system is in the standby state.

📖 NOTE

- Even if the SOS emergency assistance is in the standby state, communication may not be possible for a while depending on the radio wave conditions.

2. The system operates as follows.
[Automatic Report]
If your vehicle's airbags deploy or if the unit detects that the vehicle was in a severe collision, your vehicle automatically will attempt to connect to the emergency call centre operator. Once connected, information about your vehicle, its location, and its condition will be sent to the operator; you also can speak to the operator when connected.

[Manual Report]
When you open the cover (B) and press the SOS switch (C).

2

⚠ WARNING

- Before pressing the SOS switch (C), stop the vehicle in a safe place. If you operate it while driving, your attention to the surrounding conditions may be affected, resulting in an accident.

⚠ CAUTION

- Do not open the cover unless you intend to press the SOS switch (C). You may press the SOS switch (C) by mistake. In addition, if the cover is left open while driving, the cover can cause injury in the event of an accident.

📖 NOTE

- Do not press the SOS switch (C) unless there is an emergency such as an accident or sudden illness. If an emergency vehicle, etc. is dispatched unnecessarily, you may be charged.

3. The green indication lamp blinks and the system calls the emergency call centre.

Telematics Control Unit (TCU)*

2

⚠ WARNING

- If the red indication lamp illuminates as follows, directly arrange an emergency vehicle or road service with a cellular phone, etc.
 - When the red indication lamp remains illuminated. (There is a possible problem in the system.)
 - When the red indication lamp illuminates for 60 seconds. (The vehicle may be in a place where radio waves cannot be transmitted and received.)

4. The green indication lamp blinks slowly, and the location and vehicle information is transmitted to the emergency call centre.

5. When the green indication lamp changes from a blinking state to an illuminated state a conversation with an operator of the emergency call centre is available.

⚠ WARNING

- Do not replace the speakers. If they are replaced, the voice of the operator at the emergency call centre may not be audible. If the speakers need to be replaced due to a problem, etc., we recommend you to consult a MITSUBISHI MOTORS Authorized Service Point.
- An error may occur between the actual report point and the point reported to the emergency call centre. Mutually confirm the report point and the object through the phone call with the operator of the emergency call centre.

📖 NOTE

- If the vehicle side microphone (E) and/or the speakers fail, you cannot talk with the operator of the emergency call centre.
- An emergency call cannot be disconnected from the vehicle side.

6. The emergency call centre arranges for dispatch of the emergency vehicle as required.

Indicator list

Situation	Indication lamp		Cause	Solution
	Red lamp	Green lamp		
When changing the operation mode to ON	Illuminates (for approximately 10 seconds)	Extinguishes	The system check is in progress.	Wait for a while. The indication lamps go off when the system check is complete. If the indication lamps do not illuminate, there is a possible problem in the system. In this case, immediately have the system inspected at a MITSUBISHI MOTORS Authorized Service Point.

Telematics Control Unit (TCU)*

2

Situation	Indication lamp		Cause	Solution
	Red lamp	Green lamp		
After approximately 10 seconds after changing the operation mode to ON	Extinguishes	Extinguishes	The system works normally	—
	Illuminates	Extinguishes	There is a possible problem in the system or the battery may be exhausted.	Immediately have the system inspected at a MITSUBISHI MOTORS Authorized Service Point.
While the SOS emergency assistance/Information assistance is activated	Extinguishes	Fast blinking	<ul style="list-style-type: none"> ● The system calls the emergency call centre. ● The system transmits the location and vehicle information to the emergency call centre. 	—
	Extinguishes	Slow blinking	A conversation with an operator of the emergency call centre is available.	Mutually confirm the details of the SOS emergency assistance/Information assistance with the operator of the emergency call centre. If the green lamp does not extinguish even after the call ends, have the system inspected at a MITSUBISHI MOTORS Authorized Service Point.
When the SOS emergency assistance/Information assistance failed	Illuminates (for approximately 60 seconds)	Extinguishes	The SOS emergency assistance/Information assistance failed.	Activate SOS emergency assistance/Information assistance again, or directly arrange an emergency vehicle or road service with the nearest public telephone, etc.

Remote control

2

NOTE

- To operate the remote control functions from a smartphone or to receive notifications using the smartphone, you must install the smartphone app and register as a user beforehand.
- Some of the remote operations can be performed from the owner portal as well. You must register as a user beforehand.
<https://www.mitsubishi-connect.eu/>
- The remote operation functions, other than the alert notification, cannot be activated if the vehicle engine is not started for 5 or more consecutive days.

- **Alarm notification (if so equipped)**
When the vehicle's security alarm system is activated, an alert is sent to the smartphone using a short message service (SMS), e-mail, or push notification.
- **Remote door lock/unlock (if so equipped)**
The vehicle doors and tailgate can be locked and unlocked using the smartphone app and the owner portal.

NOTE

- Remote door lock/unlock service is not available on vehicles equipped with the alarm notification service.
- If the doors and the tailgate are unlocked using the smartphone app and the owner portal when no doors or the tailgate are opened within a certain length of time, the doors and the tailgate will automatically re-lock.
- Be sure to have the keyless operation key with you before locking the vehicle. It is possible to lock/unlock the vehicle even when the keyless operation key is inside the vehicle. If the smartphone app cannot be used for some reason (e.g., your smartphone battery becomes discharged), you need the keyless operation key in order to unlock the vehicle.
- When the vehicle is locked or unlocked, the power-folding outside rear-view mirrors operate.

- **Car finder**
The location of the parked vehicle can be confirmed using the smartphone app.
- **Remote horn**
You can make the horn sound using the smartphone app.
- **Remote lights**
The lamps can be turned on using the smartphone app.

NOTE

- The remote lights turn off automatically after approximately 30 seconds.

- **Speed alert**
If you set a vehicle speed limit beforehand using the smartphone app and the owner portal, an alert is sent to the smartphone app when the vehicle speed exceeds that limit.
- **Geofence alert**
If the specified area is set beforehand using the smartphone app, an alert is sent to the smartphone using a short message service (SMS), e-mail, or push notification when the vehicle enters or leaves that area.
- **Curfew alert**
If the specified time of day is set beforehand using the smartphone app and the owner portal, an alert is sent to the smartphone using a short message service (SMS), e-mail, or push notification when the curfew is violated.
- **Vehicle settings**
You can change settings of items such as "Auto Fold Mirrors" and "Headlamp Timeout when Exiting Vehicle" from the smartphone app and the owner portal.

- **Vehicle Status Report (VSR)**

The vehicle communication and information regarding malfunctions can be transmitted using the TCU so that the condition of the vehicle can be checked remotely.

- **Over The Air Update**

When software and firmware updates are available, notifications via SMS will be sent to you to install the updates.

You can also check for available updates manually.

Installation of accessories

We recommend you to consult your MITSUBISHI MOTORS Authorized Service Point.

⚠ CAUTION

- Your vehicle is equipped with a diagnosis connector for checking and servicing the electronic control system.

Do not connect a device other than a diagnosis tool for inspections and service to this connector. Otherwise, the battery could be discharged, the electronic devices of the vehicle could malfunction, or other unexpected problems could result.

In addition, malfunctions caused by connecting a device other than a diagnosis tool may not be covered under warranty.

- The installation of accessories, optional parts, etc., should only be carried out within the limits prescribed by law in your country, and in accordance with the guidelines and warnings contained within the documents accompanying this vehicle.

- Installing electric components incorrectly could lead to a fire. See the “Modification/ alterations to the electrical or fuel systems” section within this owner’s manual.

- When installing the radio, for the required information (frequency, transmission output, installing procedure), consult a MITSUBISHI MOTORS Authorized Service Point.

If the frequency, transmission output and installing condition are not appropriate, it can adversely affect the electronic devices and could lead to unsafe vehicle operation.

- Using a cellular phone or radio set inside the vehicle without an external antenna may cause electrical system interference, which could lead to unsafe vehicle operation.
- Tyres and wheels which do not meet specifications must not be used. Refer to the “Specifications” section for information regarding wheel and tyre sizes.

Important points!

Due to large number of accessory and replacement parts of different manufactures available in the market, it is not possible, not only for MITSUBISHI MOTORS, but also for a MITSUBISHI MOTORS Authorized Service Point, to check whether the attachment or installation of such parts affects the overall safety of your vehicle.

Even when such parts are officially authorized, for example by a “general operators permit” (an appraisal for the part) or through the execution of the part in an officially approved manner of construction, or when a single operation permit following the attachment or installation of such parts, it cannot be deduced from that alone, that the driving safety of your vehicles has not been affected.

Consider also that there basically exists no liability on the part of the appraiser or the official. Maximum safety can only be ensured with parts recommended, sold and fitted or installed by a MITSUBISHI MOTORS authorized Service Point (MITSUBISHI MOTORS GENUINE replacement parts and MITSUBISHI MOTORS accessories). The same also pertains to modifications of vehicles with respect to the production specifications. For safety reasons, do not attempt any modifications other than those that follow the recommendations of a MITSUBISHI MOTORS authorized Service Point.

2

Modification/alterations to the electrical or fuel systems

MITSUBISHI MOTORS CORPORATION has always manufactured safe, high quality vehicles. In order to maintain this safety and quality, it is important that any accessory that is to be fitted, or any modifications carried out which involve the electrical or fuel systems, should be carried out in accordance with MITSUBISHI MOTORS guidelines.

CAUTION

- If the wires interfere with the vehicle body or improper installation methods are used (protective fuses not included, etc.), electronic devices may be adversely affected, resulting in a fire or other accident.

Genuine parts

MITSUBISHI MOTORS has gone to great lengths to bring you a superbly crafted automobile offering the highest quality and dependability.

Use MITSUBISHI MOTORS GENUINE Parts, designed and manufactured to maintain your MITSUBISHI MOTORS automobile at top performance. MITSUBISHI MOTORS GENUINE Parts are identified by this mark and are available at all MITSUBISHI MOTORS Authorized Service Points.

**MITSUBISHI MOTORS
GENUINE PARTS**

Safety and disposal information for used engine oil

WARNING

- Prolonged and repeated contact may cause serious skin disorders, including dermatitis and cancer.
- Avoid contact with the skin as far as possible and wash thoroughly after any contact.
- Keep used engine oils out of reach of children.

Protect the environment

It is illegal to pollute drains, water courses and soil. Use authorized waste collection facilities, including civic amenity sites and garages providing facilities for disposal of used oil and used oil filters. If in doubt, contact your local authority for advice on disposal.

Disposal information for used batteries



Your vehicle contains batteries and/or accumulators.

Do not mix with general household waste.

For proper treatment, recovery and recycling of used batteries, please take them to applicable collection points, in accordance with your national legislation and the Directives 2006/66/EC.

By disposing of these batteries correctly, you will help to save valuable resources and prevent any potential negative effects on human health and the environment which could otherwise arise from inappropriate waste handling.

Event Data Recording

This vehicle is equipped with an event data recorder (EDR).

The main purpose of an EDR is to record, in certain crash or near crash-like situations, such as an airbag deployment or hitting a road obstacle, data that will assist in understanding how a vehicle's systems performed.

The EDR is designed to record data related to vehicle dynamics and safety systems for a short period of time, typically 30 seconds or less.

The EDR in this vehicle is designed to record such data as:

- How various systems in your vehicle were operating;
- How far (if at all) the driver was depressing the accelerator and/or brake pedal; and,
- How fast the vehicle was travelling.

These data can help provide a better understanding of the circumstances in which crashes and injuries occur.

NOTE

- EDR data are recorded by your vehicle only if a non-trivial crash situation occurs; no data are recorded by the EDR under normal driving conditions and no personal data (e.g., name, gender, age, and crash location) are recorded. However, other parties, such as law enforcement, could combine the EDR data with the type of personally identifying data routinely acquired during a crash investigation.

To read data recorded by an EDR, special equipment is required, and access to the vehicle or the EDR is needed. In addition to the vehicle manufacturer, other parties, such as law enforcement, that have the special equipment, can read the information if they have access to the vehicle or the EDR.

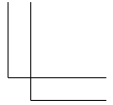
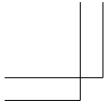

Handwriting practice lines consisting of 12 horizontal dashed lines.

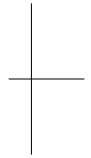
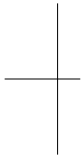

OGKE20E1

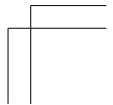
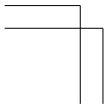

Locking and unlocking

3

Keys.....	3-02
Electronic immobilizer (Anti-theft starting system).....	3-03
Keyless entry system.....	3-04
Keyless operation system*.....	3-08
Doors.....	3-16
Central door locks.....	3-18
Dead Lock System*.....	3-19
“Child-protection” rear doors.....	3-20
Tailgate.....	3-21
Security alarm system*.....	3-23
Electric window control.....	3-30
Power panoramic sunroof*.....	3-33

OGKE20E1

Keys

Keys

The key fits all locks.

3

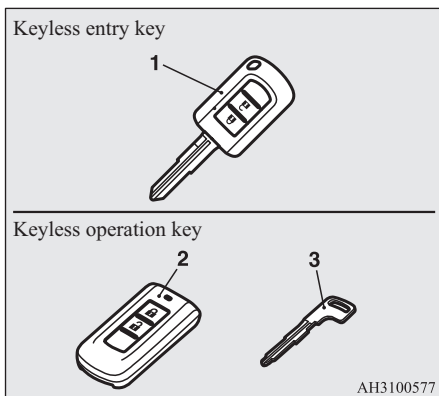

- 1- Keyless entry key
- 2- Keyless operation key
- 3- Emergency key

WARNING

- When taking a key on flights, do not press any switches on the key while on the plane. If a switch is pressed on the plane, the key emits electromagnetic waves, which could adversely affect the plane's flight operation. When carrying a key in a bag, be careful that no switches on the key can be easily pressed by mistake.

NOTE

- The key (except for the emergency key) is a precision electronic part with a built-in signal transmitter. Please observe the following in order to prevent a malfunction.
 - Do not leave in a place that is exposed to direct sunlight, for example on the dashboard.
 - Do not disassemble or modify.
 - Do not excessively bend the key or subject it to strong impacts.
 - Do not expose to water.
 - Keep away from magnetic key rings.
 - Keep away from audio systems, personal computers, TVs, and other equipment that generates a magnetic field.
 - Keep away from devices that emit strong electromagnetic waves, such as cellular phones, wireless devices and high frequency equipment (including medical devices).

NOTE

- Do not clean with ultrasonic cleaners or similar equipment.
- Do not leave the key where it may be exposed to high temperature or high humidity.
- The engine is designed so that it will not start if the ID code registered in the immobilizer computer and the key's ID code do not match. Refer to the "Electronic immobilizer" section for details and key usage.
- [For vehicles equipped with the security alarm system]
Pay attention to the following if the security alarm is set to "Active".
Refer to "Security alarm system*" on page 3-23.
 - If the security alarm is in the system armed mode, the alarm will sound if the doors are opened after being unlocked with the key, the inside lock knob or the central door lock switch.
 - Even if the security alarm is set to "Active", the system preparation mode is not entered if the keyless entry system or the keyless operation function was not used to lock the vehicle.

Key number tag

The key number is stamped on the tag as indicated in the illustration.

Electronic immobilizer (Anti-theft starting system)

Make a record of the key number and store the key and key number tag in separate places, so that you can order a key from your MITSUBISHI MOTORS Authorized Service Point in the event the original keys are lost.

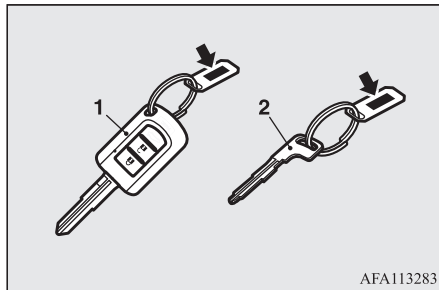

1. Keyless entry key
2. Emergency key

Electronic immobilizer (Anti-theft starting system)

⚠ CAUTION

- Do not modify or add parts to the immobilizer system. Doing so could cause the immobilizer to malfunction.

The electronic immobilizer is designed to significantly reduce the possibility of vehicle theft. The purpose of the system is to immobilize the vehicle if an invalid start is attempted. A valid start attempt can only be achieved by using a key “registered” to the immobilizer system.

NOTE

- In the following cases, the vehicle may not be able to receive the registered ID code from the registered key and the engine may not start. (vehicles equipped with the keyless entry system)
 - When the key contacts a key ring or other metallic or magnetic object

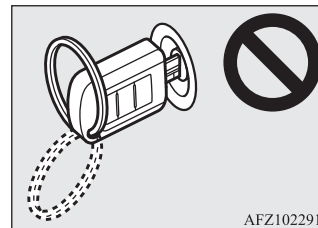

NOTE

- When the key grip contacts metal of another key

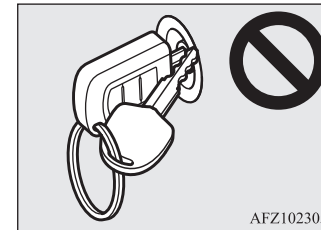

- When the key contacts or is close to other immobilizing keys (including keys of other vehicles)



In cases like these, remove the object or additional key from the vehicle key. Then try again to start the engine. If the engine does not start, we recommend you to contact your MITSUBISHI MOTORS Authorized Service Point.

3

Keyless entry system

NOTE

3

- If the engine does not start, we recommend you to contact your MITSUBISHI MOTORS Authorized Service Point. (vehicles equipped with the keyless operation system)
- If you lose one of them, contact a MITSUBISHI MOTORS Authorized Service Point as soon as possible. To obtain a replacement or extra spare key, take your vehicle and all remaining keys to your MITSUBISHI MOTORS Authorized Service Point. All the keys have to be re-registered in the immobilizer computer unit. The immobilizer can register as follows.
 - Keyless entry key: up to eight different keys
 - Keyless operation key: up to four different keys

Keyless entry system

Press the key switch, and all doors and the tailgate will be locked or unlocked as desired. It is also possible to operate the outside rear-view mirrors. (vehicles equipped with the mirror retractor switch)

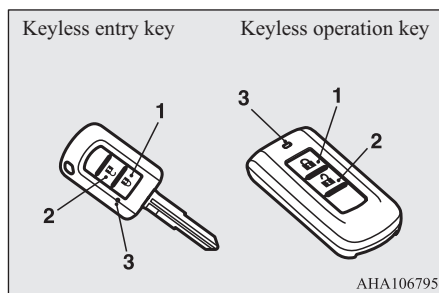

- 1- LOCK switch
- 2- UNLOCK switch
- 3- Indication lamp

To lock

Press the LOCK switch (1). All the doors and the tailgate will be locked. The turn-signal lamps will blink once when the doors and the tailgate are locked.

To unlock

Press the UNLOCK switch (2). All the doors and the tailgate will be unlocked. If the doors and tailgate are unlocked when the front or the rear room lamp switch is in the “☺” or the “•” position, the room lamp will illuminate for approximately 15 seconds and the turn-signal lamps will blink twice.

The position and tail lamps can also be set to turn on for approximately 30 seconds. Refer to “Instruments and controls: Welcome light” on page 5-62.

NOTE

- Except for vehicles equipped with a Dead Lock System, the door and tailgate unlock function can be set so that only the driver’s door unlocks when the UNLOCK switch (2) is pressed once.
If the door and tailgate unlock function is set to work as described above, all the doors and the tailgate unlock when the UNLOCK switch is pressed two times in succession. Refer to “Setting of door and tailgate unlock function (except for vehicles equipped with a Dead Lock System)” on page 3-06.

NOTE

- On vehicles equipped with the mirror retractor switch, the outside rear-view mirrors automatically retract or extend when all the doors and tailgate are locked or unlocked using the key switches of the keyless entry system.
Refer to “Starting and driving: Outside rear-view mirrors” on page 6-11.
- If the UNLOCK switch (2) is pressed and no door or tailgate is opened within approximately 30 seconds, relocking will automatically occur.
- It is possible to modify functions as follows:
For further information, please contact your MITSUBISHI MOTORS Authorized Service Point.
On vehicles equipped with the Smartphone Link Display Audio or the MITSUBISHI Multi-Communication System (MMCS), screen operations can be used to make the adjustment. Refer to the separate owner’s manual for details.
 - The time for automatic relocking can be changed.
 - The confirmation function (flashing of the turn-signal lamps) can be set to operate only when the doors and backdoor are locked or only when the doors and backdoor are unlocked.
 - The confirmation function (this indicates locking or unlocking of the doors and tailgate with the blink of the turn-signal lamps) can be deactivated.

NOTE

- The number of times the turn-signal lamps are flashed by the confirmation function can be changed.
- The keyless entry system does not operate in the following conditions:
 - The key is left in the ignition switch. (except for vehicles equipped with the keyless operation system)
 - The operation mode is not in OFF. (vehicles equipped with the keyless operation system)
 - The LOCK switch (1) is pressed while a door or the tailgate is open.
- The key switch will operate within approximately 4 m from the vehicle. However, the operating range of the key switch may change if the vehicle is located near a power station, or radio/TV broadcasting station.
- If either of the following problems occurs, the battery may be exhausted.
 - The key switch is operated at the correct distance from the vehicle, but the doors and tailgate are not locked/unlocked in response.
 - The indication lamp (3) is dim or does not come on.
 For further information, please consult your MITSUBISHI MOTORS Authorized Service Point.
If you replace the battery yourself, refer to “Procedure for replacing the key battery” on page 3-07.
- If your key is lost or damaged, please contact your MITSUBISHI MOTORS Authorized Service Point for a replacement key.

NOTE

- If you wish to add a key, we recommend you to contact your MITSUBISHI MOTORS Authorized Service Point.
The below keys are available for your vehicle.
 - Keyless entry key: up to eight different keys
 - Keyless operation key: up to four different keys

3**Operation of the Dead Lock System***

With a vehicle that has a Dead Lock System, it is possible to set the Dead Lock System by pressing the LOCK switch (1) two times. Refer to “Dead Lock System” on page 3-19.

Operation of the outside rear-view mirrors (vehicles equipped with mirror retractor switch)**To retract**

Locking the doors and tailgate using the LOCK switch (1), the outside rear-view mirrors are retracted automatically.

Keyless entry system

To extend

Unlocking the doors and tailgate using the UNLOCK switch (2), the outside rear-view mirrors are extended automatically.

3

NOTE

● Functions can be modified as stated below. Please consult a MITSUBISHI MOTORS Authorized Service Point.

In a vehicle equipped with the Smartphone Link Display Audio or the MITSUBISHI Multi-Communication System (MMCS), it is possible to change the setting by means of screen operations. Refer to the separate owner's manual for details.

- Automatically extend when the driver's door is closed and the ignition switch is turned to the "ON" position or the operation mode is put in ON. In addition, automatically retract when the ignition switch is turned to the "LOCK" or "ACC" position or the operation mode is put in OFF or ACC, and the driver's door is then opened.
- Automatically extend when the vehicle speed reaches approximately 30 km/h (16 mph).
- Deactivate the automatic extension function.

Setting of door and tailgate unlock function (except for vehicles equipped with a Dead Lock System)

The door and tailgate unlock function can be set to the following two conditions.

Each time the door and tailgate unlock function is set, a chime will sound to tell you the condition of the door and tailgate unlock function.

Number of chimes	Condition
One chime	When the UNLOCK switch (2), driver's or front passenger's door lock/unlock switch, or tailgate open switch is pressed one time, all doors and the tailgate unlock. [Factory setting]
Two chimes	When the UNLOCK switch (2) or the driver's door lock/unlock switch is pressed one time, only the driver's door unlocks. When the UNLOCK switch or the driver's door lock/unlock switch is pressed two times in succession, all doors and the tailgate unlock.

- Turn the ignition switch to the "LOCK" position and then remove the key (except for vehicles equipped with the keyless operation system), or put the operation mode in OFF (vehicles equipped with the keyless operation system).
- Place the lamp switch in the "AUTO" position, and leave the driver's door open.
- Perform the following steps. Steps ii to iv should be completed within 8 seconds.

Step i:

Press and hold the LOCK switch (1) for 4 to 8 seconds.



Step ii:

While holding the LOCK switch (1), press the UNLOCK switch (2).



Step iii:

While holding the UNLOCK switch (2), release the LOCK switch (1).



Step iv:
Release the UNLOCK switch (2).



NOTE

- The number of chimes indicates the current setting.
- Be sure to press the switches correctly when performing the procedures. If you perform the procedures incorrectly, the setting can be changed unintentionally.
- On vehicles equipped with the Smartphone Link Display Audio or the MITSUBISHI Multi-Communication System (MMCS), screen operations can be used to make the adjustment. Refer to the separate owner's manual for details.

Procedure for replacing the key battery

Before replacing the battery, remove static electricity from your body by touching a metal grounded object.

WARNING

- Do not swallow a coin type battery.

WARNING

- This product contains a coin type battery. If a coin type battery is swallowed, it can cause severe internal burns and can lead to death.
There have been cases where a swallowed battery has caused severe internal burns in just 2 hours.
- Keep new and used batteries away from children.
- If the key case does not close securely, stop using the product and keep it away from children.
- If you think batteries might have been swallowed or placed inside any part of a person's body, seek immediate medical attention.
- To prevent that can result in an explosion or the leakage of flammable liquid or gas.
 - Do not replace an incorrectly battery. Replace only with the same battery or an equivalent type.
 - Do not dispose of a battery into fire or incinerator, or mechanically crushing or cutting a battery.
 - Do not use, store in or bring into a battery where it may be exposed to extremely high temperature or extremely low air pressure.

CAUTION

- When the key case is opened, be careful to keep water, dust, etc. out. Also, do not touch the internal components.

CAUTION

- Dispose of used batteries according to regulations for the disposal of battery.

NOTE

- You may purchase a replacement battery at an electric appliance store.
- A MITSUBISHI MOTORS Authorized Service Point can replace the battery for you if you prefer.

1. Remove the screw (A) from the key. (Keyless entry key only)

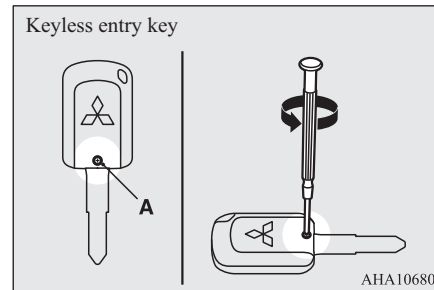

2. Remove the emergency key from the key. (Keyless operation key only)
Refer to "Emergency key" on page 3-16.
3. With the MITSUBISHI mark facing you, insert the cloth-covered tip of a straight

3

Keyless operation system*

blade (or minus) screwdriver into the notch in the key case and use it to open the case.

3

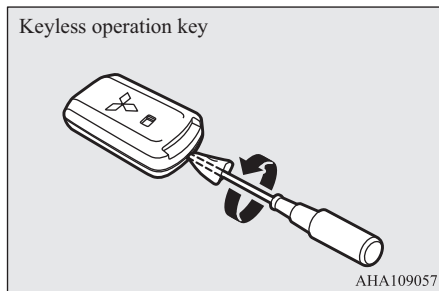
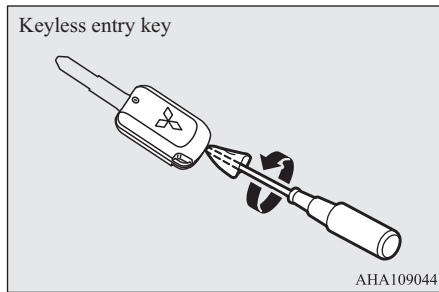

NOTE

- Be sure to perform the procedure with the MITSUBISHI mark facing you. If the MITSUBISHI mark is not facing you when you open the key case, the switches may come out.

3-08 Locking and unlocking

4. Remove the used battery.
5. Install a new battery with the + side (B) up.

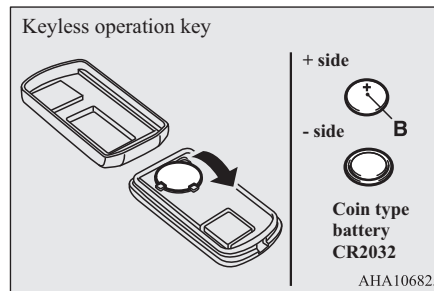
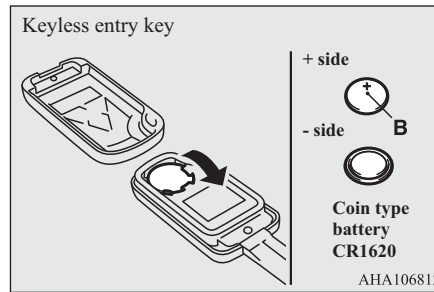

6. Close the key case firmly.
7. Attach the screw (A) removed in step 1. (Keyless entry key only)
8. Install the emergency key removed in step 2. (Keyless operation key only)

OGKE20E1

9. Check the keyless entry system to see that it works.

Keyless operation system*

The keyless operation system allows you to lock and unlock the doors and tailgate and start the engine simply by carrying the keyless operation key with you.

The switches on the keyless operation key can also be used as the key switch of keyless entry system.

Refer to “Starting and stopping the engine” on page 6-19.

Refer to “Keyless entry system” on page 3-04.

The driver should always carry the keyless operation key. This key is necessary for locking and unlocking the doors and tailgate, starting the engine and otherwise operating the vehicle, so before locking and leaving the vehicle, be sure to check that you have the keyless operation key.

⚠ WARNING

- People with implantable cardiac pacemakers or implantable cardiovascular-defibrillators should not go near the exterior transmitters (A) or the interior transmitters (B). The radio waves used by the keyless operation system could adversely affect implantable cardiac pacemakers or implantable cardiovascular-defibrillators.

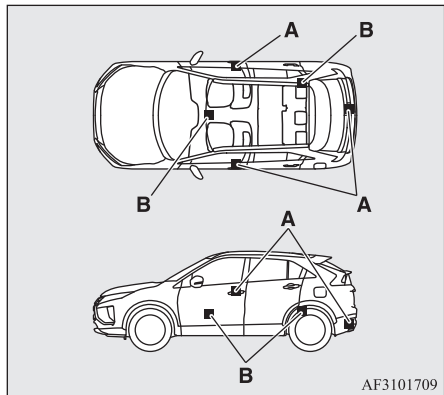

⚠ WARNING

- When using electro-medical devices other than implantable cardiac pacemakers or implantable cardiovascular-defibrillators, contact the electromedical device manufacturer ahead of time to determine the affects of radio waves on the devices. Electromedical device operations could be adversely effected by radio waves.

You can limit the possible operations of the keyless operation system in the following ways. (The keyless operation system can be used as a keyless entry system.) Please consult a MITSUBISHI MOTORS Authorized Service Point.

- You can limit operations to locking and unlocking the doors and tailgate.
- You can limit operations to starting the engine.
- The keyless operation system can be disabled.

📖 NOTE

- The keyless operation key uses an ultra-weak electromagnetic wave. In the following cases, the keyless operation system may not operate properly or may be unstable.
 - When there is equipment nearby that emits strong radio waves, such as: a power station, a radio/TV broadcasting station or an airport.

📖 NOTE

- The keyless operation system is carried together with a communications device such as a cellular phone or radio set, or with an electronic device such as a personal computer.
- The keyless operation key is touching or covered by a metal object.
- A keyless entry system is being used nearby.
- When the keyless operation key battery is worn out.
- When the keyless operation key is placed in an area with strong radio waves or noise. In such cases, use the emergency key.

Refer to “To operate without using the keyless operation function” on page 3-16.

- Because the keyless operation key receives signals in order to communicate with the transmitters in the vehicle, the battery continually wears down regardless of keyless operation key use. The battery life is 1 to 2 years, depending on usage conditions. When the battery wears out, replace the battery according to the description in this manual or have it replaced at your MITSUBISHI MOTORS Authorized Service Point. Refer to “Procedure for replacing the key battery” on page 3-07.

Keyless operation system*

3

NOTE

- Because the keyless operation key continually receives signals, strong radio wave reception could affect battery wear. Do not leave the key near a TV, personal computer, or other electronic device.

Operating range of the keyless operation system

If you are carrying the keyless operation key, enter the operating range of the keyless operation system, and press the driver's or front passenger's door lock/unlock switch, the tailgate lock switch or the tailgate open switch, the ID code for your key is verified.

You can only lock and unlock the doors and tailgate and start the engine only if the ID codes of your keyless operation key and the vehicle match.

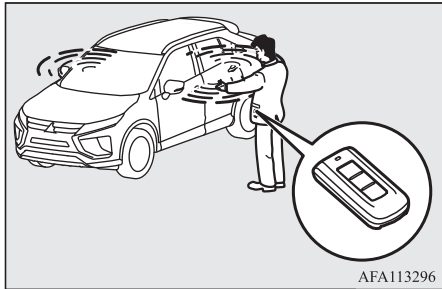

NOTE

- If the keyless operation key battery is wearing out or there are strong electromagnetic waves or noise present, the operating range may become smaller and operation may become unstable.

Operating range for locking and unlocking the doors and tailgate

The operating range is approximately 70 cm from the driver's door lock/unlock switch, front passenger's door lock/unlock switch, and tailgate switch.

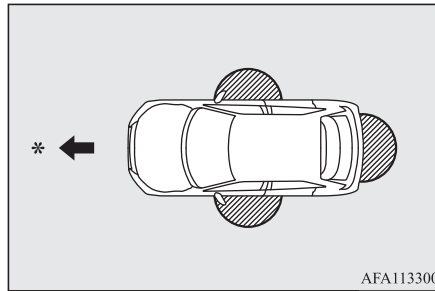

*: Forward direction

: Operating range

NOTE

- Locking and unlocking operate only when you press a door or tailgate switch that detects the keyless operation key.
- Operation may not be possible if you are too close to the front door, door window, or tailgate.
- Even if the keyless operation key is within 70 cm of the driver's door lock/unlock switch, front passenger's door lock/unlock switch, or tailgate switch, if the key is near to the ground or high up, the system may not operate.
- If the keyless operation key is within the operating range, even someone not carrying the key can lock and unlock the doors and tailgate by pressing the driver's or front passenger's door lock/unlock switch, the tailgate lock switch or the tailgate open switch.

Keyless operation system*

Operating range for starting the engine

The operating range is the interior of the vehicle.

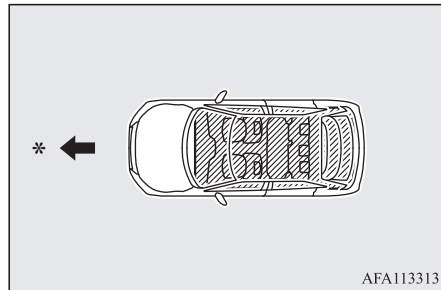

*: Forward direction

: Operating range

NOTE

- Even if it is within the operating range, if the keyless operation key is in a small item holder such as the glove box, on top of the instrument panel, door pocket or in the luggage area, it may be impossible to start the engine.

NOTE

- If a keyless operation key is too close to the door or door window, it may be possible to start the engine or change the operation mode even when the key is outside the vehicle.

To operate using the keyless operation function

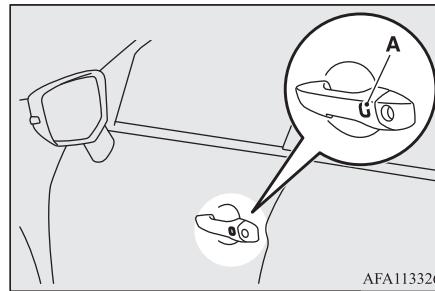

A- Driver's or front passenger's door lock/unlock switch

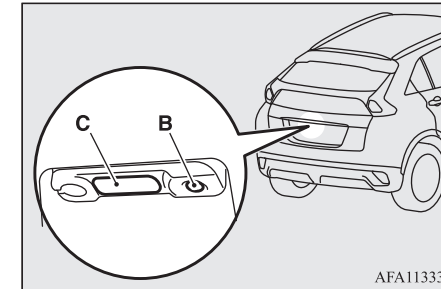

B- Tailgate lock switch
C- Tailgate open switch

Locking the doors and tailgate

When you are carrying the keyless operation key, if you press the driver's or front passenger's door lock/unlock switch (A), or the tailgate lock switch (B) within the operating range, the doors and the tailgate are locked. The turn-signal lamps will blink once.

Also refer to "Locking and unlocking: Doors, Central door locks, Tailgate" on pages 3-16, 3-18 and 3-21.

3

Keyless operation system*

3

NOTE



- Be sure to have the keyless operation key with you before locking the vehicle. Even if the keyless operation key is left in the vehicle in the glove box or other small storage compartment, near the instrument panel, or in the luggage compartment, the vehicle may be locked depending on the radio waves and other conditions in the surrounding environment, trapping the key inside the vehicle.
- For vehicles equipped with the mirror retractor switch, the outside rear-view mirrors automatically retract when all the doors and tailgate are locked using the keyless operation function.
Refer to “Starting and driving: Outside rear-view mirrors” on page 6-11.
- For vehicles equipped with the Dead Lock System, pressing the driver’s or front passenger’s door lock/unlock switch (A), or the tailgate lock switch (B) two times in succession causes the Dead Lock System to be set. (Refer to “Setting the system” on page 3-19.)
- The keyless operation function does not operate under the following conditions:
 - The keyless operation key is inside the vehicle.
 - The operation mode is not in OFF.
 - A door or the tailgate is open or ajar.

NOTE

- The tailgate open switch (C) can be used to check that the vehicle is locked properly. Press the tailgate open switch within approximately 3 seconds of locking the vehicle. If you wait longer than 3 seconds and press the tailgate open switch, the doors and tailgate will be unlocked.
- The time allowed for checking that the vehicle is locked can be adjusted. For further information, please contact a MITSUBISHI MOTORS Authorized Service Point. On vehicles equipped with the Smartphone Link Display Audio or the MITSUBISHI Multi-Communication System (MMCS), screen operations can be used to make the adjustment. Refer to the separate owner’s manual for details.

Unlocking the doors and tailgate

When you are carrying the keyless operation key, if you press the driver’s or front passenger’s door lock/unlock switch (A), or the tailgate open switch (C) within the operating range, all the doors and the tailgate are unlocked.

If the front or the rear room lamp switch is in the “” or the “” position, at this time, the room lamp will turn on for 15 seconds. The turn-signal lamps will blink twice.

If the driver’s or front passenger’s door lock/unlock switch is pressed and any of the doors or tailgate is not opened within approximately 30 seconds, relocking will automatically occur.

Also refer to “Locking and unlocking: Doors, Central door locks, Tailgate” on pages 3-16, 3-18 and 3-21.



NOTE

- For vehicles equipped with the mirror retractor switch, the outside rear-view mirrors automatically extend when all the doors and tailgate are unlocked using the keyless operation function.
Refer to “Starting and driving: Outside rear-view mirrors” on page 6-11.
- Except for vehicles equipped with a Dead Lock System, the keyless operation function can be set so that only the driver’s door unlocks when the driver’s door lock/unlock switch is pressed.
If the keyless operation function is set to work as described above, all the doors and the tailgate unlock when the driver’s door lock/unlock switch is pressed two times in succession.
Refer to “Setting of door and tailgate unlock function” on page 3-06.
- The keyless operation function does not operate when the operation mode is not in OFF.

NOTE

- In order to make it possible to check that the doors and tailgate are locked, you cannot unlock them by using the tailgate open switch for 3 seconds after locking them.
- The time allowed for checking that the vehicle is locked can be adjusted. For further information, please contact a MITSUBISHI MOTORS Authorized Service Point.
On vehicles equipped with the Smartphone Link Display Audio or the MITSUBISHI Multi-Communication System (MMCS), screen operations can be used to make the adjustment. Refer to the separate owner's manual for details.
- The time between unlocking and automatic locking can be adjusted. Please consult a MITSUBISHI MOTORS Authorized Service Point.
On vehicles equipped with the Smartphone Link Display Audio or the MITSUBISHI Multi-Communication System (MMCS), screen operations can be used to make the adjustment. Refer to the separate owner's manual for details.

Operation confirmation when locking and unlocking

Operation can be confirmed as shown below. However, the room lamp will only illuminate if the front or the rear room lamp switch is in the “” or the “” position,
When locking: The turn-signal lamps blink once.

When unlocking: The room lamp illuminates for approximately 15 seconds, the turn-signal lamps blink twice.

(Refer to “Dead Lock System” on page 3-19.)

NOTE

- Functions can be modified as stated below. For further information, please contact your MITSUBISHI MOTORS Authorized Service Point.
On vehicles equipped with the Smartphone Link Display Audio or the MITSUBISHI Multi-Communication System (MMCS), screen operations can be used to make the adjustment. Refer to the separate owner's manual for details.
 - Set the confirmation function (blinking of the turn-signal lamps) to operate only when the vehicle is locked or only when the vehicle is unlocked.
 - Disable the operation confirmation function (blinking of the turn-signal lamps).
 - Change the number of blinks for the operation confirmation function (blinks of the turn-signal lamps).

Operation of the Dead Lock System*

For vehicles equipped with the Dead Lock System, it is possible to set the Dead Lock System using the driver's or front passenger's door lock/unlock switch, or the tailgate lock switch.





Keyless operation system*

Warning activation



In order to prevent vehicle theft or the accidental operation of the keyless operation system, the buzzer and the display on the information screen in the multi-information display are used to alert the driver.

3

If a warning is activated, always check the vehicle and the keyless operation key. The warning is also displayed if there is a fault in the keyless operation system.

Item	Display	Buzzer	Note (Solution)
Detection of failure		Inner buzzer sounds once	There is a fault in the keyless operation system.
Fall of battery voltage		Inner buzzer sounds once	The battery starts to run out, the warning is activated. (The warning is not activated if the battery is completely dead.)
Key not detected	Engine switch is pressed one time 	Inner buzzer sounds once	When the engine switch is pressed to change the operation mode from OFF or when the engine is started, the warning is activated, if any of the following conditions has occurred. <ul style="list-style-type: none"> ● Carrying another keyless operation key with a different code, or the keyless operation key could be outside the operating range. ● The battery of the keyless operation key is dead. ● Communication is blocked by electric wave environment. <p>In such case, touch the keyless operation key to the engine switch to change the operation mode or start the engine. Refer to “If the keyless operation key is not operating properly” on page 6-25.</p>
	Engine switch is pressed two times or more 		

Keyless operation system*

Item	Display	Buzzer	Note (Solution)
Keyless operation key take-out monitoring system		Inner buzzer sounds once Outer buzzer sounds intermittently	<ul style="list-style-type: none"> ● When the vehicle is parked with the operation mode in any mode other than OFF, if you close the door after opening any of the doors and taking the keyless operation key out of the vehicle, a warning is issued until the key is detected in the vehicle. ● If you take the keyless operation key out of the vehicle through a window without opening a door, the keyless operation key take-out monitoring system does not operate. ● It is possible to change the setting to make the keyless operation key takeout monitoring system operate if you take the keyless operation key out from the vehicle through a window without opening a door. For further information, please contact a MITSUBISHI MOTORS Authorized Service Point. ● Even if you have the keyless operation key within the engine start operating range, if the keyless operation key and vehicle ID codes cannot be matched, for example due to the ambient environment or electromagnetic conditions, the warning may be activated.
Key lock-in prevention system		Inner buzzer sounds once Outer buzzer sounds approximately 3 seconds intermittently	<ul style="list-style-type: none"> ● When the operation mode is in OFF, if you close all the doors and the tailgate with the keyless operation key left in the vehicle and you try to lock the doors and tailgate by pressing the driver's or front passenger's door lock/unlock switch, or the tailgate LOCK switch, a warning is issued and you cannot lock the doors and tailgate. ● Make sure you have the keyless operation key with you before locking the doors. Even if you leave the keyless operation key inside the vehicle, it is possible that the doors will lock depending on the surrounding environment and wireless signal conditions.

3

Doors

3

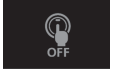
Item	Display	Buzzer	Note (Solution)
Door ajar prevention system		Inner buzzer sounds once Outer buzzer sounds approximately 3 seconds intermittently	When the operation mode in OFF, if you try to lock the doors and tailgate by pressing the driver's or front passenger's door lock/unlock switch, or the tailgate LOCK switch with one of the doors or the tailgate not completely closed, a warning is issued and you cannot lock the doors and tailgate.
Operation mode OFF reminder system		Inner buzzer sounds once Outer buzzer sounds approximately 3 seconds intermittently	When the operation mode is in any mode other than OFF, if you try to lock the doors and tailgate by pressing the driver's or front passenger's door lock/unlock switch, or the tailgate lock switch, a warning is issued and you cannot lock the doors and tailgate.

To operate without using the keyless operation function

Emergency key

The emergency key is built into the keyless operation key. If the keyless operation function cannot be used, for example because the keyless operation key battery has worn out or the vehicle battery is flat, you can lock and unlock the driver's door with the emergency key. To use the emergency key (A), unlock the lock knob (B) and remove it from the keyless operation key (C).

Refer to "Doors" on page 3-16.

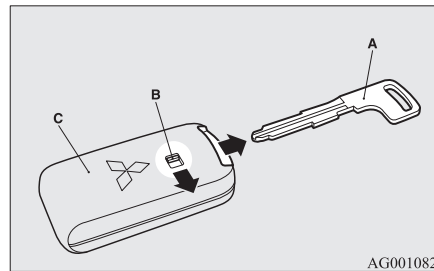

NOTE

- Only use the emergency key for emergencies. If the keyless operation key battery wears out, replace it as quickly as possible so that you can use the keyless operation key.
- After using the emergency key, always return it into the keyless operation key.

Doors

CAUTION

- Make sure the doors are closed: driving with doors not completely closed is dangerous.
- Never leave children in the vehicle unattended.

CAUTION

- Be careful not to lock the doors while the key is inside the vehicle.

NOTE

- To prevent the key from being locked inside the vehicle, neither the lock knob on the driver's door nor the key can be used to lock the driver's door when it is open.

To lock or unlock with the key

Driver's door

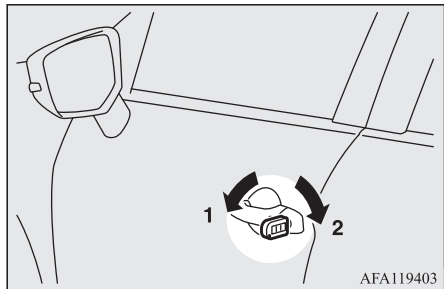

- 1- Lock
- 2- Unlock

Turning the key in the forward direction locks the door, and turning it in the rear direction unlocks the door.

NOTE

- When locking or unlocking with the key, only the driver's door will be locked or unlocked.
To lock or unlock all doors and the tailgate, use the central door lock switch, the keyless entry system or the keyless operation function.
Refer to "Central door locks" on page 3-18, "Keyless entry system" on page 3-04, and "To operate using the keyless operation function" on page 3-11.
- If the vehicle is equipped with the keyless operation system, the driver's door can be locked or unlocked with the emergency key. Refer to "Emergency key" on page 3-16.

To lock or unlock from inside the vehicle

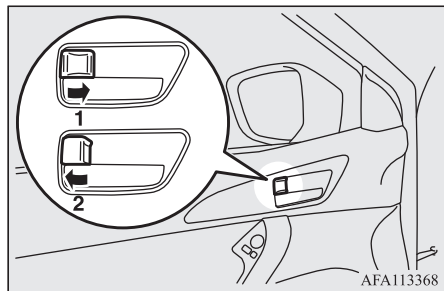

- 1- Lock
- 2- Unlock

Pull the inside door handle towards you to open the door.

NOTE

- The driver's door can be opened without using the lock knob by pulling on the inside door handle.
- In a vehicle that has a Dead Lock System, it is not possible to unlock the door by pushing the lock knob to the unlock side while the Dead Lock System is set. (Refer to "Dead Lock System" on page 3-19.)

3

To lock without using the key

Front passenger's door, Rear door

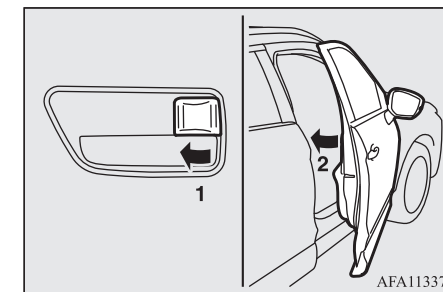

Set the inside lock knob (1) to the locked position, and close the door (2).

Central door locks

NOTE

- The driver's door cannot be locked using the inside lock knob while the driver's door is opened.

3

Central door locks

NOTE

- Repeated continuous operation between lock and unlock could activate the central door locking systems built-in protection circuit and prevent the system from operating. If this occurs, wait approximately 1 minute before operating the central door lock switch.
- When the driver's door is open, the central door lock switch cannot be used to lock it.

To lock and unlock the doors and tailgate

Using the central door lock switch

Using the central door lock switch on the driver's door locks or unlocks all doors and the tailgate.

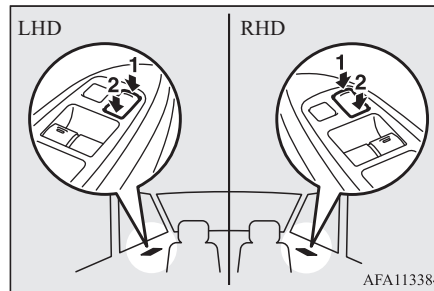

- 1- Lock
- 2- Unlock

To unlock the doors and tailgate

You can select the functions to unlock the doors and tailgate either using the ignition switch or the engine switch, or using the selector lever position.

These functions are not activated when the vehicle is shipped from the factory. To activate or deactivate these functions, please contact a MITSUBISHI MOTORS Authorized Service Point.

Using the ignition switch or the engine switch

All doors and the tailgate will unlock whenever the ignition switch is turned to the "LOCK" position or the operation mode is put in OFF.

Using the selector lever position (A/T or CVT)

All doors and the tailgate will unlock whenever the selector lever is moved to the "P" (PARK) position with the ignition switch in the "ON" position or put the operation mode in ON.



NOTE

- On vehicles equipped with the Smartphone Link Display Audio or the MITSUBISHI Multi-Communication System (MMCS), screen operations can be used to make the adjustment. Refer to the separate owner's manual for details.

Dead Lock System*

The Dead Lock System helps prevent theft. When the keyless entry system or the keyless operation system has been used to lock all of the doors and the tailgate, the Dead Lock System makes it impossible to unlock the doors using the inside lock knobs.

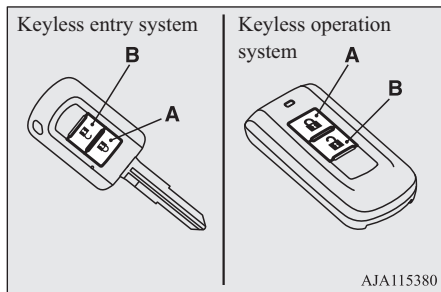

A- Lock switch

B- Unlock switch

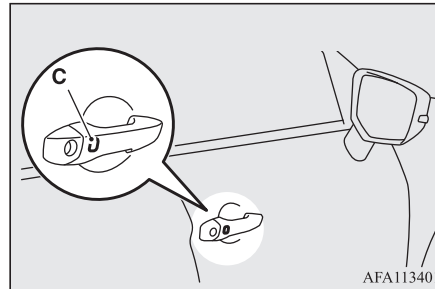

C- Driver's and front passenger's door lock/unlock switches*

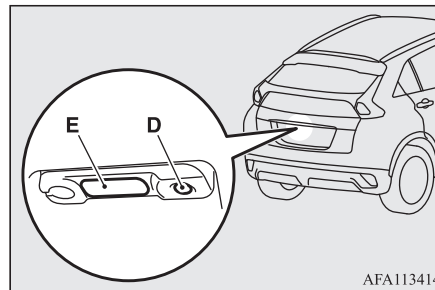

D- Tailgate lock switch*
E- Tailgate open switch

CAUTION

- Do not set the Dead Lock System when someone is inside the vehicle. With the Dead Lock System set, it is not possible to unlock the doors using the inside lock knobs. If you erroneously set the Dead Lock System, unlock the doors using the UNLOCK switch on the key or using the keyless operation function.

3

Setting the system

- Turn the ignition switch to the "LOCK" position and then remove the key (except for vehicles equipped with the keyless operation system), or put the operation mode in OFF (vehicles equipped with the keyless operation system).
- Get out of the vehicle. Close all of the doors and the tailgate.
- Press the LOCK switch (A) on the key switch, the driver's or front passenger's door lock/unlock switch (C), or the tailgate lock switch (D) to lock all of the doors and the tailgate. The turn-signal lamps will blink once.
- Press the switch again within 2 seconds. The turn-signal lamps will blink three times to show that the Dead Lock System has been set.

“Child-protection” rear doors

3

NOTE

- Pressing the LOCK switch (A) on the key once while the Dead Lock System is set causes the turn-signal lamps to blink three times, so it is possible to confirm that the Dead Lock System is set.

cancelling the system

When the following operation is performed, the doors and tailgate will unlock and the Dead Lock System will be simultaneously cancelled.

- The UNLOCK switch (B) on the key is pressed.
- The driver’s or front passenger’s door lock/unlock switch (C) or the tailgate open switch (E) is pressed while you are carrying the keyless operation key.

NOTE

- If neither a door nor the tailgate is opened within 30 seconds of unlocking (except using the tailgate open switch), the doors and tailgate are automatically relocked and the Dead Lock System is simultaneously set again.

NOTE

- It is possible to adjust the time between pressing the UNLOCK switch (B) on the key or the driver’s or front passenger’s door lock/unlock switch (C) and automatic locking. For details, please contact a MITSUBISHI MOTORS Authorized Service Point.
On vehicles equipped with the Smartphone Link Display Audio or the MITSUBISHI Multi-Communication System (MMCS), screen operations can be used to make the adjustment. Refer to the separate owner’s manual for details.
- Even when it is not possible to use the keyless entry system or keyless operation function to unlock the doors, it is possible to use the key to unlock the driver’s door. When the key is used to unlock the driver’s door, the Dead Lock System is cancelled for only the driver’s door. If you wish to subsequently unlock all other doors, turn the ignition switch to the “ON” or “ACC” position, or put the operation mode in on or ACC.
- It is possible to lock the doors and tailgate and set the Dead Lock System at the same time with a single push of the LOCK switch (A) on the key, the driver’s or front passenger’s door lock/unlock switch (C), or the tailgate lock switch (D). For details, please contact a MITSUBISHI MOTORS Authorized Service Point.

Testing the system

Open all of the door windows, then set the Dead Lock System.

(Refer to “Setting the system” on page 3-19.) After setting the Dead Lock System, reach into the vehicle through a window and confirm that you cannot unlock the doors using the lock knobs.

NOTE

- If you need advice on how to set the Dead Lock System, please contact a MITSUBISHI MOTORS Authorized Service Point.

“Child-protection” rear doors

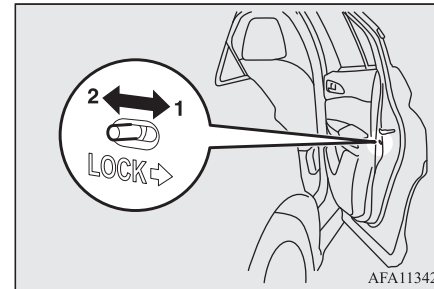

- 1- Lock
- 2- Unlock

Child protection helps prevent the rear doors from being opened accidentally from the inside.

If the lever is set to the locked position, the rear door cannot be opened using the inside handle, but only with the outside handle.

If the lever is set to the unlock position (2), the child protection mechanism does not function.

CAUTION

- When driving with a child in the rear seat, please use the child protection to prevent accidental door opening which may cause an accident.

Tailgate

WARNING

- The luggage compartment is not designed for people to ride in. Do not let people ride or children play there. This could result in a serious accident.
- It is dangerous to drive with the tailgate open, since carbon monoxide (CO) gas can enter the cabin. You cannot see or smell CO. It can cause unconsciousness and even death. And also, if opening the tailgate while driving, luggage may fall from the tailgate. This could result in a serious accident.

WARNING

- When opening and closing the tailgate, make sure of the surrounding safety and keep enough space from the back and upper of the vehicle and be careful not to hit your head or pinch your hands, neck, etc.
- When there is a build up of snow or ice, it should be removed before opening the tailgate. If you open the tailgate without removing it, there is a possibility that the tailgate may close suddenly due to the weight of that snow or ice.
- When you open the tailgate make sure that the tailgate is opened fully and remains fully open. If you only open the tailgate halfway there is a risk that the tailgate may drop and slam shut. If you open the tailgate while your vehicle is parked on an incline it is more difficult to do so than on the flat and also it may drop and slam shut.

CAUTION

- Do not stand behind the exhaust pipe when loading and unloading luggage. Heat from the exhaust could lead to burns.
- To avoid damage to the tailgate, make sure the area above and behind the tailgate is clear before opening it.

To lock/unlock

The tailgate can be locked or unlocked by using the central door lock switch (driver side).

3

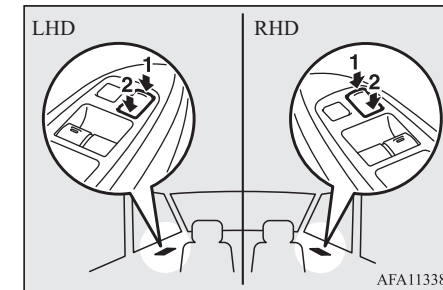

- 1- Lock
2- Unlock

NOTE

- Repeated continuous operation between lock and unlock could activate the central door locking systems built-in protection circuit and prevent the system from operating. If this occurs, wait approximately 1 minute before operating the central door lock switch.

Tailgate

To open

3

To open from outside the vehicle

After unlocking the tailgate, press the tailgate open switch (A) and pull up the tailgate.

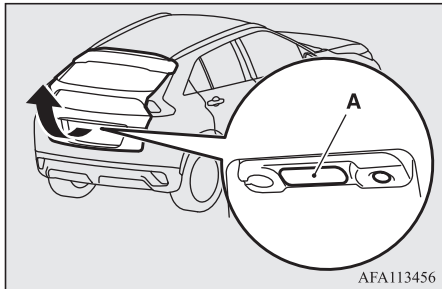

AFA113456

NOTE

- The tailgate cannot be pulled up when you do not open it as soon as the tailgate open switch is pressed. In this case, push the tailgate open switch once again and pull up the tailgate.
- The tailgate cannot be opened when the battery is flat or disconnected.

To open from inside the vehicle

The tailgate can also open from the inside of vehicle.

It is designed to provide a way to open the tailgate in the case of a discharged battery.

1. Open the lid (A) inside of the tailgate.

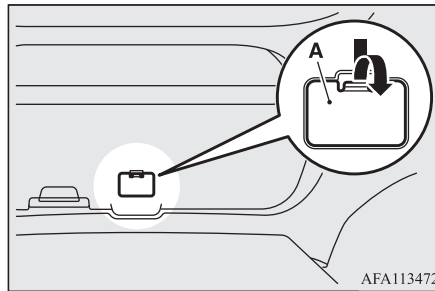

AFA113472

2. Move the lever (B) to open the tailgate.

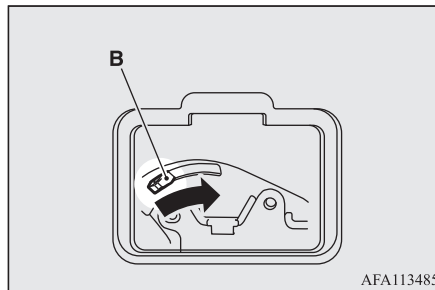

AFA113485

3. Push out on the tailgate to open it.

WARNING

- Always keep the release lever lid on the tailgate closed when driving so that your luggage cannot accidentally bump against the lever and open the tailgate.

To close

To close the tailgate, pull the tailgate grip (A) downward and release it before the tailgate is completely closed, then gently push shut the tailgate from the outside.

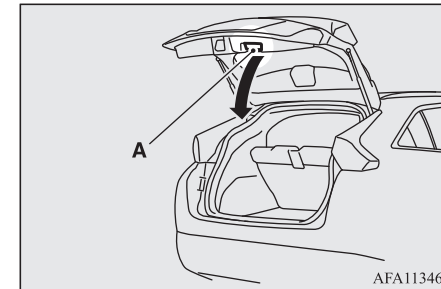

AFA113469

CAUTION

- When closing the tailgate, do not close it directly putting the hands on the tailgate grip. If hands or arms got caught, a serious injury could result.

NOTE

- Gas struts (B) are installed to support the tailgate.

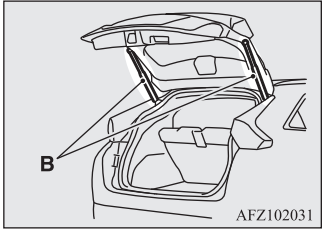

To prevent damage or faulty operation.

- Do not hold the gas struts when closing the tailgate.
- Also, do not push or pull the gas struts.
- Do not attach any plastic material, tape, etc., to the gas struts.
- Do not tie string, etc., around the gas struts.
- Do not hang any object on the gas struts.

Security alarm system*

The security alarm system is for alerting the surrounding area of suspicious behaviour to prevent unlawful entry into the vehicle by operating an alarm if a door, the tailgate or the bonnet is opened when the vehicle has not been unlocked using the keyless entry system or the keyless operation function.

- Also, for vehicles equipped with the interior alarm sensor, the alarm will be activated if any of the following occurs:
- Attempt to an unlawful moving of the vehicle. (the vehicle impact detection function)
 - Detection of a motion in the vehicle (the interior intrusion detection function)
 - Disconnect the battery terminal.

The security alarm system is set to “active”. When making changes to the settings, please follow the procedure listed in the section titled “Changing the security alarm settings” on page 3-25.

On vehicles equipped with the Smartphone Link Display Audio or the MITSUBISHI Multi-Communication System (MMCS), screen operations can be used to make the adjustment. Refer to the separate owner’s manual for details.

CAUTION

- Do not modify or add parts to the security alarm system. Doing so could cause the security alarm to malfunction.

NOTE

- The alarm system will not be activated if the doors and the tailgate have been locked using a key, the inside lock knob or the central door lock switch (instead of the keyless entry system or the keyless operation function).
- For vehicles equipped with the interior alarm sensor, if the turn-signal lamps do not blink after the locking and unlocking operation using the keyless entry system or the keyless operation function, the security alarm system may be malfunctioning. Have the vehicle inspected at a MITSUBISHI MOTORS Authorized Service Point. If the confirmation function (blinking of the turn-signal lamps by locking and unlocking the doors and the tailgate) is deactivated, the turn-signal lamps do not blink after the locking and unlocking operation. For information on the confirmation function, refer to “Keyless entry system” on page 3-04 and “To operate using the keyless operation function” on page 3-11.
- For vehicles equipped with the interior alarm sensor, the security alarm system could be activated in the following situations.
 - Using a car wash
 - Taking the vehicle on a ferry
 - Parking in an automated car park
 - Leaving someone or a pet in the vehicle
 - Leaving a window or the front sunroof open

3

Security alarm system*

3

NOTE

- Leaving an unstable object such as a stuffed toy or accessory in the vehicle
- Suffering a continuous impact or vibration by hail, thunder, etc.
According to the situations, deactivate the vehicle impact detection function and the interior intrusion detection function.
Refer to “To deactivate the vehicle impact detection function and the interior intrusion detection function” on page 3-28.
- For vehicles equipped with the interior alarm sensor, the sensitivity of the interior intrusion detection function can be adjusted. For details, please contact a MITSUBISHI MOTORS Authorized Service Point.

The security alarm has four modes:

System preparation mode (approximately 20 seconds)

(The buzzer sounds intermittently and the security indicator (A) blinks.)

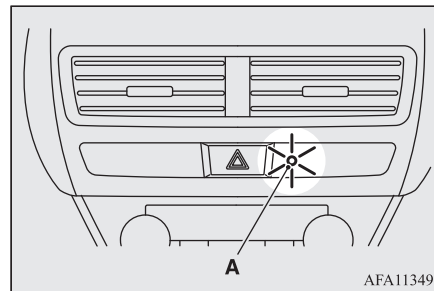

The system preparation time extends from the point at which all of the doors and the tailgate are locked by pressing the LOCK switch on the key or the keyless operation function to the point at which the system armed mode goes into effect.

During this time, it is possible to temporarily open a door or the tailgate without using the keyless entry system or the keyless operation function and without causing the alarm to sound (for example, when you forget something inside the vehicle or realize that a window is open).

System armed mode

(The buzzer stops and the security indicator continues to blink with the indicator's reduced lit-up duration time.)

Once the system preparation mode has ended, the system armed mode starts.

If an unlawful opening of any of the doors, tailgate or bonnet is detected during the system armed mode, the alarm will be activated to warn people around the vehicle of an abnormal condition.

Also, for vehicles equipped with the interior alarm sensor, if unlawful moving of the vehicle is attempted or a vehicle intrusion is detected, the alarm will be activated.

Alarm activation

Inside alarm (approximately 10 seconds):

The buzzer sounds, warning those inside the vehicle of an abnormal condition.

(except for vehicles equipped with the interior alarm sensor)

Outside alarm (approximately 30 seconds):

The turn-signal lamps blink and the horn (the siren for vehicles equipped with the interior alarm sensor) sounds, warning people around the vehicle of an abnormal condition. Refer to “Alarm activation” on page 3-29.

NOTE

- The alarm will resume if unlawful actions are taken again, even if the alarm has stopped.

System cancellation

It is possible to cancel the system activation during the system preparation mode or the system armed mode. In addition, it is possible to cancel the alarm once it has been activated. Refer to “Cancelling the system” on page 3-28, “Cancelling the alarm” on page 3-29.

NOTE

- When lending the vehicle to another person or allowing the vehicle to be driven by someone who is unfamiliar with the security alarm system, be sure to give the person a proper explanation of the security alarm system. If a person who is unfamiliar with the security alarm system accidentally unlocked the vehicle, causing the alarm to sound, the alarm would be a nuisance to people nearby.

Changing the security alarm settings

It is possible to set the security alarm to the “active” mode or “inactive” mode. Follow the procedure below.

1. Turn the ignition switch to the “LOCK” position and then remove the key (except for vehicles equipped with the keyless operation system), or put the operation mode in OFF (vehicles equipped with the keyless operation system).
2. Place the lamp switch in the “AUTO” position, and leave the driver’s door open.

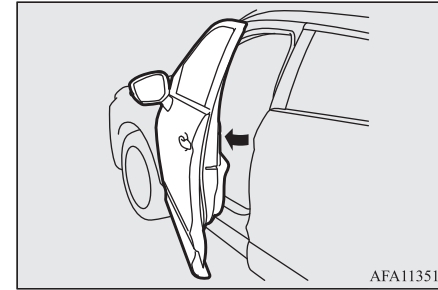

3

3. Pull the windscreen wiper and washer switch towards you and hold it there. (Since the ignition switch is in the “LOCK” position or the operation mode in OFF, washer fluid will not be sprayed.)

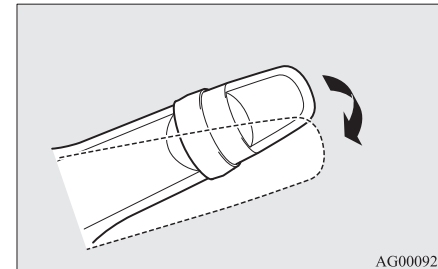
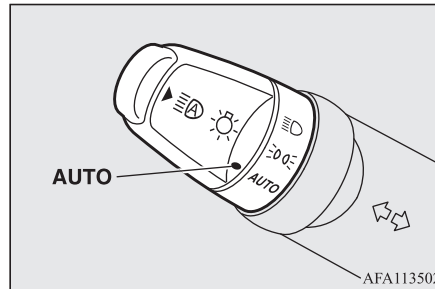

Security alarm system*

3

4. After approximately 10 seconds, the buzzer will make a sound. Keep the windscreen wiper and washer switch pulled towards you. (If the windscreen wiper and washer switch was released, the setting change mode would be cancelled. To start over, perform the procedure again from step 3.)
5. When the buzzer stops, with the windscreen wiper and washer switch still pulled towards you, press the UNLOCK switch (A) on the key to select the security alarm settings mode.

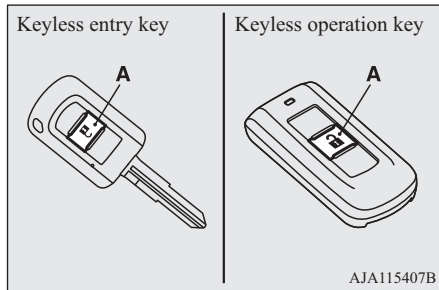

The settings mode can be toggled by pressing the UNLOCK switch. The mode can be confirmed from the number of times the buzzer sounds.

Number of times the buzzer sounds	Security alarm settings mode
1	Alarm inactive
2	Alarm active

6. Any of the following operations can be used to terminate the system settings change mode.
 - Releasing the windscreen wiper and washer switch.
 - Closing the driver's door.
 - Inserting the key into the ignition switch.
 - Putting the operation mode in ON or ACC. (vehicles equipped with the keyless operation system)
 - Placing the lamp switch in any position other than "AUTO".
 - Allowing 30 seconds to pass without making any changes to the settings.

NOTE

- If anything with regard to making changes to the security alarm system settings is hard to understand, please consult your MITSUBISHI MOTORS Authorized Service Point.
- Avoid leaving valuable items inside the vehicle even when the security alarm system has been set to the "active" mode.

Setting the system

Follow the procedure below to set the system to the system armed mode.

1. Turn the ignition switch to the "LOCK" position and then remove the key (except for vehicles equipped with the keyless operation system), or put the operation mode in OFF (vehicles equipped with the keyless operation system).
2. Exit the vehicle and close all of the doors, tailgate and bonnet.
3. Press the LOCK switch (A) on the key, the driver's or front passenger's door lock/unlock switch (B), or the tailgate lock switch (C) in order to lock all the doors and the tailgate.

Security alarm system*

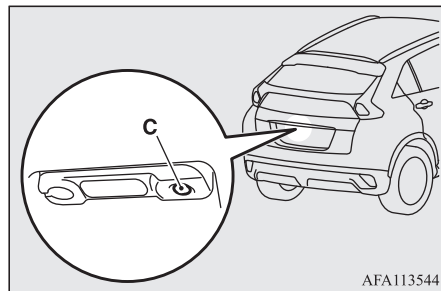
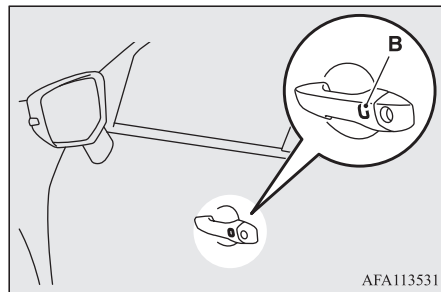
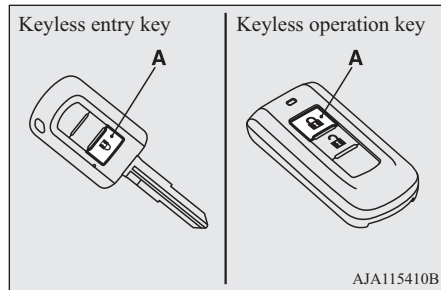

By locking the vehicle using the keyless entry system or the keyless operation function, the system preparation mode is activated.

The buzzer makes an intermittent beeping sound and the security indicator (D) in the centre panel flashes for confirmation.

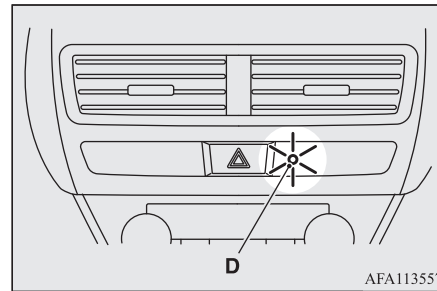

NOTE

- The system preparation mode is not activated when the doors and the tailgate have been locked using a method other than the keyless entry system or the keyless operation function (namely a key, the inside lock knob or the central door lock switch).

NOTE

- If the bonnet is open, the security indicator illuminates, and the system does not enter the system preparation mode. When the bonnet is closed, the system enters the system preparation mode, and after approximately 20 seconds the system enters the system armed mode.

3

4. After approximately 20 seconds, the buzzer stops, and when the blinking of the security indicator starts to slow down, the system armed mode goes into effect.

The security indicator continues to blink during the system armed mode.

NOTE

- The security alarm system can be activated when people are riding inside the vehicle or when the windows are open. To prevent accidental activation of the alarm, do not set the system to the system armed mode while people are riding in the vehicle.
- Avoid leaving valuable items inside the vehicle even when the security alarm system has been set to the “active” mode.

Security alarm system*

To deactivate the vehicle impact detection function and the interior intrusion detection function

3

The vehicle impact detection function and the interior intrusion detection function can be deactivated when parking in automated car parks, leaving pets in the vehicle or leaving the vehicle with the windows slightly open.

1. Turn the ignition switch to the “LOCK” position and then remove the key (except for vehicles equipped with the keyless operation system), or put the operation mode in OFF (vehicles equipped with the keyless operation system).
2. Raise and hold the wiper and washer switch to the “MIST” position for approximately 3 seconds. The buzzer will sound twice and the function will be deactivated.

To activate the function again, raise and hold the wiper and washer switch to the “MIST” position for approximately 3 seconds.

The buzzer will sound once and the function will be activated.

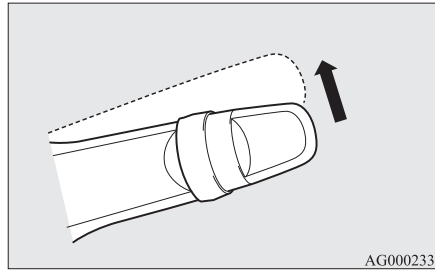

NOTE

- The function will be activated again if the following operation is performed.
 - If the doors and the tailgate are unlocked using the keyless entry system or the keyless operation function.
 - If the ignition switch is turned to the “ON” or “ACC” position or the operation mode is put in ON or ACC.

Cancelling the system

The following methods can be used to cancel the system when it is in the system preparation mode or the system armed mode.

- Pressing the UNLOCK switch on the key.

- Turning the ignition switch to the “ON” position. (except for vehicles equipped with the keyless operation system)
- Putting the operation mode in ON. (vehicles equipped with the keyless operation system)
- Opening any one of the doors or the tailgate, or inserting the key into the ignition switch (except for vehicles equipped with the keyless operation system) when the system is in the system preparation mode.
- Holding the keyless operation key and pressing the driver’s or front passenger’s door lock/unlock switch, or the tailgate open switch to unlock the doors and the tailgate (vehicles equipped with the keyless operation system).

NOTE

- If the bonnet is opened during the system preparation mode, the system preparation mode is suspended. The system returns to the system preparation mode when the bonnet is closed.
- If the battery terminals are disconnected while the system is in the system preparation mode, the memory will be erased.

NOTE

- It is possible to register up to eight keys for the keyless entry system and four keys for the keyless operation system. As long as they are registered, any of the keys, other than the one used to activate the system, can be used to cancel the system. If you want to register additional keys, please contact a MITSUBISHI MOTORS Authorized Service Point.
- The activation distance for the keyless entry system is approximately 4 m. If it is not possible to lock or unlock the vehicle by pressing the switch at the correct distance or the security alarm system cannot be set or cancelled using the switch, the battery may need to be replaced. Refer to “Procedure for replacing the key battery” on page 3-07.
- If the UNLOCK switch on the key, or the driver’s or front passenger’s door lock/unlock switch is pressed and no door or the tailgate is opened within 30 seconds, the doors and the tailgate will automatically re-lock. In this case as well, the system preparation mode will go into effect.

NOTE

- The time between pressing the UNLOCK switch on the key, or the driver’s or front passenger’s door lock/unlock switch and automatic locking can be adjusted. Please consult a MITSUBISHI MOTORS Authorized Service Point. On vehicles equipped with the Smartphone Link Display Audio or the MITSUBISHI Multi-Communication System (MMCS), screen operations can be used to make the adjustment. Refer to the separate owner’s manual for details.

NOTE

- The time for the vehicle inside alarm can be adjusted. Please consult a MITSUBISHI MOTORS Authorized Service Point.

3

2. The alarm will be activated for approximately 30 seconds. The turn-signal lamps will blink, and the horn (the siren for vehicles equipped with the interior alarm sensor) will sound intermittently.

Alarm activation

When the system is in the system armed mode, the alarm will be activated as follows if the vehicle is unlocked or if any of the doors, tailgate or bonnet is opened using a method other than the keyless entry system or the keyless operation function.

1. The inside alarm will be activated for approximately 10 seconds. (except for vehicles equipped with the interior alarm sensor)

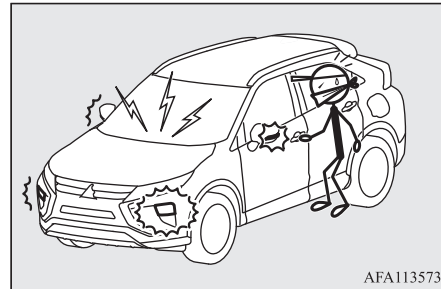

3. The alarm will resume if unlawful actions are taken again, even if the alarm has stopped.

NOTE

- If the bonnet is opened during the system armed mode, the vehicle outside alarm operates immediately, without the vehicle inside alarm operating.

Cancelling the alarm

It is possible to halt the activation of an alarm using the following methods:

Electric window control

3

- Pressing the LOCK or UNLOCK switch on the key.
(After pressing the LOCK switch, the vehicle will lock if all the doors and the tailgate are closed, after which the system preparation mode will once again go into effect.)
- Turning the ignition switch to the “ON” position. (except for vehicles equipped with the keyless operation system)
- Putting the operation mode in ON. (vehicles equipped with the keyless operation system)
- Holding the keyless operation key and locking or unlocking the doors and the tailgate using the keyless operation function (vehicles equipped with the keyless operation system).

NOTE

- Even if a door or the tailgate is closed while the inside alarm is activating, this will not cancel the alarm activation. (except for vehicles equipped with the interior alarm sensor).
- When the ignition switch is turned to the “ON” position or the operation mode is put in ON, the buzzer sounds four times. This operation indicates that the alarm was activated while the vehicle was parked. Please check the inside of the vehicle to confirm that nothing was stolen.

NOTE

- Even if the battery is disconnected, the alarm activation memory will not be erased.

Electric window control

The electric windows can only be operated with the ignition switch in the “ON” position or the operation mode in ON.

Electric window control switch

Each door window opens or closes while the corresponding switch is operated.

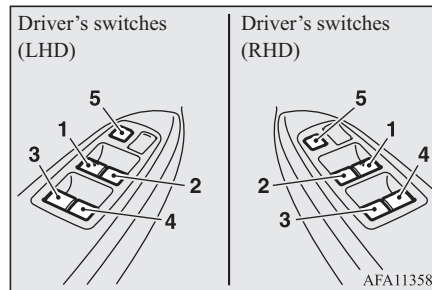

- 1- Driver's door window
- 2- Front passenger's door window
- 3- Rear left door window
- 4- Rear right door window
- 5- Lock switch

WARNING

- Before operating the electric window control, make sure that nothing can get trapped (head, hand, finger, etc.).
- Never leave the vehicle without removing the key.
- Never leave a child (or other person who might not be capable of safe operation of the electric window control) in the vehicle alone.

Driver's switches

- Type 1

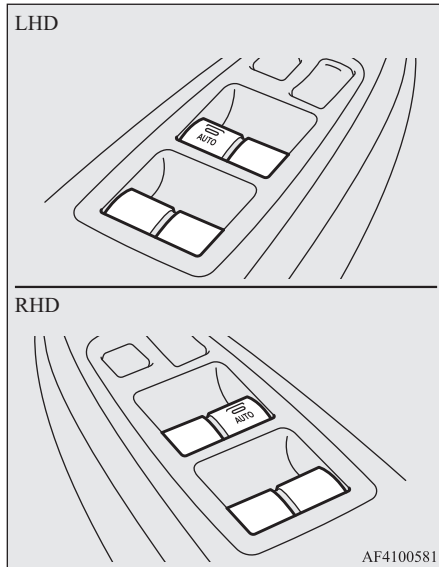

The driver's switches can be used to operate all door windows. A window can be opened or closed by operating the corresponding switch.
Press the switch down to open the window, and pull up the switch to close it.

If the switch for the driver's window is fully pressed down/pulled up, the door window automatically opens/closes completely.
If you want to stop the window movement, operate the switch lightly in the reverse direction.

- Type 2

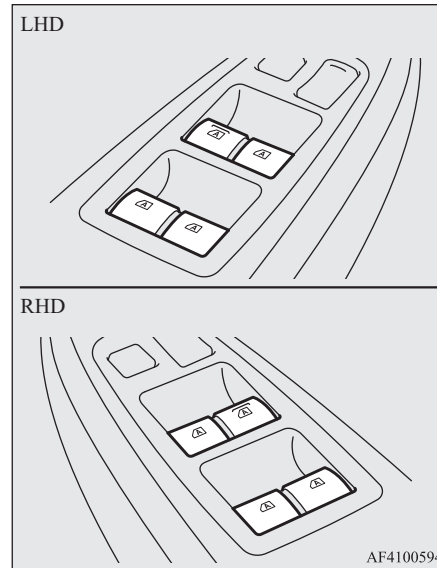

The driver's switches can be used to operate all door windows. A window can be opened or closed by operating the corresponding switch.

Press the switch down to open the window, and pull up the switch to close it.

If the switch is fully pressed down/pulled up, the door window automatically opens/closes completely.

If you want to stop the window movement, operate the switch lightly in the reverse direction.

 NOTE
<ul style="list-style-type: none"> ● When the door window does not close automatically even if the switch is fully pulled up, pull up the door window switch until the window has been fully closed. You should now be able to operate the door window in the normal fashion.

Passenger's switches

The passenger's switches can be used to operate the corresponding passenger's door windows.

3

Electric window control

Press the switch down for opening the window, and pull up the switch for closing it.

3

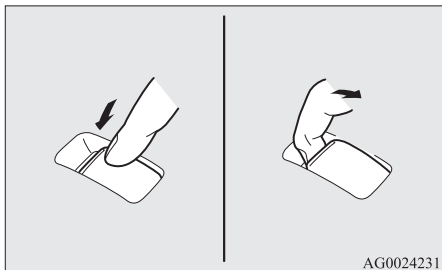

NOTE

- Repeated operation with the engine stopped will run down the battery. Operate the window switches only while the engine is running.
- The rear door windows only open halfway.

Lock switch

When this switch is operated, the passenger's switches cannot be used to open or close the door windows and the driver's switch cannot open or close any door windows other than the driver's door window.

To unlock, push it once again.

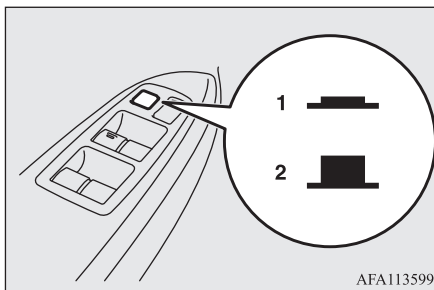

- 1- Lock
- 2- Unlock

WARNING

- A child may tamper with the switch at the risk of its hands or head being trapped in the window. When driving with a child in the vehicle, please push the window lock switch to disable the passenger's switches.

Timer function

The door windows can be opened or closed for 30 seconds after the engine is stopped. However, once the driver's door or the front passenger's door is opened, the windows cannot be operated.

Safety mechanism

Type 1

When the driver's door window is automatically closed by pulling up the switch fully, if a hand or head is trapped in the closing window, it will lower automatically.

Nonetheless, make sure that nobody puts their head or hand out of the window when closing the driver's door window.

The lowered window will become operational after a few seconds.

WARNING

- If the battery terminals are disconnected or the fuse for electric window is replaced, the safety mechanism will be cancelled. If a hand or head got trapped, a serious injury could result.

CAUTION

- The safety mechanism is cancelled just before the window is fully closed. This allows the window to close completely. Therefore be especially careful that no fingers are trapped in the window.
- The safety mechanism is deactivated while the switch is pulled up. Therefore be especially careful that fingers are not trapped in the door window opening.

NOTE

- The safety mechanism can be activated if the driving conditions or other circumstances cause the driver's door window to be subjected to a physical shock similar to that caused by a trapped hand or head.
- If the following operation is performed, the safety mechanism will be cancelled and the driver's door window will not automatically open/close completely.
 - When the battery terminals are disconnected.
 - When the fuse for electric window is replaced.
 - When the safety mechanism is activated five or more times consecutively.

In such a case, the following procedure should be implemented to rectify this situation.

If the window is open, repeatedly raise the driver's door window switch until that window has been fully closed. Following this, release the switch, raise the switch once again and hold it in this condition for at least 1 second, then release it. You should now be able to operate the driver's door window in the normal fashion.

Type 2

When the door window is automatically closed by pulling up the switch fully, if a hand or head is trapped in the closing window, it will lower automatically.

Nonetheless, make sure that nobody puts their head or hand out of the window when closing a window.
The lowered window will become operational after a few seconds.

WARNING

- **If the battery terminals are disconnected or the fuse for electric window is replaced, the safety mechanism will be cancelled. If a hand or head got trapped, a serious injury could result.**

CAUTION

- The safety mechanism is cancelled just before the window is fully closed. This allows the window to close completely. Therefore be especially careful that no fingers are trapped in the window.
- The safety mechanism is deactivated while the switch is pulled up. Therefore be especially careful that fingers are not trapped in the door window opening.

NOTE

- The safety mechanism can be activated if the driving conditions or other circumstances cause the door windows to be subjected to a physical shock similar to that caused by a trapped hand or head.

NOTE

- If the following operation is performed, the safety mechanism will be cancelled and the door window will not automatically open/close completely.
 - When the battery terminals are disconnected.
 - When the fuse for electric window is replaced.
 - When the safety mechanism is activated five or more times consecutively.

In such a case, the following procedure should be implemented to rectify this situation.

If the window is open, repeatedly raise the appropriate window switch until that window has been fully closed. Following this, release the switch, raise the switch once again and hold it in this condition for at least 1 second, then release it. You should now be able to operate the door window in the normal fashion.

3

Power panoramic sunroof*

WARNING

- **Do not put head, hands or anything else out of the front sunroof opening while driving the vehicle.**
- **Never leave a child (or other person who might not be capable of safe operation of the sunroof switches) in the vehicle alone.**

Power panoramic sunroof*

3

WARNING

- Never leave the vehicle without removing the key.
- Before operating the front sunroof, front shade, or rear shade, make sure that nothing is capable of being trapped (head, hand, finger, etc.).
- Because the front sunroof opens to the outside of the vehicle, do not open the sunroof when cleaning the top of the roof, etc. Your hands or arms could be trapped.

NOTE

- The front sunroof stops just before reaching the fully open position.
If the vehicle is driven with the front sunroof in this position, wind throbs lower than with the front sunroof fully open.
- Do not try to operate the front sunroof if it is frozen closed (after snow fall or during extreme cold).
- Do not sit or place heavy luggage on the front sunroof or roof opening edge.
- Release the switch when the front sunroof, front shade, or rear shade starts to move.
- If the front sunroof, front shade, or rear shade does not operate when the switch is operated, release the switch and check whether something is trapped by the sunroof or shade. If nothing is trapped, we recommend you to have the sunroof or shade checked.

NOTE

- Depending on the model of ski carriers or roof carriers, the front sunroof may make contact with the carrier when the front sunroof is tilted up. Be careful when tilting up the front sunroof if such a ski carrier or a roof carrier is installed.
- Be sure to close the front sunroof completely when washing the vehicle or when leaving the vehicle.
- After washing the vehicle or after it has rained, wipe off any water that is on the front sunroof before operating it.
- Operating the front sunroof, front shade, or rear shade repeatedly with the engine stopped will run down the battery. Operate the front sunroof, front shade, and rear shade while the engine is running.

Front sunroof & front shade

The front sunroof & front shade can only be operated with the ignition switch in the “ON” position or the operation mode in ON.

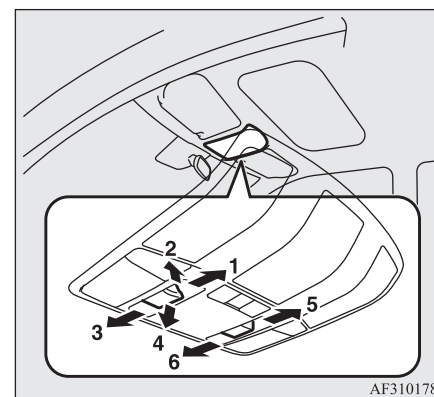

- 1- Open (front sunroof)
- 2- Tilt up (front sunroof)
- 3- Close (front sunroof)
- 4- Tilt down (front sunroof)
- 5- Open (front shade)
- 6- Close (front shade)

Opening the front sunroof

Press the switch in direction (1) to open the front sunroof automatically.

To stop the sunroof before it is fully open, operate the switches in any of the directions (1) to (6).

NOTE

- The front sunroof automatically stops just before reaching the fully open position. Press the switch again to fully open it.
- Depending on the position of the front shade, the front shade will open together with the front sunroof.

Closing the front sunroof

Press the switch in direction (3) to fully close the front sunroof automatically.

To stop the sunroof before it is fully closed, operate the switches in any of the directions (1) to (6).

NOTE

- When you press the switch in direction (6), the front sunroof will close slightly, and then the sunroof and front shade will fully close automatically.

Tilting up the front sunroof

Press the switch in direction (2) to raise the rear edge of the front sunroof as it opens.

NOTE

- Depending on the position of the front shade, the front shade will open together with the front sunroof.

Tilting down the front sunroof

Press the switch in direction (3) or pull the switch in direction (4) to fully close the front sunroof automatically.

NOTE

- When you press the switch in direction (6), the front sunroof will close slightly, and then the sunroof and front shade will fully close automatically.

Opening the front shade

Press the switch in direction (5) to fully open the front shade automatically.

To stop the shade before it is fully open, operate the switches in any of the directions (1) to (6).

Closing the front shade

Press the switch in direction (6) to fully close the front shade automatically.

To stop the shade before it is fully closed, operate the switches in any of the directions (1) to (6).

NOTE

- If the front sunroof is open, it will close together with the front shade.

Timer function

Within approximately 30 seconds after the ignition switch is changed to “ACC” or “LOCK” position or the operation mode is changed to ACC or OFF, the front sunroof and front shade can be opened and closed.

However, if the driver’s or front passenger’s door is opened within 30 seconds after the ignition switch is changed to “ACC” or “LOCK” position or the operation mode is changed to ACC or OFF, the front sunroof and front shade cannot be opened or closed.

Safety mechanism

If a person’s hand, neck, etc., is trapped in the front sunroof or front shade, the front sunroof or front shade will automatically open a maximum of 20 cm as a safety function. After the front sunroof and front shade open, you can use the switch to close them.

If the safety mechanism operates five times or more consecutively, you will not be able to close the front sunroof and front shade normally.

If this occurs, perform the following procedure to reset the safety mechanism.

Power panoramic sunroof*

3

1. Press and hold the switch in direction (3) or pull and hold the switch in direction (4).
2. The front sunroof (if open) and front shade will move to the fully closed positions in small increments.

NOTE

- If the front sunroof and front shade are both open, the front sunroof will move to the fully closed position, and then the front shade will move to the fully closed position.

3. When the front sunroof and front shade have both stopped in the fully closed position, release the switch. (The resetting procedure is finished.)

If the front sunroof and front shade do not move correctly to the fully closed position after you perform the resetting procedure, contact a MITSUBISHI MOTORS Authorized Service Point.

CAUTION

- The safety mechanism is cancelled just before the front shade is fully closed. This allows the front shade to close completely. Therefore be especially careful that no fingers are trapped in the front shade.

NOTE

- The safety mechanism can be activated if the driving conditions or other circumstances cause the front sunroof or the front shade to be subjected to a physical shock similar to that caused by a trapped hand or head.
- Do not release the switch until the resetting procedure is finished. If you release the switch, the resetting mode will be cancelled. To perform the resetting procedure again, repeat the procedure from step 1.

Rear shade

The rear shade can only be operated with the ignition switch in the “ON” position or the operation mode in ON.

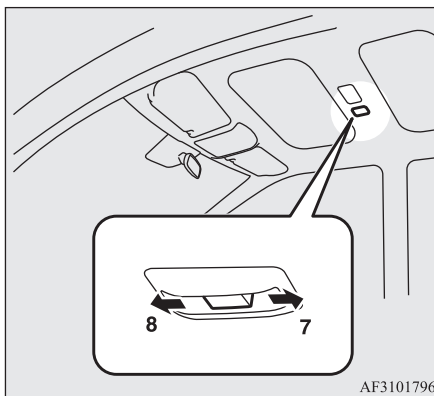

- 7- Open (rear shade)
- 8- Close (rear shade)

Opening the rear shade

Press the switch in direction (7) to fully open the rear shade automatically.

To stop the shade before it is fully open, press the switch in direction (7) or (8).

Closing the rear shade

Press the switch in direction (8) to fully close the rear shade automatically.

To stop the shade before it is fully closed, press the switch in direction (7) or (8).

Safety mechanism

If a person's hand, neck, etc., is trapped in the rear shade, the shade will automatically open a maximum of 20 cm as a safety function. After the rear shade opens, you can use the switch to close it.

If the safety mechanism operates five times or more consecutively, you will not be able to close the rear shade normally.

If this occurs, perform the following procedure to reset the safety mechanism.

1. Press and hold the switch in direction (8).
2. The rear shade will move to the fully closed position in small increments.

3. When the rear shade has stopped in the fully closed position, release the switch.
(The resetting procedure is finished.)

If the rear shade does not move correctly to the fully closed position after you perform the resetting procedure, contact a MITSUBISHI MOTORS Authorized Service Point.

 **CAUTION**

- The safety mechanism is cancelled just before the rear shade is fully closed. This allows the rear shade to close completely. Therefore be especially careful that no fingers are trapped in the rear shade.

 **NOTE**

- The safety mechanism can be activated if the driving conditions or other circumstances cause the rear shade to be subjected to a physical shock similar to that caused by a trapped hand or head.
- Do not release the switch until the resetting procedure is finished. If you release the switch, the resetting mode will be cancelled. To perform the resetting procedure again, repeat the procedure from step 1.

3

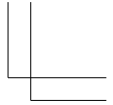
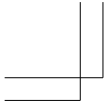

Handwriting practice lines consisting of 12 horizontal dashed lines.

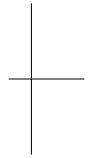
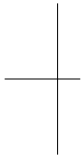

OGKE20E1

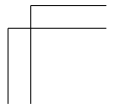
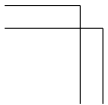

Seats and seat belts

Seat adjustment.....	4-02
Front seat.....	4-02
Rear seats.....	4-03
Heated seats*.....	4-04
Head restraints.....	4-05
Making a luggage area.....	4-07
Seat belts.....	4-08
Pregnant women restraint.....	4-14
Seat belt pretensioner system and force limiter system.....	4-14
Child restraint.....	4-15
Seat belt inspection.....	4-26
Supplemental restraint system (SRS) - airbag.....	4-26

Seat adjustment

Seat adjustment

Adjust the driver's seat so that you are comfortable and that you can reach the pedals, steering wheel, switches etc. while retaining a clear field of vision.

4

⚠ WARNING

- Do not attempt to adjust the seat while driving. This can cause loss of vehicle control and result in an accident. After adjustments are made, ensure the seating is locked in position by attempting to move the seat forward and rearward without using the adjusting mechanism.
- It is extremely dangerous to ride in the luggage area of a vehicle. Also, the luggage area and rear seats should never be used as a play area by children. In a collision, people or children riding unrestrained in these areas are more likely to be seriously injured or killed.
- Do not allow people or children to ride in any area of your vehicle that is not equipped with seats and seat belts, and make sure that everyone travelling in your vehicle is in a seat and wearing a seat belt, or in the case of a child is strapped in a child restraint.

⚠ WARNING

- To minimize the risk of personal injury in the event of a collision or sudden braking, the seatbacks should always be in the almost upright position while the vehicle is in motion. The protection provided by the seat belts may be reduced significantly when the seatback is reclined. There is greater risk that the passenger will slide under the seat belt, resulting in serious injury, when the seatback is reclined.
- Do not place objects under the seats. This could prevent the seat from locking securely, and it could lead to an accident. It may also cause damage to the seat or other parts.

⚠ CAUTION

- Make sure the seat is adjusted by an adult or with adult supervision for correct and safe operation.
- Do not place a cushion or the like between your back and the seatback while driving. The effectiveness of the head restraints will be reduced in the event of an accident.
- The reclining mechanism of the front seat's seatback is spring loaded, causing it to return to the vertical position when the lock lever is operated. When using the lever, sit close to the seatback or hold it with your hand to control its return motion.
- When sliding the seats, be careful not to catch your hand or foot.

⚠ CAUTION

- When sliding or reclining the seat rearward, pay careful attention to the rear seat passengers.

Front seat

Manual type

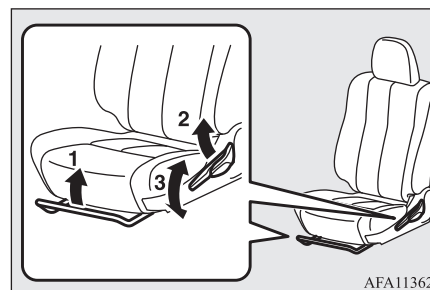

- 1- To adjust forward or backward
Lift the handle and adjust the seat to the desired position, and release the handle.
- 2- To recline the seatback
Pull the lever up and then lean backward to the desired position, and release the lever.
- 3- To adjust seat height (driver's side only)
Repeatedly operate the lever and adjust the seat height to the desired position.

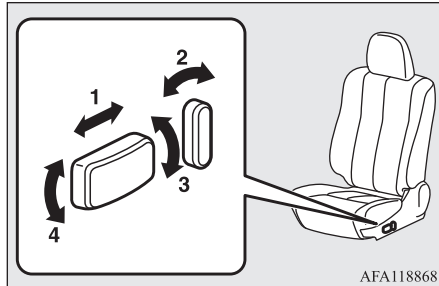
Power type (driver's side only)*

- 1- To adjust forward or backward
Operate the switch as indicated by the arrows and adjust the seat to the desired position.
- 2- To recline the seatback
Operate the switch as indicated by the arrows and adjust the seatback angle to the desired position.
- 3- To adjust seat height
Operate the switch as indicated by the arrows and adjust the seat height to the desired position.
- 4- To adjust seat cushion angle
Operate the switch as indicated by the arrows and adjust the seat cushion angle to the desired position.

NOTE

- To prevent the battery from running down, operate the switch with the engine running.

Armrest*

The lid of the floor console box can be moved forward and backward, and used as an armrest.

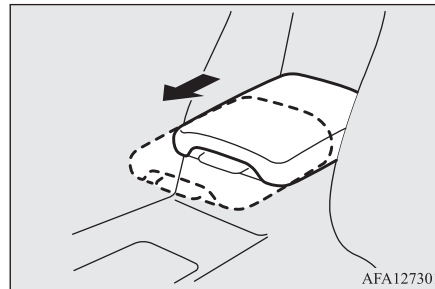
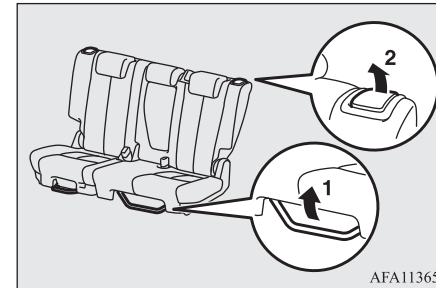
**Rear seats**

- 1- To adjust forward or backward
Lift the handle and adjust the seat to the desired position, and release the handle.
- 2- To recline the seatback
Pull the lever up and adjust the seatback by hand to the desired position, and release the lever.

CAUTION

- When sliding the rear seat rearward, make sure that there are no items behind the seat.
- If your vehicle is equipped with the armrest and the seatback is reclined while the drink holder is used, drinks could be spilled. If the spilled drink is very hot, you could be burnt.

Heated seats*

4

NOTE

- It is possible to adjust the seatback angle and move the seats forward or backward independently on each side.
- If your vehicle is equipped with the cargo area cover, the seatbacks cannot be reclined unless the cargo area cover is installed in the rear position or removed.
Refer to “Cargo area cover” on page 7-86.

Armrest*

To use the armrest, fold it down. To return to the original position, push it backward level with the seat.



CAUTION

- Do not climb or sit on the armrest. Doing so could damage the armrest.

NOTE

- The top surface of the armrest contains a drink holder for rear seat occupants. Refer to “Drink holder” on page 7-85.

Heated seats*

The heated seats can be operated with the ignition switch in the “ON” position or the operation mode in ON.

CAUTION

- Switch off seat heaters when not in use.
- Operate in the high position for quick heating. Once the seat is warm, set the heater switch to the “LO” position to keep it warm. Slight variations in seat temperature may be felt while using the heated seats. This is caused by the operation of the heater’s internal thermostat and does not indicate a malfunction.
- If the following types of persons use the heated seats, they might become too hot or receive minor burns (red skin, heat blisters, etc.):
 - Children, elderly or ill people
 - People with sensitive skin
 - Excessively tired people
 - People under the influence of alcohol or sleep inducing medication (cold medicine, etc.)

CAUTION

- Do not place heavy objects on the seat or stick pins, needles, or other pointed objects into it.
- Do not use a blanket, cushion, or other material with high heat insulation properties on the seat while using the heater; this might cause the heater element to overheat.
- Do not use benzine, kerosene, petrol, alcohol or other organic solvents when cleaning the seats. Doing so could damage not only the seat cover, but also the heater element.
- If water or any other liquid is spilled on the seat, allow it to dry thoroughly before attempting to use the heater.
- Turn the heater off immediately if it appears to be malfunctioning during use.

NOTE

- Do not use the seat heater for a long time when the engine is not running, doing so will cause the battery to be discharged.

For the front seats

Operate the switch as indicated by arrows. The indication lamp (A) will illuminate while the heater is on.

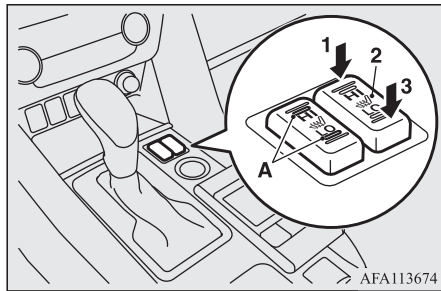

- 1 (HI) - Heater high (for quick heating)
- 2 (OFF) - Heater off
- 3 (LO) - Heater low (to keep the seat warm)

For the rear seats

Each time the switch is pressed, the mode changes to the next one in the following sequence: OFF → HI → LO → OFF.

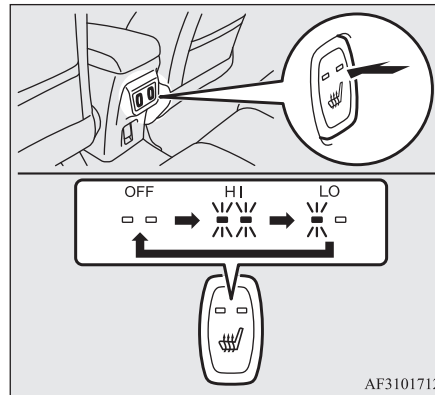

- OFF - Heater off
- HI - Heater high (for quick heating)
- LO - Heater low (to keep the seat warm)

NOTE

- The rear seat switch will automatically return to “OFF” after the engine is stopped.

Head restraints

WARNING

- Driving without the head restraints in place can cause you and your passengers serious injury or death in an accident. To reduce the risk of injury in an accident, always make sure the head restraints are installed and properly positioned when the seat is occupied.
- Never place a cushion or similar device on the seatback. This can adversely affect head restraint performance by increasing the distance between your head and the restraint.

4

To adjust height

Front seats

Adjust the head restraint height so that the centre of the head restraint is as close as possible to ear level to reduce the chances of injury in the event of collision. Any person too tall for the head restraint to reach their seated ear level, should adjust the restraint as high as possible.

Head restraints

To raise the head restraint, move it upward. To lower the restraint, move it downward while pressing the height adjusting knob (A) in the direction of the arrow. After adjustment, push the head restraint downward and make sure that it is locked.

4

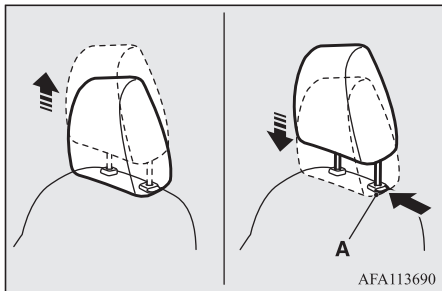

To lower the restraint, move it downward while pushing the height adjusting knob (A) in the direction of the arrow. After adjustment, push the head restraint downward and make sure that it is locked.

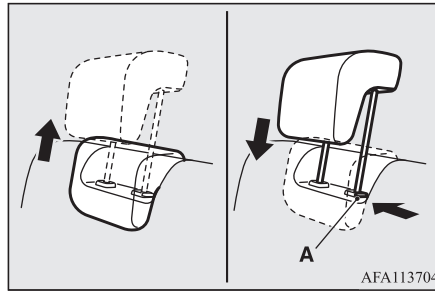

⚠ WARNING

- When a person sits in the rear seats, pull up the head restraint to a height at which it locks in position. Be sure to make this adjustment before starting to drive. Serious injuries could otherwise be suffered as the result of an impact.

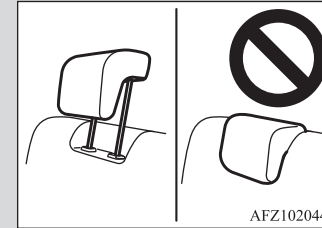

Rear seats

To reduce the risk of injury in an accident, pull up the head restraint to the locked position.

To raise the head restraint, move it upward.

⚠ CAUTION

- The shape and size of the head restraint differs according to the seat. Always use the correct head restraint provided for the seat and do not install the head restraint in the wrong direction.



To remove

Lift the head restraint with the height adjusting knob (A) pressed in.

📖 NOTE

- If a front seat head restraint contacts the headliner and cannot be removed, tilt the seatback rearward slightly. Refer to “Front seats” on page 4-02.
- To remove the head restraint from a rear outboard seat, tilt the seatback forward slightly. Refer to “Rear seats” on page 4-03.

To install

📖 NOTE

- Before installing the head restraint to a rear outboard seat, tilt the seatback forward slightly. Refer to “Rear seats” on page 4-03.

Confirm that the head restraint is facing the correct direction, and then insert it into the seatback while pressing the height adjusting knob (A) in the direction indicated by the arrow.

The head restraint stalk with the adjustment notches (B) must be installed in the hole with the adjusting knob (A).

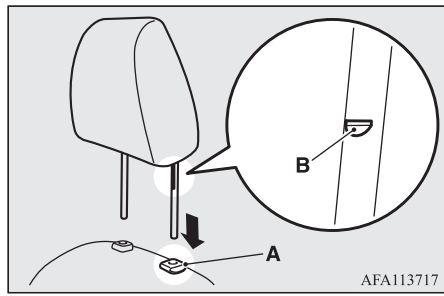

⚠ CAUTION

- Confirm that the height adjusting knob (A) is correctly adjusted as shown in the illustration, and also lift the head restraints to ensure that they do not come out of the seatback.

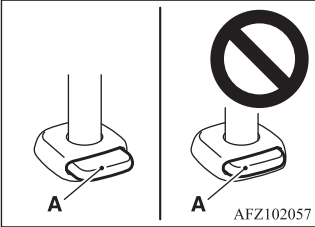

Making a luggage area

To create luggage space, you can fold the rear seats.

⚠ CAUTION

- Do not stack luggage above the seatback height. Secure the luggage firmly. Serious accidents could result due to unrestrained objects entering the passenger compartment during sudden braking.
- When folding the seat, be sure not to catch your hand or leg.

Seat belts

NOTE

- It is possible to folding the seat independently on each side.

4

To fold

1. Lower the head restraints of the rear seat to the lowest position.
Refer to “Head restraints” on page 4-05.
2. Store the seat belt for the rear centre seating position.
Refer to “Rear-centre 3-point type seat belt” on page 4-11.
3. Place the buckles in the pockets.

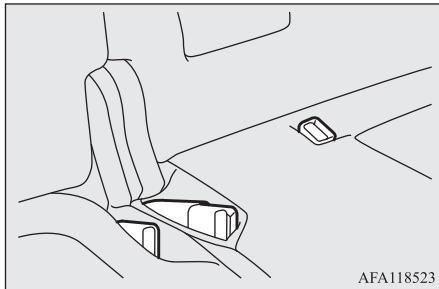

4. Adjust the rear seat to its most rearward position.
Refer to “Rear seats” on page 4-03.

NOTE

- If you do not move the rear seat to its most rearward position, items may fall into the gap between the rear seat and the luggage floor.

5. Pull up the lever (A), then fold the seat-back forward.

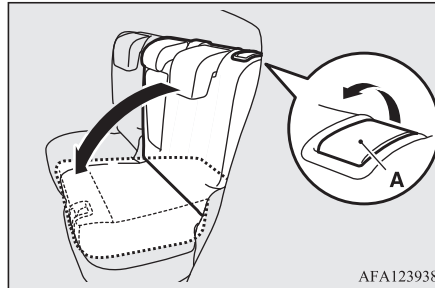

To return

Raise the seatback until it locks securely into place.

Seat belts

To protect you and your passengers in the event of an accident, it is most important that the seat belts are worn correctly while driving.

The front seat belts and/or rear outboard seat belts have a pretensioner system. These belts are used the same way as a conventional seat belt.

Refer to “Seat belt pretensioner system and force limiter system” on page 4-14.

WARNING

- Seat belts should always be worn by every adult who drives or rides in this vehicle, and by all children who are tall enough to wear seat belts properly.
Other children should always use proper child restraint systems.
- Always place the shoulder belt over your shoulder and across your chest. Never put it behind you or under your arm.
- One seat belt should be used by only one person. Doing otherwise can be dangerous.
- The seat belt will provide its wearer with maximum protection if the recliner seatback is placed in fully upright position. When the seatback is reclined, there is greater risk that the passenger will slide under the belt, especially in a forward impact accident, and may be injured by the belt or by striking the instrument panel or seatbacks.
- Remove any twists when using the belt.

⚠ WARNING

- No modifications or additions should be made by the user which will either prevent the seat belt adjusting devices from operating to remove slack, or prevent the seat belt assembly from being adjusted to remove slack.
- Never hold a child in your arms or on your lap when riding in this vehicle, even if you are wearing your seat belt. To do so risks severe or fatal injury to the child in a collision or sudden stop.
- Always adjust the belt to a snug fit.
- Always wear the lap portion of the belt over your hips.

3-point type seat belt (with emergency locking mechanism)

This type of belt requires no length adjustment. Once worn, the belt adjusts itself to the movement of the wearer, but in the event of a sudden or strong shock, the belt automatically locks to hold the wearer's body.

📖 NOTE

- You can check if the belt locks by pulling it forward quickly.

To fasten

1. Pull the seat belt out slowly while holding the latch plate.

📖 NOTE

- When the seat belts cannot be pulled out in a locked condition, pull the belts once forcefully and then return them. After that, pull the belts out slowly once again.

2. Insert the latch plate into the buckle until a "click" is heard.

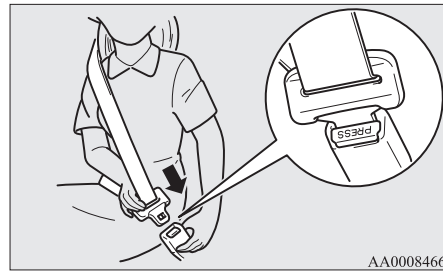

⚠ WARNING

- Never wear the lap portion of the belt across your abdomen. During accidents it can press sharply against the abdomen and increase the risk of injury.
- The seat belts must not be twisted when worn.

3. Pull the belt slightly to adjust slackness as desired.

To unfasten

Hold the latch plate and push the button on the buckle.

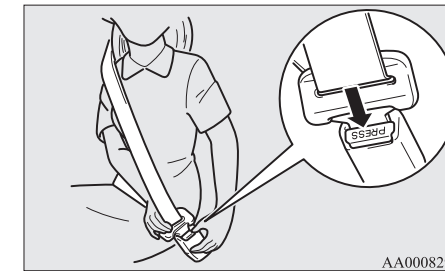

4

⚠ CAUTION

- As the belt retracts automatically, keep holding the latch plate while retracting so that the belt stows slowly. Failure to do this could damage the vehicle.

Seat belts

4

NOTE

- If the seat belt (A) or ring (B) becomes dirty, the belt may not retract smoothly. If the seat belt and ring are dirty, clean them with a mild soap or detergent solution.

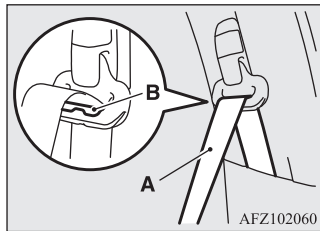

Seat belt reminder

For the driver and the front passenger's seat

[For the driver]

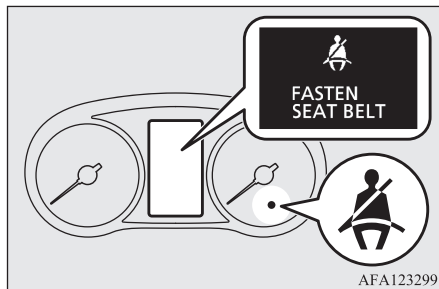

[For the front passenger]

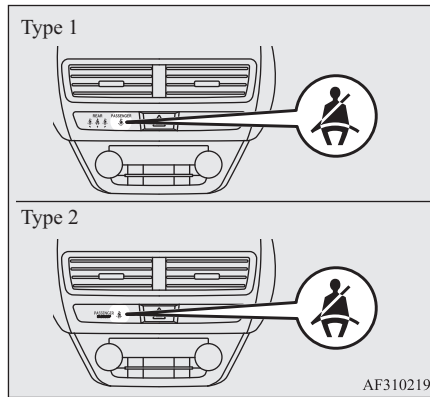

If the ignition switch is turned to the "ON" position or the operation mode is put in ON while a seat belt is not fastened, the warning lamp comes on and the tone sounds for approximately 6 seconds to remind the driver and the front passenger to fasten the seat belt. If the vehicle is driven with the seat belt still unfastened, the warning lamp will blink and the tone will sound intermittently until the seat belt is fastened. At the same time, "FASTEN SEAT BELT" is displayed on the information screen in the multi-information display for the driver.

WARNING

- Do not install any accessory or sticker that makes the lamp difficult to see.

NOTE

- If the seat belt subsequently remains unfastened, the warning lamp and the tone will issue further warnings each time the vehicle starts moving from a stop.
- For the front passenger seat, the warning function works only while a person is sitting on the seat.
- When luggage is placed on the front passenger seat, a sensor in the seat cushion may, depending on the weight and position of the luggage, cause the warning tone to sound and the warning lamp to come on.

For the rear passenger's seats*

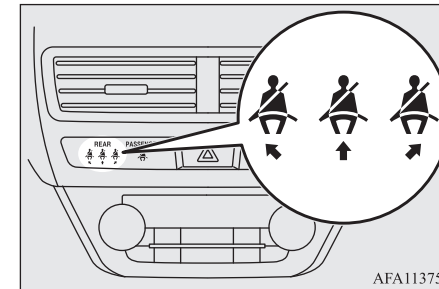

If the ignition switch is turned to the “ON” position or the operation mode is put in ON while a seat belt is not fastened, the warning lamp comes on for approximately 30 seconds to remind the rear passenger to fasten the seat belt.

If the vehicle is driven with the seat belt still unfastened, the warning lamps come on for approximately another 30 seconds. (This illumination happens only the first time the vehicle starts moving with the seat belt still unfastened.)

The warning lamps go off when the seat belt is fastened.

WARNING

- Do not install any accessory or sticker that makes the lamp difficult to see.

NOTE

- The warning lamp comes on even if no one is sitting on the rear seats.
- If a seat belt is unfastened while the vehicle is being driven, the tone sounds for approximately 1 second and the warning lamp comes on for approximately 30 seconds. At the same time, the warning lamp for the seat where the seat belt is not fastened comes on.

NOTE

- If the seat belts are initially fastened but a seat belt is unfastened while the vehicle is stationary and the vehicle is then driven with the seat belt still unfastened, the warning lamp for the seat where the seat belt is not fastened comes on again for approximately 30 seconds.

Adjustable seat belt anchor (front seats)

The seat belt anchor height can be adjusted. Raise or lower the seat belt anchor (A) while pulling the lock knob (B).

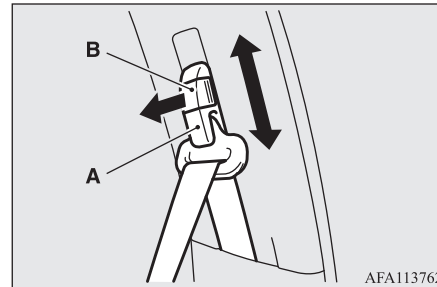

WARNING

- When adjusting the seat belt anchor, set it at a position that is sufficiently high so that the belt will make full contact with your shoulder but will not touch your neck.

4

Rear-centre 3-point type seat belt

The rear-centre 3-point type seat belt must be worn correctly as illustrated.

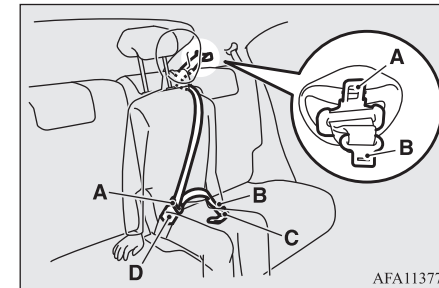

WARNING

- Be sure to securely connect the both latch plate (A and B). Failing to do so could significantly reduce the amount of protection and cause serious injuries in a collision or a sudden stop.

Seat belts

To fasten

1. Pull out the buckle (C) from the seat-back. Refer to “Rear seat belt storage” on page 4-13.
2. Pull out the latch plate (A) and then pull out the small latch plate (B) by tilting it as shown in the illustration.

4

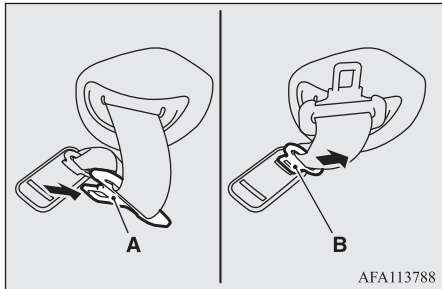

3. Pull the seat belt out slowly and pass it through the seat belt guide (E) so that

the latch plate (A) is turned to the front side.

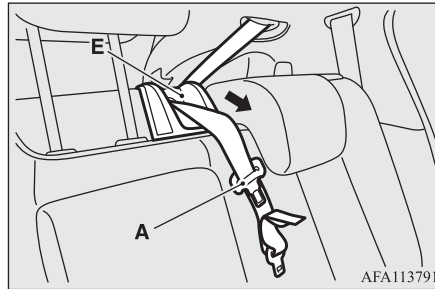

NOTE

- When the seat belts cannot be pulled out in a locked condition, pull the belt once forcefully and then return it. After that, pull the belt out slowly once again.

4. Pull the seat belt and insert the small latch plate (B) into the buckle (C).

5. Insert the latch plate (A) into the buckle (D).

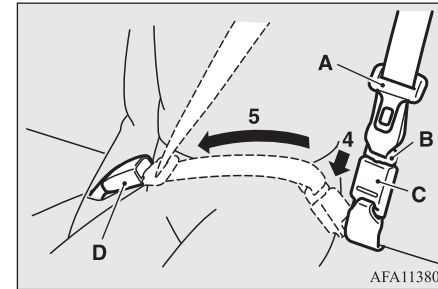

6. Pull the belt slightly to adjust slackness as desired.

To unfasten

CAUTION

- As the belt retracts automatically, keep holding the latch plate while retracting so that the belt stows slowly. Failure to do this could damage the vehicle.

1. Hold the latch plate (A) and push the button on the buckle (D).

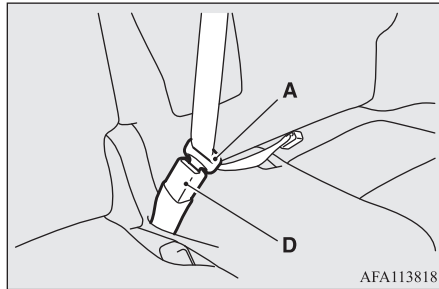

2. To release the buckle (C), press the button (F) with the latch plate (A).

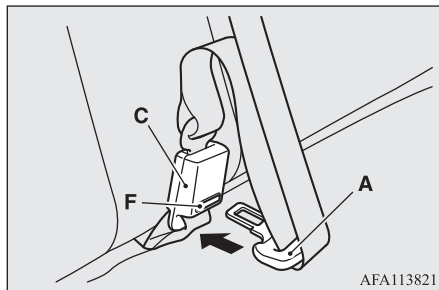

3. Retract the seat belt and remove it from the seat belt guide (E).

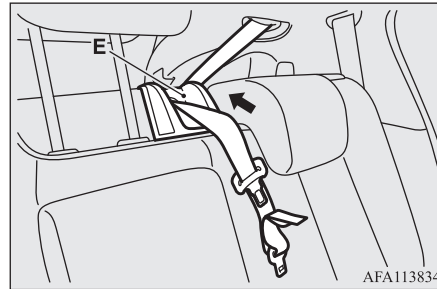

4. After the seat belt is retracted completely, insert the small latch plate (B) into the upper slit (G) and the latch plate (A) into the lower slit (H).

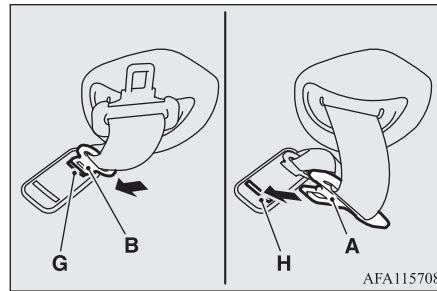

Rear seat belt storage

When the seat belt is not in use, store it as shown in the illustration.

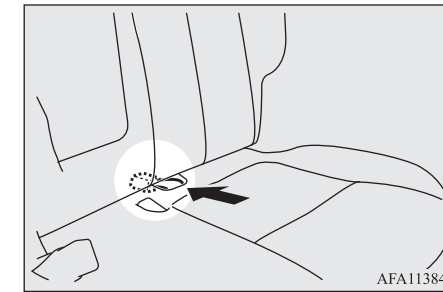

4

Seat belt plate storage

Outboard seating position

After passing the belt through the rear notch (A), insert the plate into the front notch (B).

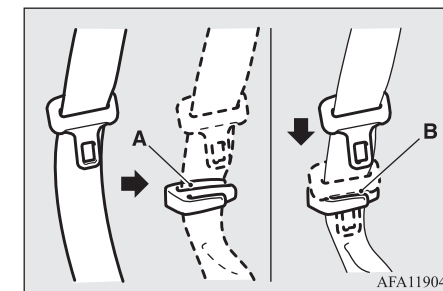

Pregnant women restraint

Centre seating position

Refer to “Rear-centre 3-point type seat belt” on page 4-11.

4

Pregnant women restraint

WARNING

- **Seat belts work for everyone, including pregnant women. Pregnant women should use the available seat belts. This will reduce the likelihood of injury to both the woman and the unborn child. The lap belt should be worn across the thighs and as snug against the hips as possible, but not across the waist. Consult your doctor if you have any additional questions or concerns.**

Seat belt pretensioner system and force limiter system

The driver’s seat, front passenger’s seat, and/or rear outboard seats each have a seat belt equipped with a pretensioner system and force limiter system.

Pretensioner system

When the ignition switch or the operation mode is under the following conditions, if there is a frontal impact or a side impact (vehicles equipped with SRS side airbags and SRS curtain airbags) severe enough to injure the driver, front passenger, and/or rear outboard passengers, the pretensioner system will retract their respective seat belts instantaneously, thus maximizing the seat belt’s effectiveness.

[Except vehicles equipped with keyless operation system]

The ignition switch is in the “ON” or “START” position.

[Vehicles equipped with keyless operation system]

The operation mode is in ON.

On vehicles equipped with the ERA-GLO-NASS, the pretensioner system will operate even when a rollover or overturning of the vehicle is detected.

WARNING

- **To obtain the best results from your pretensioner seat belt, make sure you have adjusted your seat correctly and wear your seat belt properly.**

CAUTION

- Installation of audio equipment or repairs in the vicinity of the pretensioner seat belts or floor console must be performed in line with MITSUBISHI MOTORS guidelines. It is important to do so because the work could affect the pretensioner systems.
- If you need to scrap the vehicle, please consult a MITSUBISHI MOTORS Authorized Service Point. It is important to do so because unexpected activation of the pretensioner seat belts could cause injuries.

NOTE

- The pretensioner seat belts will be activated if the vehicle suffers a severe impact, even if the seat belts are not worn.
- The pretensioner seat belts are designed to work only once. After the pretensioner seat belts have been activated, we recommend you have it replaced by a MITSUBISHI MOTORS Authorized Service Point.

SRS warning

The same warning lamp/display is shared by the SRS airbags and the pretensioner seat belts.

Refer to “SRS warning lamp/display” on page 4-37.

Force limiter system

In the event of a collision, each force limiter system will effectively absorb the load applied to the seat belt to minimize the impact to the passenger.

Child restraint

When transporting children in your vehicle, some type of child restraint system should always be used according to the size of the child. This is required by law in most countries.

The regulations concerning driving with children in the front seat may differ from country to country. You are advised to comply with the relevant regulations.

WARNING

- When possible, put children in the rear seat. Accident statistics indicate that children of all sizes and ages are safer when properly restrained in the rear seat rather than in the front seat.
- Holding a child in your arms is no substitute for a restraint system. Failure to use a proper restraint system can result in severe or fatal injury to the child.
- Each child restraint device or fixing is to be used only by one child.

WARNING

- When attaching a child restraint system to the rear seat, prevent the front seat-backs from touching the child's feet and child restraint system. Otherwise, the child could be seriously injured in the event of hard braking or a collision.

Caution for installing the child restraint on vehicles with a front passenger's airbag

The label shown here is attached on vehicles with a front passenger airbag.

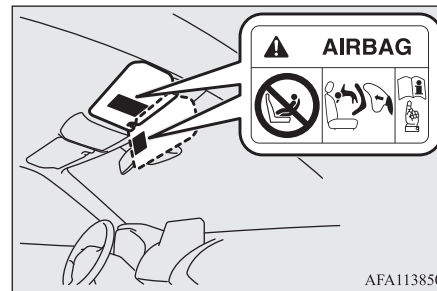

WARNING

- **Extreme Hazard!**
NEVER use a rearward facing child restraint on a seat protected by an ACTIVE AIRBAG in front of it, DEATH or SERIOUS INJURY to the CHILD can occur.

4

Use rearward facing child restraints in the rear seat or turn off the front passenger's airbag ON-OFF switch. (Refer to "To turn an airbag off" on page 4-30.)

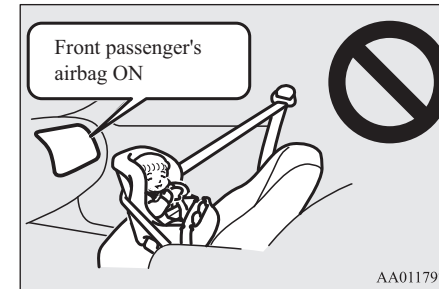

Child restraint

⚠ WARNING

4

- A **REARWARD FACING CHILD RESTRAINT** must **NOT** be used in the front passenger seat if the front passenger's airbag has not been deactivated. The force of an inflating airbag could kill or cause serious injuries to the child. A rearward facing child restraint should be used in the rear seat.
- A **FORWARD FACING CHILD RESTRAINT** should be used in the rear seat whenever possible; if it must be used in the front passenger seat, turn off the front passenger's airbag ON-OFF switch. Failure to do so could kill or cause serious injuries to the child.
- A **REARWARD FACING CHILD RESTRAINT** must **NOT** be used in the front passenger seat when driver's visibility is obstructed.

Infants and small children

When transporting infants and small children in your vehicle, follow the instruction given below.

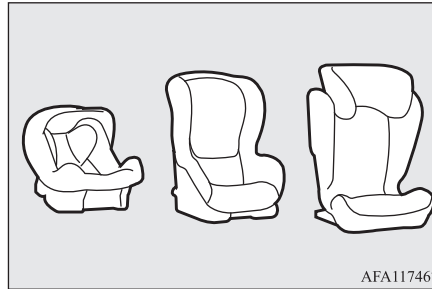

Instruction:

- For small infants, an infant carrier should be used. For small children whose height when seated allows the shoulder belt to lie in contact with the face or the throat, a child seat should be used.
- The child restraint system should be appropriate for the child's weight and height and properly fit in the vehicle. For a higher degree of safety: **THE CHILD RESTRAINT SYSTEM SHOULD BE INSTALLED IN THE REAR SEAT.**

- Before purchasing a child restraint system, try installing it in the rear seat to make sure there is a good fit. Because of the location of the seat belt buckles and the shape of the seat cushion, it may be difficult to securely install some manufacturer's child restraint systems. If the child restraint system can be pulled forward or to either side easily on the seat cushion after the seat belt has been tightened, choose another manufacturer's child restraint system.

⚠ WARNING

- **When installing a child restraint system, refer to the instructions provided by the manufacturer of the restraint system. Failure to do so can result in severe or fatal injury to the child.**
- **After installation, push and pull the child restraint system back and forth, and side to side, to see that it is properly secured. If the child restraint system is not installed securely, it may cause injury to the child or other occupants in the case of accident or sudden stops.**
- **When the child restraint system is not in use, keep your child restraint system secured with the seat belt or remove it from the vehicle in order to prevent it from being thrown around inside the vehicle during an accident.**

 **NOTE**

- Depending on the seating position in the vehicle and the child restraint system that you have, the child restraint can be attached using one of the following two ways:
 - Using the lower anchorage in the rear seat ONLY if the child restraint has ISOFIX mountings (See page 4-23).
 - Using the seat belt (See page 4-25).

Older children

Children who have outgrown the child restraint system should be seated in the rear seat and wear combination lap shoulder belt. The lap portion of the belt should be snug and positioned low on the abdomen so that it is below the top of the hip-bone. Otherwise, the belt could intrude into the child's abdomen during an accident and cause injury.

Child restraint

Suitability for various ISOFIX positions

4

Mass group	Size class	Fixture	Vehicle ISO-FIX positions*1	Recommended Child Restraint Systems*2	UN-R44 Approval No.	UN-R129 Approval No.
			Rear outboard			
Carrycot	F	ISO/L1	X	—	—	—
	G	ISO/L2	X	—	—	—
0 -Up to 10 kg	E	ISO/R1	IL	—	—	—
0+ - Up to 13 kg	E	ISO/R1	IL	—	—	—
	—	ISO/R2X	IL	—	—	—
	D	ISO/R2	IL, IL#	BABY-SAFE i-SIZE: MZ315055 BABY-SAFE i-SIZE FLEX BASE: MZ315056	—	E1-000008
	C	ISO/R3	IL	—	—	—
I -9 to 18 kg	—	ISO/R2X	IL	—	—	—
	D	ISO/R2	IL	—	—	—
	C	ISO/R3	IL	—	—	—
	B	ISO/F2	IUF	—	—	—
	B1	ISO/F2X	IUF, IL#	DUO plus: MZ313045	E1-04301133	—
	A	ISO/F3	IUF	—	—	—

*1: Vehicles with ISOFIX marking or i-Size marking. (Refer to “Lower anchorage location” on page 4-23

*2: MITSUBISHI MOTORS Europe B.V. reserves the right to changes without any prior announcement.

For detailed information, consult your MITSUBISHI MOTORS Authorized Service Point.

Mass group	Size class	Fixture	Vehicle ISO-FIX positions*1	Recommended Child Restraint Systems*2	UN-R44 Approval No.	UN-R129 Approval No.
			Rear outboard			
II & III -15 to 36 kg	—	—	IL#	KIDFIX XP: MZ315025	E1-04301304	—

4

*1: Vehicles with ISOFIX marking or i-Size marking. (Refer to “Lower anchorage location” on page 4-23)

*2: MITSUBISHI MOTORS Europe B.V. reserves the right to changes without any prior announcement.

For detailed information, consult your MITSUBISHI MOTORS Authorized Service Point.

CAUTION

- When installing a child restraint system, remove the head restraint from the seat.
- When installing a child restraint system, adjust the seat slide to its most rearward position.
- When installing a child restraint system on the rear seat, adjust the front seat to prevent the front seatback from touching the child’s feet and child restraint system.
- Do not sit in the centre seating position of the rear seat when installing a child restraint system on the left side of the rear seat.
- “BABY-SAFE i-SIZE” and “BABY-SAFE i-SIZE FLEX BASE” are designed for children 40 to 83 cm in height.

Definition of characters the above table:

- IUF- Suitable for ISOFIX forward child restraint systems of universal category approved for use in the mass group.
- IL- Suitable for ISOFIX child restraint systems of semi-universal category approved for use in the mass group.
- IL#- Suitable for particular ISOFIX child restraint systems. See the above table of “Recommended Child Restraint Systems”.
- X- ISOFIX position not suitable for ISOFIX child restraint systems in this mass group.

Child restraint

i-Size child restraint system (For vehicles with i-Size marking)

4

	Seating position *1	Recommended Child Restraint Systems *2	UN-R129 Approval No.
	Rear outboard		
i-Size child restraint system	i-U	BABY-SAFE i-SIZE: MZ315055 BABY-SAFE i-SIZE FLEX BASE: MZ315056	E1-000008

*1: Vehicles with i-Size marking. (Refer to “Lower anchorage location” on page 4-23.)

*2: MITSUBISHI MOTORS Europe B.V. reserves the right to changes without any prior announcement.

For detailed information, consult your MITSUBISHI MOTORS Authorized Service Point.

⚠ CAUTION

- When installing a child restraint system, remove the head restraint from the seat.
- When installing a child restraint system, adjust the seat slide to its most rearward position.
- When installing a child restraint system on the rear seat, adjust the front seat to prevent the front seatback from touching the child’s feet and child restraint system.
- Do not sit in the centre seating position of the rear seat when installing a child restraint system on the left side of the rear seat.
- “BABY-SAFE i-SIZE” and “BABY-SAFE i-SIZE FLEX BASE” are designed for children 40 to 83 cm in height, and up to 13 kg in weight.

Definition of characters the above table:

- i-U- Suitable for i-Size “universal” child restraint system forward and rearward facing.

Suitability for various seating positions

Mass group	Seating position				Recommended Child Restraint System *1	UN-R44 Approval No.	UN-R129 Approval No.
	Front passenger		Rear out-board	Rear centre			
	Activated air-bag	Deactivated airbag*2					
0 -Up to 10 kg	X	U	U	X	—	—	
0+ - Up to 13 kg	X	U, L#	U, L#	X	BABY-SAFE i-SIZE: MZ315055	E1-000008	
I -9 to 18 kg	X	U, L#	U, L#	X	DUO plus: MZ313045	E1-04301133	
II & III -15 to 36 kg	X	U*3, L#	U*3, L#	X	KIDFIX XP: MZ315025	E1-04301304	

*1: MITSUBISHI MOTORS Europe B.V. reserves the right to changes without any prior announcement. For detailed information, consult your MITSUBISHI MOTORS Authorized Service Point.

*2: With front passenger's airbag deactivated by means of front passenger's airbag ON-OFF switch

*3: Do not remove the head restraint when installing a booster cushion.

CAUTION

- When installing a child restraint system, remove the head restraint from the seat. However, do not remove the head restraint when installing a booster cushion ("Lower anchorage position" on page 4-25).
- When installing a child restraint system, adjust the seat slide to its most rearward position.
- When installing a child restraint system on the rear seat, adjust the front seat to prevent the front seatback from touching the child's feet and child restraint system.
- Do not sit in the centre seating position of the rear seat when installing a child restraint system on the left side of the rear seat.
- "BABY-SAFE i-SIZE" is designed for children 40 to 83 cm in height.

Child restraint

Definition of characters the above table:

- U- Suitable for “universal” category restraints approved for use in this mass group.
- L#- Suitable for particular child restraint systems. See the above table of “Recommended Child Restraint Systems”.
- X- Seat position not suitable for children in this mass group.

4

Booster seat

	Seating position			
	Front passenger		Rear outboard	Rear centre
	Activated airbag	Deactivated Airbag* ¹		
Booster fixture	X	B2, B3	B2, B3	X

*1: With front passenger’s airbag deactivated by means of front passenger’s airbag ON-OFF switch.

CAUTION

- When installing a child restraint system, remove the head restraint from the seat.

Definition of characters to be inserted in the table above:

- B2 - Suitable for ISO/B2 booster fixture.
- B3 - Suitable for ISO/B3 booster fixture.
- X- Seating position not suitable for booster seats.

Installing a child restraint system to the lower anchorage (ISOFIX child restraint mountings) and tether anchorage

Lower anchorage location

Your vehicle's rear seat is fitted with lower anchorages for attaching a child restraint system with ISOFIX mountings.

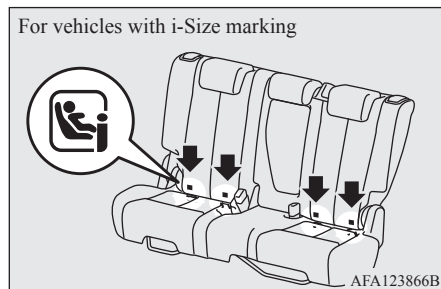
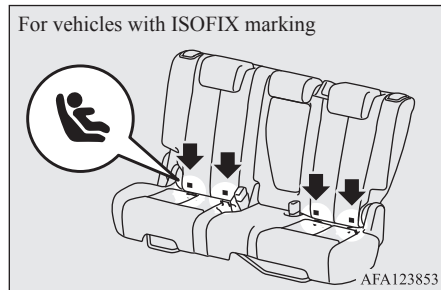

Tether anchorage locations

Your vehicle has two child restraint anchorage points on the backside of the rear seats. These are for securing a child restraint system tether strap to each of the two rear seating positions in your vehicle.

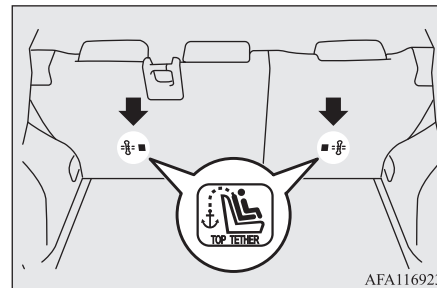

WARNING

- Child restraint anchorages are designed to withstand only those loads imposed by correctly fitted child restraints. Under no circumstances are they to be used for adult seat belts, harnesses, or for attaching other items or equipment to the vehicle.

CAUTION

- Do not sit in the centre seating position of the rear seat when installing a child restraint system on the left side of the rear seat. Because the child restraint interferes with the seat belt, you cannot fasten the seat belt correctly.

4

Child restraint system with ISOFIX mountings

The child restraint system is designed only for seats that incorporate lower anchorages. Retain the child restraint system using the lower anchorages.

It is not necessary to retain the child restraint system using the vehicle's seat belts.

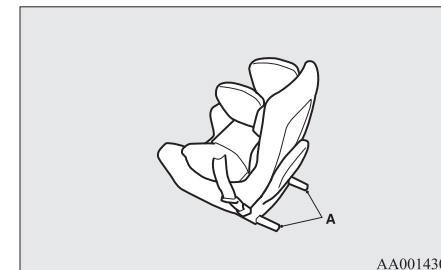

A- Child restraint system connectors

Child restraint

To install

NOTE

- On vehicles with the cargo area cover, install the cargo area cover in the rear position or remove it.
Refer to “Cargo area cover” on page 7-86.

4

1. Remove any foreign material in or around the connectors and ensure the vehicle seat belt is in its normal storage position.
2. Remove the head restraint from the location in which you wish to install a child restraint.
Refer to “Head restraints” on page 4-05.
3. Adjust the rear seat slide to its most rearward position.
Refer to “Rear seats” on page 4-03.
4. Push the child restraint system’s connectors (A) into the lower anchorages (B) in accordance with the instructions provided by the child restraint system’s manufacturer.

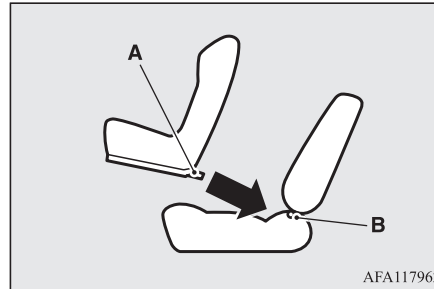

A: Connector

B: Lower anchorage

If your child restraint system has a support leg, make sure that there is a support leg at the stable position on the floor.

If your child restraint system requires the use of a tether strap, fasten the tether strap in accordance with step 5.

5. Latch the tether strap hook (C) of the child restraint system to the tether anchorage bar (D) and tighten the top tether strap hook so it is securely fastened.

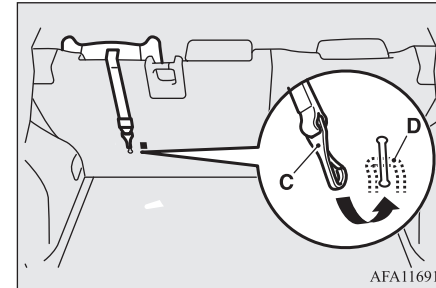

6. Push and pull the child restraint system in all directions to be sure it is secured.

To remove

Remove the child restraint system in accordance with the instructions provided by the child restraint system’s manufacturer.

Installing a child restraint system to a 3-point type seat belt (with emergency locking mechanism)

⚠ CAUTION

- Do not sit in the centre seating position of the rear seat when installing a child restraint system on the left side of the rear seat. Because the child restraint interferes with the seat belt, you cannot fasten the seat belt correctly.

To install

1. Put a child restraint system on the seat in which you wish to install it, and remove the head restraint from the seat. Refer to “Head restraints” on page 4-05.

⚠ CAUTION

- Do not remove the head restraint when installing a booster cushion.

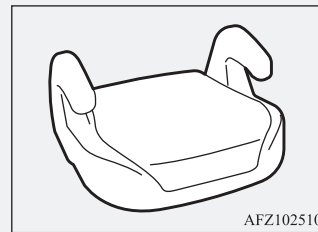

2. When installing a child restraint system in the front passenger seat or rear seat, adjust the seat slide to its most rearward position.
3. Route the belt through the child restraint according to the child restraint system manufacturer's instructions, then insert the latch plate into the buckle.
4. Use the locking clip to completely eliminate any slackness.

⚠ WARNING

- For some types of child restraint, the locking clip (A) should be used to help avoid personal injury during a collision or sudden manoeuvre. It must be fitted and used in accordance with the child restraint manufacturer's instructions. The locking clip must be removed when the child restraint is removed.

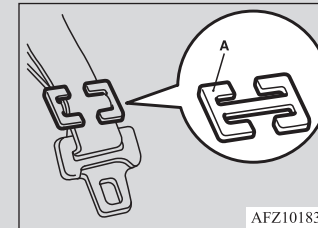

5. If your child restraint system has a support leg, make sure that there is a support leg at the stable position on the floor.
6. Before putting the child in the restraint, push and pull the restraint in all directions to be sure it is secure. Do this before each use.

4

Seat belt inspection

To remove

Remove the plate from the buckle, then remove the seat belt from the child restraint system.

4

Seat belt inspection

Check the belts for cuts, worn or frayed webbing and for cracked or deformed metallic parts. Replace the belt assembly if it is defective.

⚠ WARNING

- We recommend you to have all seat belt assemblies including retractors and attaching hardware inspected after any collision. We recommend that seat belt assemblies in use during a collision be replaced unless the collision was minor and the belts show no damage and continue to operate properly.
- Do not attempt to repair or replace any part of the seat belt assemblies; we recommend you to have this work done by a MITSUBISHI MOTORS Authorized Service Point. Incorrect repair or replacement could reduce the effectiveness of the belts and could result in serious injury in the event of a collision.

⚠ WARNING

- Once the pretensioner has been activated, it cannot be re-used. It must be replaced together with the retractor.
- Do not insert any foreign objects (pieces of plastic, paper clips, buttons, etc.) in the buckle or retractor mechanism. In addition, do not modify, remove or install the seat belt. Otherwise, the seat belt may not be able to provide adequate protection in a collision or other situation.



- A dirty belt should be cleaned with neutral detergent in warm water. After rinsing in water, let it dry in the shade. Do not attempt to bleach or re-dye the belts because this will affect their characteristics.

Supplemental restraint system (SRS) - airbag

The information for SRS airbags includes important information concerning the driver's and front passenger's airbags, the driver's knee airbag, the side airbags and the curtain airbags.

The SRS driver's and front passenger's airbags are designed to supplement the primary protection of the driver and front passenger side seat belt systems by providing those occupants with protection against head and chest injuries in certain moderate-to-severe frontal collisions.

The SRS driver's knee airbag (if so equipped) is designed to supplement the primary protection of the driver's seat belt system. It can reduce the forward movement of the driver's lower legs and provide increased overall body protection in certain moderate-to-severe frontal collisions.

The SRS side airbags (if so equipped) are designed to supplement properly worn seat belts and provide the driver and front passenger with protection against chest injuries in certain moderate-to-severe side impact collisions.

Supplemental restraint system (SRS) - airbag

The SRS curtain airbags (if so equipped) are designed to supplement properly worn seat belts and provide the driver and passenger with protection against head injuries in certain moderate-to-severe side impact collisions.

On vehicles equipped with the ERA-GLO-NASS, the SRS curtain airbags will also deploy when a rollover of the vehicle is detected and the curtain airbags are also designed to help reduce the risk of complete and partial ejection from the vehicle through side windows in both side impact and rollover type accidents.

The SRS is NOT a substitute for the seat belts. To ensure the maximum protection during all types of collisions and accidents, all occupants, including the passengers as well as the driver, must wear their seat belts.

NOTE

- The SOS emergency assistance (if so equipped) is designed to operate when any of the airbags deploy or a severe collision occurs. Refer to “Telematics Control Unit (TCU)*” on page 2-05.
- The ERA-GLONASS (if so equipped) is designed to operate when any of the airbags deploy or a severe collision occurs. Refer to “ERA-GLONASS” on page 8-02.

How the Supplemental Restraint System works

The SRS includes the following components:

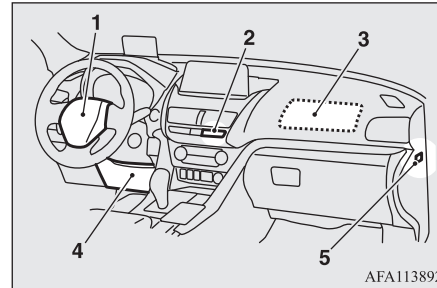

- 1- Airbag module (Driver)
- 2- Front passenger's airbag indicator
- 3- Airbag module (Passenger)
- 4- Driver's knee airbag module*

- 5- Front passenger's airbag ON-OFF switch

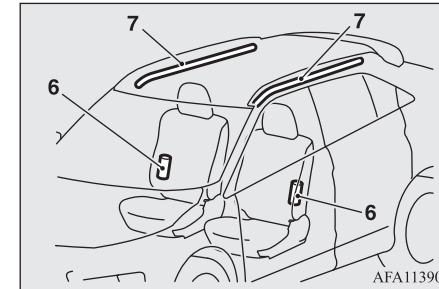

6. Side airbag modules*
7. Curtain airbag modules*

Only when the ignition switch or the operation mode is under the following conditions, the airbags will operate.

[Except vehicles equipped with keyless operation system]

The ignition switch is in the “ON” or “START” position.

[Vehicles equipped with keyless operation system]

The operation mode is in ON.

On vehicles equipped with the ERA-GLO-NASS, when the airbag control unit detects a rollover of the vehicle, the curtain airbags will be deployed.

4

Supplemental restraint system (SRS) - airbag

4

The airbags deployment produces a sudden, loud noise, and releases some smoke and powder, but these conditions are not injurious, and do not indicate a fire in the vehicle. People with respiratory problems may feel some temporary irritation from chemicals used to produce the deployment; open the windows after airbag deployment, if safe to do so.

The airbags deflate very rapidly after deployment, so there is little danger of obscured vision.

⚠ CAUTION

- Airbags inflate at an extremely rapid speed. In certain situations, contact with inflating airbags can result in abrasions, bruises, light cuts, and the like.

⚠ WARNING

- **IT IS VERY IMPORTANT TO BE PROPERLY SEATED.**

A driver or front passenger too close to the steering wheel or instrument panel during airbag deployment can be killed or seriously injured.

Airbags inflate very fast, and with great force.

If the driver and front passenger are not properly seated and restrained, the airbags may not protect you properly, and could cause serious or fatal injuries when it inflates.

- Do not sit on the edge of the seat, or sit with your lower legs too close to the instrument panel, or lean head or chest close to the steering wheel or instrument panel. Do not put feet or legs on or against the instrument panel.

⚠ WARNING

- Place all infants and small children in the rear seat and properly restrained using an appropriate child restraint system. The rear seat is the safest place for infants and children.



⚠ WARNING

- Infants and small children should never be unrestrained, stand up against the instrument panel or be held in your arms or on your lap. They could be seriously injured or killed in a collision, including when the airbag inflates. They should be properly seated in the rear seat in an appropriate child restraint system. Refer to “Child restraint” on page 4-15.



AFZ102086

- Older children should be seated in the rear seat, properly wearing the seat belt, with an appropriate booster cushion if needed.

Caution for installing the child restraint on vehicle with front passenger’s airbag

The label shown here is attached on vehicles with front passenger’s airbag.

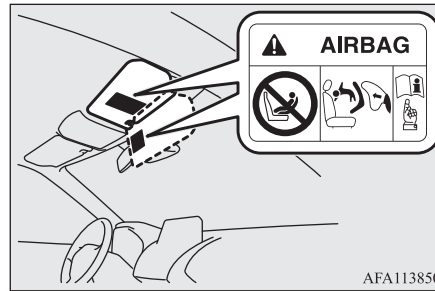

⚠ WARNING

- **Extreme Hazard!**
NEVER use a rearward facing child restraint on a seat protected by an ACTIVE AIRBAG in front of it, DEATH or SERIOUS INJURY to the CHILD can occur.

Front passenger’s airbag ON-OFF switch

The front passenger’s airbag ON-OFF switch can be used to disable the front passenger’s airbag. If you have a child restraint system that cannot be fitted to any seat other than the front passenger seat, be sure to turn OFF the front passenger’s airbag ON-OFF switch before using it.

(Refer to “To turn an airbag off” on page 4-30)

The front passenger’s airbag ON-OFF switch is located as shown in the illustration.

4

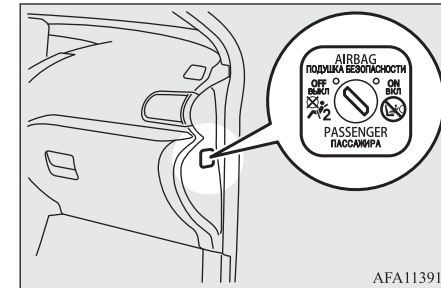

Supplemental restraint system (SRS) - airbag

Front passenger's airbag indicator

The front passenger's airbag indicator is located in the instrument panel.

4

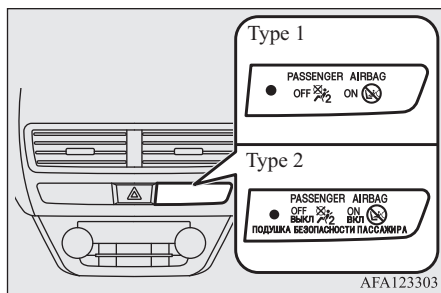

Both indicators normally come on when the ignition switch is turned to the “ON” position or the operation mode is put in ON, and goes off a few seconds later.

When the front passenger's airbag ON-OFF switch is turned OFF, the OFF indicator will stay on to show that the front passenger's airbag is not operational. When the front passenger's airbag ON-OFF switch is turned ON, the OFF indicator goes off, and the ON indicator comes on for approximately 1 minute to show that the front passenger's airbag is operational.

WARNING

- Do not fit any accessory that makes the indication lamp impossible to see, and do not cover the indication lamp with a sticker. You would not be able to verify the status of the passenger airbag system.

To turn an airbag off

WARNING

- To reduce risk of serious or fatal injury:
 - Always turn the ignition switch to the “LOCK” position or put the operation mode in OFF, before operating the front passenger's airbag ON-OFF switch. Failure to do so could adversely affect the airbag performance.
 - Wait at least 60 seconds to operate the front passenger's airbag ON-OFF switch after turning the ignition switch to the “LOCK” position or putting the operation mode in OFF.
The SRS airbag system is designed to retain enough voltage to deploy the airbag.
 - Always remove the key from the front passenger's airbag ON-OFF switch after operating that switch. Failure to do so could lead to improper position of the front passenger's airbag ON-OFF switch.

WARNING

- Do not turn OFF the front passenger's airbag ON-OFF switch except when a child restraint system is fitted to the front passenger seat.
- If the OFF indicator does not come on when the front passenger's airbag ON-OFF switch is turned OFF, do not fit a child restraint system to the front passenger seat. We recommend you to have the system inspected by a MITSUBISHI MOTORS Authorized Service Point.
- If the OFF indicator remains on when the front passenger's airbag ON-OFF switch is turned ON, do not allow anyone to sit on the front passenger seat. We recommend you to have the system inspected by a MITSUBISHI MOTORS Authorized Service Point.

To turn an airbag off, follow these steps:

1. Insert the key into the front passenger's airbag ON-OFF switch, and turn it to the “OFF” position.

NOTE

- If the vehicle is equipped with the keyless operation system, use the emergency key. Refer to “Emergency key” on page 3-16.

2. Remove the key from the front passenger's airbag ON-OFF switch.

- Turn the ignition switch to the “ON” position or put the operation mode in ON. The front passenger’s airbag OFF indication lamp will stay on.

The driver’s airbag and the front passenger’s airbag are designed to inflate at the same time even if the passenger seat is not occupied.

Driver’s knee airbag system*

The driver’s knee airbag is located under the steering wheel. The driver’s knee airbag is designed to deploy at the same time as the driver’s front airbag.

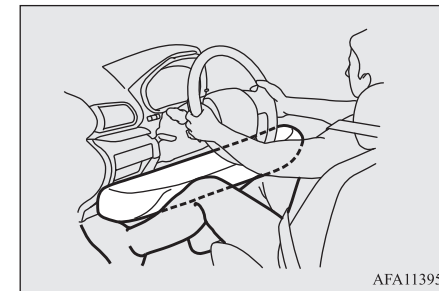
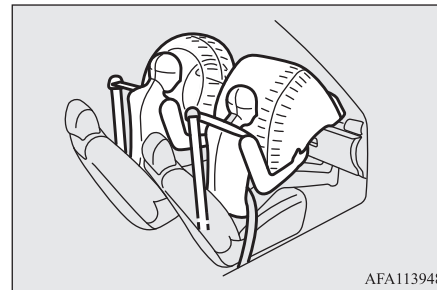
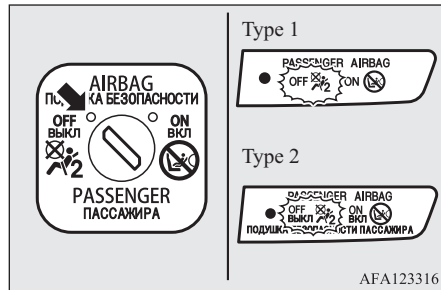

4

The front passenger’s airbag is now deactivated and will not deploy until switched on again.

Driver’s and front passenger’s airbag system

The driver’s airbag is located under the padded cover in the middle of the steering wheel. The front passenger’s airbag is contained in the instrument panel above the glove box.

Supplemental restraint system (SRS) - airbag

Deployment of front airbags and driver's knee airbag

4

The front airbags and driver's knee airbag ARE DESIGNED TO DEPLOY when...

The front airbags and driver's knee airbag are designed to deploy when the vehicle suffers a moderate to severe frontal impact. The typical condition is shown in the illustration.

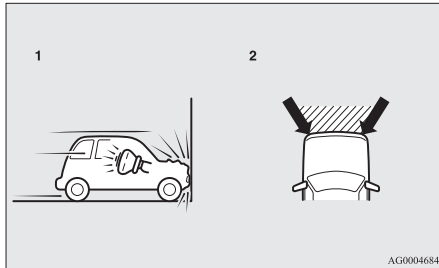

- 1- Head-on collision with a solid wall at a speed of approximately 25 km/h (16 mph) or higher
- 2- Moderate-to-severe frontal impact within the shaded area between the arrows

The front airbags and driver's knee airbag will deploy if the severity of impact is above the designed threshold level, comparable to an approximately 25 km/h (16 mph) collision when impacting straight into a solid wall that does not move or deform. If the severity of the impact is below the above threshold level, the front airbags and driver's knee airbag may not deploy. However, this threshold speed will be considerably higher if the vehicle strikes an object that absorbs the impact by either deforming or moving (for example, another stationary vehicle, pole or a guard rail).

Because frontal collisions can easily move you out of position, it is important to always properly wear your seat belts. Your seat belts will help keep you a safe distance from the steering wheel and instrument panel during the initial stages of airbag deployment. The initial stage of airbag inflation is the most forceful, and can possibly cause serious or fatal injuries. Moreover, the seat belts in your vehicle are your primary means of protection in a collision. The SRS airbags are designed to provide additional protection. Therefore, for your safety and the safety of all occupants, be sure to always properly wear your seat belts.

The front airbags and driver's knee airbag MAY NOT DEPLOY when...

With certain types of frontal collisions, the vehicle's body structure is designed to absorb the shock to help protect the occupants from harm. (The vehicle body's front area may deform significantly as it absorbs the impact.) Under such circumstances, the front airbags and driver's knee airbag may not deploy irrespective of the deformation and damage to the vehicle body.

Examples of some typical conditions are shown in the illustration.

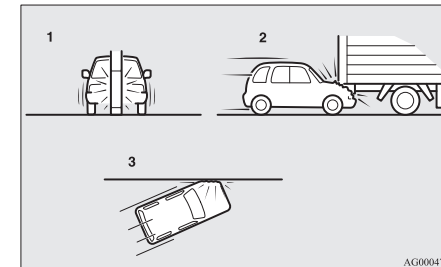

- 1- Collision with a utility pole, tree or other narrow object
- 2- Vehicle slides under the rear body of a truck
- 3- Oblique frontal impacts

Because the front airbags and driver's knee airbag do not protect the occupant in all types of frontal collisions, be sure to always properly wear your seat belts.

The front airbags and driver's knee airbag ARE NOT DESIGNED TO DEPLOY when...

The front airbags and driver's knee airbag are not designed to deploy in conditions where they cannot typically provide protection to the occupant. Such conditions are shown in the illustration.

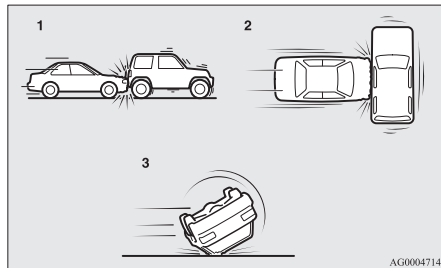

- 1- Rear end collisions
- 2- Side collisions
- 3- Vehicle rolls onto its side or roof

Because the front airbags and driver's knee airbag do not protect the occupant in all types of collisions, be sure to always properly wear your seat belts.

The front airbags and driver's knee airbag MAY DEPLOY when...

The front airbags and driver's knee airbag may deploy if the bottom of the vehicle suffers a moderate-to-severe impact (undercarriage damage).

Examples of some typical conditions are shown in the illustration.

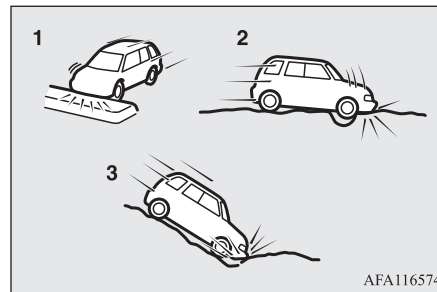

- 1- Collision with an elevated median/island or kerb
- 2- Vehicle travels over a deep hole/pothole
- 3- Vehicle drives down a steep slope and hits the ground

Because the front airbags and driver's knee airbag may deploy in certain types of unexpected impacts as shown in the illustration that can easily move you out of position, it is important to always properly wear your seat belts. Your seat belts will help keep you a safe distance from the steering wheel and instrument panel during the initial stages of airbag deployment. The initial stage of airbag inflation is the most forceful and can possibly cause serious or fatal injuries if you contact it at this stage.

4

WARNING

- Do not attach anything to the steering wheel's padded cover, such as badges or accessories. It might strike and injure an occupant if the airbag inflates.
- Do not set anything on, or attach anything to, the instrument panel above the glove box. It might strike and injure an occupant if the airbag inflates.

AFZ102099

Supplemental restraint system (SRS) - airbag

4

⚠ WARNING

- Do not attach accessories to, or put them in front of, the windscreen. These objects could restrict the airbag inflation, or strike and injure an occupant if the airbags inflate.
- Do not attach additional keys or accessories (hard, pointed or heavy objects) to the ignition key. Such objects could prevent the driver's knee airbag from inflating normally or could be propelled to cause serious injury if the airbag inflates.
- Do not attach accessories to the lower portion of the driver's side instrument panel. Such objects could prevent the driver's knee airbag from inflating normally or could be propelled to cause serious injury if the airbag inflates.

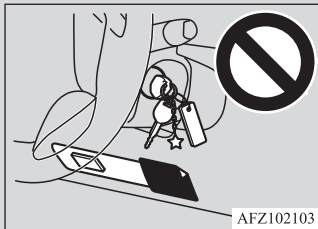

- Do not put packages, pets or other objects between the airbags and the driver or front passenger. It could affect airbag performance, or could cause injury when the airbag inflates.

⚠ WARNING

- Right after the airbag inflation, several airbag system components will be hot. Do not touch these components. There is a danger of being burnt.
- The airbag system is designed to work only once. Once the airbags have deployed, they will not work again. They must promptly be replaced and we recommend you to have the entire airbag system inspected by a MITSUBISHI MOTORS Authorized Service Point.

Side airbag system*

The side airbags (A) are contained in the driver and front passenger seatbacks. The side airbag is designed to inflate only on the side of the vehicle that is impacted, even with no passenger in the front seat.

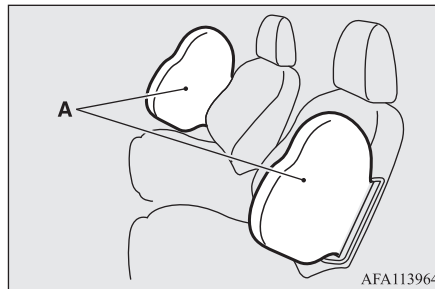

The label shown here is attached to the seatbacks with a side airbag.



Curtain airbag system*

The curtain airbags are contained in the roof side rail. The curtain airbag is designed to inflate only on the side of the vehicle that is impacted, even with no passenger in the front seat or rear seat.

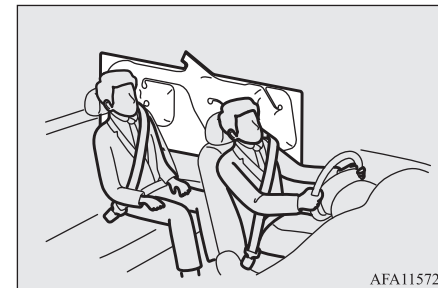

Deployment of side airbags and curtain airbags

The side airbags and curtain airbags ARE DESIGNED TO DEPLOY when...

The side airbags and curtain airbags are designed to deploy when the vehicle suffers a moderate-to-severe side impact to the middle of the passenger compartment. The typical condition is shown in the illustration.

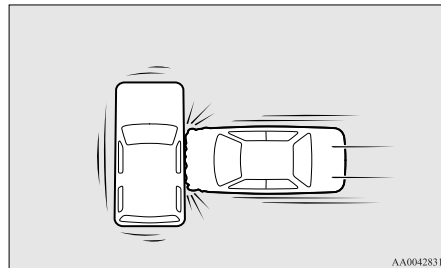

On vehicles equipped with the ERA-GLO-NASS, when the airbag control unit detects a rollover of the vehicle, the curtain airbags will deploy.

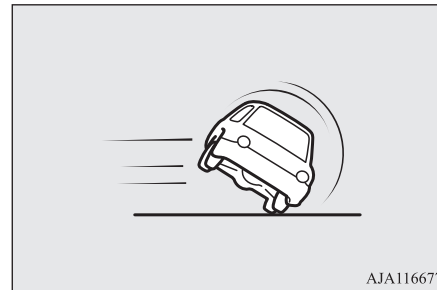

The seat belts in your vehicle are your primary means of protection in a collision. The SRS side airbags and curtain airbags are designed to provide additional protection. Therefore, for your safety and the safety of all occupants, be sure to always properly wear your seat belts.

The side airbags and curtain airbags MAY NOT DEPLOY when...

With certain types of side collisions, the vehicle's body structure is designed to absorb the shock to help protect the occupants from harm. (The vehicle body's side area may deform significantly as it absorbs the impact.) Under such circumstances, the side airbags and curtain airbags may not deploy irrespective of the deformation and damage to the vehicle body. Examples of some typical conditions are shown in the illustration.

4

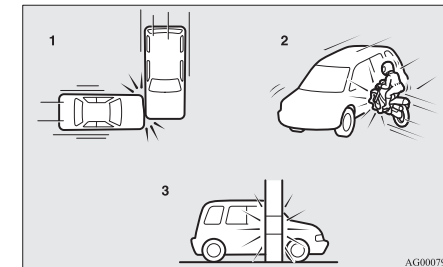

- 1- Side impacts in an area away from the passenger compartment
- 2- Motorcycle or other similar small vehicle collides with the side of vehicle

Supplemental restraint system (SRS) - airbag

- 3- Collision with a utility pole, tree or other narrow object

The side airbags and curtain airbags ARE NOT DESIGNED TO DEPLOY when...

- 2- Rear end collisions
- 3- Pitch end over end

4

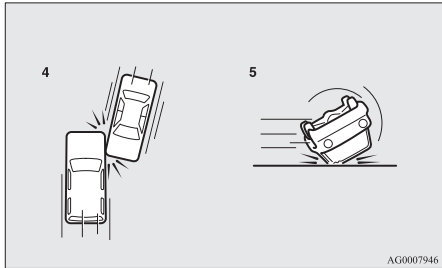

- 4- Oblique side impacts
- 5- Vehicle rolls onto its side or roof*

Because the side airbags and curtain airbags do not protect the occupant in all types of side collisions, be sure to always properly wear your seat belts.

The side airbags and curtain airbags are not designed to deploy in conditions where they cannot usually provide protection to the occupant. Typical conditions are shown in the illustration.

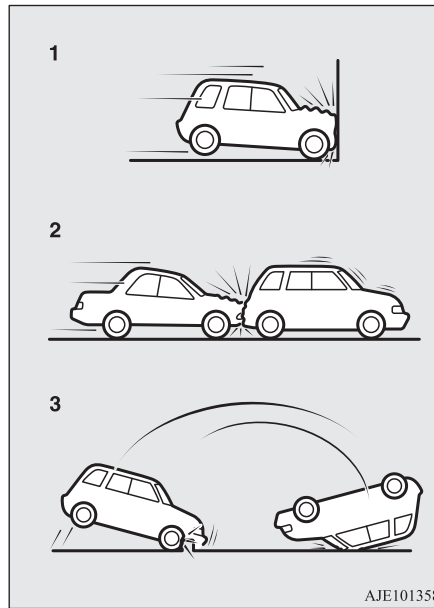

- 1- Head-on collisions

OGKE20E1

WARNING

- The side airbags and curtain airbags are designed to supplement the driver and passenger seat belts in certain side impacts. Seat belts should always be worn properly, and the driver and passenger should sit well back and upright without leaning against the window or door.
- The side airbag and curtain airbag inflate with great force. The driver and passenger should not put their arms out of the window, and should not lean against the door, in order to reduce the risk of serious or possible fatal injury from the deploying side airbag and curtain airbag.

Two illustrations showing prohibited actions: leaning against the window and putting arms out of the window. The first illustration shows a person leaning against the window with a 'no' symbol over it. The second illustration shows a person putting their arm out of the window with a 'no' symbol over it.

*: On vehicles equipped with the ERA-GLO-NASS, when the vehicle rolls onto its side or roof, the curtain airbags will deploy.

⚠ WARNING

- Do not allow any rear seat occupant to hold onto the seatback of either front seat, in order to reduce risk of injury from the deploying side airbag. Special care should be taken with children.
- Do not place any objects near or in front of the seatback of either front seat. They could interfere with proper side airbag inflation, and also could cause injury if thrown free by side airbag deployment.
- Do not place stickers, labels or additional trim on the seatback of either front seat. They could interfere with proper side airbag inflation.
- Do not install seat covers on seats with side airbags.
Do not re-cover seats that have side airbags. This could interfere with proper side airbag inflation.

⚠ WARNING

- Do not attach a microphone (A) or any other device or object around the part where the curtain airbags (B) activate such as on the windscreen, side door glass, front and rear pillars and roof side or assist grips. When the curtain airbags inflate, the microphone or other device or object will be hurled with great force or the curtain airbags may not activate correctly, resulting in death or serious injury.

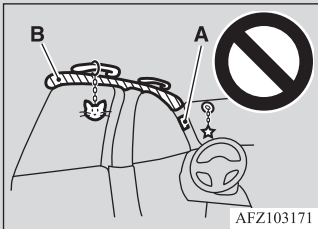

AFZ103171

- Do not put a hanger or any heavy or pointed object on the coat hook. If the curtain airbag was activated, any such item could be propelled away with great force and could prevent the curtain airbag from inflating correctly. Hang clothes directly on the coat hook (without using a hanger). Make sure there are no heavy or sharp objects in the pockets of clothes that you hang on the coat hook.

⚠ WARNING

- Do not allow a child to lean against or close to the front door even if the child is seated in a child restraint system. The child's head should also not lean against or be close to the area where the side airbag and curtain airbag are located. It is dangerous if the side airbag and curtain airbag inflate. Failure to follow all of these instructions could lead to serious or fatal injury to the child.
- We recommend work around and on the side airbags and curtain airbags system to be done by a MITSUBISHI MOTORS Authorized Service Point.

4

SRS warning lamp/display

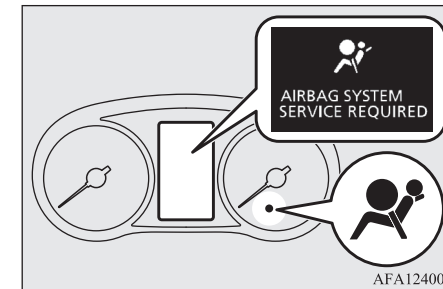

Supplemental restraint system (SRS) - airbag

4

There is a Supplemental Restraint System (“SRS”) warning lamp on the instrument panel. The system checks itself every time the ignition switch is turned to the “ON” position or the operation mode is put in ON. The SRS warning lamp will come on for several seconds and then go out. This is normal and means the system is working properly. If there is a problem involving one or more of the SRS components, the warning lamp will come on and stay on. At the same time, the warning display will appear on the information screen in the multi-information display. The SRS warning lamp/display is shared by the SRS airbag and the seat belt pretensioner system.

WARNING

- If any of the following conditions occur, there may be a problem with the SRS airbags and/or seat belt pretensioners, and they may not function properly in a collision or may suddenly activate without a collision:
 - Even when the ignition switch in the “ON” position or the operation mode is in ON, the SRS warning lamp does not come on or it remains on.
 - The SRS warning lamp and/or the warning display comes on while driving.
- The SRS airbags and seat belt pretensioners are designed to help reduce the risk of serious injury or death in certain colli-

WARNING

sions. If either of the above conditions occurs, immediately have your vehicle checked by a MITSUBISHI MOTORS Authorized Service Point.

NOTE

- On vehicles equipped with the ERA-GLO-NASS, if the ERA-GLO-NASS system operates, the SRS warning lamp illuminates.

SRS servicing

WARNING

- We recommend any maintenance performed on or near the components of the SRS to be performed by a MITSUBISHI MOTORS Authorized Service Point. Improper work on the SRS components or wiring could result in inadvertent deployment of the airbags, or could render the SRS inoperative; either situation could result in serious injury.
- Do not modify your steering wheel, seat belt retractor or any other SRS components. For example, replacement of the steering wheel, or modifications to the front bumper or body structure can adversely affect SRS performance and lead to possible injury.

WARNING

- If your vehicle has sustained any damage, we recommend you to have the SRS inspected to ensure it is in proper working order.
- Do not modify your front seats, centre pillar and centre console. It can adversely affect SRS performance and lead to possible injury.
- If you found any tear, scratch, crack or damage to the portion where the airbag is stored, you should have the SRS inspected by a MITSUBISHI MOTORS Authorized Service Point.

NOTE

- If your vehicle has to be scrapped, do this in line with local legislation and contact a MITSUBISHI MOTORS Authorized Service Point to safely dismantle the airbag system.

Instruments and controls

Instruments.....	5-02
Multi-information display.....	5-02
Indication lamp, warning lamp, and information screen display list.....	5-21
Indication lamps.....	5-47
Warning lamps.....	5-47
Information screen display.....	5-49
Head Up Display (HUD)*.....	5-51
Combination headlamps and dipper switch.....	5-56
Headlamp levelling.....	5-63
Turn-signal lever.....	5-65
Hazard warning flasher switch.....	5-65
ECO mode switch*.....	5-66
Fog lamp switch.....	5-67
Wiper and washer switch.....	5-68
Rear window demister switch.....	5-72
Heated windscreen switch*.....	5-73
Heated steering wheel switch*.....	5-74
Horn switch.....	5-74

Instruments

Instruments

5

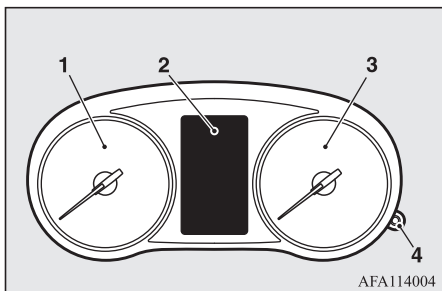

1- Tachometer

The tachometer indicates the engine speed (r/min). The tachometer helps you to obtain more economical driving and also warns you of excessive engine speeds (Red zone).

2- Multi-information display → p. 5-02

Information screen display → p. 5-22

3- Speedometer (km/h or mph + km/h)

4- Rheostat illumination button → p. 5-02

CAUTION

- When driving, watch the tachometer to make sure that the engine speed indication does not rise into the red zone (excessive engine rpm).

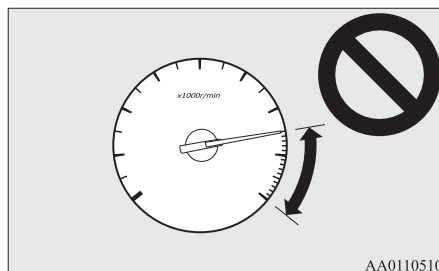

Meter illumination control

Each time you press the rheostat illumination button, there is a sound and the brightness of the instruments changes.

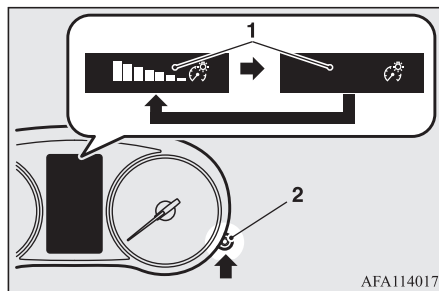

1- Brightness level

2- Reostat illumination button

NOTE

- You can adjust to 8 different levels respectively for when the position lamps are illuminated and when they are not.
- The meter illumination switches automatically to the adjusted brightness, depending on the brightness outside the vehicle.
- The brightness level of the instruments is stored when the ignition switch is turned off or the operation mode is put in OFF.
- If you press and hold the button for approximately 2 seconds or more when the position lamps are illuminated, the brightness level changes to the maximum level. Pressing and holding the button for approximately 2 seconds or more again returns the brightness level to the previous level.

On vehicles equipped with the Smartphone Link Display Audio or MITSUBISHI Multi-Communication System (MMCS), the map screen colour may not be switched to night-time setting when the meter illumination brightness level is at the maximum.

Multi-information display

Always stop the vehicle in a safe place before operating.

The following information is included on the multi-information display: warnings, odometer, tripmeter, average and instant fuel consumption, average speed, etc.

[When the ignition switch or the operation mode is OFF]

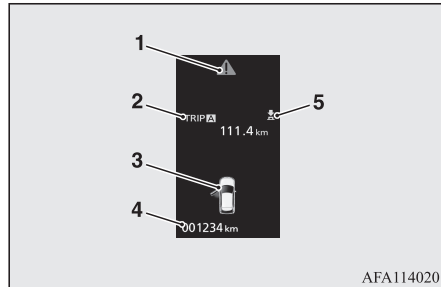

AFA114020

- 1- mark display screen → p. 5-06
- 2- Information screen → p. 5-04
Interrupt display screen → p. 5-06
- 3- Door ajar warning display screen → p. 5-07
- 4- Odometer → p. 5-08
- 5- mark indicator → p. 5-06

[When the ignition switch or the operation mode is ON]

5

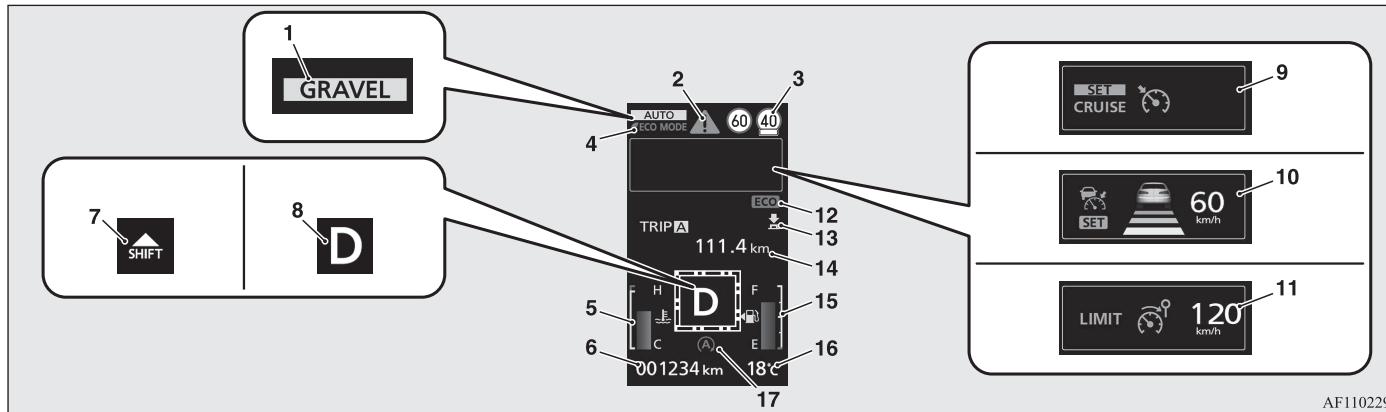

AF1102294

- 1- S-AWC (Super-All Wheel Control) drive mode display screen* → p. 6-52
- 2- mark display screen → p. 5-06
- 3- “Traffic Sign Recognition (TSR)”* on page 6-117
- 4- ECO mode indicator display screen* → p. 5-66
- 5- Engine coolant temperature display → p. 5-07
- 6- Odometer → p. 5-08
- 7- Gearshift indicator display screen* → p. 6-35, 6-46
- 8- Selector lever position display screen* → p. 6-46
- 9- SET CRUISE screen
- 10- SET 60 km/h screen
- 11- LIMIT 120 km/h screen
- 12- ECO indicator
- 13- TRIP 111.4 km
- 14- AUTO ECO MODE
- 15- D gear indicator
- 16- 001234 km
- 17- 18°C

Multi-information display

- 9- Cruise control display screen*
→ p. 6-69
- 10- Adaptive Cruise Control System (ACC) display screen* → p. 6-78
- 11- Speed limiter display screen*
→ p. 6-73
- 12- ECO indicator* → p. 5-12
- 13- “” mark indicator → p. 5-06
- 14- Information screen → p. 5-05
- 15- Fuel remaining display screen
→ p. 5-07
- 16- Outside temperature display screen
→ p. 5-08
- 17- Auto Stop & Go (AS&G) display screen* → p. 6-30
Auto Stop & Go (AS&G) OFF display screen* → p. 6-35

5

NOTE

- The fuel units, outside temperature units, display language, and other settings can be changed.
Refer to “Changing the function settings” on page 5-13.



Multi-information display switches

Each time the multi-information display switches are operated, the buzzer sounds and the multi-information display changes between information such as warnings, tripmeter, average and instant fuel consumption, distance range.

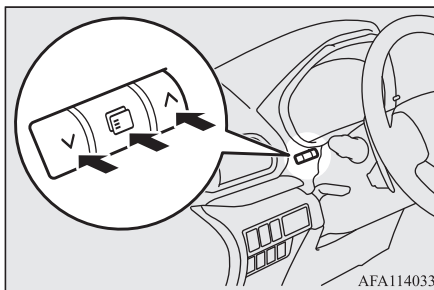
It is also possible to change elements such as the language and units used on the multi-information display by operating the multi-information display switches.



Information screen (when the ignition switch or the operation mode is OFF)

Press the  switch to display the information screen. Then, press the  switch or  switch to switch the display screen in the following order.

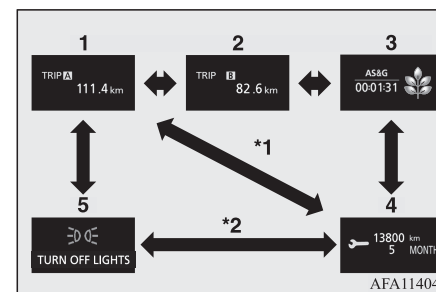

*1: When there is no warning display

*2: When there is a warning display

- 1- Tripmeter **A** → p. 5-08
- 2- Tripmeter **B** → p. 5-08
- 3- Auto Stop & Go (AS&G) monitor*
→ p. 5-12
ECO score display* → p. 5-12
- 4- Service reminder → p. 5-09
- 5- Redisplay of a warning display screen
→ p. 5-06

Information screen (when the ignition switch is turned from the “LOCK” position to the “ON” position or the operation mode is changed from OFF to ON)

When the ignition switch is turned to the “ON” position or the operation mode is put in ON, the display screen switches in the following order.

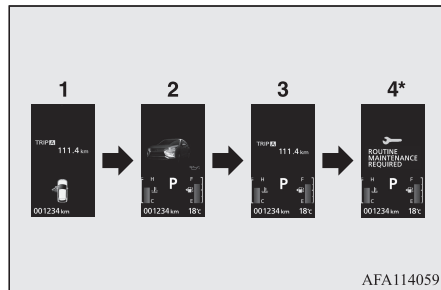

- *: When the inspection time has arrived
1. Screen when the ignition switch or the operation mode is OFF
 2. System check screen → p. 5-10
 3. Screen when the ignition switch or the operation mode is ON
 4. Service reminder → p. 5-09

Information screen (when the ignition switch or the operation mode is ON)

Press the ∇ switch or \blacktriangle switch to switch the display screen in the following order.

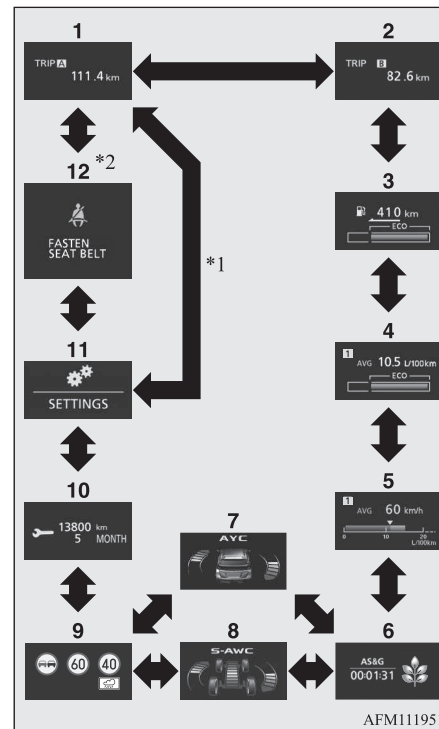

- *1: When there is no warning display
 *2: When there is a warning display
- 1- Tripmeter **A** → p. 5-08
 - 2- Tripmeter **B** → p. 5-08
 - 3- Driving range display → p. 5-10
ECO drive assist display* → p. 5-12
 - 4- Average fuel consumption display → p. 5-11
ECO drive assist display* → p. 5-12
 - 5- Average speed display → p. 5-11
Instant fuel consumption display → p. 5-11
 - 6- Auto Stop & Go (AS&G) monitor* → p. 5-12
ECO score display* → p. 5-12
 - 7- AYC (Active Yaw Control) operation display → p. 6-62
 - 8- S-AWC (Super-All Wheel Control) operation display* → p. 6-52
 - 9- “Traffic Sign Recognition (TSR)*” on page 6-117
 - 10- Service reminder → p. 5-09
 - 11- Function setting screen → p. 5-13
 - 12- Redisplay of a warning display screen → p. 5-06

Multi-information display

NOTE

- While driving, the service reminder are not displayed even if you operate the multi-information display switches. Always stop the vehicle in a safe place before operating.
- While driving, the function setting screen is not displayed even if you operate the multi-information display switches.
Always stop the vehicle in a safe place before operating and firmly apply the parking brake and put the gearshift lever into the “N” (Neutral) position (M/T) or the selector lever into the “P” (Park) position (A/T or CVT). Refer to “Changing the function settings” on page 5-13.
- When there is information to be announced, such as a system fault, the buzzer sounds and the screen display is switched.
Refer to “Interrupt display screen” on page 5-06.

Interrupt display screen

Warning display

When there is information to be announced, such as a system fault, the buzzer sounds and the information screen is switched to the warning display screen.



Refer to the warning list and take the necessary measures.

Refer to “Warning display list” on page 5-23.

When the cause of the warning display is eliminated, the warning display goes out automatically.



To return to the screen displayed before the warning display

Even if the cause of the warning display is not eliminated, you can return to the screen that was displayed before the warning display.

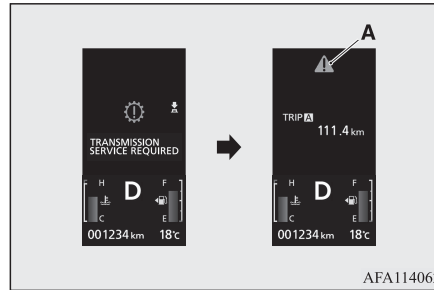

If you press the  switch, the display screen switches to the screen that was displayed before the warning display. The  mark (A) is also displayed.



If you want to switch the display

Warning display screens with the  mark displayed in the upper right of the screen can be switched. If you want to switch the display, press the  switch for approximately 2 seconds or more.

Redisplay of a warning display screen

When the  mark is displayed, if you press the  switch or  switch a few times, the warning display screen you switched from is redisplayed.

Other interrupt displays

The operation status of each system is displayed on the information screen.

Refer to the appropriate page in the warning display list for further details.

Refer to “Other interrupt displays” on page 5-43.

mark display screen

This is displayed when you press the  switch and return from the warning display screen to the previous screen.

This mark is also displayed if there is another warning other than the one displayed.

When the cause of the warning display is eliminated, the  mark goes out automatically.

NOTE

- When the  mark is displayed, the warning display screen can be redisplayed on the information screen. Refer to “Information screen (when the ignition switch or the operation mode is OFF)” on page 5-04. Refer to “Information screen (when the ignition switch or the operation mode is ON)” on page 5-05.

Door ajar warning display screen



If any of the doors or the tailgate is not completely closed, this displays the open door or tailgate.

When the ignition switch or the operation mode is ON, if the vehicle speed exceeds approximately 8 km/h while a door is ajar, a buzzer sounds four times. This notifies the driver that a door is ajar.

CAUTION

- Before moving your vehicle, check that the warning display is OFF.

Engine coolant temperature display



This indicates the engine coolant temperature. If the coolant becomes hot,  will blink. Pay careful attention to the engine coolant temperature display while you are driving.

CAUTION

- If the engine is overheating,  will blink. In this case, the bar graph is in the red zone. Immediately park the vehicle in a safe place and take the required measures. Refer to “Engine overheating” on page 8-10.

Fuel remaining display screen

This displays the amount of fuel remaining.

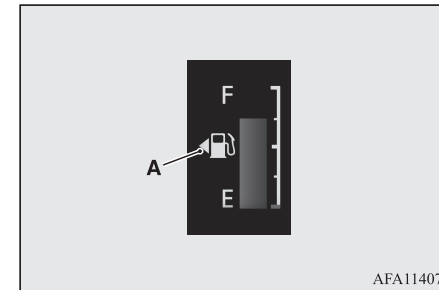

5

F- Full
E- Empty

NOTE

- It may take several seconds to stabilise the display after refilling the tank.
- If fuel is added with the ignition switch or the operation mode is in ON, the fuel gauge may incorrectly indicate the fuel level.
- The arrow (A) indicates that the fuel tank filler is located on the left side of the body.

Multi-information display

Fuel remaining warning display

When the fuel is reduced to approximately 8 litres, the information screen switches to the interrupt display of the fuel remaining warning display, and the “” mark (B) on the fuel remaining display flashes slowly (approximately once per second). After a few seconds, the information screen returns from the fuel remaining warning display to the previous screen.

If the remaining fuel level is reduced further, the information screen switches to the fuel remaining warning display and the “” mark (B) on the fuel remaining display flashes quickly (approximately twice per second).

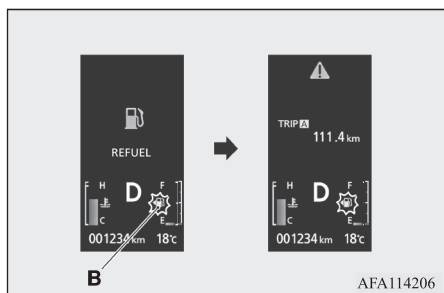

5

CAUTION

- Do not run out of fuel, or the catalytic converter may be adversely affected. If the warning display appears, refuel as soon as possible.

NOTE

- On inclines or curves, the display may be incorrect due to the movement of fuel in the tank.

Outside temperature display screen

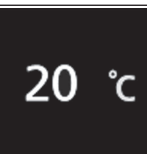

This shows the temperature outside the vehicle.

NOTE

- The display setting can be changed to the preferred units (°C or °F). Refer to “Changing the function settings” on page 5-13.
- Depending on factors such as the driving conditions, the displayed temperature may vary from the actual outside temperature.

Odometer

The odometer indicates the distance travelled.

Tripmeter

The tripmeter indicates the distance travelled between two points.

Example usage of tripmeter **A** and tripmeter **B**

It is possible to measure two currently travelled distances, from home using tripmeter **A** and from a particular point on the way using tripmeter **B**.

To reset the tripmeter

To return the display to “0”, hold down the switch for approximately 2 seconds or more. Only the currently displayed value will be reset.

Example

If tripmeter **A** is displayed, only tripmeter **A** will be reset.

NOTE

- When disconnecting the battery terminal, the memory of tripmeter **A** and **B** are cleared, and the display returns to “0”.

Multi-information display

Service reminder

Displays the approximate time until the next periodic inspection recommended by MITSUBISHI MOTORS. “---” is displayed when the inspection time has arrived.

NOTE

- Depending on the vehicle specifications, the displayed time may differ from the next periodic inspection time recommended by MITSUBISHI MOTORS. In addition, the display settings for the next periodic inspection time can be modified. To modify the display settings, have it adjusted at a MITSUBISHI MOTORS Authorized Service Point. For more details, consult a MITSUBISHI MOTORS Authorized Service Point.

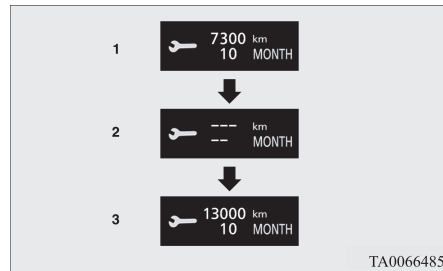

1. Displays the time until the next periodic inspection.

NOTE

- The distance is shown in units of 100 km (100 miles). The time is shown in units of months.

2. This informs you that a periodic inspection is due. We recommend you to consult a MITSUBISHI MOTORS Authorized Service Point.

At that time, when the ignition switch is turned from the “LOCK” position to the “ON” position or the operation mode is changed from OFF to ON, the warning display is displayed for a few seconds on the information screen.





3. After your vehicle is inspected at a MITSUBISHI MOTORS Authorized Service Point, it displays the time until the next periodic inspection.

To reset



The “---” display can be reset while the ignition switch or the operation mode is in OFF.

When the display is reset, the time until the next periodic inspection is displayed and the warning display is no longer displayed when the ignition switch is turned from the “LOCK” position to the “ON” position or the operation mode is changed from OFF to ON.

1. When you press the  switch or  switch a few times, the information screen switches to the service reminder display screen.

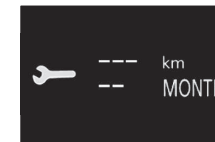
5



2. Press and hold the  switch for about 2 seconds or more to display “” and make it flash. (If there is no operation for about 10 seconds with flashing, the display returns to the previous screen.)

Multi-information display

- Press the  switch while the icon is flashing to change the display from “---” to “CLEAR”. After this, the time until the next periodic inspection will be displayed.

5

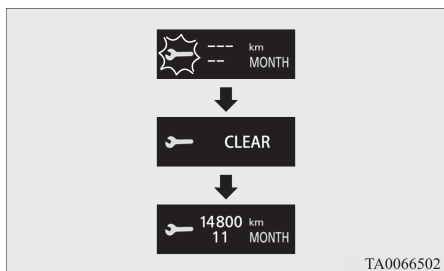

CAUTION

- The customer is responsible for making sure that periodic inspection and maintenance are performed. Inspections and maintenance must be performed to prevent accidents and malfunctions.

NOTE

- “---” display cannot be reset when the ignition switch or the operation mode is in ON.

NOTE

- When “---” is displayed, after a certain distance and a certain period of time, the display is reset and the time until the next periodic inspection is displayed.
- If you accidentally reset the display, we recommend you to consult a MITSUBISHI MOTORS Authorized Service Point.

System check screen

When the ignition switch is turned to the “ON” position or the operation mode is put in ON, the system check screen is displayed for approximately 4 seconds. If there is no fault, information screen (when the ignition switch or the operation mode is ON) is displayed.

If there is a fault, the screen changes to warning display.

Refer to “Warning display list” on page 5-23.

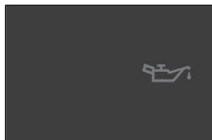

Driving range display

This displays the approximate driving range (how many more kilometres or miles you can drive). When the driving range falls below approximately 50 km (30 miles), “---” is displayed.

Refuel as soon as possible.

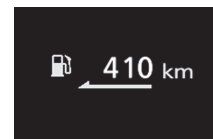

NOTE

- The driving range is determined based on the fuel consumption data. This may vary depending on the driving conditions and habits. Treat the distance displayed as just a rough guideline.
- When you refuel, the driving range display is updated. However, if you only add a small amount of fuel, the correct value will not be displayed. Fill with a full tank whenever possible.
- On rare occasions, the value displayed for the driving range may change if you are parked on an extremely steep incline. This is due to the movement of fuel in the tank and does not indicate a malfunction.

NOTE

- The display setting can be changed to the preferred units (km or miles). Refer to “Changing the function settings” on page 5-13.

Average fuel consumption display

This displays the average fuel consumption from the last reset to the present time. There are 2 types of mode settings of automatic reset [1] and manual reset [2]. Refer to “Changing the reset mode for average fuel consumption and average speed” on page 5-15. For information on how to change the average fuel consumption display setting, refer to “Changing the function settings” on page 5-13.

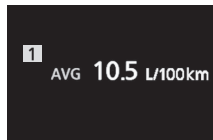
**NOTE**

- The average fuel consumption display can be reset separately for the auto reset mode and for the manual reset mode.

NOTE

- “---” is displayed when the average fuel consumption cannot be measured.
- The initial (default) setting is “Auto reset mode”.
- The average fuel consumption depends on the driving condition (road condition, driving behavior, etc.). The displayed fuel consumption may vary from the actual fuel consumption. Treat the fuel consumption displayed as just a rough guideline.
- The memory of the auto reset mode or manual reset mode for the average fuel consumption display is erased if the battery is disconnected.
- The display setting can be changed to the preferred units {km/L, mpg (US), mpg (UK) or L/100 km}. Refer to “Changing the function settings” on page 5-13.

Average speed display

This displays the average speed from the last reset to the present time.

There are 2 types of mode settings of automatic reset [1] and manual reset [2]. Refer to “Changing the reset mode for average fuel consumption and average speed” on page 5-15.

For the method for changing the average speed display setting, refer to “Changing the function settings” on page 5-13.

**NOTE**

- The average speed display can be reset separately for the auto reset mode and for the manual reset mode.
- “---” is displayed when the average speed cannot be measured.
- The initial (default) setting is “Auto reset mode”.
- The display setting can be changed to the preferred units (km/h or mph). Refer to “Changing the function settings” on page 5-13.
- The memory of the auto reset mode or manual reset mode for the average speed display is erased if the battery is disconnected.

Instant fuel consumption display

While driving, this displays the instant fuel consumption, using a bar graph.

Multi-information display

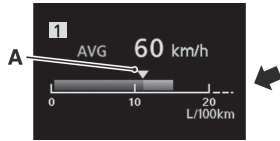

5

The “▼” mark (A) in the instant fuel gauge shows the average fuel consumption. When the value of instant fuel consumption surpasses the value of average fuel consumption, the instant fuel consumption is displayed with a green bar graph.

Be conscious of maintaining the value of instant fuel consumption below the value of average fuel consumption, it can help you to drive with the best fuel consumption.

NOTE

- When the instant fuel consumption cannot be measured, the bar graph is not displayed.
- The display setting can be changed to the preferred units {km/L, mpg (US), mpg (UK) or L/100 km}. Refer to “Changing the function settings” on page 5-13.
- It is possible to cancel the green bar graph. Refer to “Changing the function settings” on page 5-13.

Auto Stop & Go (AS&G) monitor*

The accumulated time the engine has been stopped by Auto Stop & Go (AS&G) system is displayed.

Refer to “Auto Stop & Go (AS&G) system” on page 6-30.

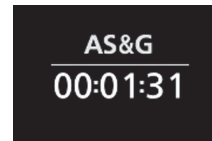

NOTE

- When the ignition switch or the operation mode is ON again, the accumulated time will be reset.

ECO mode indicator*



This indicator will be displayed when fuel-efficient driving is achieved.

ECO Drive Assist*

This function displays how fuel-efficiently you are driving under different driving conditions.

The ECO drive assist display will change as follows if you do fuel-efficient driving using the accelerator in a way well matched with the vehicle speed.

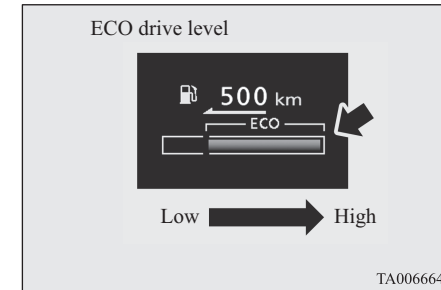

NOTE

- On vehicles with A/T or CVT, the ECO drive assist is displayed only when the vehicle is driven with the selector lever in the “D” (DRIVE) position or when the vehicle is driven in the sports mode (for vehicles equipped with shift paddles).

ECO Score*

ECO score indicates the points you have scored on fuel-efficient driving by the number of leaves as follows:

[When the ignition switch or the operation mode is ON]

Multi-information display

The display shows the score you achieved in the last several minutes.

[When the ignition switch is turned off or the operation mode is put in OFF]

The display shows the overall ECO score the function has counted from the time when the ignition switch is turned to “ON” to the time when it is turned to “LOCK” or “ACC”, or from the time when the operation mode is set to ON to the time when it is set to OFF.

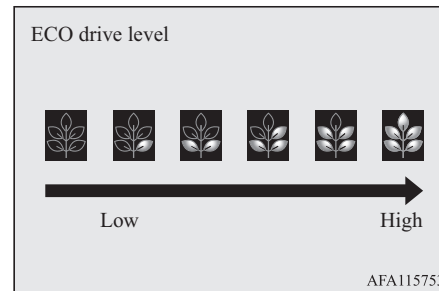

Changing the function settings

The “Display language”, “Temperature unit”, “Fuel consumption unit”, and “Average fuel consumption and speed reset method” etc. setting can be modified as desired.

1. Stop the vehicle in a safe place.

Firmly apply the parking brake and put the gearshift lever into the “N” (Neutral) position (M/T) or the selector lever into the “P” (Park) position (A/T or CVT).

2. Press the \blacktriangledown switch or \blacktriangle switch a few times to switch the information screen to the function setting screen.

Refer to “Information screen (when the ignition switch or the operation mode is ON)” on page 5-05.

5

Multi-information display



CAUTION

- For safety, stop the vehicle before operating. While driving, even if you operate the multi-information display switches (ENTER, DOWN, UP), the function setting screen is not displayed.

- Press the ENTER switch to switch to the top screen (A) for the menu screens. Then, press the DOWN switch or UP switch to switch to the menu screens (B).

5

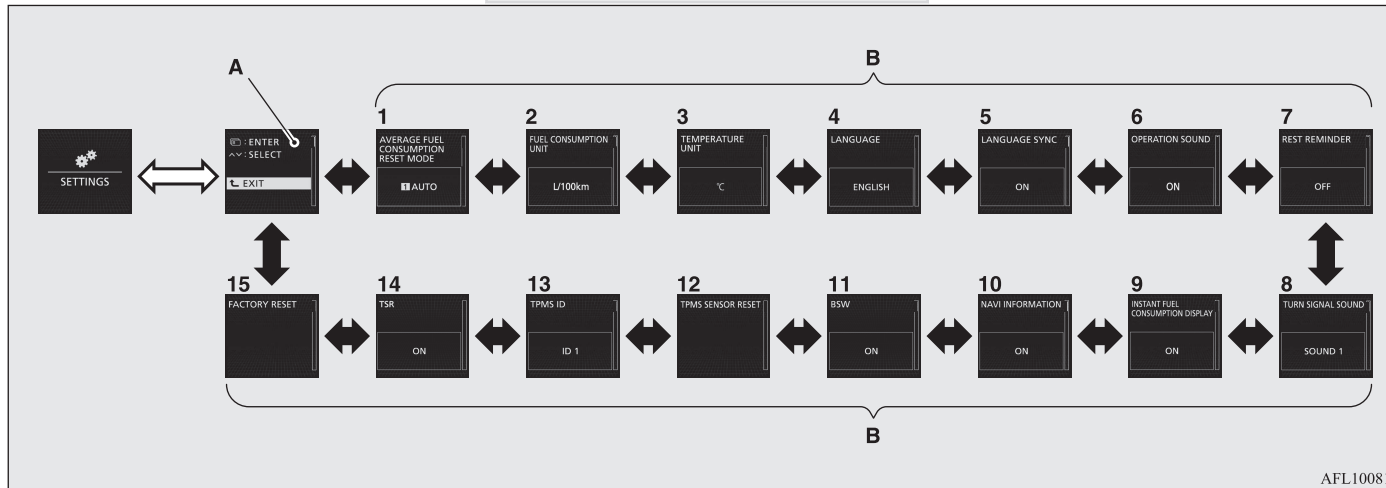

AFL100811

⇌: ENTER switch

→: DOWN switch or UP switch

- Changing the reset mode for average fuel consumption and average speed → p. 5-15
- Changing the fuel consumption display unit → p. 5-16

- Changing the temperature unit → p. 5-16

- Changing the display language → p. 5-17

- Changing the language cooperative control* → p. 5-17

- Operation sound setting → p. 5-18

- Changing the time until “REST REMINDER” is displayed → p. 5-19

- Changing the turn-signal sound → p. 5-19

- Changing the instant fuel consumption display → p. 5-19

- Changing the navigation information display* → p. 5-20

- Blind Spot Warning (BSW)*: To operate → p. 6-109

- Reset of low tyre pressure warning threshold* → p. 6-123

13. Tyre ID set change* → p. 6-123
14. “To turn on/off the TSR system” on page 6-117
15. Returning to the factory settings → p. 5-20

NOTE

- If no operations are made within approximately 30 seconds of the menu screen being displayed, the display returns to the function setting screen.



4. After switching to the menu screen (B) for the setting you want to change, press the  switch to switch to the setting selection screen. Refer to each item for further details on the operation methods.

NOTE



- If the battery is disconnected, these function settings are reset from memory to the factory settings automatically (except “Blind Spot Warning (BSW): To operate”, “Reset of low tyre pressure warning threshold” and “Tyre ID set change”).

Changing the reset mode for average fuel consumption and average speed

The mode conditions for the average fuel consumption and average speed display can be switched between “Auto reset” and “Manual reset”.

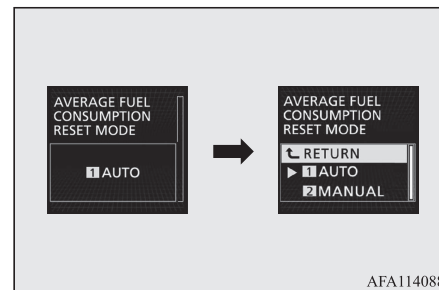
1. Switch to the function setting screen.
Refer to “Changing the function settings” on page 5-13
2. Press the  switch or  switch several times to switch to the “AVERAGE FUEL CONSUMPTION RESET MODE” screen.
Then, press the  switch to switch to the setting selection screen.



3. Press the  switch or  switch to select the reset mode, and then press the  switch to confirm the setting.
The setting is changed to the selected mode condition.

Manual reset mode

- When the average fuel consumption and average speed are being displayed, if you press and hold the  switch, the average fuel consumption and average speed displayed at that time are reset.
- When the following operation is performed, the mode setting is automatically switched from manual to auto.
[Except for vehicles equipped with keyless operation system]
Turn the ignition switch from the “ACC” or “LOCK” position to the “ON” position.
[For vehicles equipped with keyless operation system]
Change the operation mode from ACC or OFF to ON.
Switching to auto occurs automatically. If switching to manual mode is done, however, the data from the last reset is displayed.

5

Multi-information display

Auto reset mode

5

- When the average fuel consumption and average speed are being displayed, if you press and hold the  switch, the average fuel consumption and average speed displayed at that time are reset.
- When the engine switch or the operation mode is in the following conditions, the average fuel consumption display and average speed display are automatically reset.

[Except for vehicles equipped with keyless operation system]

The ignition switch is in the “ACC” or “LOCK” position for approximately 4 hours or longer.

[For vehicles equipped with keyless operation system]



The operation mode is in ACC or OFF for approximately 4 hours or longer.

NOTE



- The average fuel consumption display and average speed display can be reset separately for the auto reset mode and for the manual reset mode.
- The memory of the auto reset mode or manual reset mode for the average fuel consumption display and average speed display is erased if the battery is disconnected.

Changing the fuel consumption display unit

The display unit for fuel consumption can be switched. The distance, speed, and amount units are also switched to match the selected fuel consumption unit.

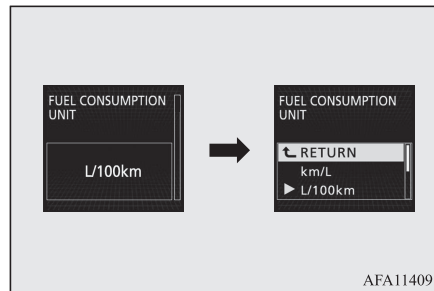
1. Switch to the function setting screen.
Refer to “Changing the function settings” on page 5-13.
2. Press the  switch or  switch several times to switch to the “FUEL CONSUMPTION UNIT” screen. Then, press the  switch to switch to the setting selection screen.



3. Press the  switch or  switch to select the units, and then press the  switch to confirm the setting.
The setting is changed to the selected unit.

NOTE



- The display units for the driving range, the average fuel consumption, the average speed and the instant fuel consumption are switched, but the units for the indicating needle (speedometer), the odometer and the tripmeter will remain unchanged.

The distance and speed units are also switched in the following combinations to match the selected fuel consumption unit.

Fuel consumption	Distance (driving range)	Speed (average speed)
km/L	km	km/h
L/100 km	km	km/h
mpg (US)	mile(s)	mph
mpg (UK)	mile(s)	mph



Changing the temperature unit

The display unit for temperature can be switched.

1. Switch to the function setting screen.
Refer to “Changing the function settings” on page 5-13.
2. Press the  switch or  switch several times to switch to the “TEMPERATURE UNIT” screen.

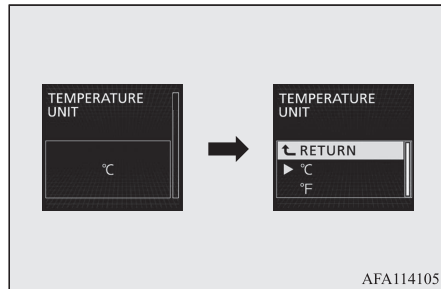
Then, press the  switch to switch to the setting selection screen.



3. Press the  switch or  switch to select the units, and then press the  switch to confirm the setting.
The setting is changed to the selected temperature unit.

NOTE



- The temperature value on the air conditioning panel is switched in conjunction with the outside temperature display unit of the multi-information display.
However, “°C” or “°F” are not shown on the temperature display of the air conditioner.

NOTE

- On vehicles equipped with the MITSUBISHI Multi-Communication System (MMCS), the temperature value of the air conditioning screen is switched in conjunction with the outside temperature display unit of the multi-information display.
However, “°C” or “°F” are not shown to the air conditioning screen.



Changing the display language

The language of the multi-information display can be switched.

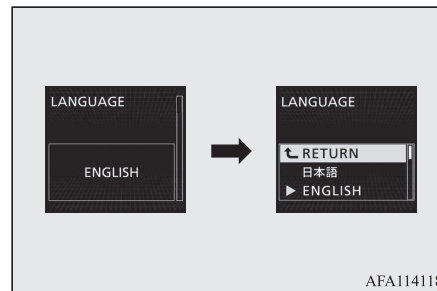
1. Switch to the function setting screen.
Refer to “Changing the function settings” on page 5-13.
2. Press the  switch or  switch several times to switch to the “LANGUAGE” screen.
Then, press the  switch to switch to the setting selection screen.



OGKE20E1

3. Press the  switch or  switch to select the desired language, and then press the  switch to confirm the setting.
The setting is changed to the selected language.

NOTE



- If “---” is selected in the language setting, a warning message is not displayed when there is a warning display or interrupt display.

5

Changing the language cooperative control

The language used in MITSUBISHI Multi-Communication System (MMCS) (if so equipped), the Bluetooth® 2.0 interface (if so equipped), Multi Around Monitor (if so equipped) or Head Up Display (HUD) (if so equipped) can be changed automatically to the same language as that shown in the multi-information display.

Bluetooth® is a registered trademark of BLUETOOTH SIG, INC.



1. Switch to the function setting screen.
Refer to “Changing the function settings” on page 5-13.
2. Press the  switch or  switch several times to switch to the “LANGUAGE

Multi-information display

SYNC” screen. Then, press the  switch to switch to the setting selection screen.

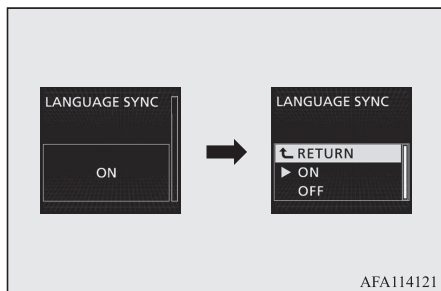
5



3. Press the  switch or  switch to select the setting, and then press the  switch to confirm the setting. The setting is changed to the selected condition.

NOTE



- The language display modified with the language setting can be switched in the following manner.

NOTE



- When “ON” (language cooperation enabled) has been selected with the language cooperative control, the language for MITSUBISHI Multi-Communication System (MMCS) (if so equipped), the Bluetooth® 2.0 interface (if so equipped), Multi Around Monitor (if so equipped) or Head Up Display (HUD) (if so equipped) is automatically changed to the language selected for the multi-information display. However, this changing function may not work depending on the language selected for the multi-information display.
- When “OFF” (language cooperation disabled) has been selected with the language cooperative control, the language for MITSUBISHI Multi-Communication System (MMCS) (if so equipped), the Bluetooth® 2.0 interface (if so equipped), Multi Around Monitor (if so equipped) or Head Up Display (HUD) (if so equipped) is not automatically changed to the language selected for the multi-information display.
- The language on the display of the audio system (if so equipped) is not automatically changed even if you select “ON” (language cooperation enabled) of the language cooperation control.

Operation sound setting

You can change the operation sounds of the multi-information display switches and rheostat illumination button.

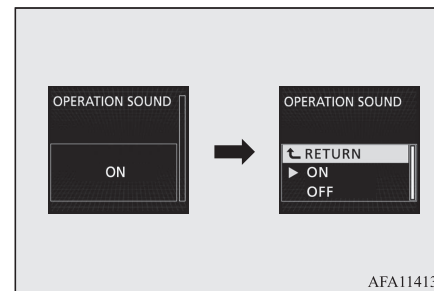
1. Switch to the function setting screen. Refer to “Changing the function settings” on page 5-13.
2. Press the  switch or  switch several times to switch to the “OPERATION SOUND” screen. Then, press the  switch to switch to the setting selection screen.



3. Press the  switch or  switch to select the sound, and then press the  switch to confirm the setting. The setting is changed to the selected condition.

NOTE

- The operation sound setting only deactivates the operation sound of the multi-information display switches and rheostat illumination button. The warning display and other sounds cannot be deactivated.

Changing the time until “REST REMINDER” is displayed

The time until the display appears can be changed.

- Switch to the function setting screen. Refer to “Changing the function settings” on page 5-13.
- Press the ∇ switch or \blacktriangle switch several times to switch to the “REST REMINDER” screen. Then, press the \square switch to switch to the setting selection screen.

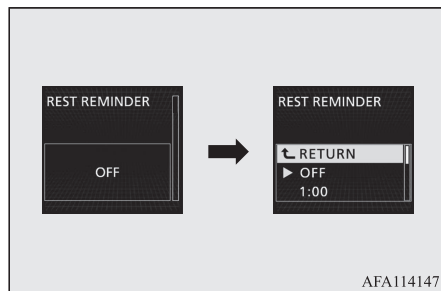

- Press the ∇ switch or \blacktriangle switch to select the time, and then press the \square switch to confirm the setting. The setting is changed to the selected time.

NOTE

- The drive time is reset when the ignition switch is turned off or the operation mode is put in OFF.

Changing the turn-signal sound

It is possible to change the turn-signal sound.

- Switch to the function setting screen. Refer to “Changing the function settings” on page 5-13.
- Press the ∇ switch or \blacktriangle switch several times to switch to the “TURN SIGNAL SOUND” screen. Then, press the \square switch to switch to the setting selection screen.

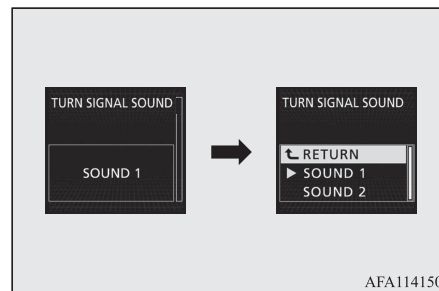

- Press the ∇ switch or \blacktriangle switch to select the sound, and then press the \square switch to confirm the setting. The setting changes to the selected turn-signal sound.

Changing the instant fuel consumption display

It is possible to change the bar graph setting of the instant fuel consumption display.

- Switch to the function setting screen. Refer to “Changing the function settings” on page 5-13.
- Press the ∇ switch or \blacktriangle switch several times to switch to the “INSTANT FUEL CONSUMPTION DISPLAY” screen. Then, press the \square switch to switch to the setting selection screen.

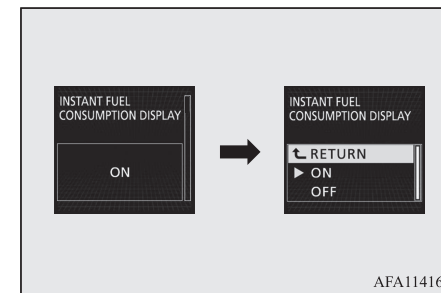

Multi-information display

3. Press the ∇ switch or \blacktriangle switch to select the setting, and then press the \square switch to confirm the setting.
The setting changes to the selected bar graph setting.

5

Changing the navigation information display*

On vehicles equipped with MITSUBISHI Multi-Communication System (MMCS), you can select whether to display the navigation information on the information screen.

1. Switch to the function setting screen.
See “Changing the function settings” on page 5-13.
2. Press the ∇ switch or \blacktriangle switch several times to switch to the “NAVI INFORMATION” screen. Then, press the \square switch to switch to the setting selection screen.

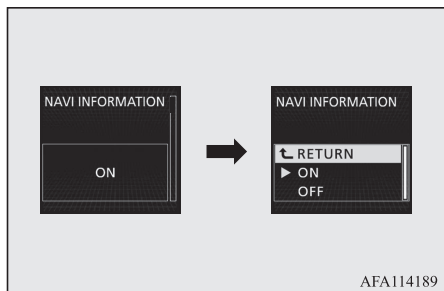

3. Press the ∇ switch or \blacktriangle switch to select the setting, and then press the \square switch to confirm the setting.
The setting is changed to the selected navigation information display setting.

Returning to the factory settings

Many of the function settings can be returned to their factory settings.

1. Switch to the function setting screen.
Refer to “Changing the function settings” on page 5-13.
2. Press the ∇ switch or \blacktriangle switch several times to switch to the “FACTORY RESET” screen. Then, press the \square switch to switch to the setting selection screen.

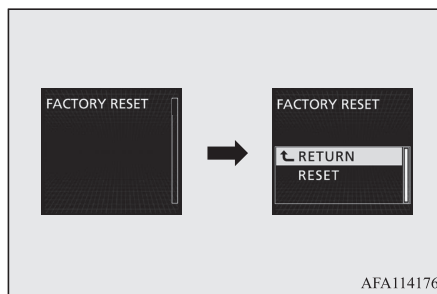

3. Press the ∇ switch or \blacktriangle switch to select “RESET”, and then press and hold the \square switch for approximately 5 seconds or more to confirm the setting.
The buzzer sounds and all of the function settings are returned to the factory settings.

NOTE

- The factory settings are as follows.
 - “AVERAGE FUEL CONSUMPTION RESET MODE”: AUTO
 - “FUEL CONSUMPTION UNIT”: L/100 km
 - “TEMPERATURE UNIT”: °C
 - “LANGUAGE”: ENGLISH or RUSSIAN
 - “LANGUAGE SYNC”: ON
 - “OPERATION SOUND”: ON
 - “REST REMINDER”: OFF
 - “TURN SIGNAL SOUND”: SOUND 1
 - “INSTANT FUEL CONSUMPTION DISPLAY”: ON
 - “NAVI INFORMATION”: ON
- “BSW”, “TPMS SENSOR RESET”, “TPMS ID” and “TSR” cannot be returned to their factory settings.

Indication lamp, warning lamp, and information screen display list

Indication and warning lamp list

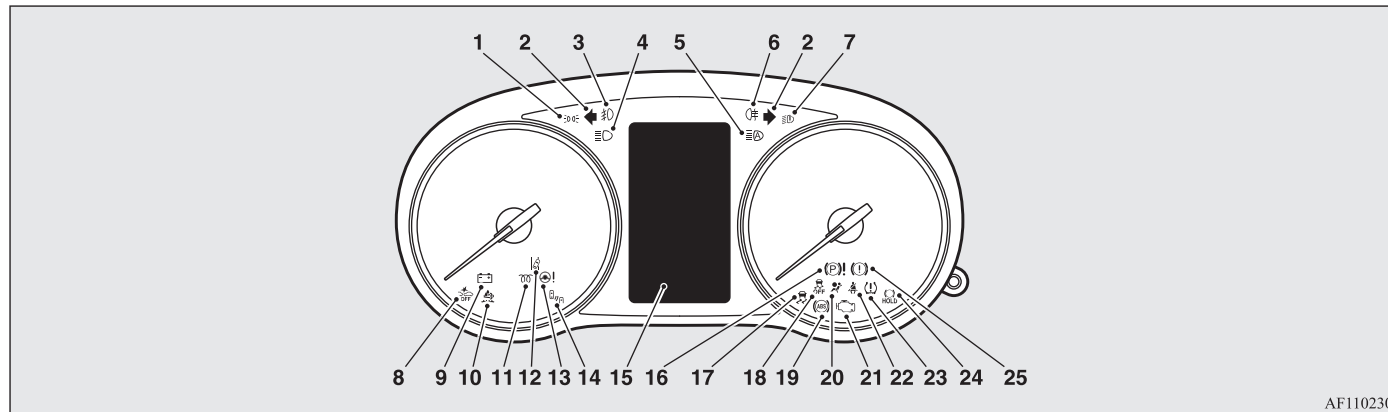

5

AF1102308

- | | | |
|---|---|---|
| <p>1- Position lamp indication lamp
→ p. 5-47</p> <p>2- Turn-signal indication lamps/Hazard warning indication lamps → p. 5-47</p> <p>3- Front fog lamp indication lamp*
→ p. 5-47</p> <p>4- High-beam indication lamp → p. 5-47</p> <p>5- Automatic High-Beam (AHB) indication lamp* → p. 5-59</p> <p>6- Rear fog lamp indication lamp
→ p. 5-47</p> | <p>7- LED headlamp warning lamp*
→ p. 5-58</p> <p>8- Forward Collision Mitigation system (FCM) OFF indicator* → p. 6-91</p> <p>9- Ultrasonic misacceleration Mitigation System (UMS) OFF indicator*
→ p. 6-102</p> <p>10- Charge warning lamp → p. 5-49</p> <p>11- Urea SCR system warning lamp (diesel-powered vehicles) → p. 6-28</p> | <p>12- Diesel preheat indication lamp (diesel-powered vehicles) → p. 5-47</p> <p>13- “Lane Departure Warning (LDW)”* on page 6-113</p> <p>14- Electric power steering system (EPS) warning lamp → p. 6-65</p> <p>15- Blind Spot Warning (BSW) indication lamp* → p. 6-107</p> <p>16- Information screen display → p. 5-22</p> <p>17- Electric parking brake warning lamp*
→ p. 5-48</p> |
|---|---|---|

Indication lamp, warning lamp, and information screen display list

17- Active Stability Control (ASC) indicator → p. 6-68	20- Supplement Restraint System (SRS) warning lamp → p. 4-37	23- Tyre pressure monitoring system warn- ing lamp* → p. 6-119
18- Active Stability Control (ASC) OFF in- dication lamp → p. 6-68	21- Check engine warning lamp → p. 5-48	24- Brake auto hold indication lamp* → p. 6-57
19- Anti-lock brake system (ABS) warning lamp → p. 6-64	22- Seat belt warning lamp → p. 4-10	25- Brake warning lamp → p. 5-47

5

Information screen display

When there is information to be announced, such as lamp reminder, the buzzer sounds and the screen switches to the displays shown below. Refer to the appropriate page and take the necessary measures.

When the cause of the warning display is eliminated, the warning display goes out automatically.

Refer to “Warning display list” on page 5-23.







Refer to “Navigation information display” on page 5-42.

Refer to “Other interrupt displays” on page 5-43.

NOTE



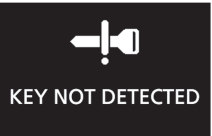

- A warning may be displayed on the information screen and the buzzer may sound in the following rare cases.
This is caused by the system picking up interference such as noise or strong electromagnetic waves, and is not a functional problem.
 - An extremely strong electromagnetic wave is received from a source such as an illegal radio set, a spark from a wire, or a radar station.
 - Abnormal voltage or a static electricity discharge is generated by the operation of installed electrical equipment (including after-market parts).
- If the warning display appears many times, we recommend you to consult a MITSUBISHI MOTORS Authorized Service Point.

Warning display list





Screen	Cause	Solution (Reference)
 <p>TURN OFF LIGHTS</p>	<ul style="list-style-type: none"> You have forgotten to turn off the lamps. 	<ul style="list-style-type: none"> Refer to “Lamps (headlamps, fog lamps, etc.) auto-cutout function” on page 5-57.
 <p>LOW WASHER FLUID</p>	<ul style="list-style-type: none"> The washer fluid is running low. 	<ul style="list-style-type: none"> Replenish the container with washer fluid. Refer to “Washer fluid” on page 10-08. Refer to “Capacity” on page 11-13.
 <p>LED HEADLIGHT SERVICE REQUIRED</p>	<ul style="list-style-type: none"> There is a fault in the LED headlamps. 	<ul style="list-style-type: none"> We recommend you to consult a MITSUBISHI MOTORS Authorized Service Point. Refer to “LED headlamp warning lamp” on page 5-58.
 <p>KEY BATTERY LOW</p>  <p>KEY NOT DETECTED</p>	<ul style="list-style-type: none"> There is a fault in the keyless operation system. 	<ul style="list-style-type: none"> Refer to “Keyless operation system” on page 3-08.
 <p>KEY STILL IN VEHICLE</p>  <p>CHECK DOORS</p>		

5

Indication lamp, warning lamp, and information screen display list

Screen	Cause	Solution (Reference)
 <p>KEYLESS OPERATION SYSTEM SERVICE REQUIRED</p>		
<p>5 Engine switch is pressed one time</p>  <p>KEY NOT DETECTED</p> <p>Engine switch is pressed two times or more</p>  <p>KEY NOT DETECTED TOUCH SWITCH WITH KEY</p>	<ul style="list-style-type: none"> ● Although the engine switch was pressed, the keyless operation key could not be detected. 	<ul style="list-style-type: none"> ● Touch the keyless operation key to the engine switch. Refer to “If the keyless operation key is not operating properly” on page 6-25.
 <p>PUSH ENGINE SWITCH WHILE TURNING STEERING WHEEL</p>	<ul style="list-style-type: none"> ● The steering wheel is locked. 	<ul style="list-style-type: none"> ● Press the engine switch while turning steering wheel. Refer to “Steering wheel lock” on page 6-18.
 <p>SHIFT TO P POSITION</p>	<ul style="list-style-type: none"> ● The engine is stopped while the selector lever is in a position other than the “P” (PARK) position. 	<ul style="list-style-type: none"> ● Place the selector lever in the “P” (Park) position to put the operation mode in OFF.





Indication lamp, warning lamp, and information screen display list

Screen	Cause	Solution (Reference)
 <p>STEERING WHEEL UNLOCKED</p>	<ul style="list-style-type: none"> The driver's door is opened with the steering wheel unlocked. 	<ul style="list-style-type: none"> Refer to "Steering wheel lock" on page 6-18.
 <p>POWER STEERING SERVICE REQUIRED</p>	<ul style="list-style-type: none"> There is a fault in the EPS. 	<ul style="list-style-type: none"> Have the vehicle inspected by a MITSUBISHI MOTORS Authorized Service Point as soon as possible. Refer to "Electric power steering system (EPS)" on page 6-65.
 <p>ABS SERVICE REQUIRED</p>	<ul style="list-style-type: none"> There is a fault in the ABS. 	<ul style="list-style-type: none"> Avoid sudden braking and high-speed driving, stop the vehicle in a safe place, and take corrective measures. Refer to "ABS warning lamp/display" on page 6-64.
 <p>LOW TIRE PRESSURE</p>	<ul style="list-style-type: none"> The tyre pressure in one of the tyres is low. 	<ul style="list-style-type: none"> Refer to "TPMS warning lamp/display" on page 6-120.
 <p>TIRE PRESSURE MONITOR SERVICE REQUIRED</p>	<ul style="list-style-type: none"> There is a fault in the tyre pressure monitoring system. 	<ul style="list-style-type: none"> Refer to "TPMS warning lamp/display" on page 6-120.





5

Indication lamp, warning lamp, and information screen display list

5

Screen	Cause	Solution (Reference)
	<ul style="list-style-type: none"> ● One of the doors or the tailgate is not completely closed. The open door is displayed. 	<ul style="list-style-type: none"> ● Close the door or tailgate. Refer to “Door ajar warning display screen” on page 5-07.
	<ul style="list-style-type: none"> ● The bonnet is open. 	<ul style="list-style-type: none"> ● Close the bonnet. Refer to “Bonnet” on page 10-03.
	<ul style="list-style-type: none"> ● There is a fault in the electronic immobilizer (Anti-theft starting system). 	<ul style="list-style-type: none"> ● Put the operation mode in OFF, and then start the engine again. If the warning is not cancelled, please contact a MITSUBISHI MOTORS Authorized Service Point.
	<ul style="list-style-type: none"> ● The driver’s door is open when the operation mode is in any mode other than OFF. 	<ul style="list-style-type: none"> ● Put the operation mode in OFF. Refer to “Operation mode ON reminder system” on page 6-18.
	<ul style="list-style-type: none"> ● An attempt was made to lock all the doors and the tailgate when the operation mode is in any mode other than OFF. 	<ul style="list-style-type: none"> ● Put the operation mode in OFF. Refer to “Operation mode OFF reminder system” on page 6-17.
	<ul style="list-style-type: none"> ● There is a fault in the steering wheel lock. 	<ul style="list-style-type: none"> ● Immediately stop the vehicle in a safe place. We recommend you to consult a MITSUBISHI MOTORS Authorized Service Point.





Indication lamp, warning lamp, and information screen display list

Screen	Cause	Solution (Reference)
 <p>ELECTRICAL SYSTEM SERVICE REQUIRED</p>	<ul style="list-style-type: none"> ● There is a fault in the electrical system. 	<ul style="list-style-type: none"> ● Immediately stop the vehicle in a safe place. We recommend you to consult a MITSUBISHI MOTORS Authorized Service Point.
 <p>ENGINE OVERHEATING STOP SAFELY</p>	<ul style="list-style-type: none"> ● The engine is overheated. 	<ul style="list-style-type: none"> ● Stop the vehicle in a safe place and take corrective measures. Refer to “Engine overheating” on page 8-10.
 <p>TRANSMISSION OVERHEATING SLOW DOWN</p>	<ul style="list-style-type: none"> ● The automatic transmission (A/T or CVT) fluid temperature is too high. 	<ul style="list-style-type: none"> ● Refer to “8-speed Automatic transmission with Sports Mode*” on page 6-36. Refer to “INVECS-III CVT with 8-step Sports Mode*” on page 6-43.
 <p>FASTEN SEAT BELT</p>	<ul style="list-style-type: none"> ● You turned the ignition switch to the “ON” position or put the operation mode in ON without fastening your seat belt. 	<ul style="list-style-type: none"> ● Fasten your seat belt properly. Refer to “Seat belt reminder” on page 4-10.
 <p>FUEL SYSTEM SERVICE REQUIRED</p>	<ul style="list-style-type: none"> ● There is a fault in the fuel system. 	<ul style="list-style-type: none"> ● We recommend you to consult a MITSUBISHI MOTORS Authorized Service Point.





5

Indication lamp, warning lamp, and information screen display list

5





Screen	Cause	Solution (Reference)
 REFUEL	<ul style="list-style-type: none"> The fuel is running low. 	<ul style="list-style-type: none"> Refuel as soon as possible. Refer to “Fuel remaining warning display” on page 5-07.
 RELEASE PARKING BRAKE	<ul style="list-style-type: none"> You are driving with the parking brake still applied. 	<ul style="list-style-type: none"> Release the parking brake. Refer to “Brake warning display” on page 5-50.
 BRAKE SYSTEM SERVICE REQUIRED	<ul style="list-style-type: none"> The brake fluid level in the reservoir has fallen to a low level. There is a fault in the brake system. 	<ul style="list-style-type: none"> Immediately stop the vehicle in a safe place. We recommend you to consult a MITSUBISHI MOTORS Authorized Service Point. Refer to “Brake warning display” on page 5-50.
 PARKING BRAKE SERVICE REQUIRED	<ul style="list-style-type: none"> There is a fault with the Electric parking brake. 	<ul style="list-style-type: none"> We recommend you to have it checked, immediately. Refer to “Electric parking brake” on page 6-05.
 PARKING BRAKE TEMPORARILY NOT AVAILABLE	<ul style="list-style-type: none"> The parking brake cannot be applied temporarily due to repeated operation of the Electric parking brake switch within a short time. 	<ul style="list-style-type: none"> Refer to “Electric parking brake” on page 6-05.

Indication lamp, warning lamp, and information screen display list





Screen	Cause	Solution (Reference)
	<ul style="list-style-type: none"> You try to release the Electric parking brake switch without depressing the brake pedal. 	<ul style="list-style-type: none"> Refer to “Electric parking brake” on page 6-05.
	<ul style="list-style-type: none"> The Electric parking brake has been automatically applied. 	<ul style="list-style-type: none"> Refer to “Brake auto hold” on page 6-57.
	<ul style="list-style-type: none"> The brake auto hold is automatically cancelled. 	<ul style="list-style-type: none"> Refer to “Brake auto hold” on page 6-57.
	<ul style="list-style-type: none"> The brake auto hold is not available. 	<ul style="list-style-type: none"> Refer to “Brake auto hold” on page 6-57.

5

Indication lamp, warning lamp, and information screen display list



Screen	Cause	Solution (Reference)
<div style="display: flex; align-items: center;"> <div style="background-color: black; color: white; padding: 5px; margin-right: 10px; font-weight: bold;">5</div>  </div>	<ul style="list-style-type: none"> The Electric parking brake is not automatically applied because there is a fault in the Electric parking brake system. 	<ul style="list-style-type: none"> When the ignition switch is turned off or the operation mode is put in OFF, place the selector lever in the “P” (Park) position and depress the brake pedal more firmly than usual with the right foot. Then, operate the ignition switch or the engine switch. We recommend you to have the brake auto hold system inspected by a MITSUBISHI MOTORS Authorized Service Point. Refer to “Brake auto hold” on page 6-57.
	<ul style="list-style-type: none"> The brake auto hold system does not turn on because the driver’s seat belt is not fastened. 	<ul style="list-style-type: none"> Press the brake auto hold switch after fastening the driver’s seat belt. Refer to “Brake auto hold” on page 6-57.
	<ul style="list-style-type: none"> The brake auto hold system does not turn off because the brake pedal is not pressed. 	<ul style="list-style-type: none"> Depress the brake pedal more firmly than usual with the right foot. Then, press the brake auto hold switch. Refer to “Brake auto hold” on page 6-57.
	<ul style="list-style-type: none"> There is a fault in the engine oil circulation system. 	<ul style="list-style-type: none"> Immediately stop the vehicle in a safe place. We recommend you to have it checked. Refer to “Oil pressure warning display” on page 5-51

Indication lamp, warning lamp, and information screen display list

Screen	Cause	Solution (Reference)
 <p>CHARGING SYSTEM SERVICE REQUIRED</p>	<ul style="list-style-type: none"> ● There is a fault in the charging system. 	<ul style="list-style-type: none"> ● Immediately stop the vehicle in a safe place. We recommend you to consult a MITSUBISHI MOTORS Authorized Service Point. Refer to “Charge warning display” on page 5-50.
 <p>PF SYSTEM SERVICE REQUIRED</p>	<ul style="list-style-type: none"> ● More than the specified limit amount of particulate matter (PM) accumulates inside the gasoline particulate filter (GPF). 	<ul style="list-style-type: none"> ● Immediately have your vehicle checked by a MITSUBISHI MOTORS Authorized Service Point.
	<ul style="list-style-type: none"> ● The fuel additives are running low. 	<ul style="list-style-type: none"> ● Refill the fuel additives at a MITSUBISHI MOTORS Authorized Service Point.
 <p>CHECK PF SYSTEM</p>	<ul style="list-style-type: none"> ● For petrol-powered vehicles, an excessive amount of particulate matter (PM) accumulates inside the gasoline particulate filter (GPF). 	<ul style="list-style-type: none"> ● Refer to “Gasoline particulate filter (GPF)*” on page 6-26.
	<ul style="list-style-type: none"> ● For diesel-powered vehicles, an excessive amount of particulate matter (PM) accumulates inside the diesel particulate filter (DPF). 	<ul style="list-style-type: none"> ● Refer to “Diesel particulate filter (DPF)*” on page 6-27.
 <p>CHECK ENGINE OIL LEVEL</p>	<ul style="list-style-type: none"> ● It is suspected that the engine oil level has increased excessively. 	<ul style="list-style-type: none"> ● Immediately have your vehicle checked by a MITSUBISHI MOTORS Authorized Service Point. Refer to “Engine oil level warning display*” on page 5-51.

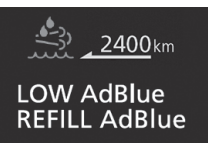

5

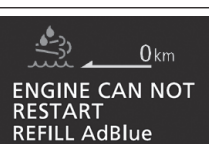
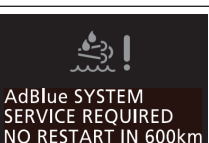
Indication lamp, warning lamp, and information screen display list

Screen	Cause	Solution (Reference)
 <p>REMOVE WATER IN SEPARATOR</p>	<ul style="list-style-type: none"> More than specified limit water has accumulated in the fuel filter. 	<ul style="list-style-type: none"> We recommend you to have it checked. Refer to “Fuel filter indicator display*” on page 5-49.
 <p>LOW AdBlue REFILL AdBlue</p>	<ul style="list-style-type: none"> The AdBlue™ is running low. AdBlue™: trademark of the Verband der Automobilindustrie e.V. (VDA). 	<ul style="list-style-type: none"> Replenish the AdBlue™ soon. Refer to “Urea SCR system (AdBlue™-related system)” on page 6-28.
 <p>ENGINE WILL NOT RESTART REFILL AdBlue</p>	<ul style="list-style-type: none"> There is almost no AdBlue™ remaining. 	<ul style="list-style-type: none"> Replenish the AdBlue™ immediately. Once 0 km (0 mile) is displayed for the driving range, the engine cannot be restarted after it is stopped. Refer to “Urea SCR system (AdBlue™-related system)” on page 6-28.
 <p>ENGINE CAN NOT RESTART REFILL AdBlue</p>	<ul style="list-style-type: none"> There is no AdBlue™ remaining. 	<ul style="list-style-type: none"> Replenish the AdBlue™ immediately. The engine cannot be restarted after it is stopped. Refer to “Urea SCR system (AdBlue™-related system)” on page 6-28.
 <p>AdBlue SYSTEM SERVICE REQUIRED NO RESTART IN 600km</p>	<ul style="list-style-type: none"> There is a fault in the Urea SCR system (AdBlue™-related system). 	<ul style="list-style-type: none"> Have the vehicle inspected by a MITSUBISHI MOTORS Authorized Service Point as soon as possible. If you continue to drive the vehicle, the engine cannot be restarted after it is stopped. Refer to “Urea SCR system (AdBlue™-related system)” on page 6-28.

5

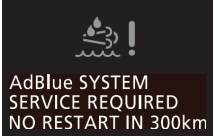
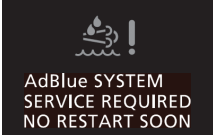
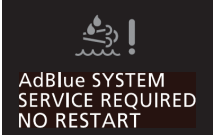



Indication lamp, warning lamp, and information screen display list

Screen	Cause	Solution (Reference)
 <p>AdBlue SYSTEM SERVICE REQUIRED NO RESTART IN 300km</p>	<ul style="list-style-type: none"> ● There is a fault in the Urea SCR system (AdBlue™-related system). 	<ul style="list-style-type: none"> ● Have the vehicle inspected by a MITSUBISHI MOTORS Authorized Service Point as soon as possible. If you continue to drive the vehicle, the engine cannot be restarted after it is stopped. Refer to “Urea SCR system (AdBlue™-related system)” on page 6-28.
 <p>AdBlue SYSTEM SERVICE REQUIRED NO RESTART SOON</p>	<ul style="list-style-type: none"> ● There is a fault in the Urea SCR system (AdBlue™-related system). 	<ul style="list-style-type: none"> ● Have the vehicle inspected by a MITSUBISHI MOTORS Authorized Service Point immediately. If you continue to drive the vehicle, the engine cannot be restarted after it is stopped. Refer to “Urea SCR system (AdBlue™-related system)” on page 6-28.
 <p>AdBlue SYSTEM SERVICE REQUIRED NO RESTART</p>	<ul style="list-style-type: none"> ● There is a fault in the Urea SCR system (AdBlue™-related system). 	<ul style="list-style-type: none"> ● Contact a MITSUBISHI MOTORS Authorized Service Point immediately. The engine cannot be restarted after it is stopped. Refer to “Urea SCR system (AdBlue™-related system)” on page 6-28.
 <p>AIRBAG SYSTEM SERVICE REQUIRED</p>	<ul style="list-style-type: none"> ● There is a fault in the SRS airbag or the pretensioner system. 	<ul style="list-style-type: none"> ● We recommend you to have it checked, immediately. Refer to “SRS warning lamp/display” on page 4-37.





5

Indication lamp, warning lamp, and information screen display list

5

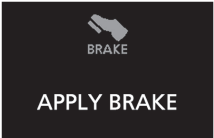
Screen	Cause	Solution (Reference)
	<ul style="list-style-type: none"> ● There is a fault in the Active Stability Control (ASC). 	<ul style="list-style-type: none"> ● We recommend you to have it checked. Refer to “Active stability control (ASC)” on page 6-66.
	<ul style="list-style-type: none"> ● There is a fault in the hill start assist. 	<ul style="list-style-type: none"> ● We recommend you to have it checked. Refer to “Hill start assist” on page 6-60.
	<ul style="list-style-type: none"> ● There is a fault in the S-AWC system. 	<ul style="list-style-type: none"> ● We recommend you to have it checked. Refer to “S-AWC (Super-All Wheel Control)” on page 6-50.
	<ul style="list-style-type: none"> ● There is a fault in the A/T or CVT. 	<ul style="list-style-type: none"> ● We recommend you to have it checked. Refer to “8-speed Automatic transmission with Sports Mode” on page 6-36. Refer to “INVECS-III CVT with 8-step Sports Mode” on page 6-43.
	<ul style="list-style-type: none"> ● The S-AWC system is hot. 	<ul style="list-style-type: none"> ● Refer to “S-AWC (Super-All Wheel Control)” on page 6-50.
	<ul style="list-style-type: none"> ● The outside temperature is 3 °C (37 °F) or less. 	<ul style="list-style-type: none"> ● Be careful of ice on the road. ● The road can be icy even when this warning is not displayed, so drive carefully.





Indication lamp, warning lamp, and information screen display list

Screen	Cause	Solution (Reference)
	<ul style="list-style-type: none"> The Adaptive Cruise Control System (ACC) has detected the approach of the vehicles in front. 	<ul style="list-style-type: none"> Increase the following distance by depressing the brake pedal or marking other decelerating control. Refer to “Adaptive Cruise Control System (ACC): Proximity alarm ” on page 6-81.
	<ul style="list-style-type: none"> The Forward Collision Mitigation system (FCM) has detected the danger of collision. 	<ul style="list-style-type: none"> Take appropriate action such as depressing the brake to avoid collision. Refer to “Forward collision warning function” on page 6-92.
	<ul style="list-style-type: none"> The Electric parking brake cannot be applied automatically. 	<ul style="list-style-type: none"> Depress the brake pedal as soon as possible. Refer to “Brake auto hold” on page 6-57.
	<ul style="list-style-type: none"> The Adaptive Cruise Control System (ACC) control is active. 	<ul style="list-style-type: none"> Refer to “How to use ACC” on page 6-83.
	<ul style="list-style-type: none"> The Adaptive Cruise Control System (ACC) control is automatically cancelled and the system is placed in the standby state. 	
	<ul style="list-style-type: none"> Conditions for the start of control are not met, the Adaptive Cruise Control System (ACC) cannot start the control. 	





5

Indication lamp, warning lamp, and information screen display list

5





Screen	Cause	Solution (Reference)	
 <p>ACC OUT OF SPEED RANGE</p>	<ul style="list-style-type: none"> The Adaptive Cruise Control System (ACC) cannot start the control because the speed is out of speed range. 		
 <p>ACC NO FORWARD VEHICLE</p>	<ul style="list-style-type: none"> The Adaptive Cruise Control System (ACC) cannot start the control because not detected the approach of the vehicles in front. 		
 <p>ACC TEMPORARILY NOT AVAILABLE</p>	<ul style="list-style-type: none"> The Adaptive Cruise Control System (ACC) is not available temporarily such as for adhesion of contaminants to the sensor. This is not a malfunction. 		
 <p>ACC SERVICE REQUIRED</p>	<ul style="list-style-type: none"> There is a fault in the Adaptive Cruise Control System (ACC). 		<ul style="list-style-type: none"> We recommend you to have it checked. Refer to “To terminate ACC control” on page 6-87.
 <p>ACC RADAR BLOCKED</p>	<ul style="list-style-type: none"> Foreign objects, such as dirt, snow or ice, adhere to the bumper surface around the sensor. 		<ul style="list-style-type: none"> Remove a foreign object on the bumper surface around the sensor. When the warning display does not disappear after having cleaned the bumper surface around the sensor, contact a MITSUBISHI MOTORS Authorized Service Point. Refer to “To terminate ACC control” on page 6-87.

Indication lamp, warning lamp, and information screen display list





Screen	Cause	Solution (Reference)
 <p>FCM SERVICE REQUIRED</p>	<ul style="list-style-type: none"> There is a fault in the Forward Collision Mitigation system (FCM). 	<ul style="list-style-type: none"> We recommend you to have it checked. Refer to “System problem warning” on page 6-97
 <p>FCM RADAR BLOCKED</p>	<ul style="list-style-type: none"> Foreign objects, such as dirt, snow or ice, adhere to the bumper surface around the sensor. 	<ul style="list-style-type: none"> Remove a foreign object on the bumper surface around the sensor. When the warning display does not disappear after having cleaned the bumper surface around the sensor, contact a MITSUBISHI MOTORS Authorized Service Point. Refer to “Forward Collision Mitigation system (FCM): System problem warning” on page 6-97.
 <p>FCM BRAKE ACTIVATED</p>	<ul style="list-style-type: none"> The FCM braking function of the Forward Collision Mitigation system (FCM) has been activated. 	<ul style="list-style-type: none"> Refer to “FCM braking function” on page 6-93.
 <p>FCM TEMPORARILY NOT AVAILABLE</p>	<ul style="list-style-type: none"> The Forward Collision Mitigation system (FCM) is temporarily unavailable for some reason. This is not a malfunction. 	<ul style="list-style-type: none"> Refer to “System problem warning” on page 6-97.

5

Indication lamp, warning lamp, and information screen display list

Screen	Cause	Solution (Reference)
	<ul style="list-style-type: none"> ● The Lane Departure Warning (LDW) has detected that your vehicle is about to leave or has left the lane. 	<ul style="list-style-type: none"> ● Refer to “Lane Departure Warning” on page 6-113.
<div style="display: flex; align-items: center;"> <div style="background-color: black; color: white; padding: 2px 5px; margin-right: 5px; font-weight: bold;">5</div>  </div>	<ul style="list-style-type: none"> ● There is a fault in the Lane Departure Warning (LDW). 	<ul style="list-style-type: none"> ● We recommend you to have it checked. Refer to “LDW deactivation due to fault” on page 6-115.
  	<ul style="list-style-type: none"> ● The Ultrasonic misacceleration Mitigation System (UMS) sensor is temporarily not available for some reason such as the environmental condition or increase of the sensor temperature. 	<ul style="list-style-type: none"> ● When the warning display does not disappear after waiting for a while, contact a MITSUBISHI MOTORS Authorized Service Point. Refer to “Ultrasonic misacceleration Mitigation System (UMS): Warning display” on page 6-107.





Indication lamp, warning lamp, and information screen display list

Screen	Cause	Solution (Reference)
  	<ul style="list-style-type: none"> ● The Ultrasonic misacceleration Mitigation System (UMS) does not operate normally because there are some malfunctions in the sensor or the system. 	<ul style="list-style-type: none"> ● We recommend you to have it checked, immediately. Refer to “Ultrasonic misacceleration Mitigation System (UMS): Warning display” on page 6-107.
 	<ul style="list-style-type: none"> ● The Ultrasonic misacceleration Mitigation System (UMS) is activated. 	<ul style="list-style-type: none"> ● Refer to “Ultrasonic misacceleration Mitigation System (UMS)” on page 6-102.



5

Indication lamp, warning lamp, and information screen display list

5





Screen	Cause	Solution (Reference)
	<ul style="list-style-type: none"> The Blind Spot Warning (BSW) sensor is temporarily not available for some reason such as the environmental condition or increase of the sensor temperature. 	<ul style="list-style-type: none"> When the warning display does not disappear after waiting for a while, contact a MITSUBISHI MOTORS Authorized Service Point. Refer to “When the sensor is temporarily not available” on page 6-111.
	<ul style="list-style-type: none"> The Blind Spot Warning (BSW) does not operate normally because there are some malfunctions in the system. 	<ul style="list-style-type: none"> We recommend you to have it checked, immediately. Refer to “When there is a malfunction in the system” on page 6-111.
	<ul style="list-style-type: none"> Foreign objects, such as dirt, snow or ice, adhere to the bumper surface around the sensor. 	<ul style="list-style-type: none"> Remove a foreign object on the bumper surface around the sensor. When the warning display does not disappear after having cleaned the bumper surface around the sensor, contact a MITSUBISHI MOTORS Authorized Service Point. Refer to “Blind Spot Warning (BSW): When there is a foreign object on the sensor” on page 6-111.
	<ul style="list-style-type: none"> The Rear Cross Traffic Alert (RCTA) has detected a vehicle that is approaching your vehicle. 	<ul style="list-style-type: none"> Pay special attention to the rear of your vehicle. Refer to “Rear Cross Traffic Alert (RCTA)” on page 6-111.

Indication lamp, warning lamp, and information screen display list

Screen	Cause	Solution (Reference)
 <p>DRIVER ASSISTANCE CAMERA SERVICE REQUIRED</p>	<ul style="list-style-type: none"> ● There is a fault in the sensor. 	<ul style="list-style-type: none"> ● We recommend you to consult a MITSUBISHI MOTORS Authorized Service Point. Refer to “Forward Collision Mitigation system (FCM): System problem warning” on page 6-97. Refer to “Lane Departure Warning (LDW): System problem warning” on page 6-113. Refer to “Automatic High-Beam (AHB): System problem warning” on page 5-61.
 <p>DRIVER ASSISTANCE CAMERA TEMPORARILY NOT AVAILABLE</p>	<ul style="list-style-type: none"> ● The Forward Collision Mitigation system (FCM), Lane Departure Warning (LDW) and Automatic High-Beam (AHB) are temporarily unavailable due to the high or low temperature of the sensor. 	<ul style="list-style-type: none"> ● After the temperature of the sensor has been in range, the system will automatically return to operation. Refer to “Forward Collision Mitigation system (FCM): System problem warning” on page 6-97. Refer to “Lane Departure Warning (LDW): System problem warning” on page 6-113. Refer to “Automatic High-Beam (AHB): System problem warning” on page 5-61.
 <p>DRIVER ASSISTANCE CAMERA BLOCKED</p>	<ul style="list-style-type: none"> ● The sensor is temporarily unavailable due to conditions such as the adhesion of contaminants to the sensor or windscreen. This is not a malfunction. 	<ul style="list-style-type: none"> ● Refer to “Forward Collision Mitigation system (FCM): System problem warning” on page 6-97. Refer to “Lane Departure Warning (LDW): System problem warning” on page 6-113. Refer to “Automatic High-Beam (AHB): System problem warning” on page 5-61.

5

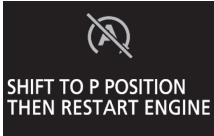
Indication lamp, warning lamp, and information screen display list

Screen	Cause	Solution (Reference)
 <p>AHB SERVICE REQUIRED</p>	<ul style="list-style-type: none"> ● There is a fault in the system of the automatic high-beam. 	<ul style="list-style-type: none"> ● We recommend you to consult a MITSUBISHI MOTORS Authorized Service Point. Refer to “Automatic High-Beam (AHB): System problem warning” on page 5-61.
 <p>AS&G SYSTEM SERVICE REQUIRED</p>	<ul style="list-style-type: none"> ● There is a fault in the Auto Stop & Go (AS&G) system. 	<ul style="list-style-type: none"> ● Refer to “Auto Stop & Go (AS&G) system” on page 6-30.
 <p>SHIFT TO P POSITION THEN RESTART ENGINE</p>	<ul style="list-style-type: none"> ● On vehicles with A/T or CVT, the engine was not automatically started by the Auto Stop & Go (AS&G) system. 	<ul style="list-style-type: none"> ● Refer to “Auto Stop & Go (AS&G) system” on page 6-30.
 <p>RESTART ENGINE</p>	<ul style="list-style-type: none"> ● On vehicles with M/T, the engine was not automatically started by the Auto Stop & Go (AS&G) system. 	

5

Navigation information display*

On vehicles equipped with the MITSUBISHI Multi-Communication System (MMCS), the following information on navigation will be displayed when guidance location such as junction and destination is approached after

Indication lamp, warning lamp, and information screen display list

you set the destination and started the route guidance.

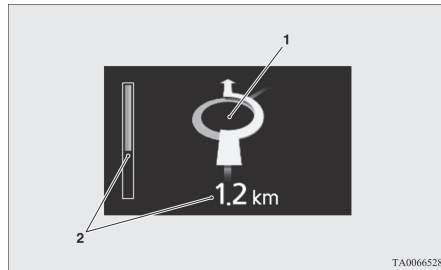

Shows the direction of vehicle travel and the guidance location.

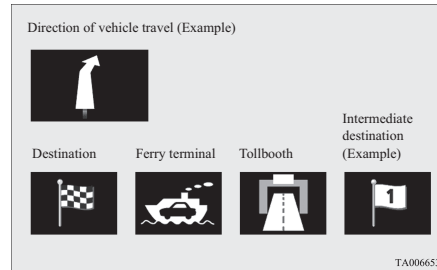

2- Remaining distance display
Shows the distance to the location where the guidance is displayed.

NOTE

- The navigation information display can be turned on or off. Refer to “Changing the navigation information display*” on page 5-20.
- Please read this section and also the separate owner’s manual for MITSUBISHI Multi-Communication System (MMCS).

5

1- Guidance display
Other interrupt displays

Screen	System operation status	Solution (Reference)
	<ul style="list-style-type: none"> ● When starting the engine, you pressed the engine switch without depressing the clutch pedal (M/T). 	<ul style="list-style-type: none"> ● Place the gearshift lever in the “N” (Neutral) position, fully depress the clutch pedal, depress the brake pedal with the right foot. Then, press the engine switch. Refer to “Starting and stopping the engine” on page 6-19.
	<ul style="list-style-type: none"> ● When starting the engine, the selector lever is in a position other than the “P” (Park) or the “N” (Neutral) position, or you pressed the engine switch without depressing the brake pedal (A/T or CVT). 	<ul style="list-style-type: none"> ● Place the selector lever in the “P” (Park) position, depress the brake pedal with the right foot. Then, press the engine switch. Refer to “Starting and stopping the engine” on page 6-19.



Indication lamp, warning lamp, and information screen display list

Screen	System operation status	Solution (Reference)
	<ul style="list-style-type: none"> When communication was successful after the keyless operation key was touched to the engine switch. 	<ul style="list-style-type: none"> Refer to “Starting and stopping the engine” on page 6-19.





The operation status of each system is displayed on the information screen. Refer to the appropriate page for the system for further details.

5  **NOTE**

- When operating each system, confirm that the operation status of the system has changed on the information screen. However, the operation status of the system may not be displayed immediately after the warning display appears even if the system is operated.

Screen	System operation status	Reference
	<ul style="list-style-type: none"> When “AUTO” mode of S-AWC is selected. 	<ul style="list-style-type: none"> Refer to “S-AWC (Super-All Wheel Control)” on page 6-50.
	<ul style="list-style-type: none"> When “SNOW” mode of S-AWC is selected. 	
	<ul style="list-style-type: none"> When “GRAVEL” mode of S-AWC is selected. 	

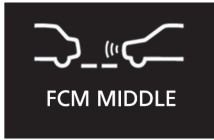
Indication lamp, warning lamp, and information screen display list

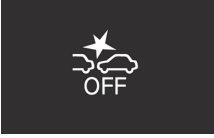
Screen	System operation status	Reference
	<ul style="list-style-type: none"> When the parking sensor detects an obstacle. 	<ul style="list-style-type: none"> Refer to “Parking sensors (Front/Rear)*” on page 6-124.
	<ul style="list-style-type: none"> When the ECO mode is activated. 	<ul style="list-style-type: none"> Refer to “ECO mode switch*” on page 5-66.
  	<ul style="list-style-type: none"> When the Forward Collision Mitigation system (FCM) is activated or the timing of an alarm is changed. 	<ul style="list-style-type: none"> Refer to “FCM and Ultrasonic misacceleration Mitigation System (UMS)* ON/OFF switch” on page 6-96.
	<ul style="list-style-type: none"> When the Forward Collision Mitigation system (FCM) is deactivated. 	<ul style="list-style-type: none"> Refer to “FCM and Ultrasonic misacceleration Mitigation System (UMS)* ON/OFF switch” on page 6-96.
	<ul style="list-style-type: none"> When the Ultrasonic misacceleration Mitigation System (UMS) is deactivated. 	<ul style="list-style-type: none"> Refer to “To turn on/off the UMS” on page 6-107.

5

Indication lamp, warning lamp, and information screen display list

This informs you that a periodic inspection is due.

5

Screen	Solution
	<p>We recommend you to have it checked. Refer to “Service reminder” for further details on page 5-09.</p>

The setting for rest interval can be changed.

Screen	Solution
	<p>Stop the vehicle in a safe place, turn off the engine, and take a rest. Use this display as rough guide for taking rests during a long drive. The interval from the start of your trip until this message is displayed can be set. Refer to “Changing the time until “REST REMINDER” is displayed” on page 5-19. The display and buzzer alert the driver when the set time is reached. If you continue to drive without having a rest, the buzzer sounds approximately every 5 minutes to encourage you to take a rest.</p> <ul style="list-style-type: none"> ● In the following cases, the time driven is reset and the display returns to the previous display screen. After this, when the set time is reached again, the buzzer and display encourage you to take a rest. <ul style="list-style-type: none"> • The buzzer sounds three times. • Turn the ignition switch to the “LOCK” position or put the operation mode in OFF. • The multi-information display switches are held for approximately 2 seconds or more.

Indication lamps

Turn-signal indication lamps/ Hazard warning indication lamps

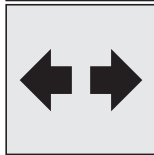

These indication lamps blink in the following situations.

- When the turn-signal lever is moved to activate a turn-signal lamp. Refer to “Turn-signal lever” on page 5-65.
- When the hazard warning flasher switch is pressed to activate the hazard warning lamps. Refer to “Hazard warning flasher switch” on page 5-65.
- When the hazard warning lamps automatically activate due to sudden braking while driving. Refer to “Emergency stop signal system” on page 6-63.

High-beam indication lamp

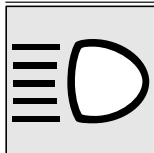

This indication lamp illuminates when the high-beam is used.

Front fog lamp indication lamp*

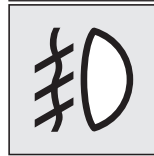

This lamp illuminates while the front fog lamps are on.

Rear fog lamp indication lamp

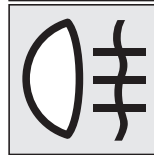

This lamp illuminates while the rear fog lamp is on.

Position lamp indication lamp

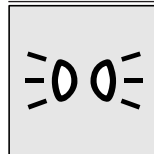

This indication lamp illuminates while the position lamps are on.

Diesel preheat indication lamp (diesel-powered vehicles)

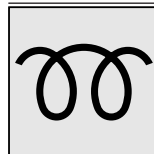

This indicates the glow plug preheat condition. [Except for vehicles equipped with keyless operation system]

When the ignition switch is turned to the “ON” position, the lamp illuminates. As the glow plug becomes hot, the lamp goes out and the engine can be started.

[For vehicles equipped with keyless operation system]

When the operation mode is put in ON, the lamp illuminates and preheating of the glow lamp starts automatically. As the glow plug becomes hot, the lamp goes out and the engine starts.

5

NOTE

- If the engine is cold, the diesel preheat indication lamp is on for a longer time.
- When the engine is warm, the diesel preheat indication lamp does not come on even if the ignition switch is turned to the “ON” position or the operation mode is put in ON.

Warning lamps

Brake warning lamp

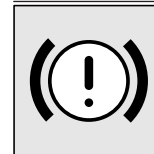

This lamp illuminates when the ignition switch is turned to the “ON” position or the operation mode is put in ON, and goes off after a few seconds.

Always make sure that the lamp goes off before driving.

Warning lamps

With the ignition switch or the operation mode in ON, the brake warning lamp illuminates under the following conditions:

- When the parking brake lever has been engaged.
- When the brake fluid level in the reservoir falls to a low level.
- When the brake force distribution function is not operating correctly.

5

With the ignition switch or the operation mode in ON, a buzzer sounds under the condition that the vehicle speed exceeds 8 km/h with the parking brake applied.

CAUTION

- In the situations listed below, brake performance may be compromised or the vehicle may become unstable if brakes are applied suddenly; consequently, avoid driving at high speeds or applying the brakes suddenly. Furthermore, the vehicle should be brought to a stop in a safe location and to have it checked.
 - The brake warning lamp does not illuminate when the parking brake is applied or does not turn off when the parking brake is released.
 - The ABS warning lamp and brake warning lamp illuminate at the same time. For details, refer to “ABS warning lamp/display” on page 6-64.
 - The brake warning lamp remains illuminated during driving.

CAUTION

- The vehicle should be brought to a halt in the following manner when brake performance has deteriorated.
 - Depress the brake pedal harder than usual. Even if the brake pedal moves down to the very end of its possible stroke, keep it pressed down hard.
 - Should the brakes fail, use engine braking to reduce your speed and observe the following instructions.
 - [Vehicles with the parking brake of the lever type]
Carefully pull the parking brake lever.
 - [Vehicles with the Electric parking brake]
Keep pulling the Electric parking brake switch. (Refer to “Electric parking brake” on page 6-05.)

Depress the brake pedal to operate the stop lamp to alert the vehicles behind you.

Electric parking brake warning lamp*



This warning lamp will illuminate when there is a fault in the Electric parking brake system. Normally, this warning lamp illuminates when the ignition switch is turned to the “ON” position or the operation mode is put in ON, and goes off in a few seconds.

CAUTION

- When the warning lamp remains on or does not come on, there is a possibility that the parking brake cannot be operated or released. Immediately contact the nearest MITSUBISHI MOTORS Authorized Service Point. When the warning lamp comes on during driving, immediately stop the vehicle in a safe place, and contact your MITSUBISHI MOTORS Authorized Service Point. If you inevitably have to park, park the vehicle on level and stable ground, shift the selector lever in “P” (Park) position and place chocks or blocks.

Check engine warning lamp

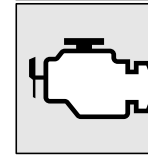

This lamp is a part of an on-board diagnostic system which monitors the emissions, engine control system, urea SCR system or A/T control system/CVT control

system.

If a problem is detected in one of these systems, this lamp illuminates or flashes.

Although your vehicle will usually be drivable and not need towing, we recommend you to have the system checked as soon as possible.

This lamp will also illuminate when the ignition switch is turned “ON” or the operation mode is put in ON, and goes off after the engine has started. If it does not go off after the engine has started, we recommend you to have the vehicle checked.

⚠ CAUTION

- Prolonged driving with this lamp on may cause further damage to the emission control system. It could also affect fuel economy and drivability.
- If the lamp does not illuminate when the ignition switch is turned to the “ON” position or the operation mode is put in ON, we recommend you to have the system checked.
- If the lamp illuminates while the engine is running, avoid driving at high speeds and have the system inspected by a MITSUBISHI MOTORS Authorized Service Point as soon as possible.
Accelerator pedal and brake pedal response may be negatively influenced under these conditions.

📖 NOTE

- The engine electronic control module accommodating the onboard diagnostic system has various fault data (especially about the exhaust emission) stored.

This data will be erased if a battery cable is disconnected which will make a rapid diagnosis difficult. Do not disconnect a battery cable when the check engine warning lamp is ON.

Charge warning lamp

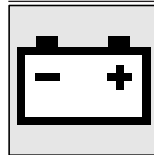

If there is a fault with the charging system, this lamp illuminates.

Normally, this lamp illuminates when the ignition switch is turned to the “ON” position or the operation mode is put in ON, and goes off after the engine has started. The charge warning display is also displayed in the multi-information display.

⚠ CAUTION

- If it illuminates while the engine is running, there is a problem in the charging system. Immediately park your vehicle in a safe place and we recommend you to have it checked.

Information screen display

Fuel filter indicator display*



5

When the ignition switch is turned to the “ON” position or the operation mode is put in ON, if more water than the specified limit has accumulated in the fuel filter, the warning display is displayed on the information screen in the multi-information display.

⚠ CAUTION

- If this warning display is displayed we recommend you to have it checked. Prolonged driving with the warning display shown may damage the engine.

📖 NOTE

- If “REMOVE WATER IN SEPARATOR” does not go out or appears frequently after removing the water, we recommend you to consult a MITSUBISHI MOTORS Authorized Service Point.

Information screen display

Brake warning display



5

This warning is displayed if you drive with the parking brake still applied. The brake warning lamp in the instrument cluster only illuminates when the parking brake is applied.

For details, refer to “Brake warning lamp” on page 5-47.

CAUTION

- If a vehicle is driven without releasing the parking brake, the brake will be overheated, resulting in ineffective braking and possible brake failure.
If this warning is displayed, release the parking brake.



When the ignition switch is turned to the “ON” position or the operation mode is put in ON, if the brake fluid is low, this warning is displayed.

The brake warning lamp in the instrument cluster also illuminates.

For details, refer to “Brake warning lamp” on page 5-47.

CAUTION

- If this warning stays illuminated and does not go out while driving, there is a danger of ineffective braking. In this case, immediately park your vehicle in a safe place and we recommend you to have it checked.
- If the brake warning display is displayed and the brake warning lamp and the ABS warning lamp are illuminated at the same time, the braking force distribution function will not operate, so the vehicle may be destabilised during sudden braking. Avoid sudden braking and high-speed driving, stop the vehicle in a safe place, and we recommend you to have it checked.
- The vehicle should be brought to a halt in the following manner when brake performance has deteriorated.
 - Depress the brake pedal harder than usual. Even if the brake pedal moves down to the very end of its possible stroke, keep it pressed down hard.

CAUTION

- Should the brakes fail, use engine braking to reduce your speed and observe the following instructions.
[Vehicles with the parking brake of the lever type]
Carefully pull the parking brake lever.
[Vehicles with the Electric parking brake]
Keep pulling the Electric parking brake switch. (Refer to “Electric parking brake” on page 6-05.)

Depress the brake pedal to operate the stop lamp to alert the vehicles behind you.

Charge warning display



If there is a fault with the charging system, the warning display is displayed on the information screen in the multi-information display. The charge warning lamp in the instrument cluster also illuminates.

⚠ CAUTION

- If the warning is displayed while the engine is running, immediately park your vehicle in a safe place and we recommend you to have it checked.

Oil pressure warning display



If the engine oil pressure drops while the engine is running, the warning display is displayed on the information screen in the multi-information display.

⚠ CAUTION

- If the vehicle is driven while the engine oil is low, or the oil level is normal but the warning is displayed, the engine may burn out and be damaged.
- If the warning is displayed while the engine is running, immediately park your vehicle in a safe place and check the engine oil level.
- If the warning is displayed while the engine oil level is normal, have it inspected.

Engine oil level warning display*



When the ignition switch or the operation mode is in ON, if it is suspected that the engine oil level has increased excessively, the warning display is displayed on the information screen in the multi-information display.

⚠ CAUTION

- If this warning is displayed while driving, stop the vehicle in a safe place, turn off the engine, and check the engine oil level. Refer to “Engine oil” on page 10-04.

📖 NOTE

- Immediately have your vehicle checked by a MITSUBISHI MOTORS Authorized Service Point.

Head Up Display (HUD)*

The Head Up Display (HUD) shows information on a transparent display so that you can easily check meter information (vehicle speed, navigation instructions, etc.) while looking ahead when driving.

5

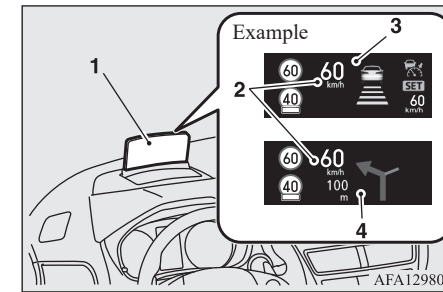

- 1- Display
- 2- Speed display screen
- 3- Information display screen
- 4- Navigation information display screen*

Displayed information:

- Vehicle speed
- Navigation information*
- Auto-speed (cruise) control information
- Speed limiter information*
- Adaptive Cruise Control System (ACC) information*

Head Up Display (HUD)*

- Traffic Sign Recognition (TSR) information*

When a warning is displayed on the information screen in the meter, a warning will also be displayed on the HUD.

Examples of displayed warnings:

5

- Door ajar warning
- Seat belt reminder
- Adaptive Cruise Control System (ACC) warning*
- Forward Collision Mitigation system (FCM) warning*
- Lane Departure Warning (LDW)*

Refer to “Indication lamp, warning lamp, and information screen display list” on page 5-21.

⚠ WARNING

- **Always stop the vehicle in a safe place before operating the HUD. Operating the HUD while driving could distract you and an accident might occur.**
- **Do not spray water or spill beverages in the HUD. If the switches, wires or electrical components become wet, they could malfunction or cause a vehicle fire. If you accidentally spill a beverage, wipe up as much liquid as possible and immediately consult a MITSUBISHI MOTORS Authorized Service Point.**

⚠ CAUTION

- When opening or closing the display, keep your hands, etc., away from the moving parts. Otherwise, your hands could be caught, resulting in personal injury.
- Do not place any objects near the HUD. The objects could prevent the display from opening or obstruct the opening operation, resulting in a malfunction.
- Do not place beverages near the HUD. Water or other liquids could splash onto wires or electrical components, resulting in a malfunction.
- Never open, close, or adjust the angle of the display manually. Applying a strong force to the display could result in a malfunction.
- Do not affix a sticker, label, etc., to the display. They could block the display or obstruct the opening or closing operation, resulting in a malfunction. Also, the sensor (A) that adjusts the brightness of the display may not function correctly, causing the display to be difficult to see.

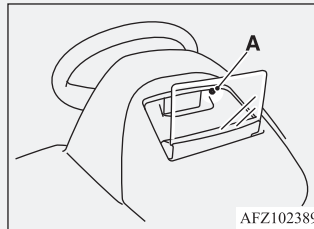

- Do not shine a bright light onto the light receiving portion of the sensor (A). The sensor could malfunction.

⚠ CAUTION

- If you drop an object into the storage space for the display and cannot retrieve it, or if the display was closed while an object was in the storage space and can no longer be opened, have the vehicle inspected by a MITSUBISHI MOTORS Authorized Service Point.

📖 NOTE

- When you are wearing sunglasses, the display may be difficult to see. Remove your sunglasses or adjust the brightness of the display. Refer to “Adjusting the brightness of the display” on page 5-51.
- If the battery is disconnected or the battery voltage is low, the display will return to the default angle and may be difficult to see. If this occurs, adjust the angle of the display. Refer to “Adjusting the angle of the display” on page 5-51.
- It may be difficult to see the display depending on the weather conditions (rain, snow, direct sunlight, temperature, etc.). If this occurs, adjust the angle and brightness of the display. Refer to “Adjusting the angle of the display” on page 5-51 and “Adjusting the brightness of the display” on page 5-51.

Head Up Display (HUD)*

Using the HUD

NOTE

- If the display does not open or close when the  switch is pushed, check that there are no objects near the display obstructing its movement. If the display does not open or close even though there are no obstructions, have the vehicle inspected by a MITSUBISHI MOTORS Authorized Service Point.

Opening the display

1. With the ignition switch is in “ON” position or the operation mode is in ON, push the  switch to open the display.

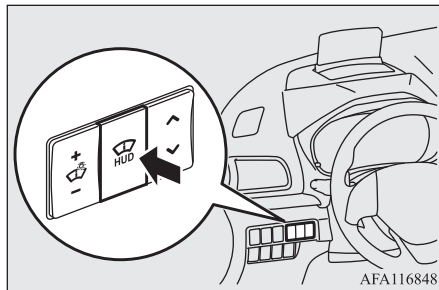

2. The launch screen will be displayed, and then information will be displayed.

NOTE

- If the HUD was open when the ignition switch was turned to the “LOCK” position or the operation mode was put in OFF, the HUD will open automatically when the ignition switch is turned to the “ON” position or the operation mode is put in ON.
- If the HUD was closed when the ignition switch was turned to the “LOCK” position or the operation mode was put in OFF, the HUD will not open automatically when the ignition switch is turned to the “ON” position or the operation mode is put in ON.

Closing the display

1. When the display is open, push the  switch.

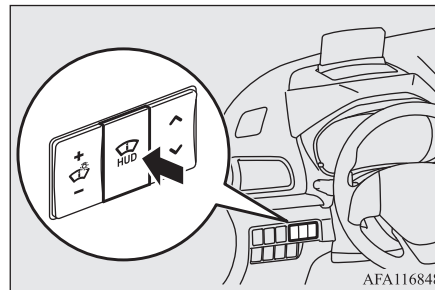

2. The setting top screen will be displayed if the vehicle is stopped, push the  switch again.



5

3. The ending screen will be displayed, and then the display will close.

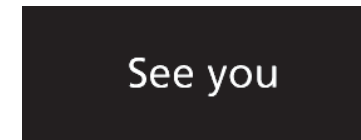

NOTE

- When the ignition switch is turned to the “LOCK” position or the operation mode is put in OFF, the HUD will close automatically.

Head Up Display (HUD)*

Adjusting the angle of the display

When the display is open, push the \wedge side or \vee side of the \diamond switch to adjust the angle of the display to raise or lower the position where the information is displayed.

5

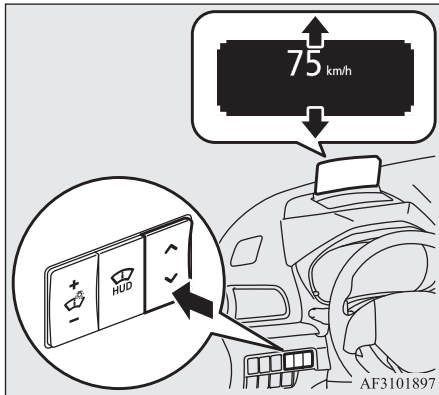

Adjusting the brightness of the display

When the display is open, push the $+$ side or $-$ side of the \diamond switch to adjust the brightness of the display. The brightness can be adjusted to 16 different levels.

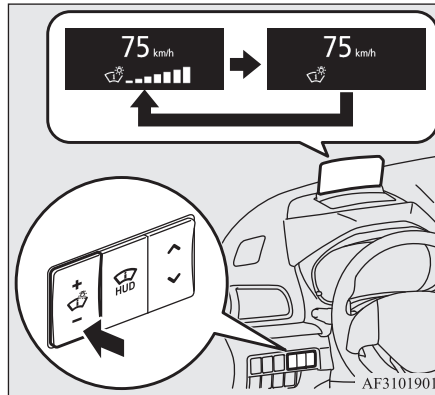

1. To change the display setting, push the \diamond switch when the display is open.

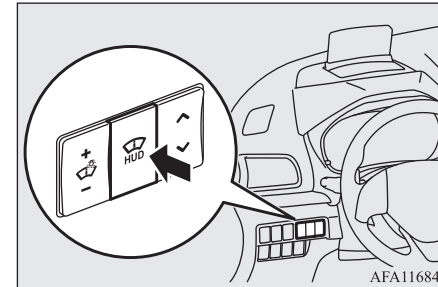

2. The setting top screen will be displayed, push and hold the \diamond switch.

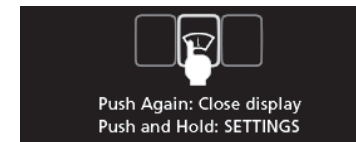

Switching the navigation information display

On vehicles equipped with MITSUBISHI Multi-Communication System (MMCS), you can select whether to display the navigation information on the display.

Head Up Display (HUD)*

3. The display setting screen will be displayed.

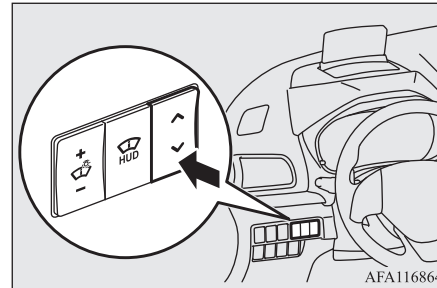
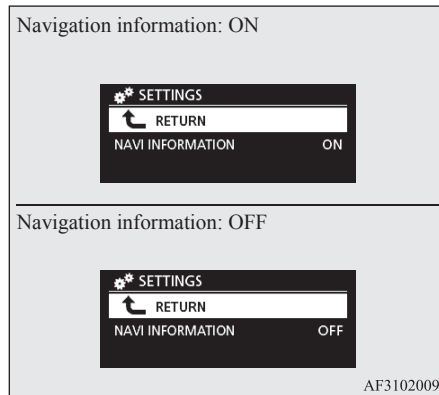

5. Push the ∇ side or \blacktriangle side of the \diamond switch to select “OFF” or “ON”, and then push the HUD switch.

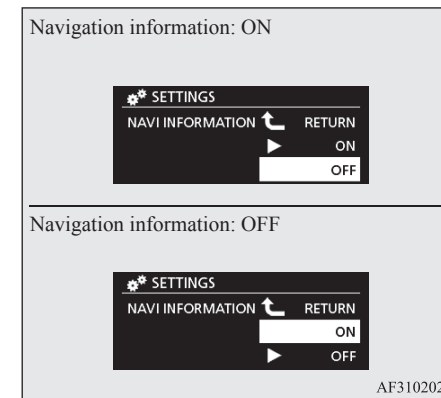

5

4. Push the ∇ side of the \diamond switch to select “NAVI INFORMATION ON” or “NAVI INFORMATION OFF”, and then push the HUD switch.

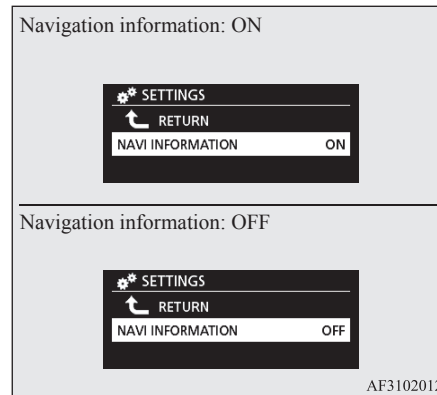

Combination headlamps and dipper switch

6. Push the \wedge side of the \diamond switch to select “RETURN”. Push the \cup switch to confirm the setting.

5

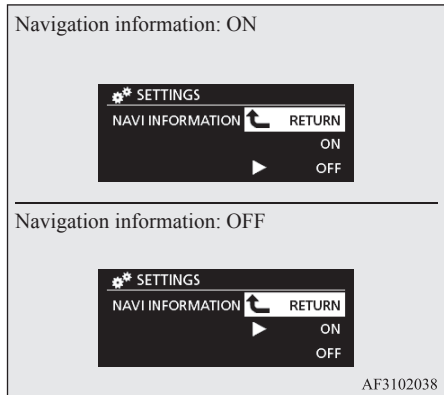

7. Push again the \cup switch while “RETURN” is selected in the setting screen, and the navigation system display will be set to “OFF” or “ON”.

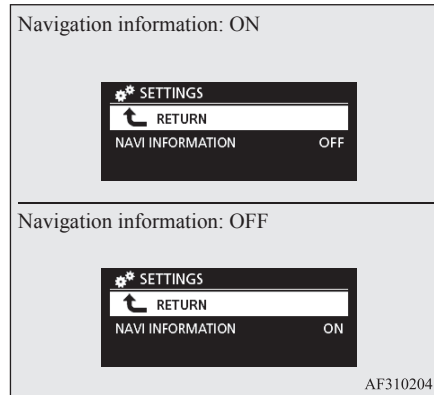

Handling the HUD

A special coating is applied to the display and mirror surface. Use a finely textured, soft cloth, such as an eyeglass cleaning cloth.

CAUTION

- Do not use cleaners or protectants that contain silicone or wax. If these cleaners and protectants are used on the display or mirror surface, the coating could be scratched and come off.

Combination headlamps and dipper switch

Headlamps

NOTE

- When entering a country in which vehicles are driven on the opposite side of the road to the country in which your vehicles is supplied, necessary measures have to be taken to avoid dazzling oncoming traffic. However, headlamps on this vehicle do not need any adjustment.
- Do not leave the lights on for a long time while the engine is stationary (not running). A run-down battery could result.
- When it rains, or when the vehicle has been washed, the inside of the lens sometimes becomes foggy, but this does not indicate a functional problem.
When the lamp is switched on, the heat will remove the fog. However, if water gathers inside the lamp, we recommend you to have it checked.

Rotate the switch to turn on the lamps.

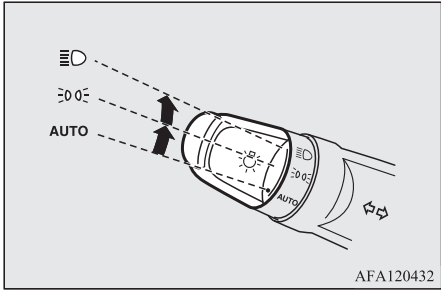

AUTO	<p>With the ignition switch or the operation mode in ON, the headlamps, position, tail, licence plate and instrument panel lamps turn on and off automatically in accordance with outside light level.</p> <p>{Daytime running lamps will go on while the tail lamps are off.}</p> <p>All lamps turn off automatically when the ignition switch is turned to "LOCK" position or the operation mode is put in OFF.</p>
	Position, tail, licence plate and instrument panel lamps on
	Headlamps and other lamps go on

NOTE

- When the headlamps are turned off by the automatic on/off control with the ignition switch in the "ON" position or the operation mode in ON, the front fog lamp (if so equipped) and rear fog lamps also go off. When the headlamps are subsequently turned back on by the automatic on/off control, the front fog lamps also come on but the rear fog lamp stays off. If you wish to turn the rear fog lamp back on, operate the switch again.
- Do not cover the sensor (A) for the automatic on/off control by affixing a sticker or label to the windscreen.

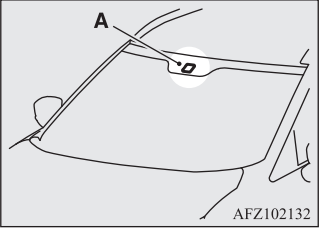

- If the lamps do not turn on or off with the switch in the "AUTO" position, manually operate the switch and we recommend you to have your vehicle checked.

Lamps (headlamps, fog lamps, etc.) auto-cutout function

- If the following operation is performed while the lamp switch is in the "AUTO" position, the lamps will turn off automatically when the driver's door is opened. [Except for vehicles equipped with keyless operation system]

The ignition switch is turned to the "LOCK" or "ACC" position, or the key is removed from the ignition switch. [For vehicles equipped with keyless operation system]

The operation mode is in OFF or ACC.
- If the following operation is performed while the lamp switch is in the "AUTO" position, the lamps will remain on for approximately 3 minutes while the driver's door is shut and will then automatically turn off. [Except for vehicles equipped with keyless operation system]

The ignition switch is turned to the "LOCK" or "ACC" position, or the key is removed from the ignition switch. [For vehicles equipped with keyless operation system]

The operation mode is in OFF or ACC.

Combination headlamps and dipper switch

NOTE

- The lamp auto-cutout will not function when the lamp switch is in the “OFF” position.
- The lamp auto-cutout function can also be disabled.
For further information, we recommend you to consult a MITSUBISHI MOTORS Authorized Service Point.
On vehicles equipped with the Smartphone Link Display Audio or the MITSUBISHI Multi-Communication System (MMCS), screen operations can be used to make the adjustment. Refer to the separate owner’s manual for details.

When you want to keep the lamps on:

1. In the following cases, turn the lamp switch to the “AUTO” position.
[Except for vehicles equipped with keyless operation system]
The ignition switch is in the “LOCK” or “ACC” position.
[For vehicles equipped with keyless operation system]
The operation mode is in OFF or ACC.
2. Turn on the lamps with the switch in the “OFF” or “AUTO” position again, then the lamps will remain on.

LED headlamp warning lamp*

This warning lamp will illuminate when there is a fault in the LED headlamps.

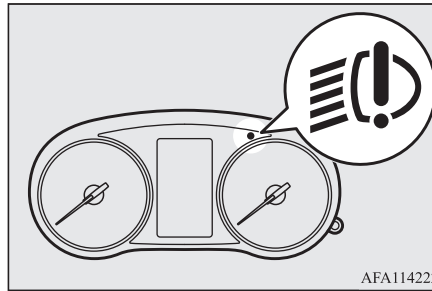

NOTE

- If the warning lamp illuminates, there may be a fault on the unit. Have the vehicle checked at a MITSUBISHI MOTORS Authorized Service Point.

Lamp monitor buzzer

If the following operation is performed, a buzzer will sound to remind the driver to turn off the lamps.

[Except for vehicles equipped with keyless operation system]

If the driver’s door is opened when the key is in the “LOCK” or “ACC” position or removed from the ignition switch while the lamps are on.

[For vehicles equipped with keyless operation system]

If the driver’s door is opened when the operation mode is in ACC or OFF while the lamps are on.

In both cases, the buzzer will automatically stop if the auto-cutoff function is activated or the door is closed.

Daytime running lamps

The daytime running lamps come on when the engine is running and the lamp switch is in the “AUTO” position and the tail lamps are off.

NOTE

- If the lamp switch is in the “OFF” or “AUTO” position, or if the tail lamps are on when the lamp switch is in the “AUTO” position, the daytime running lamps come on as position lamps.

Dipper (High/Low beam change)

When the headlamps are on, the beam changes from high to low (or low to high) each time the lever is pulled fully (1). While the high-beam is on, the high-beam indication lamp in the instrument cluster will also illuminate.

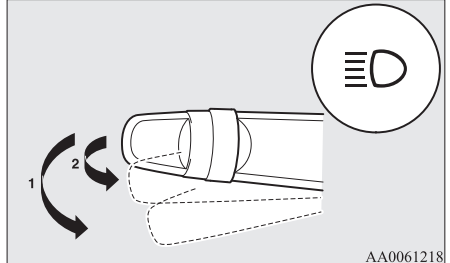

AA0061218

Headlamp flasher

The high-beams flash when the lever is pulled slightly (2), and will go off when it is released. When the high-beam is on, the high-beam indication lamp in the instrument cluster will illuminate.

NOTE

- If you turn the lamps off with the headlamps set to high-beam, the headlamps are automatically returned to their low beam setting.

Automatic High-Beam (AHB)*

The Automatic High-Beam (AHB) switches the headlamp beams (high/low) when the sensor (A) senses a illuminant such as lights of a vehicle in front or oncoming vehicle or a street lamp.

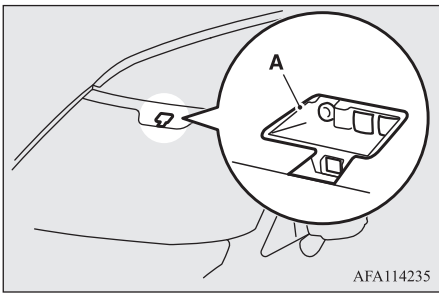

AFA114235

WARNING

- The headlamp beams (high/low) may not be switched automatically under certain circumstances. Do not overestimate the system. It is the responsibility of the driver to switch the headlamp beams (high/low) manually to suit each driving condition. Refer to “Dipper (High/Low beam change)” on page 5-59

5

How to use the AHB

1. Rotate the lamp switch to “ ” position or “AUTO” position when the engine is running.
2. Press the AHB switch.

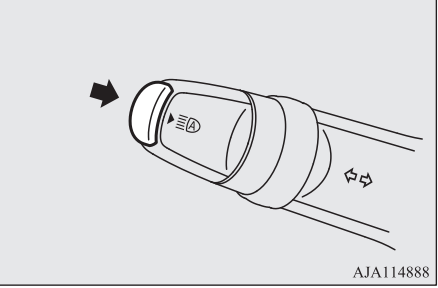

AJA114888

The AHB is activated and the indicator will illuminate.

Combination headlamps and dipper switch

If the AHB switch is pressed again, the AHB will be deactivated and AHB indicator will go off.

5

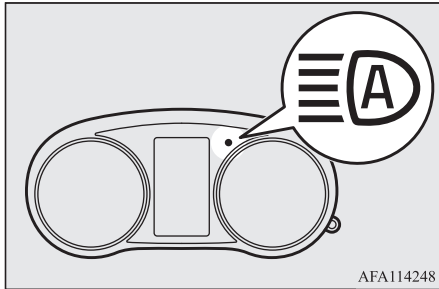

NOTE

- If the headlamps are on when the lamp switch is in the “AUTO” position, the AHB works.
- You can switch the headlamp beams (high/low) manually by operating the lever even if the AHB is working.
Refer to “Dipper (High/Low beam change)” on page 5-59
If the lever is operated manually, the AHB indicator will go off and the AHB will be deactivated.
- The AHB is not deactivated when you pull the lever slightly (operation of the headlamp flasher).

Manual switching

Switching to low beam

1. Pull the turn-signal lever towards you.
2. The AHB indicator will go off.
3. The AHB switch is pressed again, the AHB will be activated.

Switching to high-beam

1. Pull the turn-signal lever towards you.
2. The AHB indicator will go off and the high-beam indicator illuminates.
3. The AHB switch is pressed again, the AHB will be activated.

Automatic switching conditions

The high-beam headlamps illuminate when all of the following conditions are met:

- Your vehicle speed exceeds approximately 40 km/h (25 mph).
- It is dark ahead of your vehicle.
- There are no vehicles in front or oncoming vehicles, or none of their exterior lamps are illuminated.

The low beam headlamps illuminate when any of the following conditions occur:

- Your vehicle speed does not exceed approximately 30 km/h (19 mph).
- It is bright ahead of your vehicle.
- An exterior lamp of a vehicle in front or oncoming vehicle is illuminating.

NOTE

- The headlamps may not be switched from high-beam to low beam under the following circumstances:
 - A vehicle in front or oncoming vehicle is hindered by any object such as continuous bends, elevated median/island, traffic signs, roadside trees.
 - Your vehicle passes an oncoming vehicle suddenly on a bend with poor visibility.
 - Another vehicle crosses ahead of your vehicle.
- The headlamps may remain at low beam (or be switched from high-beam to low beam) when a reflective object (e.g. street lamp, traffic signal, noticeboard and signboard) reflects light.
- Any of the following factors may influence the headlamp beam switching timing:
 - How brightly the exterior lamps of a vehicle in front or oncoming vehicle illuminate.
 - Movement or direction of a vehicle in front or oncoming vehicle.
 - Only right or left exterior lamp of a vehicle in front or oncoming vehicle is illuminating.
 - A vehicle in front or oncoming vehicle is a motorcycle.
 - Road conditions (gradient, bends and road surface).
 - The number of occupants and luggage load.

NOTE

- The AHB recognises environmental conditions by sensing a light source ahead of your vehicle. Therefore, you may feel like something is not quite right when the headlamp beams are switched automatically.
- The system may not detect a light vehicle such as a bicycle.
- The system may not detect an ambient brightness precisely. This causes the traffic to be dazzled by high-beam or the low beam to be maintained. In such cases, you should switch the headlamp beams manually.
 - In bad weather (heavy rain, fog, snow or sandstorm).
 - The windscreen is dirty or fogged up.
 - The windscreen is cracked or broken.
 - The sensor is deformed or dirty.
- A light that is similar to the headlamps or tail lamps is shining around your vehicle.
- A vehicle in front or oncoming vehicle is driven without lights, the exterior lamps are dirty or discoloured, or the direction of the headlamp beams is adjusted improperly.
- It becomes dark and bright suddenly and continuously around your vehicle.
- Your vehicle is driven on uneven surfaces.
- Your vehicle is driven on a winding road.
- A reflective object such as a noticeboard or a mirror reflects a light ahead of your vehicle.
- When lamps of the vehicle in front or headlamps of an oncoming vehicle blend into the other lamps.

NOTE

- The rear end of a vehicle in front (such as a container truck) reflect a strong light.
- Your vehicle's headlamp is broken or dirty.
- Your vehicle is inclined due to a flat tyre or towing.
- The warning display appears. (Refer to "System problem warning" on page 5-61.
- Observe the precautions below to maintain good usage conditions:
 - Do not attempt to disassemble the sensor.
 - Do not affix a sticker or label on the windscreen near the sensor.
 - Avoid overload.
 - Do not modify your vehicle.
 - When the windscreen is replaced, use the MITSUBISHI MOTORS GENUINE parts.

System problem warning

If a problem occurs with the system, the following warning display will appear to the type of the problem.

The AHB deactivation due to fault

If a failure is detected in the system, the following warning display will appear and the AHB will automatically be turned off.

If the warning display remains even after the ignition switch is turned to the "LOCK" position or the operation mode is put in OFF and then turned back to ON, please contact a MITSUBISHI MOTORS Authorized Service Point.

[When the AHB is malfunctioning]



[When the sensor is malfunctioning]



5

NOTE

- If the sensor or its surrounding area reaches an extremely high temperature when parking the vehicle under a blazing sun, the "AHB SERVICE REQUIRED" warning display may appear. If the warning display remains even after the temperature of the sensor or its surrounding area has been in range, please contact a MITSUBISHI MOTORS Authorized Service Point.

Combination headlamps and dipper switch

Sensor is too hot or cold

If the system becomes temporarily unavailable due to a high or low temperature of the sensor, the following warning display will appear.

After the temperature of the sensor has been in range, the system will automatically return to operation.

If the warning display does not disappear after waiting for a while, there is a possibility that the automatic high-beam system has a malfunction. Contact a MITSUBISHI MOTORS Authorized Service Point for inspection of the system.

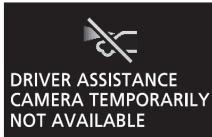

Windscreen is dirty

If the AHB determines that its performance has been degraded, the warning display will appear.

This can occur when:

- Foreign objects, such as dirt, snow or ice, adhere to the windscreen of the sensor portion.
- In adverse weather conditions, such as rain, snow, sandstorms, etc.

- A vehicle in front or an oncoming vehicle is splashing water, snow or dirt.

When the sensor performance returns, the AHB will resume operation.

If the warning display does not disappear after waiting for a while, there is a possibility that the sensor has a malfunction. Contact a MITSUBISHI MOTORS Authorized Service Point for inspection of the sensor.



Welcome light

This function turns on the position and tail lamps for approximately 30 seconds after the UNLOCK switch on the key is pressed when the combination headlamps and dipper switch is in the "AUTO" position. The welcome light function will operate only when it is dark outside the vehicle.

NOTE

- While the welcome light function is operating, perform one of the following operations to cancel the function.
 - Press the LOCK switch on the key.

NOTE

- Turn the combination headlamps and dipper switch to the "OFF" or "D" position.
- Turn the ignition switch to the "ON" position or put the operation mode in ON.
- It is possible to modify functions as follows:
 - The headlamps can be set to come on in the low beam setting.
 - The welcome light function can be deactivated.

For further information, please contact your MITSUBISHI MOTORS Authorized Service Point.

On vehicles equipped with the Smartphone Link Display Audio or the MITSUBISHI Multi-Communication System (MMCS), screen operations can be used to make the adjustment. Refer to the separate owner's manual for details.

Coming home light

This function turns on the headlamps in the low beam setting for approximately 30 seconds after the ignition switch is turned to the "LOCK" position or the operation mode is put in OFF.

1. Turn the combination headlamps and dipper switch to the "AUTO" position.
2. Turn the ignition switch to the "LOCK" position or put the operation mode in OFF. Also, if a key was used to start the engine, remove the key from the ignition switch.

Headlamp levelling

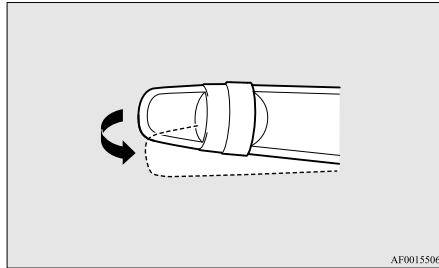

3. Within 60 seconds of turning the ignition switch to the “LOCK” position or putting the operation mode in OFF, pull the turn signal lever towards you.



4. The headlamps will come on in the low beam setting for approximately 30 seconds. After the headlamps go off, the headlamps can be turned on again in the low beam setting for approximately 30 seconds by pulling the turn signal lever towards you within 60 seconds of turning the ignition switch to the “LOCK” position or putting the operation mode in OFF.

To turn on the headlamps again after 60 seconds of turning the ignition switch to the “LOCK” position or putting the operation mode in OFF, repeat the process from step 1.

NOTE

- While the coming home light function is operating, perform one of the following operations to cancel the function.
 - Pull the turn-signal lever towards you.
 - Turn the combination headlamps and dipper switch to the “ or “” position.
 - Turn the ignition switch to the “ON” position or put the operation mode in ON.
- It is possible to modify functions as follows:
 - The time that the headlamps remain on can be changed.
 - The coming home light function can be deactivated.

For further information, please contact your MITSUBISHI MOTORS Authorized Service Point.

On vehicles equipped with the Smartphone Link Display Audio or the MITSUBISHI Multi-Communication System (MMCS), screen operations can be used to make the adjustment. Refer to the separate owner’s manual for details.

Headlamp levelling

Headlamp levelling switch (except for vehicle with LED headlamps)

The angle of the headlamp beam varies depending on the load carried by the vehicle.

The headlamp levelling switch can be used to adjust the headlamp illumination distance (when the lower beam is illuminated) so that the headlamps’ glare does not distract other drivers.

Set the switch according to the following table.

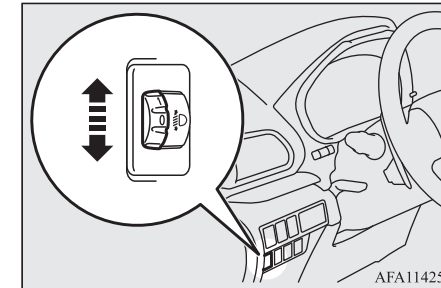

5

CAUTION

- Always perform adjustments before driving. Do not attempt to adjust while driving, as it could cause an accident.

Headlamp levelling

Except for vehicles for Russia, Kazakhstan, Belarus, Ukraine and Moldova

5

Vehicle condition	Switch position	
	2WD	4WD
	"0"	
	"0"	
	"2"	
	"3"	
	"4"	"3 or 4"

●: 1 person
 Full luggage loading

Switch position Driver only/Driver + 1 front passenger
 0-

Switch position 5 passengers (including driver)
 2-

Switch position 5 passengers (including driver) + Full luggage loading/Driver + Full luggage loading*
 3-

Switch position Driver + Full luggage loading
 4-

*: GK1WXTXXZL6/GK1WXTXXZR6 / GK9WXUHXZL6/GK9WXUHXZR6

Vehicles for Russia, Kazakhstan, Belarus, Ukraine and Moldova

Vehicle condition	Switch position	
	2WD	4WD
	"0"	
	"0"	

Vehicle condition	Switch position	
	2WD	4WD
	"2"	
	"3"	
	"4"	"3 or 4"

●: 1 person
 Full luggage loading

Switch position Driver only/Driver + 1 front passenger
 0-

Switch position 5 passengers (including driver)
 2-

Switch position 5 passengers (including driver) + Full luggage loading/Driver + Full luggage loading*
 3-

Switch position Driver + Full luggage loading
 4-

*: GK1WXTHUZL6Z

Automatic headlamp levelling (vehicles with LED headlamps)

This mechanism automatically adjusts the direction of the headlamps (beam position) depending on changes in the condition of the vehicle, such as the number of occupants or luggage weight. When the headlamps are illuminated with the ignition switch or the operation mode in ON, the beam position of the headlamps is automatically adjusted when the vehicle is stopped.

Turn-signal lever

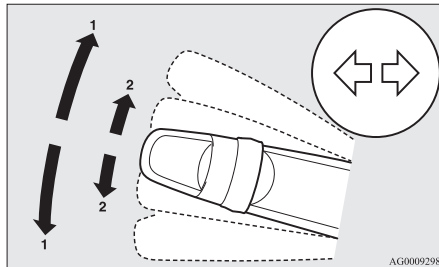

1- Turn-signals

When making a normal turn, use position (1). The lever will return automatically when cornering is completed.

2- Lane-change signals

When moving the lever to (2) slightly to change a lane, the turn-signal lamps and indication lamp in the instrument cluster will only flash while the lever is operated.

Also, when you move the lever to (2) slightly then release it, the turn-signal lamps and indication lamp in the instrument cluster will flash 3 times.

NOTE

- If the lamp flashes unusually quickly, the bulb in a turn-signal lamp may have burned out. We recommend you to have the vehicle inspected.
 - It is possible to activate the following functions.
 - Flashing of the turn-signal lamps when the lever is operated with the ignition switch or the operation mode is in ACC.
 - Deactivate the turn-signal lamp 3-flash function for lane changes
 - The time required to operate the lever for the 3-flash function can be adjusted.
- For further information, we recommend you to consult a MITSUBISHI MOTORS Authorized Service Point.
- On vehicles equipped with the Smartphone Link Display Audio or the MITSUBISHI Multi-Communication System (MMCS), screen operations can be used to make the

NOTE

adjustment. Refer to the separate owner's manual for details.

- It is possible to change the tone of a sounding buzzer as the turn-signal lamps flash. Refer to "Changing the turn-signal sound" on page 5-19.

Hazard warning flasher switch

Use the hazard warning flasher switch when the vehicle has to be parked on the road for any emergency.

The hazard warning flashers can always be operated, regardless of the ignition switch position or the operation mode.

5

ECO mode switch*

Push the switch to turn on the hazard warning flashers, all turn-signal lamps flash continuously. To turn them off, push the switch again.

5

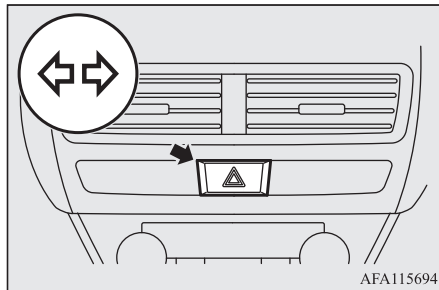

NOTE

- As your vehicle is equipped with the emergency stop signal system, while the hazard warning lamps are blinking due to having manually pushed the switch, the emergency stop signal system does not operate. Refer to "Emergency stop signal system" on page 6-63.

ECO mode switch*

ECO mode is an eco-driving support system which automatically controls the engine and air conditioning system to improve fuel efficiency.

The ECO mode starts working by pressing the ECO mode switch when the ignition switch or operation mode is in ON. Push the switch again and the ECO mode will cancel. While the ECO mode is working, an ECO mode indicator will be turned on.



NOTE

- Since the air conditioning operation is controlled while the ECO mode is operating, you may feel that effectiveness of the air conditioning is weak.

NOTE

- Even if the ECO mode is operating, you can select normal operation of the air conditioning. For further information, we recommend you to consult a MITSUBISHI MOTORS Authorized Service Point. On vehicles equipped with the Smartphone Link Display Audio or the MITSUBISHI Multi-Communication System (MMCS), it is possible to change the setting by means of screen operations. Refer to the separate owner's manual for details.

Fog lamp switch

Front fog lamp switch*

The front fog lamps can be operated while the headlamps or tail lamps are on. Turn the knob in the “ON” direction to turn on the front fog lamps. An indication lamp in the instrument cluster will also come on. Turn the knob in the “OFF” direction to turn off the front fog lamps. The knob will automatically return to its original position when you release it.

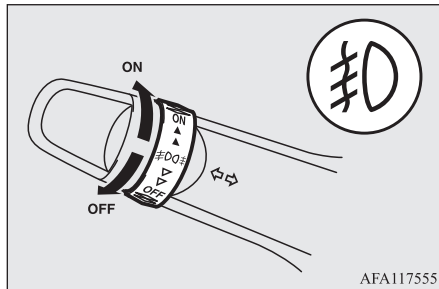

NOTE

- The front fog lamps are automatically turned off when the headlamps or tail lamps are turned off. To turn the front fog lamps on again, turn the knob in the “ON” direction after turning on the headlamps or tail lamps.

NOTE

- Do not use fog lamps except in conditions of fog, otherwise excessive lamp glare may temporarily blind oncoming vehicle drivers.

Rear fog lamp switch

The rear fog lamp can be operated when the headlamps or front fog lamps (if so equipped) turn on.

An indication lamp in the instrument cluster comes on when the rear fog lamp is turned on.

[Vehicle without front fog lamps]

Turn the knob once in the “ON” direction to turn on the rear fog lamp. To turn the rear fog lamp off, turn the knob once in the “OFF” direction. The knob will automatically return to its original position when you release it.

[Vehicle with front fog lamps]

Turn the knob once in the “ON” direction to turn on the front fog lamps. Turn the knob once more in the “ON” direction to turn on the rear fog lamp. To turn the rear fog lamp off, turn the knob once in the “OFF” direction. Turn the knob once more in the “OFF” direction to turn off the front fog lamps. The knob will automatically return to its original position when you release it.

5

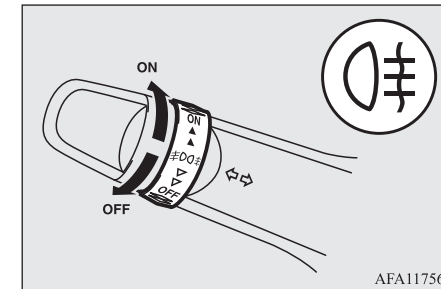

NOTE

- The rear fog lamp is automatically turned off when the headlamps or front fog lamps (if so equipped) are turned off.
- To turn the rear fog lamp on again, turn the knob once in the “ON” direction after turning on the headlamps. (Vehicle without front fog lamps)

Wiper and washer switch

NOTE

- To turn the rear fog lamp on again, turn the knob twice in the “ON” direction after turning on the headlamps. (Vehicle with front fog lamps)

5

Wiper and washer switch

CAUTION

- If the washer is used in cold weather, the washer fluid sprayed against the glass may freeze, which may hinder visibility. Warm the glass with the defroster or rear window demister before using the washer.

Windscreen wipers

NOTE

- To ensure a clear rearward view, the rear window wiper will automatically perform several continuous operations if the gearshift lever or the selector lever is put in the “R” position while the windscreen wipers are operating. Refer to “Rear window wiper and washer” on page 5-71.

The windscreen wipers can be operated with the ignition switch or the operation mode is in ON or ACC.

If the blades are frozen to the windscreen or rear window, do not operate the wipers until the ice has melted and the blades are freed, otherwise the wiper motor may be damaged.

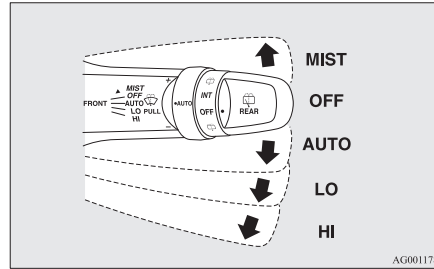

MIST- Misting function
The wipers will operate once.

OFF- Off

AUTO- Auto-wiper control
Rain sensor
The wipers will automatically operate depending on the degree of wetness on the windscreen.

LO- Slow

HI- Fast

Rain sensor

Can only be used when the ignition switch or the operation mode is in ON.

If the lever is put in the “AUTO” position, the rain sensor (A) will detect the extent of rain (or snow, other moisture, dust, etc.) and the wipers will operate automatically.

Keep the lever in the “OFF” position if the windscreen is dirty and the weather is dry.

Wiper operation under these conditions can scratch the windscreen and damage the wipers.

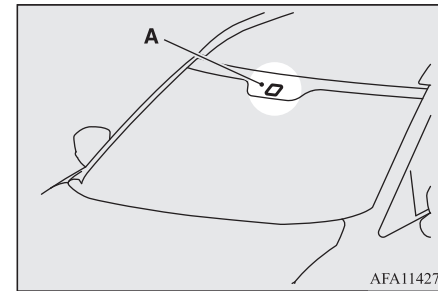

CAUTION

- With the ignition switch or the operation mode in ON and lever in the “AUTO” position, the wipers may automatically operate in the situations described below. If your hands get trapped, you could suffer injuries or the wipers could malfunction. Be sure to turn the ignition switch to the “LOCK” position or put the operation mode in OFF, or move lever to the “OFF” position to deactivate the rain sensor.

CAUTION

- When cleaning the outside surface of the windscreen, if you touch on top of the rain sensor.
- When cleaning the outside surface of the windscreen, if you wipe with a cloth on top of the rain sensor.
- When using an automatic car wash.
- A physical shock is applied to the windscreen or the rain sensor.

NOTE

- To protect the rubber parts of the wipers, this operation of the wipers does not take place even if the lever is put in the “AUTO” position when the vehicle is stationary and the ambient temperature is approximately 0 °C or lower.
- Do not cover the sensor by affixing a sticker or label to the windscreen. Also, do not put any water-repellent coating on the windscreen. The rain sensor would not be able to detect the extent of rain, and the wipers might stop working normally.
- In the following cases, the rain sensor may be malfunctioning.
For further information, we recommend you to consult a MITSUBISHI MOTORS Authorized Service Point.
 - When the wipers operate at a constant interval despite changes in the extent of rain.
 - When the wipers do not operate even though it is raining.

NOTE

- The wipers may automatically operate when things such as insects or foreign objects are affixed to the windscreen on top of the rain sensor or when the windscreen is frozen. Objects affixed to the windscreen will stop the wipers when the wipers cannot remove them. To operate the wipers again, move the lever in the “LO” or “HI” position. Also, the wipers may operate automatically due to strong direct sunlight or electromagnetic wave. To stop the wipers, place the lever in the “OFF” position.
- Contact a MITSUBISHI MOTORS Authorized Service Point when replacing the windscreen or reinforcing the glass around the sensor.

To adjust the sensitivity of the rain sensor

With the lever in the “AUTO” position, it is possible to adjust the sensitivity of the rain sensor by turning the knob (B).

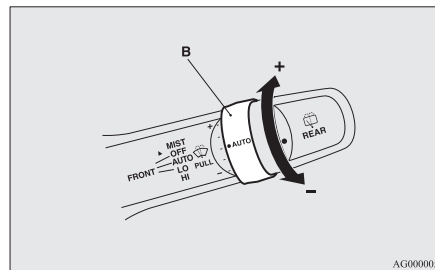

OGKE20E1

- “+”- Higher sensitivity to rain
- “-”- Lower sensitivity to rain

NOTE

- It is possible to activate the following functions.
 - Automatic operation (rain droplet sensitive) can be changed to intermittent operation (vehicle-speed sensitive).
 - Automatic operation (rain droplet sensitive) can be changed to intermittent operation (except vehicle-speed sensitive).
For further information, we recommend you to consult a MITSUBISHI MOTORS Authorized Service Point.
On vehicles equipped with the Smartphone Link Display Audio or the MITSUBISHI Multi-Communication System (MMCS), screen operations can be used to make the adjustment. Refer to the separate owner’s manual for details.

5

Misting function

Move the lever in the direction of the arrow and release, to operate the wipers once. Use this function when you are driving in mist or drizzle.

Wiper and washer switch

The wipers will operate once if the lever is raised to the “MIST” position and released when the ignition switch or the operation mode is in the “ON” or “ACC” position. The wipers will continue to operate while the lever is held in the “MIST” position.

5

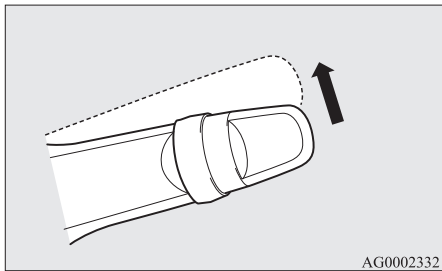

The wipers will operate once if the lever is moved to the “AUTO” position and the knob (C) is turned in the “+” direction when the ignition switch is in the “ON” position or the operation mode is in ON.

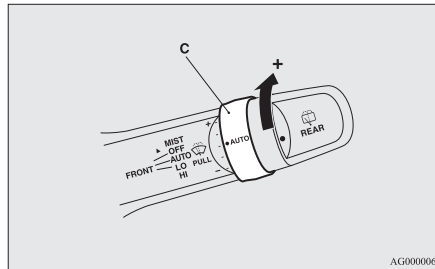

Windscreen washer

The windscreen washer can be operated with the ignition switch or the operation mode is in ON or ACC.

The washer fluid will be sprayed onto the windscreen by pulling the lever towards you. When the wipers are not in operation or in intermittent operation, by pulling the lever towards you, the wipers will operate several times while the washer fluid is being sprayed. Except for vehicles for Russia, Kazakhstan, Belarus, Ukraine and Moldova, then approximately 6 seconds later, the wipers operate once more.

On vehicles equipped with a headlamp washer, while the headlamps are on, the headlamp washer will operate once together with the windscreen washer.

Also, except for vehicles for Russia, Kazakhstan, Belarus, Ukraine and Moldova, by releasing the lever soon after pulling it towards you, the washer fluids will be sprayed several times while the wipers are operating several times. (Comfort washer)

Then approximately 6 seconds later, the wipers operate once more.

Comfort washer will stop operating with any operation of the lever.

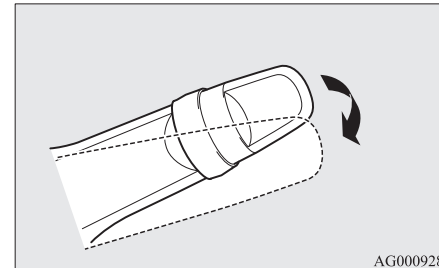

CAUTION

- If the washer is used in cold weather, the washer fluid sprayed against the glass may freeze resulting in poor visibility. Heat the glass with the defroster or demister before using the washer.

NOTE

- It is possible to modify functions as follows:
 - Causing the wiper never to operate when washer fluid is sprayed.
 - Except for vehicles for Russia, Kazakhstan, Belarus, Ukraine and Moldova, deactivating the comfort washer.
 - Except for vehicles for Russia, Kazakhstan, Belarus, Ukraine and Moldova, deactivating the function that operates the wipers once more approximately 6 seconds later.
 - Vehicles for Russia, Kazakhstan, Belarus, Ukraine and Moldova, activating the comfort washer.
 - Vehicles for Russia, Kazakhstan, Belarus, Ukraine and Moldova, the wipers can be set to operate again after approximately 6 seconds.

For further information, we recommend you to consult a MITSUBISHI MOTORS Authorized Service Point.

On vehicles equipped with the Smartphone Link Display Audio or the MITSUBISHI Multi-Communication System (MMCS), screen operations can be used to make the adjustment. Refer to the separate owner's manual for details.

Rear window wiper and washer

The rear window wiper and washer switch can be operated with the ignition switch or the operation mode in ON or ACC.

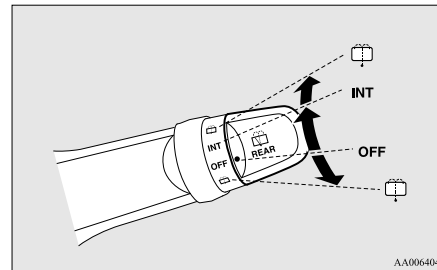

- INT-** The wiper operates continuously for several seconds then operates intermittently at intervals of approximately every 8 seconds
- OFF-** Off
-  The washer fluid will be sprayed onto the rear window when the knob is turned fully in either direction. The wipers operate automatically several times while the washer fluid is being sprayed.

NOTE

- The rear window wiper will automatically perform several continuous operations if the gearshift lever or the selector lever is put in the "R" position while the windscreen wipers or the rear window wiper is operating. (automatic operation mode)

After the automatic operation, the rear window wiper will stop operating if the knob is in the "OFF" position. If the knob is in the "INT" position, the rear window wiper will return to the intermittent operation.

It is possible to set the rear window wiper to perform the automatic operation only if the gearshift lever or the selector lever is put in the "R" position while the rear window wiper is operating with the knob in the "INT" position.

For further information, we recommend you to consult a MITSUBISHI MOTORS Authorized Service Point.

- If the knob is in the "OFF" position, turn the knob to the "INT" position twice quickly to operate the rear window wiper continuously. (continuous operation mode)

Turn the knob to the "OFF" position to stop the rear window wiper continuous operation.

Rear window demister switch

NOTE

- The interval for intermittent operation can be adjusted.
For further information, we recommend you to consult a MITSUBISHI MOTORS Authorized Service Point.
On vehicles equipped with the Smartphone Link Display Audio or the MITSUBISHI Multi-Communication System (MMCS), screen operations can be used to make the adjustment. Refer to the separate owner's manual for details.

5

Headlamp washer switch*

The headlamp washer can be operated with the ignition switch or the operation mode in ON or ACC and the headlamps are on. Push the button once and the washer fluid will be sprayed on to the headlamps.

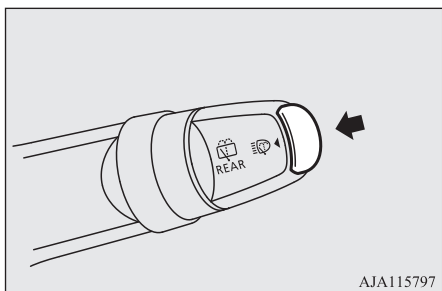

NOTE

- If the ignition switch or the operation mode is in ON or ACC and the headlamps are on, the headlamp washer operates together with the windscreen washer the first time the windscreen washer lever is pulled.

Precautions to observe when using wipers and washers

- If the moving wipers become blocked partway through a sweep by ice or other deposits on the glass, the wipers may temporarily stop operating to prevent the motor from overheating. In this case, park the vehicle in a safe place, turn the ignition switch to the "LOCK" position or put the operation mode in OFF, and then remove the ice or other deposits. The wipers will start operating again after the wiper motor cools down, so check that the wipers operate before using them.
- Do not use the wipers when the glass is dry. They may scratch the glass surface and the blades wear out prematurely.
- Before using the wipers in cold weather, check that the wiper blades are not frozen onto the glass. The motor may burn out if the wipers are used with the blades frozen onto the glass.

- Avoid using the washer continuously for more than 20 seconds. Do not operate the washer when the fluid reservoir is empty. Otherwise, the motor may burn out.
- Periodically check the level of washer fluid in the reservoir and refill if required. During cold weather, add a recommended washer solution that will not freeze in the washer reservoir. Failure to do so could result in loss of washer function and frost damage to the system components.

Rear window demister switch

The rear window demister switch can be operated when the engine is running. Push the switch to turn on the rear window demister. It will be turned off automatically in approximately 15 to 20 minutes depending on the outside temperature. To turn off the demister while it is operating, push the switch again.

The indication lamp (A) will illuminate while the demister is on.

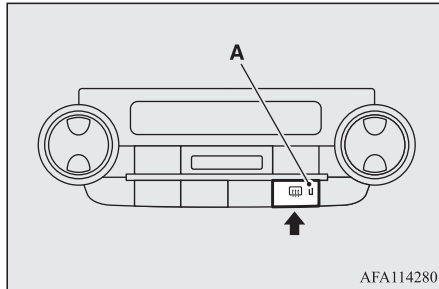

NOTE

- The rear window demister switch is pressed, the outside rear-view mirrors are fogged or defrosted. Refer to “Heated mirror” on page 6-13.

NOTE

- It is possible to change the setting to make the rear window demister operate automatically when ambient temperature becomes low while the engine is running, even if you do not push the rear window demister switch. It operates automatically only once after turning the ignition switch to the “ON” position or putting the operation mode in ON.

If you choose this setting, the heated mirrors (if so equipped) will also operate automatically at the same time.

For further information, we recommend you to consult a MITSUBISHI MOTORS Authorized Service Point.

On vehicles equipped with the Smartphone Link Display Audio or the MITSUBISHI Multi-Communication System (MMCS), screen operations can be used to make the adjustment. Refer to the separate owner’s manual for details.

- The demister switch is not to melt snow but to clear mist. Remove snow before use of the demister switch.
- When cleaning the inside of the rear window, use a soft cloth and wipe gently along the heater wires, being careful not to damage the wires.
- Do not allow objects to touch the inside of the rear window glass, damaged or broken wires may result.

Heated windscreen switch*

Heated windscreen switch*

In cold weather windscreen can be heated by electrical-heat units.

It will speed-up removal of frost and condensate.

The heated windscreen switch can be operated when the engine is running and the outside temperature is approximately 5 °C or less.

Push the switch to turn on the heated windscreen. It will be turned off automatically in approximately 5 to 10 minutes depending on the outside temperature. To turn off the heated windscreen while it is operating, push the switch again.

The indication lamp (A) will illuminate while the heated windscreen is on.

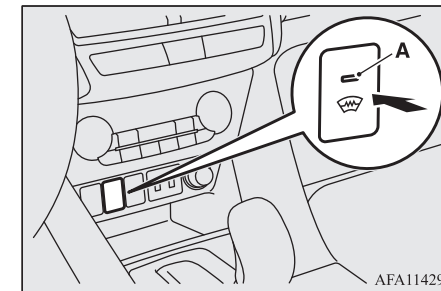

5

Heated steering wheel switch*

CAUTION

- While heated windscreen is operating, the outer surface of the windscreen will be hot. Do not touch the windscreen to prevent burns.

5

NOTE

- Remove snow before use of the heated windscreen. It is not possible to melt large amount of accumulated snow by the heated windscreen.
- To avoid the battery runs out, do not use the heated windscreen continuously.

Heated steering wheel switch*

The heated steering wheel will warm the grip portions of the left and right on the steering wheel by internal heater.

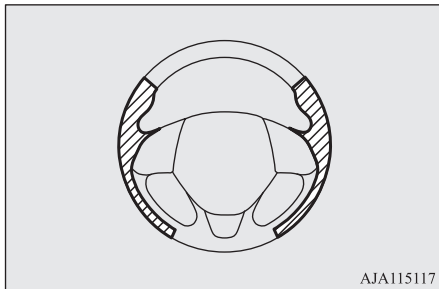

5-74 Instruments and controls



Heating range

The heated steering wheel can be operated when the ignition switch or operation mode is in ON.

Push the switch to turn on the heated steering wheel. It will be turned off automatically in approximately 30 minutes. To turn off the heated steering wheel while operating, push the switch again.

The indication lamp (A) will illuminate while the heated steering wheel is on.

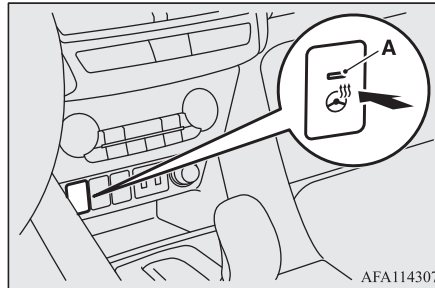

CAUTION

- If the following types of persons use the heated steering wheel, they might become too hot or receive minor burns (red skin, heat blisters, etc.):
 - Elderly people

OGKE20E1

CAUTION

- People with sensitive skin
- If water or any other liquid is spilled on the steering wheel, allow it to dry thoroughly before attempting to use the heated steering wheel. Turn the heated steering wheel off immediately if it appears to be malfunctioning during use.
- Long use of the heated steering wheel without running the engine may run down the battery.

Horn switch

Press the steering wheel on or around the “” mark.

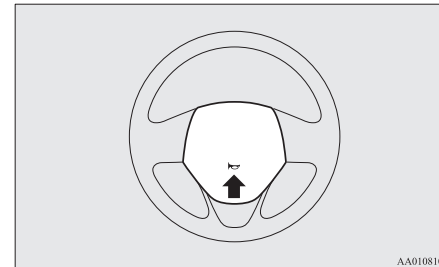

Starting and driving

Economical driving.....	6-02	Active Yaw Control (AYC).....	6-62
Driving, alcohol and drugs.....	6-02	Emergency stop signal system.....	6-63
Safe driving techniques.....	6-03	Anti-lock brake system (ABS).....	6-63
Running-in recommendations.....	6-03	Electric power steering system (EPS).....	6-65
Parking brake.....	6-04	Active stability control (ASC).....	6-66
Parking.....	6-08	Cruise control*.....	6-69
Steering wheel height and reach adjustment.....	6-09	Speed Limiter*.....	6-73
Inside rear-view mirror.....	6-10	Adaptive Cruise Control System (ACC)*.....	6-78
Outside rear-view mirrors.....	6-11	Forward Collision Mitigation system (FCM)*.....	6-91
Ignition switch*.....	6-14	Ultrasonic misacceleration Mitigation System (UMS)*.....	6-102
Engine switch*.....	6-15	Blind Spot Warning (BSW) (with Lane Change Assist)*.....	6-107
Steering wheel lock.....	6-18	Rear Cross Traffic Alert (RCTA)*.....	6-111
Starting and stopping the engine.....	6-19	Lane Departure Warning (LDW)*.....	6-113
Gasoline particulate filter (GPF)*.....	6-26	Traffic Sign Recognition (TSR)*.....	6-117
Diesel particulate filter (DPF)*.....	6-27	Tyre pressure monitoring system (TPMS)*.....	6-119
Urea SCR system (AdBlue™-related system)*.....	6-28	Parking sensors (Front/Rear)*.....	6-124
Turbocharger operation.....	6-30	Rear-view camera*.....	6-128
Auto Stop & Go (AS&G) system*.....	6-30	Multi Around Monitor*.....	6-131
Manual transmission*.....	6-35	Cargo loads.....	6-140
8-speed Automatic transmission with Sports Mode*.....	6-36	Trailer towing*.....	6-141
INVECS-III CVT with 8-step Sports Mode*.....	6-43		
S-AWC (Super All Wheel Control)*.....	6-50		
4-wheel drive operation*.....	6-53		
Inspection and maintenance following rough road operation.....	6-55		
Cautions on handling of 4-wheel drive vehicles*.....	6-55		
Braking.....	6-56		
Brake auto hold*.....	6-57		
Hill start assist.....	6-60		
Brake assist system.....	6-61		

Economical driving

Economical driving

For economical driving, there are some technical requirements that have to be met. The prerequisite for low fuel consumption is a properly adjusted engine. In order to achieve longer life of the vehicle and the most economical operation, we recommend you to have the vehicle checked at regular intervals in accordance with the service standards.

Fuel economy and generation of exhaust gas and noise are highly influenced by personal driving habits as well as the particular operating conditions. The following points should be observed in order to minimize wear of brakes, tyres and engine as well as to reduce environmental pollution.

Accelerating and decelerating

Drive according to the traffic conditions and avoid sudden starts, sudden acceleration and sudden braking, as they will increase fuel consumption.

Shifting

Shift only at an appropriate speed and engine speed. Always use the highest shift position possible.

The drive mode-selector should be set to "AUTO" (Electronically controlled 4WD) when driving 4WD vehicles to obtain best possible fuel economy.

City traffic

Frequent starting and stopping increases the average fuel consumption. Use roads with smooth traffic flow whenever possible. When driving on congested roads, avoid use of a low shift position at high engine speeds.

Idling

The vehicle consumes fuel even during idling. Avoid extended idling whenever possible.

Speed

At higher vehicle speed, more fuel is consumed. Avoid driving at full speed. Even a slight release of the accelerator pedal will save a significant amount of fuel.

Tyre inflation pressure

Check the tyre inflation pressures at regular intervals. Low tyre inflation pressure increases road resistance and fuel consumption. In addition, low tyre pressures adversely affect tyre wear and driving stability.

Cargo loads

Do not drive with unnecessary articles in the luggage compartment. Especially during city driving where frequent starting and stopping is necessary, the increased weight of the vehicle will greatly affect fuel consumption. Also avoid driving with unnecessary luggage or carriers, etc., on the roof; the increased air resistance will increase fuel consumption.

Cold engine starting

Starting of a cold engine consumes more fuel. Unnecessary fuel consumption is also caused by keeping a hot engine running. After the engine is started, commence driving as soon as possible.

Air conditioning

The use of the air conditioning will increase the fuel consumption.

Driving, alcohol and drugs

Driving after drinking alcohol is one of the most frequent causes of accidents.

6

Your driving ability can be seriously impaired even with blood alcohol levels far below the legal minimum. If you have been drinking, don't drive. Ride with a designated non-drinking driver, call a cab or a friend, or use public transportation. Drinking coffee or taking a cold shower will not make you sober. Similarly, prescription and nonprescription drugs affect your alertness, perception and reaction time. Consult with your doctor or pharmacist before driving while under the influence of any of these medications.

⚠ WARNING

- **NEVER DRINK AND DRIVE.**
Your perceptions are less accurate, your reflexes are slower and your judgment is impaired.

Safe driving techniques

Driving safety and protection against injury cannot be fully ensured. However, we recommend that you pay extra attention to the following:

Seat belts

Before starting the vehicle, make sure that you and your passengers have fastened your seat belts.

Floor mats

⚠ WARNING

- **Keep floor mats clear of the pedals by correctly laying floor mats that are suitable for the vehicle.**
To prevent the floor mats from slipping out of position, securely retain them using the hook etc.
Note that laying a floor mat over a pedal or laying one floor mat on top of another can obstruct pedal operation and lead to a serious accident.

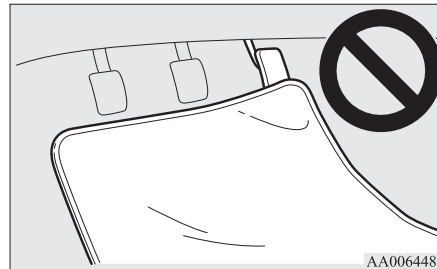

Carrying children in the vehicle

- Never leave your vehicle unattended with the key and children inside the vehicle. Children may play with the driving controls and this could lead to an accident.

- Make sure that infants and small children are properly restrained in accordance with the laws and regulations, and for maximum protection in case of an accident.
- Prevent children from playing in the luggage compartment. It is quite dangerous to allow them to play there while the vehicle is moving.

Loading luggage

When loading luggage, be careful not to load above the height of seats. This is dangerous not only because rearward vision will be obstructed, but also the luggage may be projected into the passenger compartment under hard braking.

Running-in recommendations

During the running-in period for the first 1,000 km, it is advisable to drive your new vehicle using the following precautions as a guideline to aid long life as well as future economy and performance.

- Do not race the engine at high speeds.
- Avoid rapid starting, accelerating, braking and prolonged high-speed running.

Parking brake

- Keep to the running-in speed limit shown below.
Please note that the legal speed limits displayed must be adhered to.
- Do not exceed loading limits.
- Refrain from towing a trailer.

Vehicles with M/T

6

Shift point	Speed limit
1 st gear	30 km/h (19 mph)
2 nd gear	60 km/h (37 mph)
3 rd gear	95 km/h (59 mph)
4 th gear	125 km/h (78 mph)
5 th gear	130 km/h (81 mph)
6 th gear	130 km/h (81 mph)

Vehicles with A/T

Shift point	Speed limit	
“D” (DRIVE)	145 km/h (90 mph)	
with shift paddles	1 st gear	10 km/h (6 mph)
	2 nd gear	30 km/h (19 mph)
	3 rd gear	50 km/h (31 mph)
	4 th gear	65 km/h (40 mph)
	5 th gear	80 km/h (50 mph)

6-04 Starting and driving

Shift point	Speed limit
6 th gear	95 km/h (59 mph)
7 th gear	120 km/h (75 mph)
8 th gear	125 km/h (78 mph)

Vehicles with CVT

Shift point	Speed limit	
“D” (DRIVE)	130 km/h (81 mph)	
with shift paddles	1 st position	20 km/h (12 mph)
	2 nd position	40 km/h (25 mph)
	3 rd position	50 km/h (31 mph)
	4 th position	70 km/h (43 mph)
	5 th position	80 km/h (50 mph)
	6 th position	100 km/h (62 mph)
	7 th position	110 km/h (68 mph)
	8 th position	130 km/h (81 mph)

Parking brake

To park the vehicle, first bring it to a complete stop, firmly apply the parking brake to hold the vehicle.
Make sure the brake warning lamp is illuminated.

OGKE20E1

For details, refer to “Brake warning lamp” on page 5-47.

Lever type parking brake*

To apply

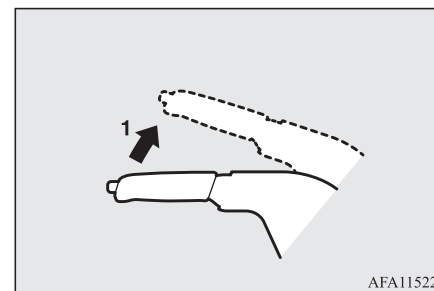

- 1- Firmly depress and hold the brake pedal, then pull the lever up without pressing the button at the end of hand grip.

CAUTION

- When you intend to apply the parking brake, firmly press the brake pedal to bring the vehicle to a complete stop before pulling the parking brake lever.
Pulling the parking brake lever with the vehicle moving could make the rear wheels lock up, thereby making the vehicle unstable.
It could also make the parking brake malfunction.

NOTE

- Apply sufficient force to the parking brake lever to hold the vehicle stationary after the foot brake is released.
- If the parking brake does not hold the vehicle stationary after the foot brake is released, have your vehicle checked immediately.

To release

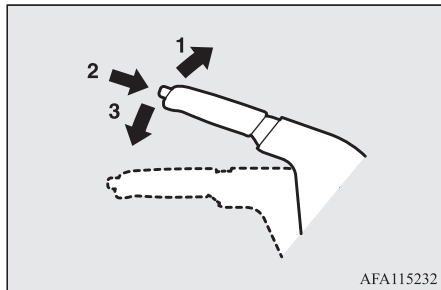

- 1- Firmly depress and hold the brake pedal, then pull the lever up slightly.
- 2- Pressing the button at the end of hand grip.
- 3- Lower the lever fully.

CAUTION

- Before driving, be sure that the parking brake is fully released and brake warning lamp is off.

If you drive without the parking brake fully released, the warning display will appear on the information screen in the multi-information display and a buzzer sounds when the vehicle speed exceeds 8 km/h (5 mph). If a vehicle is driven without releasing the parking brake, the brake will be overheated, resulting in ineffective braking and possible brake failure.

Warning lamp



Warning display



- If the brake warning lamp does not extinguish when the parking brake is fully released, the brake system may be abnormal. Have your vehicle checked immediately. For details, refer to “Brake warning lamp” on page 5-47.

Electric parking brake*

The Electric parking brake is the system that applies the parking brake by the electric motor.

NOTE

- You may hear an operation noise from the vehicle body when operating the Electric parking brake. This does not indicate a malfunction and the Electric parking brake is operating normally.
- When the battery is weak or dead, the Electric parking brake cannot be applied or released. Refer to “Emergency starting” on page 8-08.
- You may feel the brake pedal moving when operating the Electric parking brake. This does not indicate a malfunction.

6

To apply

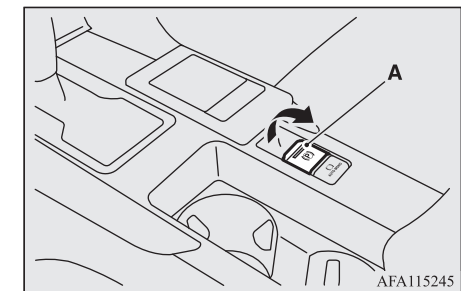

1. Stop the vehicle completely.

Parking brake

2. Pull up the Electric parking brake switch while depressing the brake pedal.

When the parking brake is applied, the brake warning lamp in the instrument cluster and the indication lamp (A) on the Electric parking brake switch will come on.

6

CAUTION

- While the vehicle is in motion, do not apply the Electric parking brake. Doing so may cause overheating and/or premature wear of brake parts, reducing brake performance.

NOTE

- In the following conditions, the brake warning lamp will illuminate for approximately 15 seconds and then go off.
 - While the electric parking brake is applied, the ignition switch is turned to the “LOCK” position or the operation mode is put in OFF.
 - While the ignition switch is in the “LOCK” position or the operation mode is in OFF, the Electric parking brake switch is pulled up.

NOTE

- If the Electric parking brake must be applied in an emergency situation, pull and hold the Electric parking brake switch to apply the Electric parking brake. At that time, the following warning display will appear in the multi-information display and a buzzer will sound, however you should continue to pull and hold the Electric parking brake switch.



RELEASE
PARKING BRAKE

- When parking on steep grades, pull up the Electric parking brake switch twice (once more after the operation is completed once). The maximum effect of the parking brake will be obtained.
- If the parking brake does not hold the vehicle stationary after the foot brake is released, contact a MITSUBISHI MOTORS Authorized Service Point.
- When the ignition switch or the operation mode is other than ON, if the parking brake is applied, the Electric parking brake indication lamp comes on for a while.

NOTE

- If the Electric parking brake switch is repeatedly operated in a short time, the following warning display will appear in the multi-information display and the Electric parking brake will temporarily stop working. In such case, wait for approximately 1 minute until the warning display disappears, and operate the Electric parking brake switch again.



PARKING BRAKE
TEMPORARILY
NOT AVAILABLE

- The brake warning lamp and the indication lamp on the Electric parking brake switch may blink. This does not indicate a malfunction, the lamps go off when/if the Electric parking brake is released.
- Depending on the situation, the Electric parking brake may be applied automatically. Refer to “Brake auto hold” on page 6-57.

To release

Manual operation

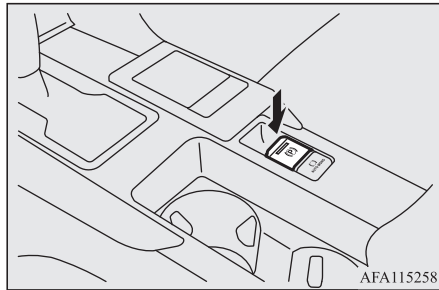

1. Make sure that the ignition switch or the operation mode is ON.
2. Press down the Electric parking brake switch while depressing the brake pedal.

Automatic operation

When the accelerator pedal is depressed slowly while all of the following conditions are met, the Electric parking brake is automatically released.

- The engine is running.
- The selector lever is in the “D” (Drive) or the “R” (Reverse) position.
- The driver’s seat belt is fastened.

When the Electric parking brake is released, the brake warning lamp and the indication lamp on the Electric parking brake switch go off.

Before driving, be sure that the parking brake is released and the brake warning lamp is off.

CAUTION

- After the Electric parking brake switch has been operated to apply or release the Electric parking brake, if the brake warning lamp and the indication lamp on the Electric parking brake switch remain blinking or the Electric parking brake warning lamp remain illuminated, the Electric parking brake system may be malfunctioning and the parking brake may not be applied or released. Immediately park your vehicle in a safe place and contact the nearest MITSUBISHI MOTORS Authorized Service Point.
- If a vehicle is driven without releasing the electric parking brake, the brake will over-heat, resulting in ineffective braking and possible brake failure.
- If the brake warning lamp does not go off after the parking brake has been released, the brake system may be malfunctioning. Contact the nearest MITSUBISHI MOTORS Authorized Service Point.

CAUTION

- If the acceleration of the vehicle seems abnormally slow after the vehicle has been parked with the Electric parking brake applied in cold weather, stop the vehicle in a safe place, then apply and release the Electric parking brake. If the vehicle acceleration is still slow, contact the nearest MITSUBISHI MOTORS Authorized Service Point.

NOTE

- When the ignition switch or the operation mode is other than ON, the parking brake cannot be released.
- If the Electric parking brake does not automatically release, it may be released by manual operation.
- When the selector lever is other than “P” (Park) position, if you try to release the Electric parking brake without depressing the brake pedal, the warning display will appear.



Parking

NOTE

- If you start driving without releasing the Electric parking brake, the warning display will appear.



- If the driver's foot contacts the accelerator pedal in the condition that the Electric parking brake can be released by an automatic operation, the Electric parking brake may be released automatically.

Warning lamp/display

Warning lamp



Warning display



If there is a malfunction in the system, the warning lamp will come on. In addition, the warning display appears on the information screen in the multi-information display.

Under normal conditions, the warning lamp only comes on when the ignition switch is turned to the "ON" position or the operation mode is put in ON and goes off a few seconds later.

CAUTION

- When the Electric parking brake warning lamp does not illuminate or remains illuminated when the ignition switch is turned to the "ON" position or the operation mode is put in ON, or comes on while driving, the Electric parking brake may not be applied or released. Immediately contact the nearest MITSUBISHI MOTORS Authorized Service Point. For details, refer to "Electric parking brake warning lamp" on page 5-48. When parking your vehicle while the Electric parking brake warning lamp is illuminated, park the vehicle on level and stable ground, move the selector lever to the "P" (PARK) position and place chocks, blocks or stones behind and in front of the tyres to prevent the vehicle from moving.

Parking

To park the vehicle, firmly apply the parking brake, and then move the gearshift lever to 1st or "R" (Reverse) position for vehicles equipped with M/T, or set the selector lever to "P" (PARK) position for vehicles equipped with A/T or CVT.

Parking on a hill

To prevent the vehicle from rolling, follow these procedures:

Parking on a downhill slope

Turn the front wheels towards the kerb and move the vehicle forward until the kerb side wheel gently touches the kerb.

On vehicles equipped with M/T, apply the parking brake and place the gearshift lever into the "R" (Reverse) position.

On vehicles equipped with A/T or CVT, apply the parking brake and place the selector lever into the "P" (Park) position.

If necessary, apply chocks to wheels.

Parking on an uphill slope

Turn the front wheels away from the kerb and move the vehicle back until the kerb side wheel gently touches the kerb.

On vehicles equipped with M/T, apply the parking brake and place the gearshift lever into the 1st position.

On vehicles equipped with A/T or CVT, apply the parking brake and place the selector lever into the “P” (Park) position.

If necessary, apply chocks to wheels.

NOTE

- On vehicles equipped with A/T or CVT, be sure to apply the parking brake before moving selector lever to the “P” (PARK) position. If you move selector lever to the “P” (Park) position before applying the parking brake, it may be difficult to disengage selector lever from the “P” (Park) position when next you drive the vehicle, requiring application of a strong force the selector lever to move from the “P” (Park) position.

Parking with the engine running

Never leave the engine running while you take a short sleep/rest. Also, never leave the engine running in a closed or poorly ventilated place.

WARNING

- Leaving the engine running risks injury or death from accidentally moving the gearshift lever (with M/T) or the selector lever (with A/T or CVT) or the accumulation of toxic exhaust fumes on the passenger compartment.

Where you park

WARNING

- Do not park your vehicle in areas where combustible materials such as dry grass or leaves can come in contact with a hot exhaust, since a fire could occur.

Do not keep the steering wheel fully turned for a long time

More effort could be required to turn the steering wheel.
Refer to “Electric power steering system (EPS)” on page 6-65.

When leaving the vehicle

Always carry the key and lock all doors and the tailgate when leaving the vehicle unattended.
Always try to park your vehicle in a well lit area.

Steering wheel height and reach adjustment

1. Release the lever while holding the steering wheel up.
2. Adjust the steering wheel to the desired position.
3. Securely lock the steering wheel by pulling the lever fully upward.

6

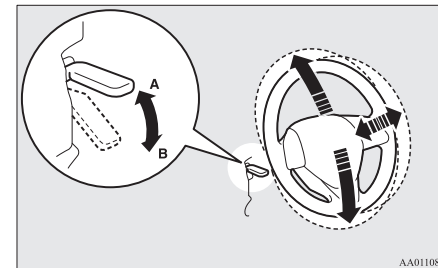

A- Locked
B- Release

WARNING

- Do not attempt to adjust the steering wheel while you are driving the vehicle.

Inside rear-view mirror

Inside rear-view mirror

Adjust the rear-view mirror only after making any seat adjustments so you have a clear view to the rear of the vehicle.

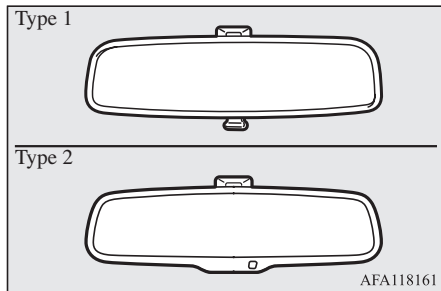

⚠ WARNING

- Do not attempt to adjust the rear-view mirror while driving. This can be dangerous. Always adjust the mirror before driving.

Adjust the rear-view mirror to maximize the view through the rear window.

To adjust the vertical mirror position

Except for vehicles equipped with Forward Collision Mitigation system (FCM)

6-10 Starting and driving

It is possible to move the mirror up and down to adjust its position.

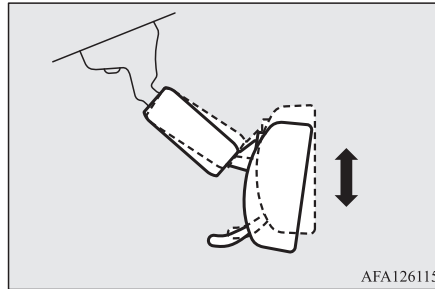

To adjust the mirror position

It is possible to move the mirror up/down and left/right to adjust its position.

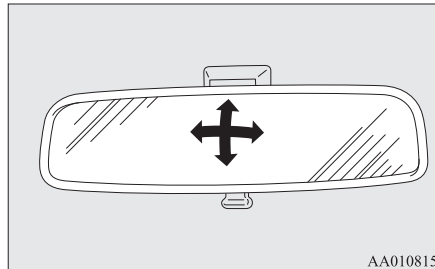

To reduce the glare

Type 1

OGKE20E1

The lever (A) at the bottom of the mirror can be used to adjust the mirror to reduce the glare from the headlamps of vehicles behind you during night driving.

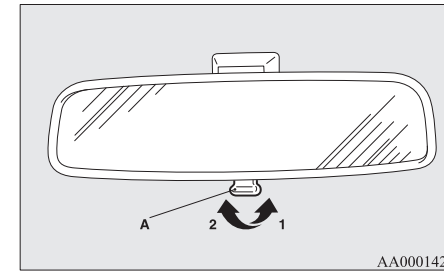

- 1- Normal
- 2- Anti-glare

Type 2

When the headlamps of the vehicles behind you are very bright, the reflection factor of the rear-view mirror is automatically changed to reduce the glare.

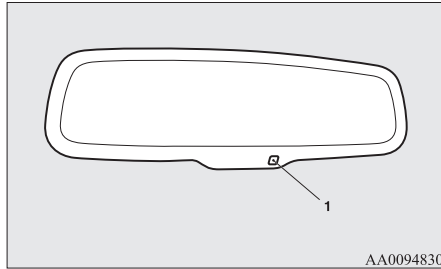

When the ignition switch is turned to the "ON" position or the operation mode is put in ON, the reflection factor of the mirror is automatically changed.

NOTE

- Do not hang items on, or spray glass cleaner on the sensor (1), as reduced sensitivity could result.

Outside rear-view mirrors

To adjust the mirror position

The outside rear-view mirrors can be operated when the ignition switch is in the "ON" or "ACC" position or the operation mode is put in ON or ACC.

WARNING

- Do not attempt to adjust the rear-view mirrors while driving. This can be dangerous. Always adjust the mirrors before driving.
- Your vehicle is equipped with convex type mirrors. Please take into consideration, that objects you see in the mirror will look smaller and farther away compared to a normal flat mirror. Do not use this mirror to estimate distance of following vehicles when changing lanes.

- Push the switch (A) on the same side as the mirror whose adjustment is desired.

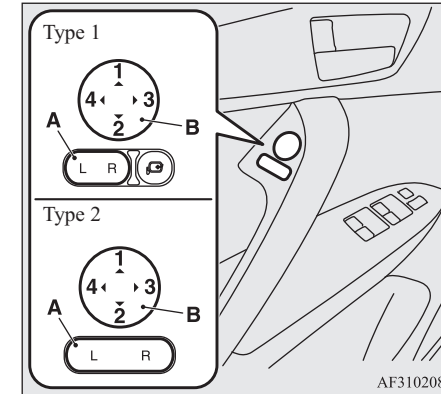

L- Left outside mirror adjustment
R- Right outside mirror adjustment

- Press the switch (B) to the left, right, up or down to adjust the mirror position.
 - 1- Up
 - 2- Down
 - 3- Right
 - 4- Left
- After completing the adjustment, return the switch (A) to the centre position.

Outside rear-view mirrors

Retracting and extending the outside mirrors

The outside mirror can be retracted in towards the side window to prevent damage when parking in narrow areas.

CAUTION

- Do not drive the vehicle with the mirror retracted in. The lack of rearward visibility normally provided by the mirror could lead to an accident.

Except for vehicles equipped with the mirror retractor switch

Push the mirror towards the back of the vehicle with your hand to retract it in. When extending the mirror, pull it out towards the front of the vehicle until it clicks to lock in place.

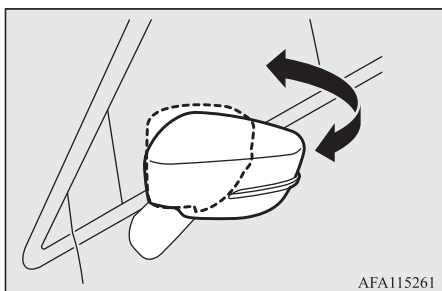

6-12 Starting and driving

For vehicles equipped with the mirror retractor switch

Retracting and extending the mirrors using the mirror retractor switch

With the ignition switch in the “ON” or “ACC” position or the operation mode in ON or ACC, push the mirror retractor switch to retract the mirrors. Push it again to extend the mirrors to their original positions.

After placing the ignition switch in the “LOCK” position or the operation mode in OFF, it is possible to retract and extend the mirrors using the mirror retractor switch for approximately 30 seconds.

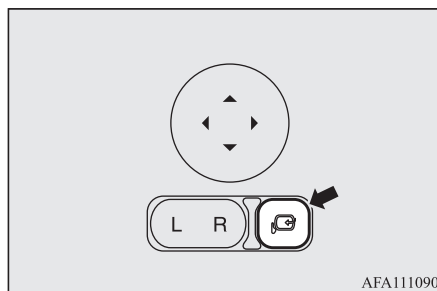

OGKE20E1

CAUTION

- It is possible to retract and extend the mirrors by hand. After retracting a mirror using the mirror retractor switch, however, you should extend it by using the switch again, not by hand. If you extended the mirror by hand after retracting it using the switch, it would not properly lock in position. As a result, the mirror could move because of the wind or vibration while you are driving, and this may limit the driver’s rearward visibility.

NOTE

- Be careful not to get your hands trapped while a mirror is moving.
- If you move a mirror by hand or it moves after hitting a person or object, you may not be able to return it to its original position using the mirror retractor switch. If this happens, push the mirror retractor switch to place the mirror in its retracted position and then push the switch again to return the mirror to its original position.
- When freezing has occurred and mirrors fail to operate as intended, please refrain from repeated pushing of the retractor switch.

Retracting and extending the mirrors without using the mirror retractor switch

[Except for vehicles equipped with keyless operation system]

The mirrors automatically retract or extend when the doors and tailgate are locked or unlocked using the key switches of the keyless entry system.

Refer to “Keyless entry system: Operation of the outside rear-view mirrors” on page 3-05.

[For vehicles equipped with keyless operation system]

The mirrors automatically retract or extend when the doors and tailgate are locked or unlocked using the key switches or the keyless operation function of the keyless operation system.

Refer to “Keyless entry system: Operation of the outside rear-view mirrors” on page 3-05 or “Keyless operation system: To operate using the keyless operation function” on page 3-11.

NOTE

- Functions can be modified as stated below. Please consult a MITSUBISHI MOTORS Authorized Service Point.
On vehicles equipped with the Smartphone Link Display Audio and MITSUBISHI Multi-Communication System (MMCS), screen operations can be used to make the adjustment. Refer to the separate owner’s manual for details.

NOTE

- Automatically extend when the ignition switch is turned to the “ON” position or the operation mode is put in ON, and automatically retract when the driver’s door is opened after the ignition switch is turned to the “LOCK” or “ACC” position or the operation mode is put in OFF or ACC.
- Automatically extend when the vehicle speed reaches approximately 30 km/h (20 mph).
- Deactivate the automatic extension function.

Heated mirror

To demist or defrost the outside rear-view mirrors, press the rear window demister switch.

The indication lamp (A) will illuminate while the demister is on.

The heater will be turned off automatically in approximately 15 to 20 minutes depending on the outside temperature.

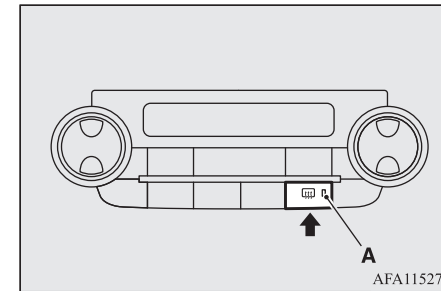

6

NOTE

- The heater mirrors can be turned on automatically.
For further information, we recommend you to consult a MITSUBISHI MOTORS Authorized Service Point.
On vehicles equipped with the Smartphone Link Display Audio and MITSUBISHI Multi-Communication System (MMCS), screen operations can be used to make the adjustment. Refer to the separate owner’s manual for details.

Ignition switch*

Ignition switch*

6

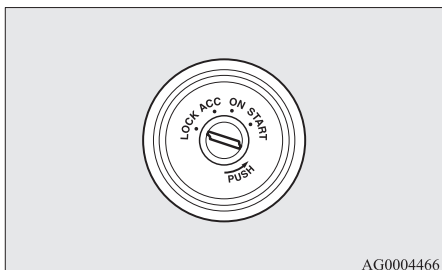

LOCK

The engine is stopped and the steering wheel locked. The key can only be inserted and removed in this position.

ACC

The engine is stopped, but the audio system and other electric devices can be operated.

ON

All the vehicle's electrical devices can be operated.

START

The starter motor operates. After the engine has started, release the key and it will automatically return to the "ON" position.

NOTE

- Your vehicle is equipped with an electronic immobilizer. To start the engine, the ID code transmitted by the transponder inside the key must match the code registered in the immobilizer computer. Refer to "Electronic immobilizer (Anti-theft starting system)" on page 3-03.

ACC power auto-cutout function

After approximately 30 minutes has elapsed with the ignition switch in the "ACC" position, the function automatically cuts out the power for the audio system and other electric devices that can be operated with that position.

When the ignition switch is turned from the "ACC" position, the power is supplied again to those devices.

NOTE

- It is possible to modify functions as follows:

NOTE

- The time until the power cuts out can be changed to approximately 60 minutes.
- The ACC power auto-cutout function can be deactivated.

For details, we recommend you to consult a MITSUBISHI MOTORS Authorized Service Point.

On vehicles equipped with the Smartphone Link Display Audio and MITSUBISHI Multi-Communication System (MMCS), screen operations can be used to make the adjustment.

Refer to the separate owner's manual for details.

- When the ACC power is automatically cut out, you cannot lock the steering wheel and you cannot lock and unlock the doors using the key switches of the keyless entry system.

To remove the key

On vehicles equipped with a M/T, when removing the key, push the key in at the "ACC" position and keep it depressed until it is turned to the "LOCK" position and remove it.

On vehicles equipped with A/T or CVT, when removing the key, first set the selector lever to the “P” (PARK) position, and push the key in at the “ACC” position and keep it depressed until it is turned to the “LOCK” position, and remove it.

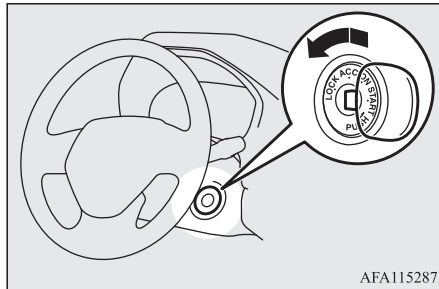

CAUTION

- Do not remove the ignition key from the ignition switch while driving. The steering wheel will be locked, causing loss of control.
- If the engine is stopped while driving, the brake servomechanism will cease to function and braking efficiency will deteriorate. Also, the power steering system will not function and it will require greater manual effort to operate the steering.

CAUTION

- Do not leave the key in the “ON” position for a long time when the engine is not running, doing so will cause the battery to be discharged.
- Do not turn the key to the “START” position while the engine is running. Doing so could damage the starter motor.

Engine switch*

In order to prevent theft, the engine will not start unless a preregistered keyless operation key is used. (Engine immobilizer function)
If you are carrying the keyless operation key, you can start the engine.

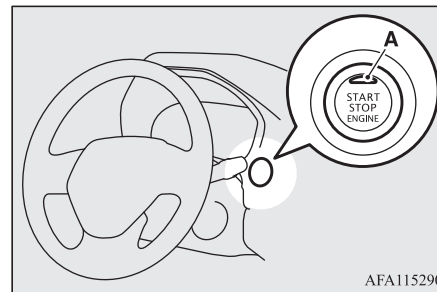

CAUTION

- The indication lamp (A) will flash orange when there is a problem or malfunction in the keyless operation system. Never drive if the indication lamp on the engine switch is flashing orange. Immediately contact a MITSUBISHI MOTORS Authorized Service Point.
- If the engine switch operation is not smooth and feels like it is sticking, do not operate the switch. Immediately contact a MITSUBISHI MOTORS Authorized Service Point.

NOTE

- When operating the engine switch, press the switch all the way in. If the switch is not fully pressed, the engine may not start or the operation mode may not change. If the engine switch is pressed correctly, there is no need to hold the engine switch down.

Engine switch*

NOTE

- When the battery in the keyless operation key has worn out, or the keyless operation key is out of the vehicle, a warning display will appear.
Warning display (when the engine switch is pressed one time)

6



Warning display (when the engine switch is pressed two times or more)



Operation mode of the engine switch and its function

OFF

The indication lamp on the engine switch turns off.

The operation mode cannot be put in OFF when the selector lever is in any position other than the “P” (PARK) position (A/T or CVT).

6-16 Starting and driving

ACC

Electrical devices such as the audio and accessory socket can be operated.

The indication lamp on the engine switch illuminates orange.

ON

All vehicle's electrical devices can be operated.

The indication lamp on the engine switch illuminates green. The indication lamp goes off when the engine is running.

NOTE

- Your vehicle is equipped with an electronic immobilizer.
To start the engine, the ID code transmitted by the transponder inside the key must match the code registered in the immobilizer computer. Refer to “Electronic immobilizer (Anti-theft starting system)” on page 3-03.

Changing the operation mode

If you press the engine switch without depressing the brake pedal (A/T or CVT) or the clutch pedal (M/T), you can change the operation mode in the order of OFF, ACC, ON, OFF.

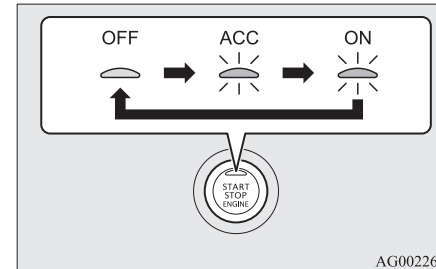

CAUTION

- When the engine is not running, put the operation mode in OFF. Leaving the operation mode in ON or ACC for a long time when the engine is not running may cause the battery to be discharged, making it impossible to start the engine, lock and unlock the steering wheel.

⚠ CAUTION

- When the battery is disconnected, the current operation mode is memorized. After reconnecting the battery, the memorized mode is selected automatically. Before disconnecting the battery for repair or replacement, make sure to put the operation mode in OFF. Be careful if you are not sure which operation mode the vehicle is in when the battery is run down.
- The operation mode cannot be changed from OFF to ACC or ON if the keyless operation key is not detected to be in the vehicle. Refer to “Keyless operation system: Operating range for starting the engine” on page 3-11.
- When there is the keyless operation key in the vehicle and the operation mode is not changed, the battery in the keyless operation key may have worn out. Refer to “Warning activation” on page 3-14.

📖 NOTE

- If the operation mode cannot be changed to OFF, perform the following procedure.
 - 1 Move the selector lever to the “P” (PARK) position, and then change the operation mode to OFF. (For vehicles with A/T or CVT)

📖 NOTE

2 One of the other causes could be low battery voltage. If this occurs, the keyless entry system, keyless operation function and steering lock will also not operate. Contact a MITSUBISHI MOTORS Authorized Service Point.

ACC power auto-cutout function

After approximately 30 minutes have elapsed with the operation mode in ACC, the function automatically cuts out the power for the audio system and other electric devices that can be operated with that position. When the engine switch operate again, the power is supplied again.

📖 NOTE

- It is possible to modify functions as follows:
 - The time until the power cuts out can be changed to approximately 60 minutes.
 - The ACC power auto-cutout function can be deactivated.

For details, we recommend you to consult a MITSUBISHI MOTORS Authorized Service Point.

On vehicles equipped with the Smartphone Link Display Audio and MITSUBISHI Mul-

📖 NOTE

ti-Communication System (MMCS), screen operations can be used to make the adjustment. Refer to the separate owner’s manual for details.

- When the ACC power is automatically cut out, you cannot lock the steering wheel and you cannot lock and unlock the doors using the keyless entry system or keyless operation function.

Operation mode OFF reminder system



When the operation mode is in any mode other than OFF, if you try to lock the doors and tailgate by pressing the driver’s or front passenger’s door lock/unlock switch, or the tailgate LOCK switch, a warning display will appear, and the outer buzzer will sound and you cannot lock the doors and tailgate.

Steering wheel lock

Operation mode ON reminder system



- 6** If the driver's door is opened with the engine stopped and the operation mode in any mode other than OFF, the inner buzzer sounds intermittently to remind you to put the operation mode in OFF.

Steering wheel lock

Except for vehicles equipped with the keyless operation system

To lock

Remove the key at the "LOCK" position. Turn the steering wheel until it is locked.

To unlock

Turn the key to the "ACC" position while moving the steering wheel slightly right and left.

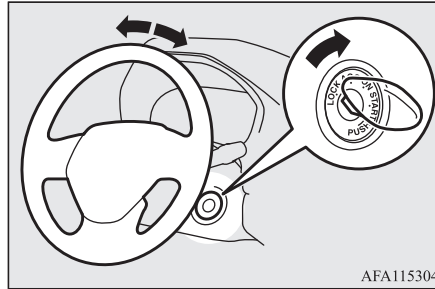

CAUTION

- Remove the key when leaving the vehicle. In some countries, it is prohibited to leave the key in the vehicle when parked.

On vehicles equipped with the keyless operation system

To lock

After pressing the engine switch and operation mode in OFF, when driver's door is opened, the steering wheel is locked.

NOTE

- When the following operation is performed with the operation mode in OFF and the selector lever in the "P" (PARK) position, the steering wheel is locked.
 - Open or close one of the doors (except the tailgate).
 - Lock all the doors and the tailgate with the keyless entry system or the keyless operation system function.
- When the driver's door is opened while the steering wheel is unlocked, a warning display will appear and the buzzer sounds to alert that the steering wheel is unlocked.



CAUTION

- If the engine is stopped while driving, do not open a door or press the LOCK switch on the key until the vehicle stops in a safe place. This could cause the steering wheel to lock, making it impossible to operate the vehicle.

To unlock

The following methods can be used to unlock the steering wheel.

- Put the operation mode in ACC.
- Start the engine.

CAUTION

- Carry the key with you when leaving the vehicle.
- If your vehicle needs to be towed, unlock the steering wheel.
Refer to “Emergency towing” on page 8-28.

NOTE

- When the steering wheel does not unlock, the warning display will appear and the inner buzzer will sound. Press the engine switch again while moving the steering wheel slightly right and left.



NOTE

- If there is a fault in the steering wheel lock and the steering wheel cannot be locked, the warning display will appear and the buzzer will sound. Change the operation mode from ON to OFF and try to lock the steering wheel again. If the warning display appears again, have your vehicle checked at a MITSUBISHI MOTORS Authorized Service Point.



- If there is a fault in the steering wheel lock, the warning display will appear and the inner buzzer will sound. Immediately stop the vehicle in a safe place and contact a MITSUBISHI MOTORS Authorized Service Point.



Starting and stopping the engine

Tips for starting

Except for vehicles equipped with the keyless operation system

- Do not operate the starter motor continuously longer than 10 seconds; doing so could run down the battery. If the engine does not start, turn the ignition switch back to “LOCK”, wait a few seconds, and then try again. Trying repeatedly with the starter motor still turning will damage the starter mechanism.

6

WARNING

- Never run the engine in a closed or poorly ventilated area any longer than is needed to move your vehicle in or out of the area. Carbon monoxide gases are odourless and can be fatal.

CAUTION

- Never attempt to start the engine by pushing or pulling the vehicle.
- Do not run the engine at high revolutions or drive the vehicle at high speed until the engine has had a chance to warm up.

Starting and stopping the engine

CAUTION

- Release the ignition key as soon as the engine starts to avoid damaging the starter motor.

For vehicles equipped with the keyless operation system

6

- The operation mode can be in any mode to start the engine.
- The starter motor will be turning for up to approximately 15 seconds if the engine switch is released at once. Pressing the engine switch again while the starter motor is still turning will stop the starter motor. The starter motor will be turning for up to approximately 30 seconds while the engine switch is pressed. If the engine does not start, wait for a while and then attempt to start the engine again. Trying repeatedly with the starter motor still turning will damage the starter mechanism.
- If you try to restart the engine after several attempts to start the engine or immediately after pressing the engine switch to change the operation mode to OFF, the engine may not start. In this case, wait a few seconds, and then try again.
- Do not operate the selector lever while the starter motor is operating.

WARNING

- **Never run the engine in a closed or poorly ventilated area any longer than is needed to move your vehicle in or out of the area. Carbon monoxide gases are odourless and can be fatal.**

CAUTION

- Never attempt to start the engine by pushing or pulling the vehicle.
- Do not run the engine at high revolutions or drive the vehicle at high speed until the engine has had a chance to warm up.

Starting the engine (petrol-powered vehicles)

Except for vehicles equipped with the keyless operation system

1. Insert the ignition key and fasten the seat belt.
2. Make sure the parking brake is applied.
3. Depress and hold the brake pedal.
4. Fully depress the clutch pedal (M/T).

NOTE

- On vehicles equipped with M/T, the starter will not operate unless the clutch pedal is fully depressed (Clutch interlock).

5. On vehicles equipped with M/T, place the gearshift lever in the “N” (Neutral) position. On vehicles equipped with CVT, make sure the selector lever is in the “P” (PARK) position.

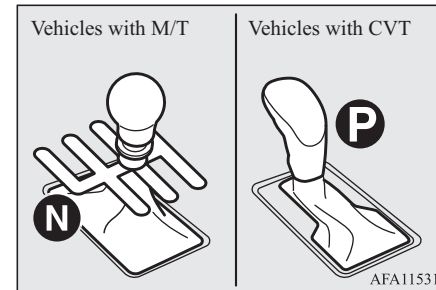

NOTE

- On vehicles with CVT, the starter will not operate unless the selector lever is in the “P” (PARK) or “N” (NEUTRAL) position. For safety reasons, start the engine in the “P” (Park) position so that the wheels are locked.

6. After turning the ignition switch to the “ON” position, make certain that all warning lamps are functioning properly before starting the engine.

- Turn the ignition switch to the “START” position without depressing the accelerator pedal, and release it when the engine starts.

NOTE

- Minor noises may be heard on engine start-up. These will disappear as the engine warms up.
- If you replace the battery, it needs more time to start the engine shortly after the battery replacement.

When it is difficult to start the engine

After several attempts, you may experience that the engine still does not start.

- Make sure that all electric devices, such as lamps, air conditioning blower and rear window demister, are turned off.
- While depressing the brake pedal on vehicles equipped with CVT or the clutch pedal on vehicles equipped with M/T, press the accelerator pedal halfway and hold it there, then crank the engine. Release the accelerator pedal, immediately after the engine starts.

- If the engine still will not start, the engine could be flooded with too much petrol. While depressing the brake pedal on vehicles equipped with CVT or the clutch pedal on vehicles equipped with M/T, push the accelerator pedal all the way down and hold it there, then crank the engine for 5 to 6 seconds. Return the ignition switch to the “LOCK” position and release the accelerator pedal. Wait a few seconds, and then crank the engine again for 5 to 6 seconds while depressing the brake pedal or the clutch pedal, but do not push the accelerator pedal. Release the ignition switch if the engine starts. If the engine fails to start, repeat these procedures. If the engine still will not start, we recommend you to have the vehicle checked.

For vehicles equipped with the keyless operation system

- Fasten the seat belt.
- Make sure the parking brake is applied.
- Press and hold the brake pedal down firmly with your right foot.

NOTE

- After the engine has not started for a while, the brake pedal effort needed to start the engine may become greater. If this occurs, depress the brake pedal more firmly than usual.

- Fully depress and hold the clutch pedal (M/T).

NOTE

- On vehicles equipped with M/T, the starter will not operate unless the clutch pedal is fully depressed (Clutch interlock).

- On vehicles equipped with M/T, place the gearshift lever in the “N” (Neutral) position.

6

Starting and stopping the engine

On vehicles equipped with CVT, make sure the selector lever is in the “P” (PARK) position.

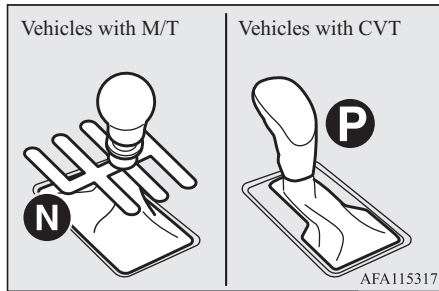

6

6. Press the engine switch.
7. Make sure that all warning lamps are functioning properly.

NOTE

- Minor noises may be heard on engine start-up. These will disappear as the engine warms up.
- When starting the engine, you pressed the engine switch without depressing the clutch pedal, warning display will appear (M/T).



NOTE

- When starting the engine, the selector lever is in a position other than the “P” (PARK) or the “N” (NEUTRAL) position, or you pressed the engine switch without depressing the brake pedal, warning display will appear (CVT).

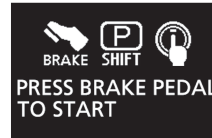

- If you replace the battery, it needs more time to start the engine shortly after the battery replacement.

When it is difficult to start the engine

After several attempts, you may experience that the engine still does not start.

1. Make sure that all electric devices, such as lamps, air conditioning blower and rear window demister, are turned off.
2. While depressing the brake pedal on vehicles equipped with CVT or the clutch pedal on vehicles equipped with M/T, press the accelerator pedal halfway and hold it there, then crank the engine. Release the accelerator pedal, immediately after the engine starts.

3. If the engine still will not start, the engine could be flooded with too much petrol. While depressing the brake pedal on vehicles equipped with CVT or the clutch pedal on vehicles equipped with M/T, push the accelerator pedal all the way down and hold it there, then press the engine switch to crank the engine. If the engine does not start after 5 to 6 seconds, press the engine switch to stop the engine, and release the accelerator pedal. Put the operation mode in OFF. Wait a few seconds, and then press the engine switch to crank the engine again while depressing the brake pedal or the clutch pedal, but do not push the accelerator pedal. If the engine fails to start, repeat these procedures. If the engine still will not start, we recommend you to have the vehicle checked.

Starting the engine (diesel-powered vehicles)

Except for vehicles equipped with the keyless operation system

1. Insert the ignition key and fasten the seat belt.
2. Make sure the parking brake is applied.
3. Depress and hold the brake pedal.

Starting and stopping the engine

4. Make sure the selector lever is in the “P” (PARK) position.



5. Turn the ignition key to the “ON” position.
The diesel preheat indication lamp will first illuminate, and then after a short time go out, indicating that preheating is completed.

NOTE

- If the engine is cold, the diesel preheat indication lamp is on for a longer time.
- When the engine has not been started within approximately 5 seconds after the diesel preheat indication lamp went out, return the ignition switch to the “LOCK” position. Then, turn the switch to the “ON” position to preheat the engine again.

NOTE

- When the engine is warm, the diesel preheat indication lamp does not come on even if the ignition switch is placed in the “ON” position.
Start the engine by turning the ignition switch to the “START” position.

6. Turn the ignition switch to the “START” position without depressing the accelerator pedal, and release it when the engine starts.

NOTE

- Minor noises may be heard on engine start-up. These will disappear as the engine warms up.

For vehicles equipped with the keyless operation system

1. Fasten the seat belt.
2. Make sure the parking brake is applied.
3. Press and hold the brake pedal down firmly with your right foot.

NOTE

- After the engine has not started for a while, the brake pedal effort needed to start the engine may become greater.
If this occurs, depress the brake pedal more firmly than usual.

4. Make sure the selector lever is in the “P” (PARK) position.



5. Press the engine switch.
The diesel preheat indication lamp will first illuminate, and then after a short time go out, indicating that preheating is completed. The engine will start.

NOTE

- If the engine is cold, the diesel preheat indication lamp is on for a longer time.
- Putting the operation mode in ON will also start preheating the engine. When the engine has not been started within approximately 5 seconds after the diesel preheat indication lamp went out, put the operation mode in OFF. Then, attempt the engine start procedure to preheat the engine again.

6

Starting and stopping the engine

NOTE

- Minor noises may be heard on engine start-up. These will disappear as the engine warms up.
- When starting the engine, if the selector lever is in a position other than the “P” (PARK) or the “N” (NEUTRAL) position, or if you pressed the engine switch without depressing the brake pedal, the following warning display will appear.



6

Stopping the engine

CAUTION

- As your vehicle is equipped with a turbocharger, do not stop the engine immediately after high-speed or uphill driving. First allow the engine to idle to give the turbocharger a chance to cool down.

Except for vehicles equipped with the keyless operation system

1. Bring the vehicle to a complete stop.
2. Firmly apply the parking brake while depressing the brake pedal.

3. On vehicles equipped with M/T, turn the ignition switch to the “LOCK” position to stop the engine, and then move the gearshift lever to the 1st (on a uphill) or “R” (Reverse) (on a downhill) position. On vehicles equipped with A/T or CVT, place the selector lever in the “P” (PARK) position, and stop the engine.

On vehicles equipped with the keyless operation system

WARNING

- Do not operate the engine switch while driving except in an emergency. If the engine is stopped while driving, the brake servomechanism will cease to function and braking efficiency will deteriorate. Also, the power steering system will not function and it will require greater manual effort to operate the steering. This could result in a serious accident.

NOTE

- If you have to bring the engine to an emergency stop while driving, press and hold the engine switch for 3 seconds or more, or press it quickly three times or more. The engine will stop and the operation mode will go to ACC.

NOTE

- Do not stop the engine with the selector lever in any position other than the “P” (Park) position (A/T or CVT). If the engine is stopped with the selector lever in any position other than the “P” (Park) position, the operation mode will go to ACC rather than OFF. Put the operation mode in OFF after placing the selector lever in the “P” (Park) position.

1. Stop the vehicle.
2. Firmly apply the parking brake while depressing the brake pedal.
3. On vehicles equipped with M/T, press the engine switch to stop the engine, move the gearshift lever to the 1st (on a uphill) or “R” (Reverse) (on a downhill) position. On vehicles equipped with A/T or CVT, move the selector lever to the “P” (PARK) position, press the engine switch to stop the engine.

NOTE

- For diesel-powered vehicles, if the temperature inside the engine compartment is high, the cooling fans (A) will continue to operate for some time even if the engine is stopped. Therefore, the operation sound of the cooling fans may be heard even after the engine is stopped. This sound is normal and does not indicate a malfunction. After operating for a period of time, the cooling fans will stop automatically.

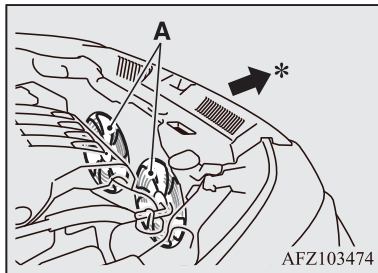

*: Front of the vehicle

Fuel injection amount learning process (diesel-powered vehicles)

To keep exhaust emissions and engine noise low, the engine very occasionally performs a learning process for the fuel injection amount.

The engine sounds slightly different from usual while the learning process is taking place. The change in the engine sound does not indicate a fault.

If the keyless operation key is not operating properly

The following operation can be used to start the engine or change the operation mode.

1. Depress the brake pedal firmly with your right foot (A/T or CVT) or the clutch pedal (M/T).
2. While depressing the brake pedal (A/T or CVT) or the clutch pedal (M/T), touch the portion of the keyless operation key shown in the illustration to the engine switch.

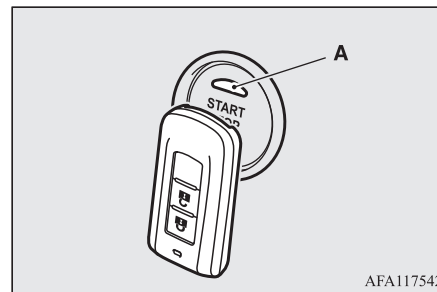

3. If the keyless operation key is recognized, the indication lamp (A) on the engine switch illuminates in green, and then the engine can be started and the operation mode can be changed within approximately 10 seconds. Refer to "Starting the engine" on pages 6-20, 6-24 and "Changing the operation mode" on page 6-16.

NOTE

- If metal objects or other keys are near the keyless operation key, the keyless operation key may not be recognized.
- Instead of depressing the brake pedal, the keyless operation key can also be recognized in the same way within approximately 30 seconds after pushing the engine switch.
- To change the operation mode without starting the engine, release the brake pedal (A/T or CVT) or the clutch pedal (M/T) after the indication lamp on the engine switch illuminates in green, and then press the engine switch.

Gasoline particulate filter (GPF)*

Gasoline particulate filter (GPF)*

The gasoline particulate filter (GPF) is a device that captures most of the particulate matter (PM) in the exhaust emissions of the petrol engine. The GPF automatically burns away trapped PM during vehicle operation. Under certain driving conditions, however, the GPF is not able to burn away all of the trapped PM and, as a result, an excessive amount of PM accumulates inside it.

6

WARNING

- The GPF reaches very high temperatures. Do not park your vehicle in areas where combustible materials such as dry grass or leaves can come in contact with a hot exhaust system since a fire could occur.

CAUTION

- Do not use any type of fuel or engine oil that is not specified for your vehicle. Also, do not use any moisture-removing agent or other fuel additive. Such substances could have a detrimental effect on the GPF. Refer to “Fuel selection” on page 2-02 and “Engine oil” on page 10-04.

NOTE

- To minimize the likelihood of excessive accumulation of PM, try to avoid driving for long periods at low speeds and repeatedly driving short distances.
- The engine sounds slightly different than usual while the GPF automatically burns away trapped PM. The change in the engine sound does not indicate a fault.

GPF warning display



The GPF warning display will appear in the event of an abnormality in the GPF system.

NOTE

- The “PF SYSTEM” warning display indicates the GPF system.

If the GPF warning display appears during vehicle operation

The accumulated PM in the GPF must be burned away.

To burn away the PM, try to drive the vehicle as follows.

With the bar graph of the engine coolant temperature display stabilized in roughly the middle of the scale, drive for 20 to 30 minutes at a speed of at least 60 km/h (37 mph) while accelerating and decelerating intermittently. When the accelerator pedal is released to decelerate, the accumulated PM in the GPF is burned away.

If the warning display stays on even after driving according to the preceding conditions, drive for approximately 30 minutes at a speed of at least 100 km/h (62 mph) while accelerating and decelerating intermittently or contact your MITSUBISHI MOTORS Authorized Service Point.

CAUTION

- You do not have to continuously drive exactly as indicated above. Always strive to drive safely in accordance with road conditions.

NOTE

- The vehicle speed and driving time necessary to burn away the PM may vary according to the payload weight, inclination of the road, and other driving conditions.

If the GPF warning display appears and the check engine warning lamp illuminates at the same time during vehicle operation

Warning display

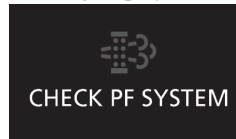

Warning lamp



If an abnormal condition occurs in the GPF system, the GPF warning display appears and the check engine warning lamp illuminates. Have the system inspected by a MITSUBISHI MOTORS Authorized Service Point.

CAUTION

- Continuing to drive with the GPF warning display appearing and the check engine warning lamp illuminating could result in engine trouble and GPF damage.

Diesel particulate filter (DPF)*

The diesel particulate filter (DPF) is a device that captures most of the particulate matter (PM) in the exhaust emissions of the diesel engine. The DPF automatically burns away trapped PM during vehicle operation. Under certain driving conditions, however, the DPF is not able to burn away all of the trapped PM and, as a result, an excessive amount of PM accumulates inside it.

WARNING

- The DPF reaches very high temperatures. Do not park your vehicle in areas where combustible materials such as dry grass or leaves can come in contact with a hot exhaust system since a fire could occur.

CAUTION

- Do not use any type of fuel or engine oil that is not specified for your vehicle. Also, do not use any moisture-removing agent or other fuel additive. Such substances could have a detrimental effect on the DPF. Refer to “Fuel selection” on page 2-02 and “Engine oil” on page 10-04.

NOTE

- To minimize the likelihood of excessive accumulation of PM, try to avoid driving for long periods at low speeds and repeatedly driving short distances, and try to keep high engine speed driving as much as possible.
- The engine sounds slightly different than usual while the DPF automatically burns away trapped PM. The change in the engine sound does not indicate a fault.

6

DPF warning display



The DPF warning display will appear in the event of an abnormality in the DPF system.

NOTE

- The “PF SYSTEM” warning display indicates the DPF system.

Urea SCR system (AdBlue™-related system)*

If the DPF warning display appears during vehicle operation

Continued appearance of the DPF warning display shows that the DPF has not been able to burn away all of the trapped PM and that, as a result, an excessive amount of PM has accumulated inside it. To enable the DPF to burn away the PM, try to drive the vehicle as follows.

6

With the bar graph of engine coolant temperature display stabilized in roughly the middle of the scale, drive for approximately 30 minutes at a speed of at least 40 km/h.

If the DPF warning display subsequently stays on, contact a MITSUBISHI MOTORS Authorized Service Point.

! CAUTION

- You do not have to continuously drive exactly as indicated above. Always strive to drive safely in accordance with road conditions.

If the DPF warning display appears and the check engine warning lamp illuminates at the same time during vehicle operation

Warning lamp



Warning display



If an abnormal condition occurs in the DPF system, the DPF warning display appears and the check engine warning lamp illuminates. Have the system inspected by a MITSUBISHI MOTORS Authorized Service Point.

! CAUTION

- Continuing to drive with the DPF warning display appearing and the check engine warning lamp illuminating could result in engine trouble and DPF damage.

Urea SCR system (AdBlue™-related system)*

AdBlue™: trademark of the Verband der Automobilindustrie e.V. (VDA).

The urea SCR system is a system that uses AdBlue™ to reduce the emissions of nitrogen oxide (NO_x) in the exhaust gas of diesel engines.

Because AdBlue™, like fuel, is consumed as the vehicle is driven, it must be replenished according to the distance travelled.

Urea SCR system (AdBlue™-related system)*

AdBlue™ level warning

Warning lamp



Warning display

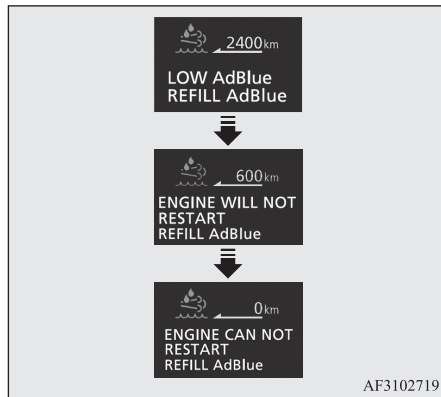

When the driving range is approximately 2,400 km (1,500 miles) or less, a warning display will appear on the information screen in the multi-information display. The warning display and estimated driving range will change according to the amount of AdBlue™ remaining.

At the same time, the warning lamp in the meter will come on or flash.

The following distances are displayed for the estimated driving range.

Driving range (km)		Driving range (miles)	
2,400	200	1,500	200
2,100	100	1,300	100
1,800	60	1,100	60
1,500	40	900	40
1,200	20	700	20
900	10	500	10
600	0	400	0
400		300	

If a warning display appears, replenish AdBlue™ as soon as possible. Refer to “AdBlue™ replenishment*” on page 10-11.

CAUTION

- When there is no AdBlue™ remaining and 0 km (0 mile) is displayed for the driving range, the engine cannot be restarted after it is stopped.

Urea SCR system warning

Warning lamp



Warning display

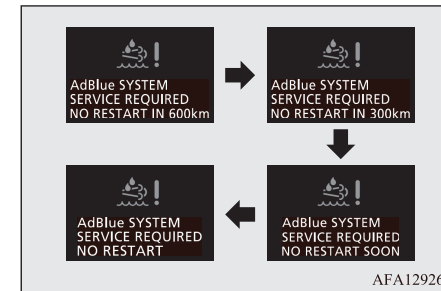

6

If there is a malfunction in the system, a warning display will appear on the information screen in the multi-information display according to the situation. At the same time, the warning lamp in the meter will flash. If a warning display appears, have your vehicle inspected by a MITSUBISHI MOTORS Authorized Service Point as soon as possible.

Turbocharger operation

CAUTION

- If the urea SCR system warning lamp comes on and the warning display appears, the vehicle can travel approximately 600 km (400 miles) before the engine cannot be restarted after it is stopped.

NOTE

- If there is a malfunction in the system, the check engine warning lamp may come on at the same time.



Turbocharger operation

CAUTION

- Do not run the engine at high speeds (for example, by revving it or by accelerating rapidly) immediately after starting it.
- Do not stop the engine immediately after high-speed or uphill driving. First allow the engine to idle to give the turbocharger a chance to cool down.
- Replace the engine oil at the specified intervals. If the engine oil is not replaced, the turbocharger could malfunction.

Auto Stop & Go (AS&G) system*

The Auto Stop & Go (AS&G) system automatically stops and restarts the engine without operating the ignition switch or engine switch when the vehicle is stopped, such as at a traffic light or in a traffic jam, to reduce exhaust gases, increase fuel efficiency.

CAUTION

- If the vehicle will be stopped for a long time or if you will leave the vehicle unattended, stop the engine.

NOTE

- The accumulated time the engine has been stopped by the AS&G system is displayed in the multi-information display. Refer to “Auto Stop & Go (AS&G) monitor” on page 5-12.
- If the AS&G system does not operate or it operates less frequently, the battery capacity may have decreased.
Have your vehicle inspected by a MITSUBISHI MOTORS Authorized Service Point.

To turn on/off AS&G

The AS&G system is automatically activated when the ignition switch is turned to the “ON” position or the operation mode is put in ON.

You can deactivate the system by pressing the “Auto Stop & Go (AS&G) OFF” switch.

Refer to “To deactivate” on page 6-35.

Automatically stopping the engine (on vehicles equipped with M/T)

1. Stop the vehicle when the  indicator display turns on.



6

2. While depressing the brake pedal, fully depress the clutch pedal and place the gearshift lever in the “N” (Neutral) position.

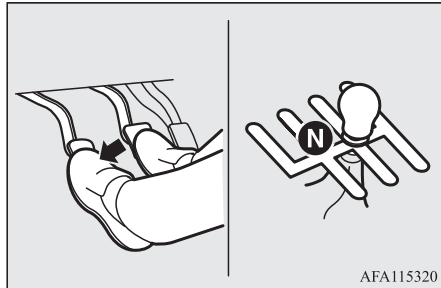

3. Release the clutch pedal. The engine will stop automatically.

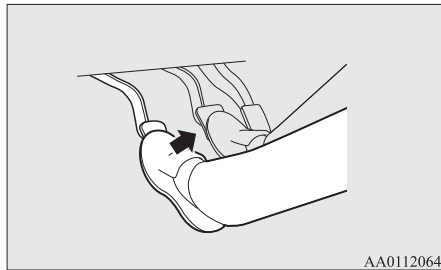

Automatically stopping the engine (on vehicles equipped with A/T or CVT)

1. Stop the vehicle when the  indicator display turns on.
2. Depress the brake pedal. The engine will stop automatically.

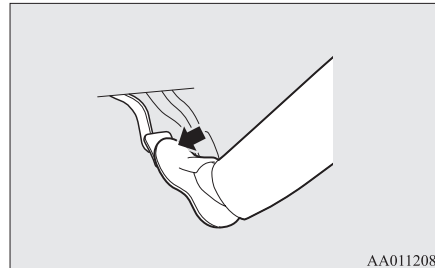

When the Adaptive Cruise Control System (ACC) is turned on (on vehicles equipped with the ACC)

1. Turn on the ACC when the  indicator display turns on.
2. When the ACC operates and the vehicle stops, the engine will stop automatically even if you do not depress the brake pedal.

NOTE

- When the engine is automatically stopped, changes will occur in the driving operations. Pay close attention to the following.
 - The brake booster becomes inoperative and the pedal effort will increase. If the vehicle is moving, press down the brake pedal harder than usual.
 - The electric power steering system (EPS) becomes inoperative and it will become harder to turn the steering wheel.



6

CAUTION

- When the engine is automatically stopped, do not attempt to exit the vehicle. Because the engine restarts automatically when the driver's seat belt is unfastened or the driver's door is opened, an unexpected accident might occur when the vehicle starts moving.
- Observe the following precautions when the engine is stopped automatically. Otherwise, an unexpected accident might occur when the engine restarts automatically.



Auto Stop & Go (AS&G) system*

CAUTION

- On vehicles equipped with M/T, do not move the gearshift lever to a position other than the “N” (Neutral) position. If the gearshift lever is moved to a position other than the “N” (Neutral) position, the  indicator display blinks and the buzzer sounds. If the gearshift lever is returned to the “N” (Neutral) position, the  indicator display stops blinking and the buzzer stops sounding. The engine will not restart if the gearshift lever is in a position other than the “N” (Neutral) position.

6

NOTE

- In the following cases, the  indicator display will blink to inform the driver and the engine will not stop automatically.
 - Driver’s seat belt is not fastened
 - Driver’s door is open
 - Bonnet is open
- In the following cases, the  indicator display will turn off and the engine will not stop automatically even if the vehicle is stopped.
 - After the engine is started, the vehicle speed never exceeded approximately 5 km/h (3 mph).
 - After the engine is started, approximately 30 seconds or more have not elapsed.

NOTE

- After the engine restarts automatically and the vehicle stops again within 10 seconds.
- Diesel particulate filter (DPF) is burning away trapped particulate matter (PM).
- Engine coolant temperature is low.
- Ambient temperature is low.
- When using the heater, the vehicle interior temperature is not warm enough.
- Air conditioning is operating and passenger compartment has not sufficiently cooled.
- Demister switch is pressed. Refer to “Demisting of the windscreen and door windows” on page 7-06.
- When the air conditioning is operated in automatic mode where the temperature control is set to the max. hot or the max. cool.
- Electric power consumption is high, such as when the rear window demister or other electrical components are operating or the blower speed is set to a high setting.
- Battery volume, voltage or battery performance is low.
- “Check engine warning lamp” is illuminated or the  indicator display is blinking.
- The selector lever is another position than in the “D” (DRIVE) position (A/T or CVT).
- ASC operation indicator and ASC OFF indicator is turned on (A/T or CVT).

NOTE

- ABS warning lamp is turned on.
- A/T or CVT warning lamp will turn on/warning display will display.
- In the following cases, the engine will not stop automatically even if the  indicator display turned on.
 - The accelerator pedal is depressed.
 - The brake booster vacuum pressure is low.
 - The steering wheel is operated.
 - The brake pedal is not sufficiently depressed (A/T or CVT).
 - The vehicle is being parked on a steep hill (A/T or CVT).
 - The parking brake operates (A/T or CVT).
- On vehicles equipped with M/T, do not rest your foot on the clutch pedal while driving because this will cause detection of clutch pedal switch malfunction and blinking of AS&G OFF display, and AS&G system will not operate.
- If the AS&G system operates while the air conditioning is operating, both the engine and the air conditioning compressor will stop. Therefore, only the blower will operate, the windows may start to fog up. If this occurs, press the demister switch to restart the engine. Refer to “Demisting of the windscreen and door windows” on page 7-06.

NOTE

- If the windows become fogged up each time the engine is stopped, we recommend you to deactivate the AS&G system by pressing the “Auto Stop & Go (AS&G) OFF” switch. Refer to “To deactivate” on page 6-35.
- If the air conditioning is operating, set the temperature control higher to lengthen the time that the engine is stopped automatically.

Automatically restarting the engine (on vehicles equipped with M/T)

Depress the clutch pedal while the gearshift lever is in the “N” (Neutral) position. The  indicator display turns off and the engine restarts automatically.

Automatically stopping the engine (on vehicles equipped with A/T or CVT)

Release the brake pedal. The  indicator display turns off and the engine restarts automatically.

When the Brake auto hold operation indicator is turned on (on vehicles equipped with Brake auto hold)

When you depress the accelerator pedal, the engine restarts automatically.

When the Adaptive Cruise Control System (ACC) is turned on (on vehicles equipped with the ACC)

When the vehicle in front starts moving or when you depress the accelerator pedal, the engine restarts automatically.

NOTE

- On vehicles equipped with Brake auto hold, if the Brake auto hold indication lamp turns on, the engine will not restart automatically even if you release the brake pedal.
- While the ACC is operating, the engine will not restart automatically even if you release the brake pedal (on vehicles equipped with ACC).
- On vehicles with M/T, do not move the gearshift lever to a position other than the “N” (Neutral) position or do not release the clutch pedal while the engine is restarting automatically. The starter motor will stop and the engine will not restart automatically.

NOTE

- If the engine does not restart automatically, the warning display will appear in the information screen of the multi-information display, and the charge warning lamp and check engine warning lamp will illuminate. Warning display (on vehicles equipped with M/T)



Warning display (on vehicles equipped with A/T or CVT)



If this occurs:

[On vehicles equipped with M/T]
The engine will not restart even if the clutch pedal is depressed again. While depressing the brake pedal, fully depress the clutch pedal and turn the ignition switch to the “START” position or press the engine switch to start the engine.

Auto Stop & Go (AS&G) system*

NOTE

[On vehicles equipped with A/T or CVT]
The engine will not restart even if release the brake pedal again. Also, the **(A)OFF** indicator display blinks, and the buzzer sounds.

While depressing the brake pedal, move the selector lever to the “P” (Park) or “N” (Neutral) position and turn the ignition switch to the “START” position or press the engine switch to start the engine. After the engine is started, the buzzer stops.

But the **(A)OFF** indicator display is blinking until turning the ignition switch to the “LOCK” position or putting the operation mode in OFF.

For details, refer to “Starting and stopping the engine” on page 6-19.

- The vehicles equipped with A/T or CVT have the function of preventing the unexpected start of the vehicle due to creeping, etc., by temporarily maintain the braking force applied when the engine restarts automatically.

This function is deactivated if the selector lever is set into the “N” (Neutral) position.

While the function is activated, you might hear operation noise from under the vehicle or feel a shock from the brake pedal.

This indicates that the system is operating normally. It does not indicate a malfunction.

CAUTION

- In the following cases, the engine will restart automatically even if the engine was stopped

CAUTION

by the AS&G system. Pay attention, otherwise an unexpected accident might occur when the engine restarts.

- Vehicle speed is 3 km/h (2 mph) or higher when coasting down a slope
- Brake booster vacuum pressure is low because the brake pedal is depressed repeatedly or depressed harder than usual
- Engine coolant temperature is low
- When the air conditioning is operated by pressing the air conditioning switch.
- When the preset temperature of the air conditioning is changed significantly.
- When the air conditioning is operated in automatic mode where the temperature control is set to the max. hot or the max. cool
- When the air conditioning is ON, the passenger compartment temperature rises and the air conditioning compressor operates to lower the temperature.
- Demister switch is pressed
Refer to “Demisting of the windscreen and door windows” on page 7-06.
- Electric power consumption is high, such as when the rear window demister or other electrical components are operating or the blower speed is set to a high setting.
- The accelerator pedal (A/T or CVT) is pushed.
- Battery voltage or battery performance is low.
- The steering wheel is operated.
- After the engine is stopped, 3 minutes have elapsed (CVT).

CAUTION

- The selector lever is moved to the “R” (REVERSE) position (A/T or CVT).
- The selector lever is moved from the “N” (NEUTRAL) to “D” (DRIVE) position (A/T or CVT).
- The driver’s seat belt is unfastened.
- The driver’s door is opened.
- When the Electric parking brake switch is pulled up to operate the Electric parking brake (on vehicles equipped with the Electric parking brake).

NOTE

- In the following cases, the engine will not restart automatically.
 - Bonnet is open
 - On vehicles equipped with M/T, while the engine is stopped automatically, “Auto Stop & Go (AS&G) OFF” switch is pressed to deactivate the “Auto Stop & Go (AS&G) OFF” system.
- When the engine restarts automatically, the audio volume may temporarily decrease. This does not indicate a malfunction.
- When the engine is stopped automatically, the air conditioning may temporarily change the air volume. This does not indicate a malfunction.

Manual transmission*

NOTE

- On vehicles equipped with A/T or CVT, while the engine is stopped automatically, if the selector lever is moved to the “P” (PARK) position quickly with the brake pedal firmly depressed, the engine does not restart automatically even if you release the brake pedal.
If this occurs, the  display will blink to inform the driver.
If you want to restart the engine, depress the brake pedal again.
If you want to put the operation mode in OFF, press the engine switch without depressing the brake pedal. (on vehicles equipped with the keyless operation system)

To deactivate

The AS&G system is automatically activated when the ignition switch is turned to the “ON” position or the operation mode put in ON. You can deactivate the system by pressing the “Auto Stop & Go (AS&G) OFF” switch.

When the AS&G system is deactivated, the  display will be turned on.

To reactivate the AS&G system, press the “Auto Stop & Go (AS&G) OFF” switch; the display will turn off.

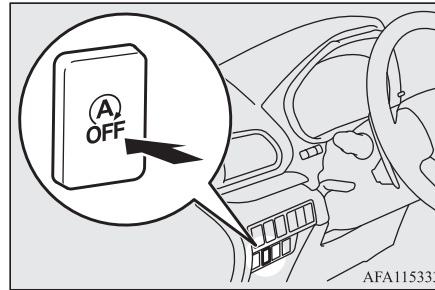

AS&G OFF indicator display



NOTE

- This display will also turn on for a few seconds when the ignition switch is turned to the “ON” position or the operation mode put in ON.

If the warning lamp/display blinks while driving



If the warning display appears on the information screen in the multi-information display and the  indicator display blinks, the AS&G system is malfunctioning and will not operate.

We recommend you to consult a MITSUBISHI MOTORS Authorized Service Point.

Manual transmission*

The shift pattern is shown on the gearshift lever knob. Press the clutch pedal all the way down while shifting gears. To start off, press the clutch pedal all the way down and shift into the 1st or “R” (Reverse) position, operating the gearshift lever slowly.

Then gradually release the clutch pedal while depressing the accelerator pedal.

6



8-speed Automatic transmission with Sports Mode*

6

CAUTION

- Do not put the gearshift lever into the reverse position while the vehicle is moving forward. Doing so could damage the transmission.
- Do not rest your foot on the clutch pedal while driving as this will cause premature clutch wear or damage.
- Do not coast in the “N” (Neutral) position.
- Do not use the gearshift lever as a handrest, because this can result in premature wear of the transmission shift forks.

NOTE

- During cold weather, shifting may be difficult until the transmission lubricant has warmed up. This is normal and not harmful to the transmission.
- If it is hard to shift into 1st, depress the clutch pedal again; the shift will then be easier to make.
- The gearshift indicator (if so equipped) shows recommended gearshift points for fuel-efficient driving. It shows a  in the multi-information display when an upshift is recommended, and it shows a  when a downshift is recommended.



Moving the gearshift lever to the “R” (Reverse) position

Pull up the pull-ring (A), then move the gearshift lever to the “R” (Reverse) position with the pull-ring still pulled.

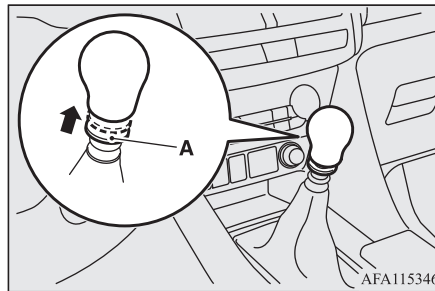

CAUTION

- Do not pull up the pull-ring (A) when moving the gearshift lever to any position other than the “R” (Reverse) position. If you always pulled up the pull-ring (A) when moving the gearshift lever, you could unintentionally move the gearshift lever to the “R” (Reverse) position and cause an accident and/or a transmission fault.

The pull-ring will return to its original position when you return the gearshift lever to the “N” (Neutral) position.

CAUTION

- If the pull-ring will not return from the pulled-up position, we recommend you to have the vehicle inspected.

Possible driving speed

Avoid shifting down at high speed, as this may cause excessive engine speed (the tachometer needle into the red zone) and damage the engine.

Shift point	Speed limit
1 st gear	45 km/h (28 mph)
2 nd gear	90 km/h (56 mph)
3 rd gear	140 km/h (87 mph)
4 th gear	190 km/h (118 mph)
5 th gear	200 km/h (124 mph)

Use 6th gear whenever vehicle speed allows, for maximum fuel economy.

8-speed Automatic transmission with Sports Mode*

Automatic transmission will automatically change its gear depending on road and driving conditions. This helps achieve smooth driving and excellent fuel efficiency.

Also you can manually shift up and shift down the transmission. Refer to “Sports mode” on page 6-46.

Selector lever operation

The transmission has eight forward gears and one reverse gear.

The individual gears are selected automatically, depending on the speed of the vehicle and the position of the accelerator pedal.

The selector lever (A) has two gates; the main gate (B) and sports mode gate (C).

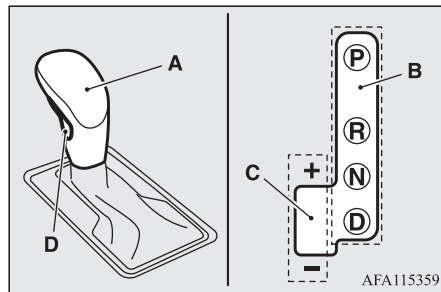

In the main gate, the selector lever has four positions, and is equipped with a lock button (D) to avoid inadvertent selection of the wrong gear.

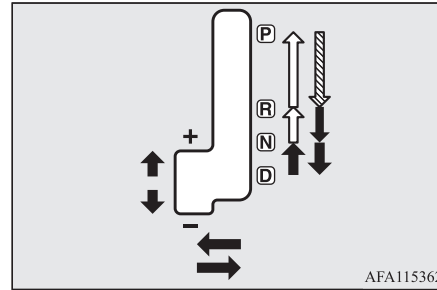

	The lock button must be pushed while the brake pedal is depressed to move the selector lever.
	The lock button must be pushed to move the selector lever.
	The lock button need not be pushed to move the selector lever.

WARNING

- If the lock button is always pushed to operate the selector lever, the lever may be accidentally shifted into the “P” (PARK) or “R” (REVERSE) position. Be sure not to push the lock button when performing the operations indicated by ↓ in the illustration.
- Always depress the brake pedal when shifting the selector lever into the other position from the “P” (PARK) or “N” (NEUTRAL) position. Never put your foot on the accelerator pedal while shifting the selector lever from the “P” (PARK) or “N” (NEUTRAL) position.

6

NOTE

- To avoid erroneous operation, move the selector lever firmly into each position and briefly hold it there. Always check the position shown by the selector lever position display after moving the selector lever.
- If the brake pedal is not depressed and held, the shift-lock device activates to prevent the selector lever from being moved from the “P” (PARK) position.

When the selector lever cannot be shifted from the “P” (Park) position

When the selector lever cannot be shifted from the “P” (PARK) position to another position while the brake pedal is pressed and held down with the ignition switch at the “ON” position or the operation mode in ON, the battery may be flat or the shift-lock mechanism may be malfunctioning. Immediately have your vehicle checked by a MITSUBISHI MOTORS Authorized Service Point.

If you need to move the vehicle, shift the selector lever as follows.

1. Make sure the parking brake is firmly applied.
2. Stop the engine if it is running.

3. Insert a straight blade (or minus) screwdriver with a cloth over its tip into notch (A) or the cover. Pry gently as shown to remove the cover.

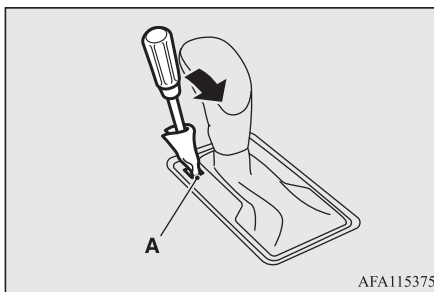

4. Depress the brake pedal with the right foot.
5. Insert a straight blade (or minus) screwdriver in the shiftlock release hole (B). Shift the selector lever to the “N” (Neu-

tral) position while pressing the straight blade (or minus) screwdriver down

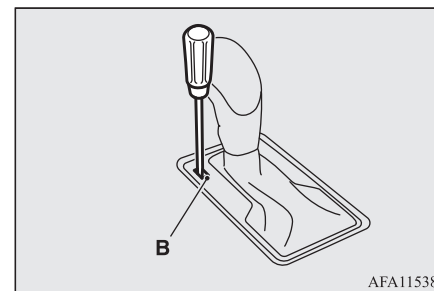

Selector lever position display

When the ignition switch is turned to the “ON” position or the operation mode is put in ON, the position of the selector lever is indicated in the multi-information display.

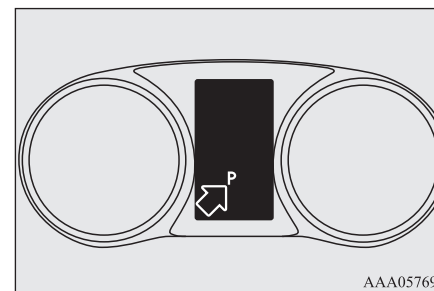

Selector lever positions

“P” PARK

This position locks the transmission to prevent the vehicle from moving. The engine can be started in this position.

CAUTION

- Never shift into the “P” (Park) position while the vehicle is in motion to avoid a transmission damage.

“R” REVERSE

This position is to back up.

CAUTION

- Never shift into the “R” (Reverse) position from the “D” (Drive) position while the vehicle is in motion to avoid a transmission damage.

“N” NEUTRAL

At this position, the transmission is disengaged. It is the same as the neutral position on a M/T, and should only be used when the vehicle is stationary for an extended length of time during driving, such as in a traffic jam.

WARNING

- Never move the selector lever to the “N” (Neutral) position while driving. A serious accident could occur since you could accidentally move the lever into the “P” (Park) or “R” (Reverse) position or you will lose engine braking.
- On a gradient, the engine should be started in the “P” (PARK) position, not in the “N” (NEUTRAL) position.
- To prevent rolling, always keep your foot on the brake pedal when the vehicle is in “N” (Neutral) position, or when shifting into or out of “N” (Neutral) position.

“D” DRIVE

This position is used for most city and highway driving. The transmission will automatically change its gear depending on road and driving conditions.

CAUTION

- To prevent transmission damage, never shift into the “D” (Drive) position from the “R” (Reverse) position while the vehicle is in motion.

Sports mode

Whether the vehicle is stationary or in motion, sports mode is selected by gently pushing the selector lever from the “D” (DRIVE) position into sports mode gate (A). To return to “D” range operation, gently push the selector lever back into the main gate (B). In sports mode, gear shifts can be made rapidly simply by moving the selector lever backward and forward or using the shift paddles at the steering wheel (for vehicles equipped with the shift paddles). In contrast to a M/T, the sports mode allows gear shifts with the accelerator pedal depressed.

6

NOTE

- You can shift into sports mode with shift paddles when the selector lever is in the main gate (B) as well. Also, you can return to the “D” range operation in any of following ways.
 - When returning to “D” range operation, the selector lever position display will change to “D” (DRIVE) position.
 - Pull the **+** (SHIFT UP) side shift paddle forward (towards the driver) for over 2 seconds.
 - Stop the vehicle.
 - Push the selector lever from the “D” (DRIVE) position into the manual gate (A) and push the selector lever back into the main gate (B).

8-speed Automatic transmission with Sports Mode*

6

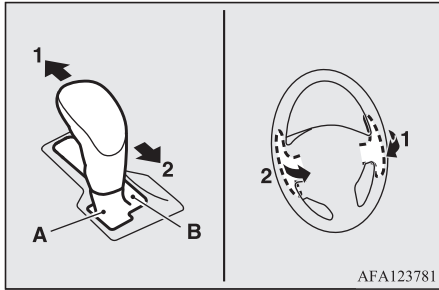

1- + (SHIFT UP)

The transmission shifts up once by each operation.

2- - (SHIFT DOWN)

The transmission shifts down once by each operation.

CAUTION

- In sports mode, the driver must execute upward shifts in accordance with prevailing road conditions, taking care to keep the engine speed below the red zone.
- Repeated continuous operation of the shift paddles will continuously switch shift position.
- Do not use the left- and right-hand shift paddles at the same time. Doing so could cause a gearshift that you do not expect.

NOTE

- Only the eight forward gears can be selected. To reverse or park the vehicle, move the selector lever to the “R” (Reverse) or “P” (Park) position as required.
- To maintain good running performance, the transmission may refuse to perform an upshift when the shift paddle on the “+ (SHIFT UP)” side is pulled at certain vehicle speeds. Also, to prevent over-revving of the engine, the transmission may refuse to perform a downshift when the shift lever or the shift paddles on the “- (SHIFT DOWN)” side is pulled at certain vehicle speeds. When this happens, a buzzer sounds to indicate that a downshift is not going to take place.
- Downward shifts are made automatically when the vehicle slows down. Before the vehicle stops, 1st gear is automatically selected.
- The upward shift may be made automatically in sports mode when the engine revolutions rise and approach the tachometer’s red zone (the red-coloured part of the tachometer dial).
- When driving away on a slippery road, pull the shift paddle on the + (SHIFT UP) side. This cause the transmission to shift into the 2nd gear which is better for smooth driving away on a slippery road. Pull the shift paddle on the - (SHIFT DOWN) side to shift back to the 1st gear.

NOTE

- When the selector lever is in the “D” (DRIVE) position and sports mode is selected, the gearshift indicator (if so equipped) shows recommended gearshift points for fuel-efficient driving. It shows a  when an upshift is recommended.

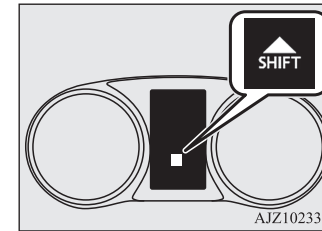

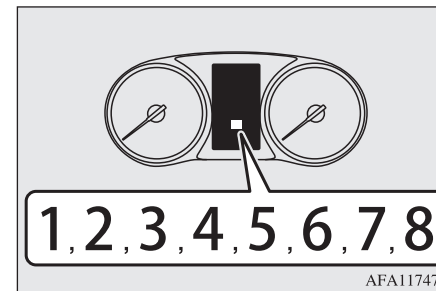

Shift paddles position display

The currently selected position is displayed on the multi-information display.



When a malfunction occurs in the A/T



There could be a system malfunction if the  warning display or the  warning display is displayed on the information screen in the multi-information display.



or



NOTE



- The selector lever position display blinks at the same time as the  or  warning display appears.

NOTE

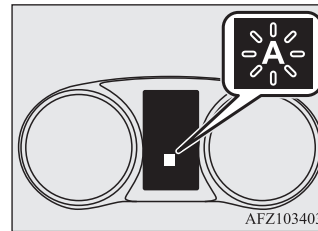

- The “A” indicator on the selector lever position display will blink only when there is a problem with the A/T position switch. It is not seen during normal driving.



CAUTION

- If malfunction occurs in the A/T while driving, the  warning display or the  warning display will appear on the information screen in the multi-information display. In this case, follow these procedures:
[When  warning display is showing]
The A/T fluid is overheating. The engine control may activate to lower the A/T fluid temperature, causing the engine revolutions and vehicle speed to decrease. In this case, take one of the following measures.
 - Slow down your vehicle.
 - Stop your vehicle in a safe place, put the selector lever in the “P” (Park) position, and open the bonnet with the engine running to allow the engine to cool down.

CAUTION

After a while, confirm that the  warning display is no longer showing. It is safe to continue driving if the display is no longer showing. If the warning display remains, contact a MITSUBISHI MOTORS Authorized Service Point immediately.
[When  warning display is showing]
It may be that there is something unusual happening in the A/T, causing a safety device to activate. Have the vehicle inspected by a MITSUBISHI MOTORS Authorized Service Point immediately.

6

Operation of the A/T

CAUTION

- Before selecting a position with the engine running and the vehicle stationary, fully depress the brake pedal to prevent the vehicle from creeping.
The vehicle will begin to move as soon as the gear is engaged, especially when the engine speed is high, at fast idle or with the air conditioning operating, the brakes should only be released when you are ready to drive away.
- Depress the brake pedal with the right foot at all times.
Using the left foot could cause driver movement delay in case of an emergency.

⚠ CAUTION

- To prevent sudden acceleration, never race the engine when shifting from the “P” (PARK) or “N” (NEUTRAL) position.
- Operating the accelerator pedal while the other foot is resting on the brake pedal will affect braking efficiency and may cause premature wear of brake pads.
- Use the selector lever in the correct shift position in accordance with driving conditions. Never coast downhill backward with the selector lever in the “D” (DRIVE) position or coast forward with the selector lever in the “R” (REVERSE) position.
The engine may stop and the unexpected increase in brake pedal effort and steering wheel weight could lead to an accident.
- Do not race the engine with brake pedal pressed when the vehicle is stationary. This can damage the A/T.
Also, when you depress the accelerator pedal while holding down the brake pedal with the selector lever in the “D” (DRIVE) position, the engine revolutions may not rise as high as when performing the same operation with the selector lever in the “N” (NEUTRAL) position.

Passing acceleration

To gain extra acceleration in “D” (DRIVE) position push the accelerator to the floor. The A/T will automatically downshift.

📖 NOTE

- When shift paddles is in operation, downshifts do not take place when the accelerator is depressed all the way to the floor.

Uphill/downhill driving

DRIVING UPHILL

The transmission prevents unnecessary upshifts even when the accelerator pedal is released and ensures smooth driving.

DRIVING DOWNHILL

According to the conditions, the transmission will automatically shift to a lower gear ratio to achieve stronger engine braking. This may help reduce your need to use the service brake.

Waiting

For short waiting periods, such as at traffic signals the vehicle can be left in selector lever position and held stationary with the service brake.

For longer waiting periods with the engine running, place the selector lever in the “N” (NEUTRAL) position and apply the parking brake, while holding the vehicle stationary with the service brake.

⚠ CAUTION

- Never hold the vehicle stationary while in gear on a hill with the accelerator, always apply the parking brake and/or service brake.

Parking

To park the vehicle, first bring it to a complete stop, fully engage the parking brake, and then move the selector lever to the “P” (PARK) position.

If you are going to leave the vehicle unattended, always switch off the engine and remove the ignition key.

📖 NOTE

- On a slope, be sure to apply the parking brake before moving the selector lever to the “P” (PARK) position. If you move the selector lever to the “P” (PARK) position before applying the parking brake, it may be difficult to disengage the selector lever from the “P” (PARK) position when next you drive the vehicle, requiring application of a strong force to the selector lever to move from the “P” (PARK) position.

When the A/T makes no speed change

If the transmission does not change speeds while driving, or your vehicle does not pick up enough speed when starting on an uphill slope, it may be that there is something unusual happening in the transmission, causing a safety device to activate. We recommend you to have your vehicle checked as soon as possible.

INVECS-III CVT with 8-step Sports Mode*

The CVT will automatically and continuously change its gear ratio depending on road and driving conditions. This helps achieve smooth driving and excellent fuel efficiency. Also you can manually shift up and shift down the transmission. Refer to “Sports mode” on page 6-46.

Selector lever operation

The transmission has eight forward gears and one reverse gear. The individual gears are selected automatically, depending on the speed of the vehicle and the position of the accelerator pedal.

The selector lever (A) has two gates; the main gate (B) and sports mode gate (C).

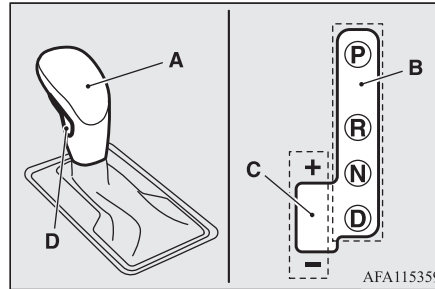

In the main gate, the selector lever has four positions, and is equipped with a lock button (D) to avoid inadvertent selection of the wrong gear.

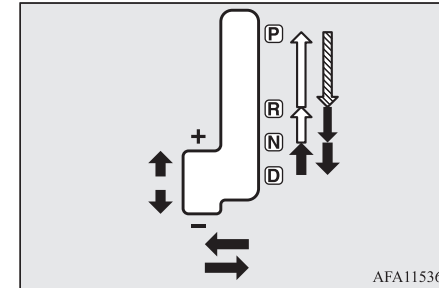

6

	The lock button must be pushed while the brake pedal is depressed to move the selector lever.
	The lock button must be pushed to move the selector lever.
	The lock button need not be pushed to move the selector lever.

⚠ WARNING

- If the lock button is always pushed to operate the selector lever, the lever may be accidentally shifted into the “P” (PARK) or “R” (REVERSE) position. Be sure not to push the lock button when performing the operations indicated by ↓ in the illustration.
- Always depress the brake pedal when shifting the selector lever into the other position from the “P” (PARK) or “N” (NEUTRAL) position. Never put your foot on the accelerator pedal while shifting the selector lever from the “P” (PARK) or “N” (NEUTRAL) position.

6

📖 NOTE

- To avoid erroneous operation, move the selector lever firmly into each position and briefly hold it there. Always check the position shown by the selector lever position display after moving the selector lever.
- If the brake pedal is not depressed and held, the shift-lock device activates to prevent the selector lever from being moved from the “P” (PARK) position.

When the selector lever cannot be shifted from the “P” (Park) position

When the selector lever cannot be shifted from the “P” (PARK) position to another position while the brake pedal is pressed and held down with the ignition switch at the “ON” position or the operation mode in ON, the battery may be flat or the shift-lock mechanism may be malfunctioning. Immediately have your vehicle checked by a MITSUBISHI MOTORS Authorized Service Point.

If you need to move the vehicle, shift the selector lever as follows.

1. Make sure the parking brake is firmly applied.
2. Stop the engine if it is running.

3. Insert a straight blade (or minus) screwdriver with a cloth over its tip into notch (A) or the cover. Pry gently as shown to remove the cover.

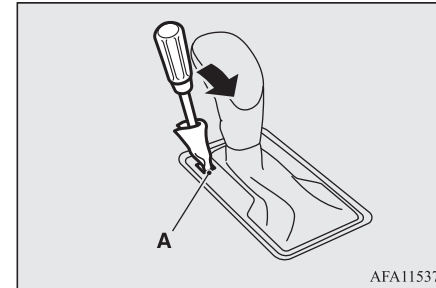

4. Depress the brake pedal with the right foot.

5. Insert a straight blade (or minus) screwdriver in the shiftlock release hole (B). Shift the selector lever to the “N” (NEUTRAL) position while pressing the straight blade (or minus) screwdriver down.

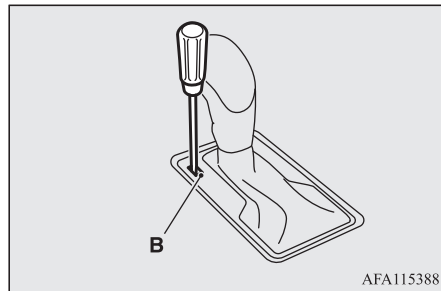

Selector lever position display

When the ignition switch is turned to the “ON” position or the operation mode is put in ON, the position of the selector lever is indicated in the multi-information display.

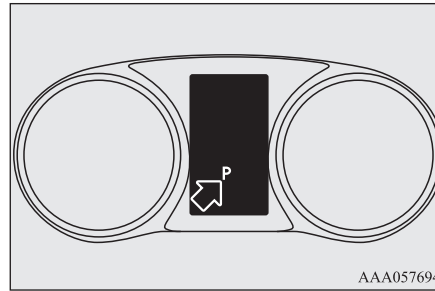

When the selector lever position display blinks (if the ambient temperature is low)

⚠ WARNING

- To avoid unintended vehicle movement, keep the brake pedal applied with your right foot and do not depress the accelerator pedal, while the selector lever position display is blinking.

If the ambient temperature is low, the selector lever position display on the multi-information display may blink when the selector lever is placed in the “D” (DRIVE) or “R” (REVERSE) position immediately after the engine has been started. This indicates that the transmission requires warming up.

While the display is blinking, the vehicle will not move, because the transmission keeps disengaging until the warm-up is completed even if the selector lever is placed in the “D” or “R” position.

6

When the selector lever position display is blinking, perform the following procedure:

1. Depress the brake pedal with your right foot and place the selector lever in the “N” (NEUTRAL) position for several seconds.
2. Keep depressing the brake pedal and then place the selector lever in the “D” (DRIVE) or “R” (REVERSE) position. If the selector lever position display stops blinking, the warm-up is completed and the transmission will function normally.
3. If the display is still blinking, repeat steps 1 and 2 above.

 **NOTE**

- While the selector lever position display is blinking, a buzzer will sound intermittently.

Selector lever positions

“P” PARK

6

This position locks the transmission to prevent the vehicle from moving. The engine can be started in this position.

 **CAUTION**

- Never shift into the “P” (Park) position while the vehicle is in motion to avoid a transmission damage.

“R” REVERSE

This position is to back up.

 **CAUTION**

- Never shift into the “R” (Reverse) position from the “D” (Drive) position while the vehicle is in motion to avoid a transmission damage.

“N” NEUTRAL

At this position, the transmission is disengaged. It is the same as the neutral position on a M/T, and should only be used when the vehicle is stationary for an extended length of time during driving, such as in a traffic jam.

 **WARNING**

- **Never move the selector lever to the “N” (Neutral) position while driving. A serious accident could occur since you could accidentally move the lever into the “P” (Park) or “R” (Reverse) position or you will lose engine braking.**
- **On a gradient, the engine should be started in the “P” (PARK) position, not in the “N” (NEUTRAL) position.**
- **To prevent rolling, always keep your foot on the brake pedal when the vehicle is in “N” (Neutral) position, or when shifting into or out of “N” (Neutral) position.**

“D” DRIVE

This position is used for most city and highway driving. The transmission will automatically and continuously change its gear ratio depending on road and driving conditions.

 **CAUTION**

- To prevent transmission damage, never shift into the “D” (Drive) position from the “R” (Reverse) position while the vehicle is in motion.

Sports mode

Whether the vehicle is stationary or in motion, sports mode is selected by gently pushing the selector lever from the “D” (DRIVE) position into sports mode gate (A).

To return to “D” range operation, gently push the selector lever back into the main gate (B). In sports mode, gear shifts can be made rapidly simply by moving the selector lever backward and forward or using the shift paddles at the steering wheel (for vehicles equipped with the shift paddles). In contrast to a M/T, the sports mode allows gear shifts with the accelerator pedal depressed.

 **NOTE**

- You can shift into sports mode with shift paddles when the selector lever is in the main gate (B) as well. Also, you can return to the “D” range operation in any of following ways.
When returning to “D” range operation, the selector lever position display will change to “D” (DRIVE) position.

NOTE

- Pull the + (SHIFT UP) side shift paddle forward (towards the driver) for over 2 seconds.
- Stop the vehicle.
- Push the selector lever from the “D” (DRIVE) position into the manual gate (A) and push the selector lever back into the main gate (B).

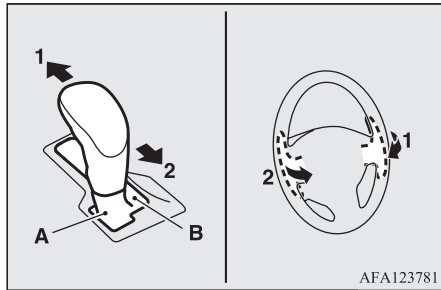

1. **+ (SHIFT UP)**
The transmission shifts up once by each operation.
2. **- (SHIFT DOWN)**
The transmission shifts down once by each operation.

CAUTION

- In sports mode, the driver must execute upward shifts in accordance with prevailing road conditions, taking care to keep the engine speed below the red zone.
- Repeated continuous operation of the shift paddles will continuously switch shift position.
- Do not use the left- and right-hand shift paddles at the same time. Doing so could cause the wrong gear ratio to be selected.

NOTE

- Only the eight forward gears can be selected. To reverse or park the vehicle, move the selector lever to the “R” (Reverse) or “P” (Park) position as required.
- To maintain good running performance, the transmission may refuse to perform an upshift when the shift paddle on the “+ (SHIFT UP)” side is pulled at certain vehicle speeds. Also, to prevent over-revving of the engine, the transmission may refuse to perform a downshift when the shift lever or the shift paddles on the “- (SHIFT DOWN)” side is pulled at certain vehicle speeds. When this happens, a buzzer sounds to indicate that a downshift is not going to take place.
- Downward shifts are made automatically when the vehicle slows down. Before the vehicle stops, 1st gear is automatically selected.

NOTE

- The upward shift may be made automatically in sports mode when the engine revolutions rise and approach the tachometer’s red zone (the red-coloured part of the tachometer dial).
- When the selector lever is in the “D” (DRIVE) position and sports mode is selected, the gearshift indicator (if so equipped) shows recommended gearshift points for fuel-efficient driving. It shows a  when an upshift is recommended.

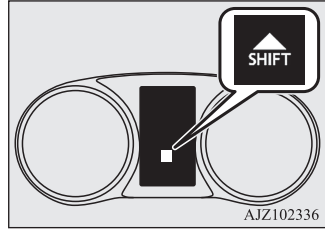



Shift paddles position display

The currently selected position is displayed on the multi-information display.

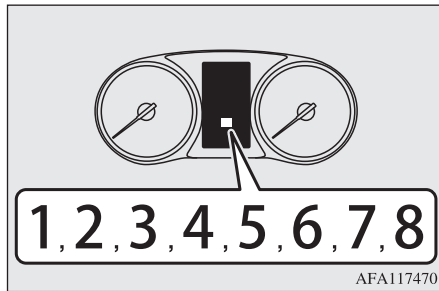
6



When a malfunction occurs in the CVT



There could be a system malfunction if the  warning display or the  warning display is displayed on the information screen in the multi-information display.



or



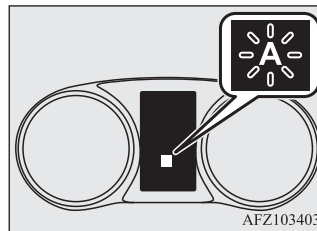

NOTE

- The selector lever position display blinks at the same time as the  or  warning display appears.
- The “A” indicator on the selector lever position display will blink only when there is a problem with the CVT position switch. It is not seen during normal driving.



CAUTION

- If malfunction occurs in the CVT while driving, the  warning display or the  warning display will appear on the information screen in the multi-information display.

In this case, follow these procedures:

[When  warning display is showing]

The CVT fluid is overheating. The engine control may activate to lower the CVT fluid temperature, causing the engine revolutions and vehicle speed to decrease. In this case, take one of the following measures.

- Slow down your vehicle.
- Stop your vehicle in a safe place, put the selector lever in the “P” (Park) position, and open the bonnet with the engine running to allow the engine to cool down.

After a while, confirm that the  warning display is no longer showing. It is safe to continue driving if the display is no longer showing. If the warning display remains, contact a MITSUBISHI MOTORS Authorized Service Point immediately.

[When  warning display is showing]

It may be that there is something unusual happening in the CVT, causing a safety device to activate. Have the vehicle inspected by a MITSUBISHI MOTORS Authorized Service Point immediately.

Operation of the CVT

CAUTION

- Before selecting a position with the engine running and the vehicle stationary, fully depress the brake pedal to prevent the vehicle from creeping.
The vehicle will begin to move as soon as the CVT is engaged, especially when the engine speed is high, at fast idle or with the air conditioning operating, the brakes should only be released when you are ready to drive away.
- Depress the brake pedal with the right foot at all times.
Using the left foot could cause driver movement delay in case of an emergency.
- To prevent sudden acceleration, never race the engine when shifting from the “P” (PARK) or “N” (NEUTRAL) position.
- Operating the accelerator pedal while the other foot is resting on the brake pedal will affect braking efficiency and may cause premature wear of brake pads.
- Use the selector lever in the correct shift position in accordance with driving conditions. Never coast downhill backward with the selector lever in the “D” (DRIVE) position or coast forward with the selector lever in the “R” (REVERSE) position.
The engine may stop and the unexpected increase in brake pedal effort and steering wheel weight could lead to an accident.

CAUTION

- Do not race the engine with brake pedal pressed when the vehicle is stationary. This can damage the CVT.
Also, when you depress the accelerator pedal while holding down the brake pedal with the selector lever in the “D” (DRIVE) position, the engine revolutions may not rise as high as when performing the same operation with the selector lever in the “N” (NEUTRAL) position.

Passing acceleration

To gain extra acceleration in “D” (DRIVE) position push the accelerator to the floor. The A/T will automatically downshift.

NOTE

- When shift paddles is in operation, downshifts do not take place when the accelerator is depressed all the way to the floor.

Uphill/downhill driving

DRIVING UPHILL

The transmission prevents unnecessary upshifts even when the accelerator pedal is released and ensures smooth driving.

DRIVING DOWNHILL

According to the conditions, the transmission will automatically shift to a lower gear ratio to achieve stronger engine braking. This may help reduce your need to use the service brake.

Waiting

For short waiting periods, such as at traffic signals the vehicle can be left in selector lever position and held stationary with the service brake.

For longer waiting periods with the engine running, place the selector lever in the “N” (NEUTRAL) position and apply the parking brake, while holding the vehicle stationary with the service brake.

CAUTION

- Never hold the vehicle stationary while in CVT on a hill with the accelerator, always apply the parking brake and/or service brake.

Parking

To park the vehicle, first bring it to a complete stop, firmly apply the parking brake, and then move the selector lever to the “P” (Park) position.

S-AWC (Super All Wheel Control)*

If you are going to leave the vehicle unattended, always switch off the engine and carry the key.

NOTE

- On a slope, be sure to apply the parking brake before moving the selector lever to the “P” (Park) position. If you move the selector lever to the “P” (Park) position before applying the parking brake, it may be difficult to disengage the selector lever from the “P” (Park) position when next you drive the vehicle, requiring application of a strong force to the selector lever to move from the “P” (Park) position.

When the CVT makes no speed change

If the transmission does not change speeds while driving, or your vehicle does not pick up enough speed when starting on an uphill slope, it may be that there is something unusual happening in the transmission, causing a safety device to activate. We recommend you to have your vehicle checked immediately.

S-AWC (Super All Wheel Control)*

S-AWC is an integrated vehicle dynamics control system that helps enhance driving performance, cornering performance, and vehicle stability over a wide range of driving conditions through integrated management of the electronically controlled 4WD, the AYC, the ABS and the ASC.

CAUTION

- Do not over-rely on the S-AWC. Even the S-AWC cannot prevent the natural laws of physics from acting on the vehicle. This system, like any other system, has limits and cannot help you to maintain traction and control of the vehicle in all circumstances. Reckless driving may lead to accidents. It is the driver’s responsibility to drive carefully. This means taking into account the traffic, road and environmental conditions.

Electronically Controlled 4WD

The electronically controlled 4WD is a system that improves acceleration performance and stability performance by controlling front-rear distribution of driving torque with operating the electronic control coupling arranged in the rear differential assembly.

NOTE

- On vehicles equipped with the lever type parking brake, if the parking brake lever is pulled up while the vehicle is moving, the front-rear distribution of driving torque control will be temporarily suspended, which will allow the rear wheel to lock easier.

Active Yaw Control (AYC)

Refer to “Active Yaw Control (AYC)” on page 6-62.

S-AWC drive mode

Select the drive mode from the following three types to suit the driving conditions.

S-AWC drive mode	Function
AUTO	AUTO mode applied to dry pavement road and wet road, etc. This mode controls driving/ braking torque between front right and front left wheel and between front and rear wheel according to the driving condition, and achieves low fuel consumption and agile driving.

S-AWC (Super All Wheel Control)*

S-AWC drive mode	Function
SNOW	This mode is chiefly suitable for the snow road. Stability improves on a slippery road.
GRAVEL	This mode is suitable mainly for driving on unpaved or rough roads. This mode provides 4WD high driving performance and stable cornering performance.

4-wheel drive operation requires special driving skills.

Carefully read the “4-wheel drive operation” on page 6-53 and take care to drive safety.

NOTE

- The S-AWC drive mode becomes “AUTO” when you turn on the ignition switch or the operation mode. For some models, the state of the S-AWC drive mode is maintained even if you turn off the ignition switch or the operation mode.

S-AWC drive mode-selector

The drive mode can be switched by press the switch while the ignition switch is in the “ON” position or the operation mode in ON.

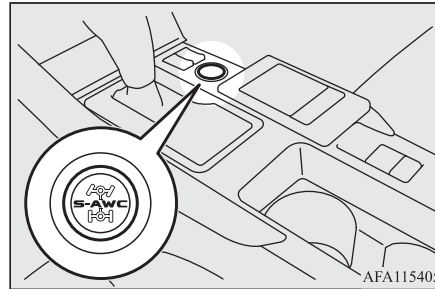

If you press the switch, you can change the drive mode in the order of AUTO, SNOW, GRAVEL, AUTO.

CAUTION

- Do not operate the drive mode-selector with the front wheels spinning on a snowy road or in similar conditions. The vehicle could lunge in an unexpected direction.
- Driving on dry, paved roads in “GRAVEL” and “SNOW” mode causes increased fuel consumption, noise and vibration.

NOTE

- Even if an S-AWC drive mode other than “AUTO” was selected before turning the ignition switch to the “LOCK” position or putting the operation mode in OFF, the S-AWC drive mode will be set to “AUTO” when the ignition switch is turned to the “ON” position or the operation mode is put in ON again. However, for some models, the state of the S-AWC drive mode is maintained even if you turn off the ignition switch or the operation mode.
- The drive mode can be switched while driving or stopped.

6

S-AWC drive mode display



Example: “AUTO” mode is selected.

The currently selected drive mode is displayed on the multi-information display. In addition, when the drive mode is changed, the selected mode appears on the interrupt display screen of the information screen in the multi-information display.

S-AWC (Super All Wheel Control)*

The drive mode display will appear on the information screen for a few seconds, and then the original screen will return.

CAUTION

- If the selected drive mode indicator is blinking, the drive mode switches automatically to protect the drive-system components. The warning display is also displayed in the information screen in the multi information display.



Reduce speed, and if the indicator goes out after driving a while, resume driving as before.

CAUTION

- If the drive mode indicator is blinking, a problem has occurred with the S-AWC system and the safety device has activated. The warning display is also displayed in the information screen in the multi-information display.

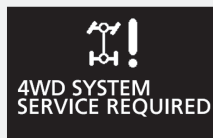

Have your vehicle inspected immediately by a MITSUBISHI MOTORS Authorized Service Point.

- Be sure to use tyres that are the same specified size, type, and brand, and have no difference in the amount of wear for all four wheels. Otherwise, the S-AWC system may not work properly.

S-AWC operation display

The S-AWC operation status can be displayed on the information screen in the multi-information display.

To display the status, press the multi-information display switch to change the information screen.

Refer to "Information screen (when the ignition switch or the operation mode is ON)" on page 5-05.

Display example

The S-AWC operation status is displayed.

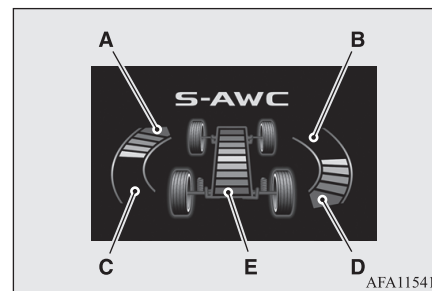

Yaw control function display

The amount of the yaw moment is displayed as a bar graph.

- A, D- Clockwise yaw moment about the vehicle's centre of gravity
- B, C- Anticlockwise yaw moment about the vehicle's centre of gravity

Traction control level display

The strength of the traction control operation (between the front and rear wheels) is displayed in section E of the meter as a bar graph.

⚠ WARNING

- Always concentrate on your driving first. Keep your eyes and mind on the road. Distractions while driving can lead to an accident.

4-wheel drive operation*

Your vehicle has been designed primarily for use on paved roads.

But its unique 4-wheel drive system allows you to occasionally travel on unpaved roads, to campgrounds, picnic sites, and similar locations.

Not only does this ensure better handling on dry, paved roads but also permits better traction when driving on slippery, wet or snow-covered roads and when moving out of mud.

But it is not suitable for heavy off road use or towing in rough conditions.

It is particularly important to note that 4-wheel drive may not give sufficient hill climbing ability and engine braking on steep slopes. You should try to avoid driving on steep slopes.

Also, you must exercise caution when driving on sand and mud and when driving through water because sufficient traction may not be available in certain circumstances.

Please avoid driving the vehicle through areas where the tyres may get stuck in deep sand or mud.

⚠ WARNING

- Do not over-rely on the 4-wheel drive vehicles. Even 4-wheel drive vehicles have limits to the system and ability to maintain control and traction. Reckless driving may lead to accidents. Always drive carefully, taking account of the road conditions.
- Improperly operating this vehicle on or off-paved roads can cause an accident or rollover in which you and your passengers could be seriously injured or killed.
 - Follow all instructions and guidelines in the owner's manual.
 - Keep your speed low and do not drive faster than conditions allow you to.

📖 NOTE

- Driving on rough roads can be hard on a vehicle. Before you leave paved roads, be sure all scheduled maintenance and service has been done, and that you have inspected your vehicle. Pay special attention to the condition of the tyres, and check the tyre pressures.
- MITSUBISHI MOTORS is not responsible to the operator for any damage or injury caused or liability incurred by improper and negligent operation of a vehicle. All techniques of vehicle operation depend on the skill and experience of the operator and other participating parties. Any deviation from the recommended operating instructions above is at their own risk.

📖 NOTE

- Note that the stopping distance required of a 4-wheel drive vehicle differs very little from that of a 2-wheel drive vehicle. When driving on a snow-covered road or a slippery, muddy surface, make sure that you keep a sufficient distance between your vehicle and the one ahead of you.
- The driving posture should be more upright; adjust the seat to a good position for easy steering and pedal operation. Be sure to wear the seat belt.
- After driving on rough roads, check each part of the vehicle and wash it thoroughly with water. Refer to “Inspection and maintenance following rough road operation” on page 6-55 and “Maintenance” on page 10-02.

⚠ CAUTION

- Setting the drive mode-selector to “GRAVEL” and “SNOW” to drive on dry paved road will increase fuel consumption, with possible noise and vibration generation.

4-wheel drive operation*

Turning sharp corners

When turning a sharp corner in “GRAVEL” position at low speed, a slight difference in steering may be experienced similar to feeling as if the brakes were applied. This is called tight corner braking and results from each of the 4 tyres being at a different distance from the corner. The phenomenon is typical of 4-wheel drive vehicles. If this occurs, either straighten out the steering wheel, or change to another mode.

6

On snowy or icy roads

Set the drive mode-selector to “SNOW” in accordance with the road conditions, and then gradually depress the accelerator pedal for a smooth start.

NOTE

- The use of snow tyres and/or snow traction device (tyre chains) is recommended.
- Maintain a safe distance between vehicles, avoid sudden braking, and use engine braking (downshifting).

CAUTION

- Avoid sudden braking, sudden acceleration and sharp turning. Skidding occurs and control of the vehicle could be lost.

Driving on sandy or muddy roads

Set the drive mode-selector to “GRAVEL” and then gradually depress the accelerator pedal for a smooth start. Keep the pressure on the accelerator pedal as constant as possible, and drive at low speed.

CAUTION

- Do not force the vehicle or drive recklessly on sandy surfaces. In comparison with normal road surfaces, the engine and other drive-system components are put under excessive strain when driving on such a surface. This could lead to accidents.
- If the engine is overheating or the engine power drops suddenly while the vehicle is being driven, immediately park your vehicle in a safe place.
Refer to “Engine overheating” on page 8-10 for details and take the required measures.

WARNING

- **When attempting to rock your vehicle out of a stuck position, be sure that the area around the vehicle is clear of people and physical objects. The rocking motion may cause the vehicle to suddenly launch forward or backward, causing injury or damage to nearby people or objects.**

NOTE

- Avoid sudden braking, sudden acceleration and sharp turning; such operations could result in the vehicle becoming stuck.
- If the vehicle becomes stuck in sandy or muddy roads, it can often be moved with a rocking motion. Move the selector lever alternately between the “D” (DRIVE) and “R” (REVERSE) positions, while pressing lightly on the accelerator pedal.
- Driving on rough roads can cause rust on the vehicle; wash the vehicle thoroughly as soon as possible after such use.

Climbing/descending sharp grades

Your vehicle may not provide sufficient hill climbing ability and engine braking on steep slopes. Avoid driving on steep slopes even though the vehicle is a 4-wheel drive vehicle.

Driving through water

If the electrical circuits become wet, further operation of the vehicle will be impossible; therefore, avoid driving through water unless absolutely necessary. If driving through water is unavoidable, use the following procedure:

Inspection and maintenance following rough road operation

Check the depth of the water and the terrain before attempting to drive through it. Drive slowly to avoid creating excessive water splashing.

CAUTION

- Never drive through water that is deep enough to cover wheel hubs, axles or exhaust pipe. Do not change the selector lever position while driving through water. Frequent driving through water can adversely affect the life span of the vehicle; we recommend you to take the necessary measures to prepare, inspect, and repair the vehicle.
- After driving through water, apply the brakes to be sure they are functioning properly. If the brakes are wet and not functioning properly, dry them out by driving slowly while lightly depressing the brake pedal. Inspect each part of the vehicle carefully.

Inspection and maintenance following rough road operation

After operating the vehicle in rough road conditions, be sure to perform the following inspection and maintenance procedures:

- Check that the vehicle has not been damaged by rocks, gravel, etc.

- Carefully wash the vehicle with water. Drive the vehicle slowly while lightly depressing the brake pedal in order to dry out the brakes. If the brakes still do not function properly, we recommend you to have the brakes checked as soon as possible.
- Remove the insects, dried grass, etc. clogging the radiator core.
- After driving through water, check the engine, transmission and differential oil. If the oil or grease is milky or cloudy because of water contamination, it must be replaced with new oil or grease.
- Check the inside of the vehicle. If water entry is found, dry the carpet etc.
- Inspect the headlamps. If the headlamp bulb is flooded with water, we recommend you to have it drained.

Cautions on handling of 4-wheel drive vehicles*

Tyres and wheels

Since the driving torque can be applied to the four wheels, the driving performance of the vehicle when operating in 4-wheel drive is greatly affected by the condition of the tyres.

Pay close attention to the tyres.

- Install only the specified tyres on all wheels. Refer to “Tyres and wheels” on page 11-11.
- Be sure all 4 tyres and wheels are the same size and type. When it is necessary to replace any of the tyres or wheels, replace all 4 tyres.
- All tyres should be rotated before the wear difference between the front and rear tyres is recognizable.

Good vehicle performance cannot be expected if there is a difference in wear between tyres. Refer to “Tyre rotation” on page 10-15.

- Check the tyre inflation pressure regularly.

CAUTION

- Always use tyres of the same size, same type, and same brand, and which have no wear differences. Using tyres of different size, type, brands or degree of wear, will increase the differential oil temperature, resulting in possible damage to the driving system. Further, the drive train will be subjected to excessive loading possibly leading to oil leakage, component seizure, or other serious faults.

Braking

Towing

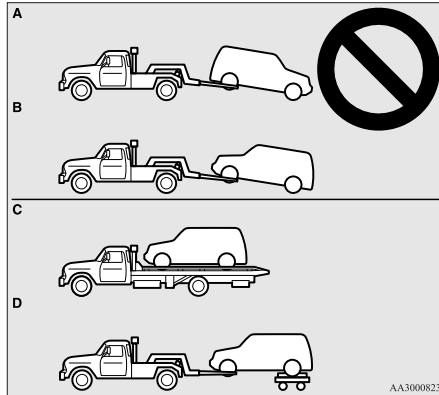

CAUTION

- Do not tow 4-wheel drive vehicles with the front or rear wheels on the ground (Type A or Type B) as illustrated. This could result in damage to the drivetrain, or unstable towing. If you tow 4-wheel drive vehicles, use Type C or Type D equipment.
- Even in “AUTO” drive mode, the vehicle cannot be towed with the front or the rear wheels on the ground.

Jacking up a 4-wheel drive vehicle

WARNING

- Do not crank the engine while jacking up the vehicle. The tyre on the ground may turn and the vehicle may roll off the jack.

Braking

All the parts of the brake system are critical to safety. We recommend you to have the vehicle checked at regular intervals according to the service booklet.

CAUTION

- Avoid driving habits that cause heavy braking and never “ride” the brakes by resting your foot on the brake pedal while driving. It causes brake overheating and fade.

Brake system

The service brake is divided into two brake circuits. And your vehicle is equipped with power brakes. If one brake circuit fails, the other is available to stop the vehicle. If you should lose the power assist for some reason, the brakes will still work. In these situations, even if the brake pedal moves down to the very end of its possible stroke or resists being depressed, keep depressing the brake pedal down harder and further than usual; stop driving as soon as possible and have the brake system repaired.

WARNING

- Do not turn off the engine while your vehicle is in motion. If you turn off the engine while driving, the power assistance for the braking system will stop working and your brakes will not work effectively.
- If the power assist is lost or if either brake hydraulic system stops working properly, have your vehicle checked immediately.

Warning lamp

The brake warning lamp illuminates to indicate a fault in the braking system. A warning is also displayed on the multi-information screen. Refer to “Brake warning lamp” on page 5-47 and “Brake warning display” on page 5-50.

When brakes are wet

Check the brake system while driving at a low speed immediately after starting, especially when the brakes are wet, to confirm they work normally.

A film of water can be formed on the brake discs and prevent normal braking after driving in heavy rain or through large puddles, or after the vehicle is washed. If this occurs, dry the brakes out by driving slowly while lightly depressing the brake pedal.

When driving downhill

It is important to take advantage of the engine braking by shifting to a lower shift position while driving on steep downhill roads in order to prevent the brakes from overheating.

WARNING

- Do not leave any objects near the brake pedal or let a floor mat slide under it; doing so could prevent the full pedal stroke that would be necessary in an emergency. Make sure that the pedal can be operated freely at all times. Make sure the floor mat is securely held in place.

Brake pad

- Avoid hard braking situations. New brakes need to be broken-in by moderate use for the first 200 km.
- The disc brakes are provided with a warning device which emits a shrieking metallic sound while braking if the brake pads have reached their wear limit. If you hear this sound, have the brake pads replaced immediately.

WARNING

- Driving with worn brake pads will make it harder to stop, and can cause an accident.

Brake auto hold*

When the vehicle is stopped at traffic signals etc., the vehicle can be held stationary with the brake auto hold system even if you release your foot from the brake pedal.

When the accelerator pedal is depressed, the brakes are released.

WARNING

- Do not overly rely on the brake auto hold system. On a steep slope, depress the brake pedal firmly because the system may not hold the vehicle stationary.

WARNING

- Never leave the vehicle while it is being stopped by the brake auto hold system. When leaving the vehicle, apply the parking brake and move the selector lever to the "P" (Park) position.
- Do not use the brake auto hold system when driving on slippery roads. The system may not hold the vehicle stationary and an accident could occur.

NOTE

- While operating the brake auto hold system, you may hear an operation noise to increase braking force when the system detected the movement of the vehicle. This does not indicate a malfunction.

How to use brake auto hold

To turn on brake auto hold

If the brake auto hold switch is pressed while all of the following conditions are met, the system will change to the standby state and the indication lamp (A) on the switch comes on.

- The ignition switch or the operation mode is in ON.
- The driver's seat belt is fastened.

Brake auto hold*

- The driver's door is closed.

6

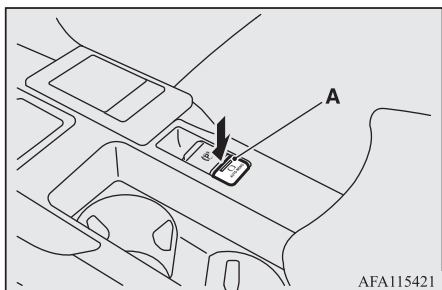

NOTE

- When the brake auto hold system cannot be used, a buzzer will sound and the following warning will appear on the information screen in the multi-information display.
 - If this warning appears, confirm that all of the conditions for system operation are met and that there is no malfunction in the system.



NOTE

- If this warning appears, fasten the driver's seat belt.



- If any of the following occurs while the system is in standby state, the brake auto hold system will be turned off automatically and the indication lamp on the switch goes off. A buzzer will sound and the message will appear on the information screen in the multi-information display.

- When the driver's seat belt is unfastened.
- When the driver's door is opened.
- When there is a malfunction in the system.



NOTE

- If you keep pressing the brake auto hold switch after setting the brake auto hold to ON (Stand by), the brake auto hold will return to OFF as a protection function is operated. After returning to OFF, the brake auto hold will not be switched to ON (stand by) even if the brake auto hold switch is pressed. To set the brake auto hold to ON, restart the engine and press the brake auto hold switch again.

To activate brake auto hold

When the vehicle is stopped by depressing the brake pedal with the selector lever in any position other than "P" (Park) or "R" (Reverse), the brake auto hold activates and the vehicle will be held stationary.

The brake auto hold indication lamp in the instrument cluster will come on while the system activates.

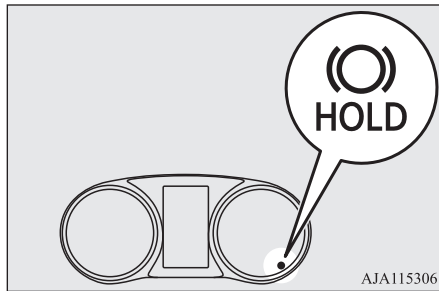

CAUTION

- Release the brake pedal after the brake auto hold indication lamp is illuminated.

NOTE

- In the following situations, the brake auto hold system may not operate temporarily.
 - The vehicle is stopped on a slippery road.
 - The vehicle was stopped while the steering wheel was turned all the way to the left or right.
 - The vehicle is being turned on a parking lot turntable.

If this occurs, the brake auto hold system will return to the normal operation if you depress the accelerator pedal and the vehicle starts moving again.

NOTE

- If the following operation is performed, the brake auto hold will be deactivated and the brake auto hold indication lamp in the instrument cluster goes off.
 - When shifting the selector lever to the “P” (Park) or “R” (Reverse) position with depressing the brake pedal.
 - When the Electric parking brake is applied by using the Electric parking brake switch.
- While the vehicle is held stationary with the brake auto hold system, the Electric parking brake will be automatically applied under the following conditions, and a buzzer will sound and the message will appear on the information screen in the multi-information display.
 - After approximately 10 minutes have elapsed while applying the brake auto hold system.
 - When the driver’s seat belt is unfastened.
 - When the driver’s door is opened.
 - When the ignition switch is turned to the “LOCK” position or the operation mode is put in OFF.

NOTE

- When the system detects the vehicle sliding down a slope.

PARKING BRAKE ENGAGED

If the Electric parking brake cannot be applied automatically due to the system malfunction, the message will appear on the information screen in the multi information display. Depress the brake pedal.

APPLY BRAKE

6

Hill start assist

NOTE

- If the ignition switch is turned to the “LOCK” position or the operation mode is put in OFF with the selector lever in any position other than “P” (Park) position, the message may appear on the information screen in the multi-information display. If the message appears, shift the selector lever to the “P” (Park) position while depressing the brake pedal.



6

To start the vehicle

Depress the acceleration pedal with the selector lever in any position other than “P” (Park) or “N” (Neutral).

The brakes are released, and the brake auto hold indication lamp in the instrument cluster will go off.

To turn off brake auto hold

Press the brake auto hold switch to turn brake auto hold off. The indication lamp on the switch goes off.

If you want to turn off the system while the brake auto hold indication lamp is illuminated, press the switch while depressing the brake pedal.

NOTE

- If the brake auto hold system is turned off without the brake pedal being depressed, a buzzer will sound and the message will appear on the information screen in the multi information display.



Hill start assist

The hill start assist makes it easy to start off on a steep uphill slope by preventing the vehicle from moving backwards. It keeps the braking force for approximately 2 seconds when you move your foot from the brake pedal to the accelerator pedal.

CAUTION

- Do not overly rely on the hill start assist to prevent backwards movement of the vehicle. Under certain circumstances, even when hill start assist is activated, the vehicle may move backwards if the brake pedal is not sufficiently depressed, if the vehicle is heavily loaded, or if the road is very steep or slippery.
- The hill start assist is not designed to keep the vehicle stopped in place on uphill slopes for more than 2 seconds.
- When facing uphill, do not rely on using the hill start assist to maintain a stopped position as an alternative to depressing the brake pedal. Doing so could result in an accident.
- Do not turn the ignition switch to the “LOCK” or “ACC” position or the operation mode in ACC or OFF while the hill start assist is operating. The hill start assist could stop operating, which could result in an accident.

To operate

1. Stop the vehicle completely using the brake pedal.
2. On vehicles equipped with M/T, place the gearshift lever into the 1st position. On vehicles equipped with A/T or CVT, place the selector lever into the “D” position.

NOTE

- When reversing on an uphill slope, place the gearshift lever or the selector lever into the “R” position.

- Release the brake pedal and the hill start assist will maintain the braking force applied while stopped for approximately 2 seconds.
- Depress the accelerator pedal and the hill start assist will gradually decrease the braking force as the vehicle starts moving.

NOTE

- The hill start assist is activated when all of the following conditions are met.
 - The engine is running.
(The hill start assist will not be activated while the engine is starting or immediately after the engine is started.)

NOTE

- On vehicles equipped with M/T, the gearshift lever is in the following position.
[When starting an uphill slope forwards.]
The gearshift lever is in any position other than “R”.
(The hill start assist will operate, even if the gearshift lever is in the “N” position.)
[When starting an uphill slope backwards.]
The gearshift lever is in the “R” position.
(The hill start assist will not operate when the gearshift lever is in the “N” position.)
- On vehicles equipped with A/T or CVT, the selector lever is in any position other than “P” or “N”.
- The vehicle is completely stationary, with the brake pedal depressed.
- The parking brake is released.
- The hill start assist will not operate if the accelerator pedal is depressed before the brake pedal is released.
- The hill start assist also operates when reversing on an uphill slope.

Warning lamp/display

If an abnormal condition occurs in the system, the following warning lamp/display will be shown.

Warning lamp



Warning display



6

CAUTION

- If the warning is displayed, the hill start assist will not operate. Start off carefully.
- Park your vehicle in a safe place and stop the engine.
Restart the engine and check whether the display/indicator goes out, in which case the hill start assist is again working normally.
If they remain displayed or reappear frequently, it is not necessary to stop the vehicle immediately, but the vehicle should be inspected by a MITSUBISHI MOTORS Authorized Service Point as soon as possible.

Brake assist system

The brake assist system is a device assisting drivers who cannot depress the brake pedal firmly when it is necessary to do so (such as in emergency stop situations) and provides greater braking force.

Active Yaw Control (AYC)

If the brake pedal is depressed suddenly, the brakes will be applied with more force than usual.

CAUTION

- The brake assist system is not a device designed to exercise braking force greater than its capacity. Make sure to always keep a sufficient distance between your vehicle and a vehicle in front of you without relying too much on the brake assist system.

6

NOTE

- Once the brake assist system is operational, it maintains great braking force even if the brake pedal is lightly released. To stop its operation, completely remove your foot from the brake pedal.
- The brake assist system may become operational when the brake pedal is fully depressed even if it has not been depressed suddenly.
- When the brake assist system is in use, you may feel as if the depressed brake pedal is soft, the pedal moves in small motions in conjunction with the sound of the ABS operation, or the vehicle body and the steering wheel vibrate. This occurs when the brake assist system is operating normally and does not indicate faulty operation. Continue to firmly depress the brake pedal.

NOTE

- You may hear an operation noise when the brake pedal is depressed suddenly while stationary. This does not indicate a malfunction and the brake assist system is operating normally.
- When the anti-lock brake system warning lamp or only Active Stability Control warning lamp illuminate, the brake assist system is not functioning.

Active Yaw Control (AYC)

The Active Yaw Control (AYC) is a system with a yaw control function, that controls the left-right driving/braking force using the brakes.

Yaw control function

The yaw control function is a function that enhances vehicle cornering performance and vehicle stability with management of vehicle turning power (yaw moment) by controlling the drive power difference of the left and right wheels and the braking force when the vehicle does not turn in response to steering input, such as when the steering wheel is turned quickly or when driving on slippery road.

CAUTION

- Control of the braking force does not enhance the stopping performance of the vehicle, therefore, pay careful attention to the safety of your surroundings when driving.

AYC operation display

The AYC operation status can be displayed on the information screen in the multi-information display.

To display the status, press the multi-information display switch to change the information screen.

Refer to “Information screen (when the ignition switch or the operation mode is ON)” on page 5-05

Yaw control function display

Vehicles with S-AWC

Refer to “S-AWC operation display” on page 6-52.

Vehicles with 2WD

The AYC operation status is displayed.

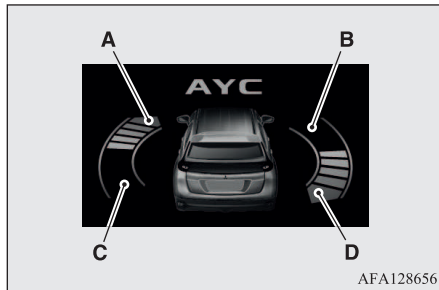

AFA128656

The amount of the yaw moment is displayed as a bar graph.

- A, D- Clockwise yaw moment about the vehicle's centre of gravity
- B, C- Anticlockwise yaw moment about the vehicle's centre of gravity

WARNING

- Always concentrate on your driving first. Keep your eyes and mind on the road. Distractions while driving can lead to an accident.

Emergency stop signal system

This is a device that reduces the possibility of rear end collisions by the rapid and automatic blinking of the hazard warning lamps to alert vehicles approaching from behind during sudden braking. When the emergency stop signal system operates, the hazard warning indication lamp in the instrument cluster blinks rapidly at the same time.

CAUTION

- If the ABS warning or ASC warning is displayed, the emergency stop signal system may not operate. Refer to "ABS warning lamp/display" on page 6-64. Refer to "ASC warning lamp/display" on page 6-68.

NOTE

- [Activating condition for the emergency stop signal system] It activates when all of the following conditions are met.
 - The vehicle speed is approximately 55 km/h (34 mph) or higher.

NOTE

- The brake pedal has been depressed, and the system judges that it was sudden braking from the vehicle deceleration and the operating condition of the anti-lock brake system (ABS).
- [Deactivating condition for the emergency stop signal system]
It deactivates when one of the following conditions is met.
- The brake pedal is released.
 - The hazard warning flasher switch is pressed.
 - The system judges that it was not sudden braking from the vehicle deceleration and the operating condition of the anti-lock brake system (ABS).

6

Anti-lock brake system (ABS)

The anti-lock brake system (ABS) helps prevent the wheels from locking during braking. This helps maintain vehicle drivability and steering wheel handling.

Driving hints

- Always keep a safe distance from the vehicle in front of you. Even if your vehicle is equipped with ABS, leave a greater braking distance when:

Anti-lock brake system (ABS)

6

- Driving on gravel or snow-covered roads.
- Driving with snow traction device (tyre chains) installed.
- Driving on roads where the road surface is pitted or has other differences in surface height.
- Driving on uneven road surfaces.
- Operation of ABS is not restricted to situations where brakes are applied suddenly. This system may also prevent the wheels from locking when you drive over manholes, steel roadwork plates, road markings, or any uneven road surface.
- When the ABS is activated, you may feel the brake pedal pulsation and the vibrations of the vehicle body and steering wheel. It may also feel as if the pedal resists being pressed.
In this situation, simply hold the brake pedal down firmly. Do not pump the brake, which will result in reduced braking performance.
- An operation noise may be emitted from the engine compartment in the following situations. The sound is associated with checking the operations of the ABS. At this time, you may feel a shock from the brake pedal if you depress it. These do not indicate a malfunction.
 - When the ignition switch is set to the “ON” position.

6-64 Starting and driving

- When the vehicle is driven for a while after the engine is turned on.
- The ABS can be used after the vehicle has reached a speed over approximately 10 km/h (6 mph). It stops operating when the vehicle slows below 5 km/h (3 mph).

CAUTION

- The ABS cannot prevent accidents. It is your responsibility to take safety precautions and to drive carefully.
- To prevent failure of the ABS, be sure all four wheels and tyres are the same size and the same type.
- Do not install any aftermarket limited-slip differential (LSD) on your vehicle. The ABS may stop functioning properly.

ABS warning lamp/display

Warning lamp



Warning display



OGKE20E1

If there is a malfunction in the system, the ABS warning lamp will come on and the warning display will appear on the information screen in the multi-information display. Under normal conditions, the ABS warning lamp only comes on when the ignition switch is turned to the “ON” position or the operation mode is put in ON and goes off a few seconds later.

CAUTION

- Any of the following warning lamp/display behaviour indicates that the ABS is not functioning and only the standard brake system is working. (The standard brake system is functioning normally.) If this happens, we recommend you to have your vehicle inspected as soon as possible.
 - When the ignition switch is turned to the “ON” position or the operation mode is put in ON, the warning lamp does not come on or it remains on and does not go off
 - The warning lamp comes on while driving
 - The warning display appears while driving

If the warning lamp/display illuminate while driving

If only the ABS warning lamp/display illuminate

Avoid hard braking and high-speed driving.

Stop the vehicle in a safe place. Restart the engine and check to see whether the lamp goes out after a few minutes driving; if it then remains off during driving, there is no problem. However, if the warning lamp/display do not disappear, or if they come on again when the vehicle is driven, we recommend you to have the vehicle checked.

If the ABS warning lamp/display and brake warning lamp/display illuminate at the same time

Warning lamp



Warning display



The ABS and brake force distribution function may not work, so hard braking could make the vehicle unstable. Avoid hard braking and high-speed driving. Stop the vehicle in a safe place immediately and we recommend you to have the vehicle checked.

NOTE

- The ABS warning lamp and brake warning lamp illuminate at the same time and the warning displays appear alternately on the information screen in the multi-information display.

Electric power steering system (EPS)

After driving on icy roads

After driving on snow or icy roads, remove any snow and ice which may have accumulated around the wheels. When doing this, be careful not to damage the wheel speed sensors (A) and the cables located at each wheel.

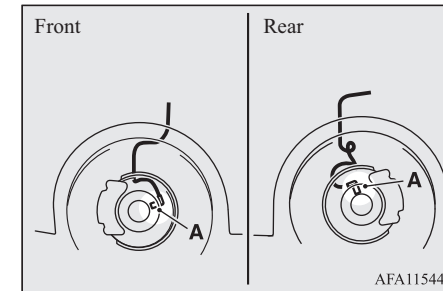

6

Electric power steering system (EPS)

The power steering system operates while the engine is running. It helps reduce the effort needed to turn the steering wheel.

Active stability control (ASC)

The power steering system has mechanical steering capability in case the power assist is lost. If the power assist is lost for some reason, you will still be able to steer your vehicle, but you will notice it takes much more effort to steer. If this happens, have your vehicle inspected at a MITSUBISHI MOTORS Authorized Service Point.

6

WARNING

- Do not stop the engine while the vehicle is moving. Stopping the engine would make the steering wheel extremely hard to turn, possibly resulting in an accident.

NOTE

- During repeated full-lock turning of the steering wheel (for example, while you are manoeuvring the vehicle into a parking space), a protection function may be activated to prevent overheating of the power steering system. This function will make the steering wheel gradually harder to turn. In this event, limit your turning of the steering wheel for a while. When the system has cooled down, the steering action will return to normal.

NOTE

- If you turn the steering wheel while the vehicle is stationary with the headlamps on, the headlamps may become dim. This behaviour is not abnormal. The headlamps will return to their original brightness after a short while.

Electric power steering system warning lamp/display

Warning lamp



Warning display



If there is a malfunction in the system, the warning lamp will come on and the warning display will appear on the information screen in the multi-information display.

Under normal conditions, the warning lamp comes on when the ignition switch is turned to the "ON" position or the operation mode is put in ON, and goes off after the engine has started.

CAUTION

- If the warning lamp comes on and the warning display appears while the engine is running, have the vehicle inspected by a MITSUBISHI MOTORS Authorized Service Point as soon as possible. It may become harder to turn the steering wheel.

Active stability control (ASC)

The Active Stability Control (ASC) takes overall control of the anti-lock brake system, traction control function and stability control function to help maintain the vehicle's control and traction. Please read this section in conjunction with the page on the anti-lock brake system, traction control function and stability control function.

Anti-lock brake system (ABS) → p. 6-63

Traction control function → p. 6-67

Stability control function → p. 6-67

CAUTION

- Do not over-rely on the ASC. Even the ASC cannot prevent the natural laws of physics from acting on the vehicle. This system, like any other system, has limits and cannot help you to maintain traction and control of the vehicle in all circumstances. Reckless driving may lead to accidents. It is the driver's responsibility to drive carefully. This means taking into account the traffic, road and environmental conditions.
- Be sure to use the same specified type and size of tyre on all four wheels. Otherwise, the ASC may not work properly.
- Do not install any aftermarket limited-slip differential (LSD) on your vehicle. The ASC may stop functioning properly.

NOTE

- An operation noise may be emitted from the engine compartment in the following situations. The sound is associated with checking the operations of the ASC. At this time, you may feel a shock from the brake pedal if you depress it. These do not indicate a malfunction.
 - When the ignition switch is set to the "ON" position or the operation mode is put in ON.
 - When the vehicle is driven for a while after the engine is turned on.

NOTE

- When the ASC is activated, you may feel a vibration in the vehicle body or hear a whining sound from the engine compartment. This indicates that the system is operating normally. It does not indicate a malfunction.
- When the anti-lock brake system warning lamp is illuminated, the ASC is not active.

Traction control function

On slippery surfaces, the traction control function prevents the drive wheels from excessive spinning, thus helping the vehicle to start moving from a stopped condition. It also provides sufficient driving force and steering performance as the vehicle turns while pressing the acceleration pedal.

CAUTION

- When driving a vehicle on a snowy or icy road, be sure to install snow tyres and drive the vehicle at moderate speeds.



Stability control function

The stability control function is designed to help the driver maintain control of the vehicle on slippery roads or during rapid steering manoeuvres. It works by controlling the engine output and brake on each wheel.

NOTE

- The stability control function operates at speeds of approximately 15 km/h (9 mph) or higher.

ASC OFF switch

The ASC is automatically activated when the ignition switch is turned to the "ON" position or the operation mode is put in ON. You can deactivate the system by pressing down the ASC OFF switch for 3 seconds or longer. When the ASC is deactivated, the  display/indicator will turn on. To reactivate the ASC, momentarily press the ASC OFF switch; the  indicator is turned off.

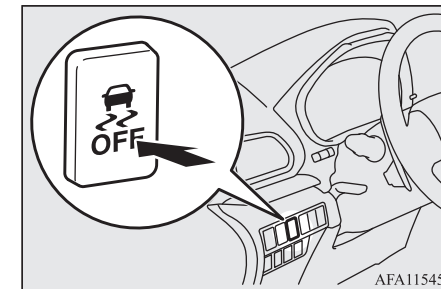
6

AFA115450

Active stability control (ASC)



CAUTION

- For safety reasons, the ASC OFF switch should be operated when your vehicle is stopped.
- Be sure to keep the ASC on while driving in normal circumstances.



NOTE

- When moving out of mud, sand or fresh snow, pressing the accelerator pedal may not allow the engine speed to increase. In such situations, temporarily turning off the ASC with the ASC OFF switch will make it easier to move out your vehicle.
- By pressing the “ASC OFF” switch, both the stability control function and the traction control function are turned OFF.
- If you continue to press the ASC OFF switch after the ASC is turned off, the “mistaken operation protection function” will activate and the ASC will turn back on.



ASC operation indicator or ASC OFF indicator

-  - ASC operation indicator
The indicator will blink when the ASC is operating.
-  - ASC OFF indicator
This indicator will turn on when the ASC is turned off with the ASC OFF switch.

CAUTION

- When  indicator blinks, ASC is operating, which means that the road is slippery or that your vehicle’s wheels are beginning to slip. If this happens, drive slower with less accelerator input.
- If the temperature in the braking system continues to increase due to continuous brake control on a slippery road surface, the  indicator will blink.
To prevent the brake system from overheating, the brake control of the traction control function will be temporarily suspended. The engine control of the traction control function and normal brake operation will not be affected. Park your vehicle in a safe place.
When the temperature in the braking system has come down, the  indicator will be turned off and the traction control function will start operating again.



NOTE

- The  indicator may turn on when you start the engine. This means that the battery voltage momentarily dropped when the engine was started. It does not indicate a malfunction, provided that the indicator goes out immediately.
- When a compact spare tyre has been put on your vehicle, the gripping ability of the tyre will be lower, making it more likely that the  indicator will blink.

ASC warning lamp/display

If an abnormal condition occurs in the system, the following warning lamp/display will turn on.

Warning lamp

-  - ASC operation indicator
-  - ASC OFF indicator

Warning display



CAUTION

- The system may be malfunctioning. Park your vehicle in a safe place and stop the engine. Restart the engine and check whether the lamp/display goes out. If they do not go out or appear frequently, it is not necessary to stop the vehicle immediately, but we recommend you to have your vehicle inspected.

⚠ CAUTION

- When towing the vehicle with only the front wheels or only the rear wheels raised off the ground, do not place the ignition switch in the “ON” position or do not put the operation mode in ON. Placing the ignition switch in the “ON” position or putting the operation mode in ON could cause the ASC to operate, resulting in an accident. Note that the correct towing method depends on the transmission type and the vehicle’s drive configuration. For details, refer to “Towing” on page 8-26.

Cruise control*

Cruise control is an automatic speed control system that keeps a set speed. It can be activated at approximately 30 km/h (20 mph) or more.

⚠ CAUTION

- When you do not wish to drive at a set speed, turn off the cruise control for safety.
- Do not use cruise control when driving conditions will not allow you to stay at the same speed, such as in heavy traffic or on roads that are winding, icy, snow-covered, wet, slippery, on a steep downhill slope.

⚠ CAUTION

- On vehicles with M/T, do not move the gear-shift lever to the “N” (Neutral) position while driving at a set speed without depressing the clutch pedal. The engine will run too fast and might be damaged.

📖 NOTE

- Cruise control may not be able to keep your speed on uphill or downhill.
- Your speed may decrease on a steep uphill. You may use the accelerator pedal if you want to stay at your set speed.
- Your speed may increase to more than the set speed on a steep downhill. You must use the brake to control your speed. As a result, the set speed driving is deactivated.

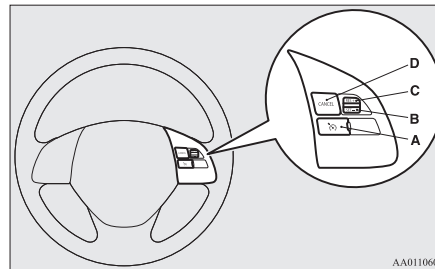
Cruise control switches**A- CRUISE CONTROL ON/OFF switch**

Used to turn on and off the cruise control.

B- “SET -” switch

Used to reduce the set speed and to set the desired speed.

C- “RES +” switch

Used to increase the set speed and to return to the original set speed.

D- “CANCEL” switch

Used to deactivate the set speed driving.

📖 NOTE

- When operating the cruise control switches, press the cruise control switches correctly. The set speed driving may be deactivated automatically if two or more switches of the cruise control are pressed at the same time.

Cruise control*

To activate

1. With the ignition switch in the “ON” position or the operation mode in ON, press the CRUISE CONTROL ON/OFF switch (A) to turn on the cruise control. The indicator display appears on the information screen of the multi-information display.

6

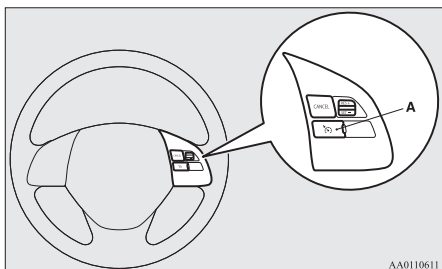

2. Accelerate or decelerate to your desired speed, then push down and release the “SET -” switch (B) when the indicator display appears on the information screen of the multi-information display. The vehicle will then maintain the desired speed. The “SET” indicator appears on the information screen of the multi-information display.

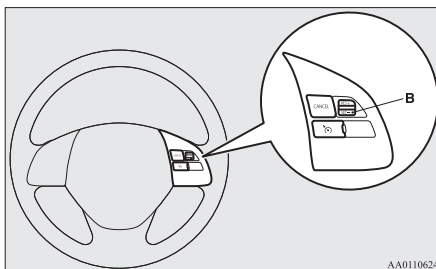

NOTE

- When you release the “SET -” switch (B), the vehicle speed will be set.

To increase the set speed

There are two ways to increase the set speed.

RES + switch

Push up and hold the “RES +” switch (C) while driving at the set speed, and your speed will then gradually increase.

When you reach your desired speed, release the switch. Your new cruising speed is now set.

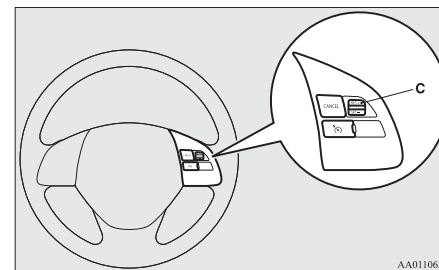

To increase your speed in small amounts, push up the “RES +” switch (C) for less than approximately 1 second and release it.

Each time you push up the “RES +” switch (C), your vehicle will go approximately 1.6 km/h (1 mph) faster.

Accelerator pedal

While driving at the set speed, use the accelerator pedal to reach your desired speed and then push down the “SET -” switch (B) and release the switch momentarily to set a new desired cruising speed.

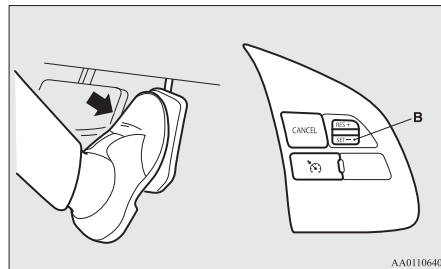

To decrease the set speed

There are two ways to decrease the set speed.

SET - switch

Push down and hold the “SET -” switch (B) while driving at the set speed, and your speed will slow down gradually.

When you reach your desired speed, release the switch. Your new cruising speed is now set.

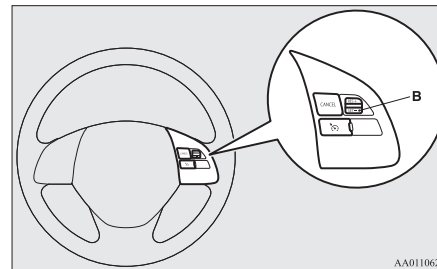

To slow down your speed in small amounts, push down the “SET -” switch (B) for less than approximately 1 second and release it. Each time you push down the “SET -” switch (B), your vehicle will slow down by approximately 1.6 km/h (1 mph).

Brake pedal

While driving at the set speed, use the brake pedal, which disengages the cruise control, then push down the “SET -” switch (B) and release the switch momentarily to set a new desired cruising speed.

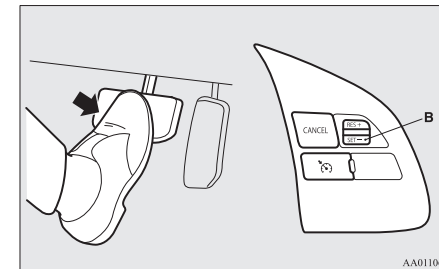

6

Cruise control*

To temporarily increase or decrease the speed

To temporarily increase the speed

Depress the accelerator pedal as you would normally. When you release the pedal, you will return to your set speed.

6

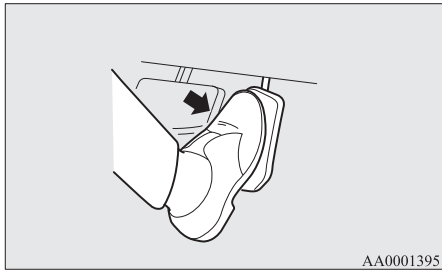

NOTE

- In some driving conditions, the set speed driving may be deactivated. If this happens, refer to “To activate” on page 6-70 and repeat the speed setting procedure.

To temporarily decrease the speed

Depress the brake pedal to decrease the speed. To return to the previously set speed, push up the “RES +” switch (C).

6-72 Starting and driving

Refer to “To resume the set speed” on page 6-73.

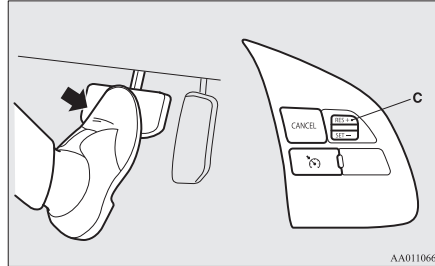

To deactivate

The set speed driving can be deactivated as follows:

- Press the CRUISE CONTROL ON/OFF switch (A) (Cruise control will be turned off.)
- Press the “CANCEL” switch (D).
- Depress the brake pedal.

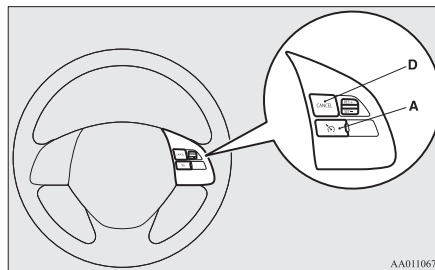

OGKE20E1

The set speed driving is deactivated automatically in any of the following ways.

- When you depress the clutch pedal (on vehicles equipped with M/T).
- When your speed slows to approximately 15 km/h (10 mph) or more below the set speed because of a hill, etc.
- When your speed slows to approximately 30 km/h (20 mph) or less.
- When the Active Stability Control (ASC) starts operating. Refer to “Active stability control (ASC)” on page 6-66.

WARNING

- On vehicles equipped with A/T or CVT, although the set speed driving will be deactivated when shifting to the “N” (Neutral) position, never move the selector lever to the “N” (Neutral) position while driving. You would have no engine braking and could cause a serious accident.

Also, the set speed driving may be deactivated as follows:

- When the engine speed rises and approaches the tachometer’s red zone (the red-coloured part of the tachometer dial).

CAUTION

- When the set speed driving is deactivated automatically in any situation other than those listed above, there may be a system malfunction.
Press the CRUISE CONTROL ON/OFF switch to turn off the cruise control and have your vehicle inspected by a MITSUBISHI MOTORS Authorized Service Point.

To resume the set speed

If the set driving speed is deactivated by the condition described in “To deactivate” on page 6-72, you can resume the previously set speed by pushing up the “RES +” switch (C) while driving at a speed of approximately 30 km/h (20 mph) or higher. The “SET” indicator appears on the information screen of the multi-information display.

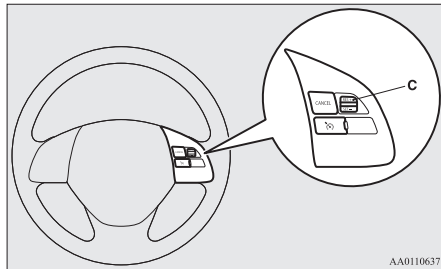

Under either of the following conditions, however, using the switch does not allow you to resume the previously set speed. In these situations, repeat the speed setting procedure:

- The CRUISE CONTROL ON/OFF switch is pressed.
- The ignition switch is turned to the “LOCK” position or the operation mode is put in OFF.
- Indication lamp goes off.

Speed Limiter*

The Speed Limiter is a driver assist function to prevent from exceeding the speed set by driver while engine power control.

CAUTION

- Because the system does not use service brake (hydraulic brake), the vehicle speed may exceed the set speed on the downhill.
If a driver wants to keep the vehicle speed in such a situation, he/she must put on a service brake or downshift.

NOTE

- If the clutch pedal (M/T) is depressed, the Speed Limiter does not activate.

If the vehicle speed exceeds the set speed (approximately 3 km/h (2 mph)), the indicator will blink in the combination meter.

If the vehicle speed exceeds the set speed approximately +3 km/h (+2 mph) more than approximately 5 seconds after indicated alert message, beep alert is sounded for approximately 10 seconds at the most.

While running without alert message, if you decrease the set speed and vehicle speed is more than set speed approximately +3 km/h (+2 mph), alert message is displayed but beep alert is delayed.

In this case, when vehicle speed keeps exceeding set speed approximately +3 km/h (2 mph) for approximately 30 seconds after the alert message is appeared, beep alert is sounded for approximately 10 seconds at the most.

If the vehicle speeds decreases less than set speeds after the alert message is appeared, the message is disappeared. When beep alert is sounding, the beep alert also goes off.

Speed Limiter*

NOTE

- However, this gives priority to audio and visual signal of safety reasons or driver's demand.
- If the set speed is too lower based on current shift position, the Speed Limiter may not limit the vehicle speed to prevent engine stall.

6 Speed Limiter control switches

There are four switches which relate to the Speed Limiter on the steering wheel.

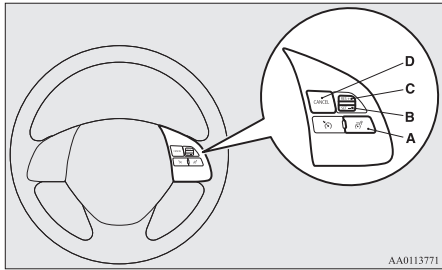

A- SPEED LIMITER ON/OFF switch

To turn on/off the Speed Limiter.

B- "SET -" switch

To set the current vehicle speed to a set speed decrease the set speed.

C- "RES +" switch

To resume the Speed Limiter with set speed memorized or increase the set speed.

D- "CANCEL" switch

To cancel the Speed Limiter.

NOTE

- Press the switch one by one.
- The Speed Limiter may be cancelled automatically, if two or more switches are pressed at the same time.

Speed Limiter information on the multi information display area

The Speed Limiter information is displayed on the multi information display area in the combination meter.

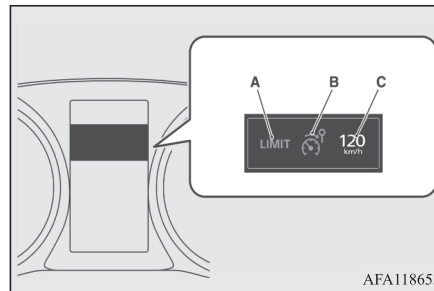

A- Control state

There are three control states as below.

LIMIT OFF

When the Speed Limiter is in STANDBY, the vehicle speed can exceed the set speed.

LIMIT

When the Speed Limiter is in operation. The vehicle is controlled in order not to exceed the set speed.

OVER LIMIT

When the vehicle speed is exceeding the set speed by more than approximately 3 km/h (2 km/h).

B- SPEED LIMITER ON indication

When the Speed Limiter is started up, the Speed Limiter's symbol is appeared.

C- Set speed

Set speed is appeared if it is stored.

To start up

First of all, press the ON/OFF switch in order to power up the Speed Limiter when the ignition switch in the "ON", position or the operation mode in ON,

The Speed Limiter indication will be appeared in the combination meter.



To activate

Accelerate or decelerate to your desired speed, and push down the “SET -” switch (B). The Speed Limiter memorizes the current vehicle speed when you release the “SET -” switch (B). Now, the Speed Limiter starts controlling in order not to exceed the set speed.

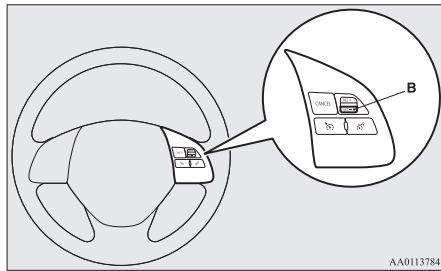

If the current vehicle speed is lower than approximately 30 km/h (20 mph) (settable minimum speed), the set speed is set at approximately 30 km/h (20 mph).

The set speed is displayed in the combination meter.

And, control state “LIMIT” is displayed in the combination meter.



To increase the set speed

By using the RES + switch

Push up the “RES +” switch continuously.

Then the set speed displayed in the combination meter is gradually increased.

If the set speed reaches your desired speed, release the “RES +” switch (C).

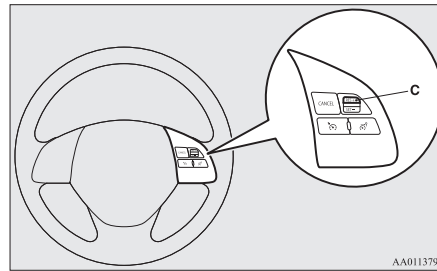

The set speed is increased each approximately 5 km/h (3 mph) per approximately 0.5 second.

If a driver wants to increase the set speed a little, push up “RES +” switch for less than approximately 0.5 second and release it.

The set speed is increased 1 km/h (1 mph) each taps.

By using the CANCEL switch, the accelerator pedal and the SET - switch

Press the “CANCEL” switch (D) to deactivate the Speed Limiter.

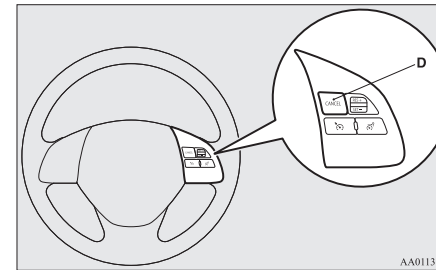

6

Control state “LIMIT” is disappeared and change control state “LIMIT OFF” in the combination meter.



Speed Limiter*

Accelerate to driver's desired vehicle speed and push down SET - switch (B) and release.

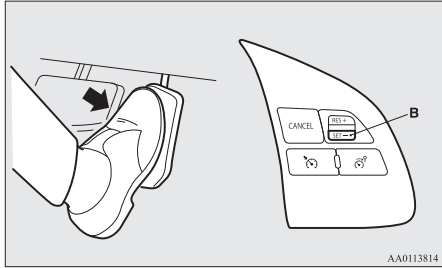

6

Control state "LIMIT" is displayed again and the set speed is updated.

To decrease the set speed

By using the SET - switch

Push down the "SET -" switch (B).

Then the set speed displayed in the combination meter is gradually decreased.

If the set speed reaches to your desired speed, release the "SET -" switch (B).

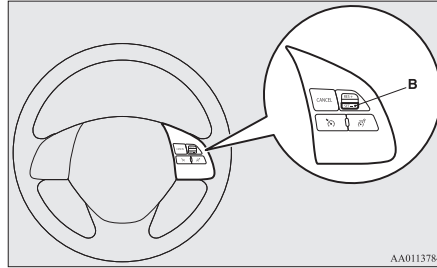

The set speed decreases approximately 5 km/h (3 mph) per approximately 0.5 second.

If a driver wants to decrease the set speed a little, press the "SET -" switch (B) for less than approximately 0.5 second and release it. The set speed is decreased 1 km/h (1 mph) each taps.

By using the CANCEL switch, the service brake and the SET - switch

Press the "CANCEL" switch (D) to deactivate the Speed Limiter.

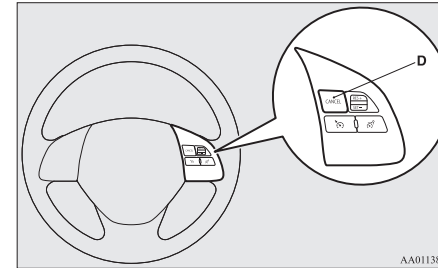

Control state "LIMIT" is disappeared and change control state "LIMIT OFF" in the combination meter.



Decelerate to driver's desired speed and push down SET - switch (B) and release.

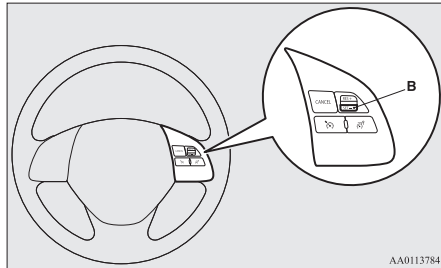

The Speed Limiter indication is displayed again and the set speed is updated.

To increase the vehicle speed temporarily

A driver can temporarily accelerate for emergency use.

The Speed Limiter is temporarily deactivated, and the vehicle speed can be increased.

The Speed Limiter will resume when the vehicle speed goes down to enough less than the set speed.

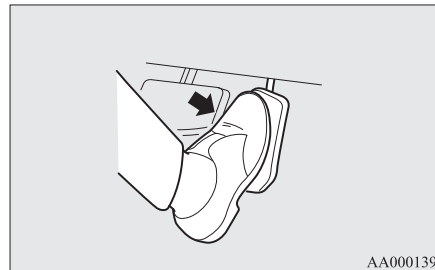

Put on an accelerator pedal to the pedal stroke end. (over a detent that makes pedal reaction force bigger before pedal stroke end)

CAUTION

- There is a possibility for the Speed Limiter to allow abrupt acceleration corresponding to accelerator pedal position. So be careful of the abrupt acceleration.

If the vehicle speed exceeds the set speed by approximately +3 km/h (2 mph), alert messages appear in the combination meter.



CAUTION

- Be careful about over speed.

NOTE

- A driver can change the set speed during this emergency use.

To deactivate

Use whichever following ways to deactivate.

- Press CANCEL switch
- Press the Speed Limiter ON/OFF switch
- If CRUISE CONTROL ON/OFF switch or ACC ON/OFF switch is pressed, the Speed Limiter will be cancelled.

NOTE

- If the Speed Limiter is cancelled by other states, it may be a system malfunction. Stop using the Speed Limiter and turn off the Speed Limiter. Have your vehicle inspected by a MITSUBISHI MOTORS Service Point.

Adaptive Cruise Control System (ACC)*

⚠ CAUTION

- There is a possibility for the Speed Limiter to allow abrupt acceleration corresponding to accelerator pedal position when the Speed Limiter is deactivated. Be careful.

To resume

6

The Speed Limiter memorizes the set speed when system has been deactivated, the Speed Limiter can resume by push up the RES + switch (C).

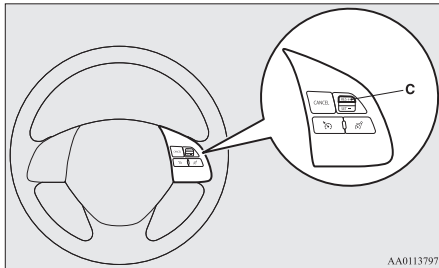

However, the Speed Limiter immediately starts controlling and the vehicle decreases as if an accelerator pedal is closed fully, when the vehicle speed is higher than the set speed.

⚠ CAUTION

- There is a possibility to occur jerk, depending on a running resistance. Be careful.

Adaptive Cruise Control System (ACC)*

The Adaptive Cruise Control System (ACC) maintains a set speed with no need for you to use the accelerator pedal. Using a sensor (A), the system also measures the relative speed and distance between your vehicle and a vehicle in front, and maintains a set following distance between your vehicle and the vehicle in front by automatically decelerating your vehicle if it becomes too close to the vehicle in front.

The ACC is the driver assist system to aid comfortable driving on a freeway. Stop lamps are illuminated during automatic braking.

If you desire, a cruise control without intervention of the following distance control is also selectable.

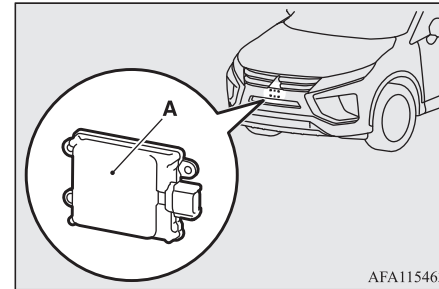

⚠ WARNING

- A driver is responsible for driving safely. Even if the ACC is in use, always grasp the surrounding circumstances and provide for safe driving.
- Never rely solely on the ACC. The ACC is the system to reduce load on the driver. The ACC is not a collision avoidance system or an automatic driving system. The system is not intended to compensate for driver's loss of attention to the front during driving due to distraction or carelessness or supplement a drop in visibility due to the rain and fog. It is never a substitute for your safe and careful driving. Always be ready to apply the brakes manually.

⚠ WARNING

- This system may not correctly detect the actual situation depending on the type of vehicle in front and its conditions, the weather conditions, and the road conditions. Additionally, the system may be unable to decelerate sufficiently if the vehicle in front applies the brakes suddenly or another vehicle cuts into your path, so your vehicle approaches the front vehicle. Improper usage of this system or loss of attention to the front by the over-rely on the ACC, may result in a serious accident.

⚠ CAUTION

- In the following situations, the system may become transiently unable to detect a vehicle in front or triggers its control and alarm functions by detecting something other than a vehicle in front.

⚠ CAUTION

- When driving in curved sections of road including their entrance/outlet or running beside a closed lane in a traffic work or similar zone.

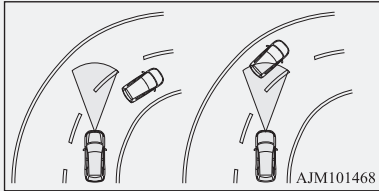

- When your vehicle position in a lane is unstable, is frequently steered to right and left, or running unstably due to a traffic accident, trouble with some vehicles, etc.
- When driving on the road that the vehicle in front runs in offset position from your vehicle.

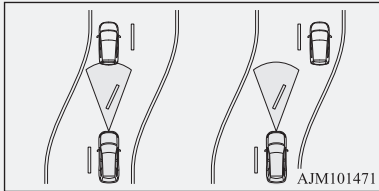

- Never use the ACC in any of the following situations. Failure to follow this instruction could lead to an accident.
 - On roads with heavy traffic or roads including many windings or steep curves.

⚠ CAUTION

- On roads with slippery surfaces, such as frozen, snow-covered, and dirt roads
- Under adverse weather conditions (rain, snow, sand storms, etc.)
- On steep downslopes
- On roads including steep up and down slopes or many changes in inclination
- In traffic requiring frequent acceleration and deceleration
- When the proximity alarm sounds frequently
- When your vehicle is towed or your vehicle tows another vehicle.
- When your vehicle is on a chassis dynamometer or free rollers.
- When the air pressure in the tyres is not correct.
- When installing the spare tyre for emergency.
- When snow traction device (tyre chains) are attached.
- Be sure to take the following precautions to keep the system in good operating conditions. Improper handling of the system components may result in degraded sensor performance.
 - Avoid application of strong shock loads to the sensor and never tamper with or remove the sensor mounting screws.
 - The cover in front of the sensor and the sensor should be kept clean.

Adaptive Cruise Control System (ACC)*

⚠ CAUTION

- Do not cover the sensor mounted area (shaded area as shown in the illustration) with a sticker, licence plate or anything such as a grill guard, etc.

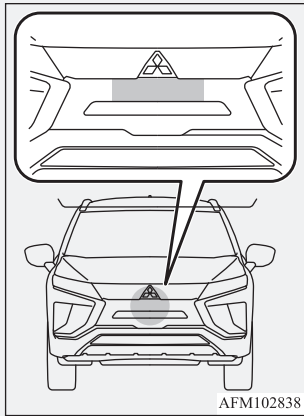

- The sensor front cover should not be modified or painted.
- Avoid using different size tyres from those specified and maintain even tyre wear.
- Do not modify the suspension of your vehicle.
- When the cover in front of the sensor or the sensor itself is deformed by an accident, please do not use the ACC and contact a MITSUBISHI MOTORS Authorized Service Point.

When ACC detects no vehicle in front within the set distance

Your vehicle runs at a speed to which you set. It is possible to set the speed between approximately 30 to 180 km/h (20 to 110 mph).

📖 NOTE

- If the vehicle speed exceed the set speed on down slope, the system automatically applies the brake to maintain the vehicle speed.
- When depressing the brake pedal while automatic brake is applied, the brake pedal is felt solidly, but it is not abnormal. You can more depress the pedal and it provides greater braking force.
- Sound is heard while automatic brake, but it is operated a brake control and not abnormal.

When ACC detects a vehicle in front within the set distance

The ACC makes control to maintain a following distance (time gap) matched with the vehicle speed between your vehicle and a vehicle in front while also activating brakes as necessary.



If the vehicle in front stops, the ACC reacts to it by stopping your vehicle.

When the ACC system enters the stationary vehicle hold state after the vehicle stops, "HOLD" appears.



While the ACC system is in the stationary vehicle hold state, if it is possible to resume following the vehicle in front because it has started moving, "ACC READY TO RESUME" will appear on the information screen of the multi-information display. To start moving again, press the switch or depress the accelerator pedal.

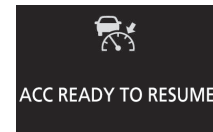

⚠ WARNING

- Never leave your vehicle while the ACC system is in the stationary vehicle hold state. When leaving the vehicle, apply the parking brake and move the selector lever to the "P" (Park) position.

NOTE

- When the ACC system is in the stationary vehicle hold state, the stop lamps will illuminate.
- While the ACC system is in the stationary vehicle hold state, the vehicle will not start moving again unless you press the switch or depress the accelerator pedal.
- If the turn-signal lever is operated while the ACC is active, the system may accelerate the vehicle to assist you in passing a vehicle in front.
- If the vehicle in front starts moving within 2 seconds after stopping, your vehicle will start moving.
While the ACC system is in the stationary vehicle hold state, the Auto Stop & Go (AS&G) system (if so equipped) will operate if the operation conditions are met even if you do not depress the brake pedal.
Refer to "Auto Stop & Go (AS&G) system*" on page 6-30.

When the ACC no longer detects any vehicle in front, a buzzer sounds and the symbol of vehicle running ahead disappears from the screen. The vehicle is slowly accelerated to resume the set speed and continues running at that speed.



WARNING

- **Your vehicle may accelerate up to the set speed in the following situations. Apply the brake, if necessary, to slow down.**
 - **When your vehicle no longer follows the vehicle in front, e.g. at a freeway exit or when your vehicle or the vehicle in front changes its lane.**

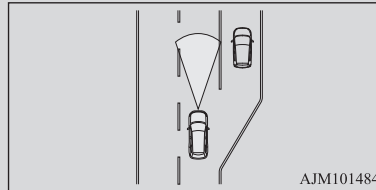

AJM101484

- **When driving on a curve**

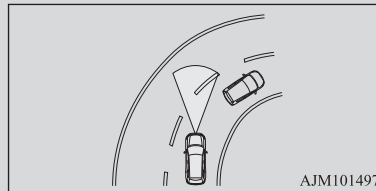

AJM101497

- **If the vehicle in front turns off or changes lane and another stationary vehicle is located in front of that vehicle, the ACC will not make deceleration control to the stationary vehicle.**

Adaptive Cruise Control System (ACC)*

Proximity alarm

While the ACC is active, if your vehicle approaches too closely to a vehicle in front because the ACC cannot allow for an adequate deceleration in such cases as rapid deceleration of the vehicle in front or apparition of a vehicle cutting in front of your vehicle, the ACC gives a warning by sounding a buzzer and displaying a message.

If this happens, increase the following distance by depressing the brake pedal or making other decelerating control.

6

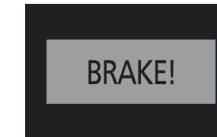

CAUTION

- When the ACC is not in use, turn off the system to prevent it from operating by mistake and an unexpected accident.
- Never operate the ACC from outside the vehicle.
- Neither control nor a warning are performed in the following situation.
 - Something other than a vehicle approaches, such as a pedestrian.

Adaptive Cruise Control System (ACC)*

CAUTION

- When there is an abnormality in the system (When the ACC detects an abnormality, “ACC SERVICE REQUIRED” is indicated.)
- The ACC makes neither acceleration nor deceleration control and only issues warning in the following situation.
 - The vehicle in front is in a park or moving at an extremely slow speed.
- The ACC may not be able to maintain the set speed or the distance to a vehicle in front and may not alert the driver, if the system cannot detect the vehicle in front properly, in the following situations.
 - When a vehicle cuts in front of your vehicle very closely.
 - When a vehicle in front is offset to the left or right.
 - When a vehicle in front is towing a trailer.
 - The vehicle in front is moving at a speed much lower than your vehicle’s.
 - A motorcycle or a bicycle.
 - A freight trailer that is not carrying a container.
 - The vehicle has a protruding load from the carrier.
 - The vehicle has a low vehicle height.
 - The vehicle has an extremely high ground clearance.
 - When there is repeated steep uphill and downhill driving.
 - When driving on an irregular or uneven road surface.

6

CAUTION

- When being driven in a tunnel.
- When you are carrying extremely heavy loads in the rear seats or luggage area.
- After the engine starting for a while.
- When driving in curved sections of road including their entrance/outlet or running beside a closed lane in a traffic work or similar zone.
- When the cover part in front of the sensor and the sensor become dirty or have snow and ice* adhering to it.
- When water, snow or sand on the road are extorted by the vehicle in front or an oncoming vehicle*.
*: After the ACC control has been cancelled automatically due to detection of a state of decline in performance, the ACC will not operate in the temporary condition and will inform the driver by buzzer and indication. When the ACC is in the state in which it can operate, indication is cancelled.
Should indications not be cancelled, then there is a possible abnormality in the system.
Please contact a MITSUBISHI MOTORS Authorized Service Point.

Cruise control switch

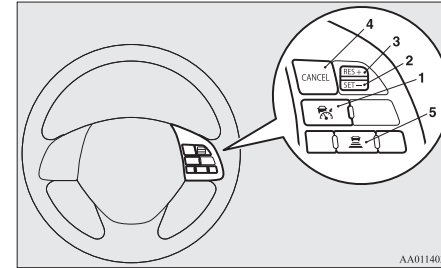

1- ACC ON/OFF switch

Used to turn on and off ACC or the cruise control function.

2- “SET -” switch

Used to set a desired speed and to reduce the set speed.

3- “RES +” switch

Used to make ACC operate at the originally set speed and also to increase the set speed.

4- “CANCEL” switch

Used to cancel the control function of ACC or the cruise control.

5- ACC distance switch

Used to change the setting of the following distance between your vehicle and a vehicle in front.

Adaptive Cruise Control System (ACC)*

NOTE

- Operate the individual switches correctly and one after another.
The ACC may be turned off or its control function may be cancelled if two or more switches are pressed concurrently.

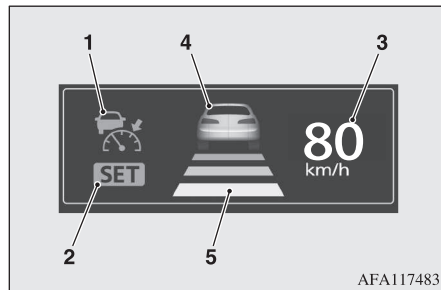

Driving aid display



- 1- ACC indicator:**
Indicates that the ACC is ON.
- 2- Control state indicator:**
Indicates that the ACC is active.
Two types of indication: “SET” and “HOLD” (stationary vehicle hold state)
- 3- Set speed:**
Indicates the target speed.





4- Vehicles in front symbol:





Comes on when the ACC detects a vehicle ahead. Two types of indication: “Stand by” and “Active”

Display	State	
	Stand by	Active
Vehicle in front detected		

5- Following distance setting symbol:

Indicates the set following distance. Two types of indication: “Stand by” and “Active”

State	Stand by	Active
		
		

State	
Stand by	Active
	
	

6

How to use ACC

To start up (place in standby state) the system

With the ignition switch or operation mode set to “ON”, press ACC ON/OFF switch shortly to activate the ACC.

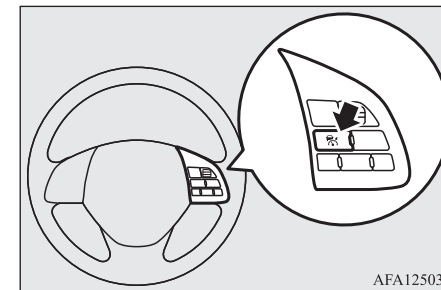

Adaptive Cruise Control System (ACC)*

The display on the information screen of the multi-information display will switch to show information on the ACC.

When the ACC is activated, it is placed in the standby state at which any control function is not started.



6

NOTE

- Even if the ACC is in the activated state when the ignition switch is turned to the “LOCK” position or the operation mode is set to OFF, the system does not automatically become activated when the ignition switch or operation mode is set to “ON” next time.

To activate ACC control

With the ACC turned on (in the standby state), push down the “SET -” switch while driving.

When your desired speed is reached, release the “SET -” switch; then this speed is set and the ACC initiates the speed control to the set speed.

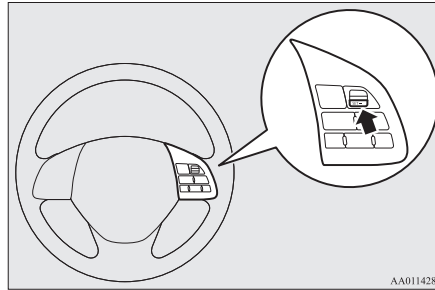

The set speed is indicated on the information screen of the multi-information display.

The ACC can be selected between approximately 30 to 180 km/h (20 to 110 mph).

You can set and initiate the speed control when driving at approximately 0 to 30 km/h (0 to 20 mph) while a vehicle in front is being detected. In this case, the target speed is set to 30 km/h (20 mph).

Setting to any speed outside this range does not cause the ACC to start the control.

When the ACC is initialized, the “SET” indicator lights up on the screen. At the same time, the display showing the following distance setting and the running-ahead vehicle symbol (only when the ACC is detecting a vehicle in front) is switched to the in-control mode display.



While the ACC system is turned on (in the standby state), if you push down the “SET -” switch when a vehicle in front is detected while your vehicle is stopped and you are depressing the brake pedal, “HOLD” will appear and the vehicle speed will be set to 30 km/h (20 mph).



NOTE

- The ACC cannot start the control when any of the following conditions is present. You are alerted to this state by a sounding buzzer.
 - When the vehicle speed is more than 180 km/h (110 mph).

Adaptive Cruise Control System (ACC)*

NOTE

- When the vehicle is running at a speed between approximately 0 to 30 km/h (0 to 20 mph) and the ACC is not detecting any vehicle in front.
- When the ASC is in the OFF state.
- When ABS, ASC or TCL is working.
- When the selector lever is in the “P” (PARK), the “R” (REVERSE) or the “N” (NEUTRAL) position.
- While the brake pedal is being depressed (only while the vehicle is moving).
- When the parking brake is applied.
- When the system determines that its performance has been degraded due to contaminants adhered to the sensor.
- When there is any abnormality in the system.
- When the driver’s seat belt is unfastened.
- When the driver’s door is opened.
- When the vehicle is stopped on a steep slope.

To increase the set speed

There are two ways to increase the set speed.

By using the “RES +” switch:

The set speed increases by 1 km/h (1 mph) every time you push up the “RES +” switch while the ACC control is working. If you hold the switch pushed up, the set speed increases in 5 km/h (3 mph) increments.

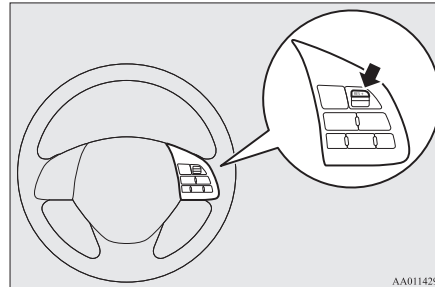

NOTE

- There is some time lag between the setting to a new speed and actually accelerating to that speed.
- Speed setting operation is possible even in presence of a vehicle in front. In this case, however, the set speed alone increases without actual acceleration taking place.
- While the ACC system is in the stationary vehicle hold state, the vehicle speed cannot be set.

CAUTION

- The setting speed should be set up the suitable speed according to a situation.

By using the accelerator pedal:

When the accelerator pedal is depressed while driving with the ACC control working, you can accelerate the vehicle temporarily beyond the presently set speed.

At the point where the vehicle speed is raised to your desired speed, push down and release the “SET -” switch; the new speed is then set in the system.

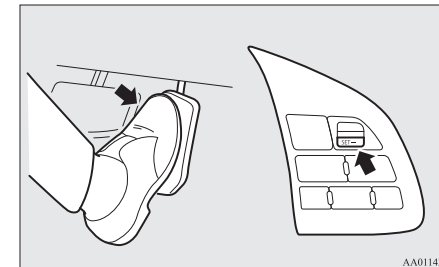

CAUTION

- The ACC braking control and proximity alarm functions will not work while the accelerator pedal is depressed.

6

Adaptive Cruise Control System (ACC)*

NOTE

- The set speed indication on the display turns to “---” when the accelerator pedal is depressed. This indication remains as long as the pedal is in a depressed position.
- The ACC control at the original set speed resumes as soon as you release the accelerator pedal. Under certain conditions, however, the braking control and alarming functions of the ACC may not work for a short while after releasing the accelerator pedal.
- Set speed adjustment is impossible while the accelerator pedal is in a depressed position.

6

To decrease the set speed

There are two ways to decrease the set speed.

By using the “SET -” switch:

The set speed decreases by 1 km/h (1 mph) every time you push down the “SET -” switch while the ACC control is working. If you hold the switch pushed down, the set speed decreases in increments of 5 km/h (3 mph).

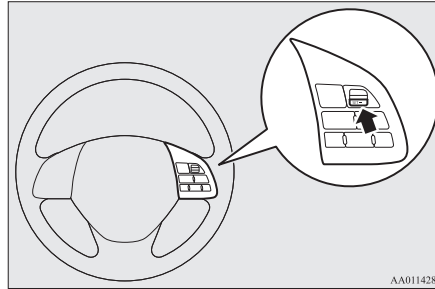

NOTE

- There is some time lag between the setting to a new speed and actually decelerating to that speed.
- If there is a vehicle in front and your vehicle is following that vehicle at a speed lower than the set speed, the set speed alone decreases with no actual deceleration taking place.
- While the ACC system is in the stationary vehicle hold state, the vehicle speed cannot be set.

CAUTION

- The setting speed should be set up the suitable speed according to a situation.

By using the brake pedal:

If you depress the brake pedal while the ACC control is working, the control is cancelled, allowing you to decelerate the vehicle.

At the point where the vehicle slows down to your desired speed, push down the “SET -” switch; the new speed is then set in the system.

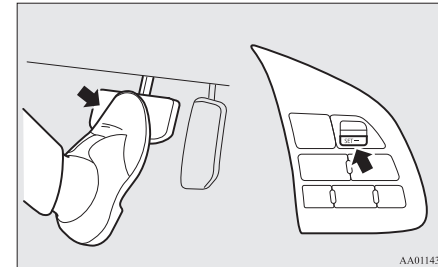

NOTE

- The ACC control is cancelled if you depress the brake pedal and the ACC control does not resume even when you release the pedal.

To temporarily accelerate the vehicle

Simply depress the accelerator pedal to temporarily accelerate the vehicle. Release the pedal to restart the ACC control.

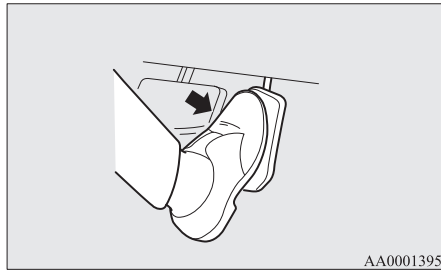

CAUTION

- The ACC braking control and proximity alarm functions will not work while the accelerator pedal is depressed.
- The setting speed should be set up the suitable speed according to a situation.

NOTE

- The set speed indication on the display turns to “---” when the accelerator pedal is depressed. This indication remains as long as the pedal is in a depressed position.

NOTE

- In certain conditions, the braking control and alarming functions of the ACC may not work for a short while after releasing the accelerator pedal.
- Set speed adjustment is impossible while the accelerator pedal is in a depressed position.

To terminate ACC control

To cancel of ACC control

You can cancel the ACC control by using either of the methods below.

When the control is cancelled, the system is placed in the standby state. You can make the system restart the control by using the “SET -” or “RES +” switch if the conditions for activating the control are met.

- Press the “CANCEL” switch.

Adaptive Cruise Control System (ACC)*

- Depress the brake pedal (except for the stationary vehicle hold state).

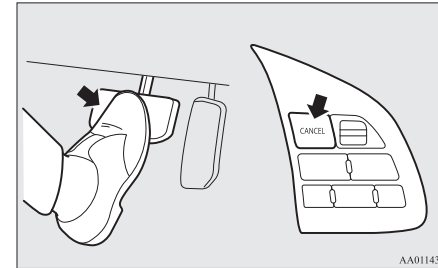

6

NOTE

- You can also cancel the ACC control by pressing the ACC ON/OFF switch. If this switch is pressed, the ACC is turned off.
- If you press the “CANCEL” switch or ACC ON/OFF switch to cancel the stationary vehicle hold state, the vehicle will start creeping.

When the system shifts into the standby state as a result of cancellation of the ACC control, the “SET” indicator goes out. At the same time, the display of the following distance setting and running-ahead vehicle symbol (only when the ACC is detecting a vehicle) is placed in the standby state of display.

Adaptive Cruise Control System (ACC)*



The ACC control is automatically cancelled and the ACC is placed in the standby state in any of the situations listed below; you are alerted to this condition by the sound of a buzzer and a message on the information screen of the multi-information display. You can make the system restart the control by using the “SET -” or “RES +” switch if the conditions for resuming the control are reestablished.

6

If the ACC system is in the stationary vehicle hold state, the Electric parking brake will operate.



- When ASC is turned off.
- When ABS, ASC or TCL is in operation.
- When the parking brake is applied.

- When the selector lever is in the “P” (PARK), the “R” (REVERSE) or the “N” (NEUTRAL) position.
- When the driver’s seat belt is unfastened.
- When the driver’s door is opened.
- When the ACC no longer detects any vehicle in front while it is in the stationary vehicle hold state.
- When the vehicle is in the stationary vehicle hold state for 10 minutes or more.
- When the system detects the vehicle sliding down a slope while the vehicle is in the stationary vehicle hold state.

If the ACC system judges that the stationary vehicle hold state can no longer be maintained on a steep slope after your vehicle stops when the vehicle in front stops, the stationary vehicle hold state is cancelled and a warning appears on the information screen of the multi-information display.

Depress the brake pedal.

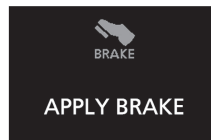

WARNING

- Although the set speed driving will be deactivated when shifting to the “N” (Neutral) position, never move the selector lever to the “N” (Neutral) position while engine braking and could cause a serious accident.

If the detection performance of the ACC system has degraded, such as in the following situations, or if the ACC system judges that it can temporarily not operate, the ACC system operation will be cancelled automatically, and then a buzzer will sound and a message will appear to inform the driver.



This can occur when:

- The brake system is overheating due to continuous brake control on long downhill slope.



This can occur when:

- There are adverse weather conditions, such as rain, snow or sand storms, etc.
- Foreign objects, such as dirt, snow or ice, adhere to the surface of the sensor.
- A vehicle in front or an oncoming vehicle is splashing water, snow or dirt.
- Driving on a nonbusy road with a few vehicles and obstacles in front.

If the display keeps showing the message, there is a possibility that the ACC has a malfunction. Contact a MITSUBISHI MOTORS Authorized Service Point.

When the ACC system detects an abnormality in the system, the ACC system will be turned off, a buzzer will sound and a message will be displayed in the multi-information display.

If the message remains after the ignition switch is turned to the "LOCK" position and then turned back to "ON" position or the operation mode is put in OFF, and then turned back to ON, contact a MITSUBISHI MOTORS Authorized Service Point.



To turn off ACC

Press the ACC ON/OFF switch when the ACC is in the ON state to turn off the ACC.

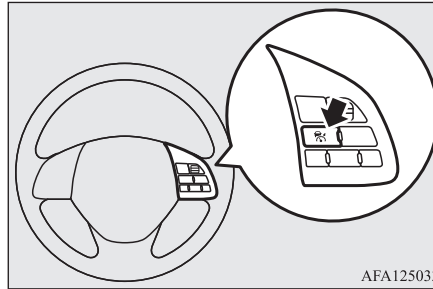

NOTE

- Pressing the switch turns off the ACC even if it is engaged.
- The set speed is cancelled when the ACC is turned off or the ignition switch is turned to the "LOCK" position or operation mode is set to OFF.
- If the ACC is in the ON state when the ignition switch is turned to the "LOCK" position or operation mode is set to OFF, the system is set to the OFF state when the ignition switch or operation mode is set to ON next time.

OGKE20E1

Adaptive Cruise Control System (ACC)*

To resume the control

After cancelling the ACC control (i.e. placing the system in the standby state) by pressing the "CANCEL" switch or depressing the brake pedal, you can resume the ACC control at the originally set speed if you push up the "RES +" switch.

While the ACC system is in the stationary vehicle hold state, if it is possible to resume following the vehicle in front because it has started moving, "ACC READY TO RESUME" will appear on the meter. To start moving again, push up the "RES +" switch or depress the accelerator pedal.

6

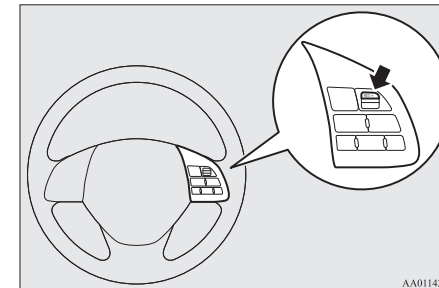
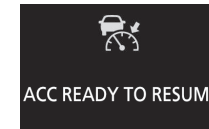

Starting and driving 6-89

Adaptive Cruise Control System (ACC)*

NOTE

- The conditions to be met before the ACC control can be resumed are the same as those for starting the ACC control.
- While the brake pedal is depressed, the vehicle will not start moving again even if the driver operates the switches.

6

To change the following distance setting

Every time you press the ACC following distance setting switch, the set following distance changes in order. Even after turning off the ACC system or putting the operation mode in OFF, the system retains your last selected following distance setting in memory.

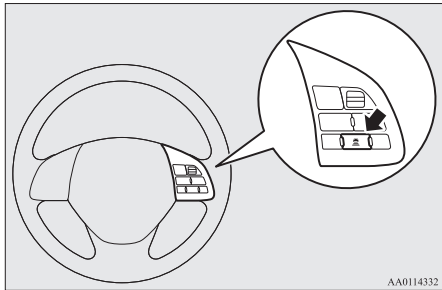

NOTE

- The following distance varies as a function of the speed; the faster the set speed, the longer the following distance.

Following distance setting

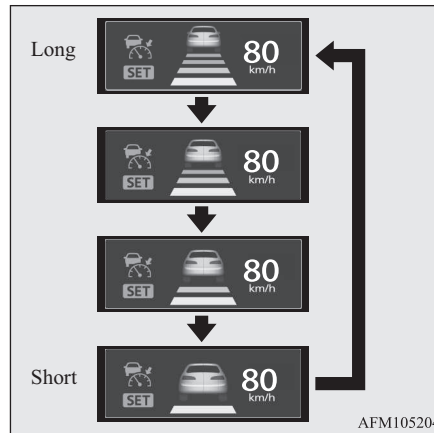

To activate cruise control (automatic speed control)

If you hold the ACC ON/OFF switch pressed with the ignition switch or operation mode set to ON and the ACC in the OFF state, the cruise control is activated. The information screen of the multi-information display then changes to the cruise control screen and a buzzer sounds at the same time.

Cruise control is turned off if you set the ignition switch to the "LOCK" or the operation mode to "OFF".

Refer to "Cruise control*" on page 6-69.



CAUTION

- Cruise control (automatic vehicle speed control system) does not alert by proximity alarm and control distance between vehicles to the vehicle in front.

Forward Collision Mitigation system (FCM)*

Forward Collision Mitigation system (FCM)*

The Forward Collision Mitigation System (FCM) uses a sensor (A) to determine the distance and relative speed to a vehicle and a pedestrian in front. When your vehicle is approaching a vehicle or a pedestrian straight-ahead in your path and the FCM judges that there is the risk of a collision, the system gives audible and visual warnings (forward collision warning function), increases the brake fluid pressure (FCM brake prefill function), and also provides braking force assistance when you depress the brake pedal (FCM brake assist function) to avoid frontal collision.

When the risk of collision increases more, the system causes the brakes to work moderately to encourage you to apply brakes. If the system judges that a potential collision is imminent, it initiates emergency braking to mitigate collision-caused damages or to avoid possible collision (FCM braking function). Stop lamps are illuminated during automatic braking.

If you turn the FCM ON/OFF, the Ultrasonic misacceleration Mitigation System (UMS) also turns ON/OFF at the same time. (Vehicles equipped with the UMS)

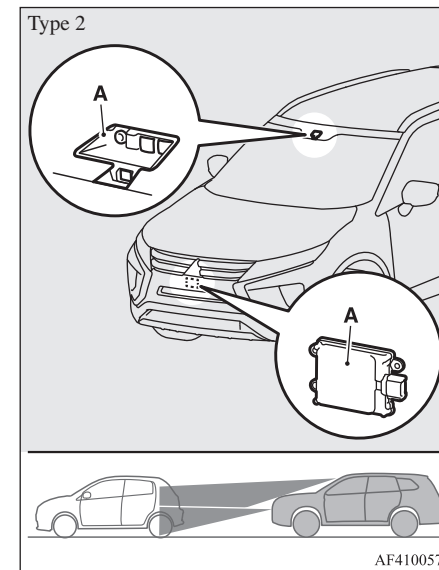
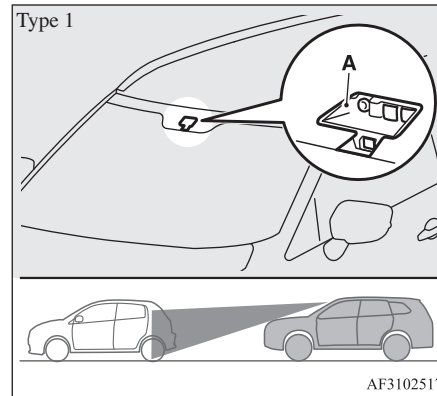

⚠ WARNING

- A driver is responsible for driving safely. The FCM is the system to mitigate collision-caused damages or to avoid collisions as much as possible. The system is not intended to compensate for driver's loss of attention to the front during driving due to distraction or carelessness or supplement a drop in visibility due to the rain and fog. It is never a substitute for your safe and careful driving. Always be ready to apply the brakes manually.
- The FCM works to avoid frontal collisions as much as possible. However, the effect of its operation varies depending on situations and conditions, such as driving conditions, road conditions, and steering, acceleration and braking operations, so that the performance the function can deliver is not always the same. If your vehicle is in danger of collision, take all necessary collision-evading actions, such as depressing the brake pedal strongly regardless of whether the system is activated or not.
- Do not try to confirm the operation of the FCM. In certain situations, this can cause an accident resulting in serious injury or death.

Forward collision warning function

If the system judges that there is a risk of your vehicle colliding with a vehicle or a pedestrian in front, this function warns you of the potential hazard with visual and audible alarms.

When this function is triggered, a buzzer sounds and, at the same time, a "BRAKE" message appears on the information screen of the multi-information display.



The forward collision warning function operates at the following vehicle speed:

Type 1

- Against a vehicle: Approximately 15 to 140 km/h (10 to 87 mph).
- Against a pedestrian: Approximately 7 to 65 km/h (4 to 40 mph).

Type 2

- Against a vehicle: Approximately 15 to 180 km/h (10 to 110 mph).
- Against a pedestrian: Approximately 7 to 65 km/h (4 to 40 mph).

⚠ CAUTION

- Under certain conditions, the audible alarm may not work at all or may be scarcely audible. Do not overly rely on the system; if your vehicle is in danger of collision, take all necessary collision-evading actions, such as depressing the brake pedal strongly regardless of whether the system is activated or not.

FCM brake prefill function

If the system judges that there is a risk of your vehicle colliding with a vehicle or a pedestrian in front, this function prefills the brake line with additional brake fluid to make the brakes more responsive to your brake pedal operation.

The FCM brake prefill function operates at the following vehicle speed:

Type 1

- Against a vehicle: Approximately 5 to 80 km/h (3 to 50 mph).
- Against a pedestrian: Approximately 5 to 65 km/h (3 to 40 mph).

Type 2

- Against a vehicle: Approximately 5 to 180 km/h (3 to 110 mph).
- Against a pedestrian: Approximately 5 to 65 km/h (3 to 40 mph).

FCM brake assist function

If the system judges that there is a risk of your vehicle colliding with a vehicle or a pedestrian in front, this function deploys the brake assist sooner than the brake assist operation. The FCM brake assist function operates at the following vehicle speed:

Type 1

- Against a vehicle: Approximately 15 to 80 km/h (10 to 50 mph).
- Against a pedestrian: Approximately 15 to 65 km/h (10 to 40 mph).

Type 2

- Against a vehicle: Approximately 15 to 180 km/h (10 to 110 mph).
- Against a pedestrian: Approximately 15 to 65 km/h (10 to 40 mph).

CAUTION

- The brake assist function may not be triggered when the brake pedal is operated in certain ways.
Do not overly rely on the system; if your vehicle is in danger of collision, take all necessary collision-evading actions, such as depressing the brake pedal strongly regardless of whether the system is activated or not.

FCM braking function

If the system judges that there is a high risk of your vehicle colliding with a vehicle or a pedestrian in front, the system applies the brakes moderately to encourage you to apply the brakes.

If the system judges that a collision is unavoidable, it initiates emergency braking control to mitigate collision-caused damages or, if the situation permits, to avoid a collision. While the FCM braking control is triggered, you are warned of the hazard with a “BRAKE!” message and audible alarms like with the forward collision warning function. Once the FCM braking has activated, the following message will appear on the information screen of the multi-information display.



The FCM braking function operates at the following vehicle speed:

Type 1

- Against a vehicle: Approximately 5 to 80 km/h (3 to 50 mph).
- Against a pedestrian: Approximately 5 to 65 km/h (3 to 40 mph).

Type 2

- Against a vehicle: Approximately 5 to 180 km/h (3 to 110 mph).
- Against a pedestrian: Approximately 5 to 65 km/h (3 to 40 mph).

CAUTION

- Do not use the FCM as a normal braking.
- After your vehicle has stopped following the activation of the FCM, automatic braking is released. As the vehicle will then start creeping, be sure to depress the brake pedal to hold the vehicle stationary.
- When applying the brake during the automatic braking condition the pedal will feel firm.
This is not abnormal.
You can apply more pressure to the pedal to assist in braking.
- In the following situations, the system provides neither control nor alarming.
 - When a vehicle or a pedestrian suddenly cuts in front of your vehicle.
 - When the distance from a vehicle or a pedestrian in front is extremely short.
 - To an oncoming vehicle.
 - On vehicles equipped with M/T, when the gearshift lever is in the “R” (REVERSE) position.
On vehicles equipped with A/T or CVT, when the selector lever is in the “P” (PARK) or “R” (REVERSE) position.

Forward Collision Mitigation system (FCM)*

6

CAUTION

- When the FCM has detected a problem in the system.
- If the ASC is deactivated, the FCM braking function will not operate. Refer to “Active stability control (ASC)” on page 6-66.
- The FCM may or may not detect a motorcycle, bicycle or wall depending on the situation. The FCM is not designed to detect these objects.
- The forward collision warning function and/or the FCM braking function may not activate in the following situations.
 - When a vehicle suddenly appears just in front of your vehicle.
 - When a vehicle cuts in front of your vehicle very closely.
 - When the vehicle in front is offset to the left or right.
 - When the vehicle in front is towing a trailer.
 - A freight trailer that is not carrying a container.
 - The vehicle has a protruding load from the carrier.
 - The vehicle has a low vehicle height.
 - The vehicle has an extremely high ground clearance.
 - When a vehicle in front is extremely dirty.
 - When a vehicle in front is covered with snow.
 - When a vehicle in front has a large glass surface.

CAUTION

- When a vehicle in front does not have reflectors (lamp reflector) or the position of the reflector is low.
- When a vehicle in front is a car carrier or a similar shaped vehicle.
- When there is a different object near the vehicle.
- When driving on a road with many and successive curves, including when passing their entrances and outlets.
- When accelerating and decelerating quickly.
- When the system recognizes driver’s steering, accelerating, braking or gear shifting actions as evasive actions to avoid collision.
- When you are driving on a road with steep and alternating up and down slopes.
- When driving on a slippery road covered by rain water, snow, ice etc.
- When a road surface is surging, and there is unevenness.
- When driving in dark areas, such as in a tunnel or at night.
- When your vehicle changed lanes, and your vehicle approached immediately behind the vehicle in front.
- During a certain time after your vehicle turns left or right.
- When you are carrying extremely heavy loads in the rear seats or luggage area.
- After the engine has been running for an extended period of time.
- When using a windscreen washer.

CAUTION

- If windscreen wipers are not MITSUBISHI MOTORS GENUINE parts or equivalent.
- When the sensor becomes extremely hot or cold.
- If the battery becomes weak or runs down.
- When the sensor is affected by strong light, such as direct sunlight or the headlights of an oncoming vehicle.
- Under adverse weather conditions (rain, snow, sand storms, etc.)
- When the windscreen of the sensor portion is covered with dirt, water droplets, snow and ice, etc.
- When water, snow or sand on the road are extorted by the vehicle in front or an oncoming vehicle.
- The FCM may not detect a pedestrian in certain situations. Some of these include:
 - It the pedestrian is shorter than approximately 1 m or taller than approximately 2 m.
 - If the pedestrian is wearing loose-fitting clothes.
 - If part of a pedestrian’s body is hidden, such as when holding an umbrella, large bag, etc.
 - If a pedestrian bends forward, sits or lies on the road.
 - When a pedestrian is pushing/pulling something, such as a stroller, bicycle or wheelchair.
 - When pedestrians gather in a group.

⚠ CAUTION

- When a pedestrian's clothing appears to be nearly the same colour or brightness as its surroundings.
- When a pedestrian is very close to an object, such as a vehicle.
- When a pedestrian is in a dark area, such as at night or in a tunnel.
- When the pedestrian is walking fast or running.
- When a pedestrian suddenly rushes in front of the vehicle.
- When the position of a pedestrian is close to the edge of the vehicle.
- Factors such as the positional relationship between your vehicle and a vehicle in front, driver's own technique of steering the vehicle and irregularly moving traffic due to accidents or vehicle trouble may deter the FCM control and alarm from functioning.
- When the system recognizes driver's steering or accelerating actions as evasive actions to avoid a collision, the FCM control and alarm functions may be cancelled.
- The FCM control and alarm functions may be triggered in the following situations.

⚠ CAUTION

- When there is a structure (B) beside the entrance of a curve and intersection.

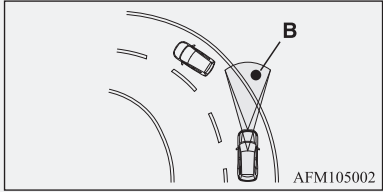

AFM105002

- When running on a narrow iron bridge.
- When passing through a gate with small head or side clearances.
- When there are metallic objects, steps or projections on the road surface.
- When quickly approaching a vehicle in front to overtake it.
- When passing an electronic toll collection gate.
- When running under an overpass, an pedestrian overpass or a small tunnel.
- When running in Multi-storey car park.
- When the road gradually and suddenly changes while running.
- When stopping very close to a wall or a vehicle in front.

⚠ CAUTION

- When passing close to a vehicle, pedestrian or object.

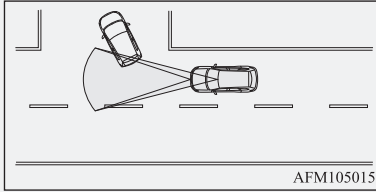

AFM105015

- When driving on the road that the vehicle in front runs in offset position from your vehicle.

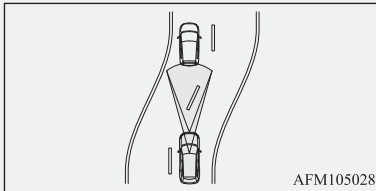

AFM105028

- When passing through an area where objects may contact the vehicle, such as thick grass, tree branches, or a banner.
- When there are patterns on the road that may be mistaken for a vehicle or a pedestrian.
- When a vehicle cuts into your path in the detecting range of the sensor.
- When an oncoming vehicle is positioned straight ahead of your vehicle on a curved road.

Forward Collision Mitigation system (FCM)*

CAUTION

- When passing through a plastic curtain etc.
- When the FCM detects a long object carried on your vehicle, such as skis or a roof carrier.
- When driving through fog, steam, smoke or dust.
- When the windscreen of the sensor portion is covered with dirt, water droplets, snow and ice, etc.
- Turn off the system beforehand when the vehicle is placed in any of the following situations as the system can operate unexpectedly.
 - When using an automatic car wash.
 - When your vehicle's wheels are driven by the engine on a lift.
 - When your vehicle is towed or your vehicle tows another vehicle.
 - When your vehicle is carried on a truck.
 - When enjoying sports driving on a circuit.
 - When your vehicle is on a chassis dynamometer or free rollers.
 - When the tyre pressure is not correct.
 - When installing the spare tyre for emergency.
 - When the snow traction device (tyre chains) are attached.
 - If the windscreen on or surrounding the sensor is cracked or scratched.

6

NOTE

- A sound will be heard during the activation of automatic braking, this is a function of the brake control and is not abnormal.

FCM and Ultrasonic misacceleration Mitigation System (UMS)* ON/OFF switch

This switch is used to turn on and off the FCM and Ultrasonic misacceleration Mitigation System (UMS) and also to select your desired collision alarm timing.

When the switch is held pressed, the ON/OFF state of the FCM and UMS changes from ON to OFF and vice versa. If you give the switch a short press with the FCM in the ON state, you can change the collision alarm timing.

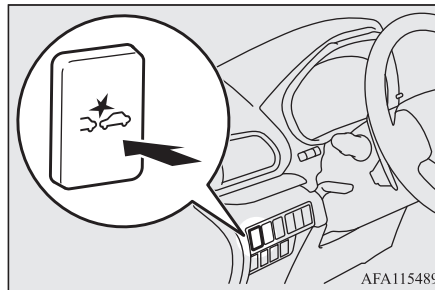

NOTE

- When the FCM and Ultrasonic misacceleration Mitigation System (UMS)* ON/OFF switch is held pressed to change the ON/OFF state of the FCM, the ON/OFF state of the UMS is also changed at the same time.

To turn on/off the system

You can switch the system from OFF to ON or ON to OFF if you hold the FCM and Ultrasonic misacceleration Mitigation System (UMS)* ON/OFF switch pressed when the ignition switch is turned to the "ON" position or the operation mode is put in ON.

Once the system is turned on, the information screen of the multi-information display shows the collision alarm timing currently selected, and the  indicator on the instrument cluster goes out.



When you turn off the system, the following message appears on the information screen of the multi-information display and the  indicator on the instrument cluster.

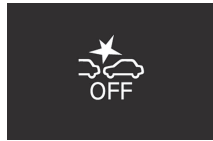

When the ignition switch is turned to the “ON” position or the operation mode is put in ON, the FCM will turn back on.

NOTE

- The indicator is combined with the “Ultrasonic misacceleration Mitigation System OFF” indicator.

To change alarm timing

Give a short press to the FCM and Ultrasonic misacceleration Mitigation System (UMS)* ON/OFF switch to change the timing at which the frontal collision alarm is triggered. Every time you press the switch, the alarm timing changes from three levels (FAR, MIDDLE or NEAR).

As you make selection, the selected alarm timing is displayed on the information screen of the multi-information display. Even after turning off the FCM, turning the ignition switch to the “LOCK” position or putting the operation mode in OFF, the system retains your last selected alarm timing in memory.

Distance mode: FAR



Distance mode: MIDDLE



Distance mode: NEAR



CAUTION

- For the FCM brake prefill, the FCM brake assist and the FCM braking functions, the function triggering timing cannot be changed.

System problem warning

If a problem occurs with the system, a visual warning specific to the type of the problem is given together with an audible alarm.

When the camera and radar cannot detect accurately

When the FCM system determines that it cannot detect objects properly, the FCM will become inoperative.

This can occur when:

- In adverse weather conditions, such as rain, snow or sand storms, etc.
- Foreign objects, such as dirt, snow or ice, adhere to the windscreen of the sensor portion or the surface of the sensor.
- A vehicle in front or an oncoming vehicle is splashing water, snow or dirt.
- Driving on a nonbusy road with a few vehicles and obstacles in front. (Type 2 only)

6

The following message will appear on the information screen of the multi-information display and the indicator will come on in the instrument cluster.



or

Forward Collision Mitigation system (FCM)*



(Type 2 only)

When the sensor performance returns, the FCM functions will resume operation. If the display keeps showing the message, there is a possibility that the sensor has a malfunction. Contact a MITSUBISHI MOTORS Authorized Service Point for inspection of the sensor.

6

NOTE

- The “DRIVER ASSISTANCE CAMERA BLOCKED” message may temporarily appear on the information screen when the sensor cannot detect a vehicle, a pedestrian or an object within range. This is not a malfunction. When a vehicle or an object comes within range, the FCM function will resume and the message will go off.

When the system cannot operate temporarily

If the system becomes temporarily unavailable for some reason, the following message will appear on the information screen of the multi-information display, the  indicator will come on in the instrument cluster and the FCM will automatically be turned off.



If the display keeps showing the message, there is a possibility that the FCM has a malfunction. Contact a MITSUBISHI MOTORS Authorized Service Point for inspection of the system.

Sensor is too hot or cold

If the system becomes temporarily unavailable due to the high or low temperature of the sensor, the following message will appear on the information screen of the multi-information display, the  indicator will come on in the instrument cluster and the FCM will automatically be turned off.

After the temperature of the sensor has been in range, the system will automatically return to operation.

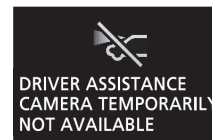

If the display keeps showing the message, there is a possibility that the FCM has a malfunction. Contact a MITSUBISHI MOTORS Authorized Service Point for inspection of the system.

FCM deactivation due to fault

If the FCM detects a malfunction in the system, either one of the following messages will appear on the information screen of the multi-information display, the  indicator will come on in the instrument cluster and the FCM will automatically be turned off.



If the message remains even after the ignition switch is turned to the “LOCK” position and then turned back to the “ON” position or the operation mode is put in OFF, and then turned back to “ON”, please contact a MITSUBISHI MOTORS Authorized Service Point.

Forward Collision Mitigation system (FCM)*

If the display keeps showing the message, there is a possibility that the FCM has a malfunction.

Contact a MITSUBISHI MOTORS Authorized Service Point.

NOTE

- If the sensor or its surrounding area reaches an extremely high temperature when parking the vehicle under a blazing sun, the “FCM SERVICE REQUIRED” message may appear. After the temperature of the sensor or its surrounding area has been in range, if the message remains even after restarting the engine, please contact a MITSUBISHI MOTORS Authorized Service Point.

Handling of the sensor

The sensor (A) is located inside the windscreen and front bumper (Type 2 only) as shown in the illustration.

The sensor is shared in the following systems:

- Forward Collision Mitigation system (FCM)*
- Lane Departure Warning (LDW)*
- Automatic High-Beam (AHB)*
- Adaptive Cruise Control System (ACC)*

- Traffic Sign Recognition (TSR)*

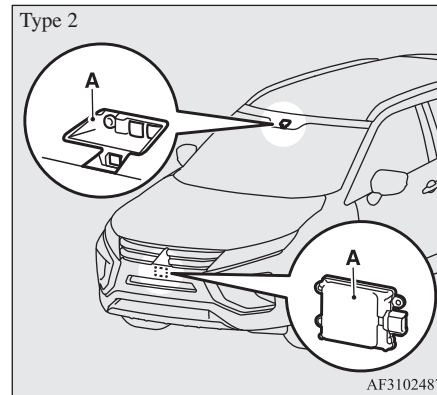
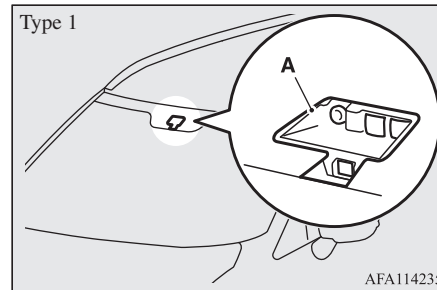

CAUTION

- To maintain proper performance of the FCM, LDW, AHB, ACC and TSR;
 - Always keep the area around the sensor clean.
- If the inside of the windscreen where the sensor is installed becomes dirty or fogged, contact a MITSUBISHI MOTORS Authorized Service Point.
- Do not apply an impact or load on the sensor or its surrounding area.
- Do not put anything including a sticker or film to the outer side of the windscreen in front of or surrounding area of the sensor. Also, do not put anything including a sticker or film to the inner side of the windscreen under the sensor.

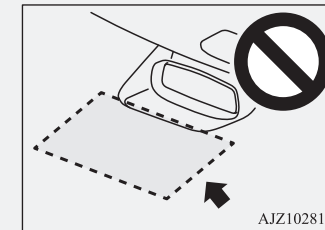

- Do not attempt to detach or disassemble the sensor and sensor mounting screw.
- The sensor front cover should not be modified or painted.
- Do not cover the sensor mounted area with a licence plate or anything such as a grill guard, etc. (Type 2 only)

Laser warning label

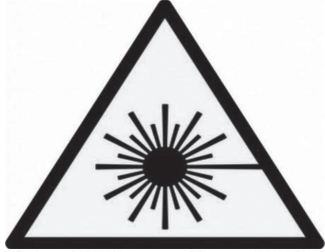

Sınıf II ve üzeri lazerler için uyarı etiketi



6

Ultrasonic misacceleration Mitigation System (UMS)*

Ultrasonic misacceleration Mitigation System (UMS)*

The Ultrasonic misacceleration Mitigation System (UMS) operates to prevent sudden starts and mitigate collision-caused damages by suppressing the engine output for up to approximately 5 seconds when the system judges that the system is detected the vehicle or obstacles within approximately 4 m in front and behind your vehicle and judges that accelerator pedal was depressed promptly and too strongly such as misoperation of it. This system operates when the vehicle is at stop or moving forward or backward at less than approximately 10 km/h (6 mph). When the UMS operates, the warning display appears on the information screen of the multi-information display, and the buzzer sounds intermittently.

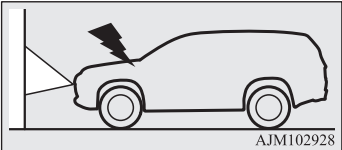
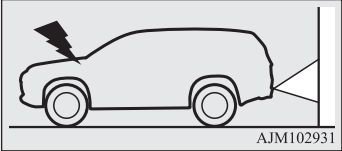
6 UMS ON/OFF is switched in conjunction with the ON/OFF state of the Forward Collision Mitigation system (FCM). (on vehicles equipped with FCM)

Situation	Operation display	Buzzer
<p>When an obstacle is detected in front of your vehicle with the selector lever in the “D” (DRIVE), or in the sports mode, if the accelerator pedal is depressed promptly and too strongly, the engine output is suppressed for up to approximately 5 seconds.</p>  <p style="text-align: right; font-size: small;">AJM102928</p> <p>When an obstacle is detected behind your vehicle with the selector lever in the “R” (Reverse) position, if the accelerator pedal is depressed promptly and too strongly, the engine output is suppressed for up to approximately 5 seconds.</p>  <p style="text-align: right; font-size: small;">AJM102931</p>		<p>Intermittent beeping sound</p>

 **WARNING**

- Do not overly rely on the UMS. It is never a substitute for your safe and careful driving. Always be careful to operate the accelerator pedal perceiving the environmental conditions. Misoperation can lead to a serious accident.
- As the UMS is not a function to keep the stop condition of the vehicle, depress the brake pedal according to the environmental condition.
- Depending on the situation, the system does not operate even if the vehicle or the obstacle in front and behind your vehicle and this may cause the vehicle to start suddenly and lead to a serious accident.
- If the vehicle is trapped in the railway crossing because the system is activated as the crossing barrier is misrecognised as an obstacle, escape from the railway crossing without any panic by one of the following methods.
 - Release the foot from the accelerator pedal and lightly depress the pedal again.
 - Turn the system OFF. (Continuously press the FCM and Ultrasonic misacceleration Mitigation System (UMS)* ON/OFF switch for more than 3 seconds.)
 - Continuously depress the accelerator pedal for more than 5 seconds.
 - Repeat to press the accelerator pedal quickly to its full stroke more than three times.
- Do not perform inspection of the system operation on your own. Depending on the situation, this may cause the system to not operate properly and lead to a serious accident.

Ultrasonic misacceleration Mitigation System (UMS)*

CAUTION

- The UMS does not operate in the following conditions:
 - The ignition switch or the operation mode is other than ON.
 - The UMS is set to OFF by operating the FCM and Ultrasonic misacceleration Mitigation System (UMS)* ON/OFF switch.
 - The selector lever is in the “P” or “N” position.
 - The ASC is set to OFF by operating the ASC OFF switch. Refer to “ASC OFF switch” on page 6-67.
- It sometimes happens that a motorcycle, bicycle or pedestrian are detected as obstacles, but these are not the object of the UMS operation.
- The UMS may not operate in the following conditions.
 - The sensors or surroundings have been wiped by hand.
 - The stickers or accessories have been attached to the sensors or surroundings.
 - When driving in the place which the outside temperature changes suddenly (tunnel or garage etc.).
 - Under adverse weather conditions (rain, strong winds, snow, sand storms, etc.).
 - When approaching an obstacle too closely.
 - When a vehicle cuts in front or behind your vehicle very closely.
 - When your vehicle changed the course and approached immediately behind an obstacle.
 - When only a part of the obstacle is within the detection areas of the sensor.
 - When the rain, snow, water or dirt adheres to the sensor.
 - When the sensor is extremely hot or cold (while the vehicle is parked for a long period of time under a blazing sun or in cold weather).
 - Immediately after engine starting.
 - When driving on a road with many and successive curves, including when passing their entrances and outlets.
 - When you are driving on a road with steep and alternating up and down slopes.
 - When a road surface is surging, and there is unevenness.
 - When the system judges driver’s steering or gear shifting actions as evasive actions to avoid collision.
 - For a short period after the system judges the repeated depression of the accelerator pedal at a few seconds interval as a release operation.
 - When the vehicle body is extremely inclined by carrying heavy loads or improper adjustment of the tyre pressure.
 - When the driving is unstable due to an accident or trouble.
 - The system receives ultrasonic noise from other sources (the horns of other vehicles, motorcycle engines, brakes, radios, pouring rain, splashing water, snow traction device (tyre chains), etc.).
 - Obstacle is not vertical to the ground, the obstacle is not at right angles to the vehicle travelling direction, or when there are uneven walls and wavy walls.
- The UMS operation may be cancelled when the system judges the handle operation as evasive actions or when the obstacle moves out of the detectable area of the sensor.

6

⚠ CAUTION

- The UMS may be triggered in the following situations.
 - When water, snow or sand on the road are extorted by the vehicle in front or an oncoming vehicle.
 - When there are objects, steps or projections on the road surface.
 - When the parking gate or railway barrier is raised imperfectly.
 - When running the road, the gradient changes suddenly.
 - When passing through the mass of the steam, fog or smoke.
 - When driving in close to the vehicle ahead, and when stopping in close to the forward/backward vehicle or a wall.
 - When there is an obstacle in a curve or an intersection.
 - When your vehicle joins the main line from parallel parking.
 - When there is a ultrasonic near your vehicle by horn of other vehicle, engine sound of a motorcycle, air brake noise of a large vehicle, a vehicle detector and sonar of a vehicle etc.
 - When an electrical equipment on the market (radio antenna etc.) is installed near the sensor.
 - When driving on a gravel road.
 - When the surrounding area is overgrown with weeds.
- Turn off the system by pressing the FCM and Ultrasonic misacceleration Mitigation System (UMS)* ON/OFF switch beforehand when the vehicle is placed in any of the following situations as the system can operate unexpectedly.
 - When getting out from a road groove or a mud.
 - When using an automatic car wash.
 - When an elevator for vehicle or a mechanical parking is used.
 - When your vehicle's wheels are driven by the motor on a lift.
 - When your vehicle is towed or your vehicle tows another vehicle.
 - When your vehicle is carried on a truck.
 - When driving on a circuit.
 - When your vehicle is on a chassis dynamometer or free rollers.
 - When the tyre pressure is not correct.
 - When snow traction device (tyre chains) are attached.

Ultrasonic misacceleration Mitigation System (UMS)*

⚠ CAUTION

- Improperly handling the system components may result in such problems as degraded sensor performance and ultimately in an accident. Be sure to take the following precautions to keep the system in good operating conditions.
 - Avoid application of strong shock loads to the sensor.
 - The sensor should be kept clean.
 - Do not cover the sensor with a sticker or anything.
 - Do not modify the suspension of your vehicle.
- If the bumper has been exposed to an impact, the sensors may fail and prevent the system from functioning properly. Have the vehicle inspected at a MITSUBISHI MOTORS Authorized Service Point.

6

Obstacle detection areas

The detection areas of the sensors are limited. Moreover, the sensors are unable to detect low or thin objects or objects near the rear bumper. Make sure to check the surroundings as you operate the vehicle in a safe manner.

Sensor locations

There are the sensors (A) on each of 4 places of the front bumper and the rear bumper.

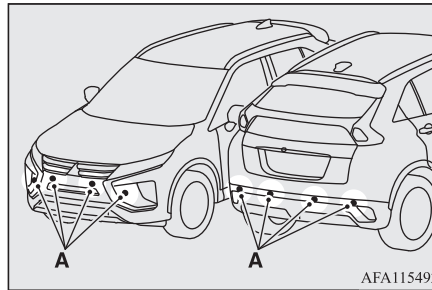

⚠ CAUTION

- The UMS may not operate because the sensor cannot detect the vehicle in front or obstacle as follows:
 - Vehicle towing a trailer etc.

⚠ CAUTION

- A freight trailer that is not carrying a container.
- Vehicle that has a protruding load from the carrier.
- A obstacle with a low height.
- Vehicle that has an extremely high ground clearance.
- Vehicle that is extremely stained.
- Vehicle or obstacle that is covered with snow.
- The vehicle is the specific shape such as the carrier car.
- Obstacles that have the shape of the pole such as the road marker or the streetlight.
- Obstacles that exists in the high position from the ground.
- Obstacles that are soft and absorb ultrasonic easily, such as spongy material or snow.
- Obstacles that are shaped with a sharp angle.

Blind Spot Warning (BSW) (with Lane Change Assist)*

CAUTION

- A fence with large mesh
- Moving object
- When there is a loud noise or an ultrasonic near your vehicle by horn of other vehicle, engine sound of a motorcycle, air brake noise of a large vehicle, a vehicle detector and sonar of a vehicle etc.
- When an electrical equipment on the market (radio antenna etc.) is installed near the sensor.
- When there is an obstacle that is not recognized between your vehicle and the obstacle that can be recognized.

NOTE

- The sensors do not detect objects located in the area directly below or near the bumper. If the height of an object is lower than the mounted position of the sensors, the sensors may not continue detecting it even if they detected it initially.

To turn on/off the UMS

The UMS is automatically turned ON by setting the ignition switch or the operation mode to ON. In addition, the UMS ON/OFF is switched in conjunction with the ON/OFF state of the FCM.

Refer to “FCM and Ultrasonic misacceleration Mitigation System (UMS)* ON/OFF switch” on page 6-96.

Warning display

When the sensor is temporarily not available

Example: When the front and/or rear sensors are temporarily not available



When the warning display appears, the sensors are temporarily not available for some reason such as the environmental condition or increase of the sensor temperature. When the warning display appears continuously, contact a MITSUBISHI MOTORS Authorized Service Point.

When there is a malfunction in the sensor or the system

Example: When there is a malfunction in both sensors



When the warning display appears, the UMS does not operate normally because there are some malfunctions in the system. Have the vehicle inspected at a MITSUBISHI MOTORS Authorized Service Point as soon as possible.

Blind Spot Warning (BSW) (with Lane Change Assist)*

6

The Blind Spot Warning (BSW) is a driving aid system that alerts the driver when another vehicle, which may not be visible through the outside rear-view mirror, is travelling in the next lane behind your vehicle.

When a vehicle in the next lane is travelling at the same speed or faster in the detection areas, the Blind Spot Warning lamp in the corresponding outside rear-view mirror will illuminate. If the turn-signal lever is operated to the side where the Blind Spot Warning lamp is illuminated, the Blind Spot Warning lamp will blink and the system will beep three times to alert the driver.

Blind Spot Warning (BSW) (with Lane Change Assist)*

Depending on the relative speed between your vehicle and a vehicle in the next lane, the BSW will detect up to approximately 70 m from your vehicle (Lane Change Assist).

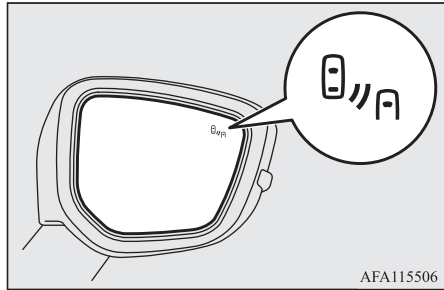

⚠ WARNING

- Before using the BSW, read this entire section to fully understand the limitations of this system. Failure to follow instructions could result in an accident.
- Never rely solely on the BSW system when changing lanes. The BSW is an aid only. It is not a substitute for your safe and careful driving. Always check visually behind and all around your vehicle for other vehicles. The performance of the BSW may vary depending on driving, traffic and/or road conditions.

Detection areas

The BSW uses two sensors (A) located inside the rear bumper. The detection areas are shown as illustrated.

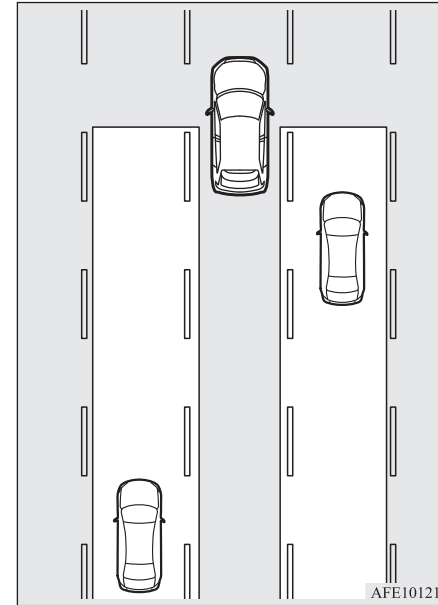
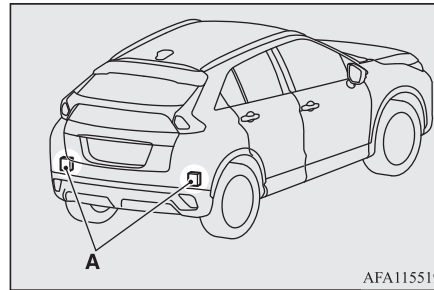

⚠ WARNING

- In certain situations, the BSW may not detect a vehicle in the detection areas or the detection may be delayed. Some of these include:
 - When a small motorcycle or a bicycle is behind your vehicle.

Blind Spot Warning (BSW) (with Lane Change Assist)*

WARNING

- When a vehicle is travelling alongside of your vehicle at nearly the same speed for prolonged periods of time.
- When the heights of the next lane and your lane are different.
- Immediately after the BSW has been turned on.
- Immediately after the ignition switch is turned to the “ON” position or the operation mode is put in ON.
- Under adverse weather conditions, such as rain, snow, strong winds, snow or sand storms.
- When your vehicle comes too close to another vehicle.
- While multiple vehicles are overtaking your vehicle.
- When driving near a pot hole and tramline.
- When a surrounding vehicle or an oncoming vehicle is splashing water, snow or dirt.
- When driving on a curve including the beginning and the end of the curve.
- When driving on a road with alternating up and down steep slopes.
- When driving on a bumpy or rough road.
- When the rear of your vehicle is weighed down or your vehicle is leaning to the right or left due to the weight of passengers and luggage or the improper adjustment of tyre pressure.

WARNING

- When the bumper surface around the sensor is covered with dirt, snow and ice, etc.
- When a bicycle carrier or accessory is installed to the rear of the vehicle.
- When the sensor is extremely hot or cold (while the vehicle is parked for a long period of time under a blazing sun or in cold weather).

CAUTION







- To maintain proper performance of the BSW, follow the instructions below.
 - Always keep the bumper surface around the sensor clean.
 - Avoid impacting the sensor or its surrounding area.
 - Do not put a sticker on the sensor or its surrounding bumper surface.
 - Do not paint the sensor or its surrounding bumper surface.
 - Do not modify the sensor or its surrounding area.
- If the bumper has experienced an impact, the sensor may have been damaged and the BSW may not function properly. Have the vehicle inspected at a MITSUBISHI MOTORS Authorized Service Point.

To operate

When the ignition switch is turned to the “ON” position or the operation mode is put in ON and “ON” is selected in the “BSW” setting screen, the BSW indication lamp in the instrument cluster comes on and the BSW enters the standby state.

When “OFF” is selected in the “BSW” setting screen, the BSW indication lamp in the instrument cluster goes off and the BSW turns off.

To turn the BSW ON/OFF, follow the procedure below.

1. Switch to the function setting screen.
Refer to “Multi-information display switches” on page 5-04
Refer to “Changing the function settings” on page 5-13
2. Press the  switch or  switch several times to switch to the “BSW” screen.
Then, press the  switch to switch to enter the setting selection screen.
3. Press the  switch or  switch to select the “ON” or “OFF”, and then press the  switch to confirm the setting.

Indication lamp

6

Blind Spot Warning (BSW) (with Lane Change Assist)*



6

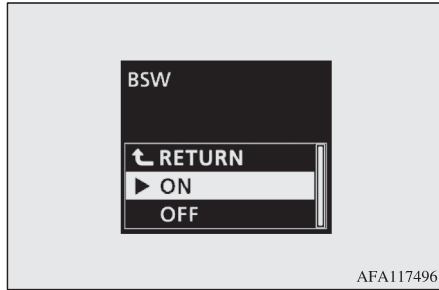

If you turn the BSW ON/OFF, the Rear Cross Traffic Alert (RCTA) also turns ON/OFF at the same time.

NOTE

- When the ignition switch is turned to the “LOCK” position or the operation mode is set to OFF, the selected condition (BSW ON/OFF) just before setting to OFF is retained.
- The BSW operates when all of the following conditions are met.
 - The ignition switch is turned to the “ON” position or the operation mode is put in ON.
 - The selector lever is in a position other than “P” (Park) and “R” (Reverse).

NOTE

- The speed of your vehicle is approximately 10 km/h (6 mph) or higher.

When the sensor detects an approaching vehicle

When the BSW indication lamp in the instrument cluster is on, if a vehicle is approaching your vehicle in the detection area, the Blind Spot Warning lamp in the outside rear-view mirror illuminates.

If the turn-signal lever is operated to the side where the Blind Spot Warning lamp is illuminated, the Blind Spot Warning lamp will blink and the system will beep three times to alert the driver.

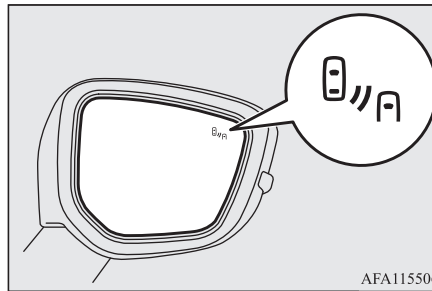

NOTE

- The Blind Spot Warning lamp in the outside rear-view mirror may come on or blink in the following conditions.
 - When driving very near the guardrail or a concrete wall.
 - When driving near the entrance and outlet of the tunnel or very near the wall or near the evacuation area inside the tunnel.
 - When turning at an intersection in a town area.
 - Under adverse weather conditions (rain, snow, sand storm etc.).
 - When driving while your vehicle is blowing up water, snow, sand, etc., on the road.
 - When driving near a kerb, pothole and tramline.
- Set the BSW to OFF when towing.
- The Blind Spot Warning lamp in the outside rear-view mirror may not be visible due to strong direct sunlight or the glare from the headlamps of vehicles behind you during night driving.

System problem warning

If a problem occurs with the system, a visual warning specific to the type of the problem is given together with an audible alarm. The warnings are combined with the Rear Cross Traffic Alert (RCTA) system.

When there is a malfunction in the system



When the warning display appears, the BSW does not operate normally because there is a malfunction in the system. Have the vehicle inspected at a MITSUBISHI MOTORS Authorized Service Point as soon as possible.

NOTE

- When the warning display appears, the BSW will be deactivated.

When the sensor is temporarily not available



When the warning display appears, the sensor is temporarily not available for some reason such as the environmental condition or increase of the sensor temperature. When the warning display does not disappear after waiting for a while, contact a MITSUBISHI MOTORS Authorized Service Point.

When there is a foreign object on the sensor



When the warning display appears, the sensor cannot detect a vehicle travelling side by side or an approaching vehicle, because foreign objects, such as dirt, snow or ice, adhere to the bumper surface around the sensor. Remove dirt, freezing or foreign material on the bumper surface around the sensor. When the warning display does not disappear after having cleaned the sensor, contact a MITSUBISHI MOTORS Authorized Service Point.

Rear Cross Traffic Alert (RCTA)*

Rear Cross Traffic Alert (RCTA)*

The Rear Cross Traffic Alert (RCTA) is an aid system for backing up. When the RCTA system detects vehicles approaching from the sides while your vehicle is reversing, the Blind Spot Warning lamps in the outside rear-view mirrors on both sides will blink and a buzzer will sound to alert the driver. A warning message will also appear on the information screen of the multi-information display.

6

Rear Cross Traffic Alert (RCTA)*

6

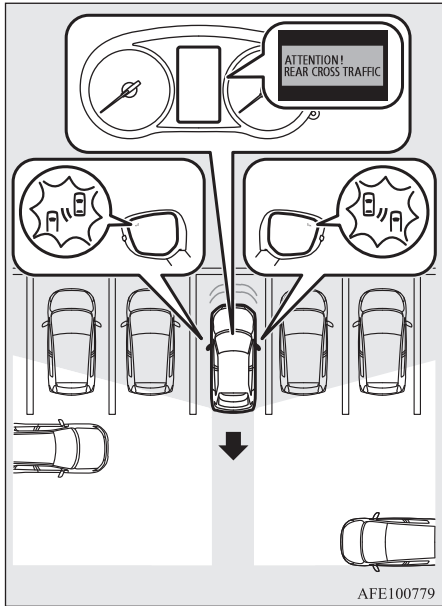

WARNING

- Before using the RCTA, read this entire section to fully understand the limitations of this system. Failure to follow instructions could result in an accident.

WARNING

- Never rely solely on the RCTA when backing up. The RCTA is an aid system. It is not a substitute for your safe and careful driving. Always check visually behind and all around your vehicle for other vehicles, persons, animals or obstructions. The performance of the RCTA may vary depending on driving, traffic and/or surrounding conditions.

NOTE

- The Blind Spot Warning lamps in the outside rear-view mirrors on both sides will blink, even when only one vehicle is approaching from one side.

Detection areas

The detection area is shown as illustrated.

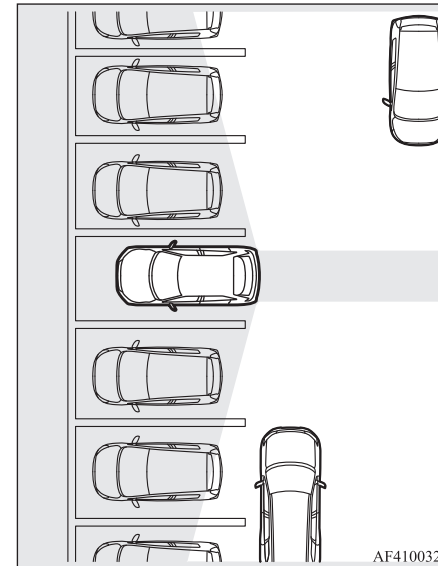

CAUTION

- In certain situations, the RCTA may not detect a vehicle in the detection areas. Some of these situations include:

CAUTION

- When the reversing speed of your vehicle is approximately 18 km/h (11 mph) or higher.
- When the speed of an approaching vehicle is approximately 7 km/h (4 mph) or less.
- If the sensor detection area is blocked by a nearby object, such as a wall or parked vehicle.
- When a vehicle is approaching from straight behind your vehicle.
- When your vehicle is exiting from an angled parking spot.

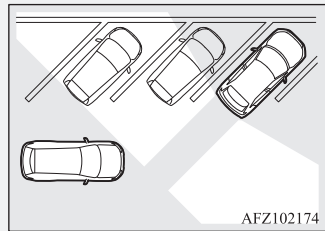

- Immediately after the RCTA has been turned on.
- Immediately after the ignition switch is turned to the "ON" position or the operation mode is put in ON.
- When the bumper surface around the sensor is covered with dirt, snow and ice, etc.
- When the sensor becomes extremely hot or cold, such as after the vehicle has been parked for a prolonged time under the blazing sun or in cold weather.

CAUTION

- If the bumper has experienced an impact, the sensor may have been damaged and the RCTA may not function properly. Have the vehicle inspected at a MITSUBISHI MOTORS Authorized Service Point.

To operate

1. Select "ON" in the "BSW" setting screen of the multi-information display. (Refer to "Blind Spot Warning (BSW): To operate" on page 6-109.)
2. When the gearshift lever or the selector lever is moved to the "R" (REVERSE) position, the RCTA will operate.

NOTE

- Set the RCTA to OFF when towing.
- The Blind Spot Warning lamp in the outside rear-view mirror may not be visible due to strong direct sunlight or the glare from the headlamps of vehicles behind you during night driving.

When a problem is detected in the system

If the system detects a problem, a warning is displayed on the information screen in the multi-information display. Refer to "Blind Spot Warning (BSW): System problem warning" on page 6-110.

Lane Departure Warning (LDW)*

By recognizing through a sensor (A) the lane in which your vehicle is running, the Lane Departure Warning (LDW) gives you a warning when your vehicle is likely to drift from its lane with an audible alarm and a visual alarm displayed on the information screen of the multi-information display.

For details about handling the sensor, refer to "Handling of the sensor" on page 6-99.

6

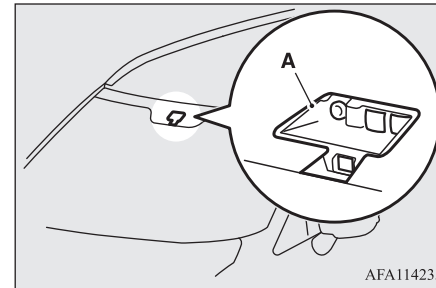

Lane Departure Warning (LDW)*

6

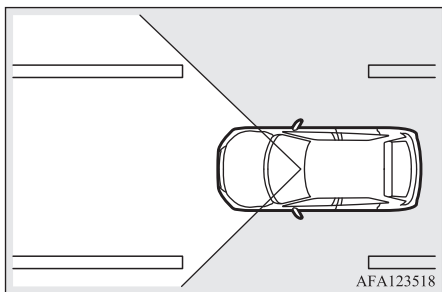

How to operate the LDW

The indication on the information screen of the multi-information display changes as follows depending on the state of the system.

To turn on/off the LDW

NOTE

- The LDW is turned on when the vehicle is shipped from the factory.
- The currently selected LDW setting (on or off) is stored even when the ignition switch is turned to the “LOCK” position or the operation mode is put in OFF.

To turn off the LDW, press the LDW switch.

The LDW indicator in the instrument cluster will then go out.

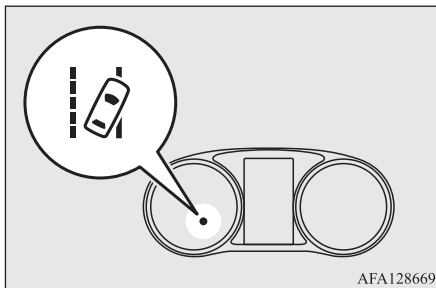
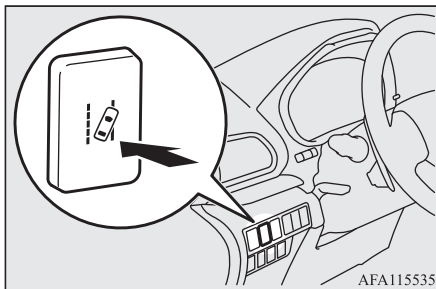

To turn the LDW back on, press the LDW switch again. The LDW indicator in the instrument cluster will come on.

Operation of the LDW

If the LDW is turned on and all of the following conditions are met, the system is capable of recognizing the lane in which your vehicle is positioned and issuing an audible warning when your vehicle goes out of the lane.

- The vehicle speed is approximately 65 km/h (40 mph) or higher.
- The turn-signal lever is not operated.
- The hazard lamp is not activated.
- Environmental conditions are adequate for the system to recognize the lane markings on both sides.

NOTE

- The system will not operate for approximately 7 seconds after the hazard lamp has stopped flashing or the turn-signal lever has returned to the home position.

Lane departure warning

A buzzer sounds intermittently and “LANE DEPARTURE” appears on the information screen of the multi-information display when your vehicle is about to leave or has left the lane.

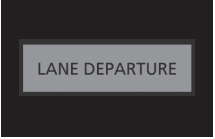

NOTE

- If the warning continues for approximately 3 seconds or more, the warning stops.
- If the lane markers are only on one side of the road, the LDW will operate only for the appropriate side where the lane marker is drawn.

System problem warning

If a problem occurs with the system, a visual warning specific to the type of the problem is given together with an audible alarm.

Too hot or cold sensor

The alarm shown below is displayed if the system becomes temporarily unavailable due to a too high or low temperature of the sensor.

If the temperature of the sensor reaches the predetermined value, the system automatically recovers the normal state.

If the alarm continues showing, there is a possibility that the LDW has a malfunction.

Contact a MITSUBISHI MOTORS Authorized Service Point for inspection of the system.

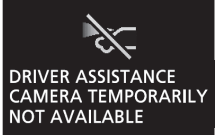

Windscreen is dirty

The alarm shown below is displayed if the system becomes temporarily unavailable due to dirt on the windscreen at the sensor portion.

After having cleaned the windscreen, the system will automatically return to operation.

If the alarm continues showing, there is a possibility that the sensor has a malfunction. Contact a MITSUBISHI MOTORS Authorized Service Point for inspection of the sensor.



LDW deactivation due to fault

The alarm shown below is displayed if the LDW goes into a non-initialized state due to a fault.

Lane Departure Warning (LDW)*

If this happens, please contact a MITSUBISHI MOTORS Authorized Service Point for inspection of the system.

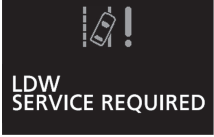

6

NOTE

- If the sensor or its surrounding area reaches an extremely high temperature when parking the vehicle under a blazing sun, the “LDW SERVICE REQUIRED” message may appear. If the message remains even after the temperature of the sensor or its surrounding area has been in range, please contact a MITSUBISHI MOTORS Authorized Service Point.

CAUTION

- LDW has its performance limitations. Do not over-rely on the system.

Lane Departure Warning (LDW)*

CAUTION

- LDW is not designed to lessen risks associated with not looking ahead carefully (attention drawn to something on the side, absent-mindedness, etc.) or poor visibility caused by bad weather etc. Keep steering your vehicle correctly and drive safely.
- The system may not operate correctly in the following conditions. If required, set the LDW switch to "OFF."
 - When driving on a road whose lane markings (white or yellow) are worn out or smeared with dirt to an extent not recognizable by the system.
 - When lane markings are vague, typically during a drive in the rain, snow, fog or dark area, or when running against the sun.
 - When the vehicle is moving in a place where lane markings are interrupted, such as a toll booth entrance and motorway junction.
 - When running on a road portion with incompletely removed old lane markings, shadows, lingering snow, truck-like puddles mistakable for lane markings (especially after the rain when road surface is reflecting light) or similar confusing factors.
 - When running in a lane other than the cruising lane and passing lane.
 - When running beside a closed lane section or in a provisional lane in a traffic work zone.

CAUTION

- When running in an extremely narrow lane.
- When the following distance between your vehicle and a vehicle in front becomes extremely reduced (especially when a marking is hidden by a vehicle in front this is running too close to the marking).
- When entering a junction or other point of road where lanes are laid out complicatedly.
- When passing a road section where the number of lanes increases/decreases or multiple lanes are crossing each other.
- When the lane is marked by double or otherwise special lines.
- When driving on a winding or rough road.
- When driving on a slippery road covered by rain water, snow, ice, etc.
- When passing through a place where the brightness suddenly changes, like the inlet or outlet of a tunnel.
- When turning steep curves.
- When the road surface is reflecting the light shining from the direction opposite to the running direction.
- Vehicle largely lurches when it is running over steps or other irregularities of the road surface.
- When the headlamp illumination is inadequate because of contaminated or deteriorated lenses or improperly aimed headlamps.

CAUTION

- When the vehicle is leaning much to one side due to heavy luggage on it or improperly adjusted tyre pressures.
- When oncoming vehicles' headlamps shine the sensor.
- When the vehicle is equipped with non-standard tyres (including excessively worn tyres and temporary spare tyre), uses snow traction device (tyre chains), or has non-specified components such as a modified suspension.
- When the windscreen is covered with water droplets, snow, dust, etc.
- Follow the instructions given below to keep your LDW in good operating conditions.
 - Always keep the windscreen clean.
 - Avoid applying a strong shock or pressure to the sensor. Do not attempt to detach or disassemble it.
 - Do not put anything like a sticker on the area in front of the sensor of the windscreen.
 - Use only MITSUBISHI MOTORS GENUINE parts when replacing the windscreen wipers.

Traffic Sign Recognition (TSR)*

Traffic Sign Recognition (TSR) is a driving support system designed to display traffic signs on the information screen of the multi-information display to help prevent the driver from overlooking the signs.

While the vehicle is being driven, the sensor (A) recognises the traffic signs and the system displays the traffic sign information on the information screen of the multi-information display in order to inform the driver of the traffic signs.

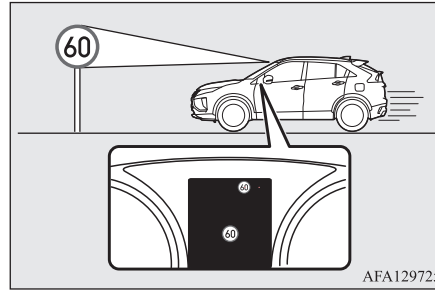
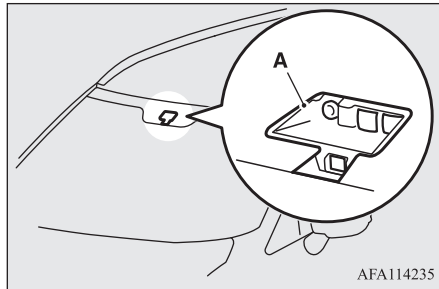

WARNING

- In the following situations, the system may not be able to recognise traffic signs or the displayed traffic sign information may be different from the actual information. When driving the vehicle, always check the traffic signs with your own eyes.
 - When the traffic signs are located outside the detection area of the sensor.
 - When visibility is poor due to bad weather, etc.

To turn on/off the TSR system

To turn the TSR on/off, follow the procedure below.

1. Switch to the function setting screen. Refer to “Multi-information display switches” on page 5-04. Refer to “Changing the function settings” on page 5-13.

Traffic Sign Recognition (TSR)*

2. Press the ∇ switch or \blacktriangle switch several times to switch to the “TSR” screen. Then, press the \square switch to switch to the setting selection screen.

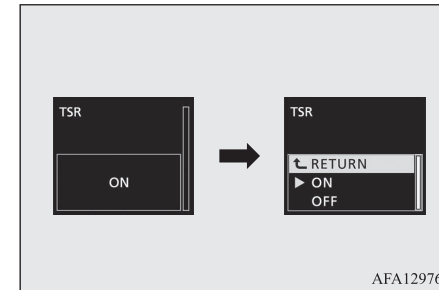

6

3. Press the ∇ switch or \blacktriangle switch to select “ON” or “OFF”, and then press the \square switch to confirm the setting.

NOTE

- The TSR system is turned on when the vehicle is shipped from the factory.
- If the TSR system is turned on when the ignition switch is turned to the “LOCK” position or the operation mode is set to OFF, the system will be turned on when the ignition switch or operation mode is set to ON next time.

Traffic Sign Recognition (TSR)*

Operation of the TSR

When the sensor recognises a traffic sign (including digital signs) while the vehicle is being driven, the traffic sign information is displayed on the information screen of the multi-information display.

A maximum of 2 speed limit signs are displayed on the Traffic Sign Recognition (TSR) display screen (A).

When the display screen is switched to the Traffic Sign Recognition (TSR) display, the overtaken prohibited sign and the 2 speed limit signs are displayed on the information screen (B).

Refer to “Information screen (when the ignition switch or the operation mode is ON)” on page 5-05.

6

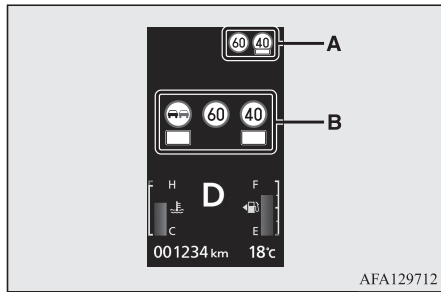

The TSR system displays the following types of traffic sign information:

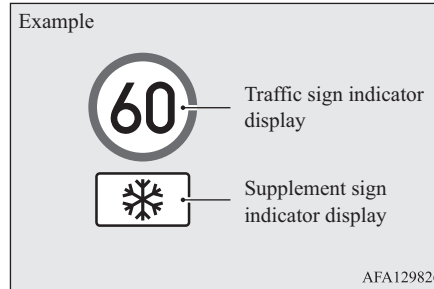

Type	Display examples
Start of speed limit	
End of speed limit	
End of all prohibition	
Supplement sign	Rain
	When wet

Type	Display examples
Snow	
Right turn/exit	
Supplement sign contents not recognized	
Start of overtaking prohibition	
End of overtaking prohibition	
No sign or TSR temporarily not available	
TSR off or TSR service required {Displayed only on the information screen (B)}	

NOTE

- If you do not operate the turn-signal lever while changing lanes, the right turn/exit sign is not displayed.

⚠ CAUTION

- The TSR system may not operate correctly in the following situations:
 - When the windscreen is covered with water droplets, snow, dust, etc.
 - When the traffic signs are not clearly visible due to rain, snow, fog, dark area, sand storms etc.
 - When the traffic sign is small, dirty, faded, tilted, or bent, or in the case of a digital sign, the contrast is poor, the information is incorrect, or there is no speed information.
 - When the traffic signs are rotated or damaged, or positioned high above the roadway.
 - When the traffic sign is partially blocked.
 - When the traffic sign is only visible to the sensor for a short amount of time.
 - When the driving scene (turning, lane change, etc.) is judged incorrectly.
 - When stickers are attached to the rear of the preceding vehicle.
 - When the vehicle is driven in a country with a different direction of traffic.
 - When the vehicle is travelling on a roundabout or curves.
 - When passing through a place where the brightness suddenly changes, such as at the entrance or exit of a tunnel or under a bridge.
 - When driving on a road with alternating up and down steep slopes.
 - When driving on a winding or rough road.

⚠ CAUTION

- When the headlamps of your vehicle are not clear or are not properly aimed.
- When the headlamps of an oncoming vehicle are very bright.
- When the windscreen wipers do not clean the windscreen properly.
- Follow the instructions given below to keep your TSR system in good operating condition.
 - Always keep the windscreen clean.
 - Avoid applying a strong shock or pressure to the sensor.
 - Do not attempt to detach or disassemble it.
 - Do not put anything like a sticker on the area of the windscreen in front of the sensor.
 - Use only MITSUBISHI MOTORS GENUINE parts when replacing the windscreen wipers.

Tyre pressure monitoring system (TPMS)*

The tyre pressure monitoring system (TPMS) uses tyre inflation pressure sensors (A) on the wheels to monitor the tyre inflation pressures. The system only indicates when a tyre is significantly under-inflated.

Tyre pressure monitoring system (TPMS)*

The base tyre pressure can be set at desired value by the driver with the reset function execution. (The low pressure warning threshold is set based on the reset.)

The tyre inflation pressure sensor IDs for two sets of tyres can be registered by a MITSUBISHI MOTORS Authorized Service Point, and the valid ID set can be switched by the multi-information display switch (It's beneficial in case of seasonal tyre change between summer tyre and winter tyre.)

6

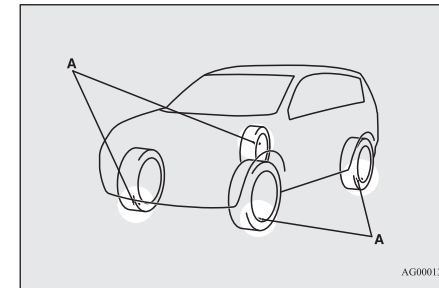

Tyre pressure monitoring system (TPMS)*

WARNING

- The spare tyre with a speed limit label does not have a tyre inflation pressure sensor.
When the spare tyre with a speed limit label is used, the TPMS will not work properly. See an MITSUBISHI MOTORS Authorized Service Point as soon as possible to replace or repair the original tyre.

6

NOTE

- The TPMS is not a substitute for regularly checking tyre inflation pressures. Be sure to check the tyre inflation pressures as described in “Tyres” on page 10-13.
 - The tyre inflation pressure sensor (B) is installed in the illustrated location.
 - On vehicles equipped with the Type 1 sensor which has the metallic air valve (C), replace grommet and washer (D) with the new ones when the tyre is replaced.
 - On vehicles equipped with the Type 2 sensor which has the rubber air valve (E), replace rubber air valve (E) with new one when the tyre is replaced.
- For details, please contact your MITSUBISHI MOTORS Authorized Service Point.

NOTE

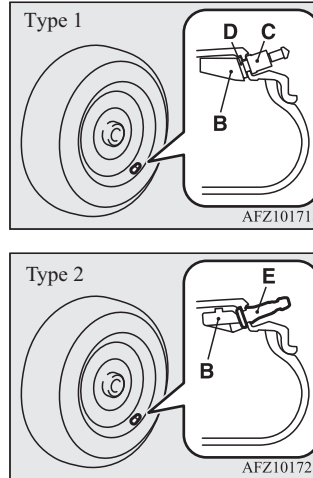

- The spare tyre with aluminium wheel has the tyre inflation pressure sensor, so it can be used for tyre rotation.

TPMS warning lamp/display



When the ignition switch is turned to the “ON” position or the operation mode is put in ON, the TPMS warning lamp normally illuminates and goes off a few seconds later.

If one or more of the vehicle tyres are significantly under-inflated, the warning lamp will remain illuminated while the ignition switch or the operation mode is in ON. Refer to “If the warning lamp/display illuminates while driving” on page 6-122 and take the necessary measures.

NOTE

- The TPMS does not monitor the spare tyre in the luggage compartment, even if the inflation pressure sensor is equipped.
- The warning display is displayed on the information screen in the multi-information display.

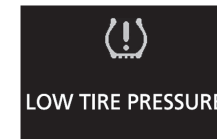

⚠ CAUTION

- If the warning lamp does not illuminate when the ignition switch is turned to the “ON” position or the operation mode is put in ON, it means that the TPMS is not working properly. Have the system inspected by a MITSUBISHI MOTORS Authorized Service Point.
In such situations, a malfunctioning of the system may be preventing the monitoring of the tyre pressure. Avoid sudden braking, sharp turning and high-speed driving.
- If a malfunction is detected in the TPMS, the warning lamp will blink for approximately 1 minute and then remain continuously illuminated. The warning lamp will issue further warnings each time the engine is restarted as long as the malfunction exists.
Check to see whether the warning lamp goes off after few minutes driving.
If it then goes off during driving, there is no problem.
However, if the warning lamp does not go off, or if it blinks again when the engine is restarted, have the vehicle inspected by a MITSUBISHI MOTORS Authorized Service Point.
In such situations, a malfunctioning of the system may be preventing the monitoring of the tyre pressure. For safety reasons, when the warning lamp appears while driving, avoid sudden braking, sharp turning and high-speed driving.

📖 NOTE

- The warning display is displayed on the information screen in the multi-information display.



Each tyre, including the spare, should be checked monthly when cold and inflated to the inflation pressure recommended by the vehicle manufacturer on the tyre inflation pressure label. (If your vehicle has tyres of a different size than the size indicated on the tyre inflation pressure label, you should determine the proper tyre inflation pressure for those tyres.)
As an added safety feature, your vehicle has been equipped with the TPMS that illuminates a low tyre pressure telltale when one or more of your tyres is significantly under-inflated.
Accordingly, when the low tyre pressure telltale illuminates, you should stop and check your tyres as soon as possible, and inflate them to the proper pressure. Driving on a significantly under-inflated tyre causes the tyre to overheat and can lead to tyre failure.

Under-inflation also reduces fuel efficiency and tyre tread life, and may affect the vehicle’s handling and stopping ability.
Please note that the TPMS is not a substitute for proper tyre maintenance, and it is the driver’s responsibility to maintain correct tyre pressure, even if under-inflation has not reached the level to trigger illumination of the TPMS low tyre pressure telltale.

Your vehicle has also been equipped with a warning lamp to indicate when the system is not operating properly.

The warning lamp is combined with the low tyre pressure telltale.

When the system detects a malfunction, the telltale will flash for approximately one minute and then remain continuously illuminated. This sequence will continue upon subsequent vehicle start-ups as long as the malfunction exists.

When the warning lamp is illuminated, the system may not be able to detect or signal low tyre pressure as intended.

The TPMS malfunctions may occur for a variety of reasons, including the installation of replacement or alternate tyres or wheels on the vehicle that prevent the TPMS from functioning properly. Always check the TPMS malfunction telltale after replacing one or more tyres or wheels on your vehicle to ensure that the replacement or alternate tyres and wheels allow the TPMS to continue to function properly.

Tyre pressure monitoring system (TPMS)*

If the warning lamp/display illuminates while driving

1. If the warning lamp illuminates, avoid hard braking, sharp steering manoeuvres and high speeds. You should stop and adjust the tyres to the proper inflation pressure as soon as possible. Adjust the spare tyre at the same time. Refer to “Tyres” on page 10-13.

6

NOTE

- In addition, the warning display will be displayed on the information screen in the multi-information display.
- When inspecting or adjusting the tyre pressure, do not apply excessive force to the valve stem to avoid breakage.
- After inspecting or adjusting the tyre pressure, always reinstall the valve cap on the valve stem.
Without the valve cap, dirt or moisture could get into the valve, resulting in damage to the tyre inflation pressure sensor.
- Do not use metal valve caps, which may cause a metal reaction, resulting in corrosion and damage of the tyre inflation pressure sensors.
- Once adjustments have been made, the warning lamp will go off after a few minutes of driving.

2. If the warning lamp remains illuminated after you have been driving for approxi-

mately 10 minutes after you adjust the tyre inflation pressure, one or more of the tyres may have a puncture. Inspect the tyre and if it has a puncture, have it repaired by a MITSUBISHI MOTORS Authorized Service Point as soon as possible.

WARNING

- **If the warning lamp/display illuminates while you are driving, avoid hard braking, sharp steering manoeuvres and high speeds. Driving with an under-inflated tyre adversely affects vehicle performance and can result in an accident.**

CAUTION

- The warning lamp/display may not illuminate immediately in the event of a tyre blow-out or rapid leak.

NOTE

- To avoid the risk of damage to the tyre inflation pressure sensors, have any punctured tyre repaired by a MITSUBISHI MOTORS Authorized Service Point. If the tyre repair is not done by a MITSUBISHI MOTORS Authorized Service Point, damage to the tyre inflation pressure sensor is not covered by your warranty.

NOTE

- Do not use an aerosol puncture-repair spray on any tyre.
Such a spray could damage the tyre inflation pressure sensors.
Have any puncture repaired by a MITSUBISHI MOTORS Authorized Service Point.

The TPMS may not work normally in the following circumstances:

- A wireless facility or device using the same frequency is near the vehicle.
- Snow or ice is stuck inside the fenders and/or on the wheels.
- The tyre inflation pressure sensor’s battery is dead.
- Wheels other than MITSUBISHI MOTORS GENUINE wheels are being used.
- Wheels that are not fitted with tyre inflation pressure sensors are being used.
- Wheels whose ID codes are not memorized by the vehicle are used.
- A window tint that affects the radio wave signals is installed.

NOTE

- Tyre inflation pressures vary with the ambient temperature. If the vehicle is subjected to large variations in ambient temperature, the tyre inflation pressures may be underinflated (causing the warning lamp/display come on) when the ambient temperature is relatively low. If the warning lamp/display comes on, adjust the tyre inflation pressure.

Whenever the tyres and wheels are replaced with new ones

If new wheels with new tyre inflation pressure sensors are installed, their ID codes must be programmed into the TPMS. Have tyre and wheel replacement performed by a MITSUBISHI MOTORS Authorized Service Point to avoid the risk of damaging the tyre inflation pressure sensors. If the wheel replacement is not done by a MITSUBISHI MOTORS Authorized Service Point, it is not covered by your warranty.

CAUTION

- The use of non-genuine wheels will prevent the proper fit of the tyre inflation pressure sensors, resulting air leakage or damage of the sensors.

Reset of low tyre pressure warning threshold

The threshold is set based on the tyre pressure which the reset function is executed by following procedure.

1. Switch to the function setting screen.
Refer to “Multi-information display switches” on page 5-04.
Refer to “Changing the function settings” on page 5-13.
2. Press the \checkmark switch or \wedge switch several times to switch to the “TPMS SENSOR RESET” screen.
Then, press the \square switch to enter the setting selection screen.
(reset of low tyre pressure warning threshold)
3. Press the \checkmark switch or \wedge switch to select “RESET”, and then press and hold the \square switch for approximately 3 seconds or more to confirm the setting.
The setting is changed to the reset.
4. The warning lamp start flashing slowly.

5. Drive for a while. The reset is completed if the warning lamp goes out.

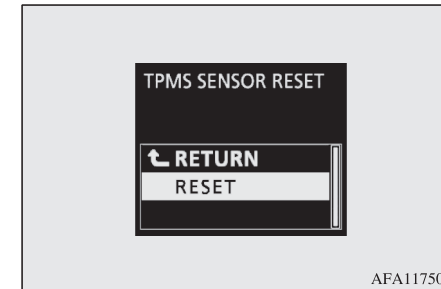
**6****NOTE**

- The reset function should be executed every time when the tyre pressure or tyre rotation is adjusted.
- The reset function should be executed when the tyre is cold. If it is executed when the tyre is warm (e.g. after driving), there may be a low tyre pressure warning earlier than usual.

Tyre ID set change

In case that 2 sets of tyre inflation pressure sensor ID are registered in the receiver, the valid tyre ID set can be changed by following procedure.

Parking sensors (Front/Rear)*

- 6**
1. Switch to the function setting screen.
Refer to “Multi-information display switches” on page 5-04.
Refer to “Changing the function settings” on page 5-13.
 2. Press the \blacktriangledown switch or \blacktriangle switch several times to switch to the “TPMS ID” screen. Then, press the \square switch to the setting selection screen.
 3. Press the \blacktriangledown switch or \blacktriangle switch to select the “ID 1” or “ID 2”, and then press and hold the \square switch for approximately 3 seconds or more to confirm the setting.

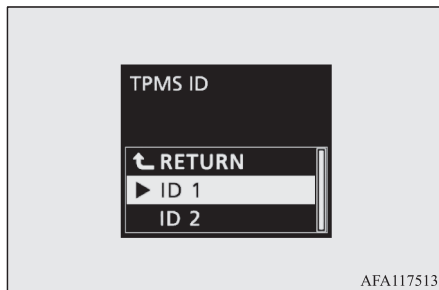

4. The valid tyre ID set is changed, and the number of the TPMS SET indicator is changed.

NOTE

- The tyre ID set is NOT changed, in case that only 1 set of ID is registered.
- When changing the tyre ID set, the reset function of low tyre pressure warning threshold is automatically started. (The warning lamp starts flashing slowly.) If the tyre is warm at this time, the reset function should be executed again when the tyre is cold.

Parking sensors (Front/Rear)*

When parking in a garage or during parallel parking, these sensors alert the driver to any objects near the vehicle and their distance, through a buzzer and the sensor display on the information screen in the multi-information display.

CAUTION

- The parking sensors assist you in determining the approximate distance between the vehicle and any objects. It has limitations in terms of detectable areas and objects, and may not properly detect some objects. Therefore, do not place excessive confidence in the parking sensors, and operate the vehicle as carefully as you would do with vehicle not equipped with this system.
- Make sure to check the surroundings with your own eyes to ensure safety. Do not operate the vehicle by relying on the parking sensors alone.

Obstacle detection areas

The detection areas of the corner and back sensors are limited to those shown in the illustration. Moreover, the sensors are unable to detect low or thin objects or objects near the front or rear bumper. Thus, make sure to check the surroundings as you operate the vehicle in a safe manner.

Parking sensors (Front/Rear)*

Corner and back sensor locations

There are eight sensors (A) in the front and rear bumper.

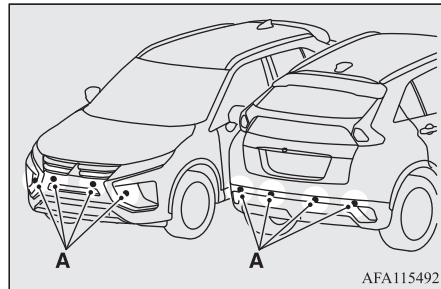

Detection areas

Depending on whether the vehicle is equipped with a towing bar, you can change the parking sensors between the standard mode and the towing bar mode. The towing bar mode changes the system to exclude the area in which the towing bar is mounted from the detection areas.

Vehicles without a towing bar

The detection areas are within approximately 60 cm (A) from the front and corner sensors and 125 cm (B) from the back sensors.

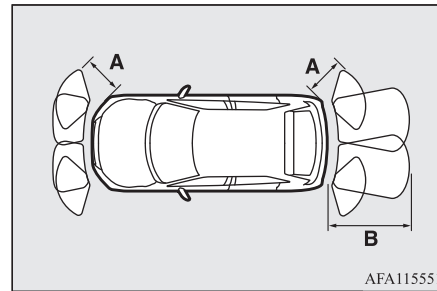

Vehicles with a towing bar

The detection areas are within approximately 60 cm (A) from the front and corner sensors and 125 cm (B) from the back sensors. The non-detection areas (C) are within approximately 20 cm (D) from the bumper.

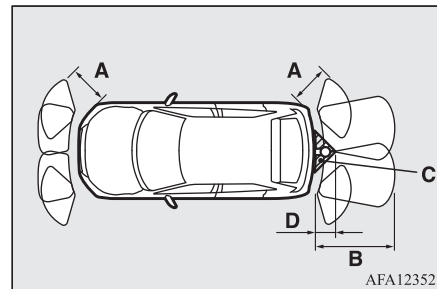

OGKE20E1

NOTE

- The sensors do not detect objects located in the area directly below or near the bumper. If the height of an object is lower than the mounted position of the sensors, the sensors may not continue detecting it even if they detected it initially.

For information on how to change the detection areas, please refer to “Changing the detection areas” on page 6-127.

6

CAUTION

- The parking sensors may not operate properly under the following conditions:
 - The sensors or surroundings have been wiped by hand.
 - The stickers or accessories have been attached to the sensors or surroundings.
 - The sensors or surroundings are covered with water droplets, ice, snow, mud, etc.
 - When the temperature difference is too large.
 - The sensors are frozen.
 - The system receives ultrasonic noise from other sources (the horns of other vehicles, motorcycle engines, brakes, radios, pouring rain, splashing water, snow traction device (tyre chains), etc.).
 - The sensors are extremely hot or cold (while the vehicle is parked for a long period of time under a blazing sun or in cold weather).

Parking sensors (Front/Rear)*

CAUTION

- The vehicle tilts significantly.
- The vehicle is driven on a rough road (with a bumpy, gravel, hilly, or grassy surface).
- The vehicle is too close to an obstacle.
- Immediately after engine starting.
- The parking sensors may not properly detect the followings:
 - Objects that are thin, such as wire nets or ropes.
 - Objects that absorb sound waves, such as snow.
 - Objects that are shaped with a sharp angle.
 - Objects with a smooth surface, such as glass.
 - Objects that are low, such as kerbstones.
- If the bumper has been exposed to an impact, the sensors may fail and prevent the system from functioning properly. Have the vehicle inspected at a MITSUBISHI MOTORS Authorized Service Point.

6

NOTE

- When the sensor is received ultrasonic noise from outside, the sensor of the corresponding portion will blink at a constant frequency. When they are not received the noise and return to normal operation.

To operate

To operate the system, the ignition switch is turned to the “ON” position or the operation mode is put in ON. When the parking sensors are operated, the indication lamp (A) will turn on. To stop the operation, press the “SONAR” switch and the indication lamp (A) goes off.

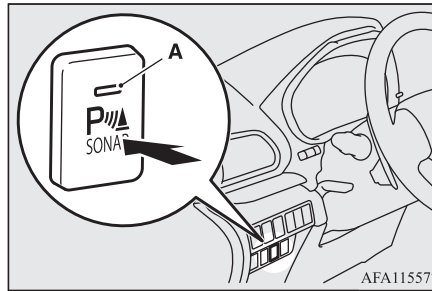

Warning for obstacles

If there is an obstacle in the vicinity of the vehicle, a warning will be issued with the information screen in the multi-information display and a warning buzzer.

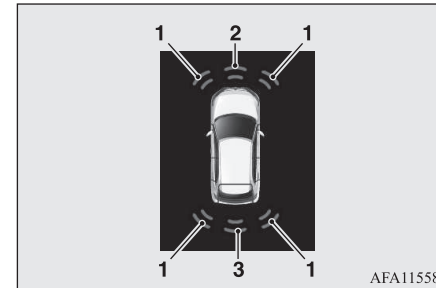

- 1- Corner sensor
- 2- Front sensor
- 3- Back sensor

Front and corner sensor

Vehicle to obstacle distance	Warning display/ sound cycle
Approximately 60 to 40 cm	Intermittent
Approximately 40 to 30 cm	Fast intermittent
Within approximately 30 cm	Continuous

Back sensor (vehicles without a towing bar)

Vehicle to obstacle distance	Warning display/sound cycle
Approximately 125 to 80 cm	Intermittent
Approximately 80 to 40 cm	Fast intermittent
Within approximately 40 cm	Continuous

Back sensor (vehicles with a towing bar)

Vehicle to obstacle distance	Warning display/sound cycle
Approximately 125 to 100 cm	Intermittent
Approximately 100 to 60 cm	Fast intermittent
Within approximately 60 cm	Continuous

⚠ CAUTION

- The distances given are to be used for reference only, as errors may be caused by various factors, such as temperature, humidity, or the shape of the obstacles.

NOTE

- When the sensors detect different obstacles at the same time, the information screen in the multi-information display indicates the directions of the obstacles each sensor is detecting. However, closer obstacles are given priority over other detected obstacles and the warning buzzer sounds to inform you of closer obstacles.

Changing the detection areas

The detection areas can be changed as follows:

Vehicles with a towing bar

While the operation of the system is stopped at the “SONAR” switch, press the “SONAR” switch approximately 3 seconds or more, and release it. The buzzer sounds twice to indicate that the detection area has been changed.

Vehicles without a towing bar

While the operation of the system is stopped at the “SONAR” switch, press the “SONAR” switch approximately 3 seconds or more, and release it. The buzzer sounds once to indicate that the detection area has been changed.

NOTE

- The mode of the detection area can be switched only when the selector lever is in the “R” (Reverse) position.
- The detection area will not change if you keep the “SONAR” switch pressed for 10 seconds or more.
- After pressing the “SONAR” switch, the parking sensors operation differs according to the detection area setting.
 - Setting when towing bar is not equipped
When the selector lever is moved to the “R” (Reverse) position, the parking sensors will operate even if corner sensor operation was stopped by pressing the “SONAR” switch.
 - Setting when towing bar is equipped
When parking sensors operation was stopped by pressing the “SONAR” switch, the parking sensors will not operate until the engine has been stopped even if the selector lever is moved to the “R” (Reverse) position.
To resume parking sensors operation, press the “SONAR” switch or stop and restart the engine, and then move the selector lever to the “R” (Reverse) position.

Rear-view camera*

Warning display

In case there is a malfunction in the parking sensors, the display for the malfunctioning sensor will blink and the warning buzzer will sound for approximately 5 seconds.

6

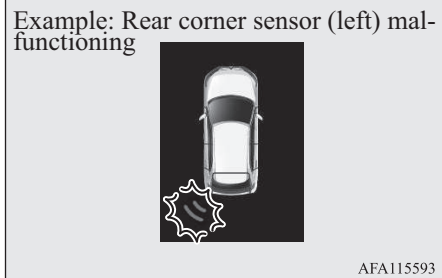

Even after the buzzer and display has stopped warning, the indication lamp (A) on “SONAR” switch will continue blinking until the system reverts to the normal state. Have the vehicle inspected at a MITSUBISHI MOTORS Authorized Service Point.

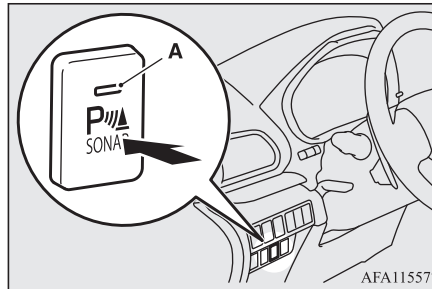

Rear-view camera*

The rear-view camera is a system that shows the view behind the vehicle on a screen of the DISPLAY AUDIO, the Smartphone Link Display Audio or the MITSUBISHI Multi-Communication System (MMCS).

CAUTION

- The rear-view camera is an assistance system that enables the driver to check for obstacles behind the vehicle. Its range of view is limited, so you should not overly depend on it. Please drive just as carefully as you would if the vehicle did not have the rear-view camera.
- Be sure to visually confirm safety around the vehicle with your own eyes. Do not depend entirely on the rear-view camera.

Range of view of rear-view camera

The range of view of the rear-view camera is limited to the area shown in the illustrations. It cannot show both sides and the lower part of the rear bumper, etc. When reversing, be sure to visually confirm safety around the vehicle.

Location of rear-view camera

The rear-view camera (A) is integrated into the part near the tailgate handle.

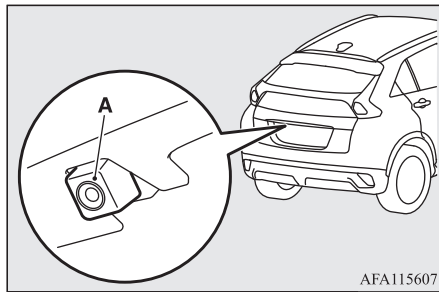

Range of view of rear-view camera

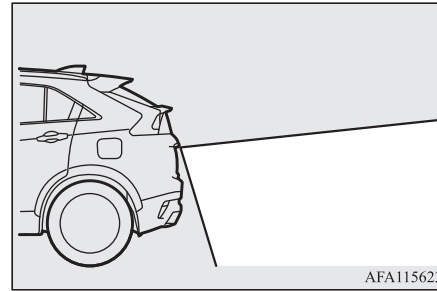
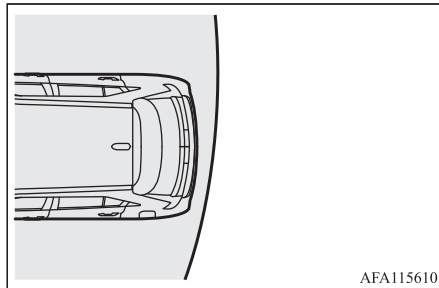

How to use the rear-view camera

When you place the gearshift lever or the selector lever in the “R” position with the ignition switch in the “ON” position or the operation mode in ON, the view behind the vehicle will automatically appear on the screen of the DISPLAY AUDIO, the Smartphone Link Display Audio or the MITSUBISHI Multi-Communication System (MMCS). When you move the gearshift lever or the selector lever to any other position, the screen will return to its original indication.

CAUTION

- The rear-view camera has a special lens that can make objects shown on the screen appear to be closer or further away than they actually are.

NOTE

- Because the rear-view camera has a special lens, the lines on the ground between parking spaces may not look parallel on the screen.
- In the following situations, the screen indication may be difficult to see. There is no abnormality.
 - Low light (nighttime).
 - When the light of the sun or the light from a vehicle’s headlamps shines directly into the lens
- If the camera is hot and is then cooled by rain or a car wash, the lens can mist up. This phenomenon does not indicate a malfunction.
- It is not possible to fully see obstacles when the lens is dirty. If the lens becomes contaminated by water droplets, snow, mud or oil, wipe off the contamination, taking care not to scratch the lens.
- Please observe the following cautions. Ignoring them could lead to a camera malfunction.
 - Do not subject the camera to physical shock.
 - Do not apply wax to the camera.
 - Do not splash the camera with boiling water.
 - Do not disassemble the camera.

6

Reference lines on the screen

Reference lines and upper surface of the rear bumper (A) are displayed on the screen.

Rear-view camera*

- Red line (B) indicates approximately 50 cm behind the rear bumper.
- Two Green lines (C) indicate approximately 20 cm outside of the vehicle body.
- Short transverse lines (1 to 3) indicate distance from the rear bumper.

6

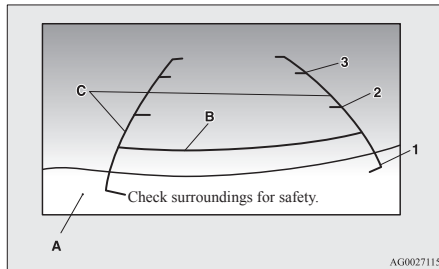

- 1- Approximately at the rear edge of the rear bumper (if so equipped)
- 2- Approximately 100 cm
- 3- Approximately 200 cm

NOTE

- On vehicles equipped with DISPLAY AUDIO, Smartphone Link Display Audio or MITSUBISHI Multi-Communication System (MMCS), it is possible to change the display language of the screen. For details, please refer to the separated owner's manual.

NOTE

- When the vehicle is tilting because of the number of people in the vehicle, the weight and positioning of luggage, and/or the condition of the road surface, the lines in the view from the rear-view camera may not be accurately positioned relative to the actual road. The reference lines for distance and vehicle width are based on a level, flat road surface. In the following cases, objects shown on the screen will appear to be farther off than they actually are.
 - When the rear of the vehicle is weighed down with the weight of passengers and luggage in the vehicle.

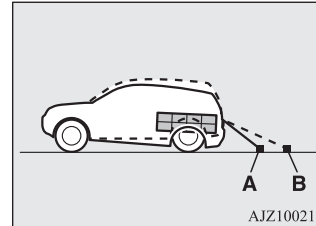

- A - Actual objects
- B - Objects shown on the screen

NOTE

- When there is an upward slope at the back.

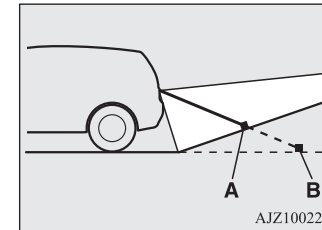

- A - Actual objects
- B - Objects shown on the screen

NOTE

- The reference lines for distance and vehicle width are intended to indicate the distance to a flat object such as a level, flat road surface. This may make the distance to a projecting object shown on the screen differ from the actual distance to the projecting object. Do not use them as a guide for distances to solid objects.

Example: On the screen the point B appears the nearest, then the point C and A in order of distance. The points A and B actually are the same distances from the vehicle, and the point C is farther off than the points A and B.

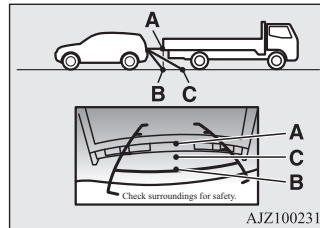

Multi Around Monitor*

The Multi Around Monitor is a system that shows the view combined with four cameras, i.e., “Front-view camera”, “Side-view cameras (right and left)” and “Rear-view camera” on the DISPLAY AUDIO, the Smartphone Link Display Audio or the MITSUBISHI Multi-Communication System (MMCS). It assists drivers to park their vehicles in parking spaces and to parallel park their vehicles.

CAUTION

- The Multi Around Monitor is an assistance system that enables the driver to check the safety around the vehicle. Its range of view is limited, so you should not overly depend on it. Please drive just as carefully as you would if the vehicle did not have the Multi Around Monitor.
- Be sure to visually confirm safety around the vehicle with your own eyes. Especially, the four corners of the vehicle become blind spots where an object is not displayed on the Multi Around Monitor. Do not depend entirely on the Multi Around Monitor.
- Do not use the Multi Around Monitor with the door mirrors folded in and/or with the doors and/or the tailgate open. It will prevent the Multi Around Monitor from displaying the appropriate range.

Location of each cameras

The cameras are integrated into the location as shown below.

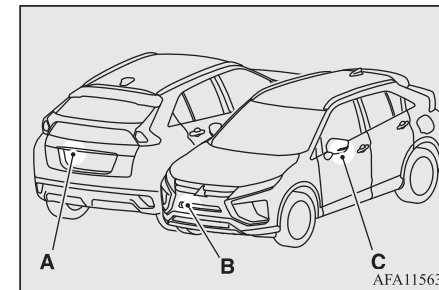

- A- Rear-view camera
- B- Front-view camera
- C- Side-view camera

WARNING

- Do not install anything which will disturb the operation of the cameras around the location of them.

Multi Around Monitor*

Range of view of the Multi Around Monitor

The range of view of the Multi Around Monitor cameras is limited to the area shown in the illustrations. It cannot show around the both sides and the lower part of the front and rear bumpers, etc. While driving, be sure to visually confirm safety around the vehicle.

Range of view of the Multi Around Monitor cameras

6

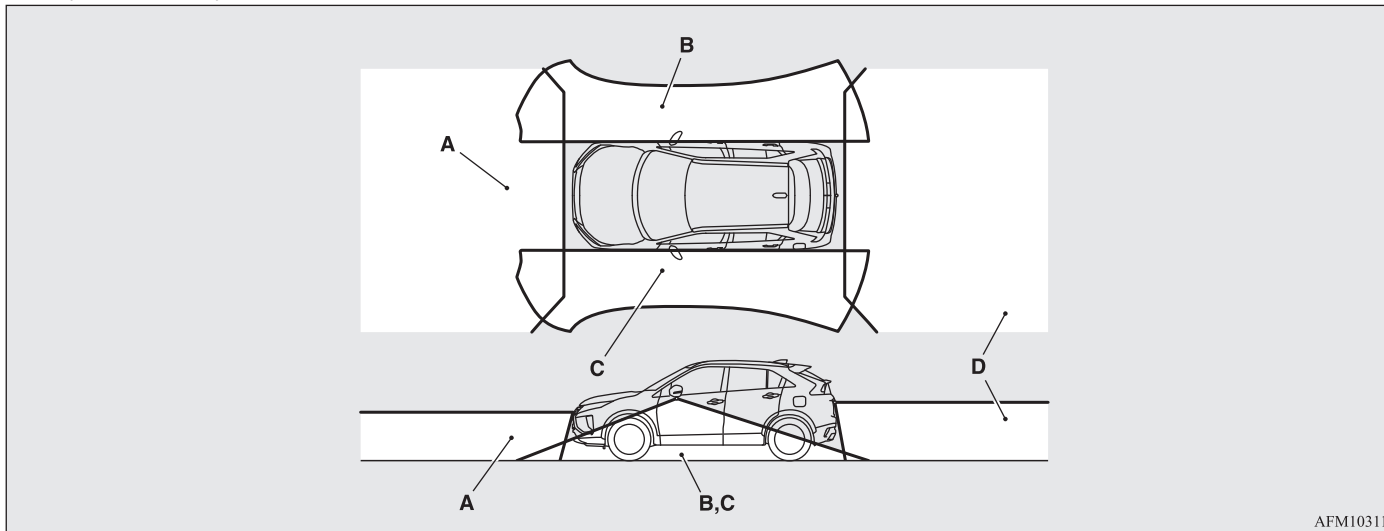

- A: Front-view camera
- B: Side-view camera (Right)
- C: Side-view camera (Left)
- D: Rear-view camera

Types of views of the Multi Around Monitor

Two different types of views are displayed on the left side and the right side respectively.

Bird's eye-view/Rear-view mode

Views of the surroundings of the vehicle and behind the vehicle are displayed.

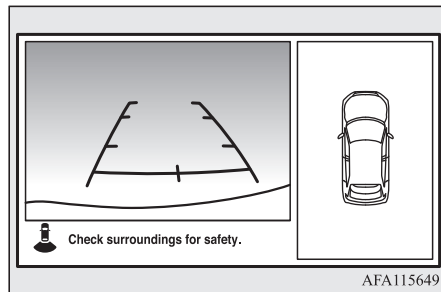

Side-view/Rear-view mode

Views of the passenger's side of the vehicle and behind the vehicle are displayed.

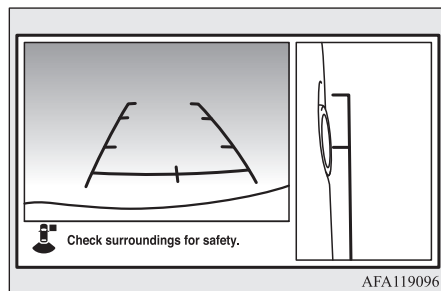

Bird's eye-view/Front-view mode

Views of the surroundings of the vehicle and the front of the vehicle are displayed.

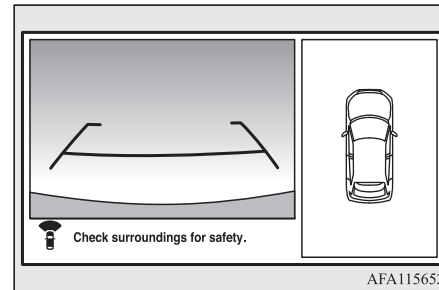

Side-view/Front-view mode

Views of the passenger's side of the vehicle and the front of the vehicle are displayed.

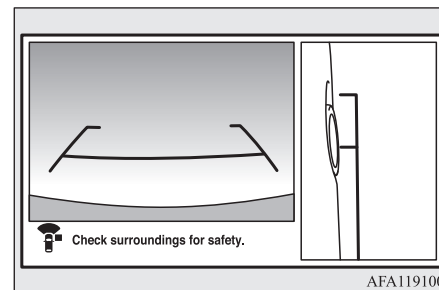

CAUTION

- The cameras have special lenses that can make objects shown on the screen appear to be closer or further away than they actually are.

NOTE

- Because the cameras have a special lens, the lines on the ground between parking spaces may not look parallel on the screen.
- In the following situations, the screen indication may be difficult to see. There is no abnormality.
 - Low light (nighttime)
 - When the light of the sun or the light from a vehicle's headlamps shines directly into the lens.
 - If a fluorescent light shines directly into the lens, the screen indication may be flicker.
 - There is no abnormality.
- If the camera is hot and is then cooled by rain or a car wash, the lens can mist up. This phenomenon does not indicate a malfunction.
- If the atmospheric temperature is extremely hot or extremely cold, the camera images may not be clear.
 - There is no abnormality.
- If a radio set is installed near the camera, the camera images may cause electrical system interference and the system may stop functioning properly.

6

Multi Around Monitor*

NOTE

- It is not possible to fully see obstacles when the lens is dirty. If the lens becomes contaminated by water droplets, snow, mud or oil, wipe off the contamination, taking care not to scratch the lens.
- Please observe the following cautions. Ignoring them could lead to a camera malfunction.
 - Do not subject the camera to physical shock such as striking it strongly or throwing a thing.
 - Do not adhere organic substances, waxes, oil remover, and glass cleaner to the camera.
If adhered to them, immediately wipe off.
 - Do not splash the camera with boiling water.
 - Never spray or splash water on the camera or around it.
 - Do not disconnect, disassemble or modify the camera.
 - Do not scratch the camera, as this may cause damage to the camera images.

6

How to use the Multi Around Monitor

The Multi Around Monitor can only be used when the ignition switch is set to the "ON" position or the operation mode is put in ON.

Operation with the selector lever

When you place the selector lever in the "R" (REVERSE) position, the bird's eye-view/rear-view is displayed on the DISPLAY AUDIO, the Smartphone Link Display Audio or the MITSUBISHI Multi-communication System (MMCS). When you move the selector lever to any other position, the display disappears.

Operation with the switch

When the switch (A) is pressed, the bird's eye-view/front-view is displayed.

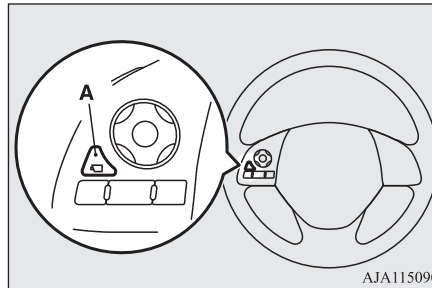

NOTE

- If there is no operation for 3 minutes after the Multi Around Monitor is displayed by pressing the switch with the selector lever in a position other than "R", the display disappears.

Switching of the screen (Selector lever position is "R")

If the switch is pressed, the mode of Multi Around Monitor is switched as follows.
Bird's eye-view/Rear-view mode → Side-view/ Rear-view mode

Switching of the screen (Selector lever position is other than "R")

If the switch is pressed, the mode of Multi Around Monitor is switched, Bird's eye-view/Front-view mode → Side-view/Front-view mode → OFF

NOTE

- The passenger's side screen can be switched to the side-view by pressing the switch.

NOTE

- When you move the selector lever to the “R” position with the front-view displayed on the driver’s side screen, the driver’s side screen switches to the Rear-view mode. When you move the selector lever to any other position, the driver’s side screen switches to the Front-view mode.
- When the switch is pressed at the vehicle speed of approximately 10 km/h (6 mph) or higher, only the side-view can be displayed on the passenger’s side screen.
- The front-view will not be displayed when the vehicle speed exceeds approximately 10 km/h (6 mph).
- The display of the view may be delayed during switching of the screen.

How to read the screen

In any mode other than the Bird’s eye-view mode, the lines in the screen give the following information. Use them only as a guide.

CAUTION

- When you accidentally hit the camera and its circumference against something, the view and the lines in the screen may not be displayed correctly. Be sure to have it inspected by a MITSUBISHI MOTORS Authorized Service Point.

Front-view mode

Reference lines for the distance and the vehicle width and upper surface of the front bumper (A) are displayed on the screen.

- The Red line (B) indicates approximately 50 cm from the front edge of the front bumper.
- The Two Green lines (C) indicate the approximate vehicle width.
- The Orange line (D) indicates an expected course when the vehicle moves forward with the steering wheel turned. It disappears when the steering wheel is in the neutral position.
- The approximate distance from the vehicle body is as follows:

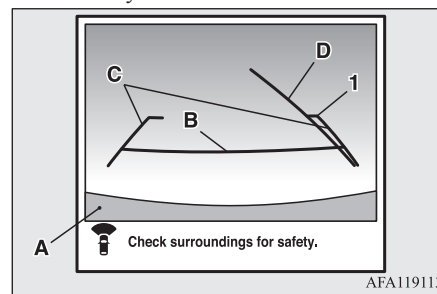

1- Approximately 100 cm from the front edge of the front bumper

NOTE

- When the expected course lines are displayed in the front-view, the expected course lines are also displayed in the bird’s eye-view (Front: solid line, Rear: broken line).

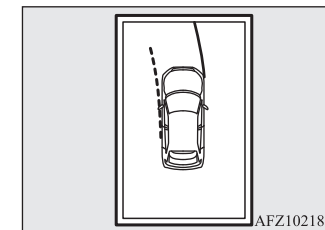

Rear-view mode

Reference lines for the distance and the vehicle width and upper surface of the rear bumper (A) are displayed on the screen.

- The Red line (B) indicates approximately 50 cm behind the rear edge of the rear bumper.
- The Two Green lines (C) indicate the approximately vehicle width.
- The Orange line (D) indicates an expected course when the vehicle is reserved with the steering wheel turned. It disappears when the steering wheel is in the neutral position.
- The approximate distance from the vehicle body is as follows:

Multi Around Monitor*

6

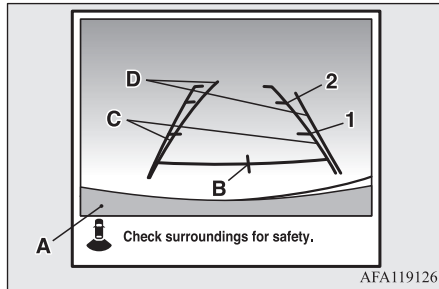

- 1- Approximately 100 cm from the rear edge of the rear bumper
- 2- Approximately 200 cm from the rear edge of the rear bumper

CAUTION

- Due to the number of people in the vehicle, the fuel quantity, the weight and positioning of luggage, and/or the condition of the road surface, the lines in the view from the rear-view camera may not be accurately positioned relative to the actual road. Use the reference lines only as a guideline, and always do a safety check of your behind and surroundings directly while driving.

NOTE

- When the expected course lines are displayed in the rear-view, the expected course lines are also displayed in the bird's eye-view (Front: broken line, Rear: solid line).

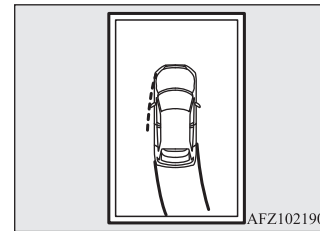

Errors between the display and the actual road surface

The reference lines for distance and vehicle width are based on a level, flat road surface. In the following cases, errors are produced between the display reference lines and the distance on the actual road surface.

When the rear of the vehicle is weighed down with the weight of passengers and luggage in the vehicle

The reference lines are displayed closer than the actual distance.

Therefore when there is an obstacle on the upward slope, it appears farther than its actual position.

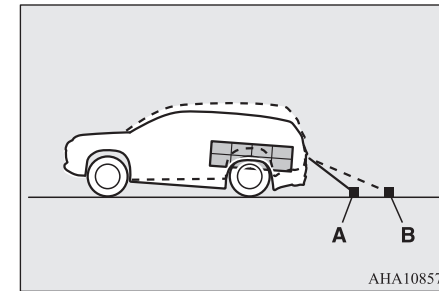

- A- Actual objects
- B- Objects shown on the screen

When there is an upward slope behind the vehicle

The reference lines are displayed closer than the actual distance.

Multi Around Monitor*

Therefore when there is an obstacle on the upward slope, it appears farther than its actual position.

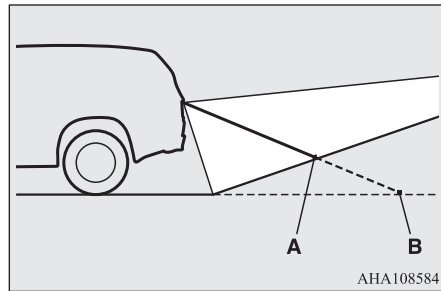

- A- Actual objects
- B- Objects shown on the screen

When there is a downward slope behind the vehicle

The reference lines are displayed farther than the actual distance.

Therefore when there is an obstacle on the downward slope, it appears closer than its actual position.

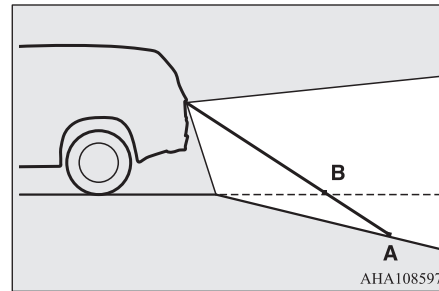

- A- Actual objects
- B- Objects shown on the screen

When solid objects are located close to the vehicle

When solid objects are located close to the vehicle, the displayed distance on the screen may differ from the actual distance. Because the reference lines do not contact the body of the truck, it looks as if it would not hit the vehicle in following illustration.

However, the vehicle may hit the truck because the body of the truck strays onto the course in reality.

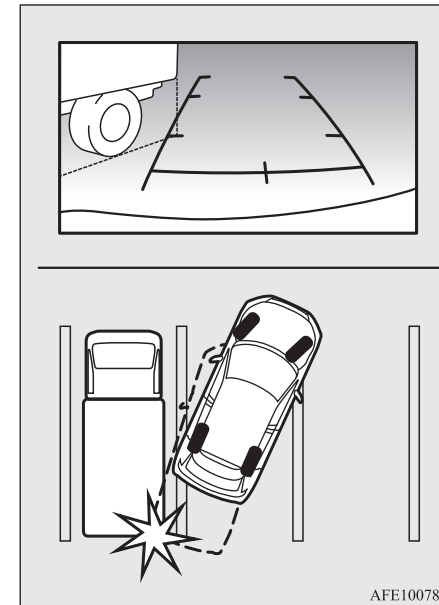

6

Multi Around Monitor*

When approaching to solid objects

The reference lines for distance and vehicle width are intended to indicate the distance to a flat object such as a level, flat road surface. This may make the distance to a projecting object shown on the screen differ from the actual distance to the projecting object. Do not use them as a guide for distances to solid objects.

6

Example: On the screen the point B appears the nearest, then the point C and A in order of distance. The points A and B actually are the same distances from the vehicle, and the point C is farther off than the points A and B.

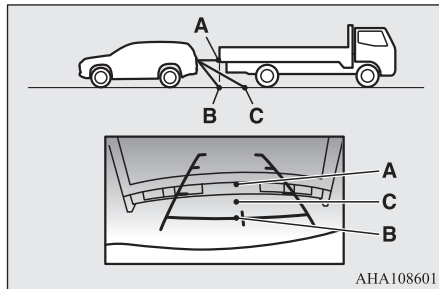

Side-view mode

Reference lines for the vehicle width and the front end of the vehicle are displayed on the screen.

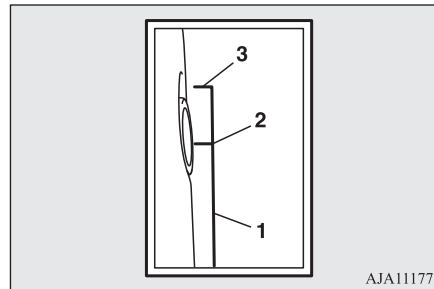

- 1- Approximate vehicle width including the door mirror.
- 2- Approximate location of the axle centre of the front wheel.
- 3- Approximate 50 cm from the front edge of the front bumper.

Bird's eye-view mode

An overhead view in which the vehicle is looked down is displayed so that you can easily identify the location of your vehicle and the course to enter the parking space.

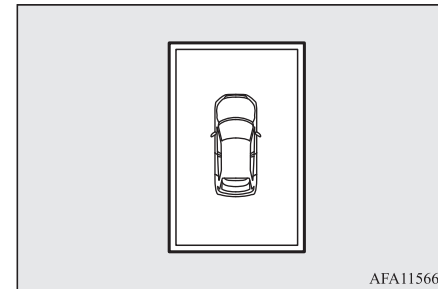

CAUTION

- The bird's eye-view is an simulated view processed by combining view captured by "Front-view camera", "Side-view cameras (right and left)" and "Rear-view camera". Because of this, in the Bird's eye-view mode, objects will appear to be farther away than they actually are. In addition, there are blind spots in the vicinity of the actual vehicle which are not displayed on the screen. You may crash your vehicle even if there seems to be a little distance between your vehicle and an object, and there may be an object in the area where there seems to be nothing. Be sure to check the safety around the vehicle with your own eyes.
- The vehicle icon displayed in the Bird's eye-view mode differs from the actual vehicle in colour and size. Because of this, an object near the vehicle may appear to be in contact with the vehicle, and the positional relationship between the vehicle and the object may differ from the actual one.
- The view composition processing regions are present in the four corners of the Bird's eye-view display, mainly at the boundary sections of views from each camera. Because of this, in the vicinity of the boundary sections, the sharpness of the views may decrease and an object may disappear and reappear on the screen.

NOTE

- In the Bird's eye-view mode, since the views captured by the four cameras, "Front-view camera", "Side-view cameras (right and left)" and "Rear-view camera" are processed based on a level flat road surface, an image may be displayed as follows:
 - An object appears to have fallen down and looks longer or larger.
 - An object having a height from the road surface may seem to appear from the joint of the view composition processing regions.
- The brightness of the views from each camera may vary depending on the illuminance conditions.
- An object above the camera is not displayed.
- The object displayed in the Front-view mode or the Rear-view mode may not be displayed in the Bird's eye-view mode.
- The view in the Bird's eye-view mode may be displaced from its true position when the mounting location and angle of each camera are changed.
- The lines on the road may appear to be displaced or bent at the joint of the views.

To change the vehicle icon colour in the bird's eye-view

It is possible to change the vehicle icon colour in the bird's eye-view.

1. Stop the vehicle in a safe place.

CAUTION

- For reasons of safety, do not operate the switch while driving.

2. Press the switch (A) to display the bird's eye-view/front-view.

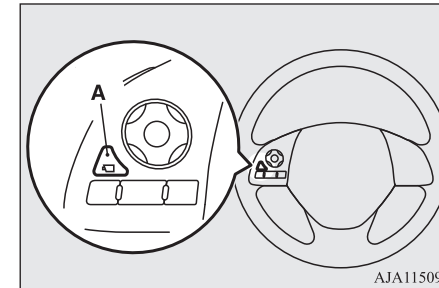
**6**

3. Press and hold down the switch (A) until the vehicle icon blinks to enter the selection mode of the vehicle icon colour in the bird's eye-view.
4. Press the switch until the desired colour appears on the display. Each time you press the switch, the vehicle icon colour in the bird's eye-view will change to the next one.
5. When it is changed to your desired colour, press and hold the switch (A) for a few seconds. This completes the setting.

Cargo loads

6

NOTE

- When the selection mode is in the following situations, the vehicle icon colour does not change.
 - When you place the gearshift lever or the selector lever in the “R” (REVERSE) position.
 - When you do not operate anything for 30 seconds.
 - The ignition switch is set to the “LOCK” position or the operation mode is put in OFF.

Cargo loads

Cargo loads precautions

CAUTION

- Do not load cargo or luggage higher than the top of the seatback. Be sure that your cargo or luggage cannot move once your vehicle is moving. Having the rear view blocked, and your cargo being thrown inside the cabin if you suddenly have to brake can cause a serious accident or injury.
- Load heavy cargo or luggage in the front of the vehicle. If the load in the back of the vehicle is too heavy, steering may become unstable.

Loading a roof carrier

CAUTION

- Use a roof carrier that properly fits your vehicle. Do not load luggage directly onto the roof.
For installation, refer to the instruction manual accompanying the roof carrier.

NOTE

- We recommend you to use a MITSUBISHI MOTORS GENUINE roof carrier, since the brackets to be used have a special shape. For details, we recommend you to consult a MITSUBISHI MOTORS Authorized Service Point.

Roof carrier precaution

CAUTION

- Make sure that the weight of the luggage does not exceed the allowable roof load. If the allowable roof load is exceeded, this may cause damage to the vehicle. The roof load is the total allowable load on the roof (the weight of the roof carrier plus the weight of luggage placed on the roof carrier).
For the specific value, refer to “Vehicle weight” on page 11-05.

CAUTION

- When luggage is loaded onto the vehicle, please make sure to drive slowly and avoid excessive manoeuvres such as sudden braking or quick turning.
In addition, place the luggage on the carrier so that its weight is distributed evenly with the heaviest items on the bottom. Do not load items that are wider than the roof carrier.
The additional weight on the roof could raise the vehicle’s centre of gravity and affect vehicle handling characteristics.
As a result, driving errors or emergency manoeuvres could lead to a loss of control and result in an accident.
- Before driving and after travelling a short distance, always check the load to make sure it is securely fastened to the roof carrier. Check periodically during your travel that the load remains secure.

NOTE

- To prevent wind noise or reduction in fuel economy, remove the roof carrier when not in use.
- Remove the roof carrier before using an automatic car wash.
- Be sure that adequate clearance is maintained for raising the sunroof (if so equipped) when installing a roof carrier.

NOTE

- Be sure that adequate clearance is maintained for raising the tailgate while loading luggage on the roof carrier.

Trailer towing*

In order to tow a trailer with your vehicle, when having a trailer towing device mounted that meets all relevant regulations in your area, consult a MITSUBISHI MOTORS Authorized Service Point.

Check that your towing bar coupling ball does not obscure your vehicle's licence plate when the trailer or caravan is disconnected. If it obscures the licence plate, please remove the towing bar coupling ball. And if the towing bar coupling ball is lockable by using a key or any kind of tools, please remove the coupling ball and use a towing bar coupling ball which can be removed or repositioned without the use of a key or any kind of tools instead.

The regulations concerning the towing of a trailer may differ from country to country. You are advised to obey the regulations in each area.

CAUTION

- Danger of Accident!
A towing bar should be fitted according to MITSUBISHI MOTORS guidelines.

Maximum towable weight with brake and maximum trailer-nose weight

Never exceed the maximum towable weight with brake and the maximum trailer-nose weight as listed in the specifications. For the specific value, refer to "Vehicle weight" on page 11-05.

If you tow a trailer at an altitude of more than 1,000 m above sea-level, reduce your weight by 10 % of the gross combination weight for every increase of 1,000 m above sea-level, as the engine output is lowered owing to decrease in atmospheric pressure.

Towing bar mounting specifications

See the following table for fixing points (A) for the towing bar.

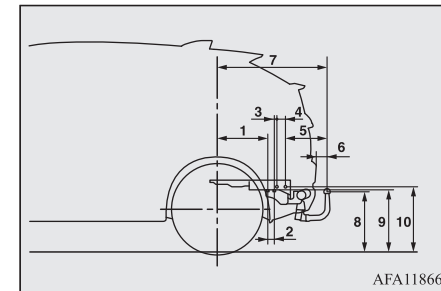

6

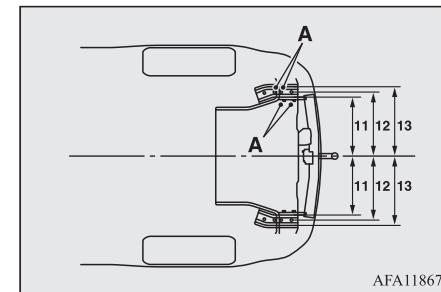

1	390 mm
2	50 mm

Trailer towing*

3	21 mm
4	68.5 mm
5	328.5 mm
6	75 mm
7	858 mm
8	489 mm (at kerb weight condition) 372-388 mm (at laden condition)
9	500 mm (at kerb weight condition)
10	524 mm (at kerb weight condition)
11	455.5 mm
12	495 mm
13	534.5 mm

6

Operating hints

- To prevent the clutch from slipping (Vehicle with a M/T only), do not rev the engine more than is required when starting off.

- Be sure that the driving speed does not exceed 100 km/h (62 mph) for trailer operation.

It is also recommended that you obey the local regulations in case driving speed with a trailer is limited to less than 100 km/h (62 mph).

- To prevent shocks from the overrun brake, depress the brake pedal lightly at first and then more strongly.
- To make full use of engine braking, change to a lower shift point before descending a slope.

Overheating

This will normally occur as a result of some mechanical failure. If your vehicle should overheat, stop and check for a loose or broken water pump/alternator drive belt, a blocked radiator air intake or a low coolant level. If these items are satisfactory the overheating could be caused by a number of mechanical causes that would have to be checked at a competent service centre.

CAUTION

- If the engine overheats, reference should be made to “Engine overheating” section of “For emergencies” prior to taking any corrective action.

CAUTION

- On vehicles equipped with A/T or CVT, if the  warning display is showing, the temperature of the A/T fluid, CVT fluid is high. Read the reference page and take the required measures. Refer to “When a malfunction occurs in the A/T” on page 6-41 and “When a malfunction occurs in the CVT” on page 6-48.

For pleasant driving

Important air conditioning operation tips.....	7-02	Ashtray*.....	7-79
Ventilators.....	7-02	Accessory socket.....	7-80
Automatic air conditioning*.....	7-05	Interior lamps.....	7-80
Dual-zone automatic climate control air conditioning*.....	7-10	Storage spaces.....	7-84
Customizing the air conditioning.....	7-15	Drink holder.....	7-85
Air purifier.....	7-22	Bottle holder.....	7-85
LW/MW/FM radio/CD player*.....	7-22	Cargo area cover*.....	7-86
Handling of Discs.....	7-25	Assist grips.....	7-87
Audio Files (MP3/WMA/AAC).....	7-26	Coat hook.....	7-88
Important Points on Safety for the Customer.....	7-30	Luggage hooks.....	7-88
Operation Keys.....	7-31	Convenient hook.....	7-88
Listening to the Radio.....	7-34	Luggage floor board.....	7-89
Listening to DAB*.....	7-35		
Listening to Traffic Messages.....	7-37		
Listening to CDs.....	7-37		
Listening to MP3s.....	7-38		
Listening to an iPod.....	7-39		
Listening to Audio Files on a USB Device.....	7-41		
To play iPod/USB memory device tracks via voice operation (vehicles with Bluetooth® 2.0 interface).....	7-43		
Listening to Bluetooth® Audio*.....	7-46		
Display Indicator.....	7-48		
Audio Quality and Volume Balance Adjustment.....	7-49		
System Settings.....	7-50		
Troubleshooting.....	7-54		
Link System*.....	7-56		
Bluetooth® 2.0 interface*.....	7-56		
USB input terminal*.....	7-76		
Sun visors.....	7-78		

Important air conditioning operation tips

Important air conditioning operation tips

CAUTION

- The engine speed may increase when the air conditioning is operating. With an increased engine speed, an A/T or CVT vehicle will creep to a greater degree than with a lower engine speed. Fully depress the brake pedal to prevent the vehicle from creeping.

7

- Park the vehicle in the shade. Parking in the hot sun will make the vehicle inside extremely hot, and it will require more time to cool the interior. If it is necessary to park in the sun, open the windows for the first few minutes of air conditioning operation to expel the hot air.
- Close the windows when the air conditioning is in use. The entry of outside air through open windows will reduce the cooling efficiency.
- Too much cooling is not good for the health. The inside air temperature should only be 5 to 6 °C below the outside air temperature.

- When operating the system, make sure the air intake, which is located in front of the windscreen, is free of obstructions such as leaves and snow. Leaves collected in the air-intake plenum may reduce air flow and plug the plenum water drains.

Air conditioning system refrigerant and lubricant recommendations

If the air conditioning seems less effective than usual, the cause might be a refrigerant leak. We recommend you to have the system inspected.

The air conditioning system in your vehicle must be charged with the refrigerant HFO-1234yf (except for vehicles for Russia, Kazakhstan, Belarus, Ukraine and Moldova) or HFC-134a (vehicles for Russia, Kazakhstan, Belarus, Ukraine and Moldova) and the lubricant PAG46A.

Use of any other refrigerant or lubricant will cause severe damage which will result in the need to replace your vehicle's entire air conditioning system. The release of refrigerant into the atmosphere should be prevented.

It is recommended that the refrigerant be recovered and recycled for further use.

During a long period of disuse

The air conditioning should be operated for at least 5 minutes each week, even in cold weather. This is to prevent poor lubrication of the compressor internal parts and to maintain the air conditioning in the best operating condition.

Ventilators

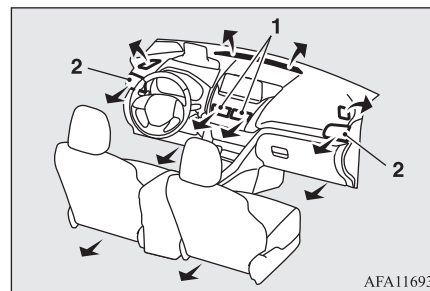

- 1- Centre ventilators
- 2- Side ventilators

Adjusting the air flow direction

Centre ventilators

Move the knob (A) to make adjustments.

To close the ventilator, move the knob (A) to the inside as far as possible.

1. Open
2. Close

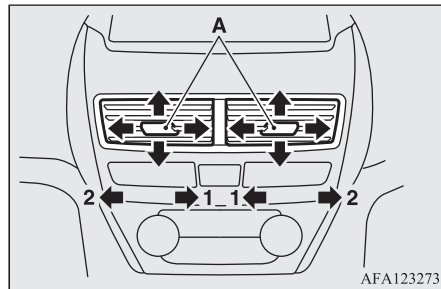

CAUTION

- Be careful not to spill beverages, etc., into the ventilators. Doing so might cause the air conditioning not to function normally.

NOTE

- The cool air from the ventilators may appear as a mist. This is due to moist air being suddenly cooled by the air conditioning. This will clear after a few moments.

1. Close
2. Open



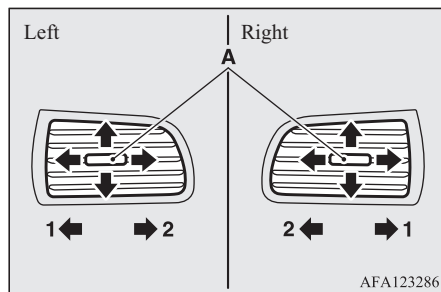

Side ventilators

Move the knob (A) to make adjustments. To close the ventilator, move the knob (A) to the outside as far as possible.



Ventilators

Changing the position of air flowing from the ventilators

Each time the MODE switch is pressed, the mode changes to the next one in the following sequence: “” → “” → “” → “” → “”.





To change to the “” position, press the demister switch.

These symbols are used in the next several illustrations to demonstrate the quantity of air coming from the ventilators.

- : Small amount of air from the ventilators
- ➔ : Medium amount of air from the ventilators
- ➡ : Large amount of air from the ventilators

7

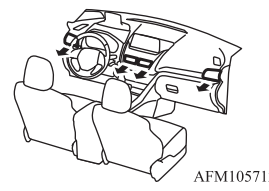
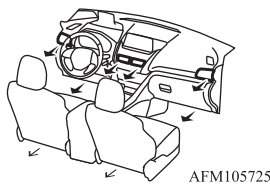
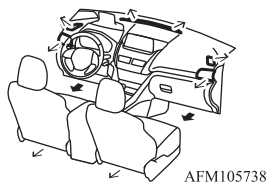

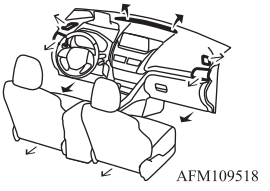
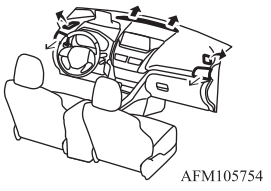
The mode selection and air flowing from the ventilators

 Face position	 Foot/Face position	 Foot position
 <p style="text-align: center;">AFM105712</p>	 <p style="text-align: center;">AFM105725</p>	 <p style="text-align: center;">AFM105738</p>
 Foot/Demister position		 Demister position
 <p style="text-align: center;">AFM109518</p>		 <p style="text-align: center;">AFM105754</p>

7-04 For pleasant driving

OGKE20E1

NOTE

- If your vehicle is equipped with the Auto Stop & Go (AS&G) system, the windows may start to fog up while the AS&G system is operating. If this occurs, press the demister switch to remove fog from the windows.
- When using the “” or “” position, set the outside position to prevent the windows from fogging up.

Automatic air conditioning*

The air conditioning can only be used while the engine is running.

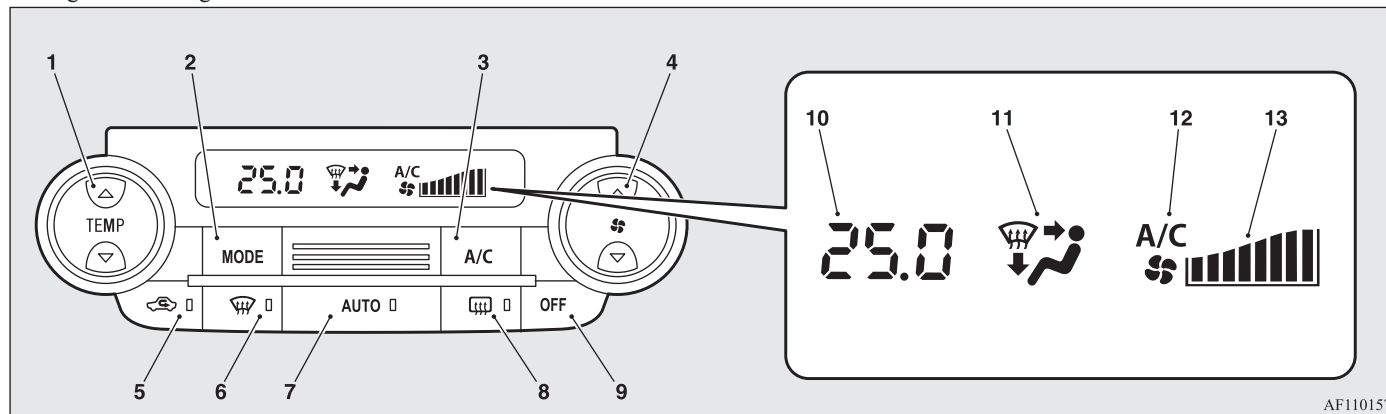

AF1101574

- | | |
|--|--|
| 1. Temperature control switch → p. 7-07 | 7. AUTO switch → p. 7-07 |
| 2. MODE switch → p. 7-04 | 8. Rear window demister switch → p. 5-72 |
| 3. A/C switch → p. 7-08 | 9. OFF switch → p. 7-06 |
| 4. Blower speed selection switch → p. 7-07 | 10. Temperature display → p. 7-07 |
| 5. Air selection switch → p. 7-08 | 11. Mode selection display → p. 7-04 |
| 6. Demister switch → p. 7-06 | 12. Air conditioning indicator → p. 7-08 |
| | 13. Blower speed display → p. 7-07 |

● Usage

- Changing the position of air flowing from the ventilators → p. 7-04
- Demisting of the windshield and door windows → p. 7-06
- Operating the system in automatic mode → p. 7-07

For pleasant driving 7-05

Automatic air conditioning*

- Operating the system in manual mode → p. 7-07
- Adjusting the blower speed → p. 7-07
- Adjusting the temperature control → p. 7-07
- Switching the air conditioning system ON/OFF → p. 7-08
- Switching outside air and recirculated air → p. 7-08
- Driving in polluted outside air conditions → p. 7-09

7

NOTE

- In extreme cold, the air conditioning control panel screen may operate sluggishly. This does not indicate a problem. It will disappear when the vehicle interior temperature rises to a normal temperature.

Demisting of the windscreen and door windows

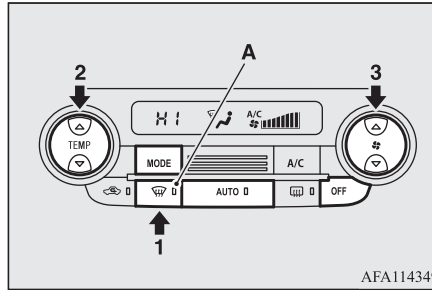

1. Press the demister switch to change to the “” position. When the demister switch is pressed, the indication lamp (A) comes on.
2. Set the temperature rather high by using the temperature control switch.
3. Select your desired blower speed by pressing the blower speed selection switch.

Press the demister switch, AUTO switch, MODE switch or OFF switch to turn off the demister mode.

CAUTION

- For safety, make sure you have a clear view through all the windows.

CAUTION

- When setting the MODE switch to the “” position, it also can prevent the windows from fogging up. But the air conditioning system does not operate automatically and outside air (as opposed to recirculated air) is not selected. If operating the air conditioning system and switching to outside air, press the A/C switch and the air selection switch.
- Do not set the temperature to the max. cool position. Cool air will blow against the window glasses and prevent demisting.

NOTE

- When demisting quick, set the blower to the maximum speed and the temperature to the highest position.
- To demist the door windows effectively, direct the air flowing of the side ventilators towards the door windows.
- When the demister switch is pressed, the air conditioning system automatically operates and outside air (as opposed to recirculated air) is selected. This automatic switching control is carried out to prevent misting of the windows even if “Disable automatic air conditioning control” or “Disable automatic air control” is set. (Refer to “Customizing the air conditioning” on page 7-15.)

Operating the system in auto-matic mode

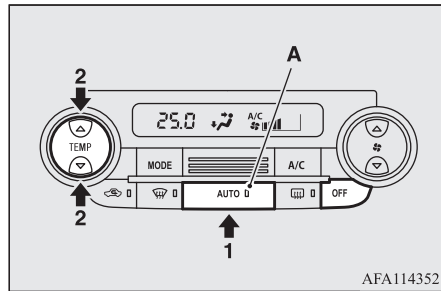

In normal conditions, use the system in the AUTO mode and follow these procedures:

1. Push the AUTO switch.
2. Set the temperature control switch to the desired temperature.

Press the OFF switch to turn off the air conditioning system.

The mode selection, blower speed adjustment, recirculated/outside air selection, temperature adjustment, and air conditioning ON/OFF status are all controlled automatically. When the AUTO switch is pressed, the indication lamp (A) comes on.

NOTE

- If the blower speed selection switch, A/C switch, MODE switch, or air selection switch is operated while the system is operating in the AUTO mode, the activated function overrides the corresponding function of automatic control. All other functions remain under automatic control.
- Never place anything on top of the interior air temperature sensor (B), which will prevent it from functioning properly.

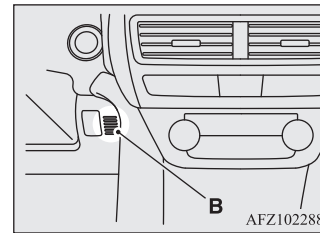

Operating the system in manual mode

Blower speed and ventilator mode may be controlled manually by setting the blower speed selection switch and the MODE switch to the desired positions.

To return to automatic operation, press the AUTO switch.

Adjusting the blower speed

Press ▲ of the blower speed selection switch to increase the blower speed.

Press ▼ of the blower speed selection switch to decrease the blower speed.

The selected blower speed (A) will be shown in the display.

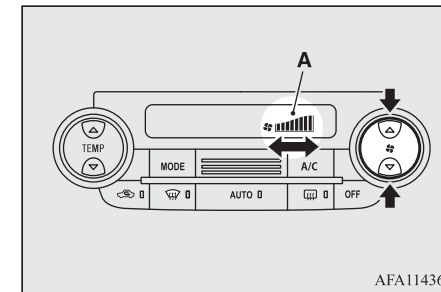

Adjusting the temperature control

Press ▲ of the temperature control switch to increase the temperature.

Press ▼ of the temperature control switch to decrease the temperature.

Automatic air conditioning*

The selected temperature (A) will be shown in the display.

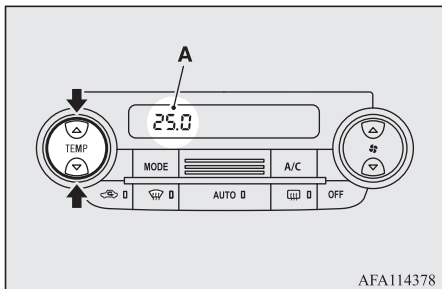

NOTE

- The temperature value of air conditioning is switched in conjunction with outside temperature display unit of the multi-information display. Refer to “Changing the temperature unit” on page 5-16.
- While the engine coolant temperature is low, the temperature of air flowing will not be changed, even if you have selected warm air with the switch. To prevent the windscreen and windows from fogging up, the mode selection will be changed to “ ” and the blower speed will be reduced while the system is operating in the AUTO mode.
- When the temperature is set to the highest or the lowest, the air selection and the air con-

NOTE

ditioning will be automatically changed as follows.

Also, if the air selection is operated manually after an automatic changeover, manual operation will be selected.

- When the temperature is set to the highest setting (HI). Outside air will be introduced and the air conditioning will stop.
- When the temperature is set to the lowest setting (LO). Inside air will be recirculated and the air conditioning will operate.

- The settings described above are the factory settings.

The air selection and air conditioning switches can be customized (function setting changed), and the automatic switching of outside air and the air conditioning according to operating conditions can be changed as desired.

For further information, we recommend you to consult a MITSUBISHI MOTORS Authorized Service Point.

Refer to “Customizing the air conditioning” on page 7-15.

Switching the air conditioning system ON/OFF

Press the switch to turn the air conditioning on, the “A/C” indicator (A) will be shown in the display.

Press the switch again to switch it off.

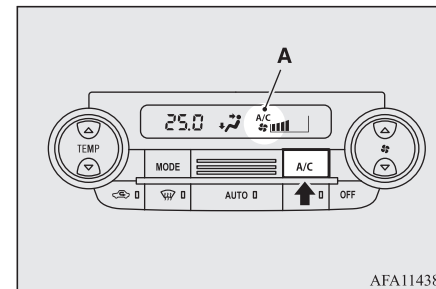

Switching outside air and recirculated air

To change the air selection, simply press the air selection switch.

- Outside air: Indication lamp (A) is OFF. Outside air is introduced into the passenger compartment.

- Recirculated air: Indication lamp (A) is ON
Air is recirculated inside the passenger compartment.

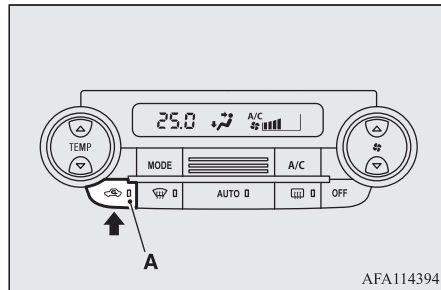

CAUTION

- Normally, use the outside position to prevent the windows from fogging up. Use of the recirculation position for extended time may cause the windows to fog up. Switch to the outside position periodically to increase ventilation.

NOTE

- If effective cooling performance is desired, use the recirculation position.
- When pressing the AUTO switch after manual operation, the air selection switch is also controlled automatically.

NOTE

- When the engine coolant temperature rises to a certain level, the air selection is automatically switched to the recirculation position and the indication lamp (A) comes on. At this time, the system will not switch to the outside position even if the air selection switch is pressed.

Driving in polluted outside air conditions

If the outside air is dusty or otherwise contaminated when driving through a tunnel or in a traffic jam, select the recirculation position by pressing the air selection switch. Refer to “Switching outside air and recirculated air” on page 7-08.

Dual-zone automatic climate control air conditioning*

Dual-zone automatic climate control air conditioning*

The air conditioning can only be used while the engine is running.

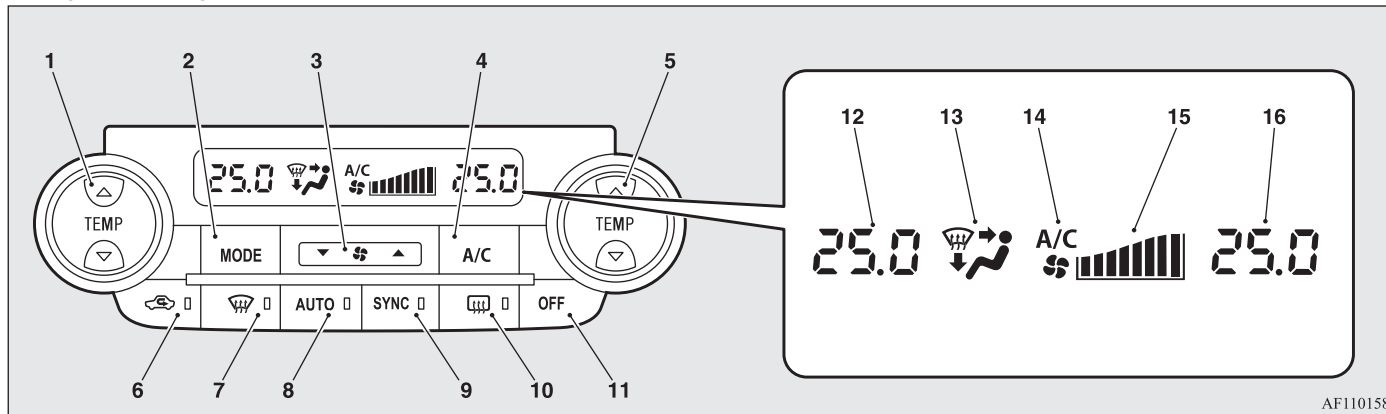

1. Driver's side temperature control switch (LHD vehicles) → p. 7-12
Passenger's side temperature control switch (RHD vehicles) → p. 7-12
2. MODE switch → p. 7-04
3. Blower speed selection switch → p. 7-12
4. A/C switch → p. 7-14
5. Passenger's side temperature control switch (LHD vehicles) → p. 7-12
Driver's side temperature control switch (RHD vehicles) → p. 7-12

6. Air selection switch → p. 7-14
7. Demister switch → p. 7-11
8. AUTO switch → p. 7-12
9. SYNC switch → p. 7-13
10. Rear window demister switch → p. 5-72
11. OFF switch → p. 7-11
12. Driver's side temperature display (LHD vehicles) → p. 7-12
Passenger's side temperature display (RHD vehicles) → p. 7-12
13. Mode selection display → p. 7-07
14. Air conditioning indicator → p. 7-14

15. Blower speed display → p. 7-12
16. Passenger's side temperature display (LHD vehicles) → p. 7-12
Driver's side temperature display (RHD vehicles) → p. 7-12

● Usage

- Changing the position of air flowing from the ventilators → p. 7-04
- Demisting of the windscreen and door windows → p. 7-11

- Operating the system in automatic mode → p. 7-12
- Operating the system in manual mode → p. 7-12
- Adjusting the blower speed → p. 7-12
- Adjusting the temperature control → p. 7-12
- To control the driver's side and the passenger's side temperature independently → p. 7-13
- Switching the air conditioning system ON/OFF → p. 7-14
- Switching outside air and recirculated air → p. 7-14
- Driving in polluted outside air conditions → p. 7-14

NOTE

- In extreme cold, the air conditioning control panel screen may operate sluggishly. This does not indicate a problem. It will disappear when the vehicle interior temperature rises to a normal temperature.

Demisting of the windscreen and door windows

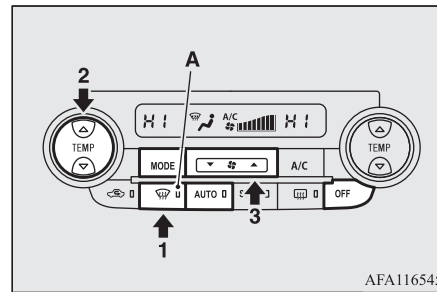

1. Press the demister switch to change to the “” position. When the demister switch is pressed, the indication lamp (A) comes on.
2. Set the temperature rather high by using the driver's side temperature control switch.
3. Select your desired blower speed by pressing the blower speed selection switch.

Press the demister switch, AUTO switch, MODE switch or OFF switch to turn off the demister mode.

CAUTION

- For safety, make sure you have a clear view through all the windows.
- When setting the MODE switch to the “” position, it also can prevent the windows from fogging up. But the air conditioning system does not operate automatically and outside air (as opposed to recirculated air) is not selected. If operating the air conditioning system and switching to outside air, press the A/C switch and the air selection switch.
- Do not set the temperature to the max. cool position. Cool air will blow against the window glasses and prevent demisting.

NOTE

- When demisting quick, set the blower to the maximum speed and the temperature to the highest position.
- To demist the door windows effectively, direct the air flowing of the side ventilators towards the door windows.
- When the demister switch is pressed, the air conditioning system automatically operates and outside air (as opposed to recirculated air) is selected. This automatic switching control is carried out to prevent misting of the windows even if “Disable automatic air conditioning control” or “Disable automatic air control” is set. (Refer to “Customizing the air conditioning” on page 7-15.)

Dual-zone automatic climate control air conditioning*

Operating the system in automatic mode

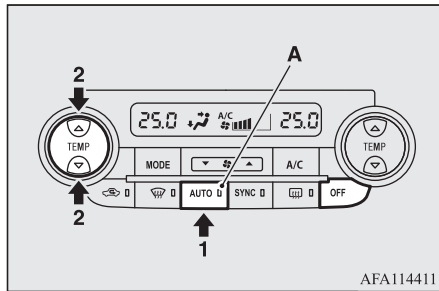

In normal conditions, use the system in the AUTO mode and follow these procedures:

1. Press the AUTO switch.
2. Set the temperature control switch to the desired temperature.

Press the OFF switch to turn off the air conditioning system.

The mode selection, blower speed adjustment, recirculated/outside air selection, temperature adjustment, and air conditioning ON/OFF status are all controlled automatically. When the AUTO switch is pressed, the indication lamp (A) comes on.

NOTE

- If the blower speed selection switch, A/C switch, MODE switch, or air selection switch is operated while the system is operating in the AUTO mode, the activated function overrides the corresponding function of automatic control. All other functions remain under automatic control.
- Never place anything on top of the interior air temperature sensor (B), which will prevent it from functioning properly.

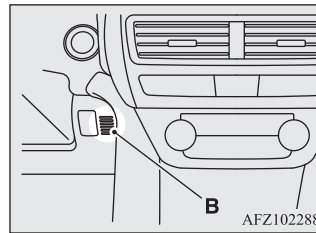

Operating the system in manual mode

Blower speed and ventilator mode may be controlled manually by setting the blower speed selection switch and the MODE switch to the desired positions.

Adjusting the blower speed

Press ▲ of the blower speed selection switch to increase the blower speed.

Press ▼ of the blower speed selection switch to decrease the blower speed. The selected blower speed (A) will be shown in the display.

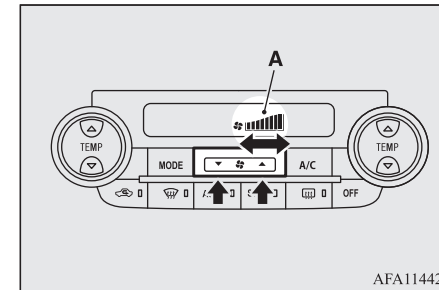

Adjusting the temperature control

Press ▲ of the temperature control switch to increase the temperature.

Press ▼ of the temperature control switch to decrease the temperature.

The selected temperature (A) will be shown in the display.

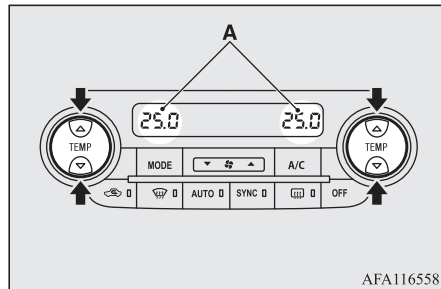

NOTE

- The temperature value of air conditioning is switched in conjunction with outside temperature display unit of the multi-information display. Refer to “Changing the temperature unit” on page 5-16.
- While the engine coolant temperature is low, the temperature of air flowing will not be changed, even if you have selected warm air with the switch. To prevent the windscreen and windows from fogging up, the mode selection will be changed to “” and the blower speed will be reduced while the system is operating in the AUTO mode.
- When the temperature is set to the highest or the lowest, the air selection and the air con-

NOTE

- ditioning will be automatically changed as follows.
- Also, if the air selection is operated manually after an automatic changeover, manual operation will be selected.
- When the temperature is set to the highest setting (HI).
Outside air will be introduced and the air conditioning will stop.
 - When the temperature is set to the lowest setting (LO).
Inside air will be recirculated and the air conditioning will operate.
 - The settings described above are the factory settings. The air selection and air conditioning switches can be customized (function setting changed), and the automatic switching of outside air and the air conditioning according to operating conditions can be changed as desired. For further information, we recommend you to consult a MITSUBISHI MOTORS Authorized Service Point. Refer to “Customizing the air conditioning” on page 7-15.

To control the driver’s side and the passenger’s side temperature independently

When the indication lamp (A) goes off by pressing the passenger’s side temperature control switch (B) or the SYNC switch, the driver’s side and the passenger’s side temperature can be controlled independently.

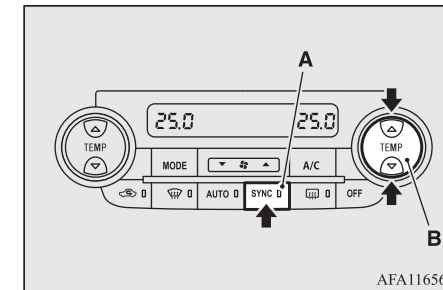

7

NOTE

- When the indication lamp (A) comes on by pressing the SYNC switch, the passenger’s side temperature will be controlled to the same setting temperature as the driver’s side. When the indication lamp (A) illuminates, if the driver’s side temperature control switch is pressed, the passenger’s side setting temperature will be synchronized to the driver’s side.

Dual-zone automatic climate control air conditioning*

Switching the air conditioning system ON/OFF

Press the switch to turn the air conditioning on, the “A/C” indicator (A) will be shown in the display.

Press the switch again to switch it off.

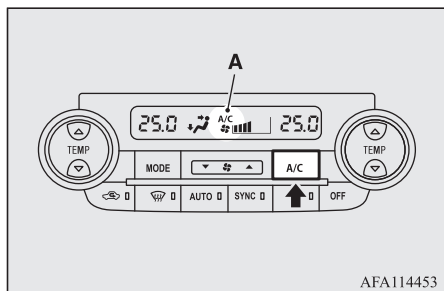

Switching outside air and recirculated air

To change the air selection, simply press the air selection switch.

- Outside air: Indication lamp (A) is OFF
Outside air is introduced into the passenger compartment.

- Recirculated air: Indication lamp (A) is ON
Air is recirculated inside the passenger compartment.

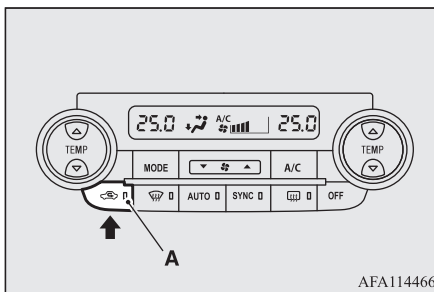

CAUTION

- Normally, use the outside position to prevent the windows from fogging up.
Use of the recirculation position for extended time may cause the windows to fog up.
Switch to the outside position periodically to increase ventilation.

NOTE

- If effective cooling performance is desired, use the recirculation position.
- When pressing the AUTO switch after manual operation, the air selection switch is also controlled automatically.

NOTE

- When the engine coolant temperature rises to a certain level, the air selection is automatically switched to the recirculation position and the indication lamp (A) comes on. At this time, the system will not switch to the outside position even if the air selection switch is pressed.

Driving in polluted outside air conditions

If the outside air is dusty or otherwise contaminated when driving through a tunnel or in a traffic jam, select the recirculation position by pressing the air selection switch.

Refer to “Switching outside air and recirculated air” on page 7-14.

Customizing the air conditioning

The following customise functions can be applied.

Item	Setting content	Factory setting	Modification method			
			Automatic climate control panel	Smart phone Link Display Audio ^{*1}	MITSUBISHI Multi-Communication System (MMCS) ^{*2}	MITSUBISHI MOTORS Authorized Service Point
Recirculation control ^{*3}	Allow you to select the function that switches automatically or manually between recirculate and refresh mode.	Automatically	○	○	○	○

7

^{*1}: Refer to Smartphone Link Display Audio instruction for procedure details.

^{*2}: Refer to MMCS instruction for procedure details.

^{*3}: When the demister switch is pushed, the air conditioning is automatically switched to refresh mode to prevent fogging of the window even if the air conditioning is set to the manual mode.

^{*4}: When the demister switch is pushed, the air conditioning is automatically switched to ON mode to prevent fogging of the window even if the air conditioning is set to the manual mode.

^{*5}: During economical driving, you may feel that the air conditioning does not work sufficiently because operation of the air conditioning controlled.

Customizing the air conditioning

Item	Setting content	Factory setting	Modification method			
			Automatic climate control panel	Smart phone Link Display Audio ^{*1}	MITSUBISHI Multi-Communication System (MMCS) ^{*2}	MITSUBISHI MOTORS Authorized Service Point
A/C switch control ^{*4}	Allows you to select the function that switches automatically or manually between ON and OFF mode of air conditioning.	Automatically	○	○	○	○

7

^{*1}: Refer to Smartphone Link Display Audio instruction for procedure details.

^{*2}: Refer to MMCS instruction for procedure details.

^{*3}: When the demister switch is pushed, the air conditioning is automatically switched to refresh mode to prevent fogging of the window even if the air conditioning is set to the manual mode.

^{*4}: When the demister switch is pushed, the air conditioning is automatically switched to ON mode to prevent fogging of the window even if the air conditioning is set to the manual mode.

^{*5}: During economical driving, you may feel that the air conditioning does not work sufficiently because operation of the air conditioning controlled.

Customizing the air conditioning

Item	Setting content	Factory setting	Modification method			
			Automatic climate control panel	Smart phone Link Display Audio ^{*1}	MITSUBISHI Multi-Communication System (MMCS) ^{*2}	MITSUBISHI MOTORS Authorized Service Point
ECO mode ^{*5}	Allows you to select the function that operates or does not operate economical driving for air conditioning during ECO mode operation (For only vehicles with ECO mode switch).	ECO	—	○	○	○

7

^{*1}: Refer to Smartphone Link Display Audio instruction for procedure details.

^{*2}: Refer to MMCS instruction for procedure details.

^{*3}: When the demister switch is pushed, the air conditioning is automatically switched to refresh mode to prevent fogging of the window even if the air conditioning is set to the manual mode.

^{*4}: When the demister switch is pushed, the air conditioning is automatically switched to ON mode to prevent fogging of the window even if the air conditioning is set to the manual mode.

^{*5}: During economical driving, you may feel that the air conditioning does not work sufficiently because operation of the air conditioning controlled.

Customizing the air conditioning

Item	Setting content	Factory setting	Modification method			
			Automatic climate control panel	Smart phone Link Display Audio ^{*1}	MITSUBISHI Multi-Communication System (MMCS) ^{*2}	MITSUBISHI MOTORS Authorized Service Point
7 Foot/Demister airflow ratio	When you select by  MODE switch, this allows you to set the ratio between ventilation to your feet and ventilation to the window.	Normal	—	○	○	○

*1: Refer to Smartphone Link Display Audio instruction for procedure details.

*2: Refer to MMCS instruction for procedure details.

*3: When the demister switch is pushed, the air conditioning is automatically switched to refresh mode to prevent fogging of the window even if the air conditioning is set to the manual mode.

*4: When the demister switch is pushed, the air conditioning is automatically switched to ON mode to prevent fogging of the window even if the air conditioning is set to the manual mode.

*5: During economical driving, you may feel that the air conditioning does not work sufficiently because operation of the air conditioning controlled.

Customizing the air conditioning

Item	Setting content	Factory setting	Modification method			
			Automatic climate control panel	Smart phone Link Display Audio ^{*1}	MITSUBISHI Multi-Communication System (MMCS) ^{*2}	MITSUBISHI MOTORS Authorized Service Point
Face/Foot airflow ratio	When you select by  MODE switch, this allows you to set the ratio between ventilation to your upper body and ventilation to your feet.	Normal	–	○	○	○

7

*1: Refer to Smartphone Link Display Audio instruction for procedure details.

*2: Refer to MMCS instruction for procedure details.

*3: When the demister switch is pushed, the air conditioning is automatically switched to refresh mode to prevent fogging of the window even if the air conditioning is set to the manual mode.

*4: When the demister switch is pushed, the air conditioning is automatically switched to ON mode to prevent fogging of the window even if the air conditioning is set to the manual mode.

*5: During economical driving, you may feel that the air conditioning does not work sufficiently because operation of the air conditioning controlled.

Customizing the air conditioning

Item	Setting content	Factory setting	Modification method			
			Automatic climate control panel	Smart phone Link Display Audio ^{*1}	MITSUBISHI Multi-Communication System (MMCS) ^{*2}	MITSUBISHI MOTORS Authorized Service Point
7 Automatic rear operation demist at engine start	Allows you to select the function that switches auto or manual operation of the rear demister at the engine start when the outside air temperature is low.	Off	–	○	○	○

^{*1}: Refer to Smartphone Link Display Audio instruction for procedure details.

^{*2}: Refer to MMCS instruction for procedure details.

^{*3}: When the demister switch is pushed, the air conditioning is automatically switched to refresh mode to prevent fogging of the window even if the air conditioning is set to the manual mode.

^{*4}: When the demister switch is pushed, the air conditioning is automatically switched to ON mode to prevent fogging of the window even if the air conditioning is set to the manual mode.

^{*5}: During economical driving, you may feel that the air conditioning does not work sufficiently because operation of the air conditioning controlled.

Item	Setting content	Factory setting	Modification method			
			Automatic climate control panel	Smart phone Link Display Audio ^{*1}	MITSUBISHI Multi-Communication System (MMCS) ^{*2}	MITSUBISHI MOTORS Authorized Service Point
Setting temperature	When you feel that it is hot or cold to the setting temperature, it is possible to adjust so that you can feel more comfortable.	Normal	—	—	—	○

*1: Refer to Smartphone Link Display Audio instruction for procedure details.

*2: Refer to MMCS instruction for procedure details.

*3: When the demister switch is pushed, the air conditioning is automatically switched to refresh mode to prevent fogging of the window even if the air conditioning is set to the manual mode.

*4: When the demister switch is pushed, the air conditioning is automatically switched to ON mode to prevent fogging of the window even if the air conditioning is set to the manual mode.

*5: During economical driving, you may feel that the air conditioning does not work sufficiently because operation of the air conditioning controlled.

Customizing the automatic climate control panel

A setting can be changed by holding down the switch^{*1} for approximately 10 seconds or more.

- When the setting is changed from enable to disable 3 sounds are emitted and the indicator^{*2} flashes three times.

- When the setting is changed from disable to enable 2 sounds are emitted and the indicator^{*3} flashes three times.

*1 In case of A/C switch control customizing, the A/C switch is appropriated. In case of recirculation control customizing, the air selection switch is appropriated.

*2 In case of A/C switch control customizing, the “A/C” indicator in the display is appropriated. In case of recirculation control customizing, the air selection switch indication lamp is appropriated.

Air purifier

Air purifier

An air filter has been incorporated into this air conditioning so that dirt and dust are cleaned from the air.

Replace the air filter periodically as its ability to clean the air will be reduced as it collects pollen and dirt. For the maintenance interval, refer to the “SERVICE BOOKLET”.

7

NOTE

- Operation in certain conditions such as driving on a dusty road and frequent use of the air conditioning can lead to reduction of service life of the filter. When you feel that the air flow is lower than normal or when the windscreen or windows start to fog up easily, replace the air filter. We recommend you to have it checked.

LW/MW/FM radio/CD player*

The audio system can only be used when the ignition switch or the operation mode is in ON or ACC.

*3 In case of A/C switch control customizing, the “A/C” indicator in the display is appropriated. In case of recirculation control customizing, the air selection switch indication lamp is appropriated.

7-22 For pleasant driving

NOTE

- To listen to the audio system while the engine is not running, turn the ignition switch to the “ACC” position or put the operation mode in ACC. If the ignition switch or the operation mode is left in ACC, the accessory power will automatically turn off after a certain period of time and you will no longer be able to use the audio system. The accessory power comes on again if the ignition switch or the engine switch is operated with it in the “ACC” position. Refer to “ACC power auto-cutout function” on pages 6-14 and 6-17.
- If a cellular phone is used inside the vehicle, it may create noise from the audio equipment. This does not mean that anything is wrong with your audio equipment. In such a case, use the cellular phone at a place as far away as possible from the audio equipment.
- If foreign objects or water get into the audio equipment, or if smoke or a strange odour comes from it, immediately turn off the audio system. We recommend you to have it checked. Never try to repair it by yourself. Avoid continuous usage without inspection by a qualified person.

Important Points on Usage

iPod/iPhone Playback Function*

- This product supports audio playback from iPod/iPhone devices, however differing versions mean that playback cannot be guaranteed.
- Please be aware that depending on the iPod/iPhone model or version, operation may differ.

How to Clean

- If the product becomes dirty, wipe with a soft cloth.
- If very dirty, use a soft cloth dipped in neutral detergent diluted in water, and then wrung out. Do not use benzene, thinners, or other chemical wipes. This may harm the surface.

Trademarks

- Product names and other proper names are the trademarks or registered trademarks of their respective owners.
- Furthermore, even if there is no specific denotation of trademarks or registered trademarks, these are to be observed in their entirety.

Made for



iPod



iPhone

“Made for iPod”, “Made for iPhone” mean that an electronic accessory has been designed to connect specifically to iPod or iPhone, respectively, and has been certified by the developer to meet Apple performance standards. iPhone, iPod, iPod classic, iPod nano, and iPod touch are trademarks of Apple

Inc., registered in the U.S. and other countries.

Apple is not responsible for the operation of this device or its compliance with safety and regulatory standards.

 **NOTE**











- iPod and iTunes licensing allows individual users to privately reproduce and play back non-copyrighted material as well as material that may be legally copied and reproduced. Infringement of copyright is prohibited.

 **NOTE**

- For vehicles with a Bluetooth^(R) 2.0 interface, the types of devices that can be connected may vary. For details, access the MITSUBISHI MOTORS website. Please read and agree to the “Warning about Links to the Web Sites of Other Companies”. The websites mentioned above may connect you to websites other than the MITSUBISHI MOTORS website. <http://www.mitsubishi-motors.com/en/products/index.html> Bluetooth^(R) is a registered trademark of BLUETOOTH SIG, INC.

LW/MW/FM radio/CD player*

7

iPod		iPod classic		
				
iPod 5th generation (video) 60GB 80GB	iPod 5th generation (video) 30GB	iPod classic 160GB (2009)	iPod classic 160GB (2007)	iPod classic 80GB
iPod nano				
				
iPod nano 6th generation 8GB 16GB	iPod nano 5th generation (video camera) 8GB 16GB	iPod nano 4th generation (video) 8GB 16GB		
				
iPod nano 3rd generation (video) 4GB 8GB	iPod nano 2nd generation (aluminium) 2GB 4GB 8GB	iPod nano 1st generation 1GB 2GB 4GB		

AA5013326

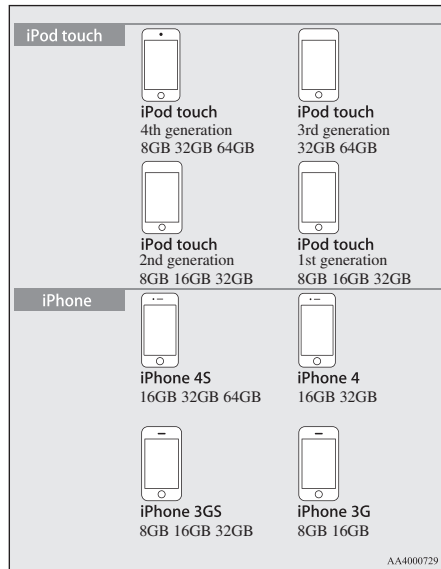

Handling of Discs

This explains care that should be taken in the handling of discs.

Important Points on Handling

- Fingerprints or other marks on the read surface of the disc may result in its content being more difficult to read. When holding the disc, grip both edges, or one edge and the centre hole, in order that the read surface is not touched.
- Do not affix paper or stickers, or otherwise damage the disc.
- Do not forcefully insert a disc if another is already within the device. This can result in damage to discs, or malfunction.

Cleaning

- Periodically clean the read surface of the disc. When cleaning, do not wipe in a circular motion. Instead, wipe gently outwards from the centre of the disc to the outer edge.
- New discs may have burring around the outer edge or in the hole in the centre. Ensure you check for these. If there are burrs, these may lead to faulty operation, therefore ensure these are removed.

Important Points on Storage

- When not using discs, ensure these are kept in cases, and stored out of direct sunlight.

- If discs are not going to be used for a long period of time, remove these from the product.

Disc Playback Environment

In cold environments such as in mid-winter when the interior of the vehicle is cold, turning the heater on and immediately trying to use the product may cause condensation (water droplets) to form on the disc and internal optical components, and this may prevent the product from operating correctly. In these conditions, remove the disc, and wait a short time before use.

7

Copyright





Actions such as unauthorized reproduction, broadcast, public performance, or rental of discs that comprise other than personal use are prohibited by law.

Types of Disc That Can Be Played Back

The following marks are printed on the disc label, package, or jacket.

Audio Files (MP3/WMA/AAC)

7

Type	Size	Maximum play-back time	Comments
 CD-DA	12 cm	74 minutes	—
 CD-TEXT	12 cm	74 minutes	—
  CD-R/RW	12 cm	—	•Disc containing MP3 files

Discs That May Not Be Played Back

- Playback of discs other than those described in “Types of Disc That Can Be Played Back” is not guaranteed.
- 8 cm discs may not be used.

- Do not insert irregularly-shaped discs (for example, heart-shaped), as these may result in malfunction. Additionally, discs that have transparent portions may not be played back.
- Discs that have not been finalized cannot be played back.
- Even if recorded using the correct format on a recorder or computer, application software settings and environments; disc peculiarities, damage, or marking; or dirt or condensation on the lens inside the product may render the disc unplayable.
- Depending on the disc, some functions may not be used, or the disc may not play back.
- Do not use discs with cracks or warps.
- If the disc has stickers affixed, remains from removed stickers, or affixed adhesive, then do not use the disc.
- Discs that have decorative labels or stickers may not be used.

Nonstandard CDs

This product will play back audio CDs, however please be aware of the following points regarding CD standards.

- Ensure that you use discs with  on the label surface.

- Playback of other than standard CDs is not guaranteed. Even if the audio can be played back, the audio quality cannot be guaranteed.
- When playing back other than standard CDs, the following may occur.
 - There may be noise during playback.
 - There may be jumping in the audio.
 - The disc may not be recognized.
 - The first track may not be played back.
 - It may take longer than usual until start of playback of tracks.
 - Playback may start from within the track.
 - Some parts may not be played back.
 - Tracks may freeze during playback.
 - Tracks may be displayed erroneously.

Audio Files (MP3/WMA/AAC)

This product can play back MP3/WMA/AAC format audio files recorded on CD-ROM, CD-R/RW, and USB devices.

There are limitations on the files and media that can be used, therefore read the following prior to recording MP3/WMA/AAC format audio files on discs or USB devices.

Additionally, ensure you read the user manuals for your CD-R/RW drive and the writing software, and ensure these are used correctly.

Audio Files (MP3/WMA/AAC)

If the MP3/WMA/AAC format audio files includes title information or other data, then this can be displayed.

NOTE

- Files larger than 2GB in size cannot be played back.

CAUTION

- CD-ROM and CD-R/RW media can only play back MP3 format audio files.
- Actions such as copying audio CDs or files and either distributing these to others for free or for charge, or uploading files via the Internet or other means to servers is an infringement of the law.
- Do not append the file extensions “.mp3”, “.wma”, or “.m4a”, to other than MP3/WMA/AAC format files. Playing back discs with these types of files recorded upon them may cause the files to be incorrectly identified for playback, which may lead to loud noise, resulting in speaker damage or accident.

Data Formats That Can Be Played Back

Data formats that can be played on discs (CD-ROM, CD-R/RW) and USB devices differ.

Data format	DISC	USB device
MP3	○	○
WMA	X	○
AAC	X	○

Folder Structure

Up to 8 folder levels can be recognized.

You can create a folder structure as in Genre - Artist - Album - Track (MP3/WMA/AAC format audio files) for management of tracks.

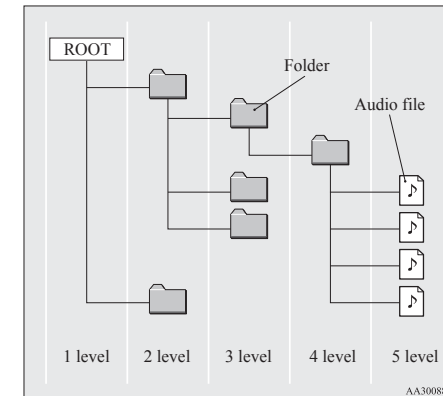

NOTE

- Depending on the condition of the disc recorder or recording software used, correct playback may not be possible. In these cases, refer to the user manual for your product or software.
- Depending on your computer's operating system, version, software, or settings, files may not have a file extension appended. In these cases, append the file extensions “.mp3”, “.wma”, or “.m4a” when copying the files.

Audio Files (MP3/WMA/AAC)

Name	Specification	Explanation	
Format specifications	ISO9660	Level 1	Maximum 8 character file name, and 3 character file extension. (single-byte alphanumeric capital letters, numerals, “_” may be used)
	ISO9660 extension	Joliet	Files names up to a maximum 64 characters can be used.
Multisession	Not supported (only first session supported)		
Maximum number of levels	8 levels (if the root is the 1 st level)		

*1: Do not include other than MP3/WMA/AAC files. However, if storing many tracks within the same folder, these may not be recognized even if less than the maximum number of tracks. In these cases, divide the tracks up into multiple folders.

Name	Specification	Explanation
Maximum folder number	700 folders (including root)	
Maximum file number*1	65,535 files (total number on media. Other than MP3, WMA, and AAC files not included)	
File name and folder name restrictions	Maximum 64 bytes (for Unicode, 32 characters), files/folders with file/folder names longer than this will not be displayed or played back.	
USB supported formats	The recommended file system is FAT32. 1 partition only	

*1: Do not include other than MP3/WMA/AAC files. However, if storing many tracks within the same folder, these may not be recognized even if less than the maximum number of tracks. In these cases, divide the tracks up into multiple folders.

NOTE

- The order in which folders and audio files are displayed on this product may be different to how they are displayed on a computer.

What Is MP3?

MP3 is the abbreviation of “MPEG-1 Audio Layer 3”. MPEG is an abbreviation of “Motion Picture Experts Group”, and this is a video compression standard used in video CDs, etc.

MP3 is one of the audio compression methods contained in the MPEG audio standard, and reduces the quality of sounds that are beyond the auditory resolution of the human ear and that are hidden by louder sounds, thus creating high-quality data with a lower data size.

This can compress CD audio to approximately 1/10 its original data size without perceptible loss, approximately 10 CDs can be written to a single CD-R/RW disc.

CAUTION

- MP3 files different to the standards at right may not play back correctly, or file/folder names may not be displayed correctly.

Standards for MP3 Files That Can Be Played Back

Specifications for MP3 files that can be played are as shown below.

Item	Details
Specification	MPEG-1 AUDIO LAYER3 MPEG-2 AUDIO LAYER3
Sampling frequency [kHz]	MPEG-1: 32/44.1/48 MPEG-2: 16/22.05/24
Bit rate [kbps]	MPEG-1: 32 to 320 MPEG-2: 8 to 160
VBR (variable bit rate)	Support
Channel mode	Stereo/ Joint stereo/ Dual channel/ Monaural
File extension	mp3
Supported tag information	ID3 tag Ver. 1.0, Ver. 1.1, Ver. 2.2, Ver. 2.3, Ver. 2.4 (ISO-8859-1, UTF-16 (Unicode)), Titles, Artist name, Album name

Item	Details
Maximum number of characters that can be indicated on the display	64 characters

What Is WMA?

WMA is the abbreviation of Windows Media Audio, and this is an audio compression format from Microsoft. This is a compression format that has a higher compression ratio than MP3.

 **NOTE**

- Microsoft, Windows Media, and Windows are registered trademarks of Microsoft Corporation (USA) and in other countries.

 **CAUTION**

- WMA supports digital rights management (DRM). This product cannot play back WMA files protected using this system.
- WMA files different to the standards at right may not play back correctly, or file/folder names may not be displayed correctly.
- “Pro”, “Lossless”, and “Voice” are not supported.

Standards for WMA Files That Can Be Played Back

Specifications for WMA files that can be played are as shown below.

Item	Details
Specification	Windows Media Audio Version 7.0/8.0/9.0
Sampling frequency [kHz]	32/44.1/48
Bit rate [kbps]	48 to 320
VBR (variable bit rate)	Support
Channel mode	Stereo/Monaural
File extension	wma
Supported tag information	WMA tags Title name, Artist name, Album name
Maximum number of characters that can be indicated on the display	64 characters

Important Points on Safety for the Customer

What is AAC?

AAC is the abbreviation of Advanced Audio Coding, and this is an audio compression standard used in “MPEG-2” and “MPEG-4”. This features 1.4x the compression of MP3, with comparable audio quality.

CAUTION

- AAC supports digital rights management (DRM). This product cannot play back AAC files protected using this system.
- AAC files different to the standards at right may not play back correctly, or file/folder names may not be displayed correctly.

Standards for AAC Files That Can Be Played Back

Specifications for AAC files that can be played are as shown below.

Item		Details
Specification		Advanced Audio Coding MPEG4/AAC-LC MPEG2/AAC-LC
Sampling frequency [kHz]	MPEG4	8/11.025/12/16/22.05/24/32/44.1/48
	MPEG2	8/11.025/12/16/22.05/24/32/44.1/48

Item		Details
Bit rate [kbps]	MPEG4	8 to 320
	MPEG2	8 to 320
VBR (variable bit rate)	Support	
Channel mode	Stereo/Monaural	
File extension	m4a	
Supported tag information	AAC tags or ID3 tags Title, Artist name, Album name	
Maximum number of characters that can be indicated on the display	64 characters	

Important Points on Safety for the Customer

This product features a number of pictorial indications as well as points concerning handling so that you can use the product correctly and in a safe manner, as well as prevent injury or damage to yourself, other users, or property.

WARNING

- The driver should not pay close attention to the display while driving. This may prevent the driver looking where they are going, and cause an accident.
- The driver should not perform complicated operations while driving. Performing complicated operations while driving may prevent the driver looking where they are going, and cause an accident. Therefore stop the vehicle in a safe location before performing such operations.
- Do not use during malfunctions, such as when no sound is audible. This may lead to accident, fire, or electric shock.
- Ensure water or other foreign objects do not enter the product. This may lead to smoking, fire, electric shock, or malfunction.
- Do not insert foreign objects into the disc slot. This may lead to fire, electric shock, or malfunction.
- In the event of abnormalities occurring when foreign objects or water enter the product, resulting in smoke or a strange smell, immediately stop using the product, and consult a MITSUBISHI MOTORS Authorized Service Point. Continuing to use the product may result in accident, fire, or electric shock.

⚠ WARNING

- Do not disassemble or modify the product. This may lead to malfunction, fire, or electric shock.
- During thunderstorms, do not touch the antenna or the front panel. This may lead to electrical shock from lightning.

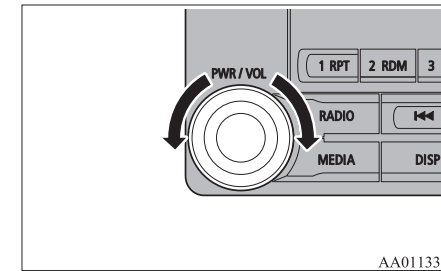
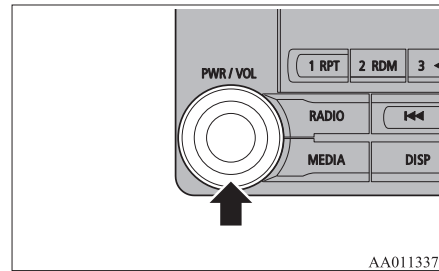

⚠ CAUTION

- Do not block ventilation holes or heat sinks on the product. Blocking ventilation holes or heat sinks may prevent heat from escaping from within the product, leading to fire or malfunction.
- Do not turn the volume up to the extent that you cannot hear sounds from outside the vehicle while driving. Driving without being able to hear sounds from outside the vehicle may result in an accident.
- Do not insert your hand or fingers into the disc slot. This may result in injury.

Turn the power on, and resume playback from the previous status.

2. Press the PWR/VOL key. Turn the power OFF.

📖 NOTE

- Hold down the steering MODE button to also turn the audio function ON/OFF.

Adjusting the Volume

1. Turn the PWR/VOL key to adjust the volume.

Turn the PWR/VOL key clockwise to increase, and counter-clockwise to decrease the volume.

7

📖 NOTE

- The maximum value for volume is 45, and the minimum is 0.
- The initial setting for volume is “17”.

Insert/Eject Discs

1. Insert the disc into the disc slot with the label surface up.

Operation Keys

Turn the Power ON/ OFF

1. Press the PWR/VOL key.

Operation Keys

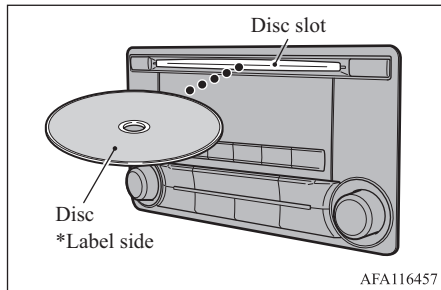

7

Push the disc in a certain amount, and the product will pull the disc in, and playback will start.

2. Press the ▲ key.
This will eject the disc from the product, so remove the disc.

⚠ CAUTION

- When replacing discs, first ensure that the vehicle is stopped in an area in which stopping is permitted.
- Do not insert your hand, fingers, or foreign objects into the disc slot. This may lead to injury, smoking, or fire.
- 8 cm CDs are not supported.

Explanation of Buttons

This explains names and functions of each part.

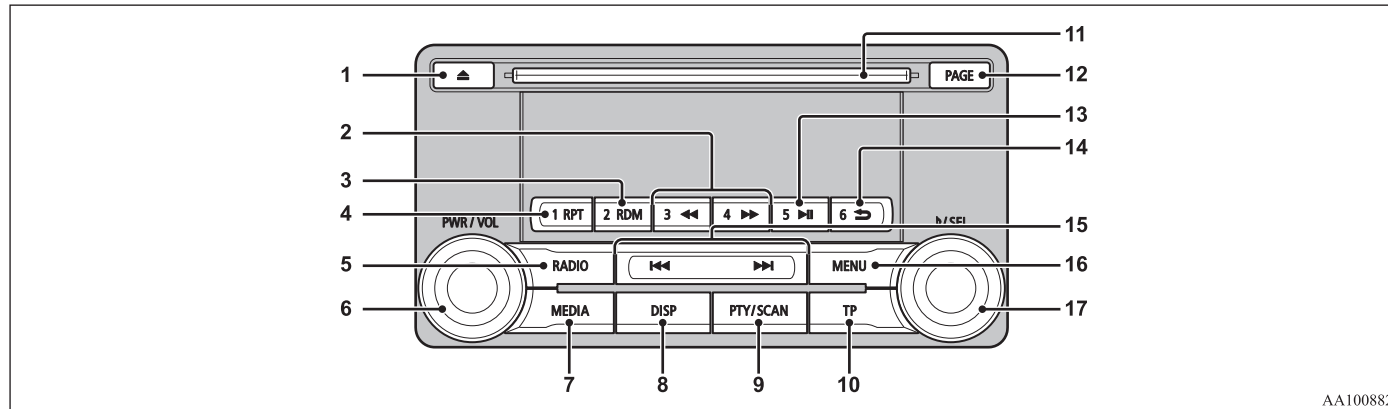

7

- | | | |
|--|--|--|
| <p>1- ▲ key
Use to eject a disc.</p> <p>2- 3◀◀ key/4▶▶ key
For audio, rewind/fast forward.
For radio, use as preset keys 3 and 4.</p> <p>3- 2RDM key
For audio, play random playback; for radio, use as preset key 2.</p> <p>4- 1RPT key
For audio, play repeat playback; for radio, use as preset key 1.</p> <p>5- RADIO key
Switch the radio and the band.</p> | <p>6- PWR/VOL key
Adjust the volume, and turn the power ON/OFF.</p> <p>7- MEDIA key
Switch between CD and other sources.</p> <p>8- DISP key
Switch the content of the display.</p> <p>9- PTY/SCAN key
For audio, play scan playback; for radio, search PTY.</p> <p>10- TP key
Receive traffic messages.</p> <p>11- Disc slot</p> | <p>12- PAGE key
Display indicator page advance.</p> <p>13- 5 ▶ key
Play/Pause Bluetooth® Audio*, and use as preset key 5 for radio.</p> <p>14- 6 ↶ key
Return during audio track search, and stop Bluetooth® Audio*.
For radio, use as preset key 6.</p> |
|--|--|--|

*Requires a separately-purchased Bluetooth®-capable audio device in equipment by type (vehicles with a Bluetooth® 2.0 interface).

Listening to the Radio

15- ◀◀ key/▶▶ key

For audio, select audio track/file; for radio, perform automatic station selection or ensemble/service station selection.

16- MENU key

Switch to Menu mode.

17- ▶/SEL key

Adjust audio quality and select items.
For radio, manually select stations.

Steering wheel audio remote control switches*

7

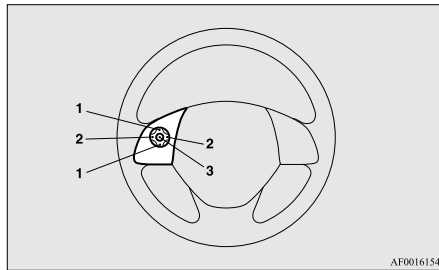

1- ▲ button, ▼ button

Adjust audio functions and the mobile phone function volume.

2- < button, > button

Select CD and other audio source tracks and radio stations.

Hold down to skip up and down through tracks.

3- MODE Key

Hold down to turn the audio function ON/OFF. Additionally, each time this is pressed, this switches the audio source. The order of switching is as shown below.

If devices are not connected, then these are to be skipped, and the next source selected.

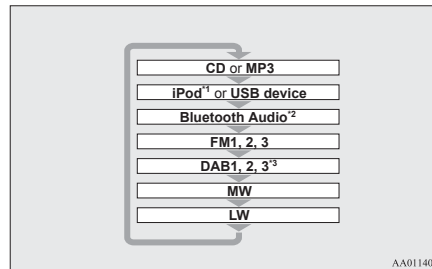

*1: An iPod cable (available separately) is required.

*2: Requires a separately-purchased Bluetooth®-capable audio device (vehicles with a Bluetooth® 2.0 interface).

*3: Requires DAB tuner connection.

Listening to the Radio

This explains how to listen to FM, MW, and LW radio broadcasts.

To Listen to the Radio

Press the RADIO key to switch the band.

Switch between FM1, FM2, FM3, MW, and LW bands.

The selected band is indicated on the display.

NOTE





- This switches in the order FM1, FM2, FM3, DAB1*, DAB2*, DAB3*, MW, and LW.

Manual/Seek Station Selection

Turn the ▶/SEL key to the frequency to listen to.

*When a DAB tuner is connected.

Listening to DAB*

 /SEL key (counter-clockwise)	Reduces the frequency being received.
 /SEL key (clockwise)	Increases the frequency being received.
 key (hold down)	Release the button to start seek station selection, and when a station is received, scanning stops.
 key (hold down)	

Preset Memory

Register the broadcast station in advance, and select this at a later time.

1. Tune in to the frequency to register.
2. Hold down any of the keys from the IRPT key to the 6  key.

A “Beep” sounds, and the preset key is registered.

NOTE

- The preset memory can register a maximum of 6 stations for each band (FM1, FM2, FM3).
- If a preset key that already has a station registered is selected, then this is overwritten with the new preset.

NOTE

- Pressing the preset key will select the previously registered frequency.

Auto Memory (Auto Store)

The top 6 stations with a strong signal can be automatically registered in order with preset keys.

Hold down the RADIO key.

After completion of auto store operations, the product will receive the station registered in the preset key [1].

CAUTION

- Please be aware that the formerly-registered frequency in the memory will be overwritten.

NOTE

- Using auto store for FM1 and FM2 switches to FM3.

PTY Search

Select PTY (program content), and automatically scan for stations.

1. During FM reception, press the PTY/SCAN key.
This switches to the PTY selection mode.

2. Turn the  /SEL key to select PTY.

The PTY (program content) indicator will flash, and station selection will automatically start. When a station is received, the station name is displayed.

NOTE

- This receives the station detected first.
- 10 seconds after reception, PTY search mode will be cancelled.

7

Listening to DAB*

This explains how to listen to DAB.

To listen to DAB

1. Press the RADIO key to switch the band. Switch between DAB1, DAB2, and DAB3 bands.
The selected band is indicated on the display.

NOTE

- This switches in the order FM1, FM2, FM3, DAB1, DAB2, DAB3, MW, and LW.

Listening to DAB*

Select a Service

1. Hold down the **◀◀** key or the **▶▶** key. Receives the lead services of the ensembles that can be received.
2. Press the **◀◀** key or the **▶▶** key to select the service.

<p>7</p> <p>◀◀ key (hold down)</p>	<p>Automatically receives lower lead services within ensembles that can be received.</p>
<p>▶▶ key (hold down)</p>	<p>Automatically receives higher lead services within ensembles that can be received.</p>
<p>◀◀ key</p>	<p>Switches to lower services.</p>
<p>▶▶ key</p>	<p>Switches to higher services.</p>

NOTE

- Going to the first service or last service within the ensemble switches to the next ensemble.

Register the Service

Register the service in advance, and select this at a later time.

1. Tune in to the service to register.
2. Hold down any of the keys from the 1RPT key to the 6 ➔ key. A “Beep” sounds, and the preset key is registered.

NOTE

- If a preset key that already has a service registered is selected, then this is overwritten with the new preset.
- Pressing the preset key will select the previously registered service.

Search for a Service

Search for ensembles and services that can be received.

1. Turn the **▶/SEL** key to select the ensemble
2. Press the **▶/SEL** key. The service name within the selected ensemble is displayed.
3. Turn the **▶/SEL** key to select the service.
4. Press the **▶/SEL** key. Receive the selected service.

NOTE

- If the text information for the service name cannot be obtained, then nothing is displayed.
- If there is no operation for 10 seconds, then service search mode will be cancelled.

PTY Search

Select PTY (program content), and automatically scan for services.

1. Press the PTY/SCAN key. This switches to the PTY selection mode.
2. Turn the **▶/SEL** key to select PTY.
3. Press the **◀◀** key or **▶▶** key. This starts PTY search.

<p>◀◀ key</p>	<p>Lower PTY search starts.</p>
<p>▶▶ key</p>	<p>Higher PTY search starts.</p>

NOTE

- When selecting PTY, press any of the keys from the 1RPT key to the 6 ➔ key to switch to the PTY registered as a preset.

NOTE

- When selecting PTY, select the PTY to register, and hold down any of the keys from the 1RPT key to the 6 ➔ key to register the PTY as a preset.
- While in PTY select status, if there is no operation for 2 seconds, then an upwards search within the selected PTY will start.

Listening to Traffic Messages

This explains how to listen to traffic messages.

To Listen to Traffic Messages

1. When not in MW or LW mode, press the TP key.
If traffic messages are being broadcast, these are received.

CAUTION

- When receiving a MW or LW signal, traffic messages cannot be received.

NOTE

- Receiving traffic messages will indicate “TRAF INF” on the display, and if text information can be received, the station name is displayed.

NOTE

- If traffic messages are received, then this will switch to the volume of the previously received traffic messages or emergency broadcasts. The volume when receiving traffic messages or emergency broadcasts is that at which subsequent broadcasts will be received.

Traffic Message Standby Mode

When the broadcast of traffic messages starts, this automatically switches to the station that is broadcasting traffic messages.

1. When not in MW or LW mode, press the TP key.
“TP” is indicated on the display, and the product switches to standby mode.
If traffic messages are being broadcast, these are received.
2. When not in MW or LW mode, press the TP key.
“TP” disappears from the display, and standby mode will be cancelled.

CAUTION

- When receiving a MW or LW signal, traffic message standby mode will be cancelled.

Listening to CDs

This explains how to listen to audio CDs (CD-DA/CD-TEXT).

Play CDs

Insert the disc.
Insert a disc to automatically start playback. → “Insert/Eject Discs” on page 7-31
If a disc is already within the product, press the MEDIA key to switch to CD as the source.

7

Select the Track

Press the ◀◀ key or ▶▶ key to select the track.
This enables selection of the next or previous track.

Fast Forward or Rewind

Hold down the 3◀◀ key or the 4▶▶ key.
Fast forward/rewind is possible.

Switching Playback Mode

Repeat playback, random playback, and scan playback are possible.

Repeat Playback (RPT)

Press the 1RPT key.

Listening to MP3s

Repeat playback of the track currently being played.

NOTE

- Pressing again will cancel.
- Selecting a track, ejecting, fast forwarding, or rewinding will cancel.

Random Playback (RDM)

7

Press the 2RDM key.
Play the tracks on the disc in a random order.

NOTE

- Pressing again will cancel.
- Ejecting will cancel this.

Scan Playback (SCAN)

Press the PTY/SCAN key.
Play the first 10 seconds of each of the tracks on the whole disc in order.

NOTE

- Press this button again during playback if you wish to hear that track, and that track will play normally.

Listening to MP3s

This explains how to listen to audio files on a disc.

CAUTION

- CD-ROM and CD-R/RW media can only play back MP3 format audio files.

To Listen to MP3s

Insert the disc.
Insert a disc to automatically start playback.
→ “Insert/Eject Discs” on page 7-31
If a disc is already within the product, press the MEDIA key to switch to CD as the source.

NOTE

- Depending on the file structure, it may take some time to read the contents of the disc.

Select the Track (File)

Press the ◀◀ key or ▶▶ key to select the track.
This enables selection of the next or previous track.

Fast Forward or Rewind

Hold down the 3◀◀ key or the 4▶▶ key.
Fast forward/rewind is possible.

Switching Playback Mode

Repeat playback, random playback, and scan playback are possible.

Repeat Playback (RPT)

Press the 1RPT key.
Repeat playback of the track currently being played.

NOTE

- Pressing again will cancel.
- Selecting a file, ejecting, fast forwarding, or rewinding will cancel.

Folder Repeat Playback

Hold down the 1RPT key.
Repeat playback of the tracks within the folder currently being played.

NOTE

- Pressing again will cancel.
- Even if the file is selected, folder repeat playback will not be cancelled.

Random Playback (RDM)

Press the 2RDM key.
Play the tracks in the folder in a random order.

NOTE

- Pressing again will cancel.

Folder Random Playback

Hold down the 2RDM key.
Play all tracks in folders on the disc in a random order.

NOTE

- Pressing again will cancel.

Scan Playback (SCAN)

Press the SCAN key.
Play the first 10 seconds of each of the tracks in the folder currently being played in order.

Search Tracks

Search folders and files, and select a track.

1. Turn the **▶/SEL** key to select the folder.
2. Press the **▶/SEL** key.
Files within the selected folder are displayed.
3. Turn the **▶/SEL** key to select the file.

4. Press the **▶/SEL** key.
This plays the selected file (track).

NOTE

- While the folder is selected, press the **6** **➔** key to cancel track search mode.
- If there is no operation for 10 seconds after selecting the folder, then track search mode will be cancelled.
- Select the folder, and hold down the **▶/SEL** key to start playback from the first track in that folder.
- While the file is selected, press the **6** **➔** key to return to the previous operation.
- While the file is selected, hold down the **6** **➔** key to cancel track search mode.
- If there is no operation for five seconds after selecting the file, that file is played back.
- Disc operations such as selecting a track will cancel track search mode.

Listening to an iPod

By connecting commercially-available iPod/iPhone devices to this product, you can play back tracks on these through the product.

CAUTION

- Do not leave the iPod/iPhone unattended in the vehicle.
- Never hold these devices in your hand to operate while driving, as this is dangerous.

CAUTION

- No indemnification for data loss resulting when the iPod/iPhone is connected to the product will be possible.
- Depending on how the devices are handled, audio files being damaged or lost, therefore it is recommended that data be backed up.

NOTE

- Depending on the generation, model, or software version of the iPod/iPhone, playback on this product may not be possible. (→ p. 7-22) Additionally, playback as explained in this document may not be possible.
- For vehicles with a Bluetooth® 2.0 interface, the types of devices that can be connected may vary.
For details, access the MITSUBISHI MOTORS website.
Please read and agree to the “Warning about Links to the Web Sites of Other Companies”.
The websites mentioned above may connect you to websites other than the MITSUBISHI MOTORS website.
<http://www.mitsubishi-motors.com/en/products/index.html>
- Usage of iPod/iPhone hardware with the latest software version is recommended.
- Regarding how to connect the iPod/iPhone, refer to “How to connect an iPod” on page 7-77.

Listening to an iPod

NOTE

- When connecting the iPod/iPhone, use a commercially available iPod connection cable.
- Set up the device in order that no unsafe actions, such as plugging in the connection cable are taken while driving.
- When inserting and removing the iPod/iPhone, for safety's sake first stop the vehicle.
- Depending on the status of the iPod/iPhone, it may take some time until the device is recognized, or playback starts.
- Buttons on the product will not operate while iPod/iPhone is connected.
- iPod/iPhone specifications and settings may mean that connection is not possible, or result in differences in operation or display.
- Depending on audio data in the iPod/iPhone, track information may not be displayed correctly.
- Depending on the status of the vehicle and device, the iPod/iPhone may not play back after starting the engine.
- Data containing copyright information may not play back.
- It is recommended that the iPod/iPhone equaliser settings be set to flat.
- Operate the iPod/iPhone while connected to this product.
- If the iPod/iPhone is connected via Bluetooth® as a Bluetooth®-capable audio device, then do not connect the iPod/iPhone using an iPod connection cable. Connection using both methods will result in erroneous operation.

7

NOTE

- If an iPod/iPhone does not operate correctly, then remove the iPod/iPhone from the product, reset, then reconnect.

Play iPod

Press the MEDIA key to set the iPod as the source.

The selected source is indicated on the display.

Select the Track (File)

Press the ◀◀ key or ▶▶ key to select the track.

This enables selection of the next or previous track.

Fast Forward or Rewind

Hold down the 3◀◀ key or the 4▶▶ key.

Fast forward/rewind is possible.

Switching Playback Mode

Repeat playback and shuffle playback are possible.

Repeat Playback (RPT)

Press the 1RPT key.

Repeat playback of the track currently being played.

NOTE

- Pressing again will cancel.

Shuffle Playback (RDM)

Press the 2RDM key.

Play tracks in the category currently being played in a random order.

NOTE

- Pressing again will cancel.

Album Shuffle Playback

Hold down the 2RDM key.

Play back the album in a random order (tracks in any order on the album).

NOTE

- Pressing again will cancel.

Search Tracks

Search categories or track names, and select a track.

1. Turn the **▶** /SEL key to select the category.
2. Press the **▶** /SEL key. Categories or tracks within the selected category are displayed.
3. Turn the **▶** /SEL key to select the category or track.
4. Press the **▶** /SEL key.
Repeat steps 1 to 4, and search for tracks.
Select the track, and press the **▶** /SEL key to play.

NOTE

- While the category (1st level) is selected, press the **6** **↵** key to cancel track search mode.
- If there is no operation for 10 seconds after selecting the category, then track search mode will be cancelled.
- Select the category, and hold down the **▶** /SEL key to start playback from the first track in that category.
- While the track is selected, press the **6** **↵** key to return to the previous operation.
- While the track is selected, hold down the **6** **↵** key to cancel track search mode.

NOTE

- If there is no operation for five seconds after selecting the track, that file is played back.
- iPod operations such as selecting a track will cancel track search mode.

Listening to Audio Files on a USB Device

By connecting commercially-available USB devices such as USB memory to this product, you can play back audio files on these through the product.

CAUTION

- Do not leave the USB device unattended in the vehicle.
- Never hold these devices in your hand to operate while driving, as this is dangerous.
- Do not use hard discs, card readers, or memory readers, as damage may occur to these or to the data contained therein. If these are erroneously connected, then turn the ignition switch to the “LOCK” position or put the operation mode in OFF, then remove.
- Because of the risk of data loss, it is recommended that files be backed up.
- No guarantee is made as regards damage to the USB device, nor regarding loss or damage to data contained therein.

CAUTION

- Depending on how the devices are handled, audio files being damaged or lost, therefore it is recommended that data be backed up.

NOTE

- Digital audio players that support the mass storage class specifications can be connected.
- For details regarding the types of USB devices that can be connected and the types of files that can be played back in vehicles with a Bluetooth® 2.0 interface, refer to “Types of connectable devices and supported file specifications” on page 7-77.
- Regarding how to connect USB devices, refer to “How to connect a USB memory device” on page 7-76.
- When connecting a USB device, use a connection cable. Failure to use a connection cable when connecting may place undue load on, or damage the USB connector.
- Set up the device in order that no unsafe actions, such as plugging in the connection cable are taken while driving.
- When inserting and removing the USB device, for safety’s sake first stop the vehicle.
- Do not insert other than audio devices into the USB port. Damage to the device or equipment may result.
- Depending on the status of the USB device, it may take some time until the device is recognized, or playback starts.

Listening to Audio Files on a USB Device

NOTE

- Buttons on the product will not operate while USB device is connected.
- USB device specifications and settings may mean that connection is not possible, or result in differences in operation or display.
- Depending on audio data in the USB device, track information may not be displayed correctly.
- Depending on the status of the vehicle and device, the iPod/iPhone may not play back after starting the engine.
- Data containing copyright information may not play back.
- This product can play back MP3, WMA, and AAC format audio files.
- Depending on the type of USB device, usage may not be possible, or functions that can be used may be restricted.
- The recommended file system for USB memory is FAT32.
- The maximum supported capacity for USB memory is 32GB.
- Operate the USB device containing recorded audio files while connected to this product.

Play Back of Audio Files on a USB Device

Press the MEDIA key to set

USB as the source. The selected source is indicated on the display.

7-42 For pleasant driving

Select the Track (File)

Press the ◀◀ key or ▶▶ key to select the track.

This enables selection of the next or previous track.

Fast Forward or Rewind

Hold down the 3◀◀ key or the 4▶▶ key.

Fast forward/rewind is possible.

Switching Playback Mode

Repeat playback, random playback, and scan playback are possible.

Repeat Playback (RPT)

Press the 1RPT key.

Repeat playback of the track currently being played.

NOTE

- Pressing again will cancel.
- Selecting a file will cancel this.

Folder Repeat Playback

Hold down the 1RPT key.

Repeat playback of the tracks within the folder currently being played.

NOTE

- Pressing again will cancel.
- Even if the file is selected, folder repeat playback will not be cancelled.

Folder Random Playback (RDM)

Press the 2RDM key.

Play tracks in the folder currently being played in a random order.

NOTE

- Pressing again will cancel.
- Even if the file is selected, folder random playback will not be cancelled.

All Folder Random Playback

Hold down the 2RDM key.

Play the tracks in all folders in a random order.

To play iPod/USB memory device tracks via voice operation (vehicles with Bluetooth® 2.0 interface)

NOTE

- Pressing again will cancel.
- Even if the file is selected, all folder random playback will not be cancelled.

Scan Playback (SCAN)

Press the PTY/SCAN key.

Play the first 10 seconds of each of the tracks on the whole USB device in order.

NOTE

- Press this button again during playback if you wish to hear that track, and that track will play normally.

Folder Scan Playback

Hold down the PTY/SCAN key.

Play the first 10 seconds of the first track in each folder on the USB device in order.

NOTE

- Press this button again during playback if you wish to hear that track, and that track will play normally.

Search Tracks

Search folders and files, and select a track.

1. Turn the **▶/SEL** key to select the folder.
2. Press the **▶/SEL** key.

Files within the selected folder are displayed.

3. Turn the **▶/SEL** key to select the file.
4. Press the **▶/SEL** key.

This plays the selected file (track).

NOTE

- While the folder is selected, press the **6 ➡** key to cancel track search mode.
- If there is no operation for 10 seconds after selecting the folder, then track search mode will be cancelled.
- Select the folder, and hold down the **▶/SEL** key to start playback from the first track in that folder.
- While the file is selected, press the **6 ➡** key to return to the previous operation.
- While the file is selected, hold down the **6 ➡** key to cancel track search mode.
- If there is no operation for five seconds after selecting the file, that file is played back.
- Operations such as selecting a track will cancel track search mode.

To play iPod/USB memory device tracks via voice operation (vehicles with Bluetooth® 2.0 interface)

Desired tracks on the iPod/USB memory device which is connected to the USB input terminal can be selected and played via voice operation.

For information concerning the voice recognition function or speaker registration function, refer to “Bluetooth® 2.0 interface” on page 7-56.

The following explains how to prepare for voice operation and play the tracks.

Preparation for voice operation

To use the voice operation, press the **SPEECH** button (A) first.

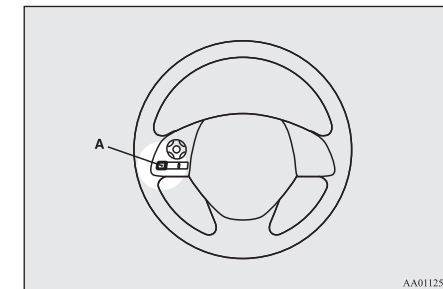

7

To play iPod/USB memory device tracks via voice operation (vehicles with Bluetooth® 2.0 interface)

To search by artist name

1. Say “Play” on the main menu.

NOTE

- The Bluetooth® 2.0 interface starts recognizing the connected device. If the connected device cannot be recognized or a connection error occurs, the Bluetooth® 2.0 interface starts an appropriate voice guide. Follow the voice guide.

7

2. After the voice guide says “Would you like to play by Artist, Album, Playlist or Genre?,” say “Artist”.

NOTE

- If you say “Artist <name>,” you can skip step 3.

3. After the voice guide says “What Artist would you like to play?,” say the artist name.
4. If there is only one match, the system proceeds to step 6.
5. If there are two or more matches, the voice guide will say “More than one match was found, would you like to play <artist name>?” If you say “Yes,” the system proceeds to step 6. If you say “No,” the next matching artist is uttered by the system.

7-44 For pleasant driving

NOTE

- If you say “No” to three or all artist names uttered by the system, the voice guide will say “Artist not found, please try again” and the system returns to step 2.
- Search time is dependant on the number of songs on your connected device. Devices containing a large number of songs may take longer to return search results.

6. After the voice guide says “Playing <artist name>,” the system creates a playlist index for the artist.

NOTE

- If the confirmation function is active, the voice guide confirms if the artist name is correct. If the artist name is correct, say “Yes”. If not, say “No”. After the voice guide says “Artist not found, please try again,” the system returns to step 2.

7. The system exits the voice recognition mode and starts playback.

To search by album title

1. Say “Play” on the main menu.

NOTE

- The Bluetooth® 2.0 interface starts recognizing the connected device. If the connected device cannot be recognized or a connection error occurs, the Bluetooth® 2.0 interface starts an appropriate voice guide. Follow the voice guide.

2. After the voice guide says “Would you like to play by Artist, Album, Playlist or Genre?,” say “Album”.

NOTE

- If you say “Album <title>,” you can skip step 3.

3. After the voice guide says “What Album would you like to play?” say the album title.
4. If there is only one match, the system proceeds to step 6.
5. If there are two or more matches, the voice guide will say “More than one match was found, would you like to play <album title>?” If you say “Yes,” the system proceeds to step 6. If you say “No,” the next matching album is uttered by the system.

To play iPod/USB memory device tracks via voice operation (vehicles with Bluetooth® 2.0 interface)

NOTE

- If you say “No” to three or all album titles uttered by the system, the voice guide will say “Album not found, please try again” and the system returns to step 2.

6. After the voice guide says “Playing <album title>,” the system creates a playlist index for the album title.

NOTE

- If the confirmation function is active, the voice guide confirms if the album title is correct. If the album title is correct, say “Yes”. If not, say “No”. After the voice guide says “Album not found, please try again,” the system returns to step 2.

7. The system exits the voice recognition mode and starts playback.

To search by playlist

1. Say “Play” on the main menu.

NOTE

- The Bluetooth® 2.0 interface starts recognizing the connected device. If the connected device cannot be recognized or a connection error occurs, the Bluetooth® 2.0 interface starts an appropriate voice guide. Follow the voice guide.

2. After the voice guide says “Would you like to play by Artist, Album, Playlist or Genre?,” say “Playlist”.

NOTE

- If you say “Playlist <playlist>,” you can skip step 3. If the device has no playlist, the voice guide will say “There are no playlists stored on device” and the system returns to step 2.

3. After the voice guide says “What Playlist would you like to play?,” say the playlist name.
4. If there is only one match, the system proceeds to step 6.
5. If there are two or more matches, the voice guide will say “More than one match was found, would you like to play <playlist>?” If you say “Yes,” the system proceeds to step 6. If you say “No,” the next matching playlist name is uttered by the system.

NOTE

- If you say “No” to three or all playlist names uttered by the system, the voice guide will say “Playlist not found, please try again” and the system returns to step 2.

6. After the voice guide says “Playing <playlist>,” the system creates an index for the playlist.

NOTE

- If the confirmation function is active, the voice guide confirms if the playlist name is correct. If the playlist name is correct, say “Yes”. If not, say “No”. After the voice guide says “Playlist not found, please try again,” the system returns to step 2. Refer to “Confirmation function setting” on page 7-59.

7. The system exits the voice recognition mode and starts playback.

To search by genre

1. Say “Play” on the main menu.

NOTE

- The Bluetooth® 2.0 interface starts recognizing the connected device. If the connected device cannot be recognized or a connection error occurs, the Bluetooth® 2.0 interface starts an appropriate voice guide. Follow the voice guide.

2. After the voice guide says “Would you like to play by Artist, Album, Playlist or Genre?,” say “Genre”.

7

Listening to Bluetooth® Audio*

NOTE

- If you say “Genre <type>,” you can skip step 3.

3. After the voice guide says “What Genre would you like to play?,” say the music type.
4. If there is only one match, the system proceeds to step 6.
5. If there are two or more matches, the voice guide will say “More than one match was found, would you like to play <genre>?” If you say “Yes,” the system proceeds to step 6.
If you say “No,” the next matching genre is uttered by the system.

NOTE

- If you say “No” to three or all genres uttered by the system, the voice guide will say “Genre not found, please try again” and the system returns to step 2.

6. After the voice guide says “Playing <genre>,” the system creates an index for the genre.

NOTE

- If the confirmation function is active, the voice guide confirms if the genre is correct. If the genre is correct, say “Yes”. If not, say “No”. After the voice guide says “Genre not found, please try again,” the system returns to step 2. Refer to “Confirmation function setting” on page 7-59.

7. The system exits the voice recognition mode and starts playback.

Listening to Bluetooth® Audio*

This product can play back tracks on commercially-available Bluetooth®-capable audio devices.

CAUTION

- Never hold these devices in your hand to operate while driving, as this is dangerous.
- Do not leave the Bluetooth® audio device unattended in the vehicle.
- Depending on how the devices are handled, audio files being damaged or lost, therefore it is recommended that data be backed up.

NOTE

- Depending on the type of Bluetooth®-capable audio devices, usage may not be possible, or functions that can be used may be restricted.
- Confirm together with the user manuals for the commercially- available Bluetooth®-capable audio devices.
- Depending on the type of Bluetooth®-capable audio devices, volume levels may differ. There is the danger of loud volumes, so prior to use, it is recommended that you turn the volume down.
→ “Adjusting the Volume” on page 7-31
- Depending on the status of the Bluetooth® audio device, it may take some time until the device is recognized, or playback starts.
- Bluetooth® audio device specifications and settings may mean that connection is not possible, or result in differences in operation or display.
- Depending on audio data in the Bluetooth® audio device, track information may not be displayed correctly.
- Depending on the status of the vehicle and device, the iPod/iPhone may not play back after starting the engine.

Connect a Bluetooth®-capable Audio Device

Regarding how to connect your Bluetooth® device, refer to “Connecting the Bluetooth® 2.0 interface and Bluetooth® device.” on page 7-62

Operation methods below describe situations once connection has been completed.

NOTE
● If the iPod/iPhone is connected via Bluetooth® as a Bluetooth®-capable audio device, then do not connect the iPod/iPhone using an iPod cable. Connection using both methods will result in erroneous operation.

Play Bluetooth® Audio

1. Press the MEDIA key to set Bluetooth® Audio as the source.

The selected source is indicated on the display.

2. Press the 5 **▶** key. Bluetooth® Audio playback starts.

NOTE
● Hold down the 5 **▶** key to pause.

NOTE
● Press the 6 **➡** key to stop.

Select the Track (File)

Press the **◀◀** key or **▶▶** key to select the track.

This enables selection of the next or previous track.

Fast Forward or Rewind

Hold down the 3 **◀◀** key or the 4 **▶▶** key.

Fast forward/rewind is possible.

Switching Playback Mode

Repeat playback, random playback, and scan playback are possible.

Repeat Playback (RPT)

Press the 1RPT key.

Repeat playback of the track currently being played.

NOTE
● Each time the 1RPT key is pressed, this switches in the order Repeat OFF, 1 track repeat, All track repeat, and Repeat OFF.

Random Playback (RDM)

Press the 2RDM key.

Play the tracks in the Bluetooth® Audio device in a random order.

NOTE
● Pressing again will cancel.

Scan Playback (SCAN)

Press the PTY/SCAN key.

Play the first 10 seconds of each of the tracks on the whole Bluetooth® Audio device in order.

NOTE
● Press this button again during playback if you wish to hear that track, and that track will play normally.

Display Indicator

Display Indicator

This explains content of the display indicator.

7

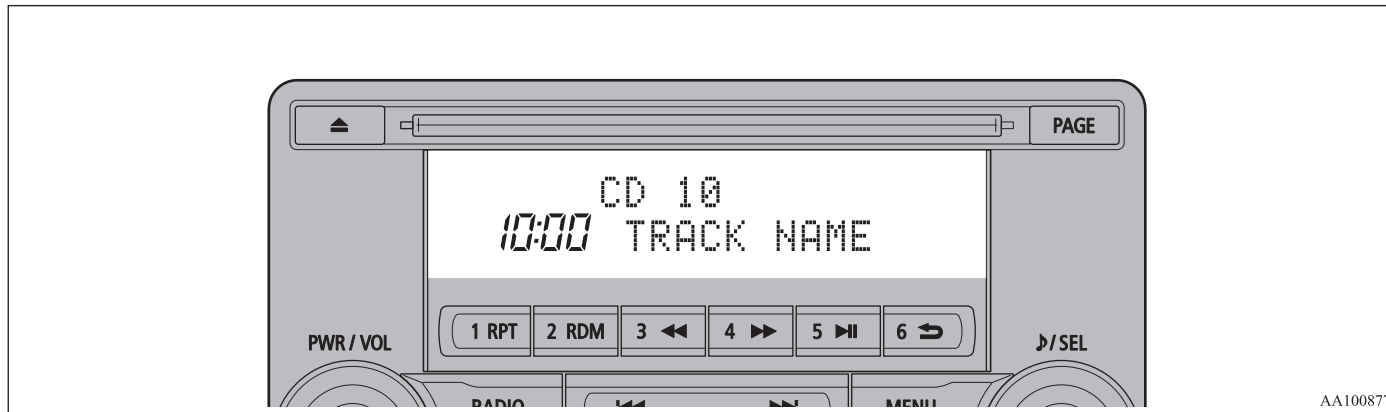

Change the Display Mode

You can change the content of the display indicator.

Press the DISP key to switch the display content.

Each time the DISP key is pressed, the display content changes.

CAUTION

- The operation of changing display contents may impede safe driving, therefore check safety before operation.

NOTE

- Up to 11 characters may be displayed at one time. To display 12 or more characters, press the PAGE key, and subsequent characters will be displayed.

During DAB Reception*

This switches in the order “Service name”, “Ensemble name”, and “CH no. (CH ID)”.

NOTE

- If the text information for the service name and ensemble name cannot be obtained, then nothing is displayed.

During CD-DA playback

This switches in the order “Disc title”, “Track title”, and “Operating status”.

NOTE

- If there is no text information to display, then “NO TITLE” is displayed.

During MP3/WMA/AAC Playback

This switches in the order “Folder title”, “File title”, and “Operating status”.

NOTE

- If there is no text information to display, then “NO TITLE” is displayed.

Display the ID3tag

Hold down the DISP key.

This switches the ID3tag display. [DISP] Each time the key is pressed, this switches in the order “Album name”, “Track name”, “Artist name”, “Genre name”*, and “Operating status”.

*Displayed when playing back audio files on a USB device (vehicles with a Bluetooth® 2.0 interface).

NOTE

- During display of the ID3tag, hold down the DISP key to switch to the folder title display.
- The genre name display may not be possible.

During iPod Playback

This switches in the order “Albums”, “Track name”, “Artist name”, “Genre name”*, and “Operating status”.

NOTE

- If there is no text information to display, then “NO TITLE” is displayed.
- Displayed genre name in equipment by type (vehicles with a Bluetooth® 2.0 interface).
- The genre name display may not be possible.

During Bluetooth® 2.0 Audio Playback*

Operating details are the same as in “During iPod Playback” on page 7-49.

Audio Quality and Volume Balance Adjustment

Change audio quality settings.

Adjust Audio Quality and Volume Balance

1. Press the **▶**/SEL key to select settings items.

Each time the **▶**/SEL key is pressed, this switches in the order BASS, TREBLE, FADER, BALANCE, SCV (speed compensated volume), and Cancel.

2. Turn the **▶**/SEL key to adjust.

7

Adjustment items	Turn counter-clockwise	Turn clockwise
BASS	-6 to 0 (low low-pass volume)	0 to +6 (high low-pass volume)
TREBLE	-6 to 0 (Low high-pass volume)	0 to +6 (High high-pass volume)
FADER	CENTER to REAR 11 (emphasise REAR)	FRONT 11 to CENTER (emphasise FRONT)
BALANCE	LEFT 11 to CENTER (emphasise LEFT)	CENTER to RIGHT 11 (emphasise RIGHT)

System Settings

Adjustment items	Turn counter-clockwise	Turn clockwise
SCV	OFF, LOW (SCV effect is OFF/low)	MID, HIGH (SCV effect is middle/high)

System Settings

7

- Change system settings such as product time.
1. Press the MENU key.
 2. Press the **▶**/SEL key to select settings items.

Each time the **▶**/SEL key is pressed, this switches in the order DAB setting*¹, Gracenote DB*², AF, REG, TP-S, PI-S, PTY language settings, PHONE settings, CT, Adjust time, and Cancel.

3. Turn the **▶**/SEL key to set.
4. Press the **▶**/SEL key to determine.

This completes settings, and displays the next settings item.

*¹ Displayed when a DAB tuner is connected

*² Displayed when playing back audio files (vehicles with a Bluetooth® 2.0 interface).

DAB Setting*

Change DAB settings

("Set value" bold typeface indicates factory default settings.)

Settings name	Settings value	Settings content
DAB-DAB Link settings	OFF	If low reception sensitivity, switch to another service.
	ON	
DAB Band settings	BAND III	Set used broadcast band to 174 to 239 MHz.
	L-BAND	Set used broadcast band to 1452 to 1490 MHz.
	BOTH	Set used broadcast band to Band III and L-Band.

RDS Setting

Change RDS settings

("Set value" bold typeface indicates factory default settings.)

Settings name	Settings value	Settings content
AF	AF ON	Automatically track the same station as the program being received.
	AF OFF	Do not automatically track the same station as the program being received.
REG	REG ON	Do not automatically track the local station for the program being received.

System Settings

Settings name	Settings value	Settings content
	REG OFF	Automatically track the local station for the program being received.
TP-S	TP-S ON	Automatically search for traffic messages (TP stations).
	TP-S OFF	Do not automatically search for traffic messages (TP stations).
PI-S	PI-S ON	Search for the same station or local station for that registered in the preset channel.

Settings name	Settings value	Settings content
	PI-S OFF	Do not search for the same station or local station for that registered in the preset channel.
PTY	ENGLISH	Set the display language for the program content search (PTY search) to English.
	FRANCAIS	Set the display language for the program content search (PTY search) to French.
	DEUTSCH	Set the display language for the program content search (PTY search) to German.

Settings name	Settings value	Settings content
	SVENSK	Set the display language for the program content search (PTY search) to Swedish.
	ESPAÑOL	Set the display language for the program content search (PTY search) to Spanish.
	ITALIANO	Set the display language for the program content search (PTY search) to Italian.
CT	CT ON	Update the time if time data is received.

7

System Settings

Settings name	Settings value	Settings content
	CT OFF	Do not update the time even if time data is received.

*: It is necessary to press the [TP] key and turn traffic message standby mode "ON".

7

Time Setting

Turning the RDS setting CT setting "CT OFF" enables manual setting of the time.

1. Select "YES" at the "Adjust time" screen, and press the **▶**/SEL key.

The hour can be adjusted. Press the **▶**/SEL key again to adjust the minutes.

2. Turn the **▶**/SEL key to adjust the time.
3. Press the **▶**/SEL key.

This completes the adjustment.

NOTE

- In order to finish adjusting the time, hold down the **▶**/SEL key until the seconds are reset to "00".

PHONE Settings

Change the mobile phone voice cut-in settings and the Bluetooth® 2.0 interface language.

Depending on the vehicle, PHONE settings may not be possible.

NOTE

- Cancel functions such as the mobile phone "dial lock", and connect while on the standby screen.
- While connected, mobile phone (receiving calls, etc.) operations may not function correctly.
- Depending on the distance between the product and the mobile phone, the conditions within the vehicle, and types of screening, connection may not be possible. In these cases, situate the mobile phone as close as possible to the product.
- Even though a Bluetooth®-capable mobile phone, characteristics and specifications may mean that correct operation may not be possible.
- For safety's sake, do not operate the mobile phone while driving. When operating the mobile phone, first stop the vehicle in a safe location.
- Even though a Bluetooth®-capable mobile phone, phone specifications and settings may result in differences in display, or prevent correct operation.

NOTE

- Some models may not be confirmed as connected, or may not connect.

Supported profiles

Hands-free	HFP(v1.5)
Phone book transfer	OPP(v1.1), PBAP(v1.0)

Vehicles without a Bluetooth® 2.0 Interface

A hands-free kit (available separately) is required.

("Set value" bold typeface indicates factory default settings.)

Settings value	Settings content
PHONE OFF	Do not use mobile phone voice cut-in.
PHONE MUTE	During mobile phone voice cut-in, mute the audio.
PHONE ATT	During mobile phone voice cut-in, output audio from all speakers.
PHONE IN-L	During mobile phone voice cut-in, output sound from the left front speaker.

Settings value	Settings content
PHONE IN-R	During mobile phone voice cut-in, output sound from the right front speaker.
PHONE IN-LR	During mobile phone voice cut-in, output sound from the left and right front speakers.

Vehicles with a Bluetooth® 2.0 Interface

(“Set value” bold typeface indicates factory default settings.)

Settings name	Settings value	Settings content
PHONE IN settings	PHONE IN-R	During mobile phone voice cut-in, output sound from the right front speaker.
	PHONE IN-L	During mobile phone voice cut-in, output sound from the left front speaker.
HFM voice language settings	ENGLISH	Change the hands free mod-

Settings name	Settings value	Settings content
	FRENCH	Change the voice language.
	GERMAN	
	SPANISH	
	ITALIAN	
	DUTCH	
	PORTUGUESE	
	RUSSIAN	

NOTE

- Depending on the vehicle model, this may not display.

Gracenote DB (Vehicles with a Bluetooth® 2.0 interface)

The version number can be confirmed.

1. Select “Gracenote DB” and press the **▶/SEL** key.
2. Turn the **▶/SEL** key and select “DB Version”.
3. Press the **▶/SEL** key.
The DB Version is displayed.

Troubleshooting

Troubleshooting

Please check these items if a message appears on the display, or if you think something is not working properly.

If This Message Appears...

A message is displayed on this product according to the situation.

Mode	Message	Cause	Response
CD	CHECK DISC	The disc is inserted upside down.	Insert with the label side up.
		The disc has condensation on it.	Wait a while before inserting again.
	DISC ERROR	The disc is damaged.	Clean the read surface of the disc.
		The disc is dirty.	
	INTERNAL E	The drive has malfunctioned for some reason.	Check that there is no problem with the disc, and insert the disc again. If the problem persists, consult a MITSUBISHI MOTORS Authorized Service Point.
HEAT ERROR	The temperature inside the product is high.	Remove the disc, and wait for the internal temperature to return to normal.	
USB	FILE ERROR	Files that cannot be played are selected.	Select files that can be played. → “Audio Files (MP3/WMA/AAC)” on page 7-26.
	USB BUS PWR	There is high or low electrical current or voltage.	Turn the power OFF and wait a short while. If the problem persists, consult a MITSUBISHI MOTORS Authorized Service Point.
	LSI ERROR	There is an internal malfunction for some reason.	
	UNSUPPORTED FORMAT	Unsupported audio files have been played.	Confirm audio files that can be played. → “Audio Files (MP3/WMA/AAC)” on page 7-26.
	UNSUPPORTED DEVICE	An unsupported USB device has been connected.	Please connect a USB memory device.
iPod	NO SONG	An iPod/iPhone not containing any tracks has been connected.	Connect an iPod/iPhone containing tracks.

Mode	Message	Cause	Response
	VER ERROR	This iPod/iPhone software version is not supported.	Please change to a supported software version.
Other	ERROR DC	An abnormal direct voltage has been sent to the speakers.	Turn the power OFF and wait a short while. If the problem persists, consult a MITSUBISHI MOTORS Authorized Service Point.

If You Think Something Is Not Working Properly...

Here is a list of symptoms, causes and responses if you think something is not working properly.

Symptoms	Cause	Response
There is no sound or quiet sound.	The volume is turned to its minimum.	Adjusting the volume. → “Adjusting the Volume” on page 7-31.
	The balance or fader is turned to one side.	Adjusting the balance or fader. → “Adjust Audio Quality and Volume Balance” on page 7-49.
The disc cannot be inserted.	A disc is already in the product.	Eject the disc. → “Insert/Eject Discs” on page 7-31.
	There is no disc in the product, but the product says it is loading.	Press the eject button once. → “Insert/Eject Discs” on page 7-31.
The disc cannot be played.	The disc is inserted upside down.	Insert with the label side up.
	The disc has condensation on it.	Wait a while before inserting.
	The disc is dirty.	Clean the read surface of the disc.
The sound skips in the same place.	The disc is damaged or dirty.	Check the disc.
There is no sound, even if the disc is inserted.	Damage to or dirt on the disc means that its data cannot be read.	Check the disc. Additionally, if using CD-R/RW discs, their characteristics may render them unable to be played.

Link System*

Link System*

The Link System takes overall control of the devices connected via the USB input terminal or the Bluetooth® 2.0 interface allowing the connected devices to be operated by using the switches in the vehicle or voice commands. See the following section for details on how to operate.

Refer to “Bluetooth® 2.0 interface” on page 7-56.

Refer to “USB input terminal” on page 7-76.

Refer to “Listening to an iPod” on page 7-39.
Refer to “Listening to Audio Files on a USB Device” on page 7-41.

Refer to “To play iPod/USB memory device tracks via voice operation” on page 7-43.

Refer to “Listen to Bluetooth® Audio” on page 7-46.

Link System End User Licence Agreement

You have acquired a device that includes software licensed by MITSUBISHI MOTORS CORPORATION from Visteon Corporation, and their subsequent 3rd party suppliers. For a complete list of these 3rd party products and their end user licence agreements, please go to the following website.
<http://www.jciblueconnect.com/faq/fulldisclosure.pdf>

7-56 For pleasant driving

Bluetooth® 2.0 interface*

The Bluetooth® 2.0 interface allows for making/receiving hands-free calls in the vehicle using a Bluetooth® compatible cellular phone based on the wireless communication technology commonly known as Bluetooth®. It also allows the user to play music, saved in a Bluetooth® music player, from the vehicle’s speakers.

The system is equipped with a voice recognition function, which allows you to make hands-free calls by simple switch operations and voice command operations using a defined voice tree.

The Bluetooth® 2.0 interface can be used when the ignition switch or the operation mode is in ON or ACC.

Before you can use the Bluetooth® 2.0 interface, you must pair the Bluetooth® device and Bluetooth® 2.0 interface. Refer to “Connecting the Bluetooth® 2.0 interface and Bluetooth® device” on page 7-62.

⚠ WARNING

- Although the Bluetooth® 2.0 interface allows you to make hands-free calls, if you choose to use the cellular phone while driving, you must not allow yourself to be distracted from the safe operation of your vehicle. Anything, including cellular phone usage, that distracts you from the safe operation of your vehicle increases your risk of an accident.
- Refer to and comply with all state and local laws in your area regarding cellular phone usage while driving.

📖 NOTE

- If the ignition switch or the operation mode is left in ACC, the accessory power will automatically turn off after a certain period of time and you will no longer be able to use the Bluetooth® 2.0 interface. The accessory power comes on again if the ignition switch or the engine switch is operated. Refer to “ACC power auto-cutout function” on pages 6-14 and 6-17.
- The Bluetooth® 2.0 interface cannot be used if the Bluetooth® device has a flat battery or the device power is turned off.
- Hands-free calls will not be possible if your phone does not have service available.
- If you place the Bluetooth® device in the vehicle’s third seat or luggage compartment, you may not be able to use the Bluetooth® 2.0 interface.

NOTE

- Some Bluetooth® devices are not compatible with the Bluetooth® 2.0 interface.
- You can confirm the Link System software version by pressing the HANG-UP button three times (press and hold two times and then press briefly) within 10 seconds.
- For details on the Bluetooth® 2.0 interface, you can see them by accessing the MITSUBISHI MOTORS website. Please read and agree the “Warning about Links to the Web Sites of Other Companies” because it connects other than MITSUBISHI MOTORS website.
<http://www.mitsubishi-motors.com/en/products/index.html>
- Software updates by cellular phone/digital audio device manufacturers may change/alter device connectivity.
- For vehicles equipped with the ERA-GLO-NASS or the Telematics Control Unit (TCU), the Bluetooth® 2.0 interface cannot be used while an emergency call is activated.

Steering control switch and microphone
→ p. 7-57

Voice recognition function → p. 7-58

Useful voice commands → p. 7-59

Speaker enrollment function → p. 7-60

Connecting the Bluetooth® 2.0 interface and the Bluetooth® device → p. 7-62

Operating a music player connected via Bluetooth® → p. 7-67

How to make or receive hands-free calls
→ p. 7-67

Phone book function → p. 7-69

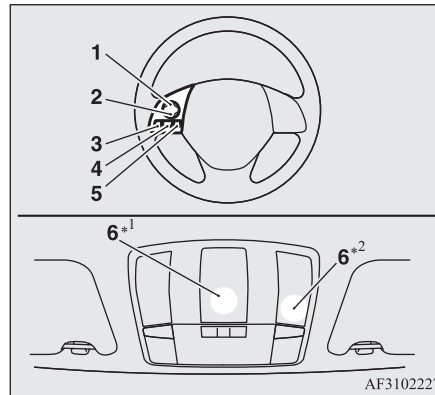
Steering control switch and microphone

*1: Vehicles equipped with the ERA-GLO-NASS

*2: Except for vehicles equipped with the ERA-GLONASS

- 1- Volume up button
- 2- Volume down button
- 3- SPEECH button
- 4- PICK-UP button
- 5- HANG-UP button
- 6- Microphone

Volume up button

Press this button to increase the volume.

Volume down button

Press this button to decrease the volume.

SPEECH button

- Press this button to change to voice recognition mode. While the system is in voice recognition mode, “Listening” will appear on the audio display.
- If you press the button briefly while in voice recognition mode, it will interrupt prompting and allow voice command input. Pressing the button longer will deactivate the voice recognition mode.
- Pressing this button briefly during a call will enable voice recognition and allow voice command input.

7**PICK-UP button**

- Press this button when an incoming call is received to answer the telephone.
- When another call is received during a call, press this button to put the first caller on hold and talk to the new caller.

Bluetooth® 2.0 interface*

- In such circumstances, you can press the button briefly to switch between callers. You will switch to the first caller and the other caller will be put on hold.
- To establish a three-way call in such situations, press the SPEECH button to enter voice recognition mode and then say “Join calls”.

HANG-UP button

7

- Press this button when an incoming call is received to refuse the call.
- Press this button during a call to end the current call.
When another call is on hold, you will switch to that call.
- If this button is pressed in the voice recognition mode, the voice recognition mode will be deactivated.

NOTE

- When you press the SPEECH button to enter voice recognition mode with a cellular phone paired to the system, current information on the cellular phone, such as “remaining battery life”, “signal strength” or “roaming”, will be displayed on the audio display.*

*Some cellular phones will not send this information to the Bluetooth® 2.0 interface.

7-58 For pleasant driving

NOTE

- Call waiting and three-way calls can be used by the Bluetooth® 2.0 interface, only if it is possible to use those services with your cellular phone.

Microphone

Your voice will be recognized by a microphone in the overhead console, allowing you to make hands-free calls with voice commands.

NOTE

- If a cellular phone is brought close to the microphone, it may create noise in the voice on the phone. In such a case, take the cellular phone to a place as far as possible from the microphone.

Voice recognition function

The Bluetooth® 2.0 interface is equipped with a voice recognition function. Simply say voice commands and you can perform various operations and make or receive hands-free calls.

With the Bluetooth® 2.0 interface, voice recognition is possible for English, French, Spanish, Italian, German, Dutch, Portuguese and Russian. The factory setting is “English” or “Russian.”

OGKE20E1

NOTE

- If the voice command that you say differs from the predefined command or cannot be recognized due to ambient noise or some other reason, the Bluetooth® 2.0 interface will ask you for the voice command again up to three times.
- For best performance and further reduction of ambient noise, close the vehicle windows, lower the blower speed and refrain from conversation with your passengers while engaging the voice recognition function.
- Some voice commands have alternative commands.
- Depending on the selected language, some functions may not be available.

Selecting the Language

1. Press the SPEECH button.
2. Say “Setup.”
3. Say “Language.”
4. The voice guide will say “Select a language: English, French, Spanish, Italian, German, Dutch, Portuguese or Russian” Say the desired language. (Example: Say “English.”)
5. The voice guide will say “English (French, Spanish, Italian, German, Dutch, Portuguese or Russian) selected. Is this correct?” Say “Yes.”
If you say “No,” the system will return to Step 4.

NOTE

- The voice guide will repeat the same message twice. The first message is in the current language, and the second message is in the selected language.
- If many entries are registered in the vehicle phone book, changing the language will take longer.
- Changing the language deletes the mobile phone book imported to the Bluetooth® 2.0 interface. If you wish to use it, you will have to import it again.

- When the voice guide says “English (French, Spanish, Italian, German, Dutch, Portuguese or Russian) selected,” the language change process will be completed and the system will return to the main menu.

Useful voice commands**Help function**

The Bluetooth® 2.0 interface is equipped with a help function.

If you say “Help” when the system is waiting for a voice command input, the system will tell you a list of the commands that can be used under the circumstances.

Cancelling

There are two cancel functions.

If you are at the main menu, say “Cancel” to exit from the Bluetooth® 2.0 interface. If you are anywhere else within the system, say “Cancel” to return to the main menu.

NOTE

- You can return to the previous menu by saying “Go Back.” (if so equipped)

Confirmation function setting

The Bluetooth® 2.0 interface is equipped with a confirmation function.

With the confirmation function activated, you are given more opportunities than normal to confirm a command when making various settings to the Bluetooth® 2.0 interface. This allows you to decrease the possibility that a setting is accidentally changed.

The confirmation function can be turned on or off by following the steps below.

- Press the SPEECH button.
- Say “Setup.”
- Say “Confirmation prompts”.
- The voice guide will say “Confirmation prompts are <on/off>. Would you like to turn confirmation prompts <off/on>”. Answer “Yes” to change the setting or answer “No” to keep the current setting.

- The voice guide will say “Confirmation prompts are <off/on>” and then the system will return to the main menu.

Security function

It is possible to use a password as a security function by setting a password of your choice for the Bluetooth® 2.0 interface.

When the security function is turned on, it is necessary to make a voice input of a 4-digit password in order to use all functions of the Bluetooth® 2.0 interface, except for reception.

Setting the password

Use the following procedure to turn on the security function by setting a password.

- Press the SPEECH button.
- Say “Setup.”
- Say “Password.”
- The voice guide will say “Password is disabled. Would you like to enable it?” Answer “Yes.” Answer “No” to cancel the setting of the password and return to the main menu.
- The voice guide will say “Please say a 4-digit password. Remember this password. It will be required to use this system.” Say a 4-digit number which you want to set as a password.

Bluetooth® 2.0 interface*

- For confirmation purposes, the voice guide will say “Password <4-digit password>. Is this correct?” Answer “Yes.” Answer “No” to return to the password input in Step 5.
- When the registration of the password is completed, the voice guide will say “Password is enabled” and the system will return to the main menu.

7

NOTE

- Password will be required to access the system after the next ignition cycle.
- It is required for a little time after engine stop that the entered password is actually recorded in the system.
If the ignition switch or the operation mode is made to ACC or ON or the engine is started immediately after engine stop, there is a case when the entered password is not recorded in the system. At this time, please try to enter the password again.

Entering the password

If a password has been set and the security function is enabled, the voice guide will say “Hands-free system is locked. State the password to continue” when the SPEECH button is pressed to enter voice recognition mode. Say the 4-digit password number to enter the password.

If the entered password is wrong, the voice guide will say “<4-digit password>, Incorrect password. Please try again.” Enter the correct password.

NOTE

- You can re-enter the password as many times as you want.
- If you have forgotten your password, say “Cancel” to quit the voice input mode and then check with a MITSUBISHI MOTORS Authorized Service Point.

Disabling the password

Use the following procedure to turn off the security function by disabling the password.

NOTE

- System must be unlocked to disable the password.

- Press the SPEECH button.
- Say “Setup.”
- Say “Password.”
- The voice guide will say “Password is enabled. Would you like to disable it?” Answer “Yes.”
Answer “No” to cancel the disabling of the password and return to the main menu.

- When the disabling of the password is completed, the voice guide will say “Password is disabled” and the system will return to the main menu.

Speaker enrollment function

The Bluetooth® 2.0 interface can use the speaker enrollment function to create a voice model for one person per language.

This makes it easier for the Bluetooth® 2.0 interface to recognise voice commands said by you.

You can turn a voice model registered with the speaker enrollment function on and off whenever you want.

Speaker enrollment

It takes approximately 2 to 3 minutes to complete the speaker enrollment process.

To ensure the best results, run through the process while in the driver’s seat, in an environment that is as quiet as possible (when there is no rain or strong winds and the vehicle windows are closed). Please turn off your phone while in speaker enrollment to prevent interruption of the process.

Use the following procedure for speaker enrollment.

- Stop your vehicle in a safe area, put the gearshift lever (M/T) in the “N” (Neutral) position, or the selector lever (A/T

or CVT) in the “P” (Park) position, and apply the parking brake.

NOTE

- Speaker enrollment is not possible unless the vehicle is parked. Make sure you park the vehicle in a safe area before attempting speaker enrollment.

2. Press the SPEECH button.
3. Say “Voice training”.
4. The voice guide will say “This operation must be performed in a quiet environment while the vehicle is stopped. See the owner’s manual for the list of required training phrases. Press and release the SPEECH button when you are ready to begin. Press the HANG-UP button to cancel at any time”. Press the SPEECH button to start the speaker enrollment process.

NOTE

- If you do not start the speaker enrollment process within 3 minutes of pressing the SPEECH button, the speaker enrollment function will time out. The voice guide will say “Speaker enrollment has timed out.” The system will then beep and the voice recognition mode will be deactivated.

5. The voice guide will prompt for phrase 1. Repeat the corresponding phrase listed in table “Enrollment commands” on page 7-76.

The system will register your voice and then move on to the registration of the next command. Continue the process until all phrases have been registered.

NOTE

- To repeat the most recent voice training command, press and release the SPEECH button.
- If you press the HANG-UP button anytime during the process, the system will beep and stop the speaker enrollment process.

6. When all enrollment commands have been read out, the voice guide will say “Speaker enrollment is complete.” The system will then end the speaker enrollment process and return to the main menu.

NOTE

- Completing the speaker enrollment process will turn on the voice model automatically.
- The commands “Help” and “Cancel” will not work in this mode.

Enabling and disabling the voice model and retraining

You can turn a voice model registered with the speaker enrollment function on and off whenever you want.

You can also retrain the system.

Use the following procedure to perform these actions.

1. Press the SPEECH button.
2. Say “Voice training”.
3. If you have completed a speaker enrollment process once already, the voice guide will say either “Enrollment is enabled. Would you like to disable or retrain?” or “Enrollment is disabled. Would you like to enable or retrain?”
4. When enrollment is “enabled,” the voice model is on; when enrollment is “disabled,” the voice model is off. Say the command that fits your needs. Say “Retrain” to start the speaker enrollment process and recreate a new voice model. (Refer to “Speaker enrollment” on page 7-60.)

Bluetooth® 2.0 interface*

Connecting the Bluetooth® 2.0 interface and Bluetooth® device

Before you can make or receive hands-free calls or play music using the Bluetooth® 2.0 interface function, you must pair the Bluetooth® device and Bluetooth® 2.0 interface.

7

NOTE

- Pairing is required only when the device is used for the first time. Once the device has been paired with the Bluetooth® 2.0 interface, all you need is to bring the device into the vehicle next time and the device will connect to the Bluetooth® 2.0 interface automatically (if supported by the device). The device must have Bluetooth® turned ON to connect.

Up to 7 Bluetooth® devices can be paired with the Bluetooth® 2.0 interface.

If multiple paired Bluetooth® devices are available in the vehicle, the cellular phone or music player most recently connected is automatically connected to the Bluetooth® 2.0 interface.

You can also change a Bluetooth® device to be connected.

To pair

To pair a Bluetooth® device with the Bluetooth® 2.0 interface, use either one of the following 2 methods (Type 1 or Type 2).

Pairing procedure - Type 1*

1. Stop your vehicle in a safe area, put the gearshift lever (M/T) in the “N” (Neutral) position, or the selector lever (A/T or CVT) in the “P” (Park) position, and apply the parking brake.

NOTE

- You cannot pair any Bluetooth® device with the Bluetooth® 2.0 interface unless the vehicle is parked. Before pairing a Bluetooth® device with the Bluetooth® 2.0 interface, confirm that the vehicle is parked in a safe location.

2. Press the SPEECH button.
3. Say “Setup.”
4. Say “Pairing Options.”
5. The voice guide will say “Select one of the following: pair, edit, delete, or list.” Say “Pair.”

NOTE

- If 7 devices have already been paired, the voice guide will say “Maximum devices paired” and then the system will end the pairing process. To register a new device, delete one device and then repeat the pairing process.
(Refer to “Selecting a device: Deleting a device” on page 7-65.)

6. The voice guide will say “Please say a 4-digit pairing code.” Say a 4-digit number.

When the confirmation function is on, the system will confirm whether the number said is acceptable. Answer “Yes.”

Answer “No” to return to pairing code selection.

NOTE

- Some Bluetooth® devices require a specific pairing code. Please refer to the device manual for pairing code requirements.

NOTE

- The pairing code entered here is only used for the Bluetooth® connection certification. It is any 4-digit number the user would like to select.
Remember the pairing code as it needs to be keyed into the Bluetooth® device later in the pairing process.
Depending on the connection settings of the Bluetooth® device, this code may have to be entered each time you connect the Bluetooth® device to the Bluetooth® 2.0 interface. For the default connection settings, refer to the instructions for the device.

7. The voice guide will say “Start pairing procedure on the device. See the device manual for instructions.” Enter in the Bluetooth® device the 4-digit number you have registered in Step 6.

NOTE

- According to the corresponding device to Bluetooth®, it might take a few minute to pair the Bluetooth® device with the Bluetooth® 2.0 interface.
- If the Bluetooth® 2.0 interface cannot recognize the Bluetooth® device, the voice guide will say “Pairing has timed out” and the pairing process will be cancelled.
Confirm that the device you are pairing supports Bluetooth®, and try pairing it again.

NOTE

- If you enter the wrong number, the voice guide will say “Pairing failed” and the pairing process will be cancelled.
Confirm the number is right, and try pairing it again.

8. The voice guide will say “Please say the name of the device after the beep.” You can assign a desired name for the Bluetooth® device and register it as a device tag. Say the name you want to register after the beep.

NOTE

- When the confirmation function is on, after repeating the device tag you have said, the voice guide will ask “Is this correct?” Answer “Yes.”
To change the device tag, answer “No” and then say the device tag again.

9. The voice guide will say “Pairing complete,” and the pairing process will end.

Pairing procedure - Type 2*

1. Stop your vehicle in a safe area, put the gearshift lever (M/T) in the “N” (Neutral) position, or the selector lever (A/T or CVT) in the “P” (Park) position, and apply the parking brake.

NOTE

- You cannot pair any Bluetooth® device with the Bluetooth® 2.0 interface unless the vehicle is parked. Before pairing a Bluetooth® device with the Bluetooth® 2.0 interface, confirm that the vehicle is parked in a safe location.

2. Press the SPEECH button.
3. Say “Pair Device.”

NOTE

- The following procedure (① to ③) can also be used instead of saying “Pair Device.”
Replace this step 3 with the following procedure if you prefer.
 - ① Say “Setup.”
 - ② Say “Pairing Options.”
 - ③ The voice guide will say “Select one of the following: pair, edit, delete, list or set code.”
Say “Pair.”
- If 7 devices have already been paired, the voice guide will say “Maximum devices paired” and then the system will end the pairing process. To register a new device, delete one device and then repeat the pairing process.
(Refer to “Selecting a device: Deleting a device” on page 7-65.)

4. The voice guide will say “Start pairing procedure on the device. See the device

For pleasant driving 7-63

Bluetooth® 2.0 interface*

manual for instructions.” and then will say “The pairing code is <pairing code>.”

NOTE

- Some Bluetooth® devices require a specific pairing code. Please refer to the device manual for pairing code requirements and read the next section “If your device requires a specific pairing code” on page 7-65 to set the pairing code.
- The pairing code entered here is only used for the Bluetooth® connection certification. Depending on the connection settings of the Bluetooth® device, this code may have to be entered each time you connect the Bluetooth® device to the Bluetooth® 2.0 interface. For the default connection settings, refer to the instructions for the device.

- 7
5. Enter in the Bluetooth® device the 4-digit number that has been read out in Step 4.

NOTE

- According to the corresponding device to Bluetooth®, it might take a few minutes to pair the Bluetooth® device with the Bluetooth® 2.0 interface.

NOTE

- If the Bluetooth® 2.0 interface cannot recognize the Bluetooth® device, the voice guide will say “Pairing has timed out” and the pairing process will be cancelled. Confirm that the device you are pairing supports Bluetooth®, and try pairing it again.
 - If you enter the wrong number, the voice guide will say “Pairing failed” and the pairing process will be cancelled. Confirm the number is right, and try pairing it again.
- If your device requires a specific pairing code, you need to set the pairing code. Refer to the device manual for pairing code requirements and read the next section “If your device requires a specific pairing code” on page 7-65.

6. The voice guide will say “Please say the name of the device after the beep.” You can assign a desired name for the Bluetooth® device and register it as a device tag. Say the name you want to register after the beep.

NOTE

- When the confirmation function is on, after repeating the device tag you have said, the voice guide will ask “Is this correct?” Answer “Yes.”
To change the device tag, answer “No” and then say the device tag again.

7. The voice guide will say “Pairing Complete. Would you like to import the contacts from your mobile device now?” Answer “Yes,” and the voice guide will say “Please wait while the contacts are imported. This may take several minutes.” Answer “No” to end the pairing process.

If your device requires a specific pairing code

If your device requires a specific pairing code, you need to set the pairing code. Follow the procedures below.

1. Press the SPEECH button.
2. Say “Setup.”
3. Say “Pairing Options.”
4. Say “Set Code.”
5. The voice guide will say “Do you want the pairing code to be random or fixed?” Say “Fixed.”
6. The voice guide will say “Please say a 4-digit pairing code.” Say a 4-digit number.
7. The voice guide will say “Pairing code set to <pairing code>.”
When the confirmation function is on, the system will confirm whether the number said is acceptable. Answer “Yes.”
Answer “No,” the system will return to Step 6.

8. The voice guide will say “Do you want to pair a device now?” Answer “Yes,” the system will proceed to Step 3 in the pairing process. Refer to the “Pairing procedure- Type 2.”

Selecting a device

If multiple paired Bluetooth® devices are available in the vehicle, the cellular phone or music player most recently connected is automatically connected to the Bluetooth® 2.0 interface.

You can connect to the other paired cellular phone or music player by following setting change procedures.

To select a cellular phone

1. Press the SPEECH button.
2. Say “Setup.”
3. Say “Select phone.”
4. After the voice guide says “Please say,” the numbers of the cellular phones and device tags of corresponding cellular phones will be read out in order, starting with the cellular phone that has been most recently connected.
Say the number of the cellular phone that you want to connect to.
When the confirmation function is on, the system will ask you again whether the phone that you want to connect to is

correct. Answer “Yes” to continue and connect to the cellular phone.
Answer “No,” and the voice guide will say “Please say.” Say the number of the phone that you want to connect to.

NOTE

- You can connect to a phone at any time by pressing the SPEECH button and saying the number, even before all of the paired numbers and device tags of corresponding cellular phones are read out by the system.

5. The selected phone will be connected to the Bluetooth® 2.0 interface. The voice guide will say “<device tag> selected” and then the system will return to the main menu.

To select a music player

1. Press the SPEECH button.
2. Say “Setup.”
3. Say “Select music player.”
4. After the voice guide says “Please say,” the numbers of the music players and device tags of corresponding music players will be read out in order, starting with the music player that has been most recently connected.
Say the number of the music player that you want to connect to.

When the confirmation function is on, the system will ask you again whether the music player that you want to connect to is correct. Answer “Yes” to continue and connect to the music player.
Answer “No,” and the voice guide will say “Please say.” Say the number of the music player that you want to connect to.

NOTE

- You can connect to a music player at any time by pressing the SPEECH button and saying the number, even before all of the paired numbers and device tags of corresponding music players are read out by the system.

5. The selected music player will be connected to the Bluetooth® 2.0 interface. The voice guide will say “<device tag> selected” and then the system will return to the main menu.

Deleting a device

Use the following procedure to delete a paired Bluetooth® device from the Bluetooth® 2.0 interface.

1. Press the SPEECH button.
2. Say “Setup.”
3. Say “Pairing options.”

Bluetooth® 2.0 interface*

7

- The voice guide will say “Select one of the following: pair, edit, delete, or list.” Say “Delete.”
- After the voice guide says “Please say,” the numbers of the devices and device tags of corresponding devices will be read out in order, starting with the device that has been most recently connected. After it completes reading all pairs, the voice guide will say “or all.” Say the number of the device that you want to delete from the system. If you want to delete all paired phones from the system, say “All.”
- For confirmation purposes, the voice guide will say “Deleting <device tag> <number>. Is this correct?” or “Deleting all devices. Is this correct?” Answer “Yes” to delete the phone(s). Answer “No” to return to Step 4.
- The voice guide will say “Deleted,” and then the system will end the device deletion process.

NOTE

- If the device deletion process fails for some reason, the voice guide will say “Delete failed” and then the system will cancel deleting the device.

To check a paired Bluetooth® device

You can check a paired Bluetooth® device by following the steps below.

- Press the SPEECH button.
- Say “Setup.”
- Say “Pairing options.”
- The voice guide will say “Select one of the following: pair, edit, delete, or list.” Say “List.”
- The voice guide will read out device tags of corresponding devices in order, starting with the Bluetooth® device that has been most recently connected.
- After the device tags of all paired Bluetooth® devices have been read, the system will say “End of list, would you like to start from the beginning?” To hear the list again from the beginning, answer “Yes.” When you are done, answer “No” to return to the main menu.

NOTE

- If you press and release the SPEECH button and say “Continue” or “Previous” while the list is being read, the system will advance or rewind the list. Say “Continue” to proceed to the device with the next highest number or “Previous” to return to the phone with the previous number.
- You can change the device tag by pressing and releasing the SPEECH button and then saying “Edit” while the list is being read.
- You can change the phone to be connected by pressing and releasing the SPEECH button and then saying “Select phone” while the list is being read.
- You can change the music player to be connected by pressing and releasing the SPEECH button and then saying “Select music player” while the list is being read.

Changing a device tag

You can change the device tag of a paired cellular phone or music player. Follow the steps below to change a device tag.

- Press the SPEECH button.
- Say “Setup.”
- Say “Pairing options.”
- The voice guide will say “Select one of the following: pair, edit, delete, or list.” Say “Edit.”
- The voice guide will say “Please say,” and read out the numbers of the Blue-

tooth® devices and device tags of corresponding devices in order, starting with the Bluetooth® that has been most recently connected.

After all paired device tags have been read, the voice guide will say “Which device, please?” Say the number of the device tag you want to change.

NOTE

- You can press and release the SPEECH button while the list is being read, and immediately say the number of the device tag you want to change.

- The voice guide will say “New name, please.” Say the name you want to register as a new device tag.

When the confirmation function is on, the voice guide will say “<New device tag>. Is this correct?” Answer “Yes.”

Answer “No,” to say the new device tag you want to register again.

- The device tag is changed.

When the change is complete, the voice guide will say “New name saved” and then the system will return to the main menu.

Operating a music player connected via Bluetooth®

For the operation of a music player connected via Bluetooth®, refer to “Listen to Bluetooth® Audio” on page 7-46. On vehicles equipped with MITSUBISHI Multi-Communication System (MMCS), the Smartphone Link Display Audio or the DISPLAY AUDIO, refer to the separate owner’s manual.

How to make or receive hands-free calls

You can make or receive hands-free calls using a Bluetooth® compatible cellular phone connected to the Bluetooth® 2.0 interface.

You can also use the phone books in the Bluetooth® 2.0 interface to make calls without dialling telephone numbers.

To make a call → p. 7-67

SEND function → p. 7-69

Receiving calls → p. 7-69

MUTE function → p. 7-69

Switching between hands-free mode and private mode → p. 7-69

NOTE

- The hands-free calls might not be operated correctly when it makes calling or receiving by operating the cellular phone directly.

To make a call

You can make a call in the following 3 ways using the Bluetooth® 2.0 interface:

Making a call by saying a telephone number, making a call using the Bluetooth® 2.0 interface’s phone book, and making a call by re-dialing.

Making a call by using the telephone number

You can make a call by saying the telephone number.

7

- Press the SPEECH button.
- Say “Dial.”
- After the voice guide says “Number please,” say the telephone number.
- The voice guide will say “Dialing <number recognised>.”

The Bluetooth® 2.0 interface will then make the call.

When the confirmation function is on, the system will confirm again the telephone number. To continue with that number, answer “Yes.”

To change the telephone number, answer “No.” The system will say “Number please” then say the telephone number again.

Bluetooth® 2.0 interface*

NOTE

- In the case of English, the system will recognize both “zero” and “oh” (Letter “o”) for the number “0.”
- The Bluetooth® 2.0 interface supports numbers (0 to 9) and characters (+, # and *).
- The maximum supported telephone number length is as follows:
 - International telephone number: + and telephone numbers (to 18 digits).
 - Except for international telephone number: telephone numbers (to 19 digits).

7

Making a call using a phone book

You can make calls using the vehicle phone book or mobile phone book of the Bluetooth® 2.0 interface.

For details on the phone books, refer to “Phone book function” on page 7-69.

1. Press the SPEECH button.
2. Say “Call.”

NOTE

- If you say “Call” when the vehicle phone book and the mobile phone book are empty, the voice guide will say “The vehicle phone book is empty. Would you like to add a new entry now?”
Answer “Yes,” and the voice guide will say “Entering the phone book - new entry menu.” You can now create data in the vehicle phone book.
Answer “No,” to return to the main menu.

3. After the voice guide says “Name please,” say the name you want to call, from those registered in the phone book.

4. If there is only one match, the system proceeds to Step 5.

If there are two or more matches, the voice guide will say “More than one match was found, would you like to call <returned name>.” If that person is the one you want to call, answer “Yes.”

Answer “No,” and the name of the next matching person will be uttered by the voice guide.

NOTE

- If you say “No” to all names read by the system, the voice guide will say “Name not found, returning to main menu” and the system will return to the main menu.

5. If only one telephone number is registered under the name you just said, the voice guide proceeds to Step 6.

If two or more telephone numbers are registered that match the name you just said, the voice guide will say “Would you like to call <name> at [home], [work], [mobile], or [other]?” Select the location to call.

NOTE

- If the name you selected has matching data in the vehicle phone book but no telephone number is registered under the selected location, the voice guide will say “{home/work/mobile/other} not found for <name>. Would you like to add location or try again?”
Say “Try again,” and the system will return to Step 3.
Say “Add location” and you can register an additional telephone number under the selected location.
- If the name you selected has matching data in the mobile phone book but no telephone number is registered under the selected location, the voice guide will say “{home/work/mobile/other} not found for <name>. Would you like to try again?”
Answer “Yes,” and the system will return to Step 3.
Answer “No,” and the call will be cancelled.
Start over again from step 1.

6. The voice guide will say “Calling <name> <location>” and then the system will dial the telephone number.

NOTE

- When the confirmation function is on, the system will ask if the name and location of the receiver are correct. If the name is correct, answer “Yes.”
To change the name or location to call, answer “No.” The system will return to Step 3.

Redialing

You can redial the last number called, based on the history of dialed calls in the paired cellular phone.

Use the following procedure to redial.

1. Press the SPEECH button.
2. Say “Redial.”

SEND function

During a call, press the SPEECH button to enter voice recognition mode, then say “<numbers> SEND” to generate DTMF tones.

For example, if during a call you need to simulate the pressing of a phone button as a response to an automated system, press the SPEECH button and speak “1 2 3 4 pound send” and the 1234# will be sent via your cellular phone.

Receiving calls

If an incoming phone call is received while the ignition switch or the operation mode is in ON or ACC, the audio system will be automatically turned on and switched to the incoming call, even when the audio system was originally off.

The voice guide announcement for the incoming call will be output from the front passenger’s seat speaker.

If the CD player or radio was playing when the incoming call was received, the audio system will mute the sound from the CD player or radio and output only the incoming call.

To receive the call, press the PICK-UP button on the steering wheel control switch.

When the call is over, the audio system will return to its previous state.

MUTE function

At any time during a call, you can mute the vehicle microphone.

Pressing the SPEECH button and then saying “Mute” during a call will turn ON the MUTE function and mute the microphone.

Saying “Mute off” in the same way will turn off the MUTE function and cancel the mute on the microphone.

Switching between hands-free mode and private mode

The Bluetooth® 2.0 interface can switch between hands-free mode (hands-free calls) and private mode (calls using cellular phone).

If you press the SPEECH button and say “Transfer call” during a hands-free call, you can stop the hands-free mode and talk in private mode.

To return to Hands-free mode, press the SPEECH button again and say “Transfer call.”

Phone book function

The Bluetooth® 2.0 interface has 2 types of unique phone books that are different from the phone book stored in the cellular phone. They are the vehicle phone book and the mobile phone book.

These phone books are used to register telephone numbers and to make calls to desired numbers via the voice recognition function.

NOTE

- Disconnecting the battery cable will not delete information registered in the phone book.

Vehicle phone book

This phone book is used when making calls with the voice recognition function.

Up to 32 names can be registered in the vehicle phone book per language.

Also, each entry has 4 locations associated with: home, work, mobile and other. You can register one telephone number for each location.

You can register a desired name as a name for any phone book entry registered in the vehicle phone book.

Names and telephone numbers can be changed later on.

Bluetooth® 2.0 interface*

The vehicle phone book can be used with all paired cellular phones.

To register a telephone number in the vehicle phone book

You can register a telephone number in the vehicle phone book in the following 2 ways: Reading out a telephone number, and selecting and transferring 1 phone book entry from the phone book of the cellular phone.

7

To register by reading out a telephone number

1. Press the SPEECH button.
2. Say "Phone book."
3. The voice guide will say "Select one of the following: new entry, edit number, edit name, list names, delete, erase all, or import contact." Say "New entry."
4. The voice guide will say "Name please." Say your preferred name to register it.

NOTE

- If the maximum number of entries are already registered, the voice guide will say "The phone book is full. Would you like to delete a name?" Say "Yes" if you want to delete a registered name. Say "No," to return to the main menu.

5. When the name has been registered, the voice guide will say "home, work, mo-

bile, or other?" Say the location for which you want to register a telephone number.

NOTE

- When the confirmation function is on, the voice guide will say "<Location>. Is this correct?" Answer "Yes."
If a telephone number has been registered for the selected location, the voice guide will say "The current number is <telephone number>, number please."
If you do not want to change the telephone number, say "cancel" or the original number to keep it registered.

6. The voice guide will say "Number please." Say the telephone number to register it.

NOTE

- In the case of English, the system will recognise both "zero" and "oh" (Letter "o") for the number "0."

7. The voice guide will repeat the telephone number you have just read, and then register the number.

When the telephone number has been registered, the voice guide will say "Number saved. Would you like to add another number for this entry?"

To add another telephone number for a new location for the current entry, answer "Yes." The system will return to location selection in Step 5.

Answer "No" to end the registration process and return to the main menu.

NOTE

- When the confirmation function is on, after repeating the telephone number you have read, the voice guide will ask "Is this correct?" Answer "Yes."
Answer "No" to return to telephone number registration in step 6.

To select and transfer one phone book entry from the phone book of the cellular phone

You can select 1 phone book entry from the phone book of the cellular phone and register it in the vehicle phone book.

 **NOTE**

- Transfer is not permitted unless the vehicle is parked. Before transferring, make sure that the vehicle is parked in a safe location.
- All or part of data may not be transferred, even when the cellular phone supports Bluetooth®, depending on the compatibility of the device.
- The maximum supported telephone number length is 19 digits. Any telephone number of 20 digits or more will be truncated to the first 19 digits.
- If telephone numbers contain characters other than 0 to 9, *, # or +, these characters are deleted before the transfer.
- For the connection settings on the cellular phone side, refer to the instructions for the cellular phone.

1. Press the SPEECH button.
2. Say “Phone book.”
3. The voice guide will say “Select one of the following: new entry, edit number, edit name, list names, delete, erase all, or import contact.” Say “Import contact.”
4. The voice guide will say “Would you like to import a single entry or all contacts?” Say “Single entry.”
The Bluetooth® 2.0 interface will become ready to receive transferred phone book data.

 **NOTE**

- If the maximum number of entries are already registered, the voice guide will say “The phone book is full. Would you like to delete a name?” Say “Yes” if you want to delete a registered name. Say “No,” to return to the main menu.

5. After the voice guide says “Ready to receive a contact from the phone. Only a home, a work, and a mobile number can be imported,” the Bluetooth® 2.0 interface will receive the phone book data from the Bluetooth® compatible cellular phone.
6. Operate the Bluetooth® compatible cellular phone to set it up so that the phone book entry you want to register in the vehicle phone book can be transferred to the Bluetooth® 2.0 interface.

 **NOTE**

- If the Bluetooth® 2.0 interface cannot recognize the Bluetooth® compatible cellular phone or the connection takes too much time, the voice guide will say “Import contact has timed out” and then the system will cancel the registration. In such case, start over again from Step 1.

 **NOTE**

- Pressing the HANG-UP button or pressing and holding the SPEECH button will cancel the registration.

7. When the reception is completed, the voice guide will say “<Number of telephone numbers that had been registered in the import source> numbers have been imported. What name would you like to use for these numbers?”
Say the name you want to register for this phone book entry.

 **NOTE**

- If the entered name is already used for other phone book entry or similar to a name used for other phone book entry, that name cannot be registered.

8. The voice guide will say “Adding <name>.”
When the confirmation function is on, the system will ask if the name is correct. Answer “Yes.”
Answer “No,” and the voice guide will say “Name please.” Register a different name.
9. The voice guide will say “Numbers saved.”

Bluetooth® 2.0 interface*

- The voice guide will say “Would you like to import another contact?”
Answer “Yes” if you want to continue with the registration. You can continue to register a new phone book entry from Step 5.
Answer “No,” to return to the main menu.

7

To change the content registered in the vehicle phone book

You can change or delete a name or telephone number registered in the vehicle phone book.

You can also listen to the list of names registered in the vehicle phone book.

NOTE

- The system must have at least one entry.

Editing a telephone number

- Press the SPEECH button.
- Say “Phone book.”
- The voice guide will say “Select one of the following: new entry, edit number, edit name, list names, delete, erase all, or import contact.” Say “Edit number.”
- The voice guide will say “Please say the name of the entry you would like to edit, or say list names.” Say the name of the phone book entry you want to edit.

NOTE

- Say “List names,” and the names registered in the phone book will be read out in order. Refer to “Vehicle phone book: Listening to the list of registered names” on page 7-73.

- The voice guide will say “Home, work, mobile or other?” Select and say the location where the telephone number you want to change or add is registered.

When the confirmation function is on, the system will check the target name and location again. Answer “Yes” if you want to continue with the editing.

Answer “No,” the system will return to Step 3.

- The voice guide will say “Number please.” Say the telephone number you want to register.

NOTE

- If the telephone number is already registered in the selected location, the voice guide will say “The current number is <current number>. New number, please.” Say a new telephone number to change the current number.

- The voice guide will repeat the telephone number.

When the confirmation function is on, the system will ask if the number is correct. Answer “Yes.”

Answer “No,” the system will return to the Step 3.

- Once the telephone number is registered, the voice guide will say “Number saved” and then the system will return to the main menu.

NOTE

- If the location where a telephone number was already registered has been overwritten with a new number, the voice guide will say “Number changed” and then the system will return to the main menu.

Editing a name

- Press the SPEECH button.
- Say “Phone book.”
- The voice guide will say “Select one of the following: new entry, edit number, edit name, list names, delete, erase all, or import contact.” Say “Edit name.”
- The voice guide will say “Please say the name of the entry you would like to edit, or say list names.” Say the name you want to edit.

NOTE

- Say “List names,” and the names registered in the phone book will be read out in order. Refer “Vehicle phone book: Listening to the list of registered names” on page 7-73.

5. The voice guide will say “Changing <name>.”

When the confirmation function is on, the system will ask if the name is correct. Answer “Yes” if you want to continue with the editing based on this information.

Answer “No” to return to Step 4.

6. The voice guide will say “Name please.” Say the new name you want to register.

7. The registered name will be changed. When the change is completed, the system will return to the main menu.

■ Listening to the list of registered names

1. Press the SPEECH button.
2. Say “Phone book.”
3. The voice guide will say “Select one of the following: new entry, edit number, edit name, list names, delete, erase all, or import contact.” Say “List names.”
4. Bluetooth® 2.0 interface will read out the entries in the phone book in order.

5. When the voice guide is done reading the list, it will say “End of list, would you like to start from the beginning?” When you want to check the list again from the beginning, answer “Yes.” When you are done, answer “No” to return to the previous or main menu.

NOTE

- You can call, edit or delete a name that is being read out. Press the SPEECH button and say “Call” to call the name, “Edit name” to edit it, or “Delete” to delete it. The system will beep and then execute your command.
- If you press the SPEECH button and say “Continue” or “Previous” while the list is being read, the system will advance or rewind the list. Say “Continue” to proceed to the next entry or “Previous” to return to the previous entry.

■ Deleting a telephone number

1. Press the SPEECH button.
2. Say “Phone book.”
3. The voice guide will say “Select one of the following: new entry, edit number, edit name, list names, delete, erase all, or import contact.” Say “Delete.”
4. The voice guide will say “Please say the name of the entry you would like to delete, or say list names.” Say the name of

the phone book entry in which the telephone number you want to delete is registered.

NOTE

- Say “List names,” and the names registered in the phone book will be read out in order. Refer to “Vehicle phone book: Listening to the list of registered names” on page 7-73.

5. If only one telephone number is registered in the selected phone book entry, the voice guide will say “Deleting <name> <location>.”

If multiple telephone numbers are registered in the selected phone book entry, the voice guide will say “Would you like to delete [home], [work], [mobile], [other], or all?”

Select the location to delete, and the voice guide will say “Deleting <name> <location>.”

NOTE

- To delete the telephone numbers from all locations, say “All.”

Bluetooth® 2.0 interface*

6. The system will ask if you really want to delete the selected telephone number(s) to go ahead with the deletion, answer “Yes.”

Answer “No,” the system will cancel deleting the telephone number(s) and then return to Step 4.

7. When the deletion of the telephone number is completed, the voice guide will say “<name> <location> deleted” and then the system will return to the main menu.

If all locations are deleted, the system will say “<name> and all locations deleted” and the name will be removed from the phone book. If numbers still remain under the entry, the name will retain the other associated numbers.

Erasing the phone book

You can delete all registered information from the vehicle phone book.

1. Press the SPEECH button.
2. Say “Phone book.”
3. The voice guide will say “Select one of the following: new entry, edit number, edit name, list names, delete, erase all, or import contact.” Say “Erase all.”

4. For confirmation purposes, the voice guide will ask “Are you sure you want to erase everything from your hands-free system phone book?” Answer “Yes.”

Answer “No” to cancel the deletion of all registered information in the phone book and return to the main menu.

5. The voice guide will say “You are about to delete everything from your hands-free system phone book. Do you want to continue?” Answer “Yes” to continue. Answer “No” to cancel the deletion of all registered information in the phone book and return to the main menu.

6. The voice guide will say “Please wait, erasing the handsfree system phone book” and then the system will delete all data in the phone book.

When the deletion is complete, the voice guide will say “Hands-free system phone book erased” and then the system will return to the main menu.

Mobile phone book

All entries in the phone book stored in the cellular phone can be transferred in a batch and registered in the mobile phone book.

Up to 7 mobile phone books, each containing up to 1,000 names, can be registered.

The Bluetooth® 2.0 interface automatically converts from text to voice the names registered in the transferred phone book entries, and creates names.

NOTE

- Only the mobile phone book transferred from the connected cellular phone can be used with that cellular phone.
- You cannot change the names and telephone numbers in the phone book entries registered in the mobile phone book. You cannot select and delete specific phone book entries, either. To change or delete any of the above, change the applicable information in the source phone book of the cellular phone and then transfer the phone book again.

To import a devices phone book

Follow the steps below to transfer to the mobile phone book the phone book stored in the cellular phone.

NOTE

- Transfer should be completed while the vehicle is parked. Before transferring, make sure that the vehicle is parked in a safe location.
- The already stored phone book in the mobile phone book is overwritten by the stored phone book in the cellular phone.

NOTE

- All or part of data may not be transferred, even when the cellular phone supports Bluetooth®, depending on the compatibility of the device.
- Only a home, a work, and a mobile number can be imported.
- The maximum supported telephone number length is 19 digits. Any telephone number of 20 digits or more will be truncated to the first 19 digits.
- If telephone numbers contain characters other than 0 to 9, *, # or +, these characters are deleted before the transfer.
- For the connection settings on the cellular phone side, refer to the instructions for the cellular phone.

1. Press the SPEECH button.
2. Say "Phone book."
3. The voice guide will say "Select one of the following: new entry, edit number, edit name, list names, delete, erase all, or import contact." Say "Import contact."
4. The voice guide will say "Would you like to import a single entry or all contacts?" Say "All contacts."
5. The voice guide will say "Importing the contact list from the mobile phone book. This may take several minutes to complete. Would you like to continue?" Answer "Yes," transferring to the mobile phone book the phone book stored in the cellular phone will start.

Answer "No," to return to the main menu.

NOTE

- The transfer may take some time to complete depending on the number of contacts.
- If the Bluetooth® 2.0 interface could not be connected to the Bluetooth® compatible cellular phone, the voice guide will say "Unable to transfer contact list from phone" and then the system will return to the main menu.
- If you press the HANG-UP button or press and hold the SPEECH button during the data transfer, the transfer will be cancelled and the system will return to the main menu.
- If an error occurs during the data transfer, all transfer will be cancelled and the voice guide will say "Unable to complete the phone book import" and then the system will return to the main menu.
- If there are no contacts in the phone book, the voice guide will say "There are no contacts on the connected phone."

6. When the transfer is complete, the voice guide will say "Import complete" and then the system will return to the main menu.

USB input terminal*

Enrollment commands

Phrase	English	French	Spanish	Italian	German	Dutch	Portuguese	Russian
1	0123456789	0123456789	0123456789	0123456789	0123456789	0123456789	0123456789	0123456789
2	888 555 1212	888 555 1212	888 555 1212	888 555 1212	888 555 1212	888 555 1212	888 555 1212	888 555 1212
3	Call	Appeler	Llamar	Chiama	Anrufen	Bellen	Ligar	Вызов
4	Dial	Composer	Marcar	Componi	Wählen	Nummer keuze	Marcar	Набор
5	Setup	Configurer	Configuración	Configura	Einrichtung	Setup	Configurar	Настройка
6	Cancel	Annuler	Cancelar	Annulla	Abbrechen	Annuleren	Cancelar	Отмена
7	Continue	Continuer	Continuar	Continua	Weiter	Doorgaan	Continuar	Продолжить
8	Help	Aide	Ayuda	Aiuto	Hilfe	Help	Ajuda	Справка

7

USB input terminal*

You can connect your USB memory device or iPod* to play music files stored in the USB memory device or iPod.

The USB input terminal (A) is located in the indicated position.

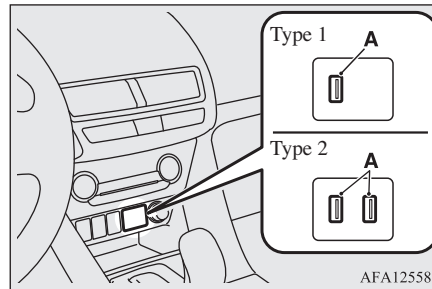

This section explains how to connect and remove a USB memory device or iPod. See the following section for details on how to play music files. Refer to “Listening to an iPod” on page 7-39. Refer to “Listening to Audio Files on a USB Device” on page 7-41. Refer to “To play iPod/USB memory device tracks via voice operation” on page 7-43.

How to connect a USB memory device

1. Park your vehicle in a safe place and turn the ignition switch to the “LOCK” position or put the operation mode in OFF.

*“iPod” is a registered trademark of Apple Inc. in the United States and other countries.

2. Connect a commercially available USB connector cable (B) to the USB memory device (A).

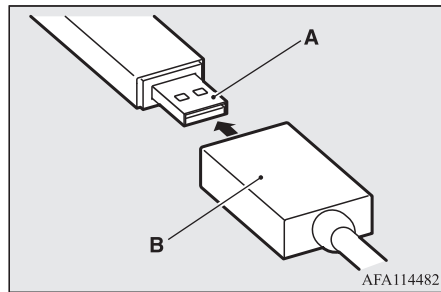

3. Connect the USB connector cable to the USB input terminal.

NOTE

- Do not connect the USB memory device to the USB input terminal directly. The USB memory device may be damaged.

4. To remove the USB connector cable, turn the ignition switch to the “LOCK” position or put the operation mode in OFF first and perform the installation steps in reverse.

How to connect an iPod

1. Park your vehicle in a safe place and turn the ignition switch to the “LOCK” position or put the operation mode in OFF.
2. Connect the connector cable to the iPod.

NOTE

- Use a genuine connector cable from Apple Inc.

3. Connect the connector cable to the USB input terminal.
4. To remove the connector cable, turn the ignition switch to the “LOCK” position or put the operation mode in OFF first and perform the installation steps in reverse.

Types of connectable devices and supported file specifications

Except for vehicles equipped with the Bluetooth® 2.0 interface

For details about the types of connectable devices and supported file specifications, refer to the following pages and manuals.

[For vehicles equipped with the LW/MW/FM radio/CD player]

Refer to “Listening to an iPod” on page 7-39, “Listening to Audio Files on a USB Device” on page 7-41 and “Audio Files (MP3/WMA/AAC)” on page 7-26.

[For vehicles equipped with the MITSUBISHI Multi-Communication System (MMCS), the Smartphone Link Display Audio or the DISPLAY AUDIO]

Refer to the separate owner’s manual.

For vehicles equipped with the Bluetooth® 2.0 interface

For details about the types of connectable devices and supported file specifications, refer to the following section.

Device types

Devices of the following types can be connected.

Model name	Condition
USB memory device	Storage capacity of 256 Mbytes or more (File System is FAT16/32)
Models other than USB memory devices and iPods	Digital audio player supporting mass storage class

For pleasant driving 7-77

Sun visors

For connectable device type for “iPod*,” “iPod classic*,” “iPod nano*,” “iPod touch*” and “iPhone*,” access the MITSUBISHI MOTORS website.

Please read and agree to the “Warning about Links to the Web Sites of Other Companies”. The websites mentioned above may connect you to websites other than the MITSUBISHI MOTORS website.

<http://www.mitsubishi-motors.com/en/products/index.html>

7

NOTE

- Depending on the type of the USB memory device or other device connected, the connected device may not function properly or the available functions may be limited.
- It is recommended to use an iPod with firmware updated to the latest version.
- You can charge your iPod by connecting it to the USB input terminal when the ignition switch is in the “ACC” or “ON” position.
- Do not keep your USB memory device or iPod in your vehicle.
- It is recommended that you back up files in case of data damage.

NOTE

- Do not connect to the USB input terminal any device (hard disk, card reader, memory reader, etc.) other than the connectable devices specified in the previous section. The device and/or data may be damaged. If any of these devices was connected by mistake, remove it after turning the ignition switch to the “LOCK” position.

File specifications

You can play music files of the following specifications that are saved in a USB memory device or other device supporting mass storage class. When you connect your iPod, playable file specifications depend on the connected iPod.

Item	Condition
File format	MP3, WMA, AAC, WAV
Maximum number of levels (including the root)	Level 8
Number of folders	700
Number of files	65,535

*“iPod”, “iPod classic”, “iPod nano”, “iPod touch” and “iPhone” are registered trademarks of Apple Inc. in the United States and other countries.

7-78 For pleasant driving

OGKE20E1

Sun visors

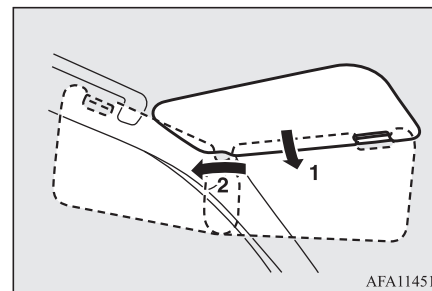

- 1- To eliminate front glare
- 2- To eliminate side glare

Vanity mirror

Type 1

A vanity mirror is fitted to the back of the sun visor.

Operating the lid of the vanity mirror will automatically turn on the mirror lamp (A).

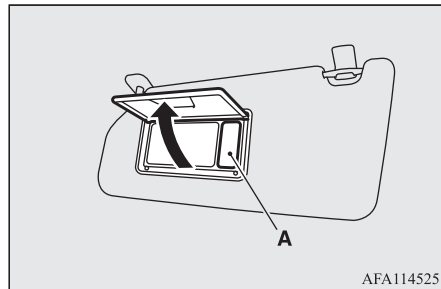

CAUTION

- If the lid of vanity mirror with lamp is kept open for prolonged periods of time, the vehicle's battery will be discharged.

Type 2

A vanity mirror is fitted to the back of the sun visor.

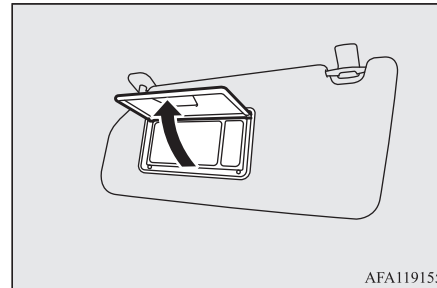

Ticket holder

The holder (B) is located on the back of the sun visor.

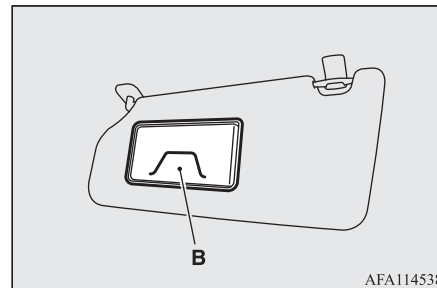

CAUTION

- Do not leave plastic cards in the ticket holder. Because the inside of the vehicle will become hot if the vehicle is parked in strong sunlight, the cards could deform or crack.

Ashtray*

CAUTION

- Put out matches and cigarettes before they are placed in the ashtray.
- Don't put papers and other things that burn into your ashtrays. If you do, cigarettes or other smoking materials could set them on fire, causing damage.
- Always close the ashtray. If left open, other cigarette butts in the ashtray may be rekindled.

7

To use the ashtray, open the lid.

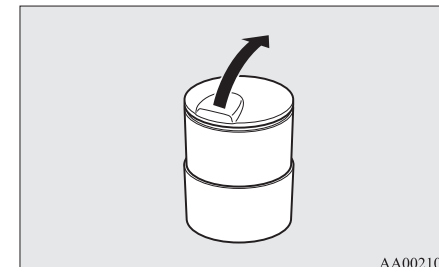

Accessory socket

Mounting position for moveable ashtray

The moveable ashtray can be installed in the drink holder.

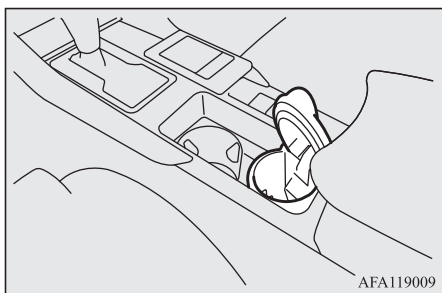

7

Accessory socket

CAUTION

- Be sure to use a “plug-in” type accessory operating at 12 V and at 120 W or less. When using more than one socket at the same time, make sure that the electrical accessories are 12 V accessories and that the total power consumption does not exceed 120 W.
- Long use of the electric appliance without running the engine may run down the battery.

CAUTION

- When the accessory socket is not in use, be sure to close the lid or install the cap, because the socket might become clogged by foreign material and be short-circuited.

To use a plug-in type accessory, open the lid or remove the cap, and insert the plug in the accessory socket.

NOTE

- Accessory sockets in 2 locations can be used at the same time.

The accessory socket can be used while the ignition switch or the operation mode is in ON or ACC.

Centre console

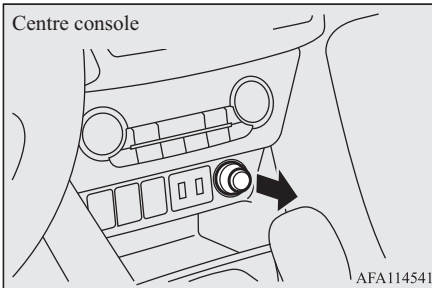

Floor console

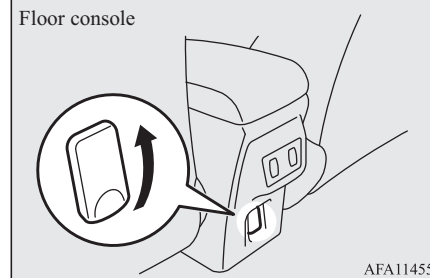

Interior lamps

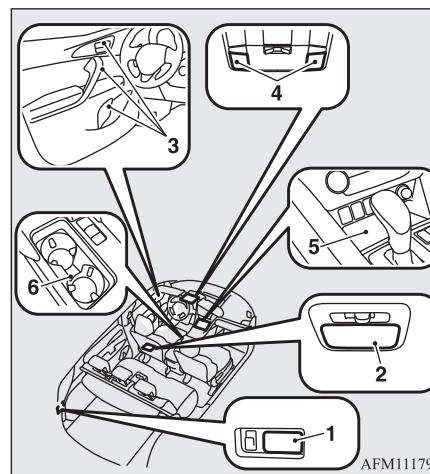

1. Luggage room lamp

2. Room lamp (rear)
3. LED interior illumination (Front door)*
4. Map & room lamps (front)
5. LED interior illumination (Smartphone tray)
6. LED interior illumination (Front drink holder)

NOTE

- If you leave the lamps on without running the engine, you will run down the battery. Before you leave the vehicle, make sure that the lamps are turned off.

Room lamps

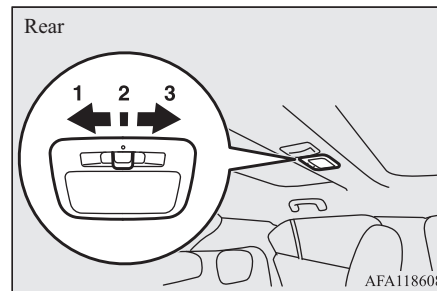
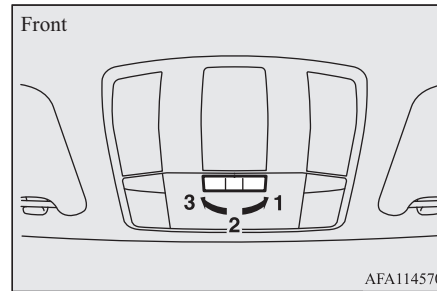

Position of lamp switch	On/off control
1-ON (☞)	The lamp illuminates regardless of whether a door or the tailgate is open or closed.

Position of lamp switch	On/off control
2-DOOR (☞)/(☉)	<p>The lamp illuminates when a door or the tailgate is opened. It goes off approximately 15 seconds after all doors and the tailgate are closed.</p> <p>However, the lamp goes off immediately with all doors and the tailgate closed in the following cases:</p> <ul style="list-style-type: none"> ● When the ignition switch is turned to the “ON” position or the operation mode is put in ON. ● When the central door lock function is used to lock the vehicle. ● When the keyless entry key or the keyless operation key is used to lock the vehicle. ● If the vehicle is equipped with the keyless operation system, when the keyless operation function is used to lock the vehicle.

7

Interior lamps

Position of lamp switch	On/off control
3-OFF (○)	The lamp goes off regardless of whether a door or the tailgate is open or closed.

NOTE

- When the key was used to start the engine, if the key is removed while the doors and tailgate are closed, the lamp is illuminated and after approximately 15 seconds it goes off.
- When the keyless operation function was used to start the engine, if the operation mode is put in OFF while the doors and tailgate are closed, the lamp illuminates and after approximately 15 seconds it goes off. (if so equipped)
- The time until the lamp goes off can be adjusted. For details, please consult a MITSUBISHI MOTORS Authorized Service Point.
On vehicles equipped with the Smartphone Link Display Audio or the MITSUBISHI Multi-Communication System (MMCS), screen operations can be used to make the adjustment. Refer to the separate owner's manual for details.

7

Map lamps

When the lamp switch is in the off position, push the switch (A) to turn on the lamp. Push the switch again to turn off the lamp.

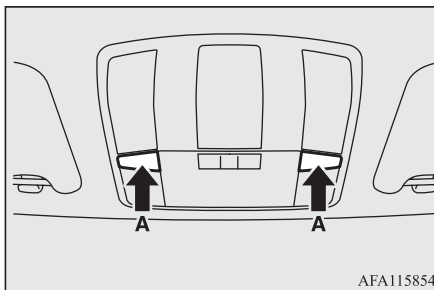

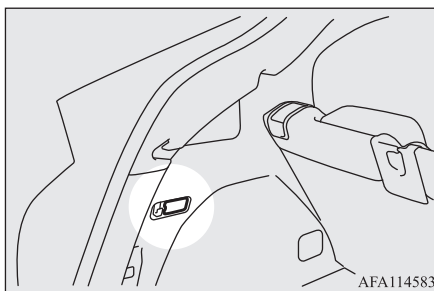

Luggage room lamp

The lamp illuminates when the tailgate is opened, and goes off when the tailgate is closed.



LED interior illumination (Front drink holder)

When the lamps are illuminated with the lamp switch in the “”, “”, or “AUTO” position, the LED interior illumination (Front drink holder) illuminates.



LED interior illumination (Smartphone tray)

When the lamps are illuminated with the lamp switch in the “

A line drawing showing the interior of a car, specifically the area around the center console and glove box. The smartphone tray is highlighted with a glowing effect, indicating it is illuminated. The reference code AFA118611 is located in the bottom right corner of the image.

LED interior illumination (Front door)*

For the inside door handle

When the key is removed from the ignition switch or the operation mode is set from ON to OFF, the LED interior illumination (Front door) illuminates for several seconds.

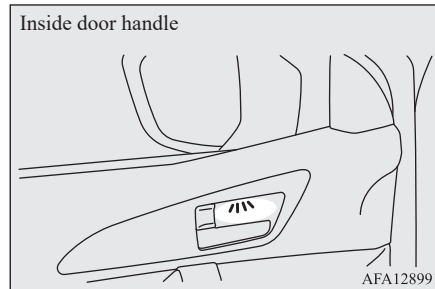

NOTE

- If the driver’s door is opened when the ignition switch is in the “LOCK” or “ACC” position or the operation mode is set to OFF or ACC, the illumination will illuminate.

For the door grip and bottle holder

When the lamps are illuminated with the lamp switch in the “

A line drawing of the interior door panel, focusing on the door grip. The grip is highlighted with a glowing effect, indicating it is illuminated. The reference code AFA129002 is located in the bottom right corner of the image.

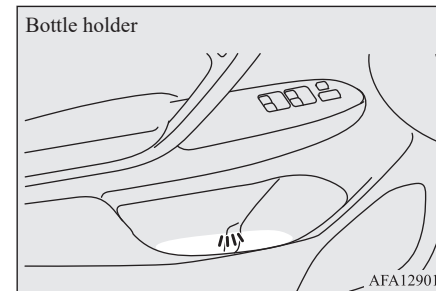

Storage spaces

Interior lamp* auto-cutout function

*: Map & room lamps (front), room lamp (rear), luggage room lamp, and LED interior illumination (Front door) (if so equipped) for the inside door handle

If any of the interior lamps are left switched on with the ignition switch in the "LOCK" position or the operation mode in OFF, it goes off automatically after approximately 30 minutes.

The lamps will illuminate again after they automatically go off if the ignition switch or the engine switch is operated, if one of the doors or the tailgate is opened or closed, or if the keyless entry system or keyless operation system is operated.

NOTE

- The interior lamps auto-cutout function can be deactivated. The time until the lamps automatically go off can be adjusted. For details and support, consult your nearest MITSUBISHI MOTORS Authorized Service Point.

On vehicles equipped with Smartphone Link Display Audio or MITSUBISHI Multi-Communication System (MMCS), screen operations can be used to make the adjustment. Refer to the separate owner's manual for details.

Storage spaces

CAUTION

- Never leave lighters, cans of carbonated drink, and spectacles in the cabin when parking the vehicle in hot sunshine. The cabin will become extremely hot, so lighters and other flammable items may catch fire and unopened drink cans may rupture. Also, spectacles with plastic lenses or materials could deform or crack.
- Keep the lids of storage spaces closed while driving the vehicle. A lid or the contents of a storage space could otherwise cause injuries.

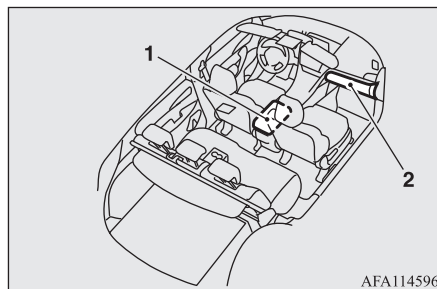

- 1- Floor console box
- 2- Glove box

Glove box

To open, pull the lever (A).

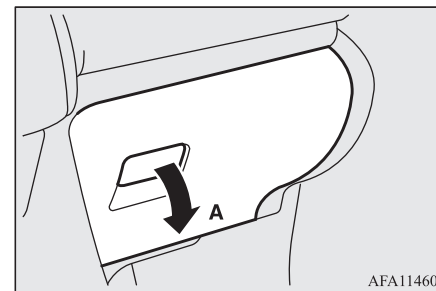

Card holder

There is a card holder inside the glove box.

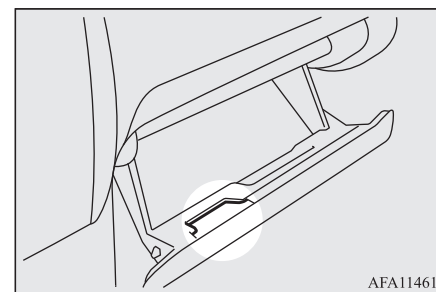

Floor console box

To open the console box, lift the release lever (A) and raise the lid.

The floor console box can also be used as an armrest.

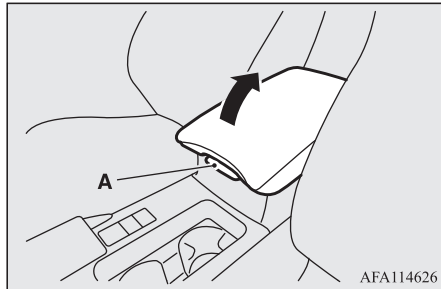

Drink holder

⚠ WARNING

- Do not spray water or spill beverages inside the vehicle. If the switches, wires or electrical components become wet, they could malfunction or cause a vehicle fire. If you accidentally spill a beverage, wipe up as much liquid as possible and immediately consult a MITSUBISHI MOTORS Authorized Service Point.

⚠ CAUTION

- Do not drink beverages while driving. This is distracting and could cause an accident.

For the front seat

The drink holder is located in front of the floor console.

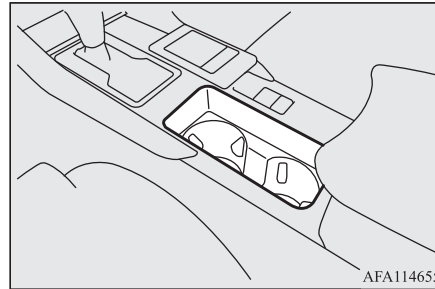

For the rear seat*

In order to use the drink holder, allow the armrest to drop down.

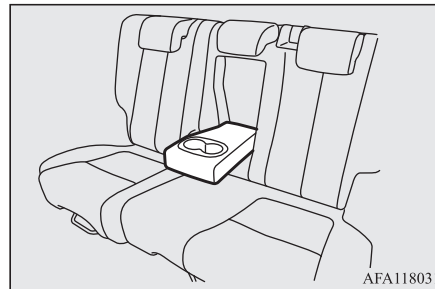

Bottle holder

⚠ WARNING

- Do not spray water or spill beverages inside the vehicle. If the switches, wires or electrical components become wet, they could malfunction or cause a vehicle fire. If you accidentally spill a beverage, wipe up as much liquid as possible and immediately consult a MITSUBISHI MOTORS Authorized Service Point.

7

⚠ CAUTION

- Do not drink beverages while driving. This is distracting and could cause an accident.
- Drinks could be spilled by the vibration and jolts while driving. If the spilt drink is very hot, you could be burnt.

Cargo area cover*

There are bottle holders located on both sides of front and rear doors.

7

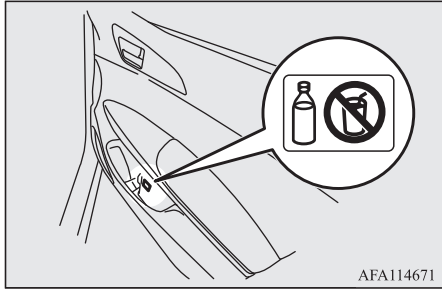

NOTE

- Do not store cup or drink can in the bottle holder.
- Tightly close the cap on drink bottles before storing them.
- Some bottles may be too big or the wrong shape to fit in the holder.

Cargo area cover*

To use

1. Draw out the cover retracted by spring and insert it in the mounting grooves (A).

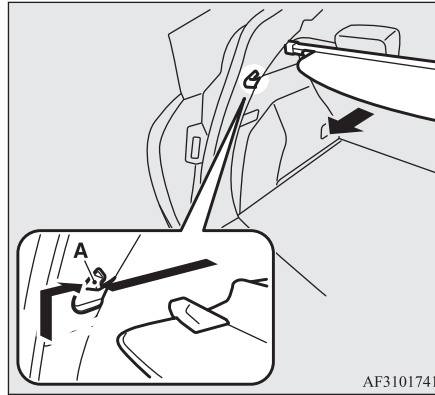

2. Remove the cover from the mounting grooves, and the cover will roll back into the retracted position.

NOTE

- Do not put luggage on the cover.

To change position

There are two installation holes (B) for the cover.

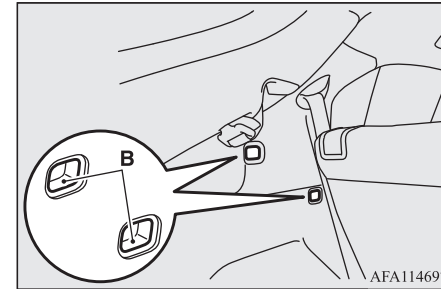

1. Move one of the sliders (C) towards the inside of the vehicle, and fit the tab (D) into the installation hole that is to be used. Move the opposite slider in the same fashion.

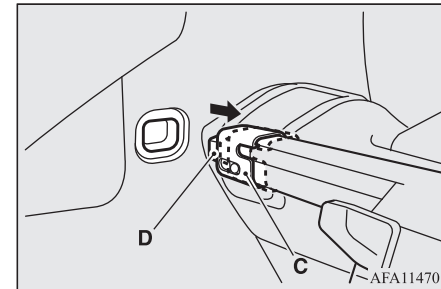

2. After changing the position, gently shake the entire cover to make sure it is securely retained.

NOTE

- If the rear seatback touches the cover, move the cover rearward. The cover could break if it supports the seatback of the rear seat.

To remove

1. Roll the cover into the retracted position.
2. Move one of the sliders (C) towards the inside of the vehicle and lift it to remove the cover.

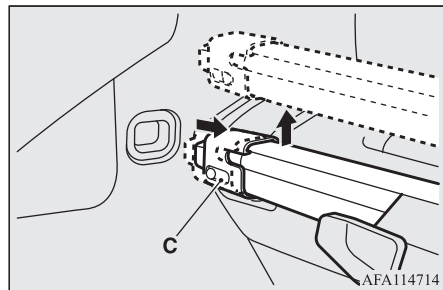

To refit

Refit the cover by performing the removal steps in reverse. Gently shake the entire cover after fitting it to make sure it is securely retained.

To store

The cover can be fitted at the indicated position when not in use. The cover can be stored above the luggage floor board.

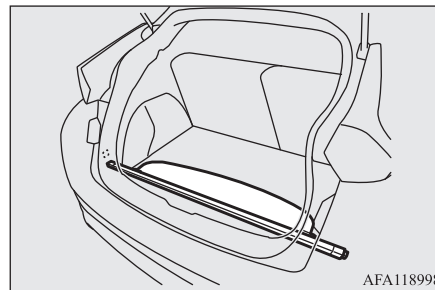

NOTE

- Except for vehicles equipped with a spare tyre, the cover can be stored under the luggage floor board.

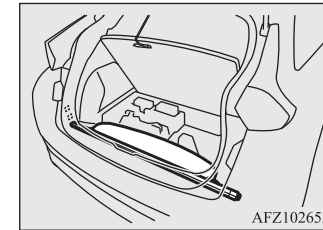

7

Assist grips

The assist grips (located above the doors on the headliner) are not designed to support body weight. They are intended for use only while seated in the vehicle.

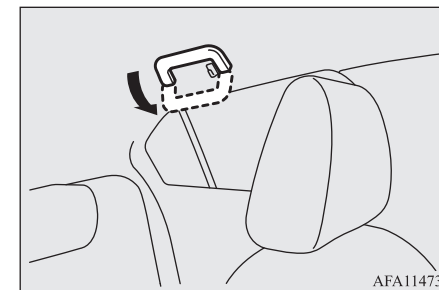

Coat hook

⚠ CAUTION

- Do not use the assist grips when getting into or out of the vehicle. The assist grips could detach causing you to fall.

Coat hook

There is a coat hook on the rear seat assist grip of the driver's side.

7

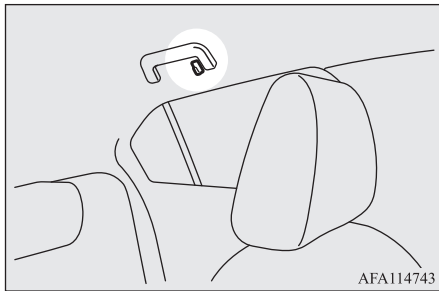

⚠ WARNING

- Do not put a hanger or any heavy or pointed object on the coat hook. If the curtain airbag was activated, any such item could be propelled away with great force and could prevent the curtain airbag from inflating correctly. Hang clothes directly on the coat hook (without using a hanger). Make sure there are no heavy or sharp objects in the pockets of clothes that you hang on the coat hook.

Luggage hooks

There are 4 hooks located on the side walls of the luggage compartment. Use the hooks for securing the luggage.

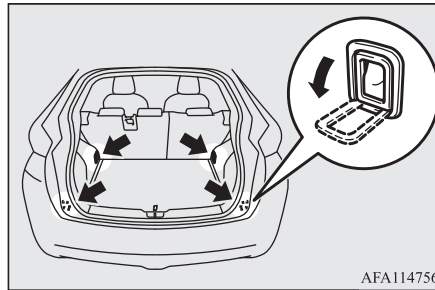

⚠ CAUTION

- Do not pile up the luggage beyond the seat-back height. Also, firmly secure the luggage. Otherwise, serious accidents could result due to hindered rearward view or flying objects during sudden braking.

Convenient hook

Light items of luggage can be hung from the hook.

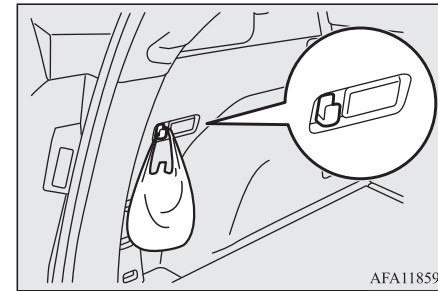

📖 NOTE

- Do not hang heavy luggage (more than approximately 3 kg) on the hook. Doing so could cause damage to the hook.

Luggage floor board

1. Hold the tab (A) and lift the luggage floor board.

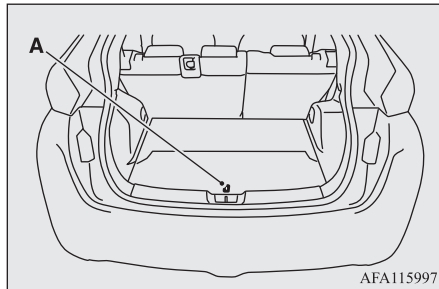

2. Hook the strap (B) of the luggage floor board onto the top of the vehicle as shown to secure the luggage floor board.

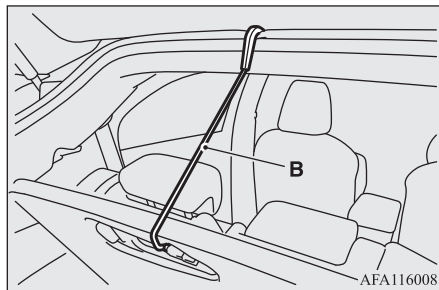

7

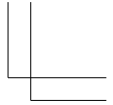
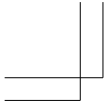

Handwriting practice lines consisting of 12 horizontal dashed lines.

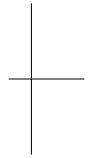
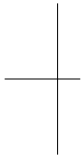

OGKE20E1

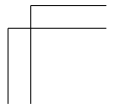
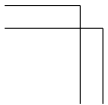

For emergencies

ERA-GLONASS*.....	8-02
If the vehicle breaks down.....	8-08
If the operation mode cannot be changed to OFF (vehicles equipped with the keyless operation system).....	8-08
Emergency starting.....	8-08
Engine overheating.....	8-10
Tools and jack*.....	8-11
Tyre repair kit*.....	8-13
How to change a tyre.....	8-19
Towing.....	8-26
Operation under adverse driving conditions.....	8-30

ERA-GLONASS*

ERA-GLONASS*

ERA-GLONASS is a system designed to reduce the severity of accidents. The location and vehicle information is transmitted from the system to the emergency call centre in case of an accident or sudden illness, and the emergency call centre arranges for despatch of emergency vehicles as required.

WARNING

8

- In the country or area where there is no available emergency call centre of the ERA-GLONASS, or where the radio wave of the emergency call cannot be transmitted or received normally, the system does not operate. In this case, directly arrange an emergency vehicle or road service with a cellular phone, etc.
- If an emergency occurs and you notice a fuel smell or bad smell, do not stay inside the vehicle and escape to a safe place immediately.
- While waiting for the rescue after the emergency call, take action to prevent secondary accidents such as a rear end collision with the following vehicle, and escape to a safe place.
- In the following cases, directly arrange an emergency vehicle or road service with a cellular phone, etc.
 - When the system does not operate by failing because of collision, etc.

WARNING

- When the vehicle is in a place where radio waves cannot be transmitted and received. (for example, indoor, a basement parking area, mountainous area, inside a tunnel, etc.)
- When the line to the emergency call centre is occupied and the call cannot be connected to the emergency call centre.

NOTE

- This system reports to the emergency call centre, but does not directly arrange an emergency vehicle or pass to the road service.
- This system helps to make an emergency call for a traffic accident or sudden illness, but does not have a function to protect the occupants.

Flow of the emergency call

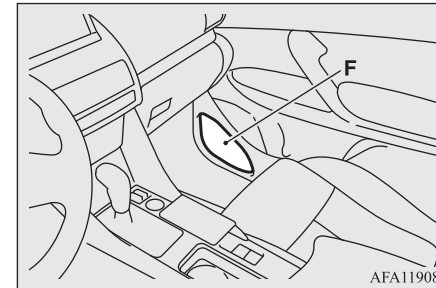
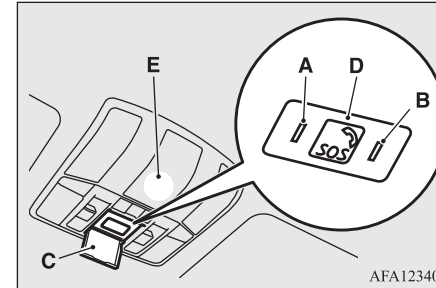

- A- Red lamp
- B- Green lamp
- C- Cover
- D- SOS switch
- E- Microphone
- F- Door speaker (only front passenger side)

⚠ WARNING

- Do not remove or install the above parts. This can cause failure of contact or equipment, and the system may not operate normally.

1. After setting the ignition switch or the operation mode to “ON”, the red lamp (A) and the green lamp (B) illuminate for approximately 10 seconds. When approximately 10 seconds have elapsed after the lamps extinguish, the system is in the standby state.

⚠ WARNING

- If the red lamp and/or the green lamp do not illuminate after setting the ignition switch or the operation mode to “ON”, there is a possible failure in the system. Have the system inspected by a MITSUBISHI MOTORS Authorized Service Point immediately.
- If the red lamp remains illuminated or illuminates again after approximately 20 seconds has elapsed after setting the ignition switch or the operation mode to “ON”, there is a possible failure in the system or the battery for exclusive use of the ERA-GLONASS may be exhausted. The battery life is approximately 3 years. Have the system inspected or the battery replaced by a MITSUBISHI MOTORS Authorized Service Point immediately.

⚠ WARNING

- When the system is not in the standby state, the system does not operate. When you drive, make sure to check that the system is in the standby state.

2. The system operates as follows.
[Automatic Report]
When the vehicle receives an impact above a certain level.

📖 NOTE

- Depending on the level of impact or the angle of the collision, the system may not operate.

[Manual Report]

When you open the cover (C) and press the SOS switch (D).

⚠ WARNING

- Before pressing the SOS switch, stop the vehicle in a safe place. If you operate it while driving, your attention to the surrounding circumstances becomes insufficient, enough to cause an unexpected accident.

⚠ CAUTION

- Do not open the cover except when you press the SOS switch. You may press the SOS switch by mistake. In addition, if the cover is opened while driving, the cover can cause injury in case of an emergency.

📖 NOTE

- Before the manual report gets connected, it can be cancelled by long pressing the SOS button again for more than 2 seconds.
- Do not press the SOS switch except in case an emergency such as an accident or sudden illness. When an emergency vehicle, etc. is despatched for mischief, the applicable cost may be charged.

3. The green lamp blinks and the system calls the emergency call centre.

⚠ WARNING

- If the red lamp illuminates as follows, directly arrange an emergency vehicle or road service with a cellular phone, etc.
 - When the red lamp remains illuminated. (There is a possible failure in the system.)
 - When the red lamp illuminates for 60 seconds. (The vehicle may be in a place where radio waves cannot be transmitted and received.)

ERA-GLONASS*

- The green lamp blinks slowly, and the location and vehicle information is transmitted to the emergency call centre.
- When the green lamp changes from a blinking state to an illumination state and the buzzer sounds once, a conversation with an operator of the emergency call centre is available.

WARNING

- **Do not replace the speakers. If they are replaced, the buzzer sound or the voice of the operator at the emergency call centre may not be audible. If the speakers need to be replaced due to a failure etc., we recommend you to consult a MITSUBISHI MOTORS Authorized Service Point.**

8

WARNING

- **An error may occur between the actual report point and the point reported to the emergency call centre. Mutually confirm the report point and the object through the phone call with the operator of the emergency call centre.**

NOTE

- If the vehicle side microphone (E) and/or the speakers fail, you cannot talk with the operator of the emergency call centre.
- A call cannot be disconnected from the vehicle side.

- The emergency call centre arranges for despatch of the emergency vehicle as required.

Indicator list

Situation	Indication lamp		Cause	Solution	Buzzer sound
	Red lamp	Green lamp			
When setting the ignition switch or the operation mode to "ON"	Illuminates (for approximately 10 seconds)	Illuminates (for approximately 10 seconds)	The system check is in progress.	Wait for a while. The indication lamps extinguish when the system check is complete. If the red lamp and/or the green lamp do(es) not illuminate, there is a possible failure in the system. In this case, immediately have the system inspected at a MITSUBISHI MOTORS Authorized Service Point.	No sound
After approximately 20 seconds after setting the ignition switch or the operation mode to "ON"	Extinguishes	Extinguishes	The system works normally.	–	No sound
	Illuminates	Extinguishes	There is a possible failure in the system or the battery may be exhausted.	Immediately have the system inspected at a MITSUBISHI MOTORS Authorized Service Point.	3 times
While the emergency call is activated	Extinguishes	Blinks (at a 0.5-second interval)	The system calls the emergency call centre.	–	No sound
	Extinguishes	Blinks (at a 2-second interval)	The system transmits the location and vehicle information to the emergency call centre.	–	No sound

ERA-GLONASS*

Situation	Indication lamp		Cause	Solution	Buzzer sound
	Red lamp	Green lamp			
	Extinguishes	Illuminates	A conversation with an operator of the emergency call centre is available.	Mutually confirm the details of the emergency call with the operator of the emergency call centre. If the green lamp does not extinguish even after the emergency call ends, have the system inspected at a MITSUBISHI MOTORS Authorized Service Point.	Once
When the emergency call failed	Illuminates (for approximately 60 seconds)	Extinguishes	The emergency call failed.	Make an emergency call again, or directly arrange an emergency vehicle or road service with the nearest public telephone, etc.	3 times

8

Test mode

You can check if the system is in the normal standby state by the following process. Before operation, stop the vehicle in a safe place, with good visibility, where radio waves can be transmitted and received.

NOTE

- The test emergency call must be carried out by qualified personnel only. Therefore, if you want to check the system, please consult a MITSUBISHI MOTORS Authorized Service Point.

Change to Test Mode

- When the ignition switch or the operation mode is set to "OFF", set the ignition switch or the operation mode to "ON" while pressing the SOS switch.

- After setting the ignition switch or the operation mode to "ON", perform Steps 3 and 4 within 10 seconds.
- Release your finger from the SOS switch.
- Press the SOS switch 3 or more times.
- After approximately 10 seconds from Step 2, the red lamp and the green lamp extinguish. After that, the buzzer sounds 3 times.

NOTE

- If the buzzer does not sound, repeat the process from Step 1.

6. Approximately 60 seconds later, the green lamp blinks. If you press the SOS switch within 20 seconds, the mode changes to the test mode.

NOTE

- When the red lamp blinks instead of the green lamp, move the vehicle in a safe place, with good visibility, where radio waves can be transmitted and received, then repeat the process from Step 1.

7. Within approximately 20 seconds after the mode has changed to the test mode, press the SOS switch for one of the following periods to select the desired test type.
 - 10 seconds or more: Report test to the emergency call centre
 - Less than 10 seconds: Test of the ERA-GLONASS system equipment of the vehicle

NOTE

- If you do not press the SOS switch within approximately 20 seconds, the test mode ends.

NOTE

- If you drive a certain distance in the test mode, the test mode ends.

Report test to the emergency call centre

1. The green lamp illuminates, and the report test to the emergency call centre is started.

NOTE

- If the red lamp illuminates for approximately 60 seconds, the vehicle is in a place where radio waves cannot be transmitted and received. Therefore you cannot report to the emergency call centre.

2. When the green lamp extinguishes, the test mode is completed.

Test of the ERA-GLONASS system equipment of the vehicle

1. After the buzzer sounds once, press the SOS switch.

[Lamp Check]
When the buzzer sounds once and both the red and green lamp illuminate alternately, they are working normally.

2. When the lamps are normal, press the SOS switch. When the lamps do not illuminate normally, wait for approximately 20 seconds.

[Speaker Check]

When the buzzer sounds twice and continues sounding, they are working normally.

3. When the speakers are normal, press the SOS switch. When the buzzer does not sound normally, wait for approximately 20 seconds.

[Microphone Check]

After the buzzer sounds 3 times, say something towards the microphone.

If your voice sounds from the speakers, they are working normally.

4. When the microphone is normal, press the SOS switch. When it does not operate normally, wait for approximately 20 seconds.
5. If all check results are normal, the green lamp illuminates (for approximately 5 seconds) and the buzzer sounds once.

8**WARNING**

- If any of the check results are not normal, the red lamp illuminates (for approximately 5 seconds) and the buzzer sounds 3 times. In this case, there is a possible failure in the system. Have the system inspected by a MITSUBISHI MOTORS Authorized Service Point immediately.

For emergencies 8-07

If the vehicle breaks down

6. When the green lamp extinguishes, the test mode is completed.

If the vehicle breaks down

If the vehicle breaks down on the road, move it to the shoulder and use the hazard warning flashers and/or the warning triangle etc.

Refer to “Hazard warning flasher switch” on page 5-65.

If the engine stops/fails

8

Vehicle operation and control are affected if the engine stops. Before moving the vehicle to a safe area, be aware of the following:

- The brake booster becomes inoperative and the pedal effort will increase. Press down the brake pedal harder than usual.
- Since the power steering system is no longer operative, the steering wheel feels heavy when turning it.

If the operation mode cannot be changed to OFF (vehicles equipped with the keyless operation system)

If the operation mode cannot be changed to OFF, perform the following procedure.

8-08 For emergencies

1. Move the selector lever to the “P” (PARK) position, and then change the operation mode to OFF. (For vehicles with A/T or CVT)
2. One of the other causes could be low battery voltage. If this occurs, the keyless entry system, keyless operation function and steering lock will also not operate.
Contact a MITSUBISHI MOTORS Authorized Service Point.

Emergency starting

If the engine cannot be started because the battery is weak or dead, the battery from another vehicle can be used with jumper cables to start the engine.

⚠ WARNING

- To start the engine using jumper cables connected to another vehicle, perform the correct procedures according to the instruction below. Incorrect procedures could result in a fire or explosion or damage to the vehicles.
- Keep sparks, cigarettes and flames away from the battery because the battery may produce an explosion.

⚠ CAUTION

- Do not attempt to start the engine by pulling or pushing the vehicle. It could damage your vehicle.
- Check the other vehicle. It must have a 12-volt battery. If the other system isn't 12-volt, shorting can damage both vehicles.
- Use the proper cables suitable for the battery size to prevent overheating of the cables.
- Check the jumper cables for damage and corrosion before use.
- Always wear protective eye goggles when working near the battery.
- Keep the battery out of the reach of children.

1. Get the vehicles close enough so the jumper cables can reach, but be sure the vehicles aren't touching each other.
2. Turn off all lamps, heater and other electrical loads.
3. Set the parking brake firmly on each vehicle. Put an A/T or CVT in “P” (PARK) or the M/T in “N” (Neutral). Stop the engine.

⚠ WARNING

- Turn off the ignition on both vehicles beforehand. Make sure that the cables or your clothes cannot be caught by the fan or drive belt. Personal injury could result.

4. Make sure battery electrolyte is at the proper level.
Refer to "Battery" on page 10-09.

⚠ WARNING

- If electrolyte fluid is not visible, or appears to be frozen, **Do Not Attempt Jump Starting!**
A battery might rupture or explode if the temperature is below the freezing point or if it is not filled to the proper level.
- Electrolyte is corrosive diluted sulphuric acid.
If electrolyte (battery acid) comes into contact with your hands, eyes, clothes and the painted surface of your vehicle, it should be thoroughly flushed with water.
If electrolyte gets in your eyes, flush them with water immediately and thoroughly, and get prompt medical attention.

5. Connect one end of one jumper cable ① to the positive (+) terminal of the discharged battery (A), and the other end ② to the positive (+) terminal of the booster battery (B).
Connect one end of the other jumper cable ③ to the negative (-) terminal of the booster battery, and the other end ④ to the designated ground location of the ve-

hicle with the discharged battery at the point farthest from the battery.

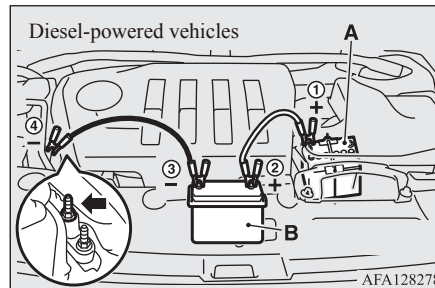
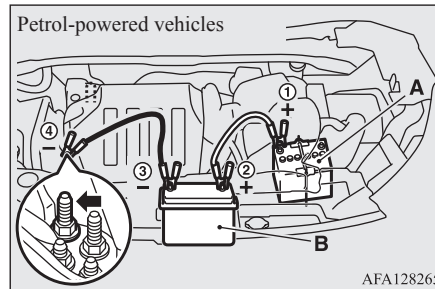

⚠ WARNING

- Make sure that the connection ④ is made to the appointed position (shown in the illustration). If the connection is made directly to the negative (-) side of the battery, the inflammable gases generated from the battery might catch fire and explode.
- When connecting the jumper cables, do not connect the positive (+) cable to the negative (-) terminal. Otherwise sparks might cause explosion of the battery.

⚠ CAUTION

- Take care not to get the jumper cable caught in the cooling fan or other rotating part in the engine compartment.

6. Start the engine in the vehicle which has the booster battery, let the engine idle a few minutes, then start the engine in the vehicle with the discharged battery.

⚠ CAUTION

- Keep the engine of the vehicle giving assistance running.

Engine overheating

NOTE

- If your vehicle is equipped with the Auto Stop & Go (AS&G) system, press the “Auto Stop & Go (AS&G) OFF” switch to deactivate the Auto Stop & Go (AS&G) system and prevent the engine from automatically stopping before the battery is sufficiently charged. Refer to “To deactivate” on page 6-35.

7. After the engine is started, disconnect the cables in the reverse order and keep the engine running for several minutes.

8

NOTE

- If the vehicle is put in motion without fully charging the battery, it might cause the loss of the smooth engine operation and the anti-lock brake warning lamp to illuminate. Refer to “Anti-lock brake system (ABS)” on page 6-63.

Engine overheating

When the engine is overheating, the information screen in the multi-information display will be interrupted and the engine coolant temperature warning display will appear. Also “” will blink. If this occurs, take the following corrective measures:

1. Stop the vehicle in a safe place.

8-10 For emergencies

2. Check whether steam is coming from the engine compartment.

[If steam does not come from the engine compartment]

With the engine still running, raise the bonnet to ventilate the engine compartment.

NOTE

- If your vehicle is equipped with the Auto Stop & Go (AS&G) system, press the “Auto Stop & Go (AS&G) OFF” switch to deactivate the Auto Stop & Go (AS&G) system before stopping the vehicle. Refer to “To deactivate” on page 6-35.

[If steam is coming from the engine compartment]

Stop the engine, and when the steam stops, raise the bonnet to ventilate the engine compartment. Restart the engine.

WARNING

- Do not open the bonnet while steam is coming from the engine compartment. It could cause steam or hot water to spurt out, causing burns. Hot water could spurt out even when there is no steam coming out, and some parts will be very hot. Be very careful when opening the bonnet.

WARNING

- Be careful of hot steam, which could be blowing off the reserve tank cap.
- Do not attempt to remove the radiator cap while the engine is hot.

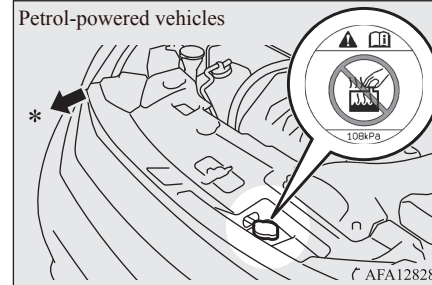

*: Front of the vehicle

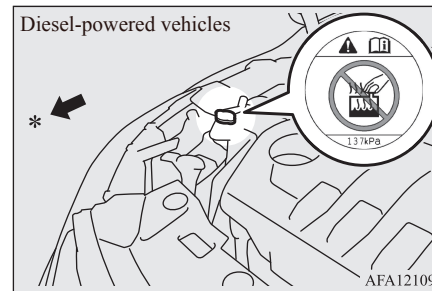

*: Front of the vehicle

- Confirm that the cooling fans (A) are turning.
 [If the cooling fans are turning]
 After the high coolant temperature warning has gone off, stop the engine.
 [If the cooling fans are not turning]
 Stop the engine immediately and contact a MITSUBISHI MOTORS Authorized Service Point for assistance.

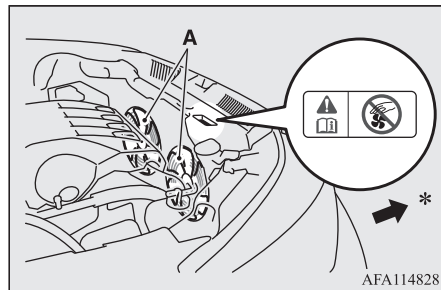

*: Front of the vehicle

WARNING

- Be careful not to get your hands or clothes caught in the cooling fan.

- Check the coolant level in the reserve tank (B).

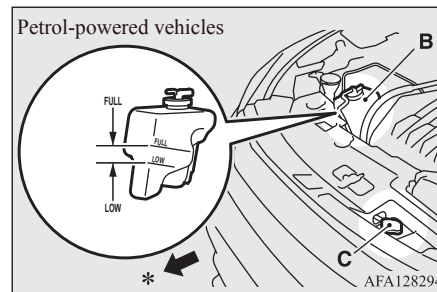

*: Front of the vehicle

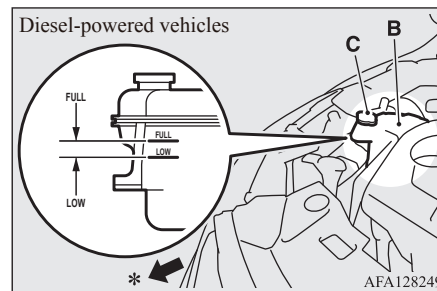

*: Front of the vehicle

- Add coolant to the radiator and/or reserve tank if necessary. (Refer to the "Maintenance" section.)

WARNING

- Make sure that the engine has cooled down before removing the radiator cap (C), because hot steam or boiling water otherwise will gush from the filler port and may scald you.

CAUTION

- Do not add coolant while the engine is hot. Suddenly adding cold coolant could damage the engine. Wait for the engine to cool down, then add coolant a little at a time.

- Examine the radiator hoses for coolant leakage and the drive belt for looseness or damage.
 If there is anything wrong with the cooling system or drive belt, we recommend you to have it checked and repaired.

Tools and jack*

Storage

The tools and jack are stored under the luggage floor board of the luggage compartment.

Tools and jack*

The storage location of the tools and jack should be remembered in case of an emergency.

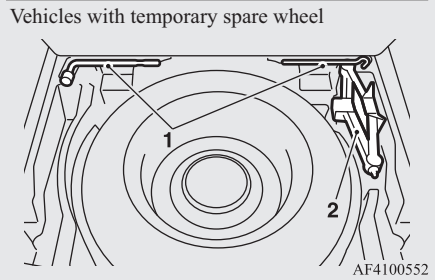
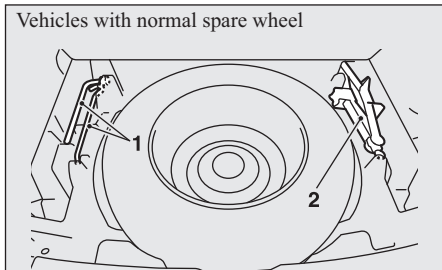

1- Tools

2- Jack

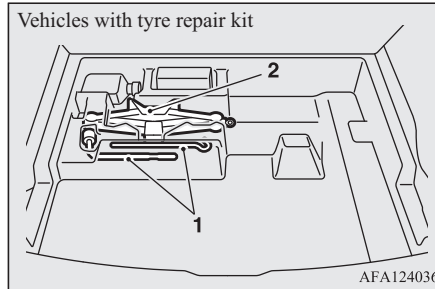

1- Tools
2- Jack

Tools

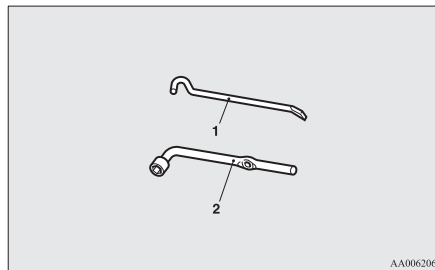

1- Jack bar
2- Wheel nut wrench

Jack

The jack is used only for the purpose of changing a tyre when a tyre is punctured.

NOTE

- The jack is maintenance-free.
- The jack is in conformity with EC law as approximated by the Machinery Directive 2006/42/EC.
- The EC declarations of conformity are attached to the section “Declaration of Conformity” in the end of this owner’s manual.
 - The business name, full address of the manufacturer and of his authorized representative and the designation of the jack are described in the EC declaration of conformity.

To remove

1. Lift up the luggage floor board.
Refer to “Luggage floor board” on page 7-89.

2. Retract the jack and remove it from its installation fitting (A).

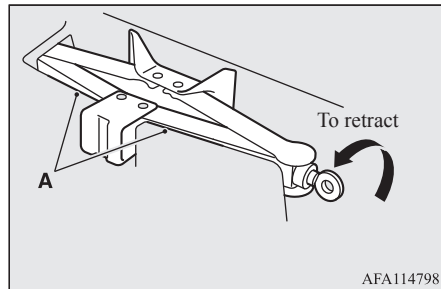

To store

1. Retract the jack, then return it to its original position.
2. Extend the jack and firmly secure it, then lower the luggage floor board.

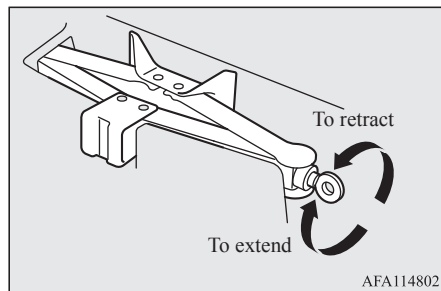

Tyre repair kit*

This kit enables emergency repair of a small puncture in the tread area of a tyre that has run over a nail, screw, or similar object.

Storage

The tyre repair kit is stored under the luggage floor board of the luggage compartment. The storage location of the tyre repair kit should be remembered in case of an emergency. Refer to “Luggage floor board” on page 7-89.

Tyre repair kit*

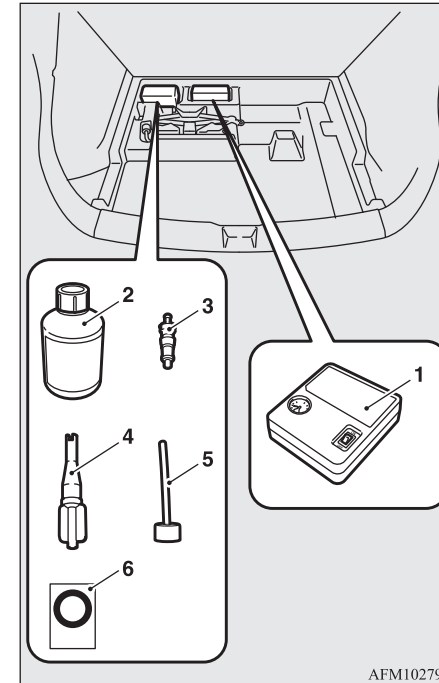

- 1- Tyre compressor
- 2- Tyre sealant bottle
- 3- Valve insert (spare)
- 4- Valve remover
- 5- Filler hose
- 6- Speed restriction sticker

8

Tyre repair kit*

How to use the tyre repair kit

WARNING

- Using the tyre repair kit may damage the wheel and/or the tyre inflation pressure sensor for the tyre. The vehicle must promptly be inspected and repaired by a MITSUBISHI MOTORS Authorized Service Point after using the tyre repair kit.

CAUTION

- The tyre sealant can cause health damage if swallowed. If you accidentally swallow it, drink as much water as possible and immediately consult a doctor.
- If the tyre sealant gets in your eyes or on your skin, rinse with lots of water. If you still sense an abnormality, consult a doctor.
- Consult a doctor immediately if any allergic reactions occur.
- Do not allow children to touch the tyre sealant.
- Do not breathe in the vapours of tyre sealant.
- Be sure to use a MITSUBISHI MOTORS GENUINE tyre sealant.

NOTE

- The tyre sealant cannot be used in any of the situations listed below. If any of these situations occurs, please contact a MITSUBISHI

NOTE

MOTORS Authorized Service Point or another specialist.

- The tyre sealant's expiry date has passed. (The expiry date is shown on the bottle label.)

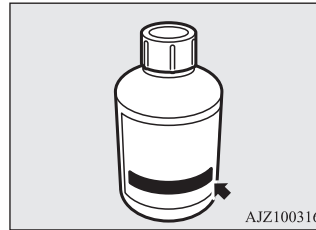

- More than one tyre is punctured.
- The puncture hole has a length or width of 4 mm or more.
- The tyre is punctured in the side wall (A), not in the tread (B).

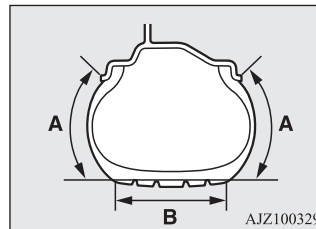

- The vehicle has been driven with the tyre almost completely flat.

NOTE

- The tyre has completely slipped over the wheel rim and has come off the wheel.
- The wheel is damaged.
- Use the tyre sealant only at ambient temperatures of -30 °C to +60 °C.
- Effect an emergency repair without pulling out the object (nail, screw, etc.) that is stuck in the tyre.
- Do not use the tyre sealant if the tyre has been damaged by being driven when insufficiently inflated (e.g. bumps, cuts, cracks etc. on the tyre).
- Wipe tyre sealant off the paintwork immediately with a damp cloth.
- Immediately wash clothes contaminated with tyre sealant.
- Check the tyre sealant's expiry date regularly, be sure to purchase a new one from a MITSUBISHI MOTORS Authorized Service Point before the expiry date.

Before repairing a tyre, first stop your vehicle in a safe, flat location.

1. Park the vehicle on level and stable ground.
2. Set the parking brake firmly.
3. On vehicles with M/T, stop the engine and move the gearshift lever to the "R" (Reverse) position.

On vehicles with A/T or CVT, move the selector lever to the "P" (PARK) position and stop the engine.

Tyre repair kit*

4. Turn on the hazard warning flashers and set up a warning triangle, flashing signal lamp, etc., at an adequate distance from the vehicle, and have all your passengers leave the vehicle.
5. Take out the tyre repair kit.
6. Take the valve cap (C) off the tyre valve (D), then press the valve remover (E) onto the valve as illustrated. Allow all of the air in the tyre to escape.

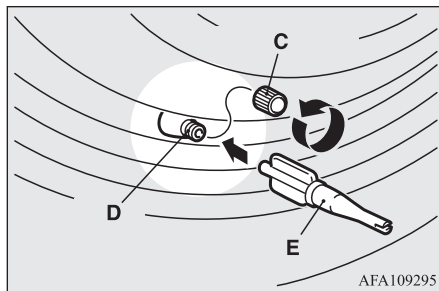

7. Remove the valve insert (F) by turning it anticlockwise using the valve remover (E). Put the removed valve insert in a clean place so it does not get dirty.

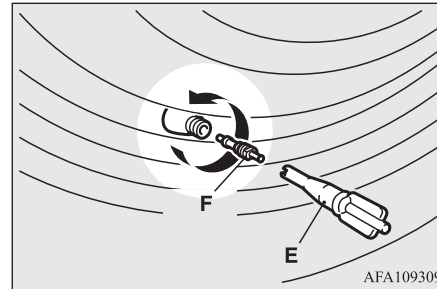

CAUTION

- If there is any air left in the tyre when you remove the valve insert, the valve insert may fly out and injure you. Make sure the tyre contains no air before removing the valve insert.

8. Shake the tyre sealant bottle well.

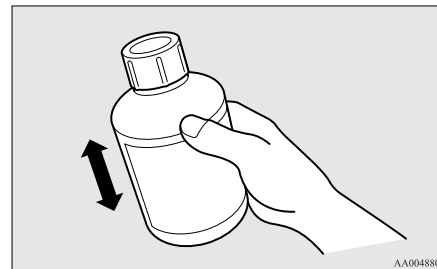

NOTE

- In cold conditions (when the ambient temperature is 0 °C or lower), thickening of the tyre sealant can make the tyre sealant hard to squeeze out of the bottle. Warm the bottle inside the vehicle.

9. Take the cap (G) off the tyre sealant bottle (H). Do not remove the seal (I). Screw the filler hose (J) onto the bottle (H). As you screw the filler hose onto the bottle, the seal will break, allowing the sealant to be used.

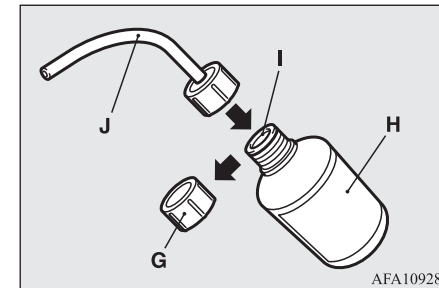

CAUTION

- If you shake the bottle after screwing on the hose, sealant may spray out of the hose.

10. Press the hose onto the valve (D). Holding the sealant bottle upside-down,

For emergencies 8-15

8

Tyre repair kit*

squeeze it again and again to inject all of the sealant into the tyre.

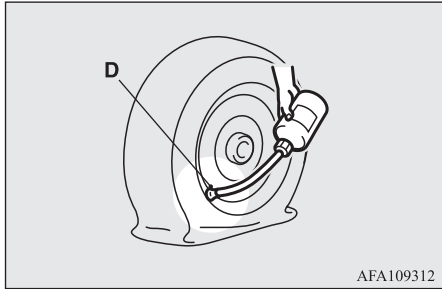

8

NOTE

- When injecting the sealant, position the valve away from the bottom, i.e., away from the point where the tyre touches the ground. If the valve is near the point where the tyre touches the ground, the sealant may not go into the tyre easily.

11. After injecting the sealant, pull the hose off the valve, remove any residual sealant from the valve, rim and/or tyre. Fit the valve insert (F) into the valve (D), and screw the valve insert securely into place using the valve remover (E).

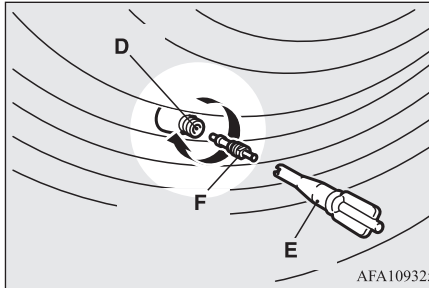

NOTE

- When removing and screwing in the valve insert using the valve remover, turn the valve remover by hand. Using a tool to turn the valve remover could damage it.

12. After injecting the sealant, securely fit the valve remover (E) into the end of the filler hose (J) to prevent sealant from leaking from the empty bottle.

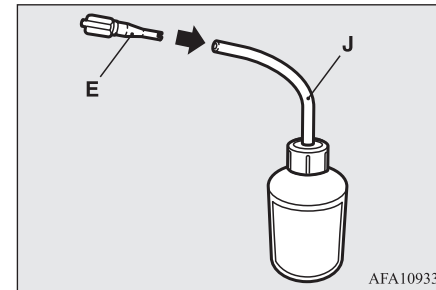

13. Pull out the compressor hose (K) from the side of the tyre compressor, and then securely attach the hose to the tyre valve (D).

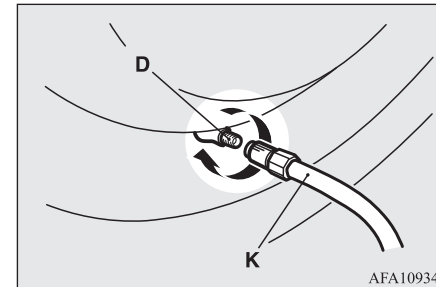

14. Place the compressor (L) with its air pressure gauge (M) on top.

Pull out the compressor's power cord (N), insert the plug on the cord into the accessory socket (O), and then put the operation mode in ACC. (Refer to "Accessory socket" on page 7-80.)

Turn ON the compressor switch (P) and inflate the tyre to the specified pressure.

(Refer to "Tyre inflation pressures" on page 10-13.)

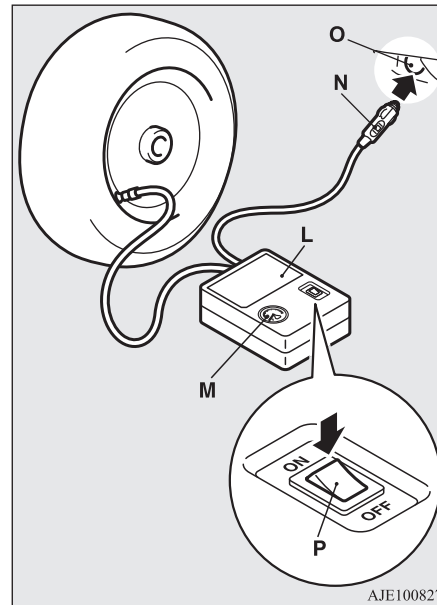

⚠ CAUTION

- The supplied compressor is designed only for inflation of your vehicle tyres.
- The compressor is designed to run on a vehicle's 12 V power supply. Do not connect it to any other power source.

⚠ CAUTION

- The compressor is not waterproof. If you use it in rain, make sure water does not get on it.
- Any sand or dust sucked into the compressor could make the compressor break down. Do not place the compressor directly on any sandy or dusty surface when using it.
- Do not disassemble or modify the compressor. Also, do not subject the air pressure gauge to shock. It could malfunction.

15. Check and adjust the tyre pressure with reference to the air pressure gauge on the compressor. If you overinflate the tyre, release air by loosening the hose's end fitting.

If there is a gap between the tyre and wheel because the tyre has moved inward from the wheel rim, press the periphery of the tyre towards the wheel to close the gap before running the compressor. (With no gaps, the tyre pressure will rise.)

8

⚠ CAUTION

- Be careful not to get your fingers trapped between the tyre and wheel as the tyre inflates.
- The surface of the compressor will get hot while the compressor is running. Do not keep the compressor running continuously for more than 10 minutes. After using the compressor, wait for the compressor to cool before using it again.

Tyre repair kit*

CAUTION

- If the compressor becomes sluggish or hot while operating, it is overheating. Immediately place the switch in the OFF position and let the compressor cool down for at least 30 minutes.

NOTE

- If the tyre pressure does not rise to the specified level within 10 minutes, the tyre may be so severely damaged that the tyre sealant cannot be used to effect an emergency repair. Please contact a MITSUBISHI MOTORS Authorized Service Point or another specialist in this event.

8

16. Turn OFF the compressor switch, then pull the power cord plug out of the socket.

NOTE

- Simply putting sealant and air into the tyre using the tyre repair kit does not seal the puncture hole. Air will leak through the puncture hole until the emergency repair procedure is completed (through step 19 or step 20 of these instructions).

17. Affix the speed restriction sticker (Q) to the three-diamond mark on the steering wheel.

8-18 For emergencies

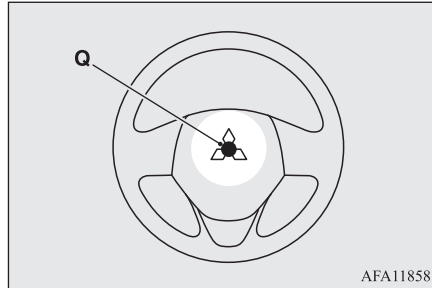

CAUTION

- Do not affix the sticker anywhere except the specified position on the pad of the steering wheel. Affixing the sticker in an incorrect position could prevent the SRS airbag from working normally.

18. When you have inflated the tyre to the specified pressure, stow the compressor, bottle, and other items in the vehicle and promptly start driving the vehicle so that the tyre sealant can spread evenly in the tyre. Drive with great care. Do not exceed a speed of 80 km/h (50 mph). Observe local speed limits.

CAUTION

- If you sense any abnormality while driving, stop the vehicle and contact a MITSUBISHI MOTORS Authorized Service Point or another specialist. Otherwise the tyre pressure may drop before the emergency repair procedure is completed, rendering the vehicle unsafe.

NOTE

- Driving faster than 80 km/h (50 mph) can make the vehicle vibrate.

19. After driving for 10 minutes or 5 km (3 miles), check the tyre pressure using the air pressure gauge on the compressor. If the tyre pressure has apparently not dropped, the emergency repair procedure is complete. Continue the process from step 21.

If the tyre pressure is not sufficient, inflate the tyre to the specified pressure again and drive the vehicle carefully without exceeding a speed of 80 km/h (50 mph).

⚠ CAUTION

- If the tyre pressure is lower than the minimum permitted pressure (1.3 bar {130 kPa}), the tyre cannot successfully be repaired with the tyre sealant. Do not drive the vehicle any further. Contact a MITSUBISHI MOTORS Authorized Service Point or another specialist.

20. After driving for 10 minutes or 5 km (3 miles), check the tyre pressure using the air pressure gauge on the compressor. If the tyre pressure has apparently not dropped, the emergency repair procedure is complete. You must still not exceed a speed of 80 km/h (50 mph). Observe local speed limits.

📖 NOTE

- If the tyre pressure has dropped below the specified level when you check it at the end of the repair procedure, do not drive the vehicle any further. Contact a MITSUBISHI MOTORS Authorized Service Point or another specialist.

📖 NOTE

- In cold conditions (when the ambient temperature is 0 °C or lower), the time and driving distance necessary until completion of the repair can be longer than in warmer conditions, meaning that the tyre pressure can drop below the specified level even when you have inflated the tyre a second time and subsequently driven the vehicle. If this happens, inflate the tyre to the specified pressure once more, drive for approximately 10 minutes or 5 km (3 miles), then check the tyre pressure again. If the tyre pressure has again dropped below the specified level, stop driving the vehicle and contact a MITSUBISHI MOTORS Authorized Service Point or another specialist.

21. Immediately drive with great care to a MITSUBISHI MOTORS Authorized Service Point and have tyre repair/replacement performed.

⚠ CAUTION

- Be sure to check the tyre pressure for confirmation that the emergency repair procedure is complete.

📖 NOTE

- Please give the empty sealant bottle to your MITSUBISHI MOTORS Authorized Service Point when you purchase new sealant or dispose of the sealant bottle according to national regulations for the disposal of chemical waste.
- A tyre in which puncture sealant has been used should ideally be replaced with a new one. If you wish to have such a tyre properly repaired for reuse, please contact a MITSUBISHI MOTORS Authorized Service Point or another specialist. Note that a proper repair is impossible following an emergency repair if the puncture hole cannot be located.
- The manufacturer is unable to guarantee that all tyre punctures can be repaired with the tyre repair kit, in particular cuts or perforations with a diameter of more than 4 mm or away from the tyre's tread. The manufacturer is not liable for damage sustained through improper use of the tyre repair kit.
- The manufacturer is not liable for damage sustained through re-use of any tyre in which tyre sealant has been used.

How to change a tyre

Before changing a tyre, first stop your vehicle in a safe, flat location.

1. Park the vehicle on level and stable ground, free of loose pebbles, etc.
2. Set the parking brake firmly.

How to change a tyre

- On vehicles with M/T, stop the engine and move the gearshift lever to the “R” (Reverse) position.
On vehicles with A/T or CVT, move the selector lever to the “P” (PARK) position and stop the engine.
- Turn on the hazard warning flashers and set up a warning triangle, flashing signal lamp, etc., at an adequate distance from the vehicle, and have all your passengers leave the vehicle.
- To prevent the vehicle from rolling when jacking up the vehicle, place chocks or blocks (A) at the tyre that is diagonally opposite from the tyre (B) you are changing.

8

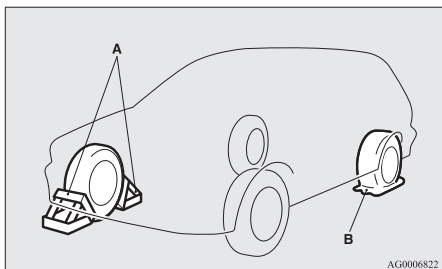

⚠ WARNING

- Be sure to apply chocks or blocks to the correct tyre when jacking up the vehicle. If the vehicle moves while jacked up, the jack could slip out of position, leading to an accident.

📖 NOTE

- The chocks shown in the illustration do not come with your vehicle. It is recommended that you keep one in the vehicle for use if needed.
- If chocks are not available, use stones or any other objects that are large enough to hold the wheel in position.

- Get the jack bar and wheel nut wrench ready.
Refer to “Tools and jack” on page 8-11.

Spare wheel information*

The spare wheel is stored under the luggage floor board of the luggage compartment. Check the air pressure of the spare tyre frequently and make sure it is ready for emergency use at any time.

Maintaining the spare wheel at the highest specified air pressure will ensure that it can always be used under any conditions (city/high-speed driving, varying load weight, etc.).

⚠ CAUTION

- The pressure should be periodically checked and maintained at the specified pressure while the tyre is stowed.
Driving with an insufficient tyre pressure can lead to an accident. If you have no choice but to drive with an insufficient tyre pressure, keep your speed down and inflate the tyre to the correct pressure as soon as possible. (Refer to “Tyre inflation pressures” on page 10-13.)

Temporary spare wheel*

⚠ CAUTION

- The temporary spare wheel is for temporary use only and should be removed as soon as the original wheel can be repaired or replaced. (The temporary spare wheel is being used, the tyre pressure monitoring system will not function properly.)
- The vehicle must not be driven at speeds in excess of 80 km/h (50 mph) while using the temporary spare wheel.
- The temporary spare wheel is not as good as a standard wheel in controllability and stability.
When the temporary spare wheel is used, avoid quick starts, sudden braking and sharp steering.
- The temporary spare wheel is specifically designed for your vehicle and it should not be used on any other vehicle.

CAUTION

- When you purchase the temporary spare wheel, be sure to purchase the type designed specially for your vehicle from your MITSUBISHI MOTORS Authorized Service Point.
- Do not use snow traction device (tyre chains) with your temporary spare wheel. Because of the smaller tyre size, a snow traction device (tyre chains) will not fit properly. This could cause damage to the wheel and result in loss of the snow traction device (tyre chains).

If a front tyre becomes flat when using snow traction device (tyre chains), first replace a rear wheel with the temporary spare wheel and then use the removed rear wheel to replace the flat front wheel so that you can continue to use the snow traction device (tyre chains).

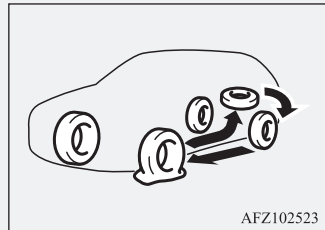

CAUTION

- Upon installation of the temporary spare wheel, the ground clearance is reduced as the tyre is smaller in diameter than the standard tyre. When passing over the projections on the road, take care not to damage the vehicle's undercarriage.
- Do not install more than one temporary spare wheel at the same time.

To remove the spare wheel

1. Lift up the luggage floor board. Refer to "Luggage floor board" on page 7-89.
2. To remove the spare wheel, remove the installation clamp (A) by turning it anti-clockwise.

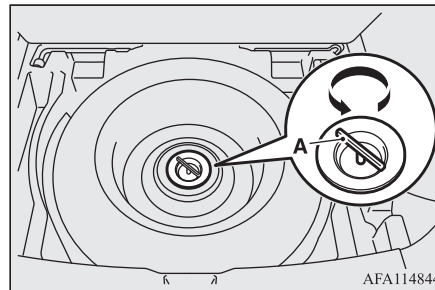

OGKE20E1

NOTE

- Put the spare wheel under the vehicle body near the jack. This makes it safer if the jack slips out of position.

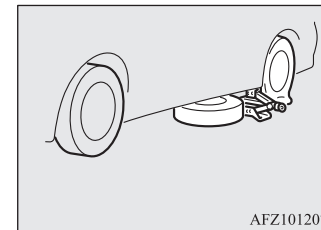

8

To change a tyre

1. On vehicles with wheel covers, first remove the covers (refer to "Wheel covers" on page 8-25). Then loosen the wheel nuts a quarter turn with the wheel nut wrench. Do not remove the wheel nuts yet.

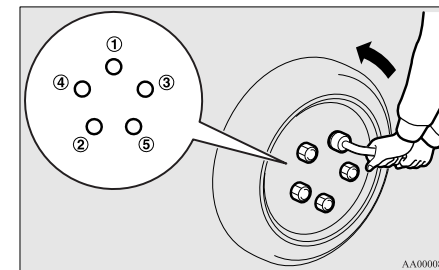

For emergencies 8-21

How to change a tyre

2. Place the jack under one of the jacking points (A) shown in the illustration. Use the jacking point closest to the tyre you wish to change.

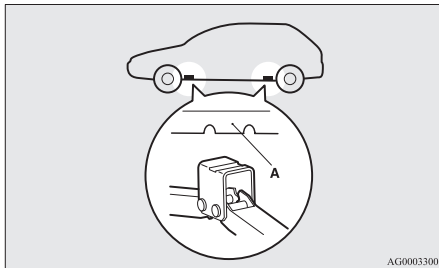

8

⚠ WARNING

- Set the jack only at the positions shown here. If the jack is set at a wrong position, it could dent your vehicle or the jack might fall over and cause personal injury.
- Do not use the jack on a tilted or soft surface. Otherwise, the jack might slip and cause personal injury. Always use the jack on a flat, hard surface. Before setting the jack, make sure there are no sand or pebbles under the jack base.

3. Rotate the jack by hand until the flange portion (B) fits in the groove (C) at the top of the jack.

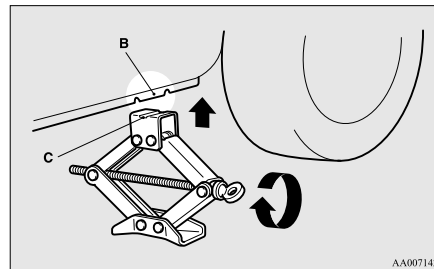

4. Check that the flange portion at the jacking point fits in the groove at the top of the jack.

Insert the jack bar (D) into the wheel nut wrench (E). Then put the end of the jack bar into the shaft's jack end, as shown in the illustration.

Slowly rotate the wheel nut wrench until the tyre is raised slightly off the ground surface.

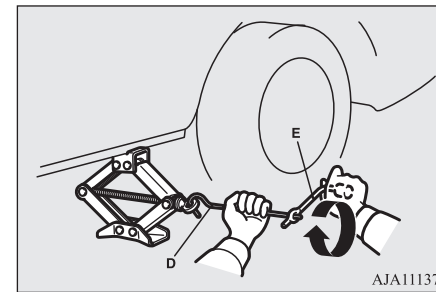

⚠ WARNING

- Stop jacking up the vehicle as soon as the tyre is raised off the ground. It is dangerous to raise the vehicle any higher.
- Do not get under your vehicle while using the jack.
- Do not bump the raised vehicle or leave it sitting on the jack for a long time. Both are very dangerous.
- Do not use a jack except the one that came with your vehicle.
- The jack should not be used for any purpose other than to change a tyre.
- No one should be in your vehicle when using the jack.
- Do not start or run the engine while your vehicle is on the jack.

⚠ WARNING

- Do not turn the raised wheel. The tyres still on the ground could turn and make your vehicle fall off the jack.

5. Remove the wheel nuts with the wheel nut wrench, then take the wheel off.

⚠ CAUTION

- Handle the wheel carefully when changing the tyre, to avoid scratching the wheel surface.

6. Clean out any mud, etc. on the hub surface (F), hub bolts (G) or in the installation holes (H) in the wheel, and then mount the spare tyre.

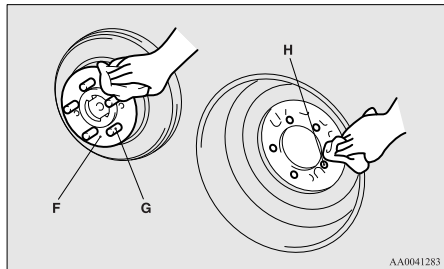

⚠ WARNING

- Mount the spare wheel with the valve stem (I) facing outboard. If you cannot see the valve stem (I), you have installed the wheel backwards. Operating the vehicle with the spare wheel installed backwards can cause vehicle damage and result in an accident.

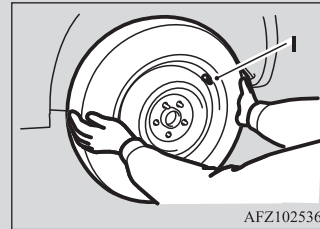

7. Turn the wheel nuts clockwise by hand to initially tighten them.

[Type 1: On vehicles with steel wheels]
Temporarily tighten the wheel nuts by hand until the tapered parts of the wheel nuts make light contact with the seats of the wheel holes and the wheel is not loose.

[Type 2: On vehicles with aluminium wheels]
Temporarily tighten the wheel nuts by hand until the flange parts of the wheel

nuts make light contact with the wheel and the wheel is not loose.

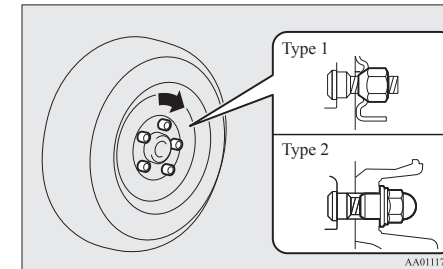

📖 NOTE

- Flange nuts can be temporarily used on the steel spare wheel as shown in the illustration, but return to the original wheel and tyre as soon as possible.

Diagram illustrating the use of a flange nut on a steel spare wheel. Reference code: AJZ101283.

How to change a tyre

CAUTION

- Never apply oil to either the wheel bolts or the nuts, or they will tighten too much.

NOTE

- On vehicles with aluminium wheels, if all 4 aluminium wheels are changed to steel wheels, e. g. when fitting winter tyres, use tapered nuts.

8

8. Lower the vehicle slowly by rotating the wheel nut wrench anticlockwise until the tyre touches the ground.

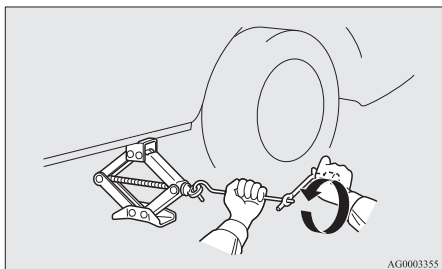

9. Tighten the nuts in the order shown in the illustration until each nut has been tightened to the torque listed here.

Tightening torque 88 to 108 Nm

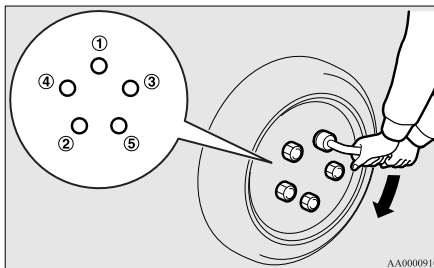

CAUTION

- Never use your foot or a pipe extension for extra force in the wheel nut wrench. If you do so, you will tighten the nut too much.

10. On vehicles with wheel covers, install the covers (refer to “Wheel covers” on page 8-25).
11. Lower and remove the jack, then store the jack, flat tyre, and chocks. Have your damaged tyre repaired as soon as possible.

12. Check your tyre inflation pressure at the next gasstation. The correct tyre pressures are shown on the driver’s door label. See the illustration.

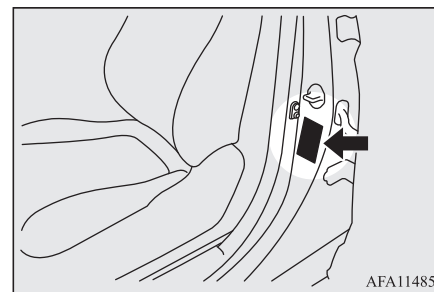

13. If your vehicle is equipped with the tyre pressure monitoring system (TPMS), after filling your tyres to the correct pressure, reset the tyre pressure monitoring system (TPMS). Refer to “Tyre pressure monitoring system (TPMS): Reset of low tyre pressure warning threshold” on page 6-123.

CAUTION

- After changing the tyre and driving the vehicle approximately 1,000 km (620 miles), re-tighten the wheel nuts to make sure that they have not come loose.

CAUTION

- If the steering wheel vibrates when driving after changing the tyre, we recommend you to have the tyres checked for balance.
- Do not mix one type of tyre with another or use a different size from the one listed. This would cause early wear and poor handling.

To store the spare wheel

1. Lift up the luggage floor board. Refer to “Luggage floor board” on page 7-89.
2. Store the spare wheel under the luggage floor board. To store the spare wheel, fit the installation clamp (A) by turning it clockwise.

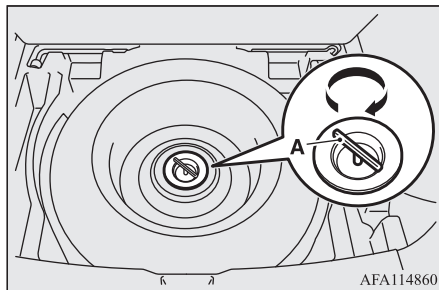

NOTE

- On vehicles with a T155/90D16 or T155/80D17 size spare wheel, the clamp cannot be used for a normal size tyre.
- When storing a normal size flat tyre in the space for the spare wheel under the luggage floor board, the luggage floor board will be positioned higher than usual.

3. Have your damaged tyre repaired as soon as possible.

To store the tools and jack

Reverse the removing procedure when storing the jack, jack bar and wheel nut wrench. Refer to “Tools and jack*” on page 8-11.

Wheel covers*

To remove

Wrap the tip of the jack bar with a cloth, insert it into the notch provided in the wheel cover, and pry the cover away from the wheel. Using the same procedure at the other wheel cover notches, work the wheel cover away from the wheel to remove it completely.

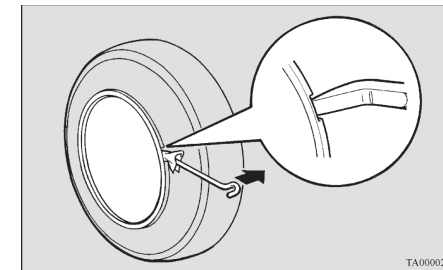

8

CAUTION

- Removing the cover with your hands may cause injury to the fingers.

NOTE

- The wheel cover is made of plastic. Pry it loose carefully.

Towing

To install

1. Make sure the tabs (A) of the back of the wheel cover are not broken and correctly fitted on the rings (B). If in doubt, do not install the wheel cover and consult your MITSUBISHI MOTORS Authorized Service Point.

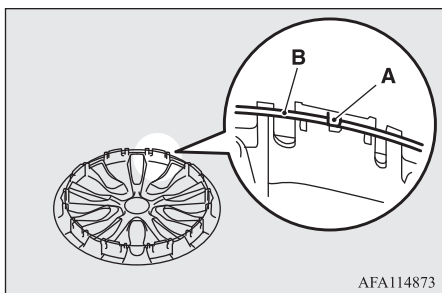

2. Align the air valve (C) of the tyre with the notch (D) in the wheel cover.

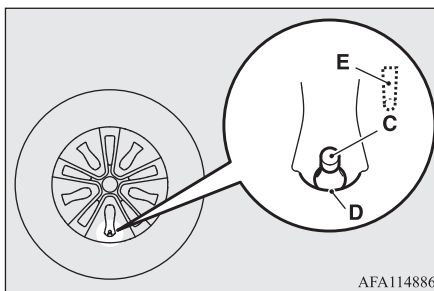

NOTE

- Full wheel covers have a symbol mark (E) provided on the reverse side to show the air valve location. Before installing the wheel cover to the wheel, make sure that the opening with the symbol mark is correctly aligned with the air valve.

3. Push the underside (F) of the wheel cover into the wheel.
4. Gently push both sides (G) of the wheel cover and hold them in place with both knees.

5. Gently tap around the circumference of the wheel cover at the top (H), then push the wheel cover into place.

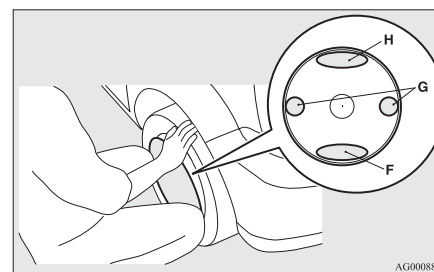

Towing

If your vehicle needs to be towed

If towing is necessary, we recommend you to have it done by your MITSUBISHI MOTORS Authorized Service Point or a commercial tow truck service.

In the following cases, transport the vehicle using a tow truck.

- The engine runs but the vehicle does not move or abnormal noise is produced.

- Inspection of the vehicle's underside reveals that oil or some other fluid is leaking.

If a wheel gets stuck in a ditch, do not try to tow the vehicle.

Please contact your MITSUBISHI MOTORS Authorized Service Point or a commercial tow truck service for assistance.

Only when you cannot receive a towing service from a MITSUBISHI MOTORS Authorized Service Point or commercial tow truck service, tow your vehicle carefully in accordance with the instructions given in "Emergency towing" in this part.

The regulations concerning towing may differ from country to country. It is recommended that you obey the regulations of the area where you are driving your vehicle.

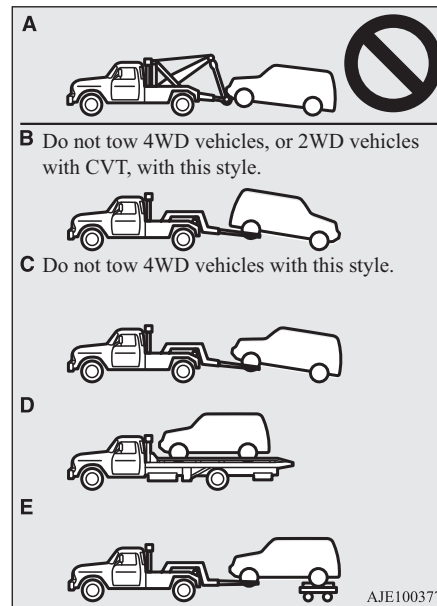

Towing the vehicle by a tow truck

⚠ CAUTION

- This vehicle must not be towed by a tow truck using sling lift type equipment (Type A) as illustrated. Using a sling lift will damage the bumper and front end.
- Do not tow 2WD vehicles with CVT with the driving wheels on the ground (Type B) as illustrated. This could result in the driving system damage.
- Do not tow 4WD vehicles with the front or rear wheels on the ground (Type B or Type C) as illustrated. This could result in driving system damage or the vehicle may jump at the carriage. If you tow 4WD vehicles, use Type D or E equipment.
- On 2WD vehicles, if the transmission is malfunctioning or damaged, transport the vehicle with the driving wheels on a carriage (Type C, D or E) as illustrated.

Towing

⚠ CAUTION

- [For 2WD vehicles equipped with the Active Stability Control (ASC)]

If the vehicle is towed with the ignition switch in the “ON” position or the operation mode in ON and only the front wheels or only the rear wheels raised off the ground (Type B or C), the ASC may operate, resulting in an accident. When towing the vehicle with the rear wheels raised, turn the ignition switch to the “ACC” position or put the operation mode in ACC. When towing the vehicle with the front wheels raised, keep the ignition switch or the operation mode as follows.

[Except vehicles equipped with keyless operation system]

The ignition switch is in the “LOCK” or “ACC” position.

[Vehicles equipped with keyless operation system]

The operation mode is in OFF or ACC.

Towing with rear wheels off the ground (Type B - 2WD vehicles with M/T only)

Place the gearshift lever in the “N” (Neutral) position.

Turn the ignition switch to the “ACC” position or put the operation mode in ACC and secure the steering wheel in a straight-ahead position with a rope or tiedown strap. Never place the ignition switch in the “LOCK” position or put the operation mode in OFF when towing.

Towing with front wheels off the ground (Type C - 2WD vehicles only)

Release the parking brake.

Place the gearshift lever in the “N” (Neutral) position (M/T) or the selector lever in the “N” (Neutral) position (CVT).

Emergency towing

If towing service is not available in an emergency, your vehicle may be temporarily towed by a rope secured to the towing hook.

If your vehicle is to be towed by another vehicle or if your vehicle tows another vehicle, pay careful attention to the following points.

If your vehicle is to be towed by another vehicle

1. The front towing hooks are located as shown in illustration. Secure the tow rope to the front towing hook.

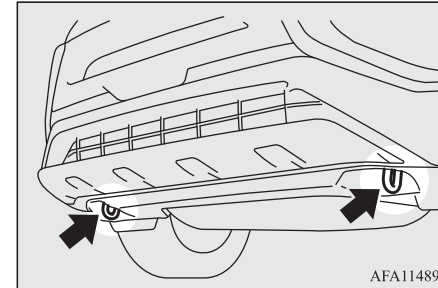

⚠ CAUTION

- Using any part other than the designated towing hook could result in damage to vehicle body.

📖 NOTE

- Using a wire rope or metal chain can result in damage to the vehicle body. It is best to use a non-metallic rope. If you use a wire rope or metal chain, wrap it with cloth at any point where it touches the vehicle body.
- Take care that the tow rope is kept as horizontal as possible. An angled tow rope can damage the vehicle body.
- Secure the tow rope to the same side towing hook, to keep the tow rope as straight as possible.

2. Keep the engine running.

If the engine is not running, perform the following operation to unlock the steering wheel.

[Except vehicles equipped with keyless operation system]

On vehicles with M/T, turn the ignition switch to the “ACC” or “ON” position.

On vehicles with A/T or CVT, turn the ignition switch to the “ON” position.

[For vehicles with the keyless operation system]

On vehicles with M/T, put the operation mode in ACC or ON.

On vehicles with A/T or CVT, put the operation mode in ON.

NOTE

- If your vehicle is equipped with the Auto Stop & Go (AS&G) system, press the “Auto Stop & Go (AS&G) OFF” switch to deactivate the Auto Stop & Go (AS&G) system before stopping the vehicle. Refer to “To deactivate” on page 6-35.

WARNING

- **When the engine is not running, the brake booster and power steering system do not operate. This means higher brake depression force and higher steering effort are required. Therefore, vehicle operation is very difficult.**

CAUTION

- Do not leave the ignition switch in the “LOCK” position or the operation mode in OFF. The steering wheel will lock, causing loss of control.
- For vehicle equipped with the Adaptive Cruise Control System (ACC) and Forward Collision Mitigation system (FCM), stop these systems to prevent an unexpected accident or unexpected operation during towing. Refer to “Adaptive Cruise Control System (ACC)” on page 6-78 and “Forward Collision Mitigation system (FCM)” on page 6-91.

3. Place the gearshift lever in the “Neutral” position (M/T), or the selector lever in the “N” (Neutral) position (A/T or CVT).
4. Turn on the hazard warning lamps if required by law. (Follow the local driving laws and regulations.)
5. During towing make sure that close contact is maintained between the drivers of both vehicles, and that the vehicles travel at low speed.

WARNING

- **Avoid sudden braking, acceleration and steering wheel movements; such driving operation could cause damage to the towing hook or tow rope. People in the vicinity could be injured as a result.**
- **When going down a long slope, the brakes may overheat, reducing effectiveness. Have your vehicle transported by a tow truck.**

CAUTION

- The person in the vehicle being towed must pay attention to the brake lamps of the towing vehicle and make sure the rope never becomes slack.
- When a vehicle equipped with A/T or CVT is to be towed by another vehicle with all the wheels on the ground, make sure that the towing speed and distance given below are never exceeded, since this may cause damage to the transmission.

Towing speed: 40 km/h (25 mph)
Towing distance: 40 km (25 miles)

For the towing speed and the towing distance, follow the local driving laws and regulations.

Operation under adverse driving conditions

If your vehicle tows another vehicle

Only use the rear towing hook as shown in the illustration.

Secure the tow rope to the rear towing hook. Otherwise, the instructions are the same as for “When being towed by another vehicle”.

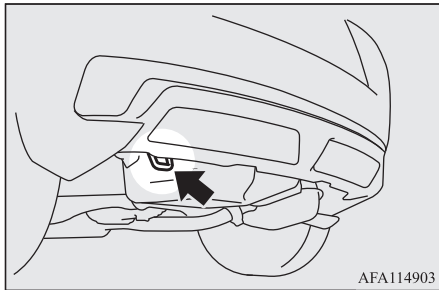

CAUTION

- Using any part other than the designated towing hook could result in damage to vehicle body.

CAUTION

- Do not tow a vehicle heavier than your own vehicle.

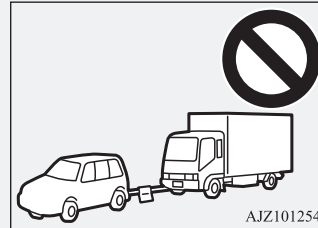

Operation under adverse driving conditions

On a flooded road

Avoid flooded roads. In the event driving flooded roads, doing so may cause the following serious damage to the vehicle.

- Engine stalling
- Short in electrical components
- Engine damage caused by water immersion

After driving on flooded roads, be sure to have an inspection at a MITSUBISHI MOTORS Authorized Service Point and take the necessary measures or repair.

On a wet road

When driving in rain or on a road with many puddles a layer of water may form between the tyres and the road surface.

This reduces a tyre's frictional resistance on the road, resulting in loss of steering stability and braking capability.

To cope with this, observe the following items:

- (a) Drive your vehicle at a slow speed.
- (b) Do not drive on worn tyres.
- (c) Always maintain the specified tyre inflation pressures.

On a snow-covered or frozen road

- When driving on a snow-covered or frozen road, it is recommended that you use snow tyres or snow traction device (tyre chains). Refer to the “Snow tyres” and “Snow traction device (tyre chains)” sections.
- Avoid high-speed operation, sudden acceleration, abrupt brake application and sharp cornering.

- Depressing the brake pedal during travel on snowy or icy roads may cause tyre slippage and skidding. When traction between the tyres and the road is reduced the wheels may skid and the vehicle cannot readily be brought to a stop by conventional braking techniques. Braking will differ, depending upon whether you have anti-lock brake system (ABS). As your vehicle is equipped with ABS, brake by pressing the brake pedal hard, and keeping it pressed.
- Allow extra distance between your vehicle and the vehicle in front of you, and avoid sudden braking.
- Accumulation of ice on the braking system can cause the wheels to lock. Pull away from a standstill slowly after confirming safety around the vehicle.

CAUTION

- Do not press the accelerator pedal rapidly. If the wheels break free of the ice, the vehicle could suddenly start moving and possibly cause an accident.

On a bumpy or rutted road

Drive as slow as possible when driving on bumpy or rutted roads.

CAUTION

- The impact on tyres and/or wheels when driving on a bumpy or rutted road can damage the tyre and/or wheel.

This vehicle is intended for driving mainly on roads with firm surface.

4WD system (if available on your vehicle) makes possible driving on roads without special coverage, on flat and firm surface. Please, remember that off-road ability of your vehicle is limited. Your vehicle is not intended for driving in heavy off-road terrain, overcoming the rugged terrain, deep ruts, etc. Manufacturer of the vehicle is proceeding from the following assumption: taking the decision to keep driving under conditions mentioned above, driver takes all actions at own risk, aware of possible consequences.

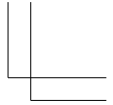
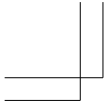

Handwriting practice lines consisting of 12 horizontal dashed lines.

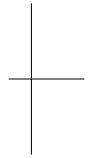
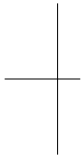

OGKE20E1

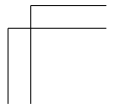
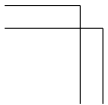

Vehicle care

Vehicle care precautions.....9-02
Cleaning the interior of your vehicle.....9-02
Cleaning the exterior of your vehicle.....9-03

Vehicle care precautions

Vehicle care precautions

In order to maintain the value of your vehicle, it is necessary to perform regular maintenance using the proper procedures.

Always maintain your vehicle in compliance with environmental pollution control regulations.

Carefully select the materials used for washing, etc., to be sure that they do not contain corrosives.

If in doubt, we recommend you to consult a specialist for selection of these materials.

9

CAUTION

- Cleaning products can be dangerous. Always follow the instructions of the cleaning product supplier.
- To avoid damage, never use the following to clean your vehicle:
 - Petrol
 - Paint Thinner
 - Benzine
 - Kerosene
 - Turpentine
 - Naphtha
 - Lacquer Thinner
 - Carbon Tetrachloride
 - Nail Polish Remover
 - Acetone

Cleaning the interior of your vehicle

After cleaning the interior of your vehicle with water, cleaner or similar, wipe and dry in a shady, well-ventilated area.

NOTE

- To clean the inside of the tailgate window, always use a soft cloth and wipe the window glass along the demister heater element so as not to cause damage.

CAUTION

- Do not use organic substances (solvents, benzine, kerosene, alcohol, petrol, etc.) or alkaline or acidic solutions. These chemicals can cause discolouring, staining or cracking of the surface. If you use cleaners or polishing agents, make sure their ingredients do not include the substances mentioned above.

Plastic, vinyl leather, fabric and flocked parts

1. Lightly wipe these off with a soft cloth soaked in a mild soap and water solution.
2. Dip cloth in fresh water and wring it out well. Using this cloth, wipe off the detergent thoroughly.

NOTE

- Do not use cleaners, conditioners, and protectants containing silicons or wax. Such products can cause discolouring and, when applied to the instrument panels or other parts, may cause reflections on the windscreen and obscure vision. Also, if such products get on the switches of the electrical accessories, it may lead to failure of these accessories.
- Do not use synthetic fiber or dry cloth. They can cause discolouring or damage the surface.
- Do not place a deodorizer on the instrument panel or near lamps and instruments. The ingredients for deodorizer can cause discolouring or cracking.

Upholstery

1. To maintain the value of your new vehicle, handle the upholstery carefully and keep the interior clean. Use a vacuum cleaner and brush to clean the seats. If stained, vinyl and synthetic leather should be cleaned with an appropriate cleaner. Cloth fabrics can be cleaned with either upholstery cleaner or a mild soap and water solution.
2. Clean the carpeting with a vacuum cleaner and remove any stains with carpet cleaner. Oil and grease can be removed by lightly dabbing with a clean colourfast cloth and stain remover.

Genuine leather*

1. To clean, lightly wipe the leather with a soft cloth soaked in a mild soap and water solution.
2. Dip cloth in fresh water and wring it out well. Using this cloth, wipe off the detergent thoroughly.
3. Apply leather protecting agent to the genuine leather surface.

NOTE

- If genuine leather is wet with water or is washed in water, wipe off water as quickly as possible with a dry, soft cloth. If left damp, mildew may grow.
- Organic solvents such as benzine, kerosene, alcohol and petrol, acid or alkaline solvents may discolour the genuine leather surface. Be sure to use neutral detergents.
- Remove dirty patches or oil substances quickly as they can stain genuine leather.
- The genuine leather surface may harden and shrink if it is exposed to direct sun for long hours. When your vehicle is parked, place it in the shade as much as possible.
- When the temperature of the vehicle interior rises in summer, vinyl products left on the genuine leather seat may deteriorate and stick to the seat.

Cleaning the exterior of your vehicle

If the following is left on your vehicle, it may cause corrosion, discolouration and stains, wash the vehicle as soon as possible

- Seawater, road deicing products.
- Soot and dust, iron powder from factories, chemical substance (acids, alkalis, coaltar, etc.).
- Droppings from birds, carcasses of insects, tree sap, etc.

Washing

Chemicals contained in the dirt and dust picked up from the road surface can damage the paint coat and body of your vehicle if left in prolonged contact.

Frequent washing and waxing is the best way to protect your vehicle from this damage. This will also be effective in protecting it from environmental elements such as rain, snow, salt air, etc.

Do not wash the vehicle in direct sunlight. Park the vehicle in the shade and spray it with water to remove dust. Next, using an ample amount of clean water and a car washing brush or sponge, wash the vehicle from top to bottom.

Use a mild car washing soap if necessary.

Cleaning the exterior of your vehicle

Rinse thoroughly and wipe dry with a soft cloth. After washing the vehicle, carefully clean the joints and flanges of the doors, bonnet and other sections where dirt is likely to remain.

CAUTION

- When washing the under side of your vehicle or wheel, be careful not to injure your hands.
- As your vehicle has rain sensor, place the wiper switch lever in the "OFF" position to deactivate the rain sensor before washing the vehicle. Otherwise, the wipers will operate in the presence of water spray on the windscreen and may get damaged as a result.
- Refrain from excessively using a car wash as its brushes may scratch the paint surface, causing it to lose its gloss. Scratches will be especially visible on darker coloured vehicles.
- Never spray or splash water on the electrical components in the engine compartment. Doing so could have an adverse effect on the engine startability. Exercise caution also when washing the underbody; be careful not to spray water into the engine compartment.
- Some types of hot water washing equipment apply high pressure and heat to the vehicle. They may cause heat distortion and damage to the vehicle resin parts and may result in flooding of the vehicle interior. Therefore:

Cleaning the exterior of your vehicle

CAUTION

- Maintain a distance of approximately 70 cm or more between the vehicle body and the washing nozzle.
- When washing around the door glass, hold the nozzle at a distance of more than 70 cm and at right angles to the glass surface.
- After washing the vehicle, drive the vehicle slowly while lightly depressing the brake pedal several times in order to dry out the brakes.
Leaving the brakes wet could result in reduced braking performance. Also, there is a possibility that they could freeze up or become inoperative due to rust, rendering the vehicle unable to move.
- When using an automatic car wash, pay attention to the following items, referring to the operation manual or consulting a car wash operator. If the following procedure is not followed, it could result in damage to your vehicle.
 - Close the door windows.
 - Close the front sunroof (if so equipped).
 - The outside mirrors are retracted.
 - The wiper arms are secured in place with tape.
 - As your vehicle is equipped with the roof spoiler and the rear spoiler, check with the car wash operator before using the car wash.
 - If your vehicle is equipped with roof rails, consult a car wash operator before using the car wash.

9

CAUTION

- As your vehicle has a rain sensor, place the wiper switch lever in the “OFF” position to deactivate the rain sensor.
- If your vehicle is equipped with the Ultrasonic misacceleration Mitigation System (UMS), turn off the system. Refer to “FCM and Ultrasonic misacceleration Mitigation System (UMS)* ON/OFF switch” on page 6-96.

During cold weather

Salt and other chemicals spread on the roads in some areas in winter can have a harmful effect on the vehicle body. You should therefore wash the vehicle as often as possible in accordance with our care-instructions. It is recommended to have a preservative applied and the underfloor protection checked before and after the cold weather season.

After washing your vehicle, wipe off all water drops from the rubber parts around the doors to prevent the doors from freezing.

NOTE

- To prevent freezing of the weatherstripping on the doors, bonnet, etc., they should be treated with silicone spray.

Waxing

Waxing the vehicle will help prevent the adherence of dust and road chemicals to the paintwork. Apply a wax solution after washing the vehicle, or at least once every three months to assist displacing of water.

Do not wax your vehicle in direct sunlight. You should wax after the surfaces have cooled.

For information on how to use wax refer to the instruction manual of the wax.

CAUTION

- Waxes containing high abrasive compounds should not be used.
- On vehicles with the front sunroof, be careful when waxing the area around the sunroof opening, not to put any wax on the weatherstrip (black rubber) and surrounding plastic parts. If stained with wax, the weatherstrip and surrounding plastic parts cannot maintain a weatherproof seal with the front sunroof.

Polishing

The vehicle should only be polished if the paintwork has become stained or lost its lustre. Do not polish parts with a mat coating and the plastic bumpers. Doing so could cause stains or damage the finish.

Cleaning plastic parts

Use a sponge or chamois leather. If a car wax adheres on a grey or black rough surface of the bumper, moulding or lamps, the surface becomes white. In such a case, wipe it off using lukewarm water and soft cloth or chamois leather.

CAUTION

- Do not use a scrubbing brush or other hard tools as they may damage the plastic part surface.
- Do not bring the plastic parts into contact with petrol, light oil, brake fluids, engine oils, greases, paint thinners, and sulphuric acid (battery electrolyte) which may crack, stain or discolour the plastic parts. If they touch the plastic parts wipe them off with soft cloth, chamois or the like and an aqueous solution of neutral detergent then immediately rinse the affected parts with water.

Chrome parts

In order to prevent spots and corrosion of chrome parts, wash with water, dry thoroughly, and apply a special protective coating. This should be done more frequently in winter.

Aluminium wheels*

1. Remove dirt using a sponge while sprinkling water on the wheels.
2. Use neutral detergent on any dirt that cannot be removed easily with water. Rinse off the neutral detergent after washing the wheels.
3. Dry the wheels thoroughly using a chamois leather or a soft cloth.

CAUTION

- Do not use a brush or other hard implement on the wheels. Doing so could scratch the wheels.
- Do not use any cleaner that contains an abrasive substance or is acidic or alkaline. Doing so could cause the coating on the wheels to peel or become discoloured or stained.
- Do not directly apply hot water using a steam cleaner or by any other means.
- Contact with seawater and road deicer can cause corrosion. Rinse off such substances as soon as possible.

Window glass

The window glass can normally be cleaned using only a sponge and water.

Glass cleaner can be used to remove oil, grease, insect carcasses, etc. After washing the glass, wipe it dry with a clean, dry, soft cloth. Never use a cloth that is used for cleaning a painted surface to clean a window. Wax from the painted surface could get on the glass and lower glass transparency and visibility.

NOTE

- To clean the inside of the rear window, always use a soft cloth and wipe the window glass along the demister heater element so as not to cause damage.

Wiper blades

Use a soft cloth and glass cleaner to remove grease, dead insects, etc., from the wiper blades. Replace the wiper blades when they no longer wipe properly. (Refer to page 10-17.)

Cleaning the sunroof*

Use a soft cloth to clean the inner side of the sunroof. Hard deposits should be wiped away with a cloth dipped in warm, neutral detergent solution. Wipe away the solution with a sponge dipped in fresh water.

Cleaning the exterior of your vehicle

NOTE

- The surface treatment on the inside of the glass may be removed if hard cloth or organic solvent (benzine, kerosene, thinner, etc.) is used.

Engine compartment

Clean the engine compartment at the beginning and end of winter. Pay particular attention to flanges, crevices and peripheral parts where dust containing road chemicals and other corrosive materials might collect.

If salt and other chemicals are used on the roads in your area, clean the engine compartment at least every three months.

Never spray or splash water on the electrical components in the engine compartment, as this may cause damage.

Do not bring the nearby parts, the plastic parts and so on into contact with sulphuric acid (battery electrolyte) which may crack, stain or discolour them.

If they are in contact, wipe off with soft cloth, chamois or the like and an aqueous solution of neutral detergent then immediately rinse the affected parts with plenty of water.

9

Maintenance

Service precautions.....	10-02
Catalytic converter*.....	10-03
Bonnet.....	10-03
Engine oil.....	10-04
Engine coolant.....	10-06
Washer fluid.....	10-08
Brake fluid/Clutch fluid*.....	10-08
Battery.....	10-09
AdBlue™ replenishment*.....	10-11
Tyres.....	10-13
Wiper blade rubber replacement.....	10-17
General maintenance.....	10-19
Fusible links.....	10-19
Fuses.....	10-20
Replacement of lamp bulbs.....	10-24

Service precautions

Service precautions

Adequate care of your vehicle at regular intervals serves to preserve the value and appearance as long as possible.

Maintenance items as described in this owner's manual can be performed by the owner.

We recommend you to have the periodic inspection and maintenance performed by a MITSUBISHI MOTORS Authorized Service Point or another specialist.

In the event a malfunction or a problem is discovered, we recommend you to have it checked and repaired. This section contains information on inspection maintenance procedures that you can do yourself. Follow the instructions and cautions for each of the various procedures.

10

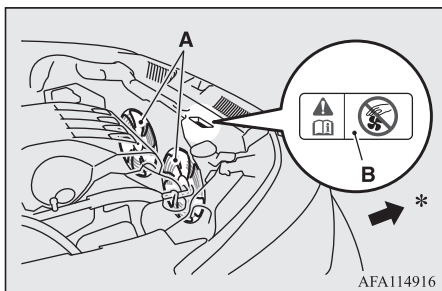

A- Cooling fans

B- Caution label

10-02 Maintenance

*: Front of the vehicle

WARNING

- When checking or servicing the inside of the engine compartment, make sure the engine is switched off and has had a chance to cool down.
- If it is necessary to do work in the engine compartment with the engine running, be especially careful that your clothing, hair, etc., does not become caught by the cooling fans, drive belts, or other moving parts.
- After performing the maintenance, make sure that no tools or cloths are left behind in the engine compartment. If they are left behind, a fire or damage to the vehicle may occur.
- The cooling fans can turn on automatically even if the engine is not running. Turn the ignition switch to the "LOCK" position or put the operation mode in OFF to be safe while you work in the engine compartment.
- Do not smoke, cause sparks or allow open flames around fuel or battery. The fumes are flammable.
- Be extremely cautious when working around the battery. It contains poisonous and corrosive sulphuric acid.
- Do not get under your vehicle with just the body jack supporting it. Always use automotive jack stands.

OGKE20E1

WARNING

- Improper handling of components and materials used in the vehicle can endanger your personal safety. We recommend you to consult a specialist for necessary information.

Check items of engine compartment are located as shown in the figure below.

Petrol-powered vehicles

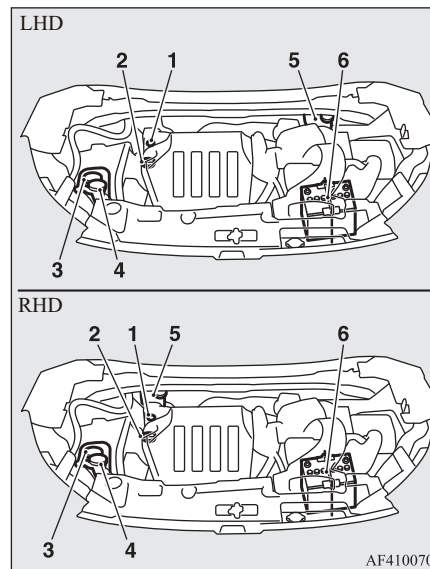

Diesel-powered vehicles

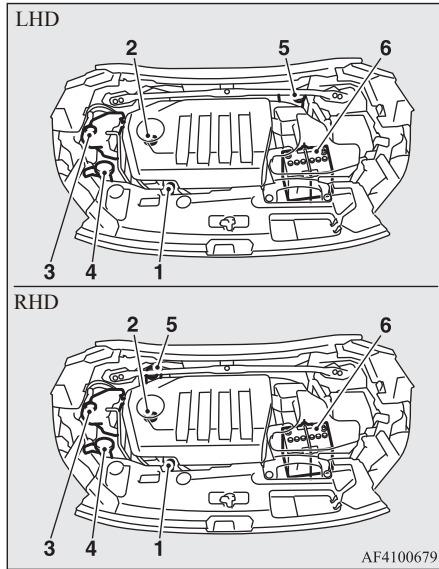

- 1- Engine oil level dipstick
- 2- Engine oil cap
- 3- Engine coolant reservoir
- 4- Washer fluid reservoir
- 5- Brake fluid reservoir/Clutch fluid reservoir*
- 6- Battery

Catalytic converter*

The exhaust gas scavenging devices used with the catalytic converter are extremely efficient for the reduction of noxious gases. The catalytic converter is installed in the exhaust system.

It is important to keep the engine properly tuned to ensure proper catalyst operation and prevent possible catalyst damage.

WARNING

- As with any vehicle, do not park or operate this vehicle in areas where combustible materials such as dry grass or leaves can come in contact with a hot exhaust since a fire could occur.
- Paint should not be applied to the catalytic converter.

NOTE

- Use fuel of the type recommended in "Fuel selection" on page 2-02.

Bonnet

To open

1. Pull the release lever towards you to unlock the bonnet.

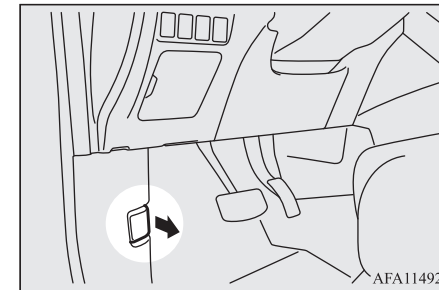

2. Raise the bonnet while pressing the safety lock.

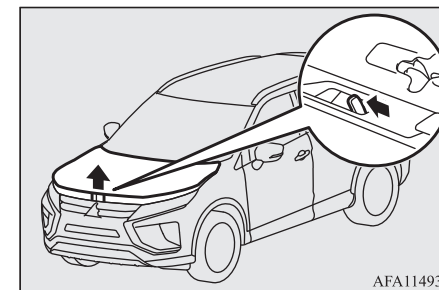

Engine oil

CAUTION

- Only open the bonnet when the wipers are in the original position. Failure to do so may cause damage to the bonnet, wiper arms or front windscreen.

3. Support the bonnet by inserting the support bar in its slot.

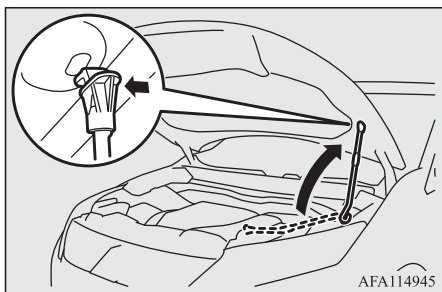

10

CAUTION

- Note that the support bar may disengage the bonnet if the open bonnet is lifted by a strong wind.
- After inserting the support bar into the slot, make sure the bar supports the bonnet securely from falling down on to your head or body.

To close

1. Unlatch the support bar and clip it in its holder.
2. Slowly lower the bonnet to a position approximately 20 cm above the closed position, then let it drop.
3. Make sure the bonnet is securely locked by softly lifting the centre of the bonnet.

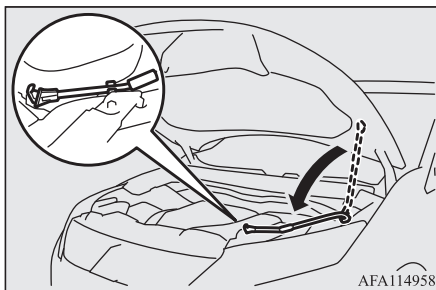

CAUTION

- Be careful that hands or fingers are not trapped when closing the bonnet.
- Before driving, make sure that the bonnet is securely locked. An incompletely locked bonnet can suddenly open while driving. This can be extremely dangerous.
- Do not press down the bonnet hard with a hand as it may damage the bonnet.

NOTE

- If this does not close the bonnet, release it from a slightly higher position.
- For vehicles equipped with the Auto Stop & Go (AS&G) system, if you drive with the bonnet left open, a warning display appears on the information screen in the multi-information display.



Engine oil

To check and refill engine oil

Petrol-powered vehicles

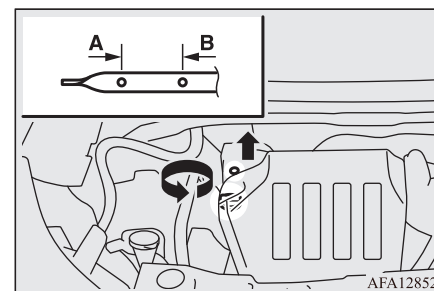

- A- Minimum level
- B- Maximum level

Diesel-powered vehicles

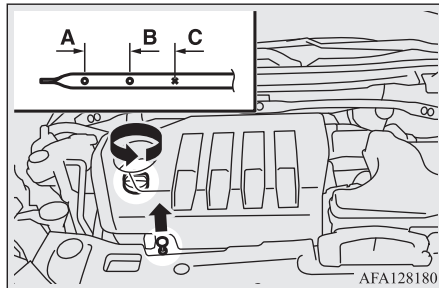

- A- Minimum level
- B- Maximum level
- C- Oil replacement indication mark

The engine oil used has a significant effect on the engine's performance, service life and startability. Be sure to use oil of the recommended quality and appropriate viscosity. All engines consume a certain amount of oil during normal operation. Therefore, it is important to check the oil level at regular intervals or before starting a long trip.

1. Park the vehicle on a horizontal surface.
2. Switch off the engine.
3. Wait a few minutes.

4. Remove the dipstick and wipe it with a clean cloth.
5. Reinsert the dipstick as far as it goes.
6. For petrol-powered vehicles, remove the dipstick and confirm that the oil level is between the marks (A) and (B). For diesel-powered vehicles, remove the dipstick and confirm that the oil level is between the marks (A) and (C).
7. If the oil level is less than the level indicated by the mark (A), remove the cap and add enough oil to raise the level to between the marks (A) and (B). For diesel-powered vehicles, if the oil level is above the mark (C), replace the oil as soon as possible. Then, the oil should be refilled to the maximum level (B).
8. After adding oil, close the cap securely.
9. Confirm the oil level by repeating step 4 to 6.

NOTE

- To avoid engine damage, do not overfill by exceeding the mark (B).
- Be sure to use the specified engine oil and do not mix various types of oil.
- When the oil level is checked in step 6 above, check it on a low side of the dipstick because it is different in appearance of oil level in the two sides of the dipstick.
- For diesel-powered vehicles, the engine oil level will be increased due to an amount of

NOTE

the fuel being mixed in the engine oil when the diesel particulate filter (DPF) regenerates to burn away the PM (particulate matter). It does not indicate a malfunction. In the following conditions, the engine oil level may increase easily. We recommend you to have it checked frequently.

- frequent driving at uphill and downhill
- frequent driving at high altitudes
- frequent and extended idling
- frequent driving through a traffic jam
- The engine oil will deteriorate rapidly if the vehicle is subjected to severe conditions, requiring earlier oil replacement. Please refer to the maintenance schedule.
- For handling of used engine oils, refer to page 2-12.

Recommended engine oil (petrol-powered vehicles)

Engine oil specification

Engine oil should meet all the following conditions.

- API SN classification
- Calcium content $\leq 2,000$ ppm
- Base number ≥ 6.37 mg KOH/g

Engine coolant

NOTE

- If those conditions are unknown, contact a MITSUBISHI MOTORS Authorized Service Point.

Recommended engine oil:
MITSUBISHI MOTORS GENUINE ENGINE OIL SN/GF-5.

Engine oil viscosity

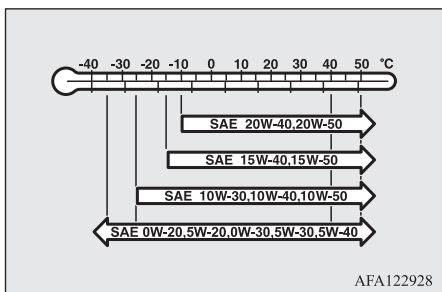

- Select engine oil of the proper SAE viscosity number according to the atmospheric temperature.

NOTE

- Use of additives is not recommended since they may reduce the effectiveness of additives already included in the engine oil. It may result in failure of the mechanical assembly.

Recommended engine oil (diesel-powered vehicles)

Engine oil specification

- Use engine oil conforming to the following classification:
 - ACEA classification: “For service C1, C2, C3 or C4”
 - JASO classification: “For service DL-1”

NOTE

- If those classifications are not available, contact a MITSUBISHI MOTORS Authorized Service Point.

Engine oil viscosity

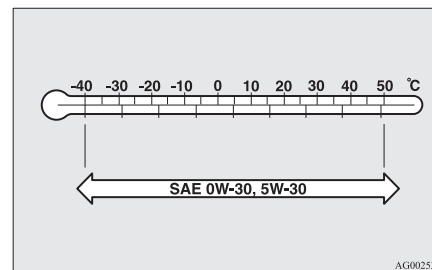

- Select engine oil of the proper SAE viscosity number according to the atmospheric temperature.

NOTE

- Use of additives is not recommended since they may reduce the effectiveness of additives already included in the engine oil. It may result in failure of the mechanical assembly.

Engine coolant

To check the coolant level

A transparent coolant reserve tank (A) is located in the engine compartment.

The coolant level in this tank should be kept between the “LOW” and “FULL” marks when measured while the engine is cold.

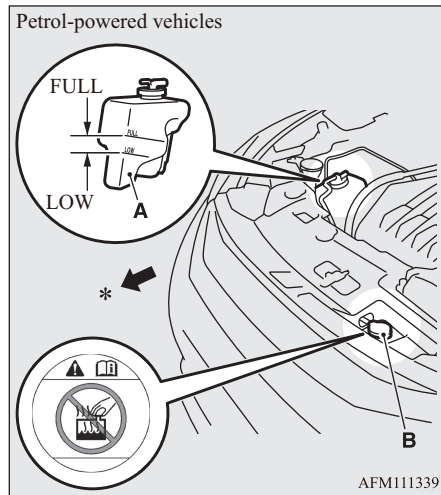

*: Front of the vehicle

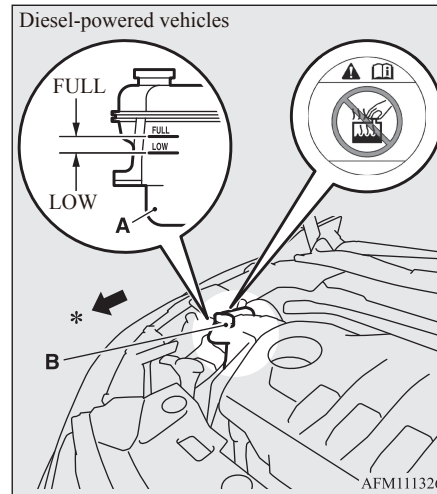

*: Front of the vehicle

To add coolant

The cooling system is a closed system and normally the loss of coolant should be very slight. A noticeable drop in the coolant level could indicate leakage. If this occurs, we recommend you to have the system checked as soon as possible.

If the level should drop below the “LOW” level on the reserve tank, open the lid and add coolant.

Also, if the reserve tank is completely empty, remove the radiator cap (B) and add coolant until the level reaches the filler neck.

WARNING

- Do not open the radiator cap (B) while the engine is hot. The coolant system is under pressure and any hot coolant escaping could cause severe burns.

Anti-freeze

The engine coolant contains an ethylene glycol anti-corrosion agent. Some parts of the engine are cast aluminium alloy, and periodic changing of the engine coolant is necessary to prevent corrosion of these parts.

Use “MITSUBISHI MOTORS GENUINE SUPER LONG LIFE COOLANT PREMIUM” or equivalent*.

*: similar high quality ethylene glycol based non-silicate, non-amine, non-nitrate and non-borate coolant with long life hybrid organic acid technology

MITSUBISHI MOTORS GENUINE Coolant has excellent protection against corrosion and rust formation of all metals including aluminium and can avoid blockages in the radiator, heater, cylinder head, engine block, etc.

Washer fluid

Because of the necessity of this anti-corrosion agent, the coolant must not be replaced with plain water even in summer. The required concentration of anti-freeze differs depending on the expected ambient temperature.

Above -35 °C: 50 % concentration of anti-freeze

Below -35 °C: 60 % concentration of anti-freeze

CAUTION

- Do not use alcohol or methanol anti-freeze or any engine coolants mixed with alcohol or methanol anti-freeze. The use of an improper anti-freeze can cause corrosion of the aluminium components.
- Do not use water to adjust the concentration of coolant.
- Concentrations exceeding 60 % will result in a reduction of both the anti-freeze and cooling performance thus adversely affecting the engine.
- Do not top up with water only. Water by itself reduces the rust-protective and anti-freeze qualities of the coolant and has a lower boiling point. It can also cause damage to the cooling system if it should freeze. Do not use tapwater, as it can cause corrosion and rust formation.

During cold weather

If the temperatures in your area drop below freezing, there is the danger that the coolant in the engine or radiator could freeze and cause severe damage to the engine and/or radiator. Add a sufficient amount of anti-freeze to the coolant to prevent it from freezing. The concentration should be checked before the start of cold weather and anti-freeze added to the system if necessary.

Washer fluid

Open the washer fluid reservoir cap and check the level of washer fluid with the dipstick.

If the level is low, replenish the container with washer fluid.

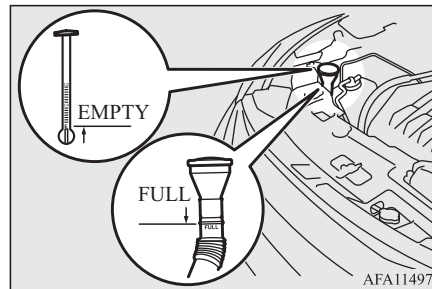

NOTE

- The washer fluid container serves the windscreen, rear window and headlamps (if so equipped).

During cold weather

To ensure proper operation of the washers at low temperatures, use a fluid containing an anti-freezing agent.

Brake fluid/Clutch fluid*

The brake fluid and the clutch fluid share the reservoir tank.

To check the fluid level

The fluid level must be between the “MAX” and “MIN” marks on the reservoir.

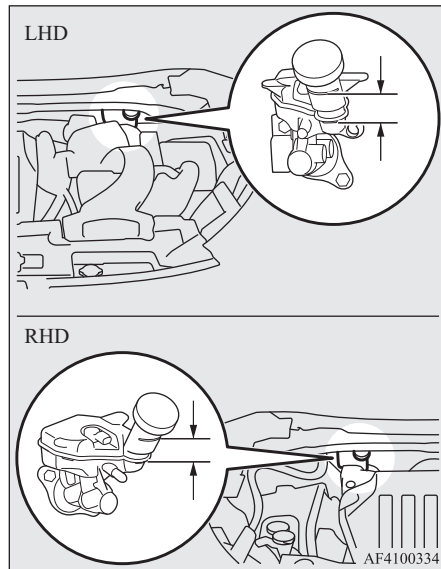

The fluid level is monitored by a float. When the fluid level falls below the “MIN” mark, the brake warning lamp lights up. The fluid level falls slightly with wear of the brake pads, but this does not indicate any abnormality.

The fluid in the master cylinder should be checked when doing other work under the bonnet. The brake system should also be checked for leakage at the same time. If the fluid level falls markedly in a short length of time, it indicates leaks from the brake system. If this occurs, we recommend you to have the vehicle checked.

Fluid type

Use brake fluid conforming to DOT3 or DOT4 from a sealed container. The brake fluid is hygroscopic. Too much moisture in the brake fluid will adversely affect the brake system, reducing the performance.

WARNING

- Take care in handling brake fluid as it is harmful to the eyes, may irritate your skin and will damage painted surfaces. Wipe up spills immediately. If brake fluid gets on your hands or in your eyes, flush immediately with clean water. Follow up with a doctor as necessary.

CAUTION

- Use only the specified brake fluid. Do not mix or add different brands of brake fluid to prevent chemical reactions. Do not let any petroleum-based fluid touch, mix with, or get into the brake fluid. This will damage the seals.
- Keep the reservoir tank cap closed to prevent the brake fluid from deteriorating except maintenance.
- Clean the filler cap before removing and close the cap securely after maintenance.

Battery

The condition of the battery is very important for quick starting and to keep the vehicle's electrical system working properly. Regular inspection and care are especially important in cold weather.

10

NOTE

- After replacing the battery, the electronic control system data for the automatic transmission, etc., will be erased. As a result, shift shocks may occur. Shift shocks will become smoother after several changes in speed.

Battery

Checking battery electrolyte level

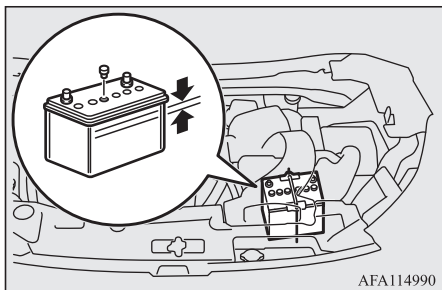

10

The electrolyte level must be between the specified limit on the outside of the battery. Replenish with distilled water as necessary.

The inside of the battery is divided into several compartments; remove the cap from each compartment and fill to the upper mark. Do not top up beyond the upper mark because spillage during driving could cause damage. Check the electrolyte level at least once every 4 weeks, depending on the operating conditions.

If the battery is not used, it will discharge by itself with time.

Check it once every 4 weeks and charge with low current as necessary.

Removing and installing the air duct

To replenish with the distilled water, remove the air duct.

⚠ WARNING

- Turn the ignition switch to the “LOCK” position or put the operation mode in OFF. Make sure that your clothes cannot be caught by the fan or drive belt. Personal injury could result.

Remove the two bolts (A), and then remove the air duct (B).

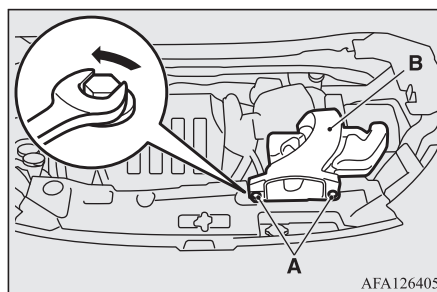

To install the air duct, perform the removal steps in reverse.

During cold weather

The capacity of the battery is reduced at low temperatures. This is an inevitable result of its chemical and physical properties. This is why a very cold battery, particularly one that is not fully charged, will only deliver a fraction of the starter current which is normally available.

We recommend you to have the battery checked before the start of cold weather and, if necessary, have it charged or replaced.

This does not only ensure reliable starting, but a battery which is kept fully charged also has a longer life.

Disconnection and connection

To disconnect the battery cable, stop the engine, first disconnect the negative (-) terminal and then the positive (+) terminal. When connecting the battery, first connect the positive (+) terminal and then the negative (-) terminal.

📖 NOTE

- Open the terminal cover (A) before disconnecting or connecting the positive (+) terminal of the battery.

NOTE

- Loosen the nut (B), and then disconnect the battery cable from the positive (+) terminal.

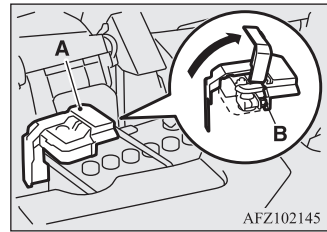

WARNING

- Always wear protective eye goggles when working near the battery. Battery electrolyte contains sulphuric acid, so getting it in your eyes is dangerous.
- Keep sparks, cigarettes, and flames away from the battery because the battery could explode.
- The battery electrolyte is extremely caustic. Do not allow it to come in contact with your eyes, skin, clothing, or the painted surfaces of the vehicle. Spilt electrolyte should be flushed immediately with ample amounts of water. Irritation to eyes or skin from contact with electrolyte requires immediate medical attention.
- Ventilate when charging or using the battery in an enclosed space.

CAUTION

- Keep it out of reach of children.
- Never disconnect the battery when the ignition switch is in the “ON” position or the operation mode in ON. Doing so could damage electric components.
- Never short-circuit the battery. This could cause it to overheat and be damaged.
- If the battery is to be quick-charged, first disconnect the battery cables.
- In order to prevent a short circuit, be sure to disconnect the negative (-) terminal first.
- Do not bring the nearby parts, the plastic parts and so on into contact with sulphuric acid (battery electrolyte) which may crack, stain or discolour them. If they are in contact, wipe off with soft cloth, chamois or the like and an aqueous solution of neutral detergent then immediately rinse the affected parts with plenty of water.

NOTE

- Keep the terminals clean. After the battery is connected, apply terminal protection grease. To clean the terminals, use lukewarm water.
- Check to see if the battery is securely installed and cannot be moved during travel. Also check each terminal for tightness.

NOTE

- When the vehicle is to be left unused for a long period of time, remove the battery and store it in a place where the battery fluid will not freeze. The battery should be stored only in a fully charged condition.

AdBlue™ replenishment*

AdBlue™: trademark of the Verband der Automobilindustrie e. V. (VDA).

CAUTION

- When replenishing, use only AdBlue™.
- Be careful not to spill AdBlue™. AdBlue™ can cause discolouring, staining, or cracking of painted surfaces. If any AdBlue™ gets on painted surfaces, wash it off immediately with clean water.
- Because AdBlue™ will freeze if the ambient temperature is less than approximately -11 °C (12 °F), observe the following precautions.
 - Do not replenish AdBlue™ if it is frozen. Otherwise, AdBlue™ could overflow.
 - If AdBlue™ is frozen, move the vehicle to a warmer place to defrost it completely.
 - Do not overfill the AdBlue™ tank. If the AdBlue™ tank is overfilled and AdBlue™ freezes, the AdBlue™ tank could be damaged.

AdBlue™ replenishment*

⚠ CAUTION

- Observe the following precautions when storing AdBlue™. Otherwise, AdBlue™ could degrade, causing an unusual odour.
 - Do not leave AdBlue™ inside the vehicle.
 - Seal the AdBlue™ container, and store it in a well-ventilated area out of direct sunlight.
- If a vehicle requires AdBlue™ or another reagent in order to reduce NO_x emissions, operating the vehicle when it does not consume the reagent may constitute a criminal act.

Types of diesel exhaust fluid and tank capacity

10

Diesel exhaust fluid	Use AdBlue™ that conforms to ISO 22241-1.
Capacity	Approximately 16 litres.

⚠ CAUTION

- When there is no AdBlue™ remaining and 0 km (0 mile) is displayed for the driving range, the engine cannot be restarted after it is stopped.

📖 NOTE

- The driving distance for 1 litre of AdBlue™ is approximately 1,000 km (621 miles). With a full tank of AdBlue™, the driving distance is approximately 16,000 km (9,942 miles), depending on your driving behavior, the vehicle load, etc.

Replenishing

1. Stop the vehicle in a safe place and stop the engine.
2. Open the fuel tank filler door by pulling the release lever located to the left of the driver's seat.

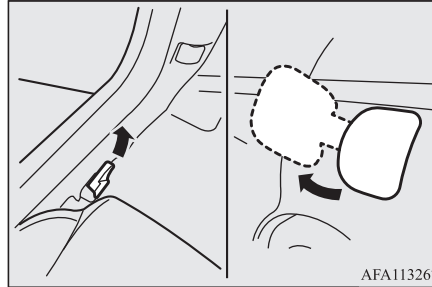

3. Slowly turn the AdBlue™ tank filler cap anticlockwise and remove it.

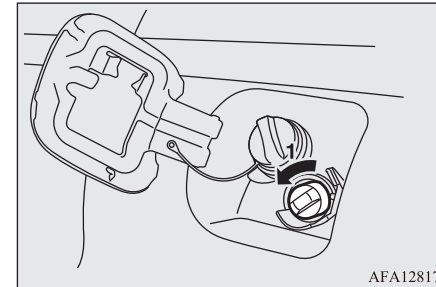

1- Remove

4. Insert the gun or bottle into the tank port to replenish AdBlue™.

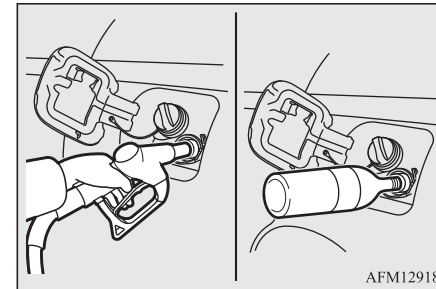

⚠ CAUTION

- When replenishing with a gun, insert the gun into the tank port as far as it goes. When replenishing with a bottle, securely fit the bottle into the tank port.
If the gun is not inserted correctly or if the bottle is not fit securely, AdBlue™ could spill.
- When the gun first stops automatically, stop replenishing AdBlue™.
If you continue replenishing AdBlue™, it could overflow.

5. After replenishing, turn the AdBlue™ tank filler cap clockwise until you hear clicking sounds.

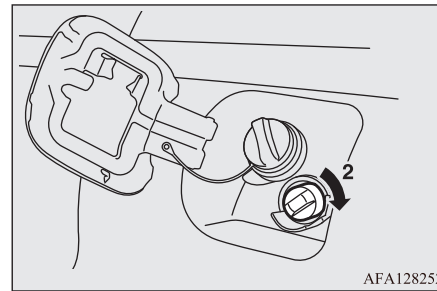

- 2- Close

6. Gently push the fuel tank filler door closed.

Tyres**⚠ WARNING**

- Driving with tyres that are worn, damaged or improperly inflated can lead to a loss of control or blow out of the tyres which can result in a collision with serious or fatal injury.

Tyre inflation pressures

Item	Tyre size	Front	Rear
Normal tyre	215/70R16 100H	2.4 bar (35 psi) [240 kPa], 2.6 bar (38 psi) [260 kPa]*	
	225/55R18 98H	2.4 bar (35 psi) [240 kPa], 2.6 bar (38 psi) [260 kPa]*	
Temporary spare tyre	T155/90D16 110M	4.2 bar (60 psi) [420 kPa]	
	T155/80D17 100M	4.2 bar (60 psi) [420 kPa]	

*: Above 160 km/h (99 mph)

Check the tyre inflation pressure of all the tyres while they are cold; if insufficient or excessive, adjust to the specified value. After the tyre inflation pressure has been adjusted, check the tyres for damage and air leaks. Be sure to put caps on the valves.

Tyres

Wheel condition

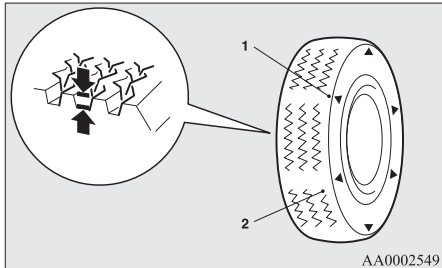

- 1- Location of the tread wear indicator
- 2- Tread wear indicator

10

Check the tyres for cuts, cracks and other damage. Replace the tyres if there are deep cuts or cracks. Also check each tyre for pieces of metal or pebbles.

The use of worn tyres can be very dangerous because of the greater chance of skidding or hydroplaning. The tread depth of the tyres must exceed 1.6 mm in order for the tyres to meet the minimum requirement for use.

Tread wear indicators will appear on the surface of the tyre as the tyre wears, thereby indicating that the tyre no longer meets the minimum requirement for use. When these wear indicators appear, the tyres must be replaced with new ones.

On 4-wheel drive vehicles, when replacement of any of the tyres is necessary, replace all of them.

CAUTION

- Always use tyres of the same size, same type, and same brand, and which have no wear differences. Using tyres of different size, type, brands or degree of wear, will increase the differential oil temperature, resulting in possible damage to the driving system. Further, the drive train will be subjected to excessive loading, possibly leading to oil leakage, component seizure, or other serious faults.

Replacing tyres and wheels

CAUTION

- Avoid using different size tyres from the one listed and the combined use of different types of tyres, as this can affect driving safety. Refer to “Tyres and wheels” on page 11-11.
- Even if a wheel has the same rim size and offset as the specified type of wheel, its shape may prevent it from being fitted correctly. We recommend you to consult a specialist before using wheels that you have.

CAUTION

- On vehicles equipped with a tyre pressure monitoring system, only MITSUBISHI MOTORS GENUINE wheels should be used. Use of another type of wheel risks air leaks and sensor damage, as it will not be possible to install the tyre pressure sensor properly. Refer to “Tyre pressure monitoring system (TPMS)” on page 6-119.

NOTE

- On vehicles equipped with the Electric parking brake, 16-inch steel wheels cannot be used because they interfere with brake parts. Additionally, 16-inch aluminium wheels may not be used on your vehicle depending on their type, even if they are MITSUBISHI MOTORS GENUINE wheels. Consult a MITSUBISHI MOTORS Authorized Service Point before using wheels that you have.
- When replacing the tyres and wheels, refer to the tyre pressure label on the driver’s door to confirm the size of tyres that can be installed on your vehicle. If you install tyres with a size that is not indicated on the label, they could interfere with the brake parts.

Tyre rotation

Tyre wear varies with vehicle conditions, road surface conditions and individual driver's driving habits. To equalize the wear and help extend tyre life, it is recommended to rotate the tyres immediately after discovery of abnormal wear, or whenever the wear difference between the front and rear tyres is recognizable.

When rotating tyres, check for uneven wear and damage. Abnormal wear is usually caused by incorrect tyre pressure, improper wheel alignment, out of balance wheel, or severe braking. We recommend you to have it checked to determine the cause of irregular tread wear.

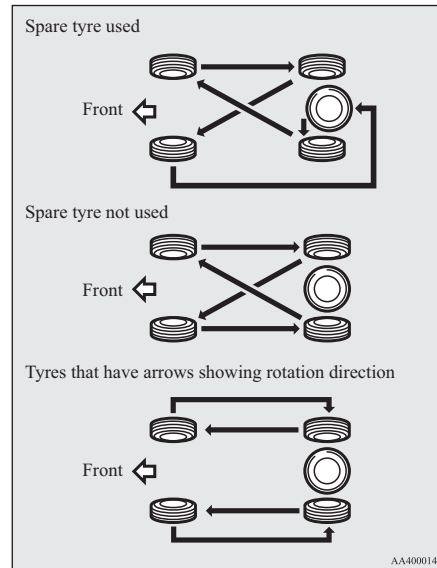

* If the spare tyre wheel differs from the standard tyre wheel, do not perform tyre rotation using a spare wheel.

CAUTION

- A temporary spare tyre can be fitted temporarily in place of a tyre that has been removed during the tyre rotation. However, it must not be included in the regular tyre rotation sequence.
- If the tyres have arrows (A) indicating the correct direction of rotation, swap the front and rear tyres on the left-hand side of the vehicle and the front and rear tyres on the right-hand side of the vehicle separately. Keep each tyre on its original side of the vehicle. When fitting the tyres, make sure the arrows point in the direction in which the wheels will turn when the vehicle moves forward. Any tyre whose arrow points in the wrong direction will not perform to its full potential.

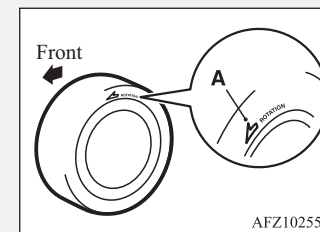

- Avoid the combined use of different types of tyres. Using different types of tyres can affect vehicle performance and safety.

Tyres

Snow tyres

The use of snow tyres is recommended for driving on snow and ice. To preserve driving stability, mount snow tyres of the same size and tread pattern on all 4 wheels.

A snow tyre that is worn down more than 50% is no longer appropriate to use.

Snow tyres which do not meet specifications must not be used.

CAUTION

- Observe permissible maximum speed for your snow tyres and the legal speed limit.
- On vehicles equipped with a tyre pressure monitoring system, only MITSUBISHI MOTORS GENUINE wheels should be used. Use of another type of wheel risks air leaks and sensor damage, as it will not be possible to install the tyre pressure sensor properly. Refer to “Tyre pressure monitoring system (TPMS)” on page 6-119.

NOTE

- The laws and regulations concerning snow tyres (driving speed, required use, type, etc.) vary. Find out and follow the laws and regulations in the area you intend to drive.
- If flange nuts are used on your vehicle, change to tapered nuts when steel wheels are used.

Snow traction device (tyre chains)

If snow traction device (tyre chains) have to be used, ensure that they are fitted only on the drive wheels (front) in accordance with the manufacturer’s instructions.

On 4WD vehicles in which the driving power is distributed preferentially to the front wheels, ensure that the snow traction device (tyre chains) are fitted on the front.

Use only snow traction device (tyre chains) which are designed for use with the tyres mounted on the vehicle: use of the incorrect size or type of snow traction device (tyre chains) could result in damage to the vehicle body.

Contact a MITSUBISHI MOTORS Authorized Service Point before putting on a snow traction device (tyre chains). The max. snow traction device (tyre chains) height is as follows.

Tyre size	Wheel size	Max. snow traction device (tyre chains) height [mm]
215/70R16 100H	16 x 6 1/2 J 16 x 6 1/2 JJ	9 mm
225/55R18 98H	18x7 J	

When driving with a snow traction device (tyre chains) on the tyres, do not drive faster than 50 km/h (30 mph). When you reach roads that are not covered in snow, immediately remove the snow traction device (tyre chains).

CAUTION

- Choose a clear straight stretch of road where you can pull off and still be seen while you are fitting the snow traction device (tyre chains).
- Do not fit snow traction device (tyre chains) before you need them. This will wear out your tyres and the road surface.
- After driving around for 100-300 meters, stop and retighten the snow traction device (tyre chains).
- Drive cautiously and do not exceed 50 km/h (30 mph). Remember that preventing accidents is not the purpose of snow traction device (tyre chains).
- When snow traction device (tyre chains) are installed, take care that they do not damage the disc wheel or body.
- Do not install a snow traction device (tyre chains) on an emergency wheel which is compact in size. If one of the front wheels has punctured, replace it with one of the rear wheels and install the temporary spare wheel in that place before fitting a snow traction device (tyre chains).

Wiper blade rubber replacement

CAUTION

- An aluminium wheel can be damaged by a snow traction device (tyre chains) while driving. When fitting a snow traction device (tyre chains) on an aluminium wheel, take care that any part of the snow traction device (tyre chains) and fitting cannot be brought into contact with the wheel.
- On vehicles equipped with the wheel covers, remove the wheel covers before installing a snow traction device (tyre chains), otherwise they may be damaged by the snow traction device (tyre chains). (See “Wheel covers*” on page 8-25.)
- When installing or removing a snow traction device (tyre chains), take care that hands and other parts of your body are not injured by the sharp edges of the vehicle body.

NOTE

- The laws and regulations concerning the use of snow traction device (tyre chains) vary. Always follow local laws and regulations. In most countries, it is prohibited by the law to use of snow traction device (tyre chains) on roads without snow.

Wiper blade rubber replacement

Windscreen wiper blades

1. Lift the wiper arm off the windscreen.
2. Pull the wiper blade until its stopper (A) disengages from the hook (B). Pull the wiper blade further to remove it.

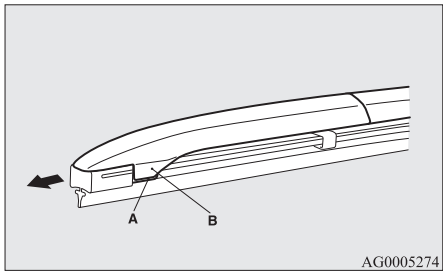

CAUTION

- Do not let the wiper arm drop onto the windscreen. This could damage the glass.

3. Attach the retainers (C) to a new wiper blade.

Refer to the illustration to ensure that the retainers are correctly aligned as you attach them.

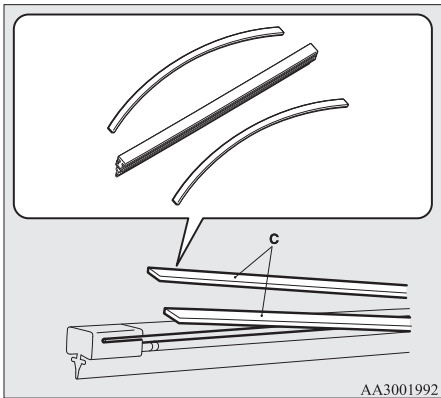

4. Insert the wiper blade into the arm, starting with the opposite end of the blade from the stopper. Make sure the hook (B) is fitted correctly in the grooves in the blade.

NOTE

- If a retainer is not supplied with the new wiper blade, use the retainer from the old blade.

Wiper blade rubber replacement

5. Push the wiper blade until the hook (B) engages securely with the stopper (A).

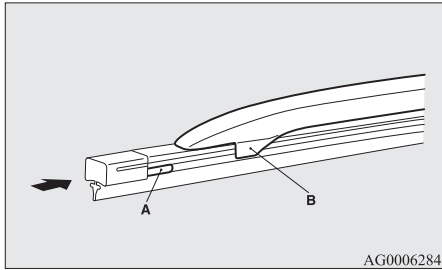

Refer to “Rear window wiper and washer” on page 5-71

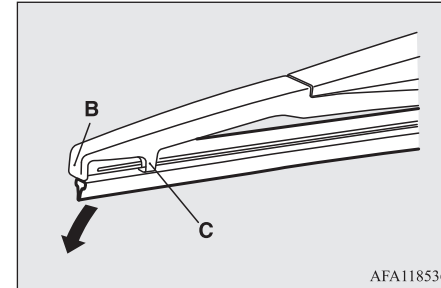
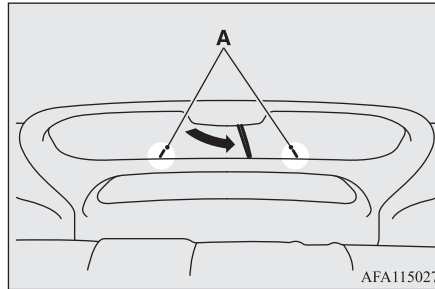

CAUTION

- Do not allow the wiper arm to fall onto the window glass; it could damage the glass.

Rear window wiper blade

10

1. Turn the ignition switch to the “ACC” position or put the operation mode in ON.
2. Operate the rear wiper using the rear window wiper and washer switch, and when the rear wiper is within the mark (A) on the rear window, turn the ignition switch to the “LOCK” position, or put the operation mode in OFF.

CAUTION

- If the rear wiper is not stopped within the mark (A), the wiper arm will contact the roof spoiler and you will not be able to lift the wiper arm. If you forcefully try to lift the wiper arm, the wiper arm and roof spoiler could be damaged or the painted surfaces could be scratched.

3. Set the rear window wiper and washer switch to OFF.
4. Lift the wiper arm off the window glass.
5. Pull the wiper blade downward to disengage it from the stopper (B) at the end of the wiper arm. Pull the wiper blade further to remove it.
6. Slide a new wiper blade through the hook (C) on the wiper arm.

7. Firmly insert the retainer (D) into the groove (E) in the wiper blade.

Refer to the illustration to ensure that the retainers are correctly aligned as you insert them into the groove.

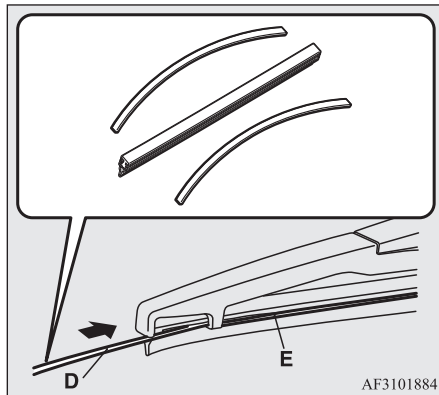

AF3101884

NOTE

- If a retainer is not supplied with the new wiper blade, use the retainer from the old blade.

General maintenance

Fuel, engine coolant, oil and exhaust gas leakage

Look under the body of your vehicle to check for fuel, engine coolant, oil and exhaust gas leaks.

WARNING

- If you see a suspicious fuel leak or if you smell fuel, do not operate the vehicle; call your MITSUBISHI MOTORS Authorized Service Point for assistance.

Exterior and interior lamp operation

Operate the combination headlamps and dipper switch to check that all lamps are functioning properly.

If the lamps do not illuminate, the probable cause is a blown fuse or defective lamp bulb. Check the fuses first. If there is no blown fuse, check the lamp bulbs.

For information regarding the inspection and replacement of the fuses and the bulbs, refer to “Fuses” on page 10-20 and “Replacement of lamp bulbs” on page 10-24.

If the fuses and bulbs are all OK, we recommend you to have your vehicle checked and repaired.

Meter, gauge and indicator/warning lamps operation

Start the engine and check the operation of all instruments, gauges and indication and warning lamps.

If there is anything wrong, we recommend you to have your vehicle inspected.

Hinges and latches lubrication

Check all latches and hinges, and, if necessary, have them lubricated.

Fusible links

The fusible links will melt to prevent a fire if a large current attempts to flow through certain electrical systems.

In case of a melted fusible link, we recommend you to have your vehicle inspected.

For the fusible links, please refer to “Fuse load capacity” on page 10-21 and “Engine compartment fuse location table” on page 10-22.

Fuses

⚠ WARNING

- **Fusible links must not be replaced by any other device. Failing to fit the correct fusible link may result in fire in the vehicle, property destruction and serious or fatal injuries at any time.**

Fuses

Fuse block location

To prevent damage to the electrical system due to short-circuiting or overloading, each individual circuit is provided with a fuse.

10

There are fuse blocks in the passenger compartment and in the engine compartment.

Passenger compartment

LHD vehicles

The fuse block in the passenger compartment is located behind the fuse lid in front of the driver's seat at the position shown in the illustration.

Pull the fuse lid to remove it.

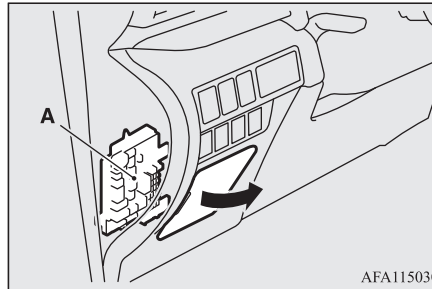

A- Fuse block

RHD vehicles

The fuse block in the passenger compartment is located behind the glove box at the position shown in the illustration.

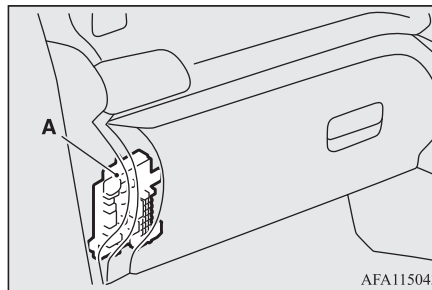

A- Fuse block

1. Open the glove box.
2. Uncouple the rod (B) on the right side of the glove box by pulling the rod to the right.

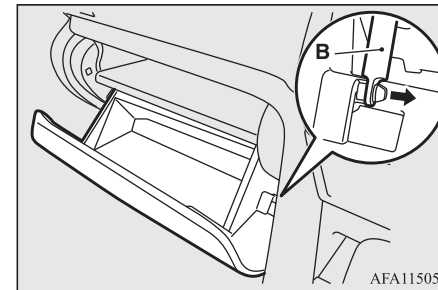

3. Pull the glove box fastener (C), then the fastener (D), towards you in the directions of the arrows shown in the illustration to remove them.

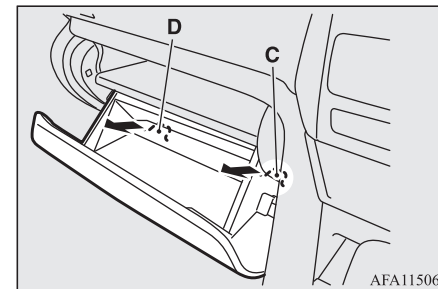

4. Pull the glove box from the bottom to remove it.

Engine compartment

The fuse block in the engine compartment is located as shown in the illustration.

1. Press the tab.
2. Remove the cover.

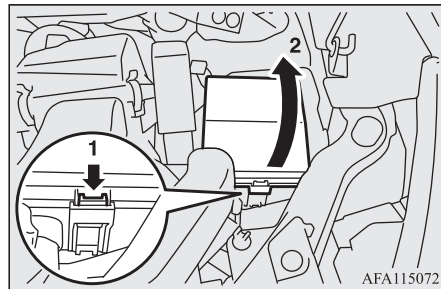

Fuse load capacity

The fuse capacity and the names of electrical systems protected by the fuses are indicated on the inside of the fuse lid (LHD vehicles), the back side of the glove box (RHD vehicles) and inside of the fuse block cover (inside of the engine compartment).

NOTE

- Spare fuses are provided on the cover of fuse block in the engine compartment. Always use a fuse of the same capacity for replacement.

Passenger compartment fuse location table

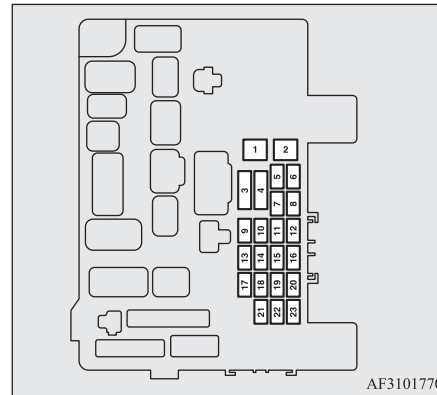

No.	Symbol	Electrical system	Capacity
1		Electric window control	30 A *

*: Fusible link

No.	Symbol	Electrical system	Capacity
2		Rear window demister	30 A *
3		Heater	30 A
4		Windscreen wipers	30 A
5		Door locks	25 A
6	—	—	—
7		Accessory socket	15 A
8		Rear window wiper	15 A
9		Sunroof	20 A
10		Ignition switch	10 A
11		Option	10 A
12		Hazard warning flasher	15 A
13		4-wheel drive system	10 A
14	STOP	Stop lamps (Brake lamps)	15 A
15		Instruments	10 A

*: Fusible link

Fuses

No.	Symbol	Electrical system	Capacity
16		SRS airbag	7.5 A
17		Radio	15 A
18		Control unit relay	7.5 A
19		Interior lamps (Room lamps)	15 A
20		Reversing lamps (Backup lamps)	7.5 A
21		Heated door mirror	7.5 A
22		Outside rear-view mirrors	10 A
23		Cigarette lighter/Accessory socket	15 A

*: Fusible link

- Some fuses may not be installed on your vehicle, depending on the vehicle model or specifications.
- The table above shows the main equipment corresponding to each fuse.

Engine compartment fuse location table

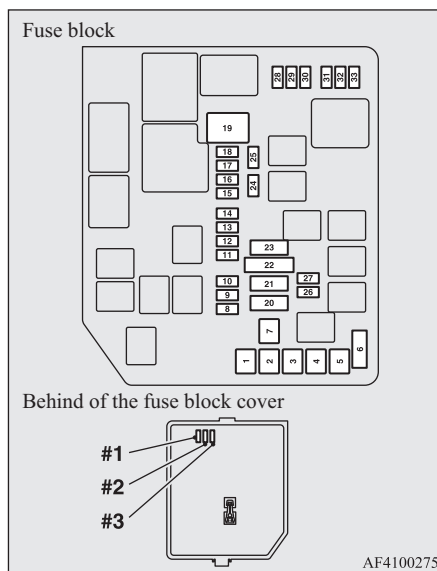











No.	Symbol	Electrical system	Capacity
1		Electric parking brake	30 A*

*: Fusible link













No.	Symbol	Electrical system	Capacity
2		Electric parking brake	30 A*
3		Anti-lock braking system	40 A*
4		Anti-lock braking system	30 A*
5		Power seat	30 A*
6		Heated seat	30 A
7		Starter	30 A*
8		Heated steering wheel	15 A
9		Headlamp washer	20 A
10		Security horn	20 A
11		Automatic transmission	20 A
12		Horn	10 A
13		Sunshade	20 A

*: Fusible link

Fuses

No.	Symbol	Electrical system	Capacity
14		Front fog lamps	15 A
15		Daytime running lamps	10 A
16		Air conditioning	10 A
17		Engine control unit	7.5 A
18		Alternator	7.5 A
19		Radiator fan motor	40 A*
20		Audio system amp	30 A
21	—	—	—
		UREA SCR	30 A
22	IOD	IOD	30 A
23		Air conditioning condenser fan motor	30 A*
24		Battery current sensor	7.5 A

*: Fusible link

No.	Symbol	Electrical system	Capacity
25		Electric Parking brake/Adaptive Cruise Control (ACC)	7.5 A
			
26		Headlamp high-beam (right)	10 A
27		Headlamp high-beam (left)	10 A
28		Turbo actuator	20 A
		Diesel	20 A
29		ENG/POWER	20 A
			25 A
30		Fuel pump	15 A
31		Ignition coil	10 A
		ENG/POWER	10 A
32		Injector	20 A
		PM sensor	10 A
33		ETV	15 A

*: Fusible link

No.	Symbol	Electrical system	Capacity
		NO _x sensor	10 A
#1	—	Spare fuse	10 A
#2	—	Spare fuse	15 A
#3	—	Spare fuse	20 A

*: Fusible link

- Some fuses may not be installed on your vehicle, depending on the vehicle model or specifications.

- The table above shows the main equipment corresponding to each fuse.

The fuse block does not contain spare 7.5 A, 25 A or 30 A fuses. If one of these fuses burns out, substitute with the following fuse.

7.5 A: 10 A Spare fuse

25 A: 20 A Spare fuse

30 A: 30 A Audio system amp fuse

When using a substitute fuse, replace with a fuse of the correct capacity as soon as possible.

Identification of fuse

Capacity	Colour
7.5 A	Brown

10

Replacement of lamp bulbs

Capacity	Colour
10 A	Red
15 A	Blue
20 A	Yellow
25 A	Natural (White)
30 A	Green (fuse type) / Pink (fusible link type)
40 A	Green (fusible link type)

Fuse replacement

1. Before replacing a fuse, always turn off the electrical circuit concerned and place the ignition switch in the "LOCK" position or put the operation mode in OFF.
2. Remove the fuse puller (A) from the inside of the fuse block cover in the engine compartment.

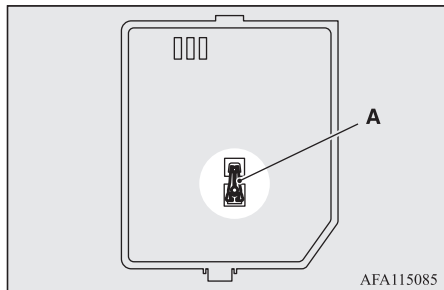

3. Referring to the fuse load capacity table, check the fuse pertaining to the problem.

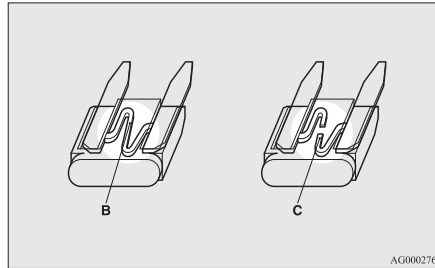

B- Fuse is OK
C- Blown fuse

NOTE

- If any system does not function but the fuse corresponding to that system is normal, there may be a fault in the system elsewhere. We recommend you to have your vehicle checked.

4. Insert a new fuse of the same capacity by using the fuse puller into the same place the fuse block.

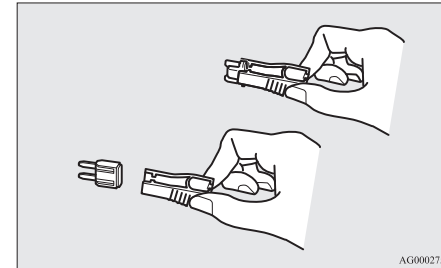

CAUTION

- If the newly inserted fuse blows again after a short time, we recommend you to have the electrical system checked to find the cause and rectify it.
- Never use a fuse with a larger capacity than specified or a substitute (such as a cable or foil). Doing so could cause the circuit wires to overheat and create a fire.

Replacement of lamp bulbs

Before replacing a bulb, ensure the lamp is off. Do not touch the glass part of the new bulb with your bare fingers; the skin oil left on the glass will evaporate when the bulb gets hot and the vapour will condense on the reflector and dim the surface.

⚠ CAUTION

- Do not install commercially available LED type bulbs.
Commercially available LED type bulbs could adversely affect the operation of the vehicle, such as by preventing the lamps and other vehicle equipment from operating properly.
- Bulbs are extremely hot immediately after being turned off.
When replacing a bulb, wait for it to cool sufficiently before touching it. You could otherwise be burnt.
- Handle halogen lamp bulbs with care. The gas inside a halogen lamp bulb is highly pressurized, so dropping, knocking, or scratching a halogen lamp bulb can cause it to shatter.

⚠ CAUTION

- Never hold the halogen lamp bulb with a bare hand, dirty glove, etc.
The oil from your hand could cause the bulb to break the next time the headlamps are operated.
If the glass surface is dirty, it must be cleaned with alcohol, paint thinner, etc., and refit it after drying thoroughly.

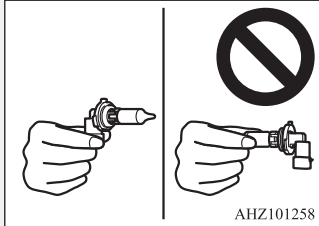

AHZ101258

📖 NOTE

- If you are unsure of how to carry out the work as required, we recommend you to consult a specialist.
- Be careful not to scratch the vehicle body when removing a lamp or lens.

📖 NOTE

- When it rains or when the vehicle has been washed, the inside of the lens sometimes becomes foggy. This is the same phenomenon as when window glass mists up on a humid day, and does not indicate a functional problem.
When the lamp is switched on, the heat will remove the fog. However, if water gathers inside the lamp, we recommend you to have the lamp checked.

Bulb location and capacity

⚠ CAUTION

- When replacing a bulb, be sure to use a new bulb of the same type, wattage and colour.
If you install a different bulb, the bulb could malfunction or fail to come on and could lead to a vehicle fire.

Replacement of lamp bulbs

Outside

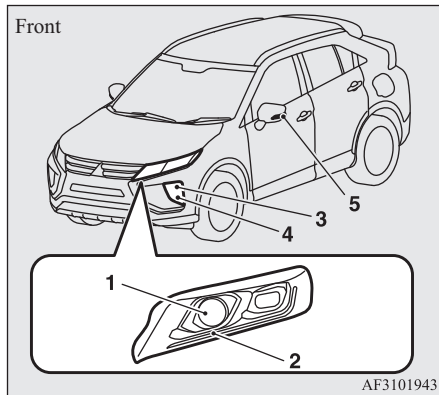

10

- 1- Headlamps
Halogen: 55 W (HIR2)
LED: –
- 2- Position lamps/Daytime running lamps:
–
- 3- Front turn-signal lamps: 21 W (PY21W)
- 4- Front fog lamps*: 35 W (H8)
- 5- Side turn-signal lamps: –

Codes in parentheses indicate bulb types.

NOTE

- The following lamps use an LED instead of the bulb.
If you need to repair or replace these lamps, contact a MITSUBISHI MOTORS Authorized Service Point.
 - Headlamps (LED type)
 - Position lamps/Daytime running lamps
 - Side turn-signal lamps

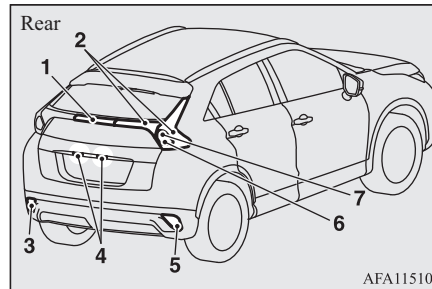

- 1- High-mounted stop lamp: –
- 2- Tail lamps: –
- 3- Rear fog lamp (LHD vehicles): 21 W (W21W)
Reversing lamp (RHD vehicles): 16 W (W16W)
- 4- Licence plate lamps: 5 W (W5W)
- 5- Rear fog lamp (RHD vehicles): 21 W (W21W)
Reversing lamp (LHD vehicles): 16 W (W16W)

- 6- Rear turn-signal lamps: 21 W (WY21W)
- 7- Stop lamps: –

Codes in parentheses indicate bulb types.

NOTE

- The following lamps use an LED instead of the bulb.
If you need to repair or replace these lamps, contact a MITSUBISHI MOTORS Authorized Service Point.
 - High-mounted stop lamp
 - Tail lamps
 - Stop lamps

Replacement of lamp bulbs

Inside

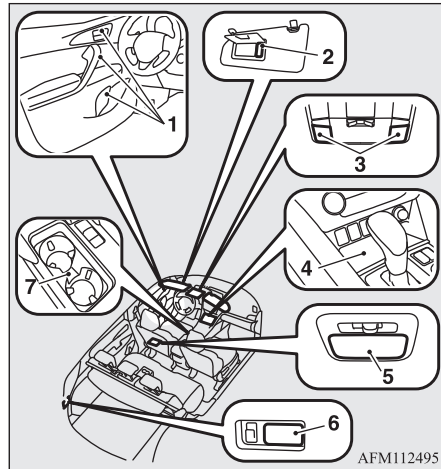

- 1- LED interior illumination (Front door)*: –
- 2- Vanity mirror lamps*: 2 W
- 3- Map & room lamps (front): 10 W
- 4- LED interior illumination (Smartphone tray): –
- 5- Room lamp (rear): 8 W
- 6- Luggage room lamp: 5 W
- 7- LED interior illumination (Front drink holder): –

NOTE

- The following lamps use an LED instead of the bulb.
If you need to repair or replace these lamps, contact a MITSUBISHI MOTORS Authorized Service Point.
 - LED interior illumination (Smartphone tray)
 - LED interior illumination (Front drink holder)
 - LED interior illumination (Front door) (if so equipped)

Headlamps (halogen bulb)

NOTE

- When replacing the bulb on the right side of the vehicle, make sure that the removed parts do not contact the coolant reserve tank.
1. For diesel-powered vehicles, remove the bolt (A), and then move the sub fuse box and bracket rearward.

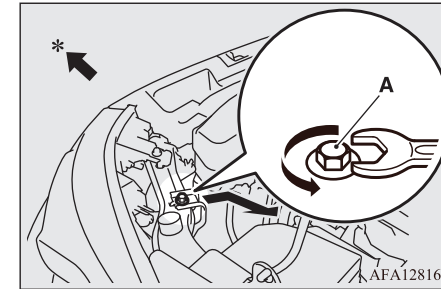

*: Front of the vehicle

2. Turn the cap (B) anticlockwise to remove it.

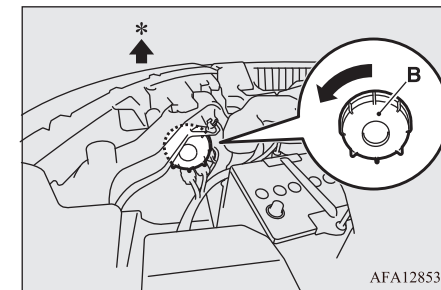

*: Front of the vehicle

10

Replacement of lamp bulbs

3. While pulling the tab (C), pull out the socket (D).

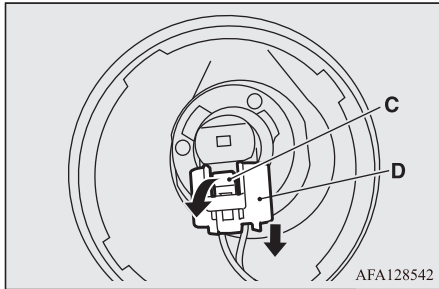

4. Turn the bulb (E) anticlockwise to remove it.

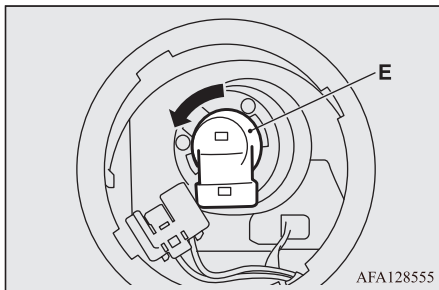

5. To install the bulb, perform the removal steps in reverse.

NOTE

- After installing the cap (B), make sure that the mark (F) on the cap is pointing upward and the cap is locked in place. If the cap is not locked in place, it may become detached while the vehicle is being driven.

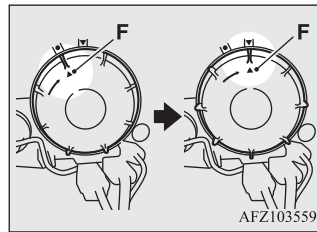

Front turn-signal lamps

1. To create enough work space, turn the steering wheel all the way in the direction opposite to the side you wish to replace.
2. Remove the screw (A), and then pull the wheel cut moulding (B) outward to release the three clips (C).

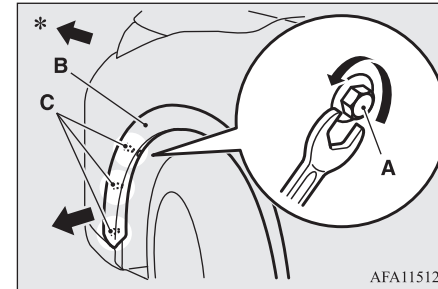

*: Front of the vehicle

CAUTION

- Do not pull the wheel cut moulding (B) more than necessary to release the three clips (C). Otherwise, the wheel cut moulding could break.

3. Remove the three clips (D), and then pull back the splash shield (E).

Replacement of lamp bulbs

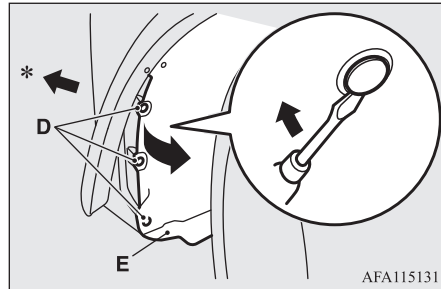

*: Front of the vehicle

- Turn the socket (F) anticlockwise to remove it, then remove the bulb from the socket by turning it anticlockwise while pressing in.

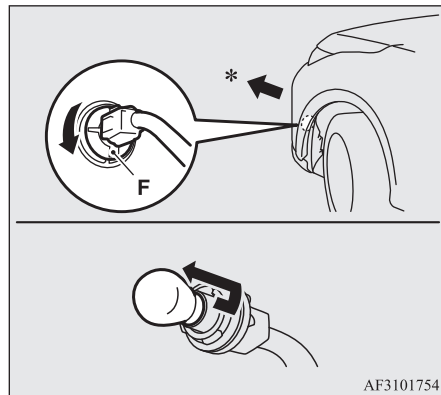

*: Front of the vehicle

- To install the bulb, perform the removal steps in reverse.

NOTE

- When refitting the clip (D), first insert part (G) of the clip into the hole and then press part (H) into it.

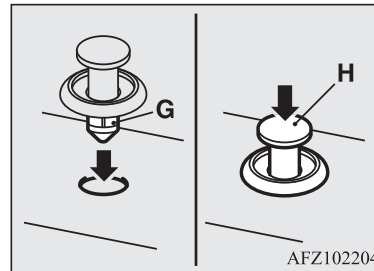

Front fog lamps*

- To create enough work space, turn the steering wheel all the way in the direction opposite to the side you wish to replace.
- Remove the screw (A), and then pull the wheel cut moulding (B) outward to release the three clips (C).

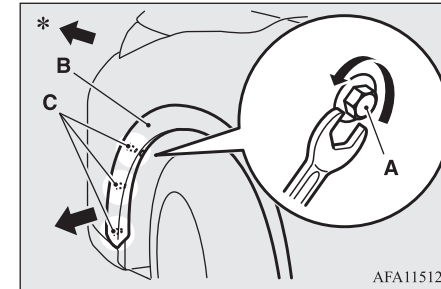

*: Front of the vehicle

CAUTION

- Do not pull the wheel cut moulding (B) more than necessary to release the three clips (C). Otherwise, the wheel cut moulding could break.

- Remove the three clips (D), and then pull back the splash shield (E).

10

Replacement of lamp bulbs

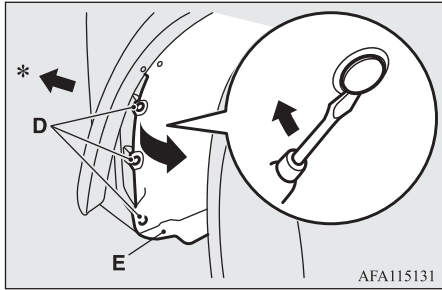

*: Front of the vehicle

4. While holding down the tab (F), pull out the socket (G).

10

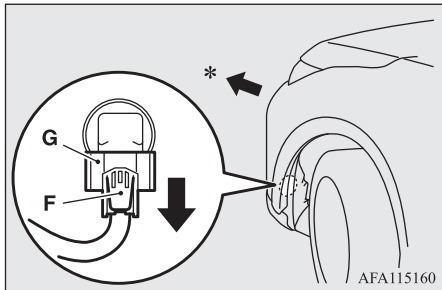

*: Front of the vehicle

5. Turn the bulb (H) anticlockwise to remove it.

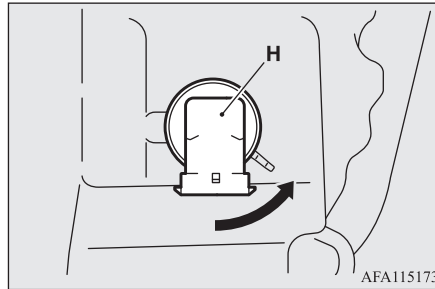

6. To install the bulb, perform the removal steps in reverse.

NOTE

- When refitting the clip (D), first insert part (I) of the clip into the hole and then press part (J) into it.

**Rear fog lamp (driver's side)/
Reversing lamp (Passenger's side)**

Except for vehicles equipped with the rear mud guard

1. Remove the three clips (A), and then pull back the splash shield (B).

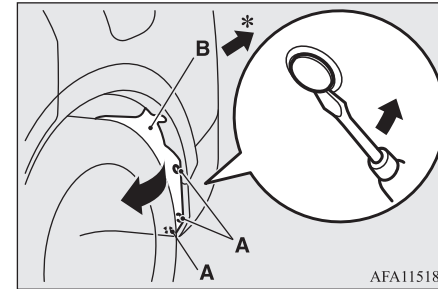

*: Rear of the vehicle

Replacement of lamp bulbs

- Turn the socket (C) anticlockwise to remove it, and then pull the bulb out of the socket.

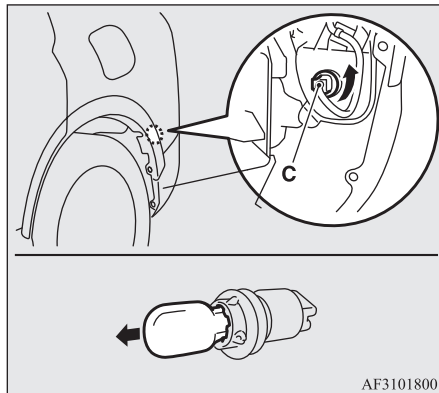

- To install the bulb, perform the removal steps in reverse.

NOTE

- Fully return the splash shield (B) to its original position in the rear bumper.

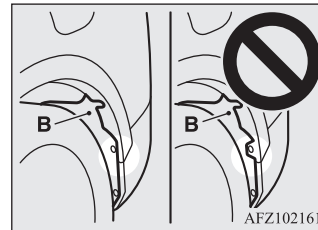

- When refitting the clip (A), first insert part (D) of the clip into the hole and then press part (E) into it.

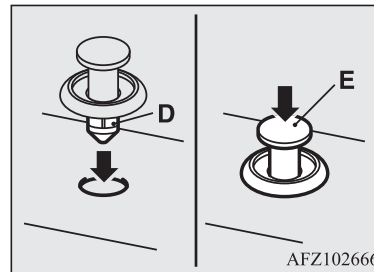

For vehicles equipped with the rear mud guard

- Remove the two bolts (A).

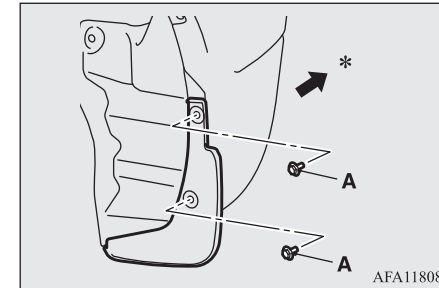

*: Rear of the vehicle

- Remove the clip (B), and then pull back the splash shield (C).

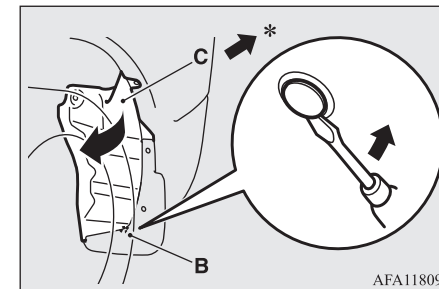

*: Rear of the vehicle

10

Replacement of lamp bulbs

3. Turn the socket (D) anticlockwise to remove it, and then pull the bulb out of the socket.

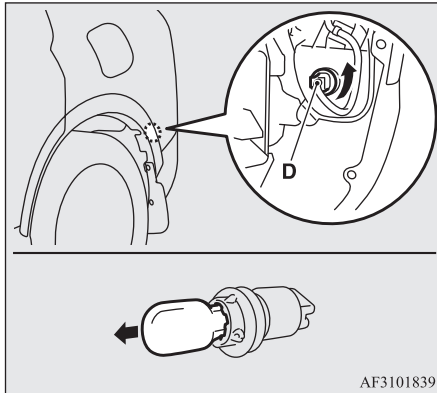

4. To install the bulb, perform the removal steps in reverse.

NOTE

- Fully return the splash shield (C) to its original position in the rear bumper.

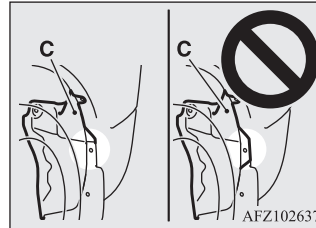

- When refitting the clip (B), first insert part (E) of the clip into the hole and then press part (F) into it.

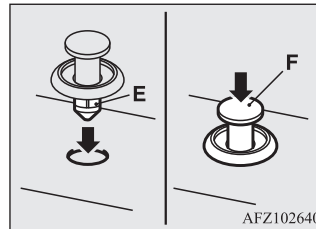

Rear combination lamps

1. Open the tailgate.
2. After removing the two screws (A), move the lamp unit rearward and remove the three lamp unit pins (B).

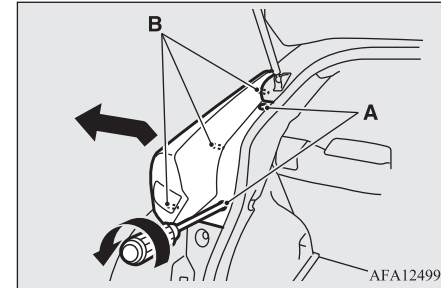

NOTE

- It will be easier to remove the lamp unit if you insert a minus screwdriver with the end covered with a cloth or other object into the space under the lamp unit and remove the highest pin, and then pull the lamp unit at an upward angle.

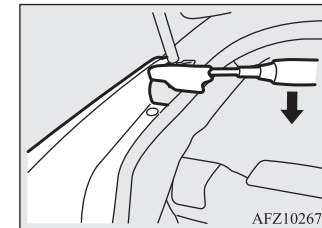

3. Turn the rear turn-signal lamp socket anticlockwise and remove it, and then pull the bulb out of the socket.

Replacement of lamp bulbs

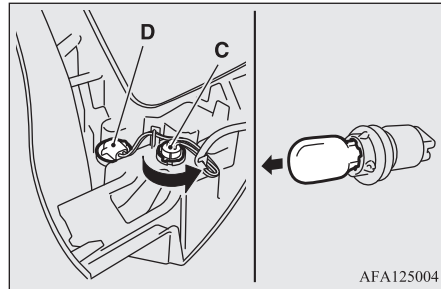

C- Rear turn-signal lamps
D- Stop lamp (LED) - cannot be replaced

NOTE

- The stop lamp use an LED instead of the bulb.
If you need to repair or replace the stop lamp, contact a MITSUBISHI MOTORS Authorized Service Point.

4. To install the bulb, perform the removal steps in reverse.

Licence plate lamps

1. Remove while pressing the lamp unit (A) to the left side of the vehicle.

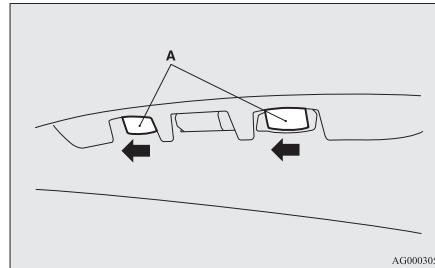

2. Insert a minus screwdriver with the end covered with a cloth or other object to press the hook (B) aside and remove the lens.

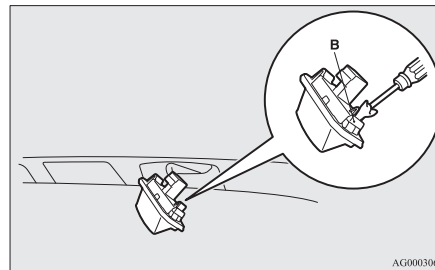

3. Remove the bulb from the socket.

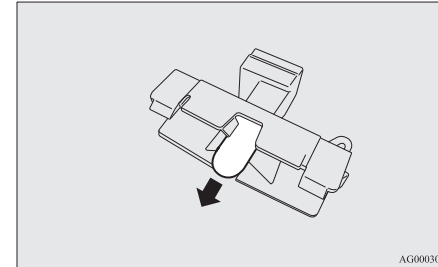

4. To install the bulb, perform the removal steps in reverse.

NOTE

- When installing the lamp unit, first insert the end of tab (C) and then align tab (D).

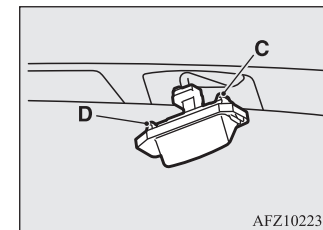

10

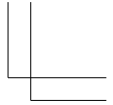
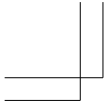

Handwriting practice lines consisting of 12 horizontal dashed lines.

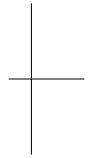
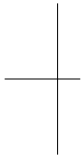

OGKE20E1

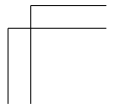
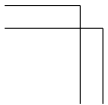

Specifications

Vehicle labelling.....	11-02
Vehicle dimensions.....	11-04
Vehicle performance.....	11-05
Vehicle weight.....	11-05
Engine specifications.....	11-09
Electrical system.....	11-10
Tyres and wheels.....	11-11
CO ₂ Mass Emissions.....	11-11
Capacity.....	11-13

OGKE20E1

Vehicle labelling

Vehicle labelling

Vehicle identification number

The vehicle identification number is stamped on the bulkhead as shown in the illustration.

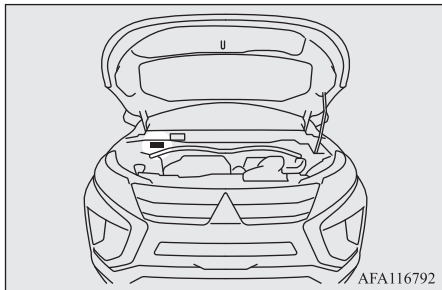

11

Vehicle information code plate

The vehicle information code plate is riveted as shown in the illustration.

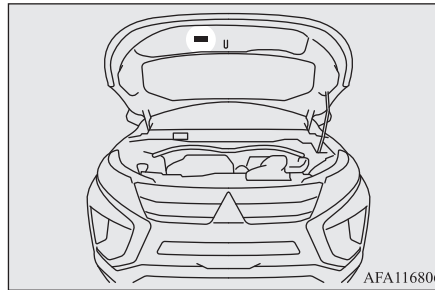

The plate shows model code, engine model, transmission model and body colour code, etc.

Please use this number when ordering replacement parts.

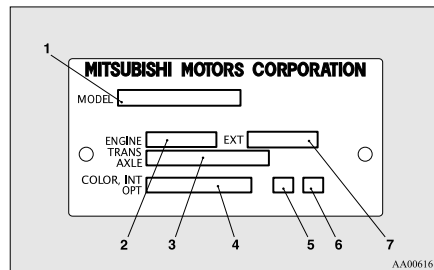

- 1- Model code
- 2- Engine model code
- 3- Transmission model code
- 4- Body colour code
- 5- Interior code
- 6- Option code
- 7- Exterior code

Vehicle identification number plate (RHD vehicles only)

The vehicle identification number is stamped on the plate riveted to the left front corner of the instrument panel pad. It is visible from outside of the vehicle through the wind-screen.

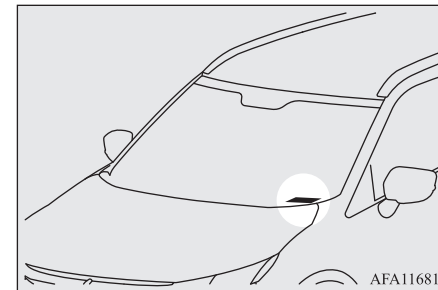

Engine model/number

The engine model and number are stamped on the engine cylinder block as shown in the illustration.

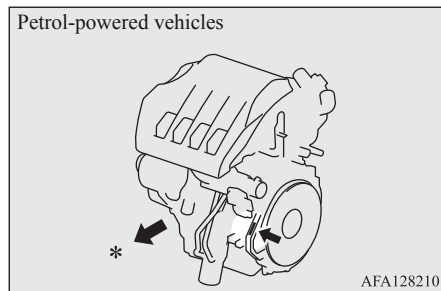

*: Front of the vehicle

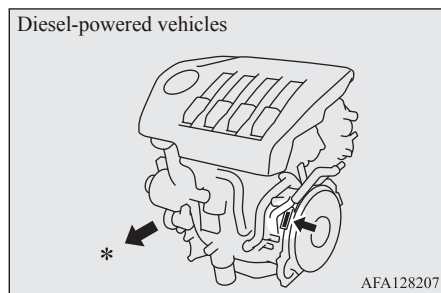

*: Front of the vehicle

Vehicle dimensions

Vehicle dimensions

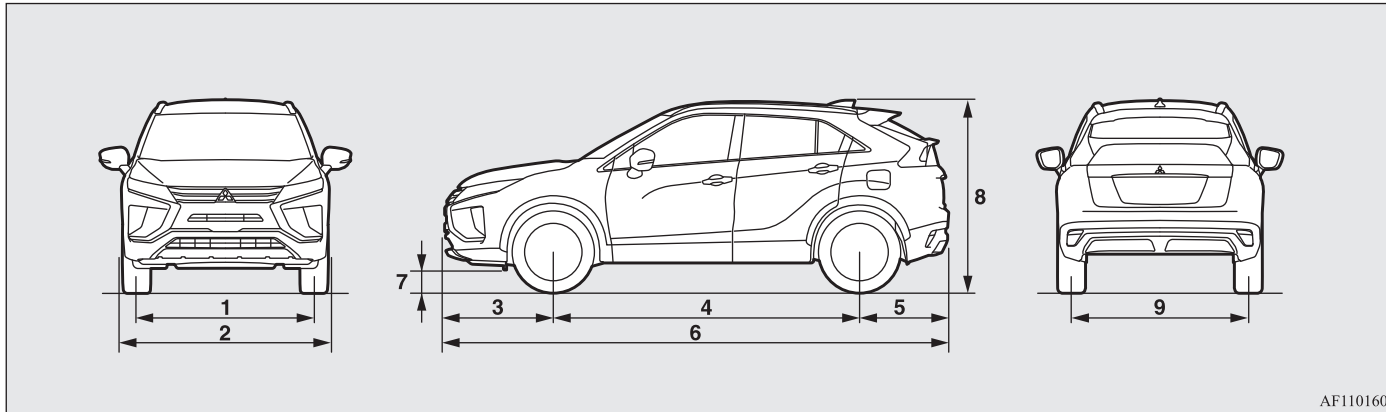

11

1	Front track	1,545 mm
2	Overall width	1,805 mm
3	Front overhang	955 mm
4	Wheel base	2,670 mm
5	Rear overhang	780 mm
6	Overall length	4,405 mm
7	Ground clearance (unladen)	183 mm
8	Overall height (unladen)	1,685 mm
9	Rear track	1,545 mm

Vehicle performance

Minimum turning radius	Body	5.7 m
	Wheel	5.3 m

Vehicle performance

Maximum speed	M/T	200 km/h (124 mph)*, 205 km/h (127 mph)
	A/T	193 km/h (120 mph)
	CVT	195 km/h (121 mph)*, 200 km/h (124 mph)

*: Vehicles for Russia, Kazakhstan, Belarus, Ukraine and Moldova

Vehicle weight

Except for vehicles for Russia, Kazakhstan, Belarus, Ukraine and Moldova

Vehicles with M/T

11

Item		GK1WXJXL6/ GK1WXJXR6	GK1WXJXL6/ GK1WXJXR6	GK1WXJXL6/ GK1WXJXR6
Seating capacity		5 persons		
Kerb weight	Without optional parts	1,425 kg	1,460 kg	1,425 kg
	With full optional parts	1,477 kg	1,542 kg	1,461 kg
Maximum gross vehicle weight		2,050 kg		
Maximum axle weight	Front	1,200 kg		
	Rear	1,160 kg		

Vehicle weight

Item		GK1WXJXL6/ GK1WXJXR6	GK1WXJXL6/ GK1WXJXR6	GK1WXJXL6/ GK1WXJXR6
Maximum towable weight	With brake	1,600 kg		
	Without brake	750 kg		
Maximum trailer-nose weight		80 kg		
Maximum gross combination weight		3,650 kg		
Maximum permissible weight of the coupling device		25 kg		
Maximum roof load		50 kg		

Vehicles with A/T

Item		GK9WXUMXL6/GK9WXUMXR6	GK9WXUHL6/GK9WXUHR6
Seating capacity		5 persons	
Kerb weight	Without optional parts	1,645 kg	1,675 kg
	With full optional parts	1,677 kg	1,740 kg
Maximum gross vehicle weight		2,300 kg	
Maximum axle weight	Front	1,200 kg	
	Rear	1,160 kg	
Maximum towable weight	With brake	2,000 kg	
	Without brake	750 kg	
Maximum trailer-nose weight		100 kg	
Maximum gross combination weight		4,300 kg	

11

Vehicle weight

Item	GK9WXUMXZL6/GK9WXUMXZR6	GK9WXUHXZL6/GK9WXUHXZR6
Maximum permissible weight of the coupling device	25 kg	
Maximum roof load	50 kg	

Vehicles with CVT

Item		GK1WXTJXL6/ GK1WXTJXR6	GK1WXTXXL6/ GK1WXTXXR6	GK1WXTSXL6/ GK1WXTSXR6	GK1WXTJXZL6/ GK1WXTJXZR6	GK1WXTXXZL6/ GK1WXTXXZR6	GK1WXTSXL6/ GK1WXTSXR6
Seating capacity		5 persons					
Kerb weight	Without optional parts	1,455 kg	1,495 kg	1,455 kg	1,520 kg	1,555 kg	1,520 kg
	With full optional parts	1,507 kg	1,579 kg	1,491 kg	1,572 kg	1,639 kg	1,556 kg
Maximum gross vehicle weight		2,150 kg					
Maximum axle weight	Front	1,200 kg					
	Rear	1,160 kg					
Maximum towable weight	With brake	1,600 kg					
	Without brake	750 kg					
Maximum trailer-nose weight		80 kg					
Maximum gross combination weight		3,750 kg					
Maximum permissible weight of the coupling device		25 kg					
Maximum roof load		50 kg					

Vehicle weight

 **NOTE**

- Vehicle usage condition should never exceed above “Maximum” values.
- Trailer specifications indicate the manufacturer’s recommendation.

Vehicles for Russia, Kazakhstan, Belarus, Ukraine and Moldova

Item		M/T		CVT			
		GK1WXJMUL 6Z	GK1WXJHUL 6Z	2WD		4WD	
				GK1WXTMUL 6Z	GK1WXTHUL 6Z	GK1WXTMUZ L6Z	GK1WXTHUZ L6Z
Seating capacity		5 persons					
Kerb weight	Without optional parts	1,430 kg	1,465 kg	1,460 kg	1,490 kg	1,525 kg	1,560 kg
	With full optional parts	1,464 kg	1,499 kg	1,501 kg	1,524 kg	1,566 kg	1,625 kg
Maximum gross vehicle weight		2,050 kg		2,100 kg			
Maximum axle weight	Front	1,200 kg					
	Rear	1,160 kg					
Maximum towable weight	With brake	1,600 kg					
	Without brake	750 kg					
Maximum trailer-nose weight		80 kg					
Maximum gross combination weight		3,730 kg		3,780 kg			
Maximum permissible weight of the coupling device		25 kg					

11

Engine specifications

Item	M/T		CVT			
	GK1WXJMUL 6Z	GK1WXJHUL 6Z	2WD		4WD	
			GK1WXTMUL 6Z	GK1WXTHUL 6Z	GK1WXTMUZ L6Z	GK1WXTHUZ L6Z
Maximum roof load	50 kg					

 **NOTE**

- Vehicle usage condition should never exceed above “Maximum” values.
- Trailer specifications indicate the manufacturer’s recommendation.

Engine specifications

Item	Petrol-powered vehicles	Diesel-powered vehicles
Engine model	4B40	4N14
No. of cylinders	4 in line	4 in line
Total displacement	1,499 cc	2,268 cc
Bore	75.0 mm	86.0 mm
Stroke	84.8 mm	97.6 mm
Camshaft	Double overhead	Double overhead
Mixture preparation	Electronic injection	Electronic direct injection
Maximum output (ECC net)	120 kW/5,500 rpm 110 kW/5,500 rpm*	109 kw/3,500 rpm

*: Vehicles for Russia, Kazakhstan, Belarus, Ukraine and Moldova

Electrical system

Item	Petrol-powered vehicles	Diesel-powered vehicles
Maximum torque (ECC net)	250 N•m/2,400 to 4,500 rpm 250 N•m/2,000 to 3,500 rpm*	388 N•m/2,000 rpm

*: Vehicles for Russia, Kazakhstan, Belarus, Ukraine and Moldova

Electrical system

Item		Except for vehicles for Russia, Kazakhstan, Belarus, Ukraine and Moldova		Vehicles for Russia, Kazakhstan, Belarus, Ukraine and Moldova
		Petrol-powered vehicles	Diesel-powered vehicles	
Voltage		12 V		
Battery	Type (JIS)	Q-85*	T-110*	75D23L
	Capacity (5HR)	55 Ah	73 Ah	52 Ah
Alternator capacity		130 A	180 A	150 A
Spark plug type	NGK	SILKR7H 8	-	SILKR7H 8

*: Vehicles equipped with Auto Stop & Go (AS&G)

NOTE

- Vehicles equipped with the Auto Stop & Go (AS&G) system have a dedicated AS&G battery type. The use of a different battery could cause the battery to run down quickly or the AS&G system not to operate normally. Please contact a MITSUBISHI MOTORS Authorized Service Point when replacing the battery.

Tyres and wheels

Tyre		215/70R16 100H	225/55R18 98H
Wheel	Size	16x6 1/2 JJ, 16x6 1/2 J	18x7J
	Offset	38 mm	

NOTE

- When replacing the tyres or wheels, refer to “Replacing tyres and wheels” on page 10-14.
- Contact your MITSUBISHI MOTORS Authorized Service Point for details on the combination used on your vehicle.

CO₂ Mass Emissions

Item		Combined	
		CO ₂ (g/km)	
		NEDC* ¹	WLTC* ²
M/T	GK1WXJXL6/GK1WXJXR6/ GK1WXJXL6/GK1WXJXR6	159	177
	GK1WXJXL6/GK1WXJXR6	154	170
A/T	GK9WXUMXL6/GK9WXUMXR6/ GK9WXUHL6/GK9WXUHL6	183	194
CVT	GK1WXTXL6/GK1WXTXR6/ GK1WXTXL6/GK1WXTXR6	162	185

*1: New European Driving Cycle

*2: Worldwide harmonized Light vehicles Test Cycle

CO₂ Mass Emissions

Item		Combined	
		CO ₂ (g/km)	
		NEDC ^{*1}	WLTC ^{*2}
	GK1WXTSXL6/GK1WXTSXR6	158	181
	GK1WXTJXZL6/GK1WXTJXZR6/ GK1WXTXXZL6/GK1WXTXXZR6	175	196
	GK1WXTSXZL6/GK1WXTSXZR6	173	190

*1: New European Driving Cycle

*2: Worldwide harmonized Light vehicles Test Cycle

NOTE

- The results given do not express or imply any guarantee of the CO₂ mass emissions of the particular vehicle. The vehicle itself has not been tested and there are inevitably differences between individual vehicles of the same model. In addition, this vehicle may incorporate particular modifications. Furthermore, the driver's style and road and traffic conditions, as well as the extent to which the vehicle has been driven and the standard of maintenance, will all affect its CO₂ mass emissions.

Capacity

Petrol-powered vehicles

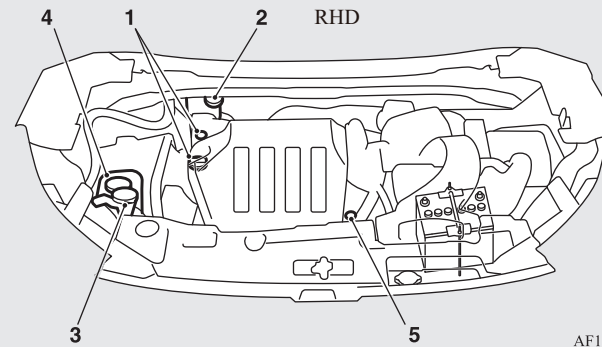
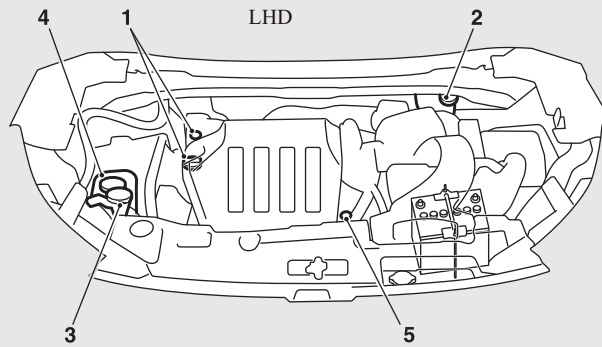

AF1101617

Diesel-powered vehicles

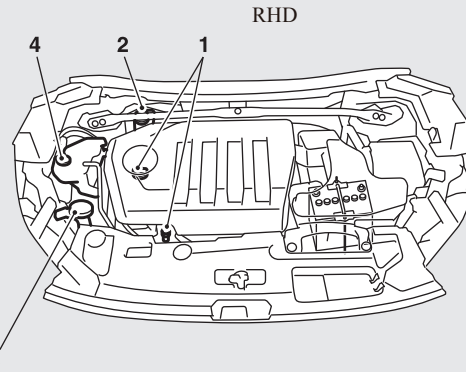
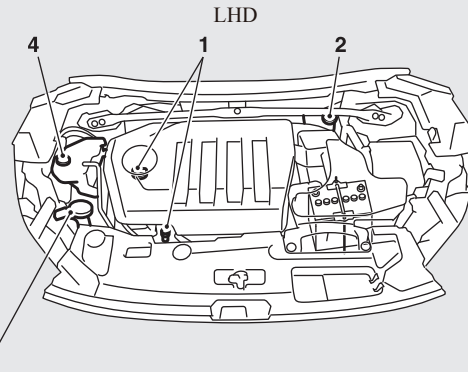

AF1102210

Capacity

No.	Item		Quantity	Lubricants	
1	Engine oil	Petrol-powered vehicles	Oil pan	4.0 litres	Refer to page 10-04.
			Oil filter	0.2 litre	
			Oil cooler	0.1 litre	
		Diesel-powered vehicles	Oil pan	5.5 litres	
			Oil filter	0.3 litre	
			Oil cooler	0.1 litre	
2	Brake fluid		As required	Brake fluid DOT3 or DOT4	
	Clutch fluid				
3	Washer fluid		4.3 litres	—	
4	Engine coolant	M/T	5.0 litres ^{*1}	MITSUBISHI MOTORS GENUINE SUPER LONG LIFE COOLANT PREMIUM or equivalent ^{*2}	
		A/T	8.0 litres ^{*3}		
		CVT	6.0 litres ^{*1}		
5	CVT fluid		7.8 litres	MITSUBISHI MOTORS GENUINE CVTF-J4	
6	Automatic transmission fluid		7.6 litres	MITSUBISHI MOTORS GENUINE ATF-MA1	

*1: Includes 0.65 litre in the reserve tank

*2: Similar high quality ethylene glycol based non-silicate, non-amine, non-nitrate and non-borate coolant with long life hybrid organic acid technology

*3: Includes 0.56 litre in the reserve tank

11

⚠ CAUTION

- Use only the MITSUBISHI MOTORS GENUINE ATF-MA1 (for the automatic transmission fluid) or MITSUBISHI MOTORS GENUINE CVTF-J4 (for the CVT fluid). Use of a different fluid could damage the transmission.

No.	Item		Quantity	Lubricants
7	Manual transmission oil		2.6 litres	MITSUBISHI MOTORS GENUINE NEW MULTI GEAR OIL ECO API GL-4, SAE 75W-80
8	Transfer oil		0.5 litre	MITSUBISHI MOTORS GENUINE Super Hypoid Gear Oil API GL-5 SAE 80
9	Rear differential oil		0.4 litre	
10	Refrigerant (air conditioning)	Except for vehicles for Russia, Kazakhstan, Belarus, Ukraine and Moldova	430 - 470 g	HFO-1234yf
		Vehicles for Russia, Kazakhstan, Belarus, Ukraine and Moldova		HFC-134a

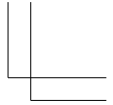
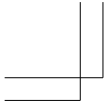

Handwriting practice lines consisting of 12 horizontal dashed lines.

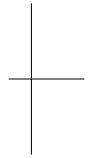
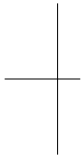

OGKE20E1

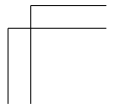
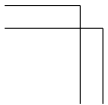

4

4-wheel drive operation..... 6-53

8

8-speed Automatic transmission with Sports Mode*..... 6-36

8-speed Automatic transmission with Sports Mode* and INVECS-III CVT with 8-step Sports Mode*..... 1-18

A

Accessory (Installation)..... 2-11

Accessory socket..... 7-80

Active stability control (ASC)..... 6-66

Adaptive Cruise Control System (ACC)..... 6-78

AdBlue™ replenishment..... 10-11

Air conditioning

Automatic air conditioning..... 7-05

Customizing the air conditioning..... 7-15

Dual-zone automatic climate control air conditioning..... 7-10

Important air conditioning operation tips..... 7-02

Air purifier..... 7-22

Airbag..... 4-26

Caution for installing the child restraint in vehicles with front passenger's airbag..... 4-15,4-29

Curtain airbag system..... 4-34

Driver's and front passenger's airbag system..... 4-31

Driver's knee airbag system..... 4-31

How the Supplemental Restraint

System works..... 4-27

Side airbag system..... 4-34

SRS warning lamp/display..... 4-37

Anti-lock brake system (ABS)..... 6-63

Warning display..... 6-64

Warning lamp..... 6-64

Armrest..... 4-03,4-04

Ashtray..... 7-79

Assist grips..... 7-87

Audio

CD player..... 7-22

LW/MW/FM radio..... 7-22

Troubleshooting..... 7-54

Auto Stop & Go (AS&G) system..... 6-30

Automatic air conditioning..... 7-05

Automatic High-Beam (AHB)..... 5-59

Automatic transmission

Fluid..... 11-13

Selector lever operation..... 6-37,6-43

Selector lever positions..... 6-46

Sports mode..... 6-39,6-46

B

Battery..... 10-09

Charge warning lamp..... 5-49

Discharged battery (Emergency starting)..... 8-08

Disposal information for used batteries..... 2-12

Specification..... 11-10

Blind Spot Warning (BSW) (with Lane Change Assist)..... 6-107

Bluetooth® 2.0 interface..... 7-56

Bonnet..... 10-03

Bottle holder..... 7-85

Alphabetical index

Brake assist system..... 6-61

Brake

Anti-lock brake system (ABS)..... 6-63

Brake auto hold..... 6-57

Braking..... 6-56

Electric parking brake..... 6-05

Fluid..... 10-08,11-13

Parking brake..... 6-04

Warning display..... 6-64

Warning lamp..... 6-64

C

Capacities..... 11-13

Card holder..... 7-78,7-84

Cargo area cover..... 7-86

Cargo loads..... 6-140

Catalytic converter*..... 10-03

Caution for installing the child restraint on vehicle with front passenger's airbag..... 4-29

Cautions on handling of 4-wheel drive vehicles..... 6-55

CD player..... 7-22

Central door locks..... 3-18

Charge warning lamp..... 5-49

Check engine warning lamp..... 5-48

Child restraint..... 4-15

Booster seat..... 4-22

Caution for installing the child restraint in vehicles with front passenger's airbag..... 4-15,4-29

Child restraint system with ISOFIX

mountings..... 4-23

Lower anchorage location..... 4-23

Alphabetical index

Suitability for various ISOFIX positions.....	4-18
Suitability for various seating positions.....	4-21
Tether anchorage locations.....	4-23
Child-protection rear doors.....	3-20

Cleaning

Exterior of your vehicle.....	9-03
Interior of your vehicle.....	9-02

Clutch

Fluid.....	10-08,11-13
------------	-------------

CO2 Mass Emissions	11-11
--------------------------	-------

Coat hook.....	7-88
----------------	------

Combination headlamps and dipper switch.....	5-56
--	------

Coolant (engine).....	10-06,11-13
-----------------------	-------------

Cruise control.....	6-69
---------------------	------

Customizing the air conditioning.....	7-15
---------------------------------------	------

D

Daytime running lamps.....	5-58
----------------------------	------

Bulb capacity and location.....	10-25
---------------------------------	-------

Demister (rear window).....	5-72
-----------------------------	------

Demisting.....	7-06,7-11
----------------	-----------

Diesel particulate filter (DPF).....	6-27
--------------------------------------	------

Diesel preheat indication lamp.....	5-47
-------------------------------------	------

Digital clock

Time Setting.....	7-50
-------------------	------

Dimensions.....	11-04
-----------------	-------

Dipper (High/Low beam change).....	5-59
------------------------------------	------

Doors

Central door locks.....	3-18
-------------------------	------

Child-protection.....	3-20
-----------------------	------

Dead Lock System.....	3-19
-----------------------	------

DPF.....	6-27
----------	------

Driving, alcohol and drugs.....	6-02
---------------------------------	------

Dual-zone automatic climate control air conditioning.....	7-10
--	------

E

Economical driving.....	6-02
-------------------------	------

Electric parking brake.....	6-05
-----------------------------	------

Electric power steering system (EPS).....	6-65
---	------

Electric window control.....	3-30
------------------------------	------

Safety mechanism.....	3-32
-----------------------	------

Switch.....	3-30
-------------	------

Timer function.....	3-32
---------------------	------

Electrical system.....	11-10
------------------------	-------

Electronic immobilizer (Anti-theft starting system).....	3-03
---	------

Emergency key.....	3-16
--------------------	------

Emergency starting.....	8-08
-------------------------	------

Emergency stop signal system.....	6-63
-----------------------------------	------

Engine specifications.....	11-09
----------------------------	-------

Engine switch.....	6-15
--------------------	------

Engine

Coolant.....	10-06,11-13
--------------	-------------

Number.....	11-02
-------------	-------

Oil.....	10-04
----------	-------

Oil and oil filter.....	11-13
-------------------------	-------

Overheating.....	8-10
------------------	------

Safety and disposal information for used engine oil.....	2-12
---	------

Specifications.....	11-09
---------------------	-------

ERA-GLONASS.....	8-02
------------------	------

Event Data Recording.....	2-13
---------------------------	------

Exterior and interior lamp operation.....	10-19
---	-------

F

Fluid capacities and lubricants.....	11-13
--------------------------------------	-------

Fluid

Automatic transmission fluid.....	11-13
-----------------------------------	-------

Brake fluid.....	10-08,11-13
------------------	-------------

Clutch fluid.....	10-08,11-13
-------------------	-------------

CVT fluid.....	11-13
----------------	-------

Engine coolant.....	10-06,11-13
---------------------	-------------

Washer fluid.....	10-08,11-13
-------------------	-------------

Forward Collision Mitigation System (FCM).....	6-91
--	------

Front fog lamps

Bulb capacity and location.....	10-25
---------------------------------	-------

Replacement.....	10-29
------------------	-------

Switch.....	5-67
-------------	------

Front room lamp

Bulb capacity and location.....	10-27
---------------------------------	-------

Front seats.....	4-02
------------------	------

Front turn-signal lamps

Bulb capacity and location.....	10-25
---------------------------------	-------

Replacement.....	10-28
------------------	-------

Fuel

Filling the fuel tank.....	2-03
----------------------------	------

Fuel remaining display screen.....	5-07
------------------------------------	------

Fuel remaining warning display.....	5-08
-------------------------------------	------

Fuel selection.....	2-02
---------------------	------

Modification/alterations to the electrical or fuel systems.....	2-12
--	------

Tank capacity.....	2-03
--------------------	------

Fuses.....	10-20
------------	-------

Fusible links.....	10-19
--------------------	-------

G

Gasoline particulate filter (GPF)*.....	6-26
---	------

General maintenance.....	10-19
General vehicle data.....	11-04
Genuine parts.....	2-12
Glove box.....	7-84

H

Hazard warning flasher switch.....	5-65
Hazard warning indication lamps.....	5-47
Head restraints.....	4-05
Head Up Display (HUD).....	5-51
Headlamp levelling switch.....	5-63
Headlamp washer switch.....	5-72
Headlamps	
Bulb capacity and location.....	10-25
Headlamp flasher.....	5-59
Replacement.....	10-27
Switch.....	5-56
Heated mirror.....	6-13
Heated seats.....	4-04
Heated steering wheel switch.....	5-74
Heated windscreen switch.....	5-73
High-mounted stop lamp	
Bulb capacity and location.....	10-25
Hill start assist.....	6-60
Hinges and latches lubrication.....	10-19
Horn switch.....	5-74

I

i-Size child restraint system.....	4-20
If the vehicle breaks down.....	8-08
Ignition switch.....	6-14

Important air conditioning operation tips.....	7-02
Indication and warning lamps.....	5-21
Indication lamps.....	5-47
Information screen.....	5-04
Inside rear-view mirror.....	6-10
Inspection and maintenance following rough road operation.....	6-55
Instruments.....	5-02
Interior lamps.....	7-80

J

Jack.....	8-12
Storage.....	8-11
Jump starting (Emergency starting).....	8-08

K

Key number tag.....	3-02
Keyless entry system.....	3-04
Keyless operation system.....	3-08
Emergency key.....	3-16
Warning activation.....	3-14
Keys.....	3-02

L

Labeling.....	11-02
Lamp monitor buzzer.....	5-58
Lane Departure Warning (LDW).....	6-113
Leakage (Fuel, engine coolant, oil and exhaust gas).....	10-19
LED headlamp warning lamp.....	5-58
LED interior illumination (Front door).....	7-83

Alphabetical index

LED interior illumination (Front drink holder).....	7-82
Bulb capacity and location.....	10-27
LED interior illumination (Smartphone tray).....	7-83
Bulb capacity and location.....	10-27
Licence plate lamps	
Bulb capacity and location.....	10-25
Replacement.....	10-33
Link System*.....	7-56
Locking and unlocking the doors.....	3-16
Lubricants.....	11-13
Luggage floor board.....	7-89
Luggage hooks.....	7-88
Luggage room lamp.....	7-82
Bulb capacity and location.....	10-27
LW/MW/FM radio.....	7-22

M

Making a luggage area.....	4-07
Manual transmission.....	6-35
Manual transmission oil.....	11-13
Map lamps.....	7-82
Bulb capacity and location.....	10-27
Meter illumination control.....	5-02
Mirror	
Inside rear-view mirror.....	6-10
Outside rear-view mirrors.....	6-11
Modification/alterations to the electrical systems.....	2-12
Multi Around Monitor.....	6-131
Multi-information display.....	5-02

Alphabetical index

O

Oil

Engine oil.....	10-04, 11-13
Manual transmission oil.....	11-13
Rear differential oil.....	11-13
Transfer oil.....	11-13
Operation under adverse driving conditions.....	8-30
Outside rear-view mirrors.....	6-11
Overheating.....	8-10

P

Parking sensors (Front/Rear).....	6-124
Parking.....	6-08
Electric parking brake.....	6-05
Parking brake.....	6-04
Position lamps	
Bulb capacity and location.....	10-25
Power panoramic sunroof.....	3-33
Precautions to observe when using wipers and washers.....	5-72
Pregnant women restraint.....	4-14
Puncture (Tyre changing).....	8-19
Puncture	
Tyre repair kit.....	8-13

R

Rear combination lamps	
Bulb capacity and location.....	10-26
Replacement.....	10-32
Rear Cross Traffic Alert (RCTA).....	6-111
Rear differential oil.....	11-13

Rear fog lamp

Bulb capacity and location.....	10-25
Replacement.....	10-30
Switch.....	5-67

Rear room lamp

Bulb capacity and location.....	10-27
---------------------------------	-------

Rear turn-signal lamps

Bulb capacity and location.....	10-25
Replacement.....	10-28, 10-32
Rear window demister switch.....	5-72

Rear-view camera.....

Rear-view mirror

Inside.....	6-10
Outside.....	6-11
Refill capacities.....	11-13

Replacement of lamp bulbs.....

Reversing lamps

Bulb capacity and location.....	10-25
Replacement.....	10-32
Roof carrier precaution.....	6-140

Room lamps.....

Running-in recommendations.....

S

S-AWC (Super All Wheel Control)*.....

Safe driving techniques.....

Safety and disposal information for used engine oil.....

Seat belt.....

Adjustable seat belt anchor.....	4-11
Child restraint.....	4-15
Force limiter.....	4-15
Inspection.....	4-26
Pregnant women restraint.....	4-14

Pretensioner.....	4-14
Seat belt reminder.....	4-10

Seat

Adjustment.....	4-02
Front seats.....	4-02
Head restraints.....	4-05
Heated seats.....	4-04
Making a luggage area.....	4-07
Rear seat.....	4-03
Security alarm system*.....	3-23
Service precaution.....	10-02

Side turn-signal lamps

Bulb capacity and location.....	10-25
Snow traction device (Tyre chains).....	10-16

Snow tyres.....

Spare wheel.....

Spark plug.....

Specifications.....

Speed Limiter.....

Starting and stopping the engine.....

Steering

Steering wheel height adjustment.....	6-09
Steering wheel lock.....	6-18

Stop lamps

Bulb capacity and location.....

Storage spaces.....

Sun visors.....

Sunroof.....

Supplemental restraint system.....

Caution for installing the child re- straint in vehicles with front pas- senger's airbag.....	4-15
How the Supplemental Restraint System works.....	4-27

Servicing.....	4-38
SRS warning lamp/display.....	4-37
System check screen.....	5-10

T

Tail lamps	
Bulb capacity and location.....	10-25
Telematics Control Unit (TCU).....	2-05
Ticket holder.....	7-79
Time Setting.....	7-50
Tools.....	8-12
Storage.....	8-11
Towing.....	8-26
Traffic Sign Recognition (TSR).....	6-117
Trailer towing.....	6-141
Transfer oil.....	11-13
Transmission	
Automatic transmission.....	1-18,6-36,6-43
Manual transmission.....	6-35
Turbocharger operation.....	6-30
Turn-signal indication lamps.....	5-47
Turn/Lane-change signals.....	5-65
Tyre pressure monitoring system (TPMS).....	6-119
Tyre repair kit.....	8-13
Tyres.....	10-13
How to change a tyre.....	8-19
Inflation pressures.....	10-13
Rotation.....	10-15
Size (tyre and wheel).....	11-11
Snow traction device (Tyre chains).....	10-16
Snow tyres.....	10-16
Tyre repair kit.....	8-13
Wheel condition.....	10-14

U

Ultrasonic misacceleration Mitigation System (UMS).....		6-102
Urea SCR system (AdBlue™-related system).....		6-28
USB input terminal.....		7-76
How to connect a USB memory device.....	7-76	
How to connect an iPod.....	7-77	

V

Vanity mirror.....	7-78
Vanity mirror lamp	
Bulb capacity.....	10-27
Vehicle care precautions.....	9-02
Vehicle dimensions.....	11-04
Vehicle identification number.....	11-02
Vehicle information code plate (RHD vehicles only).....	11-02
Vehicle labeling.....	11-02
Vehicle performance.....	11-05
Vehicle weight.....	11-05
Ventilators.....	7-02

W

Warning lamps.....	5-47
Washer	
Fluid.....	10-08,11-13
Switch.....	5-71,5-72
Washing.....	9-03
Waxing.....	9-04
Weight.....	11-05

Alphabetical index

Wheel condition.....	10-14
Wheel	
Covers.....	8-25
Specification.....	11-11
Wiper	
Rear window.....	5-71
Windscreen.....	5-68
Wiper blade rubber replacement.....	10-17

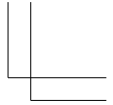
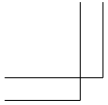

Handwriting practice lines consisting of 12 horizontal dashed lines.

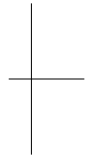
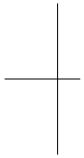

OGKE20E1

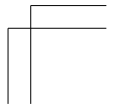
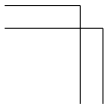

A) Generic information:

Manufacturer Postal Address

ADC Automotive Distance Control Systems GmbH
Peter-Dornier-Strasse 10, 88131 Lindau, Germany

B) Language Text:

01_RED_BG_Bulgarian	
ОПРОСТЕНА ЕС ДЕКЛАРАЦИЯ ЗА СЪОТВЕТСТВИЕ	С настоящото ADC Automotive Distance Control Systems GmbH декларира, че този тип радиосъоръжение ARS 4-A е в съответствие с Директива 2014/53/ЕС. Цялостният текст на ЕС декларацията за съответствие може да се намери на следния интернет адрес: http://continental.automotive-approvals.com/ радиочестотната лента или ленти, в която или които работи радиосъоръжението: 76–77 GHz максималната радиочестотна мощност, излъчвана в радиочестотната лента или ленти, в която или които работи радиосъоръжението.: 3.16W (35dBm RMS EIRP)
02_RED_ES_Spanish	
DECLARACIÓN UE DE CONFORMIDAD SIMPLIFICADA	Por la presente, ADC Automotive Distance Control Systems GmbH declara que el tipo de equipo radioeléctrico ARS 4-A es conforme con la Directiva 2014/53/UE. El texto completo de la declaración UE de conformidad está disponible en la dirección Internet siguiente: http://continental.automotive-approvals.com/ Banda o bandas de frecuencia en las que opera el equipo radioeléctrico: 76–77 GHz Potencia máxima de radiofrecuencia transmitida en la banda o bandas de frecuencia en las que opera el equipo radioeléctrico: 3.16W (35dBm RMS EIRP)

03_RED_CS_Czech	Tímto ADC Automotive Distance Control Systems GmbH prohlašuje, že typ rádiového zařízení ARS 4-A je v souladu se směrnicí 2014/53/EU. Úplné znění EU prohlášení o shodě je k dispozici na této internetové adrese: http://continental.automotive-approvals.com/
ZJEDNODUŠENÉ EU PROHLÁŠENÍ O SHODĚ	Kmitočtové pásmo (kmitočtová pásma), v němž (v nichž) rádiové zařízení pracuje: 76–77 GHz Maximální radiofrekvenční výkon vysílaný v kmitočtovém pásmu (v kmitočtových pásmech), v němž (v nichž) je rádiové zařízení provozováno: 3.16W (35dBm RMS EIRP)
04_RED_DA_Danish	Hermed erklærer ADC Automotive Distance Control Systems GmbH, at radioudstyrstypen ARS 4-A er i overensstemmelse med direktiv 2014/53/EU. EUoverensstemmelseserklæringens fulde tekst kan findes på følgende internetadresse: http://continental.automotive-approvals.com/
FORENKLET EUOVERENSSTEMMELSE SERKLÆRING	Frekvensbånd, som radioudstyret fungerer på: 76–77 GHz Maksimal radiofrekvensseffekt, der udsendes i de frekvensbånd, som radioudstyret fungerer på: 3.16W (35dBm RMS EIRP)
05_RED_DE_German	Hiermit erklärt ADC Automotive Distance Control Systems GmbH, dass der Funkanlagentyp ARS 4-A der Richtlinie 2014/53/EU entspricht. Der vollständige Text der EU-Konformitätserklärung ist unter der folgenden Internetadresse verfügbar: http://continental.automotive-approvals.com/
VEREINFACHTE EUKONFORMITÄT SERKLÄRUNG	Das Frequenzband oder die Frequenzbänder, in dem bzw. denen die Funkanlage betrieben wird: 76–77 GHz Die in dem Frequenzband oder den Frequenzbändern, in

	dem bzw. denen die Funkanlage betrieben wird, abgestrahlte maximale Sendeleistung: 3.16W (35dBm RMS EIRP)
06_RED_ET_Estonian LIHTSUSTATUD ELI VASTAVUSDEKLARAT SIOON	Käesolevaga deklareerib ADC Automotive Distance Control Systems GmbH, et käesolev raadioseadme tüüp ARS 4-A vastab direktiivi 2014/53/EL nõuetele. ELi vastavusdeklaratsiooni täielik tekst on kättesaadav järgmisel internetiaadressil: http://continental.automotive-approvals.com/ Sagedusriba(d), millel raadioseade töötab: 76–77 GHz Raadioseadme töösagedus(t)el edastatav maksimaalne saatevõimsus: 3.16W (35dBm RMS EIRP)
07_RED_EL_Greek ΑΠΛΟΥΣΤΕΥΜΕΝΗ ΔΗΛΩΣΗ ΣΥΜΜΟΡΦΩΣΗΣ ΕΕ	Με την παρούσα ο/η ADC Automotive Distance Control Systems GmbH, δηλώνει ότι ο ραδιοεξοπλισμός ARS 4-A πληροί την οδηγία 2014/53/ΕΕ. Το πλήρες κείμενο της δήλωσης συμμόρφωσης ΕΕ διατίθεται στην ακόλουθη ιστοσελίδα στο διαδίκτυο: http://continental.automotive-approvals.com/ Οι ζώνες συχνοτήτων στις οποίες λειτουργεί ο ραδιοεξοπλισμός: 76–77 GHz η μέγιστη ραδιοηλεκτρική ισχύς στις ζώνες συχνοτήτων στις οποίες λειτουργεί ο ραδιοεξοπλισμός: 3.16W (35dBm RMS EIRP)
08_RED_EN_English SIMPLIFIED EU DECLARATION OF CONFORMITY	Hereby, ADC Automotive Distance Control Systems GmbH declares that the radio equipment type ARS 4-A is in compliance with Directive 2014/53/EU. The full text of the EU declaration of conformity is available at the following internet address: http://continental.automotive-approvals.com/ Frequency band(s) in which the radio equipment operates:

	76-77 GHz
	Maximum radio-frequency power transmitted in the frequency band(s) in which the radio equipment operates: 3.16W (35dBm RMS EIRP)
09_RED_FR_French	
DECLARATION UE DE CONFORMITE SIMPLIFIEE	Le soussigné, ADC Automotive Distance Control Systems GmbH, déclare que l'équipement radioélectrique du type ARS 4-A est conforme à la directive 2014/53/UE. Le texte complet de la déclaration UE de conformité est disponible à l'adresse internet suivante: http://continental.automotive-approvals.com/
	Bandes de fréquences utilisées par l'équipement radioélectrique: 76-77 GHz
	Puissance de radiofréquence maximale transmise sur les bandes de fréquences utilisées par l'équipement radioélectrique: 3.16W (35dBm RMS EIRP)
10_RED_GA_empty_no_text	
Related RED Directive not released.	
11_RED_HR_Croatian	
POJEDNOSTAVLJENA EU IZJAVA O SUKLADNOSTI	ADC Automotive Distance Control Systems GmbH ovime izjavljuje da je radijska oprema tipa ARS 4-A u skladu s Direktivom 2014/53/EU. Cjeloviti tekst EU izjave o sukladnosti dostupan je na sljedećoj internetskoj adresi: http://continental.automotive-approvals.com/
	Frekvencijski pojas (frekvencijski pojas) u kojem (kojima) radijska oprema radi: 76-77 GHz
	Najveća radiofrekvencijska snaga koja se prenosi u frekvencijskom pojasu (frekvencijskim pojasima) u kojem (kojima) radijska oprema radi: 3.16W (35dBm RMS EIRP)
12_RED_IT_Italian	

DICHIARAZIONE DI CONFORMITÀ UE SEMPLIFICATA	<p>Il fabbricante, ADC Automotive Distance Control Systems GmbH, dichiara che il tipo di apparecchiatura radio ARS 4-A è conforme alla direttiva 2014/53/UE. Il testo completo della dichiarazione di conformità UE è disponibile al seguente indirizzo Internet: http://continental.automotive-approvals.com/</p> <p>Bande di frequenza di funzionamento dell'apparecchiatura radio: 76–77 GHz</p> <p>Massima potenza a radiofrequenza trasmessa nelle bande di frequenza in cui opera l'apparecchiatura radio: 3.16W (35dBm RMS EIRP)</p>
13_RED_LV_Latvian	
VIENKĀRŠOTA ES ATBILSTĪBAS DEKLARĀCIJA	<p>Ar šo ADC Automotive Distance Control Systems GmbH deklarē, ka radioiekārta ARS 4-A atbilst Direktīvai 2014/53/ES. Pilns ES atbilstības deklarācijas teksts ir pieejams šādā interneta vietnē: http://continental.automotive-approvals.com/</p> <p>Frekvenču joslu(-as), kurā(-ās) radioiekārta darbojas: 76–77 GHz</p> <p>Frekvenču joslā(-ās), kurā(-ās) darbojas radioiekārta, maksimālo pārraidītā signāla jaudu.: 3.16W (35dBm RMS EIRP)</p>
14_RED_LT_Lithuanian	
SUPAPRASTINTA ES ATITIKTIES DEKLARACIJA	<p>Aš, ADC Automotive Distance Control Systems GmbH, patvirtinu, kad radijo įrenginių tipas ARS 4-A atitinka Direktyvą 2014/53/ES. Visas ES atitikties deklaracijos tekstas prieinamas šiuo interneto adresu: http://continental.automotive-approvals.com/</p> <p>Dažnių juosta (-os), kurioje (-iose) veikia radijo įrenginiai: 76–77 GHz</p> <p>Didžiausia radijo dažnių galia, perduodama toje (tose) dažnių juostoje (-ose), kurioje (-iose) veikia radijo įrenginiai: 3.16W (35dBm RMS EIRP)</p>
15_RED_HU_Hungarian	
EGYSZERŰSÍTETT	ADC Automotive Distance Control Systems GmbH igazolja,

EUMEGFELELŐSÉGI NYILATKOZAT	<p>hogy a ARS 4-A típusú rádióberendezés megfelel a 2014/53/EU irányelvnek. Az EU-megfelelőségi nyilatkozat teljes szövege elérhető a következő internetes címen: http://continental.automotive-approvals.com/</p>
	<p>Az(ok) a frekvenciasáv(ok), amely(ek)en a rádióberendezés működik: 76–77 GHz</p>
	<p>Az abban a frekvenciasávban vagy azokban a frekvenciasávokban továbbított maximális jelerősség, amely(ek)ben a rádióberendezés üzemel: 3.16W (35dBm RMS EIRP)</p>
16_RED_MT_Maltese	
<p>DIKJARAZZJONI SSIMPLIFIKATA TA' KONFORMITÀ TAL-JE</p>	<p>B'dan, ADC Automotive Distance Control Systems GmbH, niddikjara li dan it-tip ta' tagħmir tar-radju ARS 4-A huwa konformi mad-Direttiva 2014/53/UE. It-test kollu taddikjarazzjoni ta' konformità tal-JE huwa disponibbli f'dan l-indirizz tal-Internet li ġej: http://continental.automotive-approvals.com/</p>
	<p>Il-medda/meded tal-frekwenza li jaħdem fihom it-tagħmir tar-radju: 76–77 GHz</p>
	<p>Il-potenza massima tal-frekwenza tar-radju trażmessa fil-medda/meded tal-frekwenza li jaħdem fihom it-tagħmir tar-radju: 3.16W (35dBm RMS EIRP)</p>
17_RED_NL_Dutch	
<p>VEREENVOUDIGDE EUCONFORMITEITSVERK LARING</p>	<p>Hierbij verklaar ik, ADC Automotive Distance Control Systems GmbH, dat het type radioapparaat ARS 4-A conform is met Richtlijn 2014/53/EU. De volledige tekst van de EU-conformiteitsverklaring kan worden geraadpleegd op het volgende internetadres: http://continental.automotive-approvals.com/</p>
	<p>Frequentieband(en) waarin de radioapparaatuur functioneert: 76–77 GHz</p>
	<p>Maximaal radiofrequent vermogen uitgezonden in de frequentieband(en) waarin de radioapparaatuur functioneert:</p>

	3.16W (35dBm RMS EIRP)
18_RED_PL_Polish	
UPROSZCZONA	ADC Automotive Distance Control Systems GmbH
DEKLARACJA	niniejszym oświadcza, że typ urządzenia radiowego ARS
ZGODNOŚCI UE	4-A jest zgodny z dyrektywą 2014/53/UE. Pełny tekst deklaracji zgodności UE jest dostępny pod następującym adresem internetowym: http://continental.automotive-approvals.com/
	Zakres(-ów) częstotliwości, w którym (których) pracuje urządzenie radiowe: 76–77 GHz
	Maksymalnej mocy częstotliwości radiowej emitowanej w zakresie(-ach) częstotliwości, w którym (których) pracuje urządzenie radiowe: 3.16W (35dBm RMS EIRP)
19_RED_PT_Portuguese	
DECLARAÇÃO UE DE CONFORMIDADE SIMPLIFICADA	O(a) abaixo assinado(a) ADC Automotive Distance Control Systems GmbH declara que o presente tipo de equipamento de rádio ARS 4-A está em conformidade com a Diretiva 2014/53/UE. O texto integral da declaração de conformidade está disponível no seguinte endereço de Internet: http://continental.automotive-approvals.com/
	A(s) banda(s) de frequências em que o equipamento de rádio funciona: 76–77 GHz
	A potência máxima de radiofrequências transmitida na(s) banda(s) de frequências em que o equipamento de rádio funciona: 3.16W (35dBm RMS EIRP)
20_RED_RO_Romanian	
DECLARAȚIA UE DE CONFORMITATE SIMPLIFICATĂ	Prin prezenta, ADC Automotive Distance Control Systems GmbH declară că tipul de echipament radio ARS 4-A este în conformitate cu Directiva 2014/53/UE. Textul integral al declarației UE de conformitate este disponibil la următoarea adresă internet:

	http://continental.automotive-approvals.com/
	Banda (benzile) de frecvențe în care funcționează echipamentul radio: 76-77 GHz
	Putea maximă de radiofrecvență transmisă în banda (benzile) de frecvențe în care funcționează echipamentul radio: 3.16W (35dBm RMS EIRP)
21_RED_SK_Slovak	
ZJEDNODUŠENÉ EÚ	ADC Automotive Distance Control Systems GmbH týmto vyhlasuje, že rádiové zariadenie typu ARS 4-A je v súlade so smernicou 2014/53/EÚ. Úplné EÚ vyhlásenie o zhode je k dispozícii na tejto internetovej adrese: http://continental.automotive-approvals.com/
VYHLÁSENIE O ZHODE	Frekvenčné pásmo resp. pásma, v ktorých rádiové zariadenie pracuje: 76-77 GHz
	Maximálny vysokofrekvenčný výkon prenášaný vo frekvenčnom pásme, resp. pásmach, v ktorých rádiové zariadenie pracuje: 3.16W (35dBm RMS EIRP)
22_RED_SL_Slovenian	
POENOSTAVLJENA	ADC Automotive Distance Control Systems GmbH potrjuje, da je tip radijske opreme ARS 4-A skladen z Direktivo 2014/53/EU. Celotno besedilo izjave EU o skladnosti je na voljo na naslednjem spletnem naslovu: http://continental.automotive-approvals.com/
IZJAVA EU O SKLADNOSTI	Frekvenčni pas ali pasovi, na katerih deluje radijska oprema: 76-77 GHz
	Največja energija za radijsko frekvenco, preneseno po frekvenčnem pasu ali pasovih, na katerih radijska oprema deluje: 3.16W (35dBm RMS EIRP)
23_RED_FL_Finnish	
YKSINKERTAISTETTU	ADC Automotive Distance Control Systems GmbH vakuuttaa, että radiolaitetyyppi ARS 4-A on direktiivin
EUVAAITIMUSTENMUKAISU	

USVAKUUTUS	2014/53/EU mukainen. EUvaatimustenmukaisuusvakuutuksen täysimittainen teksti on saatavilla seuraavassa internetosoitteessa: http://continental.automotive-approvals.com/
	Radiotaajuudet, joilla radiolaitte toimii: 76–77 GHz
	Suurin mahdollinen lähetysteho radiotaajuuksilla, joilla radiolaitte toimii: 3.16W (35dBm RMS EIRP)
24_RED_SV_Swedish	
FÖRENKLAD EUFÖRSÄKRAN	Härmed försäkrar ADC Automotive Distance Control Systems GmbH att denna typ av radioutrustning ARS 4-A överensstämmer med direktiv 2014/53/EU. Den fullständiga texten till EU-försäkran om överensstämmelse finns på följande webbadress: http://continental.automotive-approvals.com/
OM	Det eller de frekvensband där radioutrustningen arbetar: 76–77 GHz
ÖVERENSSTÄMMELSE	Den maximala radiofrekvensseffekt som överförs inom det eller de frekvensband där radioutrustningen arbetar: 3.16W (35dBm RMS EIRP)

OGKE20E1

Declaration of Conformity

13- 9

C) Language Text (EFTA Countries):

01_RED_IS_Icelandic EINFÖLDUÐ ESB SAMRÆMISYFIRLÝSING	Hér með lýsir ADC Automotive Distance Control Systems GmbH því yfir, að fjarskiptabúnaðurinn að gerð ARS 4-A er í samræmi við tilskipun 2014/53/ ESB. Textinn í fullri lengd um Samræmisyfirlýsingu ESB er aðgengilegur á eftirfarandi veffangi: http://continental.automotive-approvals.com/
	Bandbreidd(ir), sem fjarskiptabúnaðurinn starfar í: 76–77 GHz
	Hámarks fjarskiptiðni sendistyrkleika í bandbreiddinni/bandbreiddunum sem fjarskiptabúnaðurinn starfar í: 3.16W (35dBm RMS EIRP)

D) Language Text (Custom Union Agreement between EU and Turkey):

01_RED_TR_Turkish BASITLEŞTİRİLMİŞ AB UYGUNLUK BEYANI	İşbu belge ile, ADC Automotive Distance Control Systems GmbH şirketi ARS 4-A tipi radyo ekipmanının 2014/53/AB sayılı direktife uygun olduğunu beyan eder. AB uygunluk beyanının tam metni aşağıdaki İnternet adresinde mevcuttur: http://continental.automotive-approvals.com/
	Radyo cihazının çalıştığı frekans bandı/bantları: 76–77 GHz
	Radyo ekipmanının çalıştığı frekans bandında/bantlarında iletilen maksimum radyo frekans gücü: 3.16W (35dBm RMS EIRP)

Виробник Поштову Адресу

ADC Automotive Distance Control Systems GmbH

Peter-Dornier-Straße 10

88131 Lindau

Germany

Спрошена декларация про відповідність	Справжнім (найменування виробника ADC Automotive Distance Control Systems GmbH) заявляє, що тип радіобладнання (позначення типу радіобладнання ARS4-A) відповідає Технічному регламенту радіобладнання; повний текст декларації про відповідність доступний на веб-сайті за такою адресою: https://www.mitsubishi-motors.com/en/lwsc/ukraine/index.html
	частотний діапазон(-и), в якому працює радіобладнання: 76-77ГГц максимальна потужність радіосигналу в частотному діапазоні(-ах), в якому працює радіобладнання: 3.16Вт(35дБм середньоквадратична ефективна потужність випромінювання)

UA RF: 1CONT0004

OGKE20E1

Declaration of Conformity 13- 11

EAL

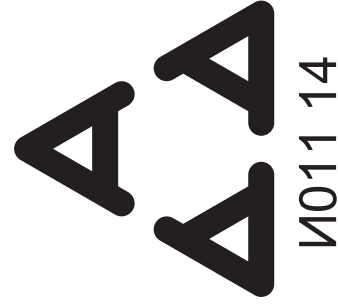
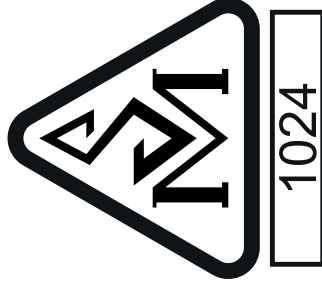

CCAB14LP3280T4

Certified for use in Hong Kong
經驗證可在香港使用
Certificate No. 證書號碼
HK0021400111



A) Generic information:

Manufacturer Postal Address

ADC Automotive Distance Control Systems GmbH
Peter-Dornier-Strasse 10, 88131 Lindau, Germany

B) Language Text:

01_RED_BG_Bulgarian	<p>С настоящото ADC Automotive Distance Control Systems GmbH декларира, че този тип радиосъоръжение SRR 3-A е в съответствие с Директива 2014/53/ЕС. Цялостният текст на ЕС декларацията за съответствие може да се намери на следния интернет адрес: http://continental.automotive-approvals.com/ радиочестотната лента или ленти, в която или които работи радиосъоръжението: 24.05–24.25 GHz максималната радиочестотна мощност, използвана в радиочестотната лента или ленти, в която или които работи радиосъоръжението.: 100mW (20 dBm) Peak EIRP</p>
02_RED_ES_Spanish	<p>Por la presente, ADC Automotive Distance Control Systems GmbH declara que el tipo de equipo radioeléctrico SRR 3-A es conforme con la Directiva 2014/53/UE. El texto completo de la declaración UE de conformidad está disponible en la dirección Internet siguiente: http://continental.automotive-approvals.com/ Banda o bandas de frecuencia en las que opera el equipo radioeléctrico: 24.05–24.25 GHz Potencia máxima de radiofrecuencia transmitida en la banda o bandas de frecuencia en las que opera el equipo radioeléctrico: 100mW (20 dBm) Peak EIRP</p>
03_RED_CS_Czech	<p>Tímto ADC Automotive Distance Control Systems GmbH prohlašuje, že typ rádiového zařízení SRR 3-A je v souladu se směrnicí 2014/53/EU. Uplně znění EU prohlášení o shodě je k dispozici na této internetové adrese: http://continental.automotive-approvals.com/ Kmitočtové pásmo (kmitočtová pásma), v němž (v nichž) rádiové zařízení pracuje: 24.05–24.25 GHz Maximální radiofrekvenci výkon vysílaný v kmitočtovém pásmu (v kmitočtových pásmech), v němž (v nichž) je rádiové zařízení provozováno: 100mW (20 dBm) Peak EIRP</p>
04_RED_DA_Danish	<p>Hermed erklærer ADC Automotive Distance Control Systems GmbH, at radioudstyretypen SRR 3-A er i overensstemmelse med direktiv 2014/53/EU. Euoverensstemmelseserklæringens fulde tekst kan findes på følgende internetadresse: http://continental.automotive-approvals.com/ Frekvensbånd, som radioudstyret fungerer på: 24.05–24.25 GHz Maksimal radiofrekvensseffekt, der udsendes i de frekvensbånd, som radioudstyret fungerer på: 100mW (20 dBm) Peak EIRP</p>
05_RED_DE_German	<p>Hiermit erklärt ADC Automotive Distance Control Systems GmbH, dass der Funkanlagentyp SRR 3-A der Richtlinie 2014/53/EU entspricht. Der vollständige Text der EU-Konformitätserklärung ist unter der folgenden Internetadresse verfügbar: http://continental.automotive-approvals.com/ Das Frequenzband oder die Frequenzbänder, in dem bzw. denen die Funkanlage betrieben wird: 24.05–24.25 GHz Die in dem Frequenzband oder den Frequenzbändern, in dem bzw. denen die</p>

	Funkanlage betrieben wird, abgestrahlte maximale Sendeleistung: 100mW (20 dBm) Peak EIRP
06_RED_ET_Estonian	
LIHTSUSTATUD ELI VASTAVUSDEKLA RATSIOON	Käesolevaga deklareerib ADC Automotive Distance Control Systems GmbH, et käesolev raadioseadme tüüp SRR 3-A vastab direktiivi 2014/53/EL nõuetele. ELI vastavusdeklaratsioonil täielik tekst on kättesaadav järgmisel internetiaadressil: http://continental.automotive-approvals.com/ Sagedusribad(d), millel raadioseade töötab: 24,05–24,25 GHz Raadioseadme töösaagedus(t)jel edastatav maksimaalne saatevõimsus: 100mW (20 dBm) Peak EIRP
07_RED_EL_Greek	
ΑΠΟΧΤΕΥΜΕΝΗ ΔΗΛΩΣΗ ΣΥΜΜΟΡΦΩΣΗΣ ΕΕ	Με την παρούσα δήλωση ADC Automotive Distance Control Systems GmbH, δηλώνει ότι ο ραδιοεξοπλισμός SRR 3-A πληροί την οδηγία 2014/53/ΕΕ. Το πλήρες κείμενο της δήλωσης συμμόρφωσης ΕΕ διατίθεται στην ακόλουθη ιστοσελίδα στο διαδίκτυο: http://continental.automotive-approvals.com/ Οι ζώνες συχνότητων στις οποίες λειτουργεί ο ραδιοεξοπλισμός: 24,05–24,25 GHz Η μέγιστη ραδιοηλεκτρική ισχύς στις ζώνες συχνότητων στις οποίες λειτουργεί ο ραδιοεξοπλισμός: 100mW (20 dBm) Peak EIRP
08_RED_EN_English	
SIMPLIFIED EU DECLARATION OF CONFORMITY	Hereby, ADC Automotive Distance Control Systems GmbH declares that the radio equipment type SRR 3-A is in compliance with Directive 2014/53/EU. The full text of the EU declaration of conformity is available at the following internet address: http://continental.automotive-approvals.com/ Frequency band(s) in which the radio equipment operates: 24,05–24,25 GHz Maximum radio-frequency power transmitted in the frequency band(s) in which the radio equipment operates: 100mW (20 dBm) Peak EIRP
09_RED_FR_French	
DECLARATION UE DE CONFORMITE SIMPLIFIEE	Le soussigné, ADC Automotive Distance Control Systems GmbH, déclare que l'équipement radioélectrique du type SRR 3-A est conforme à la directive 2014/53/UE. Le texte complet de la déclaration UE de conformité est disponible à l'adresse internet suivante: http://continental.automotive-approvals.com/ Bandes de fréquences utilisées par l'équipement radioélectrique: 24,05–24,25 GHz Puissance de radiofréquence maximale transmise sur les bandes de fréquences utilisées par l'équipement radioélectrique: 100mW (20 dBm) Peak EIRP
10_RED_IS_Icelandic	
	Related RED Directive not released.
11_RED_HR_Croatian	
POJEDNOSTAVLJE NA EU IZJAVA O SUKLADNOSTI	ADC Automotive Distance Control Systems GmbH ovime izjavljuje da je radijska oprema tipa SRR 3-A u skladu s Direktivom 2014/53/EU. Cjeloviti tekst EU izjave o sukladnosti dostupan je na slijedećoj internetskoj adresi: http://continental.automotive-approvals.com/ Frekvencijski pojas (frekvencijski pojas) u kojem (kojima) radijska oprema radi: 24,05–24,25 GHz Najveća radiofrekvencijska snaga koja se prenosi u frekvencijskom pojasu (frekvencijskim pojasima) u kojem (kojima) radijska oprema radi: 100mW (20 dBm) Peak EIRP
12_RED_IT_Italian	
DICHIARAZIONE DI CONFORMITÀ UE SEMPLIFICATA	Il fabbricante, ADC Automotive Distance Control Systems GmbH, dichiara che il tipo di apparecchiatura radio SRR 3-A è conforme alla direttiva 2014/53/UE. Il testo completo della dichiarazione di conformità UE è disponibile al seguente indirizzo Internet: http://continental.automotive-approvals.com/ Bande di frequenza di funzionamento dell'apparecchiatura radio: 24,05–24,25 GHz Massima potenza a radiofrequenza trasmessa nelle bande di frequenza in cui opera l'apparecchiatura radio.

	100mW (20 dBm) Peak EIRP
13_RED_LV_Latvian	
VIENKĀRŠŪTA ES ATBILSTĪBAS DEKLARĀCIJA	Ar šo ADC Automotive Distance Control Systems GmbH deklarē, ka radioiekārta SRR 3-A atbilst Direktīvai 2014/53/ES. Pils ES atbilstības deklarācijas teksts ir pieejams šādā interneta vietnē: http://continental.automotive-approvals.com/
	Frekvenču joslu(-ās), kurā(-ās) radioiekārta darbojas: 24.05–24.25 GHz
	Frekvenču josla(-ās), kurā(-ās) darbojas radioiekārta, maksimālo pārraidīta signāla jaudu: 100mW (20 dBm) Peak EIRP
14_RED_LT_Lithuanian	
SUPAPRASTINTA ES ATITIKTĪBES DEKLARĀCIJA	Ar šo ADC Automotive Distance Control Systems GmbH, patvirtinu, kad radioj ierīgu tipas SRR 3-A atitinka Direktīvu 2014/53/ES. Visas ES atitiktības deklarācijas tekstas pieņemamas šio interneta adresē: http://continental.automotive-approvals.com/
	Dāžņu josla(-ās), kurioje (-ose) veiktā radioj ierīgu: 24.05–24.25 GHz
	Didžiausia radioj dažņu galia, perduodama toje (tose) dažņu juostoje (-ose), kurioje (-ose) veiktā radioj ierīgu: 100mW (20 dBm) Peak EIRP
15_RED_HU_Hungarian	
EGYSZERŪSÍTETT EUMEGFELELŐSÉGI NYILATKOZAT	ADC Automotive Distance Control Systems GmbH igazolja, hogy a SRR 3-A típusú rádióberendezés megfelel a 2014/53/EU irányelvnek. Az EU-megfelelőségi nyilatkozat teljes szövege elérhető a következő internetes címen: http://continental.automotive-approvals.com/
	Az(ok) a frekvenciasáv(ok), amely(ek)en a rádióberendezés működik: 24.05–24.25 GHz
	Az abban a frekvenciasávban vagy azokban a frekvenciasávokban továbbított maximális teljesítmény, amely(ek)ben a rádióberendezés üzemel: 100mW (20 dBm) Peak EIRP
16_RED_MT_Maltese	
DIKJARAZZJONI SSIMPLIFIKATA TA' KONFORMITÀ TALUE	B'dan, ADC Automotive Distance Control Systems GmbH, niddikjara li dan it-tip ta' tagħmir tar-radju SRR 3-A huwa konformi mad-Direttiva 2014/53/UE. It-testi kollu tad-dikjarazzjoni ta' konformità tal-UE huwa disponibbli f'dan l-indirizz tal-Internet li ġejj: http://continental.automotive-approvals.com/
	Il-medda/medjed tal-frekwenza li jgħdem f'fom it-tagħmir tar-radju: 24.05–24.25 GHz
	Il-polenza massima tal-frekwenza tar-radju trażmessa fil-medda/medjed tal-frekwenza li jgħdem f'fom it-tagħmir tar- radju: 100mW (20 dBm) Peak EIRP
17_RED_NL_Dutch	
VEREENVOUDIGDE EUCONFORMITEITSV ERKLARING	Hierbij verklaar ik, ADC Automotive Distance Control Systems GmbH, dat het type radioapparaat SRR 3-A conform is met Richtlijn 2014/53/UE. De volledige tekst van de EU-conformiteitsverklaring kan worden geraadpleegd op het volgende internetadres: http://continental.automotive-approvals.com/
	Frequentieband(en) waarin de radioapparaat functioneert: 24.05–24.25 GHz
	Maximaal radiofrequent vermogen uitgezonden in de frequentieband(en) waarin de radioapparaat functioneert: 100mW (20 dBm) Peak EIRP
18_RED_PL_Polish	
UPROSZCZONA DEKLARACJA ZGODNOŚCI UE	ADC Automotive Distance Control Systems GmbH niniejszym oświadcza, że typ urządzenia radiowego SRR 3-A jest zgodny z dyrektywą 2014/53/UE. Pełny tekst deklaracji zgodności UE jest dostępny pod następującym adresem internetowym: http://continental.automotive-approvals.com/
	Zakres(-ów) częstotliwości, w którym (których) pracuje urządzenie radiowe: 24.05–24.25 GHz
	Maksymalnej mocy częstotliwości radiowej emitowanej w zakresie(-ach) częstotliwości, w którym (których) pracuje urządzenie radiowe: 100mW (20 dBm) Peak EIRP
19_RED_PT_Portuguese	

DECLARAÇÃO UE DE CONFORMIDADE SIMPLIFICADA	O(a) abaixo assinado(a) ADC Automotive Distance Control Systems GmbH declara que o presente tipo de equipamento de rádio SRR 3-A está em conformidade com a Diretiva 2014/53/UE. O texto integral da declaração de conformidade está disponível no seguinte endereço de Internet: http://continental.automotive-approvals.com/ A(s) banda(s) de frequências em que o equipamento de rádio funciona: 24.05–24.25 GHz A potência máxima de radiofrequências transmitida na(s) banda(s) de frequências em que o equipamento de rádio funciona: 100mW (20 dBm) Peak EIRP
20_RED_RO_Romanian	
DECLARAȚIA UE DE CONFORMITATE SIMPLIFICATĂ	Prin prezenta, ADC Automotive Distance Control Systems GmbH declară că tipul de echipament radio SRR 3-A este în conformitate cu Directiva 2014/53/UE. Textul integral al declarației UE de conformitate este disponibil la următoarea adresă internet: http://continental.automotive-approvals.com/ Banda (benzile) de frecvențe în care funcționează echipamentul radio: 24.05–24.25 GHz Puterea maximă de radiofrecvență transmisă în banda (benzile) de frecvențe în care funcționează echipamentul radio: 100mW (20 dBm) Peak EIRP
21_RED_SK_Slovak	
ZJEDNODUŠENÉ EU VYHLÁSENIE O ZHODE	ADC Automotive Distance Control Systems GmbH týmto vyhlasuje, že rádiové zariadenie typu SRR 3-A je v súlade so smernicou 2014/53/EU. Úplné EU vyhlásenie o zhode je k dispozícii na tejto internetovej adrese: http://continental.automotive-approvals.com/ Frekvencné pásmo resp. pásma, v ktorých rádiové zariadenie pracuje: 24.05–24.25 GHz Maximálny vysokofrekvenčný výkon prenášaný vo frekvencnom pásme, resp. pásmach, v ktorých rádiové zariadenie pracuje: 100mW (20 dBm) Peak EIRP
22_RED_SL_Slovenian	
POENOSTAVLJENA IZJAVA EU O SKLADNOSTI	ADC Automotive Distance Control Systems GmbH potrjuje, da je tip radijske opreme SRR 3-A skladen z Direktivo 2014/53/EU. Celotno besedilo izjave EU o skladnosti je na voljo na naslednjem spletnem naslovu: http://continental.automotive-approvals.com/ Frekvenčni pas ali pasovi, na katerih deluje radijska oprema: 24.05–24.25 GHz Največja energija za radijsko frekvenco, preneseno po frekvenčnem pasu ali pasovih, na katerih radijska oprema deluje: 100mW (20 dBm) Peak EIRP
23_RED_FI_Finnish	
YKSINKERTAISTETTU EU-VAATIMUSTENMUKAISUUSVAKUUTUS	ADC Automotive Distance Control Systems GmbH vakuuttaa, että radiolaitetyyppi SRR 3-A on direktiivin 2014/53/EU mukainen. EU-vaatimustenmukaisuusvakuutuksen täysimittainen teksti on saatavilla seuraavassa internetosoitteessa: http://continental.automotive-approvals.com/ Radiotaajuudet, jolla radiolaitte toimii: 24.05–24.25 GHz Suurin mahdollinen lähetytsto radiotaajuuksilla, jolla radiolaitte toimii: 100mW (20 dBm) Peak EIRP
24_RED_SV_Swedish	
FÖRENKLAD EU-FÖRSÄKRAN OM ÖVERENSSTÄMMELSE	Härmed försäkrar ADC Automotive Distance Control Systems GmbH att denna typ av radioustrustning SRR 3-A överensstämmer med direktiv 2014/53/EU. Den fullständiga texten till EU-försäkran om överensstämmelse finns på följande webbadress: http://continental.automotive-approvals.com/ Det eller de frekvensband där radioustrustningen arbetar: 24.05–24.25 GHz Den maximala radiofrekvensseffekt som överförs inom det eller de frekvensband där radioustrustningen arbetar: 100mW (20 dBm) Peak EIRP

C) Language Text (EFTA Countries):

SRR3-A : OUTLANDER / OUTLANDER PHEV / ECLIPSE CROSS

01_RED_IS_Icelandic	
EINFOLDUÐ ESB SAMRÆMISYFIRLÝ SING	Hér með lýsir ADC Automotive Distance Control Systems GmbH því yfir, að fjarskiptabúnaðurinn að gerð SRR 3-A er í samræmi við tilskipun 2014/53/ESB. Textinn í fullri lengd um Samræmisyfirlýsingu ESB er aðgengilegur á eftirfarandi veffangi: http://continental.automotive-approvals.com/
	Bandbreidd(ir) sem fjarskiptabúnaðurinn starfar í: 24,05–24,25 GHz
	Hámarks fjarskiptiðóni sendistyrkleika í bandbreiddinni/bandbreiddunum sem fjarskiptabúnaðurinn starfar í: 100mW (20 dBm) Peak EIRP

D) Language Text (Custom Union Agreement between EU and Turkey):

SRR3-A : OUTLANDER / OUTLANDER PHEV / ECLIPSE CROSS

01_RED_TR_Turkish	
BASITLEŞTİRİLMİŞ AB UYGUNLUK BEYANI	İşbu belge ile, ADC Automotive Distance Control Systems GmbH şirketi SRR 3-A tipi radyo ekipmanının 2014/53/AB sayılı direktife uygun olduğunu beyan eder. AB uygunluk beyanının tam metni aşağıdaki internet adresinde mevcuttur: http://continental.automotive-approvals.com/
	Radyo cihazının çalıştığı frekans bandı/bantları: 24,05–24,25 GHz
	Radyo ekipmanının çalıştığı frekans bandında/bantlarında iletilen maksimum radyo frekansı gücü: 100mW (20 dBm) Peak EIRP

OGKE20E1

Declaration of Conformity

13- 17

C) Language Text (EFTA Countries):

01_RED_IS_Icelandic	
EINFÖLDUÐ ESB SAMRÆMISYRIRLY SING	Hér með lýsir ADC Automotive Distance Control Systems GmbH því yfir, að fjarskiptabúnaðurinn að gerð SRR 3-A er í samræmi við tilskipun 2014/53/ ESB. Textinn í fullri lengd um Samræmisyrirlyngu ESB er aðgengilegur á eftirfarandi veffangi: http://continental.automotive-approvals.com/
	Bandbreidd(ir), sem fjarskiptabúnaðurinn starfar í: 24.05–24.25 GHz
	Hámarks fjarskiptafjöni sendistyrkleika í bandbreiddinni/bandbreiddunum sem fjarskiptabúnaðurinn starfar í: 100mW (20 dBm) Peak EIRP

D) Language Text (Custom Union Agreement between EU and Turkey):

01_RED_TR_Turkish	
BASTIŞTİRİLMİŞ AB UYGUNLUK BEYANI	İşbu belge ile, ADC Automotive Distance Control Systems GmbH şirketi SRR 3-A tipi radyo ekipmanının 2014/53/AB sayılı direktife uygun olduğunu beyan eder. AB uygunluk beyanının tam metni aşağıdaki internet adresinde mevcuttur: http://continental.automotive-approvals.com/
	Radyo cihazının çalıştığı frekans bantları/bantları: 24.05–24.25 GHz
	Radyo ekipmanının çalıştığı frekans bantlarında/bantlarında iletilen maksimum radyo frekansı gücü: 100mW (20 dBm) Peak EIRP

Виробник Поштову Адресу
ADC Automotive Distance Control Systems GmbH
Peter-Dornier-Straße 10
88131 Lindau
Germany

Спрошена декларация про відповідність	Справжнім (найменування виробника ADC Automotive Distance Control Systems GmbH) заявляє, що тип радіобладнання (позначення типу радіобладнання SRR3-A) відповідає Технічному регламенту радіобладнання; повний текст декларації про відповідність доступний на веб-сайті за такою адресою: https://www.mitsubishi-motors.com/en/lwsc/ukraine/index.html
	частотний діапазон(-и), в якому працює радіобладнання: 24.05-24.25ГГц максимальна потужність радіосигналу в частотному діапазоні(-ах), в якому працює радіобладнання: 100мВт(20Дбм) Пікова ефективна потужність випромінювання

UA RF: 1CONT0006

OGKE20E1

Declaration of Conformity 13- 19

ERL

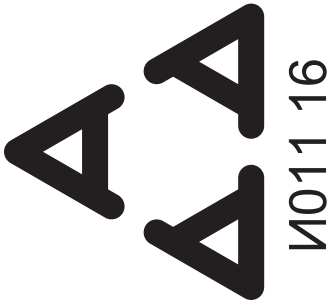

Complies with
IMDA Standards
DA106816



A) Generic information:

Manufacturer Postal Address
VISTEON CORPORATION
One Village Center Drive, Van Buren Township, Michigan USA

B) Language Text:

01_RED_BG_Bulgarian	
ОПРОСТЕНА ЕС ДЕКЛАРАЦИЯ ЗА СЪОТВЕТСТВИЕ	С настоящото VISTEON CORPORATION декларира, че този тип радиосъоръжение MDGMY10 е в съответствие с Директива 2014/53/ЕС. Цялостният текст на ЕС декларацията за съответствие може да се намери на следния интернет адрес: http://www.mitsubishi-motors.com/en/red-doc/
	радиочестотната лента или ленти, в която или които работи радиосъоръжението: 2.402-2.480 GHz
	максималната радиочестотна мощност, излъчвана в радиочестотната лента или ленти, в която или които работи радиосъоръжението.: 4 dbm
02_RED_ES_Spanish	
DECLARACIÓN UE DE CONFORMIDAD SIMPLIFICADA	Por la presente, VISTEON CORPORATION declara que el tipo de equipo radioeléctrico MDGMY10 es conforme con la Directiva 2014/53/UE. El texto completo de la declaración UE de conformidad está disponible en la dirección Internet siguiente: http://www.mitsubishi-motors.com/en/red-doc/
	Banda o bandas de frecuencia en las que opera el equipo radioeléctrico: 2.402-2.480 GHz
	Potencia máxima de radiofrecuencia transmitida en la banda o bandas de

	frecuencia en las que opera el equipo radioeléctrico: 4 dbm
03_RED_CS_Czech ZJEDNODUŠENÉ EU PROHLÁŠENÍ O SHODĚ	Tímto VISTEON CORPORATION prohlašuje, že typ rádiového zařízení MDGMY10 je v souladu se směrnicí 2014/53/EU. Úplné znění EU prohlášení o shodě je k dispozici na této internetové adrese: http://www.mitsubishi-motors.com/en/red-doc/ Kmitočtové pásmo (kmitočtová pásma), v němž (v nichž) rádiové zařízení pracuje: 2.402-2.480 GHz Maximální radiofrekvenční výkon vysílaný v kmitočtovém pásmu (v kmitočtových pásmech), v němž (v nichž) je rádiové zařízení provozováno: 4 dbm
04_RED_DA_Danish FORENKLET EUOVERENSSTEMM ELSESERKLÆR ING	Hermed erklærer VISTEON CORPORATION, at radioudstyrstypen MDGMY10 er i overensstemmelse med direktiv 2014/53/EU. EUoverensstemmelseserklæringens fulde tekst kan findes på følgende internetadresse: http://www.mitsubishi-motors.com/en/red-doc/ Frekvensbånd, som radioudstyret fungerer på: 2.402-2.480 GHz Maksimal radiofrekvenseffekt, der udsendes i de frekvensbånd, som radioudstyret fungerer på: 4 dbm
05_RED_DE_German VEREINFACHTE EUKONFORMITÄTSERKLÄRUNG	Hiermit erklärt VISTEON CORPORATION, dass der Funkanlagentyp MDGMY10 der Richtlinie 2014/53/EU entspricht. Der vollständige Text der EU-Konformitätserklärung ist unter der folgenden Internetadresse verfügbar: http://www.mitsubishi-motors.com/en/red-doc/

	Das Frequenzband oder die Frequenzbänder, in dem bzw. denen die Funkanlage betrieben wird: 2.402-2.480 GHz
	Die in dem Frequenzband oder den Frequenzbändern, in dem bzw. denen die Funkanlage betrieben wird, abgestrahlte maximale Sendeleistung: 4 dbm
06_RED_ET_Estonian	
LIHTSUSTATUD ELI VASTAVUSDEKLARATSIOON	Käesolevaga deklareerib VISTEON CORPORATION, et käesolev raadioseadme tüüp MDGMY10 vastab direktiivi 2014/53/EL nõuetele. ELi vastavusdeklaratsiooni täielik tekst on kättesaadav järgmisel internetiaadressil: http://www.mitsubishi-motors.com/en/red-doc/
	Sagedusribad(d), millel raadioseade töötab: 2.402-2.480 GHz
	Raadioseadme töösagedus(t)el edastatav maksimaalne saatevõimsus: 4 dbm
07_RED_EL_Greek	
ΑΠΛΟΥΣΤΕΥΜΕΝΗ ΔΗΛΩΣΗ ΣΥΜΜΟΡΦΩΣΗΣ ΕΕ	Με την παρούσα ο/η VISTEON CORPORATION, δηλώνει ότι ο ραδιοεξοπλισμός MDGMY10 πληροί την οδηγία 2014/53/ΕΕ. Το πλήρες κείμενο της δήλωσης συμμόρφωσης ΕΕ διατίθεται στην ακόλουθη ιστοσελίδα στο διαδίκτυο: http://www.mitsubishi-motors.com/en/red-doc/
	Οι ζώνες συχνοτήτων στις οποίες λειτουργεί ο ραδιοεξοπλισμός: 2.402-2.480 GHz
	η μέγιστη ραδιοηλεκτρική ισχύς στις ζώνες συχνοτήτων στις οποίες λειτουργεί ο ραδιοεξοπλισμός: 4 dbm

08_RED_EN_English	
SIMPLIFIED EU DECLARATION OF CONFORMITY	Hereby, VISTEON CORPORATION declares that the radio equipment type MDGMY10 is in compliance with Directive 2014/53/EU. The full text of the EU declaration of conformity is available at the following internet address: http://www.mitsubishi-motors.com/en/red-doc/
Frequency band(s) in which the radio equipment operates:	2.402-2.480 GHz
Maximum radio-frequency power transmitted in the frequency band(s) in which the radio equipment operates:	4 dbm
09_RED_FR_French	
DECLARATION UE DE CONFORMITE SIMPLIFIEE	Le soussigné, VISTEON CORPORATION, déclare que l'équipement radioélectrique du type MDGMY10 est conforme à la directive 2014/53/UE. Le texte complet de la déclaration UE de conformité est disponible à l'adresse internet suivante: http://www.mitsubishi-motors.com/en/red-doc/
Bandes de fréquences utilisées par l'équipement radioélectrique:	2.402-2.480 GHz
Puissance de radiofréquence maximale transmise sur les bandes de fréquences utilisées par l'équipement radioélectrique:	4 dbm
10_RED_IS_Icelandic	
EINFÖLDUÐ ESB-SAMRÆMISYFIRLÝSING	Pannig lýsir VISTEON CORPORATION útvarpsbúnaðinum MDGMY10 í samræmi við tilskipun 2014/53 / ESB. Fullur texti ESB samræmisyfirlýsing er að finna á eftirfarandi netfangi: http://www.mitsubishi-motors.com/en/red-doc/
Tíðnisviði (s) sem þráðlausan búnað undirrita burt:	

	2.402-2.480 GHz
	Mámarks útlarp-tíðni máttur miðlað á tíðnisvóðinu (s) sem þráðlausan búnað undirrita burt: 4 dbm
11_RED_HR_Croatian	
POJEDNOSTAVLJENA EU IZJAVA O SUKLADNOSTI	VISTEON CORPORATION ovime izjavljuje da je radijska oprema tipa MDGMY10 u skladu s Direktivom 2014/53/EU. Cjeloviti tekst EU izjave o sukladnosti dostupan je na sljedećoj internetskoj adresi: : http://www.mitsubishi-motors.com/en/red-doc/ Frekvencijski pojas (frekvencijski pojasi) u kojem (kojima) radijska oprema radi: 2.402-2.480 GHz Najveća radiofrekvencijska snaga koja se prenosi u frekvencijskom pojasu (frekvencijskim pojasi) u kojem (kojima) radijska oprema radi: 4 dbm
12_RED_IT_Italian	
DICHIARAZIONE DI CONFORMITÀ UE SEMPLIFICATA	Il fabbricante, VISTEON CORPORATION, dichiara che il tipo di apparecchiatura radio MDGMY10 è conforme alla direttiva 2014/53/UE. Il testo completo della dichiarazione di conformità UE è disponibile al seguente indirizzo Internet: http://www.mitsubishi-motors.com/en/red-doc/ Bande di frequenza di funzionamento dell'apparecchiatura radio: 2.402-2.480 GHz Massima potenza a radiofrequenza trasmessa nelle bande di frequenza in cui opera l'apparecchiatura radio: 4 dbm
13_RED_LV_Latvian	
VIENTKĀRŠOTA ES ATBILĪTĪBAS	Ar šo VISTEON CORPORATION deklarē, ka radioiekārta MDGMY10 atbilst Direktīvai 2014/53/ES. Pilns ES atbilstības

DEKLARACIJA	deklaracijos tekstas ir piejams šadā interneta vietnē: http://www.mitsubishi-motors.com/en/red-doc/ Frekvencū joslū(-as), kurā(-ās) radioiekārtas darbojas: 2.402-2.480 GHz Frekvencū joslā(-ās), kurā(-ās) darbojas radioiekārtas, maksimālo pārraidītā signāla jaudu: 4 dbm
14_RED_LT_Lithuanian	
SUPAPRASTINTA ES ATITIKTIES DEKLARACIJA	Aš, VISTEON CORPORATION, patvirtinu, kad radijo įrenginių tipas MDGMY10 atitinka Direktivą 2014/53/ES. Visas ES aittikties deklaracijos tekstas priemamas šiuo interneto adresu: http://www.mitsubishi-motors.com/en/red-doc/
	Dažnių juosta (-os), kurioje (-iose) veikia radijo įrenginiai: 2.402-2.480 GHz Didžiausia radijo dažnių galia, perduodama toje (tose) dažnių juostoje (-ose), kurioje (-iose) veikia radijo įrenginiai: 4 dbm
15_RED_HU_Hungarian	
EGYSZERŰSÍTETT EUMEGFELELŐSÉGI NYILATKOZAT	VISTEON CORPORATION igazolja, hogy a MDGMY10 típusú rádióberendezés megfelel a 2014/53/EU irányelvnek. Az EU-megfelelőségi nyilatkozat teljes szövege elérhető a következő internetes címen:: http://www.mitsubishi-motors.com/en/red-doc/ Az(ok) a frekvenciasáv(ok), amely(ek)ben a rádióberendezés működik: 2.402-2.480 GHz Az abban a frekvenciasávban vagy azokban a frekvenciasávokban továbbított maximális jelerősség, amely(ek)ben a rádióberendezés üzemel: 4 dbm
16_RED_MT_Maltese	

<p>DIKJARAZZJONI SSIMPLIFIKATA TA' KONFORMITÀ TAL-UE</p>	<p>B'dan, VISTEON CORPORATION, niddikjara li dan it-tip ta' tagħmir tar-radju MDGMY10 huwa konformi mad-Direttiva 2014/53/UE. It-test kollu tad-dikjarazzjoni ta' konformità tal-UE huwa disponibbli f'dan l-indirizz tal-Internet li ġej: http://www.mitsubishi-motors.com/en/red-doc/</p>
	<p>Il-medda/meded tal-frekwenza li jaħdem fihom it-tagħmir tar-radju: 2.402-2.480 GHz</p>
	<p>Il-potenza massima tal-frekwenza tar-radju trażmessa fil-medda/meded tal-frekwenza li jaħdem fihom it-tagħmir tar-radju: 4 dbm</p>
<p>17_RED_NL_Dutch</p>	
<p>VEREENVOUDIGDE EUCONFORMITEITSVERKLARING</p>	<p>Hierbij verklaar ik, VISTEON CORPORATION, dat het type radioapparaat MDGMY10 conform is met Richtlijn 2014/53/EU. De volledige tekst van de EU-conformiteitsverklaring kan worden geraadpleegd op het volgende internetadres: http://www.mitsubishi-motors.com/en/red-doc/</p>
	<p>Frequentieband(en) waarin de radioapparaat functioneert: 2.402-2.480 GHz</p>
	<p>Maximaal radiofrequent vermogen uitgezonden in de frequentieband(en) waarin de radioapparaat functioneert: 4 dbm</p>
<p>18_RED_PL_Polish</p>	
<p>UPROSZCZONA DEKLARACJA ZGODNOŚCI UE</p>	<p>VISTEON CORPORATION niniejszym oświadcza, że typ urządzenia radiowego MDGMY10 jest zgodny z dyrektywą 2014/53/UE. Pełny tekst deklaracji zgodności UE jest dostępny pod następującym adresem internetowym: http://www.mitsubishi-motors.com/en/red-doc/</p>
	<p>Zakres(-ów) częstotliwości, w którym (których) pracuje urządzenie radiowe:</p>

	2.402-2.480 GHz
	Maksymalnej mocy częstotliwości radiowej emitowanej w zakresie(-ach) częstotliwości, w którym (których) pracuje urządzenie radiowe: 4 dbm
19_RED_PT_Portuguese	
DECLARAÇÃO UE DE CONFORMIDADE SIMPLIFICADA	O(a) abaixo assinado(a) VISTEON CORPORATION declara que o presente tipo de equipamento de rádio MDGMY10 está em conformidade com a Diretiva 2014/53/UE. O texto integral da declaração de conformidade está disponível no seguinte endereço de Internet: http://www.mitsubishi-motors.com/en/red-doc/
	A(s) banda(s) de frequências em que o equipamento de rádio funciona: 2.402-2.480 GHz
	A potência máxima de radiofrequências transmitida na(s) banda(s) de frequências em que o equipamento de rádio funciona: 4 dbm
20_RED_RO_Romanian	
DECLARAȚIA UE DE CONFORMITATE SIMPLIFICATĂ	Prin prezenta, VISTEON CORPORATION declară că tipul de echipamente radio MDGMY10 este în conformitate cu Directiva 2014/53/UE. Textul integral al declarației UE de conformitate este disponibil la următoarea adresă internet: http://www.mitsubishi-motors.com/en/red-doc/
	Banda (benzile) de frecvențe în care funcționează echipamentul radio: 2.402-2.480 GHz
	Puterea maximă de radiofrecvență transmisă în banda (benzile) de frecvențe în care funcționează echipamentul radio: 4 dbm
21_RED_SK_Slovak	

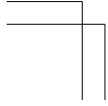
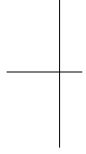
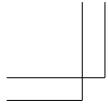

ZJEDNODUŠENÉ EÚ VYHLÁSENIE O ZHODE	VISTEON CORPORATION týmto vyhlasuje, že rádiové zariadenie typu MDGMY10 je v súlade so smernicou 2014/53/EÚ. Úplné EÚ vyhlásenie o zhode je k dispozícii na tejto internetovej adrese: http://www.mitsubishi-motors.com/en/red-doc/
	Frekvenčné pásmo resp. pásma, v ktorých rádiové zariadenie pracuje: 2.402-2.480 GHz
	Maximálny vysokofrekvenčný výkon prenášaný vo frekvenčnom pásme, resp. pásmach, v ktorých rádiové zariadenie pracuje: 4 dbm
22_RED_SL_Slovenian	
POENOSTAVLJENA IZJAVA EU O SKLADNOSTI	VISTEON CORPORATION potrjuje, da je tip radijske opreme MDGMY10 skladen z Direktivo 2014/53/EU. Celotno besedilo izjave EU o skladnosti je na voljo na naslednjem spletnem naslovu: http://www.mitsubishi-motors.com/en/red-doc/
	Frekvenčni pas ali pasovi, na katerih deluje radijska oprema: 2.402-2.480 GHz
	Največja energija za radijsko frekvenco, preneseno po frekvenčnem pasu ali pasovih, na katerih radijska oprema deluje: 4 dbm
23_RED_FL_Finnish	
YKSINKERTAISTETTU EUVAATIMUSTENMUKAISUUSVAKUUTUS	VISTEON CORPORATION vakuuttaa, että radiolaitetyppi MDGMY10 on direktiivin 2014/53/EU mukainen. EUvaatimustenmukaisuusvakuutuksen täysimittainen teksti on saatavilla seuraavassa internetosoitteessa: http://www.mitsubishi-motors.com/en/red-doc/
	Radiolaitteet, jolla radiolaitte toimii: 2.402-2.480 GHz
	Suurin mahdollinen lähetysteho radiolaitteilla, jolla radiolaitte toimii:

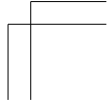
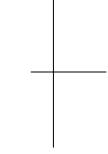
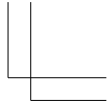

	4 dbm
24_RED_SV_Swedish FÖRENKLAD EUFÖRSÄKRAN OM ÖVERENSSTÄMMELSE	Härmed försäkrar VISTEON CORPORATION att denna typ av radioutrustning MDGMY10 överensstämmer med direktiv 2014/53/EU. Den fullständiga texten till EU-försäkran om överensstämmelse finns på följande webbadress: http://www.mitsubishi-motors.com/en/red-doc/ Det eller de frekvensband där radioutrustningen arbetar: 2.402-2.480 GHz Den maximala radiofrekvenseffekt som överförs inom det eller de frekvensband där radioutrustningen arbetar: 4 dbm

A) Generic information:

Manufacturer Postal Address

Continental Automotive GmbH
Seimensstrasse12 D-93055 Regensburg Germany

B) Language Text:

01_RED_BG_Bulgarian	
ОПРОСТЕНА ЕС ДЕКЛАРАЦИЯ ЗА СЪОТВЕТСТВИЕ	С настоящото Continental Automotive GmbH декларира, че този тип радиосъоръжение S180052094/TIS-03 е в съответствие с Директива 2014/53/ЕС. Цялостният текст на ЕС декларацията за съответствие може да се намери на следния интернет адрес: http://www.mitsubishi-motors.com/en/red-doc/
	радиочестотната лента или ленти, в която или които работи радиосъоръжението: 433.92MHz
	максималната радиочестотна мощност, излъчвана в радиочестотната лента или ленти, в която или които работи радиосъоръжението : -17 dBm

02_RED_ES_Spanish	
DECLARACIÓN UE DE CONFORMIDAD SIMPLIFICADA	Por la presente, Continental Automotive GmbH declara que el tipo de equipo radioeléctrico S180052094/TIS-03 es conforme con la Directiva 2014/53/UE. El texto completo de la declaración UE de conformidad está disponible en la dirección Internet siguiente: http://www.mitsubishi-motors.com/en/red-doc/
	Banda o bandas de frecuencia en las que opera el equipo radioeléctrico: 433.92MHz
	Potencia máxima de radiofrecuencia transmitida en la banda o bandas de frecuencia en las que opera el equipo radioeléctrico: -17 dBm

03_RED_CS_Czech	
------------------------	--

ZJEDNODUŠENÉ EU PROHLÁŠENÍ O SHODĚ	<p>Tímto Continental Automotive GmbH prohlašuje, že typ rádiového zařízení S180052094/TIS-03 je v souladu se směrnicí 2014/53/EU. Úplné znění EU prohlášení o shodě je k dispozici na této internetové adrese: http://www.mitsubishi-motors.com/en/red-doc/</p> <p>Kmitočtové pásmo (kmitočtová pásma), v němž (v nichž) rádiové zařízení pracuje: 433.92MHz</p> <p>Maximální radiofrekvenční výkon vysílaný v kmitočtovém pásmu (v kmitočtových pásmech), v němž (v nichž) je rádiové zařízení provozováno: -17 dBm</p>
04_RED_DA_Danish	
FORENKLET EUOVERENSSTEMM ELSESERKLÆRER NG	<p>Hermed erklærer Continental Automotive GmbH, at radioudstyretypen S180052094/TIS-03 er i overensstemmelse med direktiv 2014/53/EU. EUoverensstemmelseserklæringens fulde tekst kan findes på følgende internetadresse: http://www.mitsubishi-motors.com/en/red-doc/</p> <p>Frekvensbånd, som radioudstyret fungerer på: 433.92MHz</p> <p>Maksimal radiofrekvensseffekt, der udsendes i de frekvensbånd, som radioudstyret fungerer på: -17 dBm</p>
05_RED_DE_German	
VEREINFACHTE EUKONFORMITÄTSERKLÄRUNG	<p>Hiermit erklärt Continental Automotive GmbH, dass der Funklagentyp S180052094/TIS-03 der Richtlinie 2014/53/EU entspricht. Der vollständige Text der EU-Konformitätserklärung ist unter der folgenden Internetadresse verfügbar: http://www.mitsubishi-motors.com/en/red-doc/</p> <p>Das Frequenzband oder die Frequenzbänder, in dem bzw. denen die Funkanlage betrieben wird: 433.92MHz</p> <p>Die in dem Frequenzband oder den Frequenzbändern, in dem bzw. bzw. denen die Funkanlage betrieben wird, abgestrahlte maximale Sendeleistung: -17 dBm</p>

06_RED_ET_Estonian	
LIHTSUSTATUD ELI VASTAVUSDEKLARATSIIOON	Käesolevaga deklareerib Continental Automotive GmbH, et käesolev raadioseadme tüüp S180052094/TIS-03 vastab direktiivi 2014/53/EL nõuetele. ELI vastavusdeklaratsiooni täielik tekst on kättesaadav järgmisel internetiaadressil: http://www.mitsubishi-motors.com/en/red-doc/
	Sagedusriba(d), millel raadioseade töötab: 433.92MHz
	Raadioseadme tööagedus(t)el edastatav maksimaalne saatevõimsus: -17 dBm
07_RED_EL_Greek	
ΑΠΛΟΥΣΤΕΥΜΕΝΗ ΔΗΛΩΣΗ ΣΥΜΜΟΡΦΩΣΗΣ ΕΕ	Με την παρούσα ο/ή Continental Automotive GmbH, δηλώνει ότι ο ραδιοεξοπλισμός S180052094/TIS-03 πληροί την οδηγία 2014/53/ΕΕ. Το πλήρες κείμενο της δήλωσης συμμόρφωσης ΕΕ διατίθεται στην ακόλουθη ιστοσελίδα στο διαδίκτυο: http://www.mitsubishi-motors.com/en/red-doc/
	Οι ζώνες συχνοτήτων στις οποίες λειτουργεί ο ραδιοεξοπλισμός:: 433.92MHz
	η μέγιστη ραδιοηλεκτρική ισχύς στις ζώνες συχνοτήτων στις οποίες λειτουργεί ο ραδιοεξοπλισμός: -17 dBm
08_RED_EN_English	
SIMPLIFIED EU DECLARATION OF CONFORMITY	Hereby, Continental Automotive GmbH declares that the radio equipment type S180052094/TIS-03 is in compliance with Directive 2014/53/EU. The full text of the EU declaration of conformity is available at the following internet address: http://www.mitsubishi-motors.com/en/red-doc/
	Frequency band(s) in which the radio equipment operates: 433.92MHz
	Maximum radio-frequency power transmitted in the frequency band(s) in which the radio equipment operates: -17 dBm
09_RED_FR_French	
DECLARATION UE DE	Le soussigné, Continental Automotive GmbH, déclare que

CONFORMITE SIMPLIFIEE	l'équipement radioélectrique du type S180052094/TIS-03 est conforme à la directive 2014/53/UE. Le texte complet de la déclaration UE de conformité est disponible à l'adresse internet suivante: http://www.mitsubishi-motors.com/en/red-doc/
	Bandes de fréquences utilisées par l'équipement radioélectrique: 433,92MHz
	Puissance de radiofréquence maximale transmise sur les bandes de fréquences utilisées par l'équipement radioélectrique: -17 dBm
10_RED_GA_empty_no_text	
	Related RED Directive not released.
11_RED_HR_Croatian	
POJEDNOSTAVLJENA EU IZJAVA O SUKLADNOSTI	Continental Automotive GmbH ovime izjavljuje da je radijska oprema tipa S180052094/TIS-03 u skladu s Direktivom 2014/53/EU. Cjeloviti tekst EU izjave o sukladnosti dostupan je na sljedećoj internetskoj adresi:; http://www.mitsubishi-motors.com/en/red-doc/
	Frekvencijski pojas (frekvencijski pojas) u kojem (kojima) radijska oprema radi: 433,92MHz
	Najveća radiofrekvencijska snaga koja se prenosi u frekvencijskom pojasu (frekvencijskim pojasima) u kojem (kojima) radijska oprema radi: -17 dBm
12_RED_IT_Italian	
DICHIARAZIONE DI CONFORMITÀ UE SEMPLIFICATA	Il fabbricante, Continental Automotive GmbH, dichiara che il tipo di apparecchiatura radio S180052094/TIS-03 è conforme alla direttiva 2014/53/UE. Il testo completo della dichiarazione di conformità UE è disponibile al seguente indirizzo Internet: http://www.mitsubishi-motors.com/en/red-doc/
	Bande di frequenza di funzionamento dell'apparecchiatura

	<p>radio: 433.92MHz</p> <p>Massima potenza a radiofrequenza trasmessa nelle bande di frequenza in cui opera l'apparecchiatura radio: 10mW</p>
13_RED_LV_Latvian	
VĪENKĀRŠOTA ES ATBILSTĪBAS DEKLARĀCIJA	<p>Ar šo Continental Automotive GmbH deklarē, ka radioiekārta S180052094/TIS-03 atbilst Direktīvai 2014/53/ES.</p> <p>Pilns ES atbilstības deklarācijas teksts ir pieejams šādā interneta vietnē: http://www.mitsubishi-motors.com/en/red-doc/</p> <p>Frekvenču joslu(-as), kurā(-ās) radioiekārta darbojas: 433.92MHz</p> <p>Frekvenču joslā(-ās), kurā(-ās) darbojas radioiekārta, maksimālo pārraidītā signāla jaudu.: -17 dBm</p>
14_RED_LT_Lithuanian	
SUPAPRASTINTA ES ATITIKTIES DEKLARACIJA	<p>Aš, Continental Automotive GmbH, patvirtinu, kad radiojo įrenginių tipas S180052094/TIS-03 atitinka Direktyvą 2014/53/ES. Visas ES atitikties deklaracijos tekstas prieinamas šiuo interneto adresu: http://www.mitsubishi-motors.com/en/red-doc/</p> <p>Dažnių juostia (-os), kurioje (-iose) veikia radiojo įrenginiai: 433.92MHz</p> <p>Didžiausia radiojo dažnių galia, perduodama toje (tose) dažnių juostoje (-ose), kurioje (-iose) veikia radiojo įrenginiai: -17 dBm</p>
15_RED_HU_Hungarian	
EGYSZERŰSÍTETT EUMEGFELELŐSÉGI NYILATKOZAT	<p>Continental Automotive GmbH igazolja, hogy a S180052094/TIS-03 típusú rádióberendezés megfelel a 2014/53/EU irányelvnek. Az EU-megfelelőségi nyilatkozat teljes szövege elérhető a következő internetes címen:. http://www.mitsubishi-motors.com/en/red-doc/</p> <p>Az(ok) a frekvenciasáv(ok), amely(ek)en a rádióberendezés működik: 433.92MHz</p>

	Az abban a frekvenciasávban vagy azokban a frekvenciasávokban továbbított maximális jelerősség, amely(ek)ben a rádióberendezés üzemel: -17 dBm
16_RED_MT_Maltese	
DIKJARAZZJONI SSIMPLIFIKATA TA' KONFORMITÀ TAL-UE	B'dan, Continental Automotive GmbH, middikjara li dan it-tip ta' tagħmir tar-radju S180052094/TIS-03 huwa konformi maad-Direttiva 2014/53/UE. It-test kollu tad-dikjarazzjoni ta' konformità tal-UE huwa disponibbli f'dan l-indirizz tal-Internet li ġejj: http://www.mitsubishi-motors.com/en/red-doc/
	Il-medda/meded tal-frekwenza li jahdem fihom it-tagħmir tar-radju: 433.92MHz
	Il-potenza massima tal-frekwenza tar-radju trażmessa fil-medda/meded tal-frekwenza li jahdem fihom it-tagħmir tar-radju: -17 dBm
17_RED_NL_Dutch	
VEREENVOUDIGDE EUCONFORMITEITSVERKLARING	Hierbij verklaar ik, Continental Automotive GmbH, dat het type radioapparaatuur S180052094/TIS-03 conform is met Richtlijn 2014/53/EU. De volledige tekst van de EU-conformiteitsverklaring kan worden geraadpleegd op het volgende internetadres: http://www.mitsubishi-motors.com/en/red-doc/
	Frequentieband(en) waarin de radioapparaatuur functioneert: 433.92MHz
	Maximaal radiofrequent vermogen uitgezonden in de frequentieband(en) waarin de radioapparaatuur functioneert: -17 dBm
18_RED_PL_Polish	
UPROSZCZONA DEKLARACJA ZGODNOŚCI UE	Continental Automotive GmbH niniejszym oświadcza, że typ urządzenia radiowego S180052094/TIS-03 jest zgodny z dyrektywą 2014/53/UE. Pełny tekst deklaracji zgodności UE jest dostępny pod następującym adresem internetowym: http://www.mitsubishi-motors.com/en/red-doc/

	Zakresu(-ów) częstotliwości, w którym (których) pracuje urządzenie radiowe: 433.92MHz
	Maksymalnej mocy częstotliwości radiowej emitowanej w zakresie(-ach) częstotliwości, w którym (których) pracuje urządzenie radiowe: -17 dBm
19_RED_PT_Portuguese	
DECLARAÇÃO UE DE CONFORMIDADE SIMPLIFICADA	O(a) abaixo assinado(a) Continental Automotive GmbH declara que o presente tipo de equipamento de rádio S180052094/TIS-03 está em conformidade com a Diretiva 2014/53/UE. O texto integral da declaração de conformidade está disponível no seguinte endereço de Internet: http://www.mitsubishi-motors.com/en/red-doc/
	A(s) banda(s) de frequências em que o equipamento de rádio funciona: 433.92MHz
	A potência máxima de radiofrequências transmitida na(s) banda(s) de frequências em que o equipamento de rádio funciona: -17 dBm
20_RED_RO_Romanian	
DECLARAȚIA UE DE CONFORMITATE SIMPLIFICATĂ	Prin prezenta, Continental Automotive GmbH declară că tipul de echipamente radio S180052094/TIS-03 este în conformitate cu Directiva 2014/53/UE. Textul integral al declarației UE de conformitate este disponibil la următoarea adresă internet: http://www.mitsubishi-motors.com/en/red-doc/
	Banda (benzile) de frecvențe în care funcționează echipamentul radio: 433.92MHz
	Puterea maximă de radiofrecvență transmisă în banda (benzile) de frecvențe în care funcționează echipamentul radio: -17 dBm
21_RED_SK_Slovak	
ZJEDNODUŠENÉ EÚ VYHLÁSENIE O ZHODE	Continental Automotive GmbH týmto vyhlasuje, že rádiové zariadenie typu S180052094/TIS-03 je v súlade so smernicou

	<p>2014/53/EÚ. Úplné EÚ vyhlásenie o zhode je k dispozícii na tejto internetovej adrese: http://www.mitsubishi-motors.com/en/red-doc/</p> <p>Frekvenčné pásmo resp. pásma, v ktorých rádiové zariadenie pracuje: 433,92MHz</p> <p>Maximálny vysokofrekvenčný výkon prenášaný vo frekvenčnom pásme, resp. pásmach, v ktorých rádiové zariadenie pracuje: -17 dBm</p>
22_RED_SL_Slovenian	
POENOSTAVLJENA IZJAVA EU O SKLADNOSTI	<p>Continental Automotive GmbH potrjuje, da je tip radijske opreme S180052094/TIS-03 skladen z Direktivo 2014/53/EU. Celotno besedilo izjave EU o skladnosti je na voljo na naslednjem spletnem naslovu: http://www.mitsubishi-motors.com/en/red-doc/</p> <p>Frekvenčni pas ali pasovi, na katerih deluje radijska oprema: 433.92MHz</p> <p>Največja energija za radijsko frekvenco, preneseno po frekvenčnem pasu ali pasovih, na katerih radijska oprema deluje: -17 dBm</p>
23_RED_FI_Finnish	
YKSINKERTAISTETTU EUVAATIMUSTENMUKAISUUSVAKUUTUS	<p>Continental Automotive GmbH vakuuttaa, että radiolaitetyypin S180052094/TIS-03 on direktiivin 2014/53/EU mukainen. EUvaatimustenmukaisuusvakuutuksen täysimittainen teksti on saatavilla seuraavassa internetosoitteessa: http://www.mitsubishi-motors.com/en/red-doc/</p> <p>Radiolaajuudet, joilla radiolaitte toimii: 433.92MHz</p> <p>Suurin mahdollinen lähetysteho radiolaajuuksilla, joilla radiolaitte toimii: -17 dBm</p>
24_RED_SV_Swedish	
FÖRENKLAD EUFÖRSÄKRAN OM ÖVERENSSTÄMMELSE	<p>Härmed försäkrar Continental Automotive GmbH att denna typ av radioutrustning S180052094/TIS-03 överensstämmer med direktiv 2014/53/EU. Den fullständiga texten till EU-försäkran</p>

	<p>om överensstämmelse finns på följande webbadress: http://www.mitsubishi-motors.com/en/red-doc/</p> <p>Det eller de frekvensband där radioutrustningen arbetar: 433.92MHz</p> <p>Den maximala radiofrekvenseffekt som överförs inom det eller de frekvensband där radioutrustningen arbetar: -17 dBm</p>
25_RED_NO_Norwegian	
FORENKLET EU-ERKLÆRING	<p>Continental Automotive GmbH erklærer herved at utstyret S180052094/TIS-03 er i samsvar med de grunnleggende krav og øvrige relevante krav i direktiv 2014/53/EU. Den fullstendige teksten i EU-deklarasjon finnes på følgende internetadresse: http://www.mitsubishi-motors.com/en/red-doc/</p> <p>Frekvensband der radioustyr opererer: 433.92MHz</p> <p>Maksimal radiofrekvent energi som overføres i de frekvensbånd i hvilke det radioustyr opererer: -17 dBm</p>
26_RED_IS_Icelandic	
Einfalda ESB LEYFISYFIRLÝSING	<p>Hér með lýsir Continental Automotive GmbH yfir því að S180052094/TIS-03 er í samræmi við grunnkröfur og aðrar kröfur, sem gerðar eru í tilskipun 2014/53/EC. The fullur texti af ESB-samræmisyfirlýsing er í boði á eftirfarandi veffangi: http://www.mitsubishi-motors.com/en/red-doc/</p> <p>Tíðnisvið sem þráðlausan búnað starfar: 433.92MHz</p> <p>Hámarks útvarp-tíðni máttur send í tíðnisviðum sem þráðlausan búnað starfar: -17 dBm</p>

A) Generic information:**Manufacturer Postal Address**

OMRON Automotive Electronics Co. Ltd.
6368 Nenjozaka, Okusa, Komaki, Aichi 485-0802 JAPAN

B) Language Text:

01_RED_BG_Bulgarian	
ОПРОСТЕНА ЕС	С настоящия документ OMRON Automotive Electronics Co. Ltd., декларира, че
ДЕКЛАРАЦИЯ ЗА	J166E, GHR-M001, GHR-M014, R328E съответстват с Директива 2014/53/ЕС. За
СЪОТВЕТСТВИЕ	подробности посетете следния адрес: http://www.mitsubishi-motors.com/en/red-doc/
	Честотни ленти, на които работи радиооборудването: J166E, GHR-M014 : 433.92MHz GHR-M001, R328E : 125kHz
	Максималната радиочестотна енергия, предавана по честотната лента (честотните ленти) на която/които работи радиооборудването: J166E : 11µW GHR-M014 : 10µW GHR-M001 : 82dBµV/m [@3m] R328E : 94dBµV/m [@3m]
	ВНИМАНИЕ Риск от експлозия, ако батерията е сменена с неправилния вид. Изхвърлете използваните батерии според инструкциите.
02_RED_ES_Spanish	
DECLARACIÓN	Por la presente, OMRON Automotive Electronics Co. Ltd., declara que J166E,
UE DE	GHR-M001, GHR-M014, R328E cumple con la Directiva 2014/53/UE. Para más
CONFORMIDAD	información, acceda a la siguiente URL:
SIMPLIFICADA	http://www.mitsubishi-motors.com/en/red-doc/
	Banda(s) de frecuencia en que opera el equipo radioeléctrico: J166E, GHR-M014 : 433.92MHz GHR-M001, R328E : 125kHz
	Máxima potencia radioeléctrica transmitida en la(s) banda(s) de frecuencia en las que opera el equipo radioeléctrico: J166E : 11µW

	GHR-M014 : 10µW GHR-M001 : 82dBµV/m [@3m] R328E : 94dBµV/m [@3m]
	ADVERTENCIA Existe riesgo de explosión si sustituye la batería por un modelo inadecuado. Desahégase de las baterías usadas siguiendo las instrucciones.
03_RED_CS_Czech	
ZJEDNODUŠENÉ EU PROHLÁŠENÍ O SHODĚ	Společnost OMRON Automotive Electronics Co. Ltd. tímto prohlašuje, že J166E, GHR-M001, GHR-M014, R328E dodržuje Nařízení 2014/53/EU. Podrobné informace naleznete na následující URL: http://www.mitsubishi-motors.com/en/red-doc/
	Frekvenční pásmo (pásma), ve kterých rádiové zařízení funguje: J166E, GHR-M014 : 433.92MHz GHR-M001, R328E : 125kHz
	Maximální radiofrekvenční energie, přenášené v rámci frekvenčních pásem, ve kterých rádiové zařízení funguje: J166E : 11µW GHR-M014 : 10µW GHR-M001 : 82dBµV/m [@3m] R328E : 94dBµV/m [@3m]
	UPOZORNĚNÍ Nebezpečí výbuchu, pokud je baterie nahrazena nesprávným typem. Použijte baterie zlikvidujte v souladu s pokyny.
04_RED_DA_Danish	
FORENKLET EU-OVERENSSTE MMELSESERKLEÆ RING	OMRON Automotive Electronics Co. Ltd. erklærer herved, at J166E, GHR-M001, GHR-M014, R328E er i overensstemmelse med Direktiv 2014/53/EU. For detaljer, bedes du adgang til følgende webadresse: http://www.mitsubishi-motors.com/en/red-doc/
	Frekvensbåndet (er), hvor radiostyret driver: J166E, GHR-M014 : 433.92MHz GHR-M001, R328E : 125kHz
	Maksimal radiofrekvens effekt transmitteret i frekvensbåndet (er), hvor radiostyret driver: J166E : 11µW GHR-M014 : 10µW GHR-M001 : 82dBµV/m [@3m]

	R328E : 94dB μ V/m [@3m] FORSIGTIGHED Risiko for eksplosion hvis batteriet udskiftes med et af forkert type. Bortskaf brugte batterier i henhold til instruktionerne.
05_RED_DE_German	
VEREINFACHTE EU-KONFORMITÄ TSERKLÄRUNG	Hiermit erklärt OMRON Automotive Electronics Co. Ltd., dass J166E, GHR-M001, GHR-M014, R328E in Übereinstimmung mit der Richtlinie 2014/53/EU steht. Für Einzelheiten greifen Sie auf folgende URL zu: http://www.mitsubishi-motors.com/en/red-doc/ Frequenzband/Frequenzbänder, in dem das Funkgerät betrieben wird: J166E, GHR-M014 : 433.92MHz GHR-M001, R328E : 125kHz Maximal übertragene Hochfrequenzleistung im Frequenzband/Frequenzbänder, in dem das Funkgerät betrieben wird: J166E : 11 μ W GHR-M014 : 10 μ W GHR-M001 : 82dB μ V/m [@3m] R328E : 94dB μ V/m [@3m]
	VORSICHT Explosionsgefahr, wenn die Batterie durch einen falschen Typ ersetzt wird. Entsorgen Sie die gebrauchten Batterien gemäß den Anweisungen.
06_RED_ET_Estonian	
LIHTSUSTATUD ELI VASTAVUSDEKL ARATSIION	Käesolevaga teatab OMRON Automotive Electronics Co. Ltd., et J166E, GHR-M001, GHR-M014, R328E on kooskõlas Direktiiviga 2014/53/EL. Üksikasjade nägemiseks külastage võrguadressi: http://www.mitsubishi-motors.com/en/red-doc/ Sagedusala(d), milles raadioseade töötab: J166E, GHR-M014 : 433.92MHz GHR-M001, R328E : 125kHz Maksimaalne saatevõimsus/võimsustihedus sagedusala(de)s, milles raadioseade töötab: J166E : 11 μ W GHR-M014 : 10 μ W GHR-M001 : 82dB μ V/m [@3m] R328E : 94dB μ V/m [@3m]
	HOIATUS

	Plahvatusoht, kui patarei asendatakse valet tüüpi patareiga. Kõnvaldage kasutatud patareid vastavalt juhendile.
07_RED_EL_Greek	
ΑΠΛΟΥΣΤΕΥΜΕΝ Η ΔΗΛΩΣΗ ΣΥΜΜΟΡΦΩΣΗΣ ΕΕ	Με το παρόν, η OMRON Automotive Electronics Co. Ltd., δηλώνει ότι τα J166E, GHR-M001, GHR-M014, R328E συμμορφώνονται με την Οδηγία 2014/53/ΕΕ. Για λεπτομέρειες, επισκεφτείτε την εξής ιστοσελίδα: http://www.mitsubishi-motors.com/en/red-doc/ Ζώνες συχνοτήτων στις οποίες λειτουργεί ο ραδιοεξοπλισμός: J166E, GHR-M014 : 433.92MHz GHR-M001, R328E : 125kHz Μέγιστη εκπεμπόμενη ισχύς ραδιοσυχνότητων στις ζώνες συχνοτήτων στις οποίες λειτουργεί ο ραδιοεξοπλισμός: J166E : 11μW GHR-M014 : 10μW GHR-M001 : 82dBμV/m [@3m] R328E : 94dBμV/m [@3m] ΠΡΟΣΟΧΗ Κίνδυνος έκρηξης σε περίπτωση αντικατάστασης της μπαταρίας με άλλη εσφαλμένου τύπου. Απορρίψτε τις άδειες μπαταρίες σύμφωνα με τις οδηγίες.
08_RED_EN_English	
SIMPLIFIED EU DECLARATION OF CONFORMITY	Hereby, OMRON Automotive Electronics Co. Ltd., declares that J166E, GHR-M001, GHR-M014, R328E are in compliance with Directive 2014/53/EU. For details, please access the following URL: http://www.mitsubishi-motors.com/en/red-doc/ Frequency band(s) in which the radio equipment operates: J166E, GHR-M014 : 433.92MHz GHR-M001, R328E : 125kHz Maximum radio-frequency power transmitted in the frequency band(s) in which the radio equipment operates: J166E : 11μW GHR-M014 : 10μW GHR-M001 : 82dBμV/m [@3m] R328E : 94dBμV/m [@3m] CAUTION Risk of explosion if battery is replaced by an incorrect type. Dispose of used batteries according to the instructions.

09_RED_FR_French	
DECLARATION UE DE CONFORMITE SIMPLIFIEE	Par le présent document OMRON Automotive Electronics Co. Ltd., déclare que J166E, GHR-M001, GHR-M014, R328E sont conformes à la Directive 2014/53/UE. Pour plus d'informations visitez la page suivante: http://www.mitsubishi-motors.com/en/red-doc/
	Bandes de fréquence dans lesquelles fonctionne l'appareil à radiofréquence: J166E, GHR-M014 : 433.92MHZ GHR-M001, R328E : 125kHz
	Puissance radiofréquence maximale transmise dans la (es) bande(s) de fréquence dans laquelle/lesquelles l'appareil à radiofréquence fonctionne: J166E : 1µW GHR-M014 : 10µW GHR-M001 : 82dBµV/m [@3m] R328E : 94dBµV/m [@3m]
	ATTENTION Risque d'explosion si la pile est remplacée par un type incorrect de pile. Jetez les piles usagées conformément aux instructions.
10_RED_IS_Icelandic	
EINFÖLDUÐ ESB-SAMRÆMISY FIRLYSING	Hér, OMRON Automotive Electronics Co. Ltd., segir að J166E, GHR-M001, GHR-M014, R328E þeir eru í samræmi við Úrskurði 2014/53 /ESB. Fyrir frekari upplýsingar, vinsamlegast aðgang að eftirfarandi URL: http://www.mitsubishi-motors.com/en/red-doc/
	Tíðnisviði (s) sem þráðlausan búnað undirrita burt: J166E, GHR-M014 : 433.92MHZ GHR-M001, R328E : 125kHz
	Mámarks útvarp-tíðni máttur miðlað á tíðnisviðinu (s) sem þráðlausan búnað undirrita burt: J166E : 1µW GHR-M014 : 10µW GHR-M001 : 82dBµV/m [@3m] R328E : 94dBµV/m [@3m]
	VARÚÐ Það er hætt á sprengingu ef rafhladan er skipt með rangri tegund. Notuðu rafhlöður eru fargað samkvæmt leiðbeiningum.
11_RED_HR_Croatian	
POJEDNOSTAVLJ	Ovim putem tvrtka OMRON Automotive Electronics Co. Ltd. objavljuje da je J166E,

ENA EU IZJAVA O SUKLADNOSTI	GHR-M001, GHR-M014, R328E sukladna s Direktivom 2014/53/EU. Za pojedinosti posjetite sljedeći URL: http://www.mitsubishi-motors.com/en/red-doc/ Frekvencijski pojas (pojasevi) u kojima radi radio oprema: J166E, GHR-M014 : 433.92MHz GHR-M001, R328E : 125kHz Maksimalna snaga radio frekvencije prenesena u frekvencijske pojaseve u kojima radi radio oprema: J166E : 11µW GHR-M014 : 10µW GHR-M001 : 82dBµV/m [@3m] R328E : 94dBµV/m [@3m] OPREZ Opasnost od eksplozije baterije ako se zamijeni s neodgovarajućim tipom. Odbacite baterije u skladu s uputama.
12_RED_IT_Italian	
DICHIARAZIONE DI CONFORMITÀ UE SEMPLIFICATA	Con la presente, OMRON Automotive Electronics Co. Ltd., dichiara che J166E, GHR-M001, GHR-M014, R328E sono conformi alla Direttiva 2014/53/UE. Per ulteriori dettagli, accedere al seguente URL: http://www.mitsubishi-motors.com/en/red-doc/ Bandale di frequenza su cui operano le apparecchiature radio: J166E, GHR-M014 : 433.92MHz GHR-M001, R328E : 125kHz Massima alimentazione a radiofrequenza trasmessa sull'ale bandale di frequenza su cui operano le apparecchiature radio: J166E : 11µW GHR-M014 : 10µW GHR-M001 : 82dBµV/m [@3m] R328E : 94dBµV/m [@3m] ATTENZIONE L'utilizzo di una batteria di diverso tipo può provocare esplosioni. Smaltire le batterie usate in conformità con le istruzioni.
13_RED_LV_Latvian	
VIENKĀRŠOTA ES ATBILSTĪBAS DEKLARĀCIJA	Ar šo uzņēmums OMRON Automotive Electronics Co. Ltd. apstiprina, ka J166E, GHR-M001, GHR-M014, R328E atbilst Direktīvas 2014/53/ES prasībām. Detalizētu informāciju, lūdzu, skatiet šajā vietnē URL: http://www.mitsubishi-motors.com/en/red-doc/

	<p>Frekvences josla(-s), kurās darbojas radio aprīkojums: J166E, GHR-M014 : 433.92MHz GHR-M001, R328E : 125kHz</p> <p>Radio aprīkojuma darbības frekvencju joslā(-s) raidītā maksimālā radiofrekvences jauda: J166E : 11µW GHR-M014 : 10µW GHR-M001 : 82dBµV/m [@3m] R328E : 94dBµV/m [@3m]</p> <p>BRĪDINĀJUMS</p> <p>Ja akumulators tiek aizvietots ar nepareiza veida akumulatoru, pastāvs sprādzienbīstamības risks. Izlietotos akumulatorus utilizējiet atbilstoši instrukcijām.</p>
	<p>14_RED_LT_Lithuanian</p> <p>SUPAPRASTINTA ES ATTIKTIES DEKLARACIJA</p> <p>Šiuo dokumentu OMRON Automotive Electronics Co. Ltd. pareiškia, kad J166E, GHR-M001, GHR-M014, R328E atitinka Direktīvā 2014/53/ES. Norādāmi īssmesnēs informācijas, apsilankykite šiuo URL adresu: http://www.mitsubishi-motors.com/en/red-doc/</p> <p>Dažnio juostia (-os), kurioje veikia radijo įranga: J166E, GHR-M014 : 433.92MHz GHR-M001, R328E : 125kHz</p> <p>Didžiausia radijo dažnio galia, perduodama dažnio juosta (-os), kurioje veikia radijo įranga: J166E : 11µW GHR-M014 : 10µW GHR-M001 : 82dBµV/m [@3m] R328E : 94dBµV/m [@3m]</p> <p>ĮSPĖJIMAS</p> <p>Pakeitus bateriją netinkamo tipo baterija, kyla sprogimo pavojus. Panaudotas baterijas šalinkyte pagal instrukcijas.</p>
	<p>15_RED_HU_Hungarian</p> <p>EGYSZERŰSÍTET T EU-MEGFELELŐS ÉGI NYILATKOZAT</p> <p>Alulírott, OMRON Automotive Electronics Co. Ltd., kijelenti, hogy J166E, GHR-M001, GHR-M014, R328E megfelel a 2014/53/EU Irányelvnek. A részletekért nyissa meg a következő URL hivatkozást: http://www.mitsubishi-motors.com/en/red-doc/</p>

	<p>A rádióberendezés működéséhez szükséges frekvenciasáv(ok): J166E, GHR-M014 : 433.92MHz GHR-M001, R328E : 125kHz</p> <p>A rádióberendezés működéséhez szükséges frekvenciasáv(ok) maximális rádiófrekvenciás teljesítménye: J166E : 11µW GHR-M014 : 10µW GHR-M001 : 82dBµV/m [@3m] R328E : 94dBµV/m [@3m]</p> <p>VIGYÁZAT A nem megfelelő típusú csereelem robbásveszélyt okozhat. Az utasítások betartásával ártalmatlanítsa a használt elemeket.</p>
16_RED_MT_Maltese	
DIKJARAZZJONI	OMRON Automotive Electronics Co. Ltd., tírdikjara li J166E, GHR-M001,
SSIMPLIFIKATA	GHR-M014, R328E huma f konformità mad-Direttiva 2014/53/UE. Ghal dettalji, jekk
TA' KONFORMITÀ	jogħgħbok accessa L-JURL li gejjja: http://www.mitsubishi-motors.com/en/red-doc/
TAL-UE	Medda(meded) ta' frekwenza li fina jopera t-tagħmir tar-radju: J166E, GHR-M014 : 433.92MHz GHR-M001, R328E : 125kHz
	Qawwa massima tal-medda ta' frekwenza tar-radju trazimessa fil-medda(meded) tal-frekwenza li fina jopera t-tagħmir tar-radju: J166E : 11µW GHR-M014 : 10µW GHR-M001 : 82dBµV/m [@3m] R328E : 94dBµV/m [@3m]
	ATTENZJONI Hemm ir-riskju ta' splużjoni jekk il-batterija tkun sosstitwita bit-tip żbaljat. Armi l-batteriji użati skont l-istruzzjonijiet.
17_RED_NL_Dutch	
VEREENVOUDIGD	Hiermee verklaart OMRON Automotive Electronics Co. Ltd., dat J166E, GHR-M001,
EU-CONFORMITEI	GHR-M014, R328E in overeenstemming zijn met Richtlijn 2014/53/EU. Klik voor
TSVERKLARING	meer informatie op de onderstaande link: http://www.mitsubishi-motors.com/en/red-doc/
	Frequentieband(en) waarop de radioapparatuur werkt: J166E, GHR-M014 : 433.92MHz

	GHR-M001, R328E : 125kHz Maximum radiofrequentie-vermogen doorgegeven in de frequentieband(en) waarop de radioapparatuur werkt: J166E : 11µW GHR-M014 : 10µW GHR-M001 : 82dBµV/m [@3m] R328E : 94dBµV/m [@3m] LET OP Risico op explosie als batterij door een onjuist type wordt vervangen. Gooi gebruikte batterijen volgens de instructie weg.
18_RED_PL_Polish	
UPROSZCZONA	OMRON Automotive Electronics Co. Ltd. niniejszym oświadcza, że produkty
DEKLARACJA	J166E, GHR-M001, GHR-M014, R328E spełniają wymogi Dyrektywy 2014/53/UE.
ZGODNOŚCI UE	Szczegółowe informacje są dostępne pod następującym adresem URL: http://www.mitsubishi-motors.com/en/red-doc/
	Pasmo(-a) częstotliwości obsługiwane przez sprzęt radiowy: J166E, GHR-M014 : 433.92MHz GHR-M001, R328E : 125kHz
	Maksymalna przesyłana moc o częstotliwości radiowej w paśmie (pasmach) częstotliwości obsługiwanych przez sprzęt radiowy: J166E : 11µW GHR-M014 : 10µW GHR-M001 : 82dBµV/m [@3m] R328E : 94dBµV/m [@3m]
	UWAGA Ryzyko wybuchu w przypadku wymiany baterii na nieprawidłowy rodzaj. Zużyte baterie należy zutylizować zgodnie z instrukcjami.
19_RED_PT_Portuguese	
DECLARAÇÃO UE	Por isto, OMRON Automotive Electronics Co. Ltd., declara que J166E, GHR-M001,
DE	GHR-M014, R328E estão em conformidade com a Directiva 2014/53/UE. Para mais
CONFORMIDADE	detalhes, favor aceder acessar ao seguinte URL:
SIMPLIFICADA	http://www.mitsubishi-motors.com/en/red-doc/
	Banda (s) de frequência em que o equipamento de rádio opera: J166E, GHR-M014 : 433.92MHz GHR-M001, R328E : 125kHz
	Potência máxima de radiofrequência transmitida na (s) faixa (s) de frequência em

	GHR-M001 : 82dB μ V/m [@3m] R328E : 94dB μ V/m [@3m]
	UPOZORNENIE Nebezpečnostvo výbuchu, ak je batéria nahradená nesprávnym typom. Použitie batérie zlikvidujte v súlade s pokynmi.
22_RED_SL_Slovenian	
POENOSTAVLJEN	S tem podjetje OMRON Automotive Electronics Co. Ltd., izjavlja, da so J166E, GHR-M001, GHR-M014, R328E v skladu z Direktivo 2014/53/EU. Za podrobnosti
A IZJAVA EU O SKLADNOSTI	odprite naslednji URL: http://www.mitsubishi-motors.com/en/red-doc/ Frekvenčni pas(ovi) v katerih deluje radijska oprema: J166E, GHR-M014 : 433.92MHz GHR-M001, R328E : 125kHz
	Največja radio-frekvenčna moč oddajana v frekvenčnem(ih) pasu(ovih), v katerem radijska oprema deluje: J166E : 11 μ W GHR-M014 : 10 μ W GHR-M001 : 82dB μ V/m [@3m] R328E : 94dB μ V/m [@3m]
	POZOR Tveganje eksplozije v primeru, da baterijo zamenjate z napačnim tipom. Izpraznjene baterije zavrzite v skladu z navodili.
23_RED_FI_Finnish	
YKSINKERTAISTE TTU	OMRON Automotive Electronics Co. Ltd., ilmoittaa täten, että J166E, GHR-M001, GHR-M014, R328E noudattaa Direktiivin 2014/53/EU vaatimuksia. Saadaksesi
EU-VAATIMUSTE	lisätietoja, käytä seuraavaa URL-osoitetta:
NMUKAISUUSVA KUUTUS	http://www.mitsubishi-motors.com/en/red-doc/
	Taajuusalue(et), joilla radiolaitte toimii: J166E, GHR-M014 : 433.92MHz GHR-M001, R328E : 125kHz
	Suurin radiolaitteelta lähetettävä teho taajuusalueella(-alueilla), joilla radiolaitte toimii: J166E : 11 μ W GHR-M014 : 10 μ W GHR-M001 : 82dB μ V/m [@3m] R328E : 94dB μ V/m [@3m]

	<p>HUOMIO</p> <p>Räjähdyksvaara, jos paristo vaihdetaan väärään tyyppiin.</p> <p>Noudata ohjeita käytettyjen paristojen hävittämisessä.</p>
24_RED_SV_Swedish	
FÖRENKLAD	OMRON Automotive Electronics Co. Ltd. förklarar jag härmed att J166E,
EU-FÖRSÄKRAN	GHR-M001, GHR-M014, R328E är i enlighet med Direktiv 2014/53/EU. För detaljer
OM	vänligen använd följande webbläsare: http://www.mitsubishi-motors.com/en/red-doc/
ÖVERENSSTÄMM	
ELSE	
	<p>Frekvensband (er) i hvilken radio utrustning en arbetar:</p> <p>J166E, GHR-M014 : 433.92MHz</p> <p>GHR-M001, R328E : 125kHz</p>
	<p>Maximala radiofrekvens makt överförs i frekvens mottagningsläger som driver radioutrustning:</p> <p>J166E : 11µW</p> <p>GHR-M014 : 10µW</p> <p>GHR-M001 : 82dBµV/m [@3m]</p> <p>R328E : 94dBµV/m [@3m]</p>
	FÖRSIKTIGHET
	Risk för explosion om batteriet ersätts av fel batterityp.
	Kassera använda batterier enligt instruktionerna.
25_RED_NO_Norwegian	
FORENKLET EU	Herved OMRON Automotive Electronics Co. Ltd., erklærer at J166E, GHR-M001,
KONFORMITETSE	GHR-M014, R328E samsvar med Resolusjon 2014/53/EU. For ytterligere
RKLÆRING	informasjon, vennligst sjekk følgende URL:
	http://www.mitsubishi-motors.com/en/red-doc/
	Frekvens bånd (s) der radioutstyret fungerer:
	J166E, GHR-M014 : 433.92MHz
	GHR-M001, R328E : 125kHz
	Maksimal radiofrekvensen strøm ble sendt i frekvensbånd(s) som radioutstyret fungerer:
	J166E : 11µW
	GHR-M014 : 10µW
	GHR-M001 : 82dBµV/m [@3m]
	R328E : 94dBµV/m [@3m]
	FORSIKTIG

OGKE20E1

Declaration of Conformity 13- 51

	Det er fare for eksplosjon hvis batteriet er erstattet med feil type. I henhold til instruksjonene, er batteriene fjernet.
26_RED_TR_Turkish	
AB UYGUNLUK	OMRON Automotive Electronics Co. Ltd., şirketi J166E, GHR-M001, GHR-M014, R328E ürünlerinin 2014/53/EU Direktifi ile uyumlu olduğunu beyan eder. Ayrıntılar için lütfen aşağıdaki URL'ye erişin: http://www.mitsubishi-motors.com/en/red-doc/
BASITLEŞTİRİLMİŞ BEYAN	Radyo ekipmanının çalıştığı frekans bantları: J166E, GHR-M014 : 433.92MHz GHR-M001, R328E : 125kHz Radyo ekipmanının çalıştığı frekans bantlarında iletilen maksimum radyofrekans gücü: J166E : 11µW GHR-M014 : 10µW GHR-M001 : 82dBµV/m [@3m] R328E : 94dBµV/m [@3m]
	DİKKAT Pil, yanlış tip pille değiştirilirse, patlama riski vardır. Kullanılmış pilleri talimatlara göre imha edin.
27_RED_MK_Macedonian	
ПОЕДНОСТАВЕН А ДЕКЛАРАЦИЈА ЗА СОГЛАСНОСТ НА ЕУ	Со оттука, OMRON Automotive Electronics Co. Ltd. изјавува дека J166E, GHR-M001, GHR-M014, R328E е во согласност со Директивата 2014/53/EU. За подетални информации, отворете ја следнава УРЛ: http://www.mitsubishi-motors.com/en/red-doc/
	Радио опремата работи на следниот радиофреквенциски спектар: J166E, GHR-M014 : 433.92MHz GHR-M001, R328E : 125kHz
	Радио опремата функционира на следната максимална моќност на радио фреквенции емитувана во радиофреквенцискиот спектар: J166E : 11µW GHR-M014 : 10µW GHR-M001 : 82dBµV/m [@3m] R328E : 94dBµV/m [@3m]
	ВНИМАНИЕ Опасност од експлозија ако батеријата се замени со неправилен тип. Фрлете ги употребените батери во согласност со упатствата.
28_RED_SQ_Albanian	

DEKLARATÉ THJESHTUAR SË KONFORMITETIT TË BE-SË	Këtu, OMRON Automotive Electronics Co. Ltd., deklaron se J166E, GHR-M001, GHR-M014, R328E janë në përputhje me Direktivën 2014/53/EU. Për hollësi, ju lutem hapni URL-në e mëposhtme: http://www.mitsubishi-motors.com/en/red-doc/
	Banda(t) e frekuencës me të cilat punojnë pajisjet radio: J166E, GHR-M014 : 433.92MHz GHR-M001, R328E : 125kHz
	Fuqia maksimale radio-frekuencë e transmetuar në bandën(at) e frekuencave në të cilën punojnë pajisjet radio: J166E : 11µW GHR-M014 : 10µW GHR-M001 : 82dBµV/m [@3m] R328E : 94dBµV/m [@3m]
	KUJDES Rrezik shpërthimi në qoftë se bateria është zëvendësuar nga një lloj i gabuar. Shkatiëro bateritë e përdorura sipas udhëzimeve.
29_RED_XX_Montenegrin	
POJEDNOSTAVLJ ENA EU IZJAVA O USAGLAŠENOSTI	Ovim putem OMRON Automotive Electronics Co. Ltd., izjavljuje da su J166E, GHR-M001, GHR-M014, R328E u skladu sa Odredbom 2014/53/EU. Za više detalja, pristupite sljedećoj URL adresi: http://www.mitsubishi-motors.com/en/red-doc/
	Frekventni opseg u kojem funkcioniše radio oprema: J166E, GHR-M014 : 433.92MHz GHR-M001, R328E : 125kHz
	Maksimalna prenesena snaga radio frekvencije u frekventnom opsegu u kojem funkcioniše radio oprema : J166E : 11µW GHR-M014 : 10µW GHR-M001 : 82dBµV/m [@3m] R328E : 94dBµV/m [@3m]
	OPREZ Postoji rizik od eksplozije ako se baterija zamijeni pogrešnom vrstom. Odložite iskorišćene baterije u skladu sa uputstvima.
30_RED_KA_Georgian	
EU გამარტვერულო შესაბამისობის	კომპანია OMRON Automotive Electronics Co. Ltd. აცხადებს, რომ J166E, GHR-M001, GHR-M014, R328E არის 2014/53/EU დირექტივის სრულ შესაბამისობაში. დაწვრილებითი ინფორმაციისთვის იხილეთ შემდეგი ბმული:

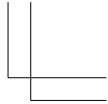
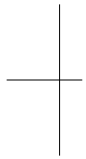
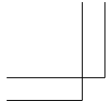

13- 54 Declaration of Conformity

<p>განცხადების</p>	<p>http://www.mitsubishi-motors.com/en/red-doc/ სიხშირის ტალღები, რომლებზეც მუშაობს რადიო: J166E, GHR-M014 : 433.92MHz GHR-M001, R328E : 125kHz რადიო მოწყობილობის რადიო-სიხშირის მაქსიმალური სიმძლავრე: J166E : 1µW GHR-M014 : 10µW GHR-M001 : 82dBµV/m [@3m] R328E : 94dBµV/m [@3m] გაფრთხილება სხვა ტიპის ელემენტით შეცვლის შემთხვევაში არსებობს აფეთქების რისკი. გამოყენებული ელემენტების განკარგვის მოახდინეთ ინსტრუქციის თანახმად.</p>
---------------------------	--

OGKE20E1

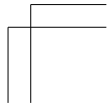
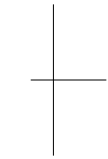

低功率電波輻射性電機管理辦法

第十二條

經型式認證合格之低功率射頻電機，非經許可，公司、商號或使用者均不得擅自變更頻率、加大功率或變更原設計之特性及功能。

第十四條

低功率射頻電機之使用不得影響飛航安全及干擾合法通信；經發現有干擾現象時，應立即停用，並改善至無干擾時方得繼續使用。

前項合法通信，指依電信法規定作業之無線電通信。

低功率射頻電機須忍受合法通信或工業、科學及醫療用電波輻射性電機設備之干擾。

A) Generic information:

Manufacturer Postal Address

Model Name: TCUMY19
 Brand Name: Visteon Corporation
 One Village center drive, Van Buren Township
 48111-5711 Michigan
 United States of America

CE MARK:



B) Language Text:

01_RED_BG_Bulgarian	С настоящото Visteon Corporation , декларира, че TCUMY19 са в съответствие с ОПРОСТЕНА ЕС ДЕКЛАРАЦИЯ ЗА СЪОТВЕТСТВИЕ Директива 2014/53/ЕС. За повече информация, моля, посетете следния URL адрес: https://www.mitsubishi-motors.com/en/red-doc/ Честотни ленти, на които работи радиоборудването: TX (MHz): 1920 - 1980, 1710 - 1785, 2500 - 2570, 880 - 915, 832 - 862, 1710.2 - 1784.8 RX (MHz): 2110 - 2170, 1805 - 1880, 2620 - 2690, 925 - 960, 791 - 821, 1805.2 - 1879.8 Максималната радиочестотна енергия, предавана по честотната лента (честотните ленти) на която/които работи радиоборудването: 33dBm
02_RED_ES_Spanish	Por este medio, Visteon Corporation , declara que TCUMY19 están en conformidad con la DECLARACIÓN UE DE CONFORMIDAD SIMPLIFICADA Directiva 2014/53/UE. Para obtener más detalles, acceda a la siguiente URL: https://www.mitsubishi-motors.com/en/red-doc/ Banda(s) de frecuencia en que opera el equipo radioeléctrico: TX (MHz): 1920 - 1980, 1710 - 1785, 2500 - 2570, 880 - 915, 832 - 862, 1710.2 - 1784.8 RX (MHz): 2110 - 2170, 1805 - 1880, 2620 - 2690, 925 - 960, 791 - 821, 1805.2 - 1879.8 Máxima potencia radioeléctrica transmitida en la(s) banda(s) de frecuencia en las que opera el equipo radioeléctrico: 33dBm

03_RED_CS_Czech	
ZJEDNODUŠENÉ EU PROHLÁŠENÍ O SHODĚ	Tímto Visteon Corporation , prohlašuje, že TCUMY19 jsou v souladu se směrnicí 2014/53/EU. Podrobnosti naleznete na následující internetové adrese: https://www.mitsubishi-motors.com/en/red-doc/
	Frekvenční pásmo (pásmo), ve kterých rádiové zařízení funguje: TX (MHz) : 1920 - 1980, 1710 - 1785, 2500 - 2570, 880 - 915, 832 - 862, 1710.2 - 1784.8 RX (MHz) : 2110 - 2170, 1805 - 1880, 2620 - 2690, 925 - 960, 791 - 821, 1805.2 - 1879.8 Maximální radiofrekvenční energie, přenášené v rámci frekvenčních pásem, ve kterých rádiové zařízení funguje: 33dBm
04_RED_DA_Danish	
FORENKLET EUOVERENSSTEMM ELSEERKLÆRI NG	Hermed, Visteon Corporation , erklærer, at TCUMY19 er i overensstemmelse med direktiv 2014/53/EU. For yderligere information gå ind på følgende webadresse: https://www.mitsubishi-motors.com/en/red-doc/
	Frekvensbåndet (er), hvor radiostyret driver: TX (MHz) : 1920 - 1980, 1710 - 1785, 2500 - 2570, 880 - 915, 832 - 862, 1710.2 - 1784.8 RX (MHz) : 2110 - 2170, 1805 - 1880, 2620 - 2690, 925 - 960, 791 - 821, 1805.2 - 1879.8 Maksimal radiofrekvens effekt transmitteret i frekvensbåndet (er), hvor radiostyret driver: 33dBm
05_RED_DE_German	
VEREINFACHTE EUKONFORMITÄTBERKL ÄRUNG	Hiermit erklärt Visteon Corporation , dass TCUMY19 in Übereinstimmung mit der Richtlinie 2014/53/EU stehen. Weitere Informationen erhalten Sie über folgende URL: https://www.mitsubishi-motors.com/en/red-doc/
	Frequenzband/Frequenzbänder, in dem das Funkgerät betrieben wird: TX (MHz) : 1920 - 1980, 1710 - 1785, 2500 - 2570, 880 - 915, 832 - 862, 1710.2 - 1784.8 RX (MHz) : 2110 - 2170, 1805 - 1880, 2620 - 2690, 925 - 960, 791 - 821, 1805.2 - 1879.8 Maximal übertragene Hochfrequenzleistung im Frequenzband/Frequenzbänder, in dem das Funkgerät betrieben wird: 33dBm
06_RED_ET_Estonian	
LIHTSUSTATUD ELI VASTAVUSDEKLARATSIO ON	Käesolevaga Visteon Corporation , teatab, et TCUMY19 on kooskõlas direktiivi 2014/53/EL. Üksikasjalikuma teabe saamiseks tutvuda järgmise URL: https://www.mitsubishi-motors.com/en/red-doc/ Sagedusala(d), milles raadioseade töötab: TX (MHz) : 1920 - 1980, 1710 - 1785, 2500 - 2570, 880 - 915, 832 - 862, 1710.2 - 1784.8

OGKE20E1

Declaration of Conformity

13- 57

	RX (MHz) : 2110 - 2170, 1805 - 1880, 2620 - 2690, 925 - 960, 791 - 821, 1805.2 - 1879.8 Maksimaalne saatevõimsus/võimsustihedus sagedusala(de)s, milles raadioseade töötab: 33dBm
07_RED_EL_Greek ΑΠΛΟΣΤΥΓΜΕΝΗ ΔΗΛΩΣΗ ΣΥΜΜΟΡΦΩΣΗΣ ΕΕ	Δια του παρόντος, Visteon Corporation , δηλώνει ότι TCUMY19 είναι σε συμμόρφωση με την οδηγία 2014/53/ΕΕ. Για λεπτομέρειες, επισκεφτείτε την παρακάτω διεύθυνση URL: https://www.mitsubishi-motors.com/en/red-doc/ Ζώνες συχνοτήτων στις οποίες λειτουργεί ο ραδιοεξοπλισμός: TX (MHz) : 1920 - 1980, 1710 - 1785, 2500 - 2570, 880 - 915, 832 - 862, 1710.2 - 1784.8 RX (MHz) : 2110 - 2170, 1805 - 1880, 2620 - 2690, 925 - 960, 791 - 821, 1805.2 - 1879.8 Μέγιστη εκπεμπόμενη ισχύς ραδιοσυχνοτήτων στις ζώνες συχνοτήτων στις οποίες λειτουργεί ο ραδιοεξοπλισμός: 33dBm
08_RED_EN_English	
SIMPLIFIED EU DECLARATION OF CONFORMITY	Hereby, Visteon Corporation , declares that TCUMY19 are in compliance with Directive 2014/53/EU. For details, please access the following URL: https://www.mitsubishi-motors.com/en/red-doc/ Frequency band(s) in which the radio equipment operates: TX (MHz) : 1920 - 1980, 1710 - 1785, 2500 - 2570, 880 - 915, 832 - 862, 1710.2 - 1784.8 RX (MHz) : 2110 - 2170, 1805 - 1880, 2620 - 2690, 925 - 960, 791 - 821, 1805.2 - 1879.8 Maximum radio-frequency power transmitted in the frequency band(s) in which the radio equipment operates: 33dBm
09_RED_FR_French	
DECLARATION UE DE CONFORMITE SIMPLIFIEE	Par la présente, Visteon Corporation , déclare que TCUMY19 sont conformes à la directive 2014/53/UE. Pour plus de détails, veuillez accéder à l'URL suivante: https://www.mitsubishi-motors.com/en/red-doc/ Bandes de fréquence dans lesquelles fonctionne l'appareil à radiofréquence: TX (MHz) : 1920 - 1980, 1710 - 1785, 2500 - 2570, 880 - 915, 832 - 862, 1710.2 - 1784.8 RX (MHz) : 2110 - 2170, 1805 - 1880, 2620 - 2690, 925 - 960, 791 - 821, 1805.2 - 1879.8 Puissance radiofréquence maximale transmise dans la (les) bande(s) de fréquence dans laquelle/esquelles l'appareil à radiofréquence fonctionne: 33dBm
10_RED_IS_Islandic	
	Hér, Visteon Corporation, segir að TCUMY19 eru í samræmi við tilskipun 2014/53/ESB. Fyrir upplýsingar, vinsamlegast aðgang eftirfarandi vefsíðu:

	<p>https://www.mitsubishi-motors.com/en/red-doc/</p> <p>Tiõnsivõdi (s) sem praõlausan búnaõ undirrita burt:</p> <p>TX (MHz) : 1920 - 1980, 1710 - 1785, 2500 - 2570, 880 - 915, 832 - 862, 1710.2 - 1784.8</p> <p>RX (MHz) : 2110 - 2170, 1805 - 1880, 2620 - 2690, 925 - 960, 791 - 821, 1805.2 - 1879.8</p> <p>Mámarks útvarp-tiõni máttur miõlaõ á tiõnsivõðinu (s) sem praõlausan búnaõ undirrita burt:</p> <p>33dBm</p>
11_RED_HR_Croatian	
POJEDNOSTAVLJENA EU IZJAVA O SUKLADNOSTI	<p>Ovime Visteon Corporation, izjavljuje da je TCUMY19 su u skladu s Direktivom 2014/53/EU. Za detalje, molimo pogledajte sljedeći URL: https://www.mitsubishi-motors.com/en/red-doc/</p> <p>Frekvencijski pojasi (pojasevi) u kojima radi radio oprema:</p> <p>TX (MHz) : 1920 - 1980, 1710 - 1785, 2500 - 2570, 880 - 915, 832 - 862, 1710.2 - 1784.8</p> <p>RX (MHz) : 2110 - 2170, 1805 - 1880, 2620 - 2690, 925 - 960, 791 - 821, 1805.2 - 1879.8</p> <p>Maksimalna snaga radio frekvencije prenesena u frekvencijske pojaseve u kojima radi radio oprema:</p> <p>33dBm</p>
12_RED_IT_Italian	
DICHIARAZIONE DI CONFORMITÀ UE SEMPLIFICATA	<p>Con la presente, Visteon Corporation, dichiara che TCUMY19 sono in conformità con la direttiva 2014/53/UE. Per ulteriori informazioni, si prega di consultare il seguente URL: https://www.mitsubishi-motors.com/en/red-doc/</p> <p>Bande di frequenza su cui operano le apparecchiature radio:</p> <p>TX (MHz) : 1920 - 1980, 1710 - 1785, 2500 - 2570, 880 - 915, 832 - 862, 1710.2 - 1784.8</p> <p>RX (MHz) : 2110 - 2170, 1805 - 1880, 2620 - 2690, 925 - 960, 791 - 821, 1805.2 - 1879.8</p> <p>Massima alimentazione a radiofrequenza trasmessa sulle bande di frequenza su cui operano le apparecchiature radio:</p> <p>33dBm</p>
13_RED_LV_Latvian	
VIENKĀRŠOTA ES ATBILSĪBAS DEKLARĀCIJA	<p>Ar šo, Visteon Corporation, paziņo, ka TCUMY19 ir saskaņā ar Direktīvu 2014/53/ES. Lai iegūtu plašāku informāciju, lūdzu, apmeklējiet šādu URL: https://www.mitsubishi-motors.com/en/red-doc/</p> <p>Frekvences josla(-s), kurās darbojas radio aprīkojums:</p> <p>TX (MHz) : 1920 - 1980, 1710 - 1785, 2500 - 2570, 880 - 915, 832 - 862, 1710.2 - 1784.8</p> <p>RX (MHz) : 2110 - 2170, 1805 - 1880, 2620 - 2690, 925 - 960, 791 - 821, 1805.2 - 1879.8</p> <p>Radio aprīkojuma darbības frekvencu josla(-s) raidītā maksimālā radiofrekvences jauda:</p> <p>33dBm</p>
14_RED_LT_Lithuanian	

SUPAPRASTINTA ES ATIKTIES DEKLARACIJA	Šiuo Visteon Corporation , pareiškiau, pareiškiu, kad TCUMY19 yra laikomasi Direktyvos 2014/53/ES, Dėl išsamesnės informacijos, prašome prisijungti prie šių URL: https://www.mitsubishi-motors.com/en/red-doc/
	Dažnio juosta (-os), kurią veikia radijo įranga: TX (MHz) : 1920 - 1980, 1710 - 1785, 2500 - 2570, 880 - 915, 832 - 862, 1710.2 - 1784.8 RX (MHz) : 2110 - 2170, 1805 - 1880, 2620 - 2690, 925 - 960, 791 - 821, 1805.2 - 1879.8
	Didžiausia radijo dažnio galia, perduodama dažnio juosta (-os), kurią veikia radijo įranga: 33dBm
15_RED_HU_Hungarian	
EGYSZERŪSÍTETT EUMEGFELELŐSÉGI NYILATKOZAT	Ezállal Visteon Corporation , kijelentli, hogy TCUMY19 irányelvnek megfelelő 2014/53/EU. A részleteket lásd az alábbi URL.: https://www.mitsubishi-motors.com/en/red-doc/
	A rádióberendezés működéséhez szükséges frekvenciasáv(ok): TX (MHz) : 1920 - 1980, 1710 - 1785, 2500 - 2570, 880 - 915, 832 - 862, 1710.2 - 1784.8 RX (MHz) : 2110 - 2170, 1805 - 1880, 2620 - 2690, 925 - 960, 791 - 821, 1805.2 - 1879.8
	A rádióberendezés működéséhez szükséges frekvenciasáv(ok) maximális rádiófrekvenciás teljesítménye: 33dBm
16_RED_MT_Maltese	
DIKJARAZZJONI SSIMPLIFIKATA TA' KONFORMITA TAL-UE	Hawnhekk, Visteon Corporation , jidjijjara li TCUMY19 huma konformi mad-Direttiva 2014/53/UE. Għad-dettalji, jekk jogħġbok aċċess għall-URL li ġej: https://www.mitsubishi-motors.com/en/red-doc/
	Medda(medda) ta' frekwenza li fiha jopera t-taħmir ta-radjju: TX (MHz) : 1920 - 1980, 1710 - 1785, 2500 - 2570, 880 - 915, 832 - 862, 1710.2 - 1784.8 RX (MHz) : 2110 - 2170, 1805 - 1880, 2620 - 2690, 925 - 960, 791 - 821, 1805.2 - 1879.8
	Qawwa massima ta'-medda ta' frekwenza ta-radjju t-trażmessa fil-medda(medda) ta'-frekwenza li fiha jopera t-taħmir ta-radjju: 33dBm
17_RED_NL_Dutch	
VEREENVOUDIGDE EUCONFORMITEITSVERK LARING	Hierbij Visteon Corporation , verklaart dat TCUMY19 zijn in overeenstemming met Richtlijn 2014/53/EU. Voor meer informatie, neem dan de volgende URL: https://www.mitsubishi-motors.com/en/red-doc/
	Frequentieband(en) waarop de radioapparatuur werkt: TX (MHz) : 1920 - 1980, 1710 - 1785, 2500 - 2570, 880 - 915, 832 - 862, 1710.2 - 1784.8 RX (MHz) : 2110 - 2170, 1805 - 1880, 2620 - 2690, 925 - 960, 791 - 821, 1805.2 - 1879.8
	Maximum radiofrequentie-vermogen doorgegeven in de frequentieband(en) waarop de

	radioapparatuur werkt: 33dBm
18_RED_PL_Polish	
UPROSZCZONA DEKLARACJA ZGODNOŚCI UE	Niniejszym Visteon Corporation , deklaruje, że TCUMY19 są zgodne z dyrektywą 2014/53/UE. Szczegółowe informacje można znaleźć pod następującym adresem URL: https://www.mitsubishi-motors.com/en/red-doc/
	Pasm(-a) częstotliwości obsługiwane przez sprzęt radiowy: TX (MHz) : 1920 - 1980, 1710 - 1785, 2500 - 2570, 880 - 915, 832 - 862, 1710.2 - 1784.8 RX (MHz) : 2110 - 2170, 1805 - 1880, 2620 - 2690, 925 - 960, 791 - 821, 1805.2 - 1879.8
	Maksymalna przesyłana moc o częstotliwości radiowej w paśmie (pasmach) częstotliwości obsługiwanych przez sprzęt radiowy: 33dBm
19_RED_PT_Portuguese	
DECLARAÇÃO UE DE CONFORMIDADE SIMPLIFICADA	Por este meio, a Visteon Corporation , declara que TCUMY19 estão em conformidade com a Directiva 2014/53/UE. Para obter detalhes, acesse o seguinte URL: https://www.mitsubishi-motors.com/en/red-doc/
	Banda (s) de frequência em que o equipamento de rádio opera: TX (MHz) : 1920 - 1980, 1710 - 1785, 2500 - 2570, 880 - 915, 832 - 862, 1710.2 - 1784.8 RX (MHz) : 2110 - 2170, 1805 - 1880, 2620 - 2690, 925 - 960, 791 - 821, 1805.2 - 1879.8
	Potência máxima de radiofrequência transmitida na (s) faixa (s) de frequência em que o equipamento de rádio opera: 33dBm
20_RED_RO_Romanian	
DECLARAȚIA UE DE CONFORMITATE SIMPLIFICATĂ	Prin prezenta, Visteon Corporation , declară că TCUMY19 sunt conforme cu Directiva 2014/53/UE. Pentru mai multe detalii, vă rugăm să accesați următoarea adresă URL: https://www.mitsubishi-motors.com/en/red-doc/
	Bandă/benzi de frecvență în care funcționează echipamentul radio: TX (MHz) : 1920 - 1980, 1710 - 1785, 2500 - 2570, 880 - 915, 832 - 862, 1710.2 - 1784.8 RX (MHz) : 2110 - 2170, 1805 - 1880, 2620 - 2690, 925 - 960, 791 - 821, 1805.2 - 1879.8
	Puterea maximă a frecvenței radio transmise în banda/benzile de frecvență în care funcționează echipamentul radio: 33dBm
21_RED_SK_Slovak	
ZJEDNODUŠENÉ EÚ VYHLÁSENIE O ZHODE	Týmto Visteon Corporation , vyhlasuje, že TCUMY19 sú v súlade so smernicou 2014/53/EÚ. Podrobnosti nájdete na nasledujúcej internetovej adrese: https://www.mitsubishi-motors.com/en/red-doc/

	<p>Frekvenčné pásma, v ktorých toto rádiové zariadenie funguje: TX (MHz) : 1920 - 1980, 1710 - 1785, 2500 - 2570, 880 - 915, 832 - 862, 1710.2 - 1784.8 RX (MHz) : 2110 - 2170, 1805 - 1880, 2620 - 2690, 925 - 960, 791 - 821, 1805.2 - 1879.8</p> <p>Maximálna rádiová frekvencia energia prenášaná v týchto rádiových pásmach: 33dBm</p>
22_RED_SL_Slovenian	
POENOSTAVLJENA	S tem, Visteon Corporation , izjavlja, da so TCUMY19 v skladu z Direktivo 2014/53/EU. Za
IZJAVA EU O	več informacij, prosimo, pojdite na naslednji naslov:
SKLADNOSTI	https://www.mitsubishi-motors.com/en/red-doc/
	Frekvenčni pas(ovi) v katerih deluje radijska oprema: TX (MHz) : 1920 - 1980, 1710 - 1785, 2500 - 2570, 880 - 915, 832 - 862, 1710.2 - 1784.8 RX (MHz) : 2110 - 2170, 1805 - 1880, 2620 - 2690, 925 - 960, 791 - 821, 1805.2 - 1879.8
	Največja radio-frekvenčna moč oddajana v frekvenčnem(ih) pasu(ovih), v katerem radijska oprema deluje: 33dBm
23_RED_FL_Finnish	
YKSINKERTAISTETTU	Täten Visteon Corporation , ilmoittaa, että TCUMY19 noudattavat direktiivin 2014/53/EU.
EUVAATIMUSTENMUKAIS	Lisätietoja, seuraavassa URL-osoitteessa:
UUSVAKUUTUS	https://www.mitsubishi-motors.com/en/red-doc/
	Taajuusalue(et), joilla radiolaitte toimii: TX (MHz) : 1920 - 1980, 1710 - 1785, 2500 - 2570, 880 - 915, 832 - 862, 1710.2 - 1784.8 RX (MHz) : 2110 - 2170, 1805 - 1880, 2620 - 2690, 925 - 960, 791 - 821, 1805.2 - 1879.8
	Suurin radioaajuudella lähetettävä teho taajuusalueella(-alueilla), joilla radiolaitte toimii: 33dBm
24_RED_SV_Swedish	
FÖRENKLAD	Härmed Visteon Corporation , förklarar att TCUMY19 överensstämmer med direktiv
EUFÖRSÄKRAN	2014/53/EU. För mer information, gå in på följande webbadress:
OM	https://www.mitsubishi-motors.com/en/red-doc/
ÖVERENSSTÄMMEELSE	
	Frekvensband (er) i hvilken radio utrustning en arbetar: TX (MHz) : 1920 - 1980, 1710 - 1785, 2500 - 2570, 880 - 915, 832 - 862, 1710.2 - 1784.8 RX (MHz) : 2110 - 2170, 1805 - 1880, 2620 - 2690, 925 - 960, 791 - 821, 1805.2 - 1879.8
	Maximala radiofrekvens makt överförs i frekvens mottagningsläger som driver radioutrustning: 33dBm
25_RED_NO_Norway	

	<p>Herved Visteon Corporation, erklærer at TCUMY19 er i samsvar med direktiv 2014/53/EU. For flere detaljer, vennligst følgende URL: https://www.mitsubishi-motors.com/en/red-doc/</p> <p>Frekvens bånd (s) der radioutstyret fungerer: TX (MHz) : 1920 - 1980, 1710 - 1785, 2500 - 2570, 880 - 915, 832 - 862, 1710.2 - 1784.8 RX (MHz) : 2110 - 2170, 1805 - 1880, 2620 - 2690, 925 - 960, 791 - 821, 1805.2 - 1879.8</p> <p>Maksimal radiofrekvensen strøm ble sendt i frekvensbånd(s) som radioutstyret fungerer: 33dBm</p>
26_RED_TR_Turkey	<p>Burada, Visteon Corporation, TCUMY19 'in 2014/53/AB sayılı Direktife uygun olduğunu beyan eder. Ayrıntılar için lütfen aşağıdaki URL'ye erişin: https://www.mitsubishi-motors.com/en/red-doc/</p> <p>Radio ekipmanının çalıştığı frekans bantları: TX (MHz) : 1920 - 1980, 1710 - 1785, 2500 - 2570, 880 - 915, 832 - 862, 1710.2 - 1784.8 RX (MHz) : 2110 - 2170, 1805 - 1880, 2620 - 2690, 925 - 960, 791 - 821, 1805.2 - 1879.8</p> <p>Radio ekipmanının çalıştığı frekans bantlarında iletilen maksimum radyofrekans gücü: 33dBm</p>
27_RED_MK_Macedonia	<p>Со ова, Visteon Corporation, изјавува дека TCUMY19 се во согласност со Директивата 2014/53/EУ. За повеќе детали, посетете ја следната веб-адреса: https://www.mitsubishi-motors.com/en/red-doc/</p> <p>Радио опремата работи на следниот радиофреквенциски спектар: TX (MHz) : 1920 - 1980, 1710 - 1785, 2500 - 2570, 880 - 915, 832 - 862, 1710.2 - 1784.8 RX (MHz) : 2110 - 2170, 1805 - 1880, 2620 - 2690, 925 - 960, 791 - 821, 1805.2 - 1879.8</p> <p>Радио опремата функционира на следната максимална моќност на радио фреквенции емитувана во радиофреквенцискиот спектар: 33dBm</p>
28_RED_AL_Albania	<p>Me anë të kësaj, Visteon Corporation, deklaron se TCUMY19 janë në përputhje me Direktivën 2014/53/BE. Për detaje, vizitoni URL e mëposhtme: https://www.mitsubishi-motors.com/en/red-doc/</p> <p>Banda(t) e frekuencës me të cilat punojnë pajisjet radio: TX (MHz) : 1920 - 1980, 1710 - 1785, 2500 - 2570, 880 - 915, 832 - 862, 1710.2 - 1784.8 RX (MHz) : 2110 - 2170, 1805 - 1880, 2620 - 2690, 925 - 960, 791 - 821, 1805.2 - 1879.8</p> <p>Fuqia maksimale radio-frekuencë e transmetuar në bandën(at) e frekuencave në të cilën punojnë pajisjet radio:</p>

	33dBm
29_RED_ME_Montenegro	
	Ovim putem, Visteon Corporation , izjavljuje da je TCUMY19 su u skladu sa Direktivi 2014/53/EU. Za detalje, molimo vas da pristupite sljedeći URL: https://www.mitsubishi-motors.com/en/red-doc/
	Frekventni opseg u kojem funkcioniše radio oprema: TX (MHz) : 1920 - 1980, 1710 - 1785, 2500 - 2570, 880 - 915, 832 - 862, 1710.2 - 1784.8 RX (MHz) : 2110 - 2170, 1805 - 1880, 2620 - 2690, 925 - 960, 791 - 821, 1805.2 - 1879.8
	Maksimalna prenesena snaga radio frekvencije u frekventnom opsegu u kojem funkcioniše radio oprema: 33dBm
30_RED_GE_Georgian	
	აბსოლან, Visteon Corporation , შპს, აცხადებს, რომ TCUMY19 შესაბამისობაში დორეცევა 2014/53/EU. დამატებითი ინფორმაციისათვის, გთხოვთ, იხილოთ შემდეგი URL: https://www.mitsubishi-motors.com/en/red-doc/
	სიხშირეს ტალღები, რომლებზეც მუშაობს რადიო: TX (MHz) : 1920 - 1980, 1710 - 1785, 2500 - 2570, 880 - 915, 832 - 862, 1710.2 - 1784.8 RX (MHz) : 2110 - 2170, 1805 - 1880, 2620 - 2690, 925 - 960, 791 - 821, 1805.2 - 1879.8
	რადიო მოწყობილობის რადიო-სიხშირის მაქსიმალური სიმძლავრე: 33dBm

Нотификация ФСБ № RU0000022370 от 17.07.2015, действительна до 09.07.2020, зарегистрирована ФСБ РФ.

Декларация о соответствии средства связи № Д-МДРТ-11741 от 26.10.2018, действительна до 23.10.2023, зарегистрирована Федеральным агентством связи РФ.

Декларация о соответствии техническому регламенту Таможенного союза 020/2011 № ТС № RU Д-JP.МЛ26.В.00353 от 23.10.2015, действительна по 22.10.2020, зарегистрирована органом по сертификации продукции АНО «СЦ Связь-сертификат» (аттестат аккредитации RA.RU.11МЛ26, дата регистрации 10.02.2015).

Декларация о соответствии аккумуляторной батареи FT0098A № РОСС RU Д-JP.АД 37.В.01289/18 от 24.10.2018, действительна до 23.10.2023, зарегистрирована органом по сертификации продукции «Красно Дар» ООО «ИД Контроль» (аттестат аккредитации RA.RU.11АД37, дата регистрации 03.11.2016).

Manufacturer Postal Address

MITSUBISHI ELECTRIC CORPORATION
2-3-33, MIWA, SANDA-CITY, HYOGO, 669-1513, JAPAN

**A) Generic information:****B) Language Text:**

Cesk [Czech]	Tímto [Mitsubishi Electric Corporation], prohlašuje, že [DY-5M/DY-1/DY-1M/CQ-0ME/NR-242/NR-201] jsou v souladu se směrnicí 2014/53/EU. Podrobnosti naleznete na následující internetové adrese: http://www.mitsubishi-motors.com/en/red-doc/
Dansk [Danish]	Hermed, [Mitsubishi Electric Corporation], erklærer, at [DY-5M/DY-1/DY-1M/CQ-0ME/NR-242/NR-201] er i overensstemmelse med direktiv 2014/53/EU. For yderligere information gå ind på følgende webadresse: http://www.mitsubishi-motors.com/en/red-doc/
Deutsch [German]	Hiermit erkläre [Mitsubishi Electric Corporation], dass [DY-5M/DY-1/DY-1M/CQ-0ME/NR-242/NR-201] in Übereinstimmung mit der Richtlinie 2014/53/EU stehen. Weitere Informationen erhalten Sie über folgende URL: http://www.mitsubishi-motors.com/en/red-doc/
Eesti [Estonian]	Käesolevaga [Mitsubishi Electric Corporation], teatab, et [DY-5M/DY-1/DY-1M/CQ-0ME/NR-242/NR-201] on kooskõlas direktiivi 2014/53/EL. Üksikasjalikuma teabe saamiseks tutvuda järgmise URL: http://www.mitsubishi-motors.com/en/red-doc/
English [English]	Hereby, [Mitsubishi Electric Corporation], declares that [DY-5M/DY-1/DY-1M/CQ-0ME/NR-242/NR-201] are in compliance with Directive 2014/53/EU. For details, please access the following URL: http://www.mitsubishi-motors.com/en/red-doc/
Español [Spanish]	Por este medio, [Mitsubishi Electric Corporation], declara que [DY-5M/DY-1/DY-1M/CQ-0ME/NR-242/NR-201] están en conformidad con la Directiva 2014/53/UE. Para obtener más detalles, acceda a la siguiente URL: http://www.mitsubishi-motors.com/en/red-doc/
Ελληνικό [Greek]	Διο του παρόντος, [Mitsubishi Electric Corporation], δηλώνει ότι [DY-5M/DY-1/DY-1M/CQ-0ME/NR-242/NR-201] είναι σε συμμόρφωση με την οδηγία 2014/53/ΕΕ. Για λεπτομέρειες, επισκεφτείτε την παρακάτω διεύθυνση URL: http://www.mitsubishi-motors.com/en/red-doc/
Français [French]	Par la présente, [Mitsubishi Electric Corporation], déclare que [DY-5M/DY-1/DY-1M/CQ-0ME/NR-242/NR-201] sont conformes à la directive 2014/53/UE. Pour plus de détails, veuillez accéder à l'URL suivante: http://www.mitsubishi-motors.com/en/red-doc/
Italiano [Italian]	Con la presente, [Mitsubishi Electric Corporation], dichiara che [DY-5M/DY-1/DY-1M/CQ-0ME/NR-242/NR-201] sono in conformità con la direttiva 2014/53/UE. Per ulteriori informazioni, si prega di consultare il seguente URL: http://www.mitsubishi-motors.com/en/red-doc/
Latviski [Latvian]	Ar šo, [Mitsubishi Electric Corporation], paziņo, ka [DY-5M/DY-1/DY-1M/CQ-0ME/NR-242/NR-201] ir saskaņā ar Direktīvu 2014/53/ES. Lai iegūtu plašāku informāciju, lūdzu, apmeklējiet šādu URL: http://www.mitsubishi-motors.com/en/red-doc/
Lietuviu [Lithuanian]	Šiuo [Mitsubishi Electric Corporation], pareiškiu, kad [DY-5M/DY-1/DY-1M/CQ-0ME/NR-242/NR-201] yra laikomasi Direktyvos 2014/53/ES. Del išsamesnės informacijos, prašome prisijungti prie šių URL: http://www.mitsubishi-motors.com/en/red-doc/
Nederlands [Dutch]	Hierbij [Mitsubishi Electric Corporation], verklaart dat [DY-5M/DY-1/DY-1M/CQ-0ME/NR-242/NR-201] zijn in overeenstemming met Richtlijn 2014/53/EU. Voor meer informatie, neem dan de volgende URL: http://www.mitsubishi-motors.com/en/red-doc/
Malti [Maltese]	Hawnhekk, [Mitsubishi Electric Corporation], jiddikjara li [DY-5M/DY-1/DY-1M/CQ-0ME/NR-242/NR-201] huma konformi mad-Direttiva 2014/53/UE. Għad-dettalji, jekk jogħġbok aċċess għall-URL li ġej: http://www.mitsubishi-motors.com/en/red-doc/
Magyar [Hungarian]	Ezáltal [Mitsubishi Electric Corporation], kijelenti, hogy [DY-5M/DY-1/DY-1M/CQ-0ME/NR-242/NR-201] irányelvnek megfelelő 2014/53/EU. A részleteket lásd az alábbi URL: http://www.mitsubishi-motors.com/en/red-doc/
Polski [Polish]	Niniejszym [Mitsubishi Electric Corporation], deklaruje, że [DY-5M/DY-1/DY-1M/CQ-0ME/NR-242/NR-201] są zgodne z dyrektywą 2014/53/UE. Szczegółowe informacje można znaleźć pod następującym adresem URL: http://www.mitsubishi-motors.com/en/red-doc/
Português [Portuguese]	Por este meio, a [Mitsubishi Electric Corporation], declara que [DY-5M/DY-1/DY-1M/CQ-0ME/NR-242/NR-201] estão em conformidade com a Directiva 2014/53/UE. Para obter detalhes, acesse o seguinte URL: http://www.mitsubishi-motors.com/en/red-doc/
Slovenski [Slovenian]	S tem, [Mitsubishi Electric Corporation], izjavljam, da so [DY-5M/DY-1/DY-1M/CQ-0ME/NR-242/NR-201] v skladu z Direktivo 2014/53/EU. Za več informacij, prosimo, pojdite na naslednji naslov: http://www.mitsubishi-motors.com/en/red-doc/

Slovenské [Slovak]	Týmto [Mitsubishi Electric Corporation], vyhlasuje, že [DY-5M/DY-1/DY-1M/CQ-0ME/NR-242/NR-201] sú v súlade so smernicou 2014/53/EÚ. Podrobnosti nájdete na nasledujúcej internetovej adrese: http://www.mitsubishi-motors.com/en/red-doc/
Suomi [Finnish]	Täten [Mitsubishi Electric Corporation], ilmoittaa, että [DY-5M/DY-1/DY-1M/CQ-0ME/NR-242/NR-201] noudattavat direktiivin 2014/53/EU. Lisätietoja, seuraavassa URL-osoitteessa: http://www.mitsubishi-motors.com/en/red-doc/
Svenska [Swedish]	Härmed [Mitsubishi Electric Corporation], förklarar att [DY-5M/DY-1/DY-1M/CQ-0ME/NR-242/NR-201] överensstämmer med direktiv 2014/53/EU. För mer information, gå in på följande webbadress: http://www.mitsubishi-motors.com/en/red-doc/
Íslenska [Icelandic]	Hér, [Mitsubishi Electric Corporation], segir að [DY-5M/DY-1/DY-1M/CQ-0ME/NR-242/NR-201] eru í samræmi við tilskipun 2014/53/ESB. Fyrir upplýsingar, vinsamlegast aðgang eftirfarandi vefslóð: http://www.mitsubishi-motors.com/en/red-doc/
Norsk [Norwegian]	Herved [Mitsubishi Electric Corporation], erklærer at [DY-5M/DY-1/DY-1M/CQ-0ME/NR-242/NR-201] er i samsvar med direktiv 2014/53/EU. For flere detaljer, vennligst følgende URL: http://www.mitsubishi-motors.com/en/red-doc/
Türk [Turkish]	Burada, [Mitsubishi Electric Corporation], [DY-5M/DY-1/DY-1M/CQ-0ME/NR-242/NR-201] 'in 2014/53/AB sayılı Direktife uygun olduğunu beyan eder. Ayrıntılar için lütfen aşağıdaki URL'ye erişin: http://www.mitsubishi-motors.com/en/red-doc/
Română [Romania]	Prin prezenta, [Mitsubishi Electric Corporation], declară că [DY-5M/DY-1/DY-1M/CQ-0ME/NR-242/NR-201] sunt conforme cu Directiva 2014/53/UE. Pentru mai multe detalii, vă rugăm să accesați următoarea adresă URL: http://www.mitsubishi-motors.com/en/red-doc/
Български [Bulgarian]	С настоящото [Mitsubishi Electric Corporation], декларира, че [DY-5M/DY-1/DY-1M/CQ-0ME/NR-242/NR-201] са в съответствие с Директива 2014/53/ЕС. За повече информация, моля, посетете следния URL адрес: http://www.mitsubishi-motors.com/en/red-doc/
Hrvatski [Croatian]	Ovime [Mitsubishi Electric Corporation], izjavljuje da je [DY-5M/DY-1/DY-1M/CQ-0ME/NR-242/NR-201] su u skladu s Direktivom 2014/53/EU. Za detalje, molimo pogledajte sljedeći URL: http://www.mitsubishi-motors.com/en/red-doc/
Македонски [Macedonian]	Со ова, [Mitsubishi Electric Corporation], изјавува дека [DY-5M/DY-1/DY-1M/CQ-0ME/NR-242/NR-201] се во согласност со Директивата 2014/53/ЕУ. За повеќе детали, посетете ја следната веб-адреса: http://www.mitsubishi-motors.com/en/red-doc/
Shqiptar [Albanian]	Me anë të kësaj, [Mitsubishi Electric Corporation], deklaron se [DY-5M/DY-1/DY-1M/CQ-0ME/NR-242/NR-201] janë në përputhje me Direktivën 2014/53/BE. Për detaje, vizitoni URL e mëposhtme: http://www.mitsubishi-motors.com/en/red-doc/
Црногорски / Crnogorski [Montenegrin]	Ovim putem, [Mitsubishi Electric Corporation], izjavljuje da je [DY-5M/DY-1/DY-1M/CQ-0ME/NR-242/NR-201] su u skladu sa Direktivi 2014/53/EU. Za detalje, molimo vas da pristupite sljedeći URL: http://www.mitsubishi-motors.com/en/red-doc/
ქართული [Georgian]	ამასთან, [Mitsubishi Electric Corporation], მის, აცხადებს, რომ [DY-5M/DY-1/DY-1M/CQ-0ME/NR-242/NR-201] შესაბამისობაშია დირექტივა 2014/53/ЕУ. დამატებითი ინფორმაციისთვის, გთხოვთ, იხილოთ მისამართი URL: http://www.mitsubishi-motors.com/en/red-doc/

COUNTRY	IMPORTER NAME	REGISTERED TRADE NAME OR REGISTERED TRADE MARK	POSTAL ADDRESS
ALBANIA	MMAI	M.M. Automobili Italia SpA	Via Giovanni da Udine 45, 20156 Milano, Italy
AUSTRIA	DENZEL Autoimport GmbH	DENZEL Autoimport GmbH	A-1230 Wien, Richard Strauss-Straße 14
BELGIUM	Beherman	Beherman Motors NV/SA	Industrieweg 3, Bornem Belgium
BULGARIA	Balkan Star Motors EOOD	Balkan Star Motors EOOD	Bulgaria, 1510 Sofia, Rezbarska str. 5
CROATIA	LMG Autokuća d.o.o.	LMG Autokuća d.o.o.	Velikogorička 18a,10419 Staro Čiče, CROATIA
CYPRUS	FAIRWAYS	Fairways Ltd	100 Arch. Makarios Avenue, P.O. BOX 51023,3021 Limmasol, Cyprus
CZECH	M Motors CZ s.r.o.	M Motors CZ s.r.o.	Na Chodovci 2457/1, Praha 4 Sporilov, ZIP 141 00, Czech Rep.
DENMARK	MMDk	MMC Danmark A/S	Hovedvejen 3 2600 Glostrup, Denmark
ESTONIA	AS SILBERAUTO	Silberauto	Järvevana tee 11, Tallinn 11314, Estonia
FINLAND	Delta Motor	Delta Motor Group Oy	Vaisalantie 6, 02130 Espoo, Finland
FRANCE	MMAF	M Motors Automobiles France SAS	1, avenue du Fief PA les Béthunes 95310 Saint Ouen L'Aumône FRANCE
GERMANY	MMD Automobile GmbH	MMD Automobile GmbH	Stahlstr. 42-44, 65428 Rüsselsheim Deutschland
GREECE	Saracakis Brothers	SARACAKIS BROTHERS S.A.	71, Athinon Ave., GR-101 73 Athens, Greece
HUNGARY	MM IMPORT KFT	MM Import kft	Mogyorodi ut24-40, H-1149 Budapest,Hungary
ICELAND	HEKLA	Hekla Hf.	Laugavegur 172-174, P.O.Box 5310, 125 Reykjavik, Iceland
IRELAND	MMC Commercial	MMC Commercial Unlimited	John F. Kennedy Drive, Naas Road, Dublin 12, Ireland
ITALY	MMAI	M.M. Automobili Italia SpA	Via Giovanni da Udine 45, 20156 Milano, Italy
LATVIA	MML Imports SIA	MML Imports SIA	32 Lieļirbes Street, Riga, LV1046, Latvia.
LITHUANIA	JSC Autovytaras	JSC Autovytaras, company code:126413861	P.Žadeikos str. 1B, Vilnius LT-06319, Lithuania
LUXEMBOURG	Beherman	Beherman Motors NV/SA	Industrieweg 3, Bornem Belgium
MALTA	INDUSTRIAL Motors Ltd	Industrial Motors Limited	Mizzi House, National Road,Ġlata I-Bajda HMR 9010,Malta
MOLDOVA	Auto Space S.R.L.	AUTO SPACE	str. Bucuriei 18a, Chisinau, Republica Moldova, MD-2064
NETHERLANDS	MMSN	Mitsubishi Motor Sales Nederland B.V.	Postbus 9090 1180 MB Amstelveen Bovenkerkerweg 6-8, 1185 XE Amstelveen, The Netherlands
NORWAY	MMCN	MMC Norge AS	Ostre Aker vei 62, 0581 Oslo P.O. Box 6843 Rodelokka, 0504 Oslo, Norway
POLAND	MMCP	MMC Car Poland Sp.z o.o.	ul.,17 Stycznia 45A,02-146,Warsaw,Poland
PORTUGAL	MBP Automoveis Portugal,S.A.	MBP Automoveis Portugal,S.A.	Rua Dr. José Espírito Santo, 38, 1950-097 LISBOA, Portugal
ROMANIA	M CAR TRADING	M CAR TRADING	2nd,Expozitiei Biv,district 1,012103 BUCHAREST,BULGARIA
SLOVAKIA	M Motors SK s.r.o.	M Motors SK s.r.o.	Panonska cesta 33, Bratislava, Slovakia, ZIP 851 04
SLOVENIA	AC-Mobil d.o.o.	AC-Mobil, d.o.o. Ljubljana	Baragova 9, 1113 Ljubljana
SPAIN	B&M Automóviles España, S.A.	B&M Automóviles España, S.A.	calle Alcalá, 65, 28014 Madrid, Spain
SWEDEN	MMCS	MMC Bilar Sverige AB	Bergkallavagen 32, SE-192 07 Sollentuna, Sweden
SWITZERLAND	MM Automobile Schweiz AG	MM Automobile Schweiz AG	Lischmatt 17, 4624 Harkingen, Switzerland
U.K.	CCC	The Colt Car Company Limited	Watermoor, Cirencester Gloucestershire GL7 1LF, The United Kingdom
GEORGIA	Caucasus Motors Ltd.	Caucasus Motors Ltd.	12th km David Agmashenebeli Alley Digomi, 0131 Tbilisi, Georgia
TAHITI	SOPA DEP S.A.	SOPA DEP S.A.	Route de ceinture de Tiperui. BP 1617. 98713 Papeete, Tahiti French Polynesia
EGYPT	DIAMOND MOTORS COMPANY	DIAMOND MOTORS COMPANY	Alex Desert Road, km 28, Cairo, Egypt

**MANUFACTURERS DECLARATION
OF CONFORMITY**



For

**Pantagraph Car Jack
Models PJM700, PJM800, PJM1000 & PJM1200**

Manufactured by

Taihei Industrial Co.,Ltd.
No.49-1, Kagekatsu-Cho,
Fushimi-Ku,
Kyoto 612-8307
Japan

**Technical File compiled and held in the
EU, on behalf of the manufacturer by**

TRac Global Ltd
100 Frobisher Business Park,
Leigh Sinton Road, Malvern,
Worcestershire, WR14 1BX
United Kingdom

**Standards used as guidance
Machinery Directive**

**Annex I of 2006/42/EC with reference to :
EN 1494:2000/A1:2008**

Means of Conformity

The Product is in conformity with EC law as approximated by the Machinery Directive 2006/42/EC,
As detailed in Technical Documentation File No **2136 Revision 2, March 2012**

Signature of Responsible Person:

Mr. Masato Nasu
President
Taihei Industrial Co., Ltd.

**Signature of the person in the EU holding
the Technical File:**

Mr Neil Roche
EMC Product Manager
TRaC Global Ltd.

MACHINE SERIAL No.

Date: 13th March 2012

Certificate No. 17-0074-1 DofC Issue 3

Deutsch (German)	Français (French)	Italiano (Italian)
<p>KONFORMITÄTSERKLÄRUNG DES HERSTELLERS Für Pantagraph Wagenheber, Modelle PJM700, PJM800, PJM1000 & PJM1200</p> <p>Hergestellt von Taihei Industrial Co., Ltd. No.49-1, Kagekatsu-cho, Fushimi-ku, Kyoto 612-8307 Japan</p> <p>Technische Dokumentation zusammengestellt und bereitgehalten in der EU, im Namen des Herstellers durch TRaC Global Ltd 100 Frobisher Business Park, Leigh Sinton Road, Malvern, Worcestershire, WR14 1BX Vereinigtes Königreich</p> <p>Als Leitlinie der Maschinenrichtlinie verwendete Normen Anhang I der 2006/42/EG mit Bezug auf: EN 1494:2000/A1:2008</p> <p>Konformität Das Produkt steht in Übereinstimmung mit den der Maschinenrichtlinie 2006/42/EG angeglichenen EG-Gesetzen,</p> <p>Entsprechend der Technischen Dokumentation Akte Nr. 2136 2, Revision, März 2012</p> <p>Unterschrift der verantwortlichen Person: Herr Masato Nasu Präsident Taihei Industrial Co., Ltd.</p> <p>Unterschrift der Person, die die technische Dokumentation in der EU bereithält: Herr Neil Roche EMV-Produktmanager TRaC Global Ltd.</p> <p>MASCHINENSERIENN.R. Datum: 13. März 2012 Zertifikatsnr. 17-0074-1 DoFC 3. Ausgabe</p>	<p>DECLARATION DE CONFORMITE DU FABRICANT Pour Pantagraph Car Jack, modèles PJM700, PJM800, PJM1000 & PJM1200</p> <p>Fabriqué par Taihei Industrial Co., Ltd. No.49-1, Kagekatsu-cho, Fushimi-ku, Kyoto 612-8307 Japon</p> <p>Fichier technique compilé et maintenu dans l'UE, au nom du fabricant en TRaC Global Ltd 100 Frobisher Business Park, Leigh Sinton Road, Malvern, Worcestershire, WR14 1BX Royaume-Uni</p> <p>Normes utilisées pour le guide de l'appareil Annexe I de 2006/42/EC en se reportant à la section : EN 1494:2000/A1:2008</p> <p>Moyens de conformité Le produit est en conformité avec la loi CE comme approximativement par la directive sur la machinerie 2006/42/CE,</p> <p>Comme décrit dans le fichier de la documentation technique n°2136 révision 2, mars 2012</p> <p>Signature de la personne responsable : M. Masato Nasu Président Taihei Industrial Co., Ltd.</p> <p>Signature de la personne dans l'UE gardant le fichier technique : M. Neil Roche Chef de produit EMC TRaC Global Ltd.</p> <p>N° DE SERIE DE LA MACHINE Date : 13 mars 2012 N° de certificat 17-0074-1 DoFC Edition 3</p>	<p>DICHIARAZIONE DI CONFORMITÀ DEL PRODUTTORE Per Cric a pantografo, modelli PJM700, PJM800, PJM1000 & PJM1200</p> <p>Prodotto da Taihei Industrial Co., Ltd. No.49-1, Kagekatsu-cho, Fushimi-ku, Kyoto 612-8307 Giappone</p> <p>File tecnico compilato e detenuto nell'UE per conto del produttore da TRaC Global Ltd 100 Frobisher Business Park, Leigh Sinton Road, Malvern, Worcestershire, WR14 1BX Regno Unito</p> <p>Standard utilizzati come guida della direttiva macchine Appendice I di 2006/42/CE con riferimento a: EN 1494:2000/A1:2008</p> <p>Certificato di conformità Il prodotto è conforme alle leggi della CE poiché rispetta la direttiva macchine 2006/42/CE,</p> <p>Come dettagliato nel file della documentazione tecnica N. 2136, revisione 2 marzo 2012</p> <p>Firma del responsabile: Masato Nasu Presidente Taihei Industrial Co., Ltd.</p> <p>Firma della persona che detiene il file tecnico nell'UE: Neil Roche EMC Product Manager TRaC Global Ltd.</p> <p>N. SERIALE DELLA MACCHINA Data: 13 marzo 2012 Certificato N. 17-0074-1 DoFC Issue 3</p>

Nederland (Dutch)	Dansk (Danish)	Ελληνικά (Greek)
<p>FABRIKANTENVERKLARING VAN CONFORMITEIT Voor Pantagraph Autokrik, Modellen PJM700, PJM800, PJM1000 & PJM1200</p> <p>Geproduceerd door Taihei Industrial Co., Ltd. No.49-1, Kagekatsu-cho, Fushimi-ku, Kyoto 612-8307 Japan</p> <p>Technisch Dossier samengesteld en gehouden in de EU, namens de fabrikant door TRaC Global Ltd 100 Frobisher Business Park, Leigh Sinton Road, Malvern, Worcestershire, WR14 1BX United Kingdom</p> <p>Normen als leidraad Machinerichtlijn</p> <p>Bijlage I van 2006/42/EG met betrekking tot: EN 1494:2000 / A1: 2008</p> <p>Middel van conformiteit Het product is in overeenstemming met het EG-recht zoals benaderd door de Machinerichtlijn 2006/42/EG, Zoals beschreven in Technische Documentatie Dossier nr. 2136 Revisie 2, maart 2012</p> <p>Handtekening van de bevoegde persoon: De heer Masato Nasu President Taihei Industrial Co., Ltd.</p> <p>Handtekening van de persoon in de EU die het Technisch Dossier: De heer Neil Roche EMC Product Manager TRaC Global Ltd.</p> <p>MACHINE Serienummer Datum: 13 maart 2012 Certificaat nr. 17-0074-1 DofC Uitgave 3</p>	<p>PRODUCENTENS OVERENSSTEMMELSESERKLÆRING for Pantografisk donkraft i modellerne PJM700, PJM800, PJM1000 & PJM1200</p> <p>Fremstillet af Taihei Industrial Co., Ltd. No.49-1, Kagekatsu-cho, Fushimi-ku, Kyoto 612-8307 Japan</p> <p>Teknisk fil kompileret og holdt inden for EU på vegne af producenten TRaC Global Ltd 100 Frobisher Business Park, Leigh Sinton Road, Malvern, Worcestershire, WR14 1BX England</p> <p>Standarder anvendt som vejledende maskindirektiv</p> <p>Bilag I i 2006/42/EU med reference til: EN 1494:2000/A1:2008</p> <p>Overensstemmelseserklæringens betydninger Produktet er i overensstemmelse med EU-lovgivningen defineret af Maskindirektivet 2006/42/EF, Som beskrevet i fil med teknisk dokumentation nr. 2136 Revidering 2, marts 2012</p> <p>Signatur for ansvarlig: Hr. Masato Nasu Formand Taihei Industrial Co., Ltd.</p> <p>Signatur fra personen i EU, der besidder den tekniske fil: Hr. Neil Roche EMC-produktchef TRaC Global Ltd.</p> <p>MASKINENS SERIENR. Dato: 13. marts 2012 Certifikatnr. 17-0074-1 DofC Problemstilling 3</p>	<p>ΔΗΛΩΣΗ ΣΥΜΜΟΡΦΩΣΗΣ ΤΩΝ ΚΑΤΑΣΚΕΥΑΣΤΩΝ Για Γρύλος Αυτοκινήτου Pantagraph, Μοντέλα PJM700, PJM800, PJM1000 και PJM1200</p> <p>Κατασκευάστηκε από την Taihei Industrial Co., Ltd. No.49-1, Kagekatsu-cho, Fushimi-ku, Kyoto 612-8307 Ιαπωνία</p> <p>Τεχνικό Αρχείο συντασσόμενο και διατηρούμενο στην ΕΕ, εξ ονόματος του κατασκευαστή από την TRaC Global Ltd 100 Frobisher Business Park, Leigh Sinton Road, Malvern, Worcestershire, WR14 1BX Ηνωμένο Βασίλειο</p> <p>Πρότυπα που χρησιμοποιούνται ως κατευθυντήρια Οδηγία περί Μηχανημάτων Παράρτημα I της 2006/42/ΕΚ με αναφορά στη: EN 1494:2000/A1:2008</p> <p>Μέσα Συμμόρφωσης Το Προϊόν είναι σύμφωνο με την κοινοτική νομοθεσία, όπως προσεγγίζεται από την Οδηγία για τα Μηχανήματα 2006/42/ΕΚ, όπως αναφέρεται λεπτομερώς στην Τεχνική Τεκμηρίωση με Αρ. Αρχείου 2136 Αναθεώρηση 2, Μαρτίου 2012</p> <p>Υπογραφή του Υπεύθυνου Ατόμου: κ. Masato Nasu Πρόεδρος Taihei Industrial Co., Ltd.</p> <p>Υπογραφή του ατόμου στην ΕΕ που διατηρεί το Τεχνικό Αρχείο: κ. Neil Roche Διευθυντής Προϊόντων Ηλεκτρομαγνητικής Συμβατότητας TRaC Global Ltd.</p> <p>ΣΕΙΡΙΑΚΟΣ ΑΡ. ΣΥΣΚΕΥΗΣ Ημερομηνία: 13 Μαρτίου 2012 Αρ. Πιστοποιητικού 17-0074-1 DofC Έκδοση 3</p>

Español (Spanish)	Português (Portuguese)	Svenska (Swedish)
<p>DECLARACIÓN DE CONFORMIDAD DEL FABRICANTE Para Gato pantógrafo para coche, modelos PJM700, PJM800, PJM1000 & PJM1200</p> <p>Fabricado por Taihei Industrial Co., Ltd. Núm. 49-1, Kagekatsu-cho, Fushimi-ku, Kioto 612-8307 Japón</p> <p>Archivo técnico compilado y mantenido en la UE, en nombre del fabricante por TRaC Global Ltd 100 Frobisher Business Park, Leigh Sinton Road, Malvern, Worcestershire, WR14 1BX Reino Unido</p> <p>Estándares usados como guía Directiva sobre maquinaria Anexo I de 2006/42/CE con referencia a: EN 1494:2000/A1:2008</p> <p>Medidas de conformidad El producto se encuentra en conformidad con la ley de la CE según se aproxima por la Directiva de máquinas 2006/42/CE,</p> <p>Como se detalla en el Archivo de documentación técnica Núm. 2136 Revisión 2, marzo de 2012</p> <p>Firma de la persona responsable: Sr. Masato Nasu Presidente Taihei Industrial Co., Ltd.</p> <p>Firma de la persona en la UE que sostiene el Archivo técnico: Sr. Neil Roche Gestor de producto EMC TRaC Global Ltd.</p> <p>NÚM. DE SERIE DE LA MÁQUINA Fecha: 13 de marzo de 2012 Núm. de certificado 17-0074-1 DoFC Edición 3</p>	<p>DECLARAÇÃO DE CONFORMIDADE DOS FABRICANTES Para Macaco para Carro Pantagraph, Modelos PJM700, PJM800, PJM1000 e PJM1200</p> <p>Fabricado por Taihei Industrial Co., Ltd. N.º 49-1, Kagekatsu-cho, Fushimi-ku, Quioto 612-8307 Japão</p> <p>Ficha Técnica compilada e mantida na UE, em nome do fabricante por TRaC Global Ltd 100 Frobisher Business Park, Leigh Sinton Road, Malvern, Worcestershire, WR14 1BX Reino Unido</p> <p>Normas usadas como orientação da Diretiva de Maquinaria Anexo I da 2006/42/EC com referência a: EN 1494:2000/A1:2008</p> <p>Meios de Conformidade O Produto está em conformidade com a lei CE como aproximado através da Diretiva Relativa a Máquinas 2006/42/CE,</p> <p>Como detalhado na Ficha de Documentação Técnica N.º 2136 Revisão 2, de Março de 2012</p> <p>Assinatura da Pessoa Responsável: Sr. Masato Nasu Presidente Taihei Industrial Co., Ltd.</p> <p>Assinatura da pessoa que detêm a Ficha Técnica na UE: Sr. Neil Roche Gestor de Produto EMC TRaC Global Ltd.</p> <p>N.º DE SÉRIE DA MÁQUINA Data: 13 de Março de 2012 Certificado N.º 17-0074-1 DoFC Edição 3</p>	<p>TILLVERKARENS FÖRSÄKRAN OM ÖVERENSSTÄMMELSE För Pantagraph domkraft för bil, modellerna PJM700, PJM800, PJM1000 & PJM1200</p> <p>Tillverkad av Taihei Industrial Co., Ltd. No.49-1, Kagekatsu-cho, Fushimi-ku, Kyoto 612-8307 Japan</p> <p>Teknisk fil sammanställd och förvarad i EU, å tillverkarens vägnar genom TRaC Global Ltd 100 Frobisher Business Park, Leigh Sinton Road, Malvern, Worcestershire, WR14 1BX Storbritannien</p> <p>Standarder som används som vägledning för maskindirektivet Bilaga I i 2006/42/EG med avseende på: EN 1494:2000/A1:2008</p> <p>Överensstämmelse Produkten överensstämmer med EG-lagstiftningen som approximeras av Maskindirektivet 2006/42/EG,</p> <p>I enlighet med Teknisk dokumentationsfil nr. 2136 revision 2, mars 2012</p> <p>Signatur av ansvarig person: Mr. Masato Nasu Ordförande Taihei Industrial Co., Ltd.</p> <p>Signatur av den person i EU som förvarar den tekniska filen: Mr Neil Roche EMC Produktchef TRaC Global Ltd.</p> <p>MASKINENS SERIENUMMER Datum: 13 mars 2012 Certifikat nr. 17-0074-1 DoFC Utgåva 3</p>

Suomi/Suomen kieli (Finnish)	Čeština (Czech)	Magyar (Hungarian)
<p>VALMISTAJAN VAATIMUSTENMUKAISUUSVAKUUTUS Malleille Pantagraph-autonosturi, mallit PJM700, PJM800, PJM1000 & PJM1200</p> <p>Valmistaja Taihei Industrial Co., Ltd. No.49-1, Kagekatsu-cho, Fushimi-ku, Kyoto 612-8307 Japan</p> <p>Teknisen asiakirjan on laatinut ja sitä säilyttää EU:ssa valmistajan puolesta TRaC Global Ltd 100 Frobisher Business Park, Leigh Sinton Road, Malvern, Worcestershire, WR14 1BX United Kingdom</p> <p>Ohjeena käytetyt standardit Konedirektiivi 2006/42/EY:n liite I viitaten standardiin: EN 1494:2000/A1:2008</p> <p>Vaatimustenmukaisuuden sisältö Tuote on EY:n lain mukainen konedirektiivin 2006/42/EY mukaisesti, Kuten on selitetty teknisessä asiakirjassa nro 2136 versio 2, maaliskuuta 2012</p> <p>Vastuuhenkilön allekirjoitus: Mr. Masato Nasu Puheenjohtaja Taihei Industrial Co., Ltd.</p> <p>Teknisestä asiakirjasta EU:ssa vastaavan henkilön allekirjoitus: Mr Neil Roche EMC-tuotepäällikkö TRaC Global Ltd.</p> <p>KONEEN SARJANRO Päivämäärä: 13. maaliskuuta 2012 Sertifikaatin nro 17-0074-1 DofC-numero 3</p>	<p>PROHLÁŠENÍ VÝROBCE O SHODĚ Pro Automobilový plošinový zvedák, modely PJM700, PJM800, PJM1000 & PJM1200</p> <p>Výrobeno společností Taihei Industrial Co., Ltd. Č. 49-1, Kagekatsu-cho, Fushimi-ku, Kyoto 612-8307 Japonsko</p> <p>Technický soubor sestaven a uložen v EU, jménem výrobce v TRaC Global Ltd 100 Frobisher Business Park, Leigh Sinton Road, Malvern, Worcestershire, WR14 1BX Velká Británie</p> <p>Doporučené normy k použití Směrnice o strojních zařízeních Dodatek I k 2006/42/EC s odkazem na: EN 1494:2000/A1:2008</p> <p>Prostředky pro shodu Výrobek vyhovuje předpisům ES vyjádřeným ve směrnici o strojních zařízeních 2006/42/ES, Jak je podrobně uvedeno ve Složce technické dokumentace č. 2136 revize 2, března 2012</p> <p>Podpis odpovědné osoby: p. Masato Nasu Předseda Taihei Industrial Co., Ltd.</p> <p>Podpis osoby v EU uchovávací Technickou služku: p. Neil Roche EMC Výrobní manažer TRaC Global Ltd.</p> <p>SÉRIOVÉ Č. STROJE Datum: 13. března 2012 Certifikát č. 17-0074-1 DofC vydání 3</p>	<p>GYÁRTÓI MEGFELELŐSÉGI NYILATKOZAT A Pantagraph Autóemelő PJM700, PJM800, PJM1000 & PJM1200 modelljeihez</p> <p>Gyártó Taihei Industrial Co., Ltd. No.49-1, Kagekatsu-cho, Fushimi-ku, Kyoto 612-8307 Japan</p> <p>Az EU-ban összeállított és megtartott Műszaki Akta, a gyártó részéről TRaC Global Ltd 100 Frobisher Business Park, Leigh Sinton Road, Malvern, Worcestershire, WR14 1BX United Kingdom</p> <p>Az irányadó Gépészeti irányelvként használt szabványok A 2006/42/EC I. melléklete, az EN 1494:2000/A1:2008-ra hivatkozva</p> <p>A megfelelőség eszközei A Termék megfelel az EK törvényeinek, a Gépi berendezésekre vonatkozó 2006/42/EK irányelvek alapján, A 2136. számú Műszaki Dokumentációs Akta 2., 2012. március javított kiadásában részletezettek szerint</p> <p>Felelős személy aláírása: Mr. Masato Nasu Elnök Taihei Industrial Co., Ltd.</p> <p>A Műszaki Aktát az EU-ban betartó személy aláírása: Mr Neil Roche EMC Termékmenedzser TRaC Global Ltd.</p> <p>GÉP SOROZATSZÁMA Datum: 2012. március 13. Tanúsítvány sz. 17-0074-1 DofC 3. kiadás</p>

Polski (Polish)	Slovenský (Slovak)	Eesti (Estonian)
<p>DEKLARACJA ZGODNOŚCI PRODUCENTA Dotycząca Pantografowy podnośnik samochodowy, modele PJM700, PJM800, PJM1000 i PJM1200</p> <p>Wyprodukowane przez Taihei Industrial Co., Ltd. No.49-1, Kagekatsu-cho, Fushimi-ku, Kioto 612-8307 Japonia</p> <p>Dokumentacja techniczna sporządzona i przechowywana w UE w imieniu producenta przez TRaC Global Ltd 100 Frobisher Business Park, Leigh Sinton Road, Malvern, Worcestershire, WR14 1BX Wielka Brytania</p> <p>Normy stosowane zgodnie z zaleceniami dyrektywy maszynowej Załącznik I dyrektywy 2006/42/WE w odniesieniu do: EN 1494:2000/A1:2008</p> <p>Zgodność z przepisami Produkt spełnia wymogi prawa WE zgodnie z Dyrektywą Maszynową 2006/42/WE, Zgodnie ze szczegółowym opisem w dokumentacji technicznej nr 2136 rewizja 2, marca 2012 r.</p> <p>Podpis osoby odpowiedzialnej: Pan Masato Nasu Prezes Taihei Industrial Co., Ltd.</p> <p>Podpis osoby w UE pozostającej w posiadaniu dokumentacji technicznej: Pan Neil Roche Menedżer Produktów EMC TRaC Global Ltd.</p> <p>Nr SERYJNY MASZYNY Data: 13 marca 2012 r. Nr certyfikatu 17-0074-1 DofC wyd. 3</p>	<p>VYHLÁSENIE VÝROBCU O ZHODE pre Automobilový plošinový zdvihák, modely PJM700, PJM800, PJM1000 a PJM1200</p> <p>Výrobca Taihei Industrial Co., Ltd. No.49-1, Kagekatsu-cho, Fushimi-ku, Kyoto 612-8307 Japonsko</p> <p>Technický súbor zostavený a uložený v EÚ v zastúpení výrobcu</p> <p>TRaC Global Ltd 100 Frobisher Business Park, Leigh Sinton Road, Malvern, Worcestershire, WR14 1BX Veľká Británia</p> <p>Normy použité podľa smerníc o strojových zariadeniach Príloha I 2006/42/ES s odkazom na: EN 1494:2000/A1:2008</p> <p>Prostriedky pre zhodu Tento výrobok je v súlade so zákonmi EÚ podľa smernice o strojových zariadeniach 2006/42/ES, Ako je uvedené v technickej dokumentácii č. 2136 revízia č. 2, marec 2012</p> <p>Podpis zodpovednej osoby: Mr. Masato Nasu Riaditeľ Taihei Industrial Co., Ltd.</p> <p>Podpis osoby v EÚ držiacej technickú dokumentáciu: Mr Neil Roche Produktový manažér EMC TRaC Global Ltd.</p> <p>VÝROBNÉ ČÍSLO ZARIADENIA Dátum: 13. marec 2012 Certifikát č. 17-0074-1 Vyhł. o zhode 3.vydanie</p>	<p>TOOTJATE VASTAVUSDEKLARATSIOON toodetele Autotungraud Pantagraph, mudelid PJM700, PJM800, PJM1000 ja PJM1200</p> <p>Tootja Taihei Industrial Co., Ltd. No.49-1, Kagekatsu-cho, Fushimi-ku, Kyoto 612-8307 Japan (Jaapan)</p> <p>Tehnilise toimiku koostaja ja selle hoidja tootja nimel Elis</p> <p>TRaC Global Ltd 100 Frobisher Business Park, Leigh Sinton Road, Malvern, Worcestershire, WR14 1BX United Kingdom (Ühendkuningriik)</p> <p>Suunistena kasutatud standardid Masinate direktiiv 2006/42/EC lisa I viitematerjaliga standardist EN 1494:2000/A1:2008</p> <p>Vastavusnormatiivid Antud toode on vastavuses EÜ seadustega, mis on ühtlustatud masinate direktiiviga 2006/42/EÜ, Vastavalt üksikasjalisele kirjeldusele tehnilise dokumentatsiooni toimikus nr 2136, redaktsioon 2, märts 2012</p> <p>Vastutava isiku allkiri: Mr. Masato Nasu President Taihei Industrial Co., Ltd.</p> <p>Tehnilise dokumentatsiooni hoidja allkiri ELIS: Mr Neil Roche EMC tootejuht TRaC Global Ltd.</p> <p>MASINA SEERIANUMBER Kuupäev: 13. märts 2012 Sertifikaat nr 17-0074-1 DofC, väljaanne 3</p>

Lietuvių kalba (Lithuanian)	Latviešu valoda (Latvian)	Slovenščina (Slovenian)
<p>GAMINTOJO ATITIKTIES DEKLARACIJA Skirta šiems modeliams Žirklinis automobilinis domkratas, modeliai PJM700, PJM800, PJM1000 ir PJM1200</p> <p>Pagaminta Taihei Industrial Co., Ltd. No.49-1, Kagekatsu-cho, Fushimi-ku, Kiotas 612-8307 Japonija</p> <p>Techninė byla sudaryta ir laikoma ES, gamintojo vardu</p> <p>TRaC Global Ltd 100 Frobisher Business Park, Leigh Sinton Road, Malvern, Worcestershire, WR14 1BX Jungtinė Karalystė</p> <p>Naudojami Mašinų direktyvoje nurodyti standartai Direktyvos 2006/42/EB I priedas su nuoroda į: EN 1494:2000/A1:2008</p> <p>Atitikties apibūdinimas Šis gaminytis atitinka EB įstatymus, apibrėžtus Mašinų direktyvoje 2006/42/EB.</p> <p>Kaip nurodyta Techninės dokumentacijos byloje Nr. 2136, 2-iojoje pataisoje, 2012 m. kovo mėn.</p> <p>Atsakingo asmens parašas: P. Masato Nasu Prezidentas Taihei Industrial Co., Ltd.</p> <p>Asmens, kuriam ES priklauso Techninė dokumentacija, parašas: P. Neil Roche EMC gamybos vadovas TRaC Global Ltd.</p> <p>MAŠINOS SERIJOS Nr. Data: 2012 m. kovo 13 d. Sertifikato Nr. 17-0074-1 DofC, 3-iasis leidimas</p>	<p>RAŽOTĀJA ATBILSTĪBAS DEKLARĀCIJA Izstrādājums Pantogrāfa tipa automobiļa domkrats, modeļi PJM700, PJM800, PJM1000 un PJM1200</p> <p>Ražotājs Taihei Industrial Co., Ltd. No.49-1, Kagekatsu-cho, Fushimi-ku, Kyoto 612-8307 Japan</p> <p>Tehniskais fails ir kompilēts un to uzglabā ES ražotāja vārdā</p> <p>TRaC Global Ltd 100 Frobisher Business Park, Leigh Sinton Road, Malvern, Worcestershire, WR14 1BX United Kingdom</p> <p>Standarti, kas izmantoti kā Mehānismu direktīvas vadlīnijas direktīvas 2006/42/EK Pielikums I ar atsauci uz EN 1494:2000/A1:2008</p> <p>Atbilstības nodrošināšanas līdzekļi Izstrādājums atbilst EK likumiem, kas tuvināti ar Mašīnu direktīvu 2006/42/EK, Kā detalizēti norādīts Tehniskās dokumentācijas failā Nr. 2136, 2. pārstrādātais izdevums, 2012. g. Marts</p> <p>Atbildīgās personas paraksts: Masato Nasu k-gs Prezidents Taihei Industrial Co., Ltd.</p> <p>Personas, kas glabā tehnisko failu ES, paraksts: Neil Roche k-gs EMC produktu menedžeris TRaC Global Ltd.</p> <p>MEHĀNISMA SĒRIJAS Nr. Datums: 2012. gada 13. Marts Sertifikāta Nr. 17-0074-1 DofC, 3. izdevums</p>	<p>IZJAVA PROIZVAJALCEV O SKLADNOSTI Za Dvigalka Pantagraph, Modeli PJM700, PJM800, PJM1000 & PJM1200</p> <p>Proizvajaja Taihei Industrial Co., Ltd. No.49-1, Kagekatsu-cho, Fushimi-ku, Kjoto 612-8307, Japonska</p> <p>Tehnično dokumentacijo se, v imenu proizvajalca, za EU zbira in hrani na TRaC Global Ltd 100 Frobisher Business Park, Leigh Sinton Road, Malvern, Worcestershire, WR14 1BX Združeno kraljestvo</p> <p>Standarti se uporabljajo kot vodilo Direktive o strojih Aneks I k 2006/42/ES s sklicem na: EN 1494:2000/A1:2008</p> <p>Skladnost Proizvod je v skladu z zakonodajo ES, kot navaja Direktiva o strojih 2006/42/ES, Kot je podrobno opisano v Tehnični dokumentaciji številka dokumenta 2136 revizija 2, marec 2012</p> <p>Podpis odgovorne osebe: G. Masato Nasu Predsednik Taihei Industrial Co., Ltd.</p> <p>Podpis osebe v EU, ki hrani tehnično dokumentacijo: G. Neil Roche EMC Produktni vodja TRaC Global Ltd.</p> <p>SERIJSKA ŠT. STROJA Datum: 13. marec 2012 Št. certifikata 17-0074-1 DofC Izdaja 3</p>

Български (Bulgarian)	Român (Romanian)	Hrvatski (Croatian)
<p>ДЕКЛАРАЦИЯ ЗА СЪОТВЕТСТВИЕ НА ПРОИЗВОДИТЕЛЯ За Авто крик тип пантограф, модели PJM700, PJM800, PJM1000 и PJM1200</p> <p>Произведено от Taihei Industrial Co., Ltd. No.49-1, Kagekatsu-cho, Fushimi-ku, Kyoto 612-8307 Japan</p> <p>Техническото досие е изготвено и се съхранява в ЕС от името на производителя от TRaC Global Ltd 100 Frobisher Business Park, Leigh Sinton Road, Malvern, Worcestershire, WR14 1BX United Kingdom</p> <p>Стандартите, използвани като ръководство за директива за машините Приложение I от 2006/42/EC с позоваване на: EN 1494:2000/A1:2008 Съответствие с изискванията Продуктът отговаря на законодателството на ЕО, съгласно Директива за машините 2006/42/EC, Както е описано подробно в Папка с техническа документация No. 2136 редакция 2, март 2012</p> <p>Подпис на отговорното лице: Г-н Масато Насу Президент Taihei Industrial Co., Ltd.</p> <p>Подпис на лицето в ЕС, притежаващо техническото досие: Г-н Нийл Рош Продуктов мениджър за EMC TRaC Global Ltd.</p> <p>СЕРИЕН No. НА МАШИНАТА Дата: 13 март 2012г. Сертификат No. 17-0074-1 DofC издание 3</p>	<p>DECLARAȚIA DE CONFORMITATE A PRODUCĂTORULUI Pentru Cric pantograf pentru automobile, modelele PJM700, PJM800, PJM1000 & PJM1200</p> <p>Produs de Taihei Industrial Co., Ltd. No.49-1, Kagekatsu-cho, Fushimi-ku, Kyoto 612-8307 Japonia</p> <p>Dosarul tehnic elaborat și păstrat în UE în numele producătorului de către TRaC Global Ltd 100 Frobisher Business Park, Leigh Sinton Road, Malvern, Worcestershire, WR14 1BX Regatul Unit</p> <p>Standarde utilizate ca linii directoare în Directiva privind echipamentele tehnice Anexa I la Directiva 2006/42/CE cu trimitere la: EN 1494:2000/A1:2008 Mijloace de asigurare a conformității Produsul respectă legislația CE, astfel cum este aproximată de Directiva Mașini 2006/42/CE și cum este detaliată în Dosarul de documentație tehnică nr. 2136, revizia 2, martie 2012</p> <p>Semnătura persoanei responsabile: DI. Masato Nasu Președinte Taihei Industrial Co., Ltd.</p> <p>Semnătura persoanei din UE care păstrează Dosarul tehnic: DI. Neil Roche Manager Produs EMC TRaC Global Ltd.</p> <p>NR. DE SERIE ECHIPAMENT Data: 13 martie 2012 Certificat nr. 17-0074-1 DofC Ediția 3</p>	<p>PROIZVODAČEVA IZJAVA O SUKLADNOSTI За Pantografska auto dizalica, Modeli PJM700, PJM800, PJM1000 & PJM1200</p> <p>Proizvodi Taihei Industrial Co., Ltd. No.49-1, Kagekatsu-cho, Fushimi-ku, Kyoto 612-8307 Japan</p> <p>Tehnički dokument sastavljen i držan u EU, u ime proizvođača</p> <p>TRaC Global Ltd 100 Frobisher Business Park, Leigh Sinton Road, Malvern, Worcestershire, WR14 1BX Ujedinjeno Kraljevstvo</p> <p>Standardi korišteni kao smjernice Direktive o strojevima</p> <p>Dodatak I iz 2006/42/EC s povezivanjem s: EN 1494:2000/A1:2008 Značenje sukladnosti Proizvod je sukladan sa zakonima EK po Direktivi o strojevima 2006/42/EC, Kao što je navedeno u Tehničkoj dokumentaciji dokument broj 2136 revizija 2, ožujka 2012.</p> <p>Potpis ovlaštene osobe: G. Masato Nasu Predsjednik Taihei Industrial Co., Ltd.</p> <p>Potpis osobe iz EU koja posjeduje Tehnički dokument: G. Neil Roche EMC Menadžer proizvoda TRaC Global Ltd.</p> <p>SERIJSKI BROJ UREĐAJA Datum: 13. ožujka 2012. Certifikat br. 17-0074-1 DofC Broj 3</p>

Norsk (Norwegian)	Türk (Turkish)	Íslenska (Icelandic)
<p>PRODUSENTENS ERKLÆRING OM OVERENSSTEMMELSE For Pantagraph biljekk, modellene PJM700, PJM800, PJM1000 og PJM1200</p> <p>Produsert av Taihei Industrial Co., Ltd Nr. 49-1, Kagekatsu-cho, Fushimi-ku, Kyoto 612-8307 Japan</p> <p>Teknisk fil er satt sammen og lagret i EU, på vegne av produsenten av TRaC Global Ltd 100 Frobisher Business Park, Leigh Sinton Road, Malvern, Worcestershire, WR14 1BX, Storbritannia</p> <p>Veiledende standarder, brukt av maskindirektivet Tillegg 1 for 2006/42/EU med henvisning til: EN 1494:2000/A1:2008</p> <p>Betydningen av overensstemmelse Apparatet er i overensstemmelse med EU-lovverket, slik det er tilnærmet i maskindirektiv 2006/42/EU, Som beskrevet i teknisk dokumentasjonsfil nr. 2136, revisjon 2, fra mars 2012</p> <p>Signatur fra ansvarlig person: Hr. Masato Nasu Direktør Taihei Industrial Co., Ltd.</p> <p>Signatur til person i EU som oppbevarer teknisk fil: Hr. Neil Roche EMC produktsjef TRaC Global Ltd.</p> <p>MASKINENS SERIENR. Dato: 13. mars 2012 Sertifikat nr. 17-0074-1 DofC utgave 3</p>	<p>AŞAĞIDAKİ ÜRÜNLER İÇİN İMALATÇI UYGUNLUK BEYANI Pantograf Araba Krikosu, Model PJM700, PJM800, PJM1000 ve PJM1200</p> <p>Üretici : Taihei Industrial Co., Ltd No.49-1, Kagekatsu-cho, Fushimi-ku, Kyoto 612-8307 Japonya</p> <p>İmalatçı adına Teknik Dosyayı derleyen ve AB'de muhafaza eden kuruluş TRaC Global Ltd 100 Frobisher Business Park, Leigh Sinton Road, Malvern, Worcestershire, WR14 1BX Birleşik Krallık</p> <p>Yol Gösterici Makine Yönetmeliği olarak kullanılan standartlar EN 1494:2000/A1:2008 no.lu standarda atfta bulunan 2006/42/EC no.lu Ek I</p> <p>Uyumluluk Aracı Ürün, 2006/42/EC no.lu Makine Yönetmeliği tarafından öngörülmediği şekilde Avrupa Topluluğu yasalarıyla uyumludur, 2136 No.lu 2. Revizyon, 2012 Mart tarihli Teknik Dokümantasyon Dosyasında detaylandırıldığı şekilde</p> <p>Sorumlu Kişinin İmzası: Sayın Masato Nasu Başkan Taihei Industrial Co., Ltd.</p> <p>Teknik Dosyayı AB'de muhafaza eden kişinin imzası: Sayın Neil Roche EMC Ürün Müdürü TRaC Global Ltd.</p> <p>MAKİNE SERİ No. Tarih: 13 Mart 2012 Sertifika No. 17-0074-1 no.lu Uyum Beyanı Yayın 3</p>	<p>YFIRLÝSING FRAMLEIÐANDA UM SAMRÆMI Fyrir Bila-Skæra Tjakkur, Gerðir PJM700, PJM800, PJM1000 & PJM1200</p> <p>Framleitt af Taihei Industrial Co., Ltd Nr.49-1, Kagekatsu-cho, Fushimi-ku, Kýótó 612-8307 Japan</p> <p>Tækniskjal tekið saman og notað í ESB, fyrir hönd framleiðanda</p> <p>TRaC Global Ltd 100 Frobisher Business Park, Leigh Sinton Road, Malvern, Worcestershire, WR14 1BX, Bretland</p> <p>Staðlar notaðir sem leiðsögn Tilskipun Vélbúnaðar Viðauki I frá 2006/42/EC með tilvísun til: EN 1494:2000/A1:2008</p> <p>Uppfylling skilyrða Varan uppfyllir lög ESB eins og mælt er fyrir í tilskipun 2006/42/EC um vélarbúnað, Sem tekið er fram í tækniskjali nr. 2136 2. Endurskoðun, mars 2012</p> <p>Undirskrift ábyrgðarmanns: Hr. Masato Nasu Forstjóri Taihei Industrial Co., Ltd.</p> <p>Undirskrift einstaklings í ESB sem heldur um tækniskjalið: Hr. Neil Roche EMC Framleiðslustjóri TRaC Global Ltd.</p> <p>RAÐNÚMER TÆKIS Dagsetning: 13. mars 2012 Númer vottorðs 17-0074-1 DofC útgáfa 3</p>



**EC Declaration of Conformity
according to EC Machinery Directive 2006/42/EC**

We, **SAMKI IND. CO., LTD.**
22, Hyojuk3-Gil, Buk-Gu, Ulsan, Korea
declare under our sole responsibility that the product

Product : Jack Assembly
Product Type : Pantograph Type
Type Designation(s) : Jack Assembly-1000kg, Jack Assembly-1200kg

to which this declaration relates is in conformity with the following standard(s) or other normative document(s):
EN ISO12100 Safety of machinery - General principles for design – Risk assessment (2010) and risk reduction
EN ISO12100-2/A1 Safety of machinery - Basic concepts, general principles for design, Part (2009) 2 : Technical principles
EN 1494/A1 Mobile or movable jacks and associated lifting equipment (2008)

following the provisions of Directive(s):
2006/42/EC Directive on the approximation of the laws of Member States relating to machinery (OJ L157 Jun, 9, 2006)

Ulsan, Korea / August 13 2014 Hyun Duck, Cho President
(Place and date of issue)(name and signature or equivalent making of authorized person)

* T.C.F Compiling Person: Safenet Limited (European Notified body : 1674)
Denford Garage, Denford, Kettering Northants, NN14 4EQ, England

OGKE20E1

<p>Deutsch(German)</p> <p>EG Konformitätserklärung nach EG-Maschinenrichtlinie 2006/42/EG</p> <p>Wir, SAMKIND, CO., LTD. # 22, Hyojok3-Gil, Buk-Gu, Ulsan, Korea erklären in allerhöchster Verantwortung, dass das Produkt Heber Produkt: Paurograph Wagenheber Art des Produktes Heber – 1000 kg, Heber – 1200 kg Bezeichnung: auf das diese Erklärung bezieht, in Übereinstimmung mit den folgenden Normen oder anderen normativen Dokumenten ist:</p> <p>ENISO 12100 Sicherheit von Maschinen – Allgemeine Gestaltungsgrundsätze – ENISO 12100-2/A1 Risikobewertung und Risikominimierung ENISO 12100-2/A1 Sicherheit von Maschinen – Grundbegriffe, Allgemeine Gestaltungsgrundsätze, Teil 2; Technische Zeichnungen EN 1494/A1 Fahrbare und ortsfestverbaute Hebegeräte und verwandte Einrichtungen (2008)</p> <p>Gemäß den Bestimmungen der Richtlinie(6); Richtlinie zur Angleichung der Rechtsvorschriften der Mitgliedstaaten betreffend die Maschinen (Amtsblatt L 157 9. Juni 2006)</p> <p>Verfasser der technischen Produktdokumentation: Safert Limited (Europäische Benannte Stelle, 1674) Denford Garage, Denford, Kettering Northants, NN14 4EQ, England</p>	<p>Français (French)</p> <p>Declaration de conformité à la Directive relative aux Machines 2006/42/CE</p> <p>Nous, SAMKIND, CO., LTD. # 22, Hyojok3-Gil, Buk-Gu, Ulsan, Corée déclarons sous notre responsabilité que le produit Produit : Ensemble cric Type du produit : Type paurographe Type de la conception(s): Ensemble cric - 1000kg, Ensemble cric - 1200kg auquel se réfère cette déclaration est conforme au(x) standard(s) suivant et autre(s) normé(s):</p> <p>EN ISO 12100 Sécurité des machines - Principes généraux de conception - Appréciation du risque et réduction du risque (2010)</p> <p>EN ISO 12100-2/A1 Sécurité des machines - Notions fondamentales, principes généraux de conception - Partie 2 : principes techniques (2009)</p> <p>EN 1494/A1 Cric mobiles ou déplaçables et équipements de levage associés (2008)</p> <p>et respecte les provisions de la Directive(s): 2006/42/CE Directive relative à l'approchement des législations des Etats Membres concernant les machines (Journal Officiel L157 du 9 juin 2006)</p> <p>* Personne qui a élaboré le Dossier de Consommation Technique: Safert Limited (Organisme notifié européen: 1674) Denford Garage, Denford, Kettering Northants, NN14 4EQ, Angleterre</p>
<p>Italiano(italian)</p> <p>Dichiarazione di conformità CE ai sensi della Direttiva Macchine 2006/42/CE</p> <p>Il produttore SAMKIND, CO., LTD. # 22, Hyojok3-Gil, Buk-Gu, Ulsan, Corea dichiara, sotto la propria responsabilità, che il prodotto Prodotto : Asieme marciante Type di prodotto : Type paurographe Designazione(6) del tipo : Ensemble cric - 1000kg, Ensemble cric - 1200kg</p> <p>al quale si riferisce questa dichiarazione è conforme ai seguenti standard e altri normativi:</p> <p>EN ISO 12100 Sicurezza del Macchinario - Principi generali di progettazione - Valutazione del rischio e riduzione del rischio (2010)</p> <p>EN ISO 12100-2/A1 Sicurezza del Macchinario - Concetti fondamentali, principi generali di progettazione - Parte 2; Principi tecnici (2009)</p> <p>EN 1494/A1 Manufatti spostabili o mobili ed apparecchi di sollevamento associati (2008)</p> <p>e osserva le disposizioni della Direttiva(6); Direttiva concernente il avvicinamento delle legislazioni degli Stati membri relative al Macchinario (Gazzetta Ufficiale L157 9 luglio 2006)</p> <p>* Persona che a reso il dossier tecnico di fabbricazione: Safert Limited (Organismo notificato europeo: 1674) Denford Garage, Denford, Kettering, Northants, NN14 4EQ, Inghilterra</p>	<p>Nederlands (Dutch)</p> <p>EG Verklaring van conformiteit volgens EG-machinerichtlijn 2006/42/EC</p> <p>Wij, SAMKIND, CO., LTD. # 22, Hyojok3-gil, Buk-gu, Ulsan, Korea verklaren onder onze eigen verantwoordelijkheid dat het product Product : Jack Assembly Product type : Paurograf type Typeaanwijding(en): Jack Assembly- 1000kg, Jack Assembly- 1200kg waarop deze verklaring betrekking heeft, in overeenstemming is met de volgende norm(en) of andere normatieve document(en):</p> <p>EN ISO 12100 Veiligheid van machines - Algemene principes voor het ontwerp - Risicobebodding en risicoreductie (2010)</p> <p>EN ISO 12100-2:A1 Veiligheid van machines - Basisbegrippen, algemene principes voor ontwerp. Deel 2: Technische principes (2009)</p> <p>EN 1494/A1 Mobilie of verplaatsbare aanbuigen en soortgelijke hefvoorzieningen (2008)</p> <p>volgens de bepalingen van de richtlijn(en): 2006/42/EC Richtlijn betreffende de onderlinge aanpassing van de wetgevingen van de lidstaten betreffende machines (01 L157 9 juni 2006)</p> <p>* T.C.F. Rapporterende persoon: Safert Limited (Europese aangemelde instantie: 1674) Denford Garage, Denford, Kettering Northants, NN14 4EQ, England</p>

<p>Dansk(Danish)</p> <p>EF Overensstemmelseserklæring ifølge EF Maskine direktiv: 2006/42/EB</p> <p>Vi, SAMKI IND CO. LTD. # 22, Hyejuleš-Gil, Buk-Gu, Ulsan, Korea beholder på eget ansvar, at produkt</p> <p>Produkt : Donkraft</p> <p>Produkt type : Pantograf type</p> <p>Andre mulige produkt typer: 1000kg donkraft, 1200kg donkraft</p> <p>hvis overensstemmelseserklæring fremlægges hennet, stemmer overens med denne (disse) standard eller anden (andre) myndighedskrav.</p> <p>EN ISO12100 Maskinsikkerhed. Generelle principper for projektering. (2010) Risikoanalyse og risikobærelse. EN ISO12100-2/A1 Maskinsikkerhed. Gennemledende beæbter, generelle (2009) principper for projektering. Del 2. Tekniske principper. EN 1494/A1 Mobile eller flytbare donkrafte og tilsvarende luftendstyr. (2008)</p> <p>Samt Direktivs bestemmelser: 2006/42/EB Direktiv vedrørende harmonisering af lovgivning af EU medlemsstaterne i forbindelse med maskinrentedelse (OJ L157 af den 9. juni 2006)</p> <p>* Person, som udfærdigede teknisk dokumentation: Safenet Limited (Europas akkrediterede myndighed: 1674) Denford Garage, Denford, Kettering, Northants, NN14 4EQ, England</p>	<p>Ελληνική (Greek)</p> <p>Δήλωση πιστότητας ΕΚ σύμφωνα με την οδηγία 2006/42/ΕΚ</p> <p>Εμείς, SAMKI IND CO., LTD. # 22, Ηγεγιλέ-Σιλ, Βουκ-Γου, Ουλσαν, Κορέα δηλώνουμε με αποκλειστική μας ευθύνη ότι το προϊόν</p> <p>Πρόϊον : Πανκράτ</p> <p>Τύπος προϊόντος : Τύπος παντογράφου</p> <p>Χαρακτηριστικός(οί) τύπος(οι): Πανκράτ, γρίλιου-1000kg, Πανκράτ γρίλιου-1200kg</p> <p>εάν το προϊόν υποβληθεί ή παρουσιάσει δήλωση είναι σύμφωνα με το ακόλουθο πρότυπο(-οί) ή άλλο(-ο) κανονιστικό(-ο) έγγραφο(-ο):</p> <p>EN ISO12100 Αρμόδια μηχανών - Γενικές αρχές, για το (2010) σχεδιασμό - αξιολόγηση και μέτρηση κινώμενο</p> <p>EN ISO12100-2/A1 Αρμόδια μηχανών - Βασικές έννοιες, (2009) γενικές αρχές, σχεδίαση, μέρος 2: Τεχνικές αρχές;</p> <p>EN 1494/A1 Κριτές ή κινούμενα; γρίλιος και σχετικά, (2008) εξοπλισμός ανύψωσης</p> <p>σύμφωνα με τις διατάξεις της των οδηγιών(-ων): 2006/42/ΕΚ Οδηγία για την πιστότητα των υιοθετημένων των κράτων μέλων σχετικά με τις μηχανές (OJ L157 9 Ιουνίου 2006)</p> <p>* Νομικό πρόσωπο που υπέγραψε, τεχνικός, μονάδα έλεγχου - Safenet Limited (Ευρωπαϊκός κανονιστικός οργανισμός: 1674) Denford Garage, Denford, Kettering, Northants, NN14 4EQ, Αγγλία</p>
<p>Español (Spanish)</p> <p>Declaración de conformidad CE según la Directiva Comunitaria sobre Maquinaria 2006/42/CE</p> <p>SAMKI IND CO, LTD. # 22, Hyejuleš-Gil, Buk-Gu, Ulsan, Corea declaramos bajo nuestra responsabilidad que el producto</p> <p>Producto : ensamble gato</p> <p>Tipo de producto : tipo pantógrafo</p> <p>Tipo de designación(es): ensamble gato, 1000kg, ensamble gato, 1200kg al que hace referencia esta declaración cumple con el(s) estándar(s) siguientes u otros)</p> <p>EN ISO12100 Seguridad de las máquinas - Principios generales para el (2010) diseño - Evaluación del riesgo y reducción del riesgo</p> <p>EN ISO12100-2/A1 Seguridad de las máquinas - Conceptos básicos, principios (2009) generales para el diseño. Parte 2: Principios básicos</p> <p>EN 1494/A1 Gatos móviles o portátiles y equipos de elevación asociados. (2008)</p> <p>está siguiendo las disposiciones de los(los) Directiva(s): 2006/42/EC Directiva relativa a la aproximación de las legislaciones de los Estados miembros sobre máquinas (Diario Oficial L157 9 de junio de 2006)</p> <p>* Persona que la elaboró el expediente técnico de construcción: Safenet Limited (organismo notificado europeo: 1674) Denford Garage, Denford, Kettering, Northants, NN14 4EQ, Inglaterra</p>	<p>Português (Portuguese)</p> <p>EC Declaração de Conformidade de acordo com a EC Directiva de Máquinas 2006/42/EC</p> <p>Nós, SAMKI IND CO., LTD. # 22, Hyejuleš-Gil, Buk-Gu, Ulsan, Coréia Declaramos com nossa única responsabilidade que o presente produto</p> <p>Produto : Jack Assembly (Montagem de Jack)</p> <p>Tipo de Produto : Tipo Pantógrafo</p> <p>Tipo de Designação : Jack Assembly-1000kg, Jack Assembly-1200kg referido nesta declaração está em conformidade com as seguintes normas ou outros documentos normativos:</p> <p>EN ISO12100 Segurança de Máquinas - Princípios gerais para o (2010) projeto - Avaliação e redução de riscos.</p> <p>EN ISO12100-2/A1 Segurança de Máquinas - Conceitos básicos (2009) princípios gerais para o projeto, Parte 2: Princípios Técnicos</p> <p>EN 1494/A1 Máquinas hidráulicas móveis ou amovíveis e (2008) equipamento associado de elevação.</p> <p>segundo as disposições da diretiva: 2006/42/EC Directiva sob aproximação das legislações dos Estados Membros respeitantes às máquinas (OJ L157, 9 de junho de 2006)</p> <p>* T.C.F Pessoa Compadrã: Safenet Limited (Organismo Europeu Notificado : 1674) Denford Garage, Denford, Kettering, Northants, NN14 4EQ, Inglaterra.</p>

<p>Svenska (Swedish)</p> <p>EG Överensstämmelseförklaring enligt EG-maskindirektivet 2006/42/EC</p> <p>V: SAMKIND CO., LTD. # 22, Hyojuk3-gil, Buk-gu, Ulsan, Korea (företagets namn enligt EG-maskindirektivet)</p> <p>Produkt : Jack Assembly Produkttyp : Srotavtagsrepp</p> <p>Typbeskrivning(er): Jack Assembly-1000kg, Jack Assembly-1200kg som denna försäkringen är överensstämmande med följande standard(er) eller andra normgivande dokument(er):</p> <p>EN ISO12100 Maskinsäkerhet - Allmänna konstruktionsprinciper - (2010) Färdigställning och riskbedömning EN ISO12100-2:AI Maskinsäkerhet - Grundläggande begrepp, allmänna konstruktionsprinciper. Del 2: Tekniska principer (2009) EN 1494:AI Rottjärn eller fjärrdrifts donorkärl och liknande lyftanordning (2008) enligt villkoren i direktiv(en): 2006/42/EC Direktiv om tillämpning av medlemsstaters lagarna om maskiner (01.11.17 den 9 juni 2006)</p> <p>* T.C.F Sammansättningspersoner: Safenet Limited (Europeiska Ansvarigt Organ: 1674) Denford Garage, Denford, Kettering, Northants, NN14 4EQ, England</p>	<p>Suomi (Finnish)</p> <p>Valmistajan vakautus tuotteen vaatimustenmukaisuudesta EY-koneidirektiivin 2006/42/EY mukaan</p> <p>M: SAMKIND CO., LTD. # 22, Hyojuk3-Gil, Buk-Gu, Ulsan, Korea, vakauttamme omalla vastuullamme, että tuote</p> <p>Tuote : tunkki viivroittimen muovioinen</p> <p>Tuotteen tyyppi: tunkki - 1 000 kg, tunkki - 1 200 kg</p> <p>Tyypimerkinnot: jota tämä vakautus koskee, löytyy seuraavien standardien tai muiden normien alalta:</p> <p>EN ISO 12100 Koneeturvallisuus - Yleiset suunnitteluperiaatteet (2010) - Riskien arviointi ja vähentäminen EN ISO 12100-2:AI Koneeturvallisuus - Penskonseptit, yleiset suunnitteluperiaatteet, osa 2: Tekniset periaatteet (2009) EN 1494:AI Siirtävät tunkit (2008)</p> <p>noudattajan samantarvan direktiivin säännöksiä: 2006/42/EY Direktiivi koneita koskevan jäsenvaltioiden lainsäädännön lähentämisestä (01.11.17, 9. kesäkuuta 2006)</p> <p>* Tekniikan rakennettaesson laittaja: Safenet Limited (eurooppalainen ilmoitettu laitos 1674) Denford Garage, Denford, Kettering, Northants, NN14 4EQ, Englanti</p>
<p>Ceskké (Czech)</p> <p>ES Prohlášení o shodě podle Směrnice Evropského parlamentu a Rady 2006/42/ES o strojních zařízeních</p> <p>M: společnost SAMKIND CO., LTD. # 22, Hyojuk3-Gil, Buk-Gu, Ulsan, Korea prohlášením na svou odpovědnost, že</p> <p>produkt : sestava zvedáku typ produktu : pantografový určen produkt : sestava zvedáku - 1000 kg, sestava zvedáku - 1200 kg</p> <p>kreáto se toto prohlášení říká odpovídá následující normě / normám nebo jinému normativnímu dokumentu / dokumentům:</p> <p>EN ISO12100 Bezpečnost strojů - Obecné zásady konstrukce - (2010) Hodnocení rizik a snížení rizik EN ISO12100-2:AI Bezpečnost strojů - Základní koncepty, obecné principy konstrukce, část 2: Technické principy (2009) EN 1494:AI Mobilní nebo pohyblivé zvedáky a přístřadky zve diet zařízení (2008)</p> <p>náslédjícím ustanovením Směrnice(s) 2006/42/ES Směrnice o harmonizaci zákonných předpisů členských států vztahujících se k strojním zařízením (Úř. věst. L157 9. čerun 2006)</p> <p>*Zpracoval: Safenet Limited (Evropská notifikovaná osoba: 1674) Denford Garage, Denford, Kettering, Northants, NN14 4EQ, Velká Británie</p>	<p>Magyar (Hungarian)</p> <p>EK Megfeleléstégi Nyilatkozat A gépekről szóló 2006/42/EK irányelv szerint</p> <p>M: SAMKIND CO., LTD. # 22. Hyojuk3-Gil, Buk-Gu, Ulsan, Korea saját felelősségemre nyilatkozom</p> <p>Termék : emelőszerkezet Termék típusa : típus áramszedő Megnevezés : emelőszerkezet-1000kg, emelőszerkezet-1200kg</p> <p>amire ez a nyilatkozat vonatkozik az alábbi szabványoknak vagy egyéb jogszabványoknak megfelelően: EN ISO12100 Gépek biztonságja - A kialakítás általános elvei - Kockázatfelmérés és közzététel elkészítése (2010) EN ISO12100-2:AI Gépek biztonságja - A kialakítás általános elvei, Második rész: (2009) EN 1494:AI Műszaki alapelvek (2008) Mozgatható és áthelyezhető emelők és hasonló szerkezetek</p> <p>amuk a következő irányelv cikkelyeit követik: 2006/42/EC Irányelv a tagállamok gépekre vonatkozó törvényeinek közelítéséről (Hivatalos Közlemény L157, 2006. június 9.)</p> <p>* Műszaki Szakértésesi Irtatók összejelölése: Safenet Limited (Európai Unióba bejelentett szervezet: 1674) Denford Garage, Denford, Kettering, Northants, NN14 4EQ, England</p>

<p>Polskie(Polish)</p> <p>Deklaracja zgodności WE Zgodnie z Dyrektywą Maszynowa 2006/42/WE</p> <p>Mę. SAMKIND CO., LTD. # 22, Hyejuik3-Gil, Buk-Gu, Ulsan, Korea ostwiadczeni z pełną odpowiedzialnością, że produkt</p> <p>Produkt : Lewar Rodzaj produktu : Pantografowy Dostępne rodzaje produktów: lewar 1000kg, lewar 1200kg którego dotyczy niniejsza deklaracja, jest zgodny z poniższą (-ymi) normą (-ami) lub innymi (-ymi) dokumentami (-ami) normatywnymi (-ymi): EN ISO12100 Bezpieczeństwo maszyn. Ogólne zasady projektowania. Ocena ryzyka i zmniejszanie ryzyka EN ISO12100-2:A1 Bezpieczeństwo maszyn. Pojęcia podstawowe. (2009) ogólne zasady projektowania. Część 2. Zasady i wymagania techniczne. EN 1494:A1 Podstawki przesłania lub przesłumy i urządzenia podnoszące pokrowce (2008) urządzenie podnoszące pokrowce oraz postanowieniami Dyrektywy (Dyrektywy) 2006/42/WE Dyrektywa 2006/42/WE Parlamentu Europejskiego i Rady z dnia 17 maja 2006 r. w sprawie maszyn, zmieniająca dyrektywę 95/16/WE (przekazanie) (DZ UE L157 z dnia 9 czerwca 2006 r.) * Podmiot, który przygotował dokumentację techniczną: Safenet Limited (Europejski ośrodek akredytacji: 1674) Denford Garage, Denford, Kettering Northants, NN14 4EQ, Anglia</p>	<p>Slovenský (Slovak)</p> <p>ES vyhlásenie o zhode v súlade so smernicou o strojových zariadeniach ES č. 2006/42/ES</p> <p>Mę. SAMKIND CO., LTD. # 22, Hyejuik3-Gil, Buk-Gu, Ulsan, Korea vyhlásuje na vlastnú zodpovednosť, že výrobok</p> <p>Výrobok : Zdvihaková súprava Typ výrobu : Typ pantograf Typové určenie(s): Zdvihaková súprava - 1 000 kg, Zdvihaková súprava - 1 200 kg na ktorý sa vzťahuje toto vyhlásenie, sa zhoduje s nasledujúcim(-imi) normami alebo inými(-imi) normatívnymi(-imi) dokumentami(-ami). EN ISO12100 Bezpečnosť strojových zariadení – Všeobecné pravidlo vyjadrené sa návrhu – Hlohovanie rizika a znížovanie rizika EN ISO12100-2:A1 Bezpečnosť strojových zariadení – Základné koncepty: všeobecné pravidlo vyjadrené sa návrhu, časť 2: Technické pravidlo EN 1494:A1 Mobilné alebo prenosné zdvíhaky a strážisce zdí podľa ustanovení smernice(s). EN 2006/42/ES Smernica o aprovaní zariadení, členských štátov týkajúcich sa strojových zariadení (E. v. L157 z 9. júna 2006) * Zostavil(a) T.C.F. Safenet Limited (európsky osmaňový orgán: 1674) Denford Garage, Denford, Kettering Northants, NN14 4EQ, Anglicko</p>
<p>Eesti(Estonian)</p> <p>EÜ Vastavusdeklaratsioon Vastavalt Masinadirektiivile 2006/42/EÜ</p> <p>Mees. SAMKIND CO., LTD. # 22, Hyejuik3-Gil, Buk-Gu, Ulsan, Korea Kinnitanne oma vastutusest, et toode</p> <p>Toode : Tungraud Toote tüüp : Trappets Toote võimalikud versioonid: 1000kg tungraud, 1200kg tungraud millale väljastatud käesolev deklaratsioon vastab järgnevale standardidele või teistele normidokumentidele: EN ISO12100 Masinohuatus. Konstruktiivne, riskide hindamine ja riskide vältimise üldpõhimõtted. EN ISO12100-2:A1 Masinohuatus. Põhimõtted, projektiveerimise üldpõhimõtted. 2 osa. Tehnilised põhimõtted. EN 1494:A1 Mobilne või liikuvtungraud ja nende seadmed. EN 2006/42/EÜ Direktiiv Lühemikele masinatele seadmetes sisalduvate liikuvtungraudide kohta (OJ L157/9. juuni 2006 a.) * Tehnilise dokumentatsiooni koostanud isik: Safenet Limited (Euroopa akrediteeritud institutsioon : 1674) Denford Garage, Denford, Kettering Northants, NN14 4EQ, Inglismaa</p>	<p>Lietuvos(Lithuanian)</p> <p>EB Atitikties deklaracija Paga EB Masinu direktyva 2006/42/EB</p> <p>Mes. SAMKIND CO., LTD. # 22, Hyejuik3-Gil, Buk-Gu, Ulsan, Korėja savo atsakomybe patvirtinama, kad produktas</p> <p>Produktas : Domkratas Produkto tipas : Pantografu tipo Galimi produkto tipai : 1000kg domkratas, 1200kg domkratas su kuriais susijęs ši deklaracija, atitinka ši (-šios) standartą (-tus) ir kita (-s) normą (-is) dokumentą (-is): EN ISO12100 Masinų sauga. Bendrieji projektavimo principai. Rizikos vertinimas ir jos mažinimas EN ISO12100-2:A1 Masinų sauga. Pagrindinės sąvokos, bendrieji projektavimo principai, 2 dalis. Techniniai principai. EN 1494:A1 Judantieji arba kabinuojamieji kėlikliai ir susijusių kėlimo įranga bei Direktyvos (-ų) nuostatos. 2006/42/EB Direktyva dėl Valstybių narių įstatymų, susijusių su mašinomis, suderinimo (OJ L157/2006 m. birželio 9 d.) * Techninė dokumentacija sudaręs asmuo: Safenet Limited (Europos akredituotoji institucija : 1674) Denford Garage, Denford, Kettering Northants, NN14 4EQ, Anglija</p>

<p>Latvijas (Latvian)</p> <p>EK atbilstības deklarācija saskaņā ar EK Direktīvu 2006/42/EK par mašīnām</p> <p>Mēs, SAMKIND CO., LTD., # 22, Hyojūn3-Gil, Buk-Gu, Ulsan, Koreja, uz savu atbildību deklarējam, ka produkts Produkts: saņemtais domkrāns Produkta veids: iekārta ar pantogrāfu Tīpo apzīmējums(š): saņemtais domkrāns – 1000 kg, saņemtais domkrāns – 1200 kg. uz kuru attiecas šī deklarācija, ir atbilstošs tālāk norādītajiem(-iem) standartiem(-iem) vai citiem(-iem) normatīvajiem(-iem) dokumentiem(-iem): EN ISO 12100 Masīnu drošība – Vispārīgās projektēšanas principi – Riska novērtēšana un riska samazināšana EN ISO 12100-2:AI Masīnu drošība – Pamata koncepcijas, (2010) vispārīgās projektēšanas principi, 2. daļa Tehniskie principi EN 1494:AI Mēbīli vai pārveidotāji domkrāni un ar tiem (2008) saistīti pacelšanas iekārtas ieievotajai direktīvai(-ām) noteikumiem: Direktīva par darbības normatīvo un administratīvo aktu 2006/42/EK mērķašāma attiecībā uz mašīnām (OV L157, 09.06.2006.)</p> <p>* Dokumenti par tehnisko stāvokli, apkopojumi: Safenet Limited (Eiropas pilnvarotā iestāde - 1674) Denford Garage, Denford, Kettering, Northants, NN14 4EQ, Anglija</p>	<p>Slovenščina(Slovenian)</p> <p>ES – Vyhlašení zhody Podľa smernice pre strojnú zariadenia 2006/42/ES</p> <p>Mý, SAMKIND CO., LTD., # 22, Hyojūn3-Gil, Buk-Gu, Ulsan, Kórea na svoju zodpovednosť potvrdím, že výrobok Výrobok : Zdvihák Typ výrobku : Typu pantograf Môžné typy výrobku: Zdvihák 1000kg, zdvihák 1200kg na ktorý sa vzťahuje toto vyhlásenie, je v zhode s týmito normami alebo s týmito normatívnymi dokumentmi: EN ISO 12100 Bezpečnosť strojových zariadení (2010) všeobecné zásady konštruovania strojov: Hodnotenie rizika a znižovanie rizika EN ISO 12100-2:AI Bezpečnosť strojových zariadení. Základné (2009) termíny, všeobecné zásady konštruovania strojov, 2. časť, Technické zásady. EN 1494:AI Mobilné a preumiestňovacie zdviháky a (2008) súvisiace zdviháckozariadenia.</p> <p>a s ustanoveniami smernice: 2006/42/ES Smernice o aproximácii právnych predpisov členských štátov týkajúcich sa strojových zariadení (EÚ L 157, 9.jún. 2006)</p> <p>* Osoba, ktorá spracovala technické dokumenty: Safenet Limited (európska notifikovaná osoba, 1674) Denford Garage, Denford, Kettering, Northants, NN14 4EQ, Anglicko</p>
<p>Български(Bulgarian)</p> <p>ЕО декларация за съответствие в съответствие с Директива 2006/42/ЕС за машините</p> <p>Ние, SAMKIND CO., LTD. # 22, Hyojūn3-Gil, Buk-Gu, Ulsan, Korea (Korea) декларираме на своя отговорност, че продуктът Продукт : Повдигателен кран Вид на продукта : Пантограф Обозначение (6) на вида : Повдигателен кран - 1000kg, повдигателен кран - 1200kg за който тази декларация се отнася, е в съответствие със следните стандарти или друг (-и) европейски (-и) документи(-и): EN ISO 12100 Безопасност на машините - Общи принципи за проектиране (2010) Оценка на риска и намаляване на риска EN ISO 12100-2:AI Безопасност на машините (Основни положения относно (2009) принципи за проектиране) проектиране. Част 2. Технически принципи. EN 1494:AI Мобилни и преносими кранове и скраповото с тях (2008) повдигащо оборудване в съответствие с Директива (-и). 2006/42/EO Директива на Съвета за обхващане на безопасността на декларацията(-и) относно отговора на машините (OJ L157, 9 юни 2006)</p> <p>* Съставил технически конструктор(-и): Safenet Limited (Европейски акредитиран орган: 1674) Denford Garage, Denford, Kettering Northants, NN14 4EQ, England (Anglia)</p>	<p>Română(Romanian)</p> <p>EC Declarație de Conformitate în funcție de EC Directiva Machinery 2006/42/EC</p> <p>Ne, SAMKIND CO., LTD., # 22, Hyojūn3-Gil, Buk-Gu, Ulsan, Coreea Declaram pe propria răspundere că produsul Produs: Jack, Asamblare Produs Tipul: pantograf Tip Tip Denunțat (e): Jack asamblare-1000 kg, Jack - asamblare 1200 kg Se referă această declarație este în conformitate cu standardul numărul (e) sau alt document normativ (s): EN ISO 12100 Securitatea mașinilor-Principii generale de proiectare- (2010) evaluare a riscurilor și de reducere a riscurilor EN ISO 12100-2:AI Securitatea mașinilor - Concepte de bază, principii (2009) generale de proiectare, Partea 2, Principii tehnice EN 1494:AI Mașini mobile sau mobile și echipament de ridicare (2008) asociat Unare Dispozițiile Directivei (s): 2006/42/EC Directiva privind apropierea legislațiilor statelor membre referitoare la mașini (OJ L157 Iunie, 9, 2006)</p> <p>* I.C.F compilarea Persoana: Safenet Limited (organismul notificat european: 1674) Denford Garage, Denford, Kettering, Northants, NN14 4EQ, England</p>

<p>Hrvatska (Croatian) EZ Izjava o sukladnosti prema Direktivi EZ o strojevima 2006/42/EZ</p> <p>Mi, SAMKI IND. CO. LTD. # 22, Hyojuk3-Gil, Buk-Gu, Ulsan, Koreja izjavljujemo pod vlastitom odgovornošću da je proizvod Proizvod : Montažna dizalica (Jack Assembly) Vrsta proizvoda : Vesta pantograf Tipisla(č oznaka) :Montažna dizalica (Jack Assembly) :1000kg. Montažna dizalica (Jack Assembly)-1200kg na koji se ova izjava odnosi u skladu sa sljedećim standardima) ili drugim normativnim dokumentima):</p> <p>EN ISO12100 Sigurnost strojeva – Opća načela za projektiranje – (2010) Procjena i smanjivanje rizika EN ISO12100-2:A1 Sigurnost strojeva – Osnovni pojmovi, opća načela za (2009) projektiranje – 2. dio : Tehnička načela EN 1494:A1 Mobilne ili pokretne dizalice i ponosna oprema za (2008) podizanje u skladu s odredbama Direktive(č): 2006/42/EZ Direktiva o uskladjivanju zakona država članica koji se odnose na velika teretna vozila (SL L157, 9. lipanj 2006.) * T.C.F. Kompilator:</p> <p>Safenet Limited (Evropsko nadležno tijelo : 1674) Denford Garage, Denford, Kettering, Northants, NN14 4EQ, England</p>	<p>Norsk(Norwegian) EOS samsvarsavklæring Iht. EOS Maskindirektivet 2006/42/EF</p> <p>Vi, SAMKI IND. CO. LTD. # 22, Hyojuk3-Gil, Buk-Gu, Ulsan, Korea etter vår ansvar erklærer at produktet Produktet : Løfteskruer (jack-skruer) Produkttype : Pantograf type Møtligte produkttyper: løfteskruer på 1000kg, løfteskruer på 1200kg som denne erklæringen gjelder for, er i samsvar med dette disse standard eller andre normative dokumenter: EN ISO12100 Maskinsikkerhet. Generelle prinsipper for (2010) design. Risikovurdering og den rensning. EN ISO12100-2:A1 Maskinsikkerhet. Grunnleggende begreper, (2009) generelle prinsipper for design. Del 2. tekniske prinsipper. EN 1494:A1 Bevegelige eller portåbne og tilhørende (2008) løftemøys. og bestemmelser i Direktivet: 2006/42/EF Direktiver om samordning av medlemsstatenes lov som gjelder for maskiner (OJ L157 av den 9. juni, 2006) * Personen som har forberedt den tekniske dokumentasjonen: Safenet Limited (det europeiske akkrediteringsorganet: 1674) Denford Garage, Denford, Kettering, Northants, NN14 4EQ, England</p>
<p>Türk (Turkish) 2006/42/AT AT Makina Yönetmeliğine göre AT Uygunluk Beyanı</p> <p>Biz, SAMKI IND. CO. LTD. # 22, Hyojuk3-Gil, Buk-Gu, Ulsan, Korea aşağıda tanımlanan olan ürün için sorumluluğum altına alıyorum beyan ederiz. Ürün : Krikö Takımı Ürün Tipi : Pantograf Tipi İpı nominalı (ar) : Krikö Takımı -1000kg, Krikö Takımı -1200kg Bu beyan ile işiği olan aşağıdaki standart(lar)ı veya diğer normatif doküman(lar)ı uygun olduğumu beyan ederiz. EN ISO12100 Makinalarda güvenlik - Tasarım için genel (2010) prensipler - Risk değerlendirmesi ve risk azaltılması EN ISO12100-2:A1 Makinalarda güvenlik - Temel kavramlar için (2009) genel prensipler. Bölüm 2 : Teknik prensipler EN 1494:A1 Teşahhüt ve/ya hareketli traktörler ve ilgili (2008) kaldırma ekipmanları aşağıdaki Yönetmeliğin hükümleri: 2006/42/AT Makinalar ile ilgili Üye Devletlerin yasalardan yaklaşımlarına ilişkin Yönergesi (OJ L157 9 Haziran, 2006) * T.C.F. Derleme KŞİ:</p> <p>Safenet Limited (Avrupa Onaylanmış Kuruluş : 1674) Denford Garage, Denford, Kettering, Northants, NN14 4EQ, İngiltere</p>	<p>İslenka(Icelandic) EB-samsæmisfrýsning sambæmt vélutöskipun 2006/42/EB</p> <p>Við, SAMKI IND. CO. LTD. # 22, Hyojuk3-Gil, Buk-Gu, Ulsan, Korea, lýsum því yfir á okkar ábyrgð állar að varam Vara : Tjakkbúnaður Vortegó : Skarrafjakkur Heiti gerðarfr : Tjakkbúnaður - 1000 kg, tjakkbúnaður - 1200 kg sem þessi yfirlýsing tengist er í samræm við eftirfarandi stöðu eða bunnar normskýli: EN ISO12100 Öryggi véla - Aðmennt grunurreglur um hönnun, (2010) áætlanir og áætlanir EN ISO12100-2:A1 Öryggi véla - Grunnreglur, almennar grunurreglur um (2009) hönnun, 2 hluti. Tæknireglur grunurreglur EN 1494:A1 Farþjakkur eða feramlegir tjakkur og tengdur (2008) lyftibúnaður eftirfarandi skvæði tjalldislausfrýsninga, 2006/42/EB Tjalldislaus um samræmingu laga aðildarríkjanna vortandi vélbúnað (Sýkið ESB L 157, 9. júní 2006) * T.C.F. samantektaraðili: Safenet Limited (tilkynnatur aðili í Evrópu: 1674) Denford Garage, Denford, Kettering, Northants, NN14 4EQ, England</p>

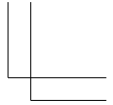
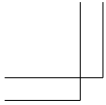

Handwriting practice lines consisting of a solid top line, a dashed midline, and a solid bottom line, repeated across the page.

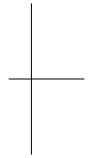
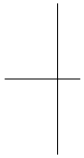

OGKE20E1

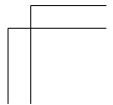
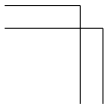

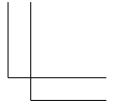
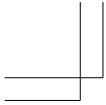

Handwriting practice lines consisting of a solid top line, a dashed midline, and a solid bottom line, repeated across the page.

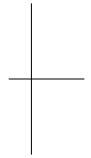
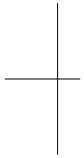

OGKE20E1

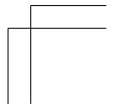
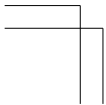

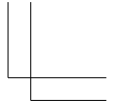
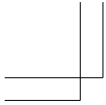

Handwriting practice lines consisting of a solid top line, a dashed midline, and a solid bottom line, repeated across the page.

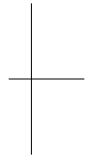
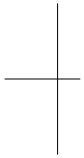

OGKE20E1

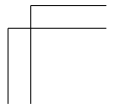
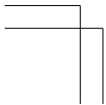

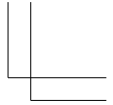
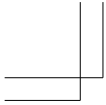

Handwriting practice lines consisting of a solid top line, a dashed midline, and a solid bottom line, repeated across the page.

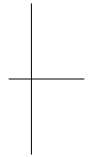
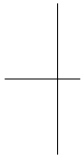

OGKE20E1

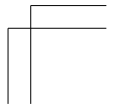
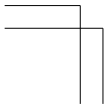

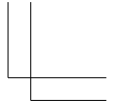
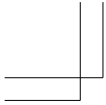

Handwriting practice lines consisting of a solid top line, a dashed midline, and a solid bottom line, repeated across the page.

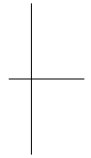
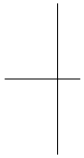

OGKE20E1

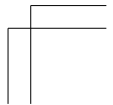
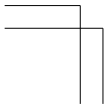

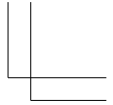
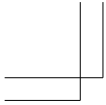

Handwriting practice lines consisting of a solid top line, a dashed midline, and a solid bottom line, repeated across the page.

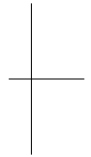
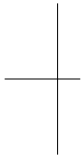

OGKE20E1

