



OWNER'S MANUAL

Leon



About this manual

This manual contains a description of the **equipment** supplied with the vehicle at the time this manual was published. Some of the units described herein will not be available until a later date or are only available in certain markets.

Because this is a general manual for the LEON range, some of the equipment and functions that are described in this manual are not included in all types or variants of the model; they may vary or be modified depending on the technical requirements and on the market; this is in no way deceptive advertising.

The **illustrations** are intended as a general guide and may vary from the equipment fitted in your vehicle in some details.

The **steering indications** (left, right, forward, reverse) appearing in this manual refer to the normal driving movements of the vehicle except when otherwise indicated.

The **audiovisual material** only is intended to help users to understand certain car functionalities better. It does not replace the instruction manual. Please use the instruction manual to obtain more comprehensive information and indications.

***** The **equipment marked with an asterisk*** is fitted as standard only in certain versions, and is only supplied as optional extras for some versions, or are only offered in certain countries.

® All **registered marks** are indicated with **®**. Although the copyright symbol does not appear, it is a copyrighted mark.

>> The section is continued on the following page.



Important warnings on a given page



Detailed contents on a given page



General information on a given page



Emergency information on a given page



WARNING

Texts preceded by this symbol contain information on safety. They warn you about possible dangers of accident or injury.



CAUTION

Texts with this symbol draw your attention to potential sources of damage to your vehicle.



For the sake of the environment

Texts preceded by this symbol contain relevant information concerning environmental protection.



Note

Texts preceded by this symbol contain additional information.

This manual is divided into six large parts, which are:

1. The essentials
2. Safety
3. Emergencies
4. Operation
5. Tips
6. Technical data

At the end of this manual, there is a detailed alphabetical index that will help you quickly find the information you require.

Foreword

This Instruction Manual and its corresponding supplements should be read carefully to familiarise yourself with your vehicle.

Besides the regular care and maintenance of the vehicle, its correct handling will help preserve its value.

For safety reasons, always note the information concerning accessories, modifications and part replacements.

If selling the vehicle, give all of the on-board documentation to the new owner, as it should be kept with the vehicle.

You can access the information in this manual using:

- Thematic table of contents that follows the manual's general chapter structure.
- Visual table of contents that uses graphics to indicate the pages containing "essential" information, which is detailed in the corresponding chapters.
- Alphabetical index with many terms and synonyms to help you find information.

WARNING

Read and always observe safety information concerning the passenger's front airbag »» page 91, Important information regarding the front passenger's airbag.

Thank you for trusting in us.

We wish you safe and enjoyable motoring.

SEAT, S.A.

Related videos



Safety: traffic jam assist, adaptive cruise control with city safety assist, front and rear parking sensors and rear view camera.

www.seat.com/youtube-af/leon/tech-safety

»» page 214
»» page 227
»» page 237
»» page 243



Technology: Kessy keyless access and starting system, with My Beat function, navigation system, wireless charger and Full Link technology.

www.seat.com/youtube-af/leon/tech-tech

»» page 123
»» page 129
»» page 183
»» Booklet Navigation system

Frequently Asked Questions

Before driving

How do you adjust the seat? » page 19

How do you adjust the steering wheel? » page 21

How do you adjust the exterior mirrors? » page 21

How do you turn on the exterior lights? » page 30

How does the automatic gearbox selector lever work? » page 50

How do you refuel? » page 58

How do you activate the windscreen wipers and windscreen washer system? » page 32

Emergency situations

A warning lamp lights up or flashes. What does this mean? » page 47

How do you open the bonnet? » page 17

How do you perform a jump start? » page 70

Where is the vehicle tool kit located? » page 66

How do you repair a tyre with the anti-puncture kit? » page 65

How do you change a wheel? » page 66

How do you change a fuse? » page 63

How do you change a light? » page 64

How do you tow a vehicle? » page 69

Useful tips

How do you set the time? » page 115

When should the vehicle inspection should be performed? » page 44

What functions do the buttons/thumbwheels on the steering wheel perform? » page 121

How do you remove the luggage compartment cover? » page 169

How do you drive in an economical and environmentally-friendly way? » page 200

How do you check and top up the engine oil? » page 59

How do you check and top up the engine coolant? » page 60

How do you top up the windscreen washer fluid? » page 61

How do you check and top up the brake fluid? » page 61

How do you check and adjust tyre pressure values? » page 280

Vehicle washing tips » page 257

Functions of interest

Easy Connect, CAR menu » page 33

How does the START-STOP system work? » page 205

What parking assistants are available? » page 237

How does the rear assist work? » page 243

How does the adaptive cruise control work? » page 214

How can the SEAT driving mode be adjusted? » page 230

How does the lane departure warning system work? » page 224

How does tyre pressure monitoring work? » page 284

How do you open the vehicle without a key (Keyless Access)? » page 129

Interior lighting and ambient light » page 147

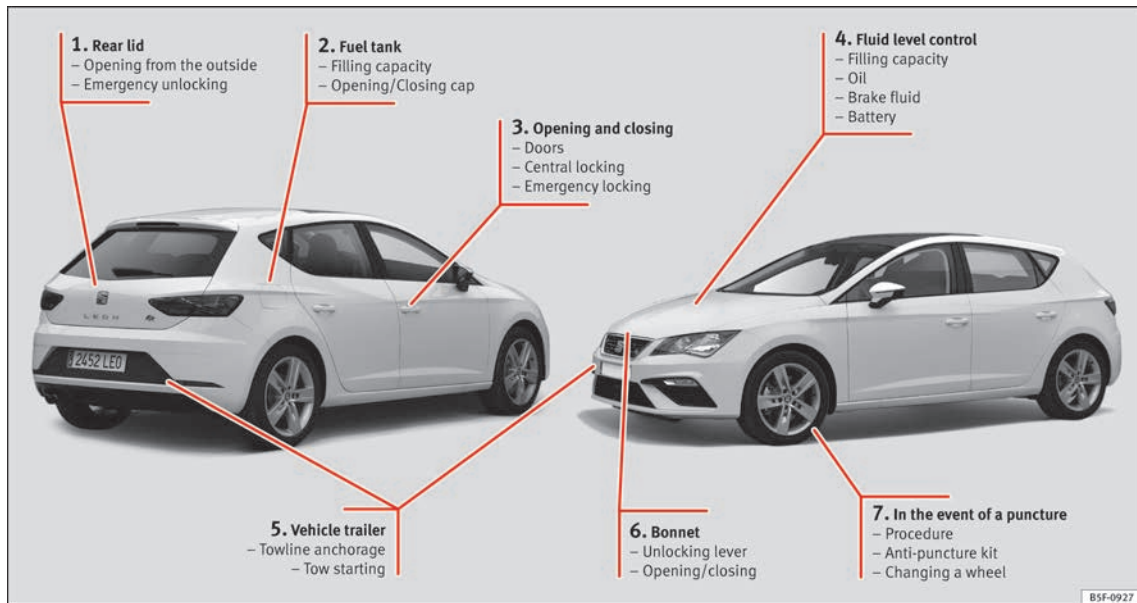
Table of Contents

The essentials	7	How to jump start	70	Operation	113
Exterior view	7	Changing the wiper blades	72	Controls and displays	113
Exterior view	8	Safety	74	General instrument panel	112
Driver-side general instrument panel (left-hand drive)	9	Safe driving	74	Instruments and warning/control lamps	114
Driver-side general instrument panel (right-hand drive)	10	Safety first!	74	Instruments	114
Centre console	11	Advice about driving	74	Control lamps	119
Passenger-side general instrument panel (left-hand drive)	12	Correct position of the vehicle occupants	75	Introduction to the Easy Connect system*	120
Passenger-side general instrument panel (right-hand drive)	13	Pedal area	79	System settings (CAR)*	120
Interior view	14	Seat belts	80	Communications and multimedia	121
How it works	15	Why wear a seat belt	80	Steering wheel controls*	121
Unlocking and locking	15	How to properly adjust your seatbelt	83	Multimedia	123
Before driving	19	Seat belt tensioners	84	Opening and closing	125
Airbags	22	Airbag system	85	Central locking system	125
Child seats	25	Brief introduction	85	Anti-theft alarm system*	133
Starting the vehicle	30	Safety instructions about airbags	87	Rear lid (luggage compartment)	135
Lights and visibility	30	Deactivating airbags	89	Controls for the windows	136
Easy Connect	33	Transporting children safely	91	Panoramic sliding sunroof*	138
Driver information System	36	Safety for children	91	Lights and visibility	140
Status display	41	Child seats	92	Lights	140
Cruise control	45	Event Data Recorder	94	Visibility	148
Warning lamps	47	Description and operation	94	Windscreen wiper and window wiper systems	148
Gearbox lever	50	Emergencies	95	Mirror	150
Air conditioning	52	Self-help	95	Seats and head restraints	152
Fluid Level control	58	Vehicle tool kit, anti-puncture kit*	95	Adjusting the seats and headrests	152
Emergencies	63	Tyre repair	95	Seat functions	154
Fuses	63	Manual unlocking/locking	97	Transport and practical equipment	157
Bulbs	64	Changing the windscreen wiper blades	97	Storage compartments	157
Action in the event of a puncture	64	Towing or tow-starting	98	Storing objects	160
Changing a wheel	66	Fuses and bulbs	101	Roof carrier	170
Snow chains	69	Fuses	101	Air conditioning	173
Emergency towing of the vehicle	69	Changing bulbs	103	Heating, ventilation and cooling	173
		Change the front bulbs	105	Driving	178
		Changing incandescent rear light bulbs	107	Starting and stopping the engine	178
		Side turn signals	110	Braking and parking	183
				Braking and stability systems	187
				Manual gearbox	190

Table of Contents

Automatic gearbox/DSG automatic gear- box*	191	Engine oil	272
Address	198	Cooling system	274
Run-in and economical driving	199	Brake fluid	275
Power management	201	Windscreen washer reservoir	276
Engine management and emission control sys- tem	202	Battery	277
Driving tips	204	Wheels	279
Driver assistance systems	205	Wheels and tyres	279
Start-Stop System*	205	Tyre monitoring systems	283
Auto Hold Function*	208	Temporary spare wheel	286
Cruise control system (CCS)*	209	Winter service	287
Emergency brake assist system (Front As- sist)*	210	Technical data	289
Adaptive Cruise Control ACC*	214	Technical specifications	289
Lane Assist system*	224	Important	289
Traffic Jam Assist	227	Vehicle identification data	289
Emergency Assist	228	Fuel consumption data	290
SEAT Drive Profile*	230	Trailer mode	290
Traffic sign detection system*	233	Wheels	291
Fatigue detection (break recommendation)* ..	236	Engine data	292
Parking aid	237	Dimensions	313
Rear Assist "Rear View Camera"*	243	Index	315
Towing bracket device	246		
Towing bracket device*	246		
Trailer towing	251		
Advice	256		
Care and maintenance	256		
Accessories and modifications to the vehi- cle	256		
Care and cleaning	257		
Vehicle exterior care	257		
Caring for the vehicle interior	261		
Checking and refilling levels	264		
Filling the tank	264		
Fuel	266		
Engine compartment	270		

Exterior view

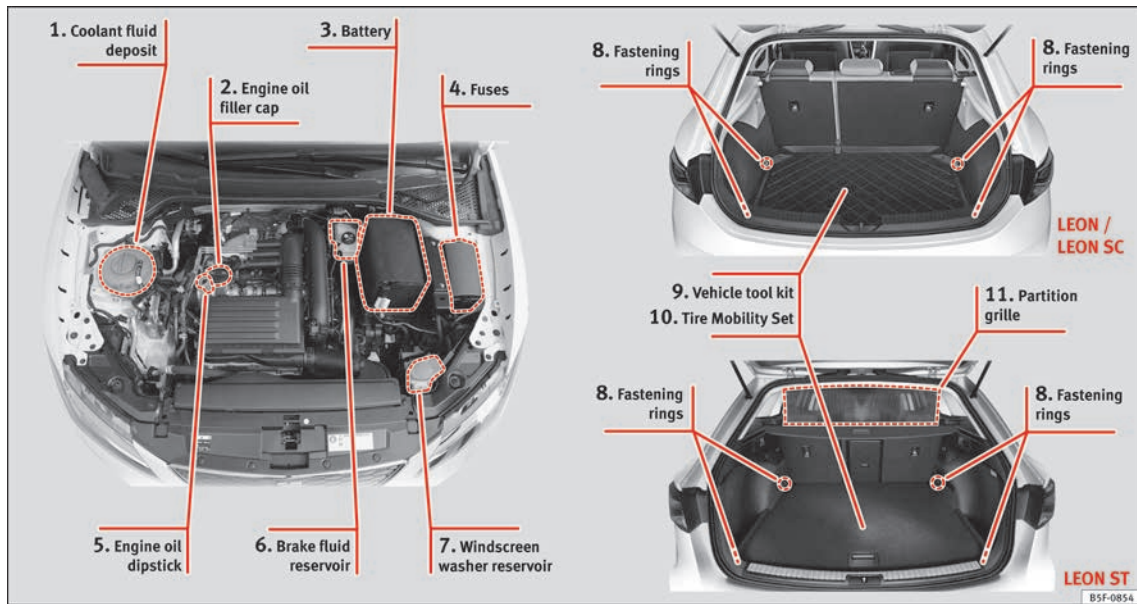


BSF-0927

- ① » page 16
- ② » page 58
- ③ » page 15
- ④ » page 58

- ⑤ » page 69
- ⑥ » page 17
- ⑦ » page 64

Exterior view



① » page 60

② » page 59

③ » page 61

④ » page 63

⑤ » page 59

⑥ » page 61

⑦ » page 61

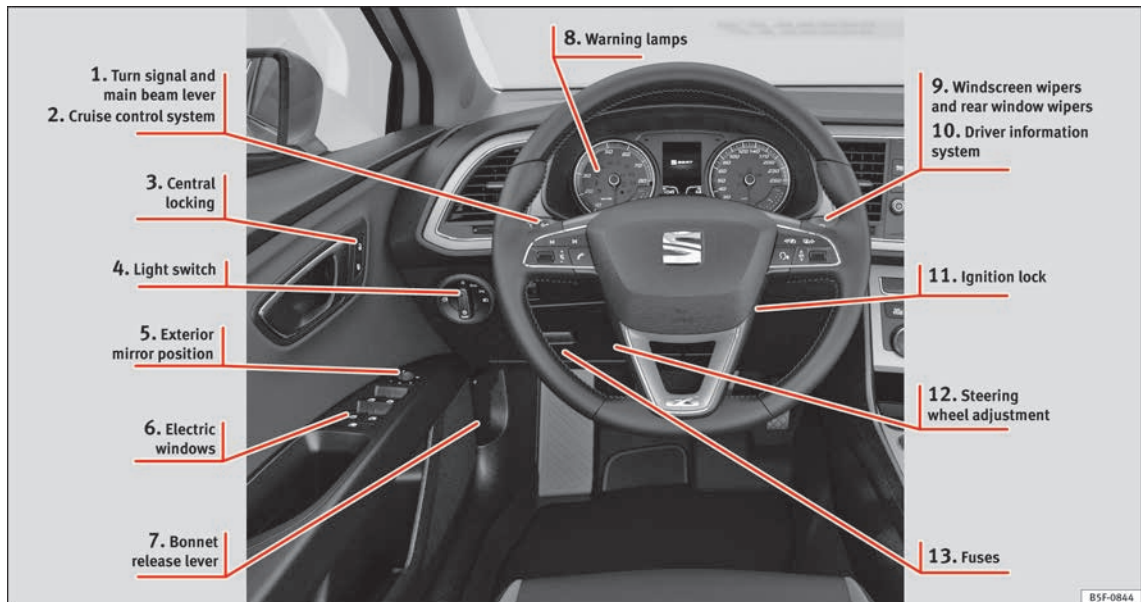
⑧ » page 167

⑨ » page 66

⑩ » page 65

⑪ » page 164

Driver-side general instrument panel (left-hand drive)



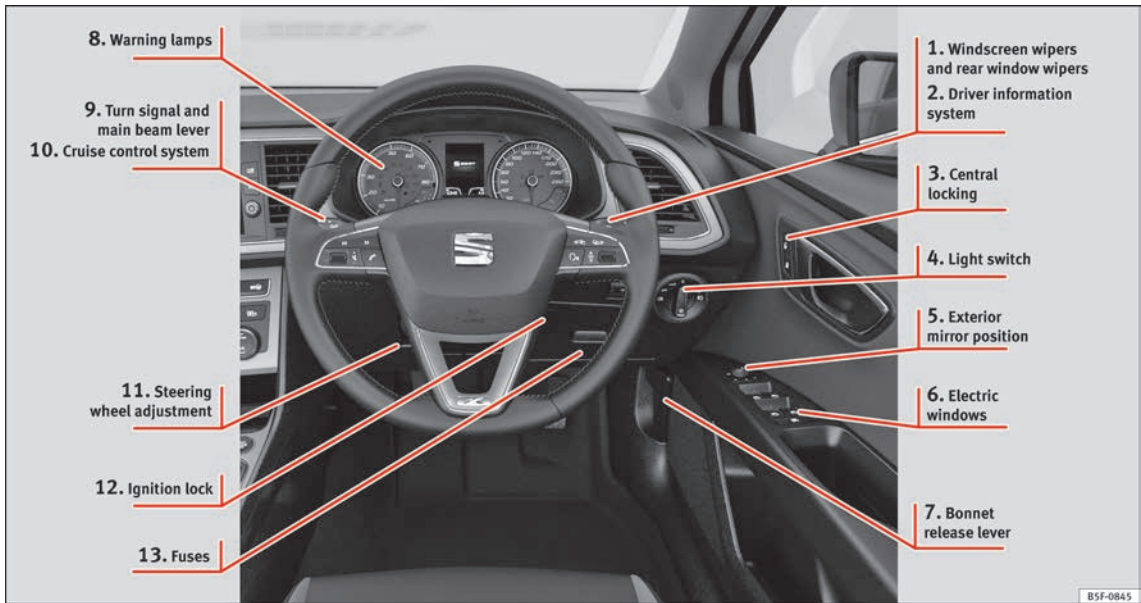
- ① »»» page 31
- ② »»» page 45
- ③ »»» page 15
- ④ »»» page 30

- ⑤ »»» page 21
- ⑥ »»» page 18
- ⑦ »»» page 17

- ⑧ »»» page 47
- ⑨ »»» page 32
- ⑩ »»» page 36

- ⑪ »»» page 30
- ⑫ »»» page 21
- ⑬ »»» page 63

Driver-side general instrument panel (right-hand drive)



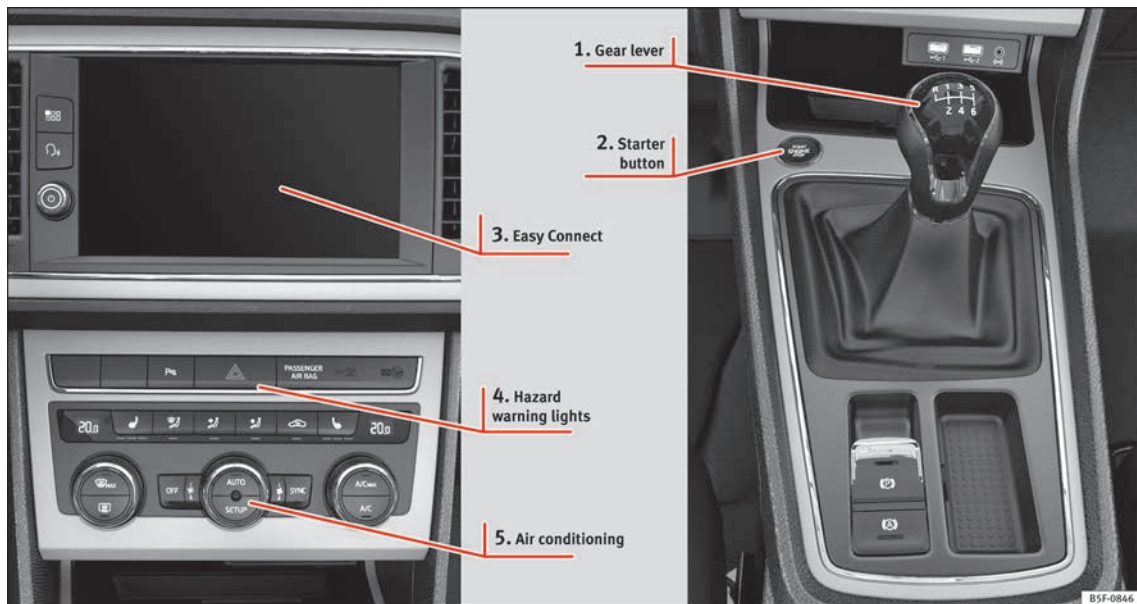
- ① »»» page 32
- ② »»» page 36
- ③ »»» page 15
- ④ »»» page 30

- ⑤ »»» page 21
- ⑥ »»» page 18
- ⑦ »»» page 17

- ⑧ »»» page 47
- ⑨ »»» page 31
- ⑩ »»» page 45

- ⑪ »»» page 21
- ⑫ »»» page 30
- ⑬ »»» page 63

Centre console



① » page 50

② »  page 180

③ » page 33


④ » page 31

⑤ » page 52, » page 54

The layout in right-hand drive vehicles is symmetrical.

Passenger-side general instrument panel (left-hand drive)



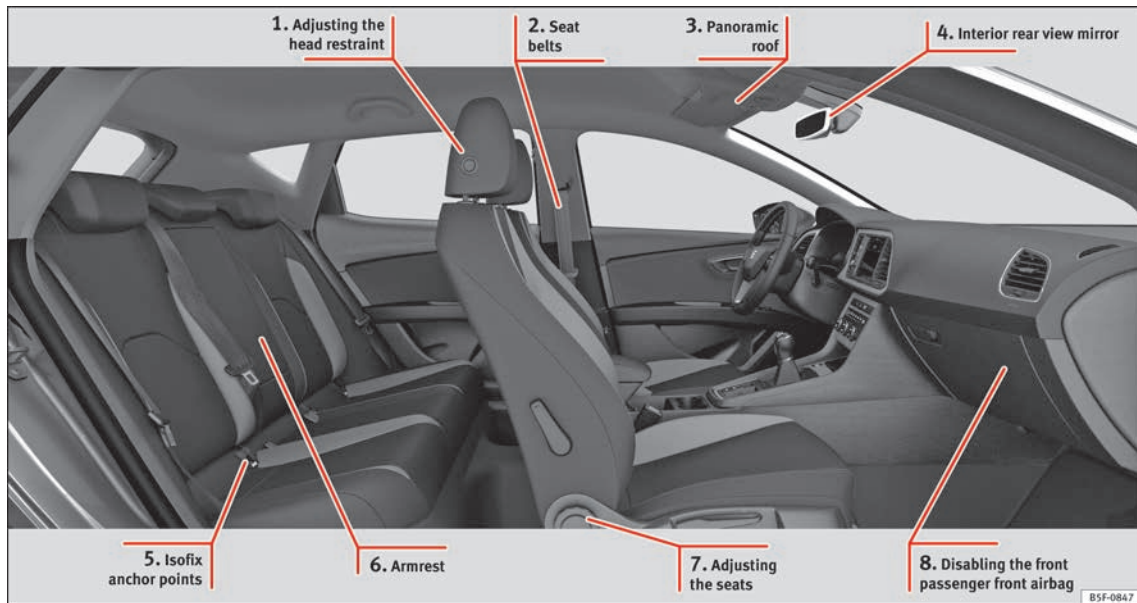
- ① »» page 22
- ② »» page 18
- ③ »»  page 158

Passenger-side general instrument panel (right-hand drive)



- ① »» page 22
- ② »» page 18
- ③ »» 📖 page 158

Interior view



① » page 20

② » page 20

③ » page 18

④ »  page 150

⑤ » page 27

⑥ »  page 166

⑦ » page 19

⑧ » page 23

How it works

Unlocking and locking

Doors







Fig. 1 Remote control key: buttons.





Fig. 2 Driver door: central locking switch.

Locking and unlocking the vehicle using the key

- Locking: press the  » Fig. 1 button.
- Locking the vehicle without activating the anti-theft system: Press the  » Fig. 1 button for a second time within 2 seconds.
- Unlocking: press the  » Fig. 1 button.
- Unlocking the rear lid: Hold down the  » Fig. 1 button for at least 1 second.

Locking and unlocking with the central locking switch

- Locking: press the  » Fig. 2 button. None of the doors can be opened from the outside. The doors can be opened from the inside by pulling the inside door handle.
- Unlocking: press the  » Fig. 2 button.



»  in Description on page 125



» page 125

SOS


» page 15, » page 16


Unlocking or locking of driver door




Fig. 3 Driver door lever: hidden lock cylinder.

If the central locking system should fail to operate, the driver door can still be locked and unlocked by turning the key in the lock.


As a general rule, when the driver door is locked manually all other doors are locked. When it is unlocked manually, only the driver door opens. Please observe the instructions relating to the anti-theft alarm system »  page 125.

- Unfold the vehicle key blade »  page 126.
- Insert the key shaft into the lower opening in the cover on the driver door handle » Fig. 3 (arrow) then remove the cover upwards.
- Insert the key blade into the lock cylinder to unlock or lock the vehicle. »

Special Characteristics

- The anti-theft alarm will remain active when vehicles are unlocked. However, the alarm will not be triggered »»»  page 125.
- After the driver door is opened, you have 15 seconds to switch on the ignition. Once this time has elapsed, the alarm is triggered.
- Switch the ignition on. The electronic immobilizer recognises a valid vehicle key and deactivates the anti-theft alarm system.

Note

The anti-theft alarm is not activated when the vehicle is locked manually using the key shaft »»»  page 125.

Emergency locking of doors without door cylinder

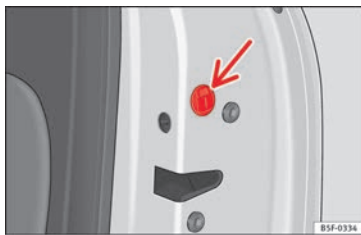


Fig. 4 Locking the door manually.

If the central locking system should fail to work at any time, doors with no lock cylinder will have to be locked separately.

A mechanical locking device (only visible when the door is open) is provided on the front passenger door.

- Pull the cap out of the opening.
- Insert the key in the inside slot and turn it to the right as far as it will go (if the door is on the right side) or to the left (if the door is on the left side).



Once the door has been closed it can no longer be opened from the outside. Pull the interior door handle once to unlock and open the door.

Rear lid



Fig. 5 Rear lid: opening from the outside.

The rear lid opening system operates electrically. It is activated by using the handle on the boot lid.


To lock/unlock, press the button  or button  »»» Fig. 1 on the remote control key.

A warning appears on the instrument panel display if the rear lid is open or not properly closed.* An audible warning is also given if it is opened while the vehicle is moving faster than 6 km/h (4 mph)*.

Opening and closing

- Opening the rear lid: pull on the release lever and lift it up »»» Fig. 5. The rear lid opens automatically.
- Closing the rear lid: Hold it by one of the handles on the interior lining and close it by pushing gently.



»»  in Rear lid automatic locking on page 135



»» page 135

SOS

»» page 17, »» page 17

Manual release mechanism for the rear lid

✓ Applies to the model: LEON/LEON SC

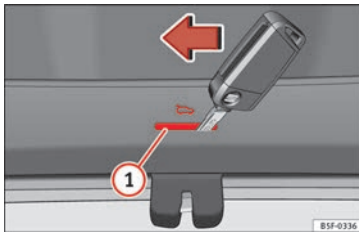


Fig. 6 Luggage compartment: access to manual release.

The rear lid can be unlocked manually from inside in the event of an emergency.

- Insert the key in the opening in the lining of the tail gate ① and move the key in the direction of the arrow until the lock is released.

Manual release mechanism for the rear lid

✓ Applies to the model: LEON ST

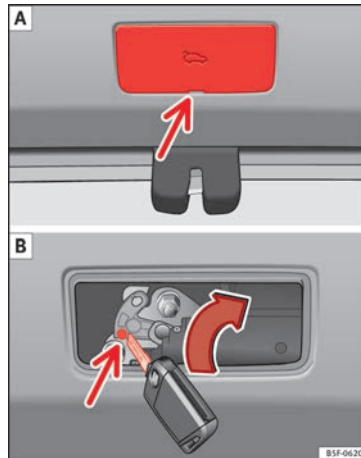


Fig. 7 Luggage compartment: access to manual release.

The rear lid can be unlocked manually from inside in the event of an emergency.

- Remove the cover by inserting a screwdriver in groove »» Fig. 7 A.

- Insert the key into the opening and turn it in the direction of the arrow until the latch »» Fig. 7 B has been released.

Bonnet

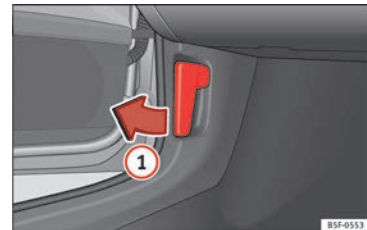


Fig. 8 Release lever in the driver's footwell area.

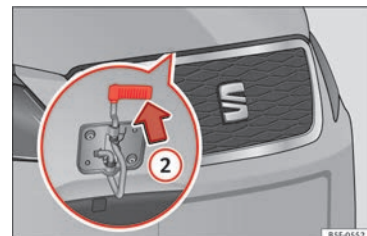


Fig. 9 Cam under the bonnet



- Opening the bonnet: Pull the lever under the dashboard »» Fig. 8 ①.
- Lift up the bonnet. Press the release catch under the bonnet upwards »» Fig. 9 ②. The arrester hook under the bonnet is released.
- The bonnet can be opened. Release the bonnet stay and secure it in the fixture designed for this in the bonnet.



»» ⚠ in Working in the engine compartment on page 270



»» page 270

Controls for the windows*

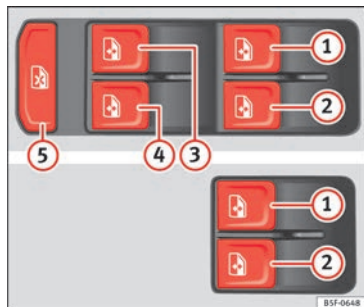




Fig. 10 Detail of the driver door: controls for the windows.

- Opening the window: Press the  button.
- Closing the window: Pull the  button.

Buttons on the driver door

- ① Window on the front left door
- ② Window on the front right door
- ③ Window on the rear left door (only 5-door vehicles)
- ④ Window on the right rear door (only 5-door vehicles)
- ⑤ Safety switch for deactivating the electric window buttons on the rear doors (only 5-door vehicles)



»» ⚠ in Opening and closing of the electric windows* on page 136



»» page 136

Panoramic roof*

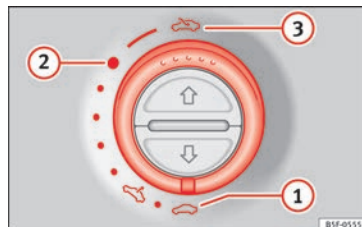


Fig. 11 On the interior roof lining: use the rotary button for opening and closing

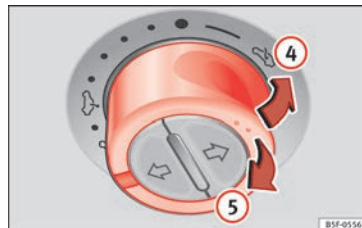


Fig. 12 On the interior roof lining: press the button and pull on it to raise and lower the sunroof.

- Opening: Turn the switch to position »» Fig. 11 ③.
- Convenience position: Turn the switch to position »» Fig. 11 ②.

• Closing: Turn the switch to position

»» Fig. 11 ①.

• To tilt open: Push the switch to position
»» Fig. 12 ④. For an intermediate position, hold down the switch until you reach the desired position.

• Lowering: Pull the switch to position
»» Fig. 12 ⑤. For an intermediate position, hold down the switch until you reach the desired position.



»» ⚠ in Opening or closing the panoramic sliding sunroof on page 138



»» page 138

Before driving

Manually adjusting the front seats



Fig. 13 Front seats: manual seat adjustment.

- ① Forward/back: pull the lever and move the seat forwards or backwards.
- ② Raising/lowering: pull/push the lever.
- ③ Tilting the backrest: turn the hand wheel.
- ④ Lumbar support: Press the button in the corresponding position.
- ⑤ Folding down the backrest (only 3-door vehicles): pull the lever and push the backrest forward.



»» ⚠ in Manual adjustment of the seats on page 152

Electric adjustment of the driver's seat*

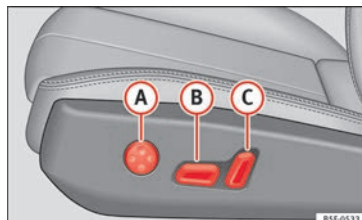


Fig. 14 Driver's seat: electric seat adjustment.

- Ⓐ Adjusting the lumbar support: press the button according to the desired position.
- Ⓑ Seat up/down: Press the button up/down. To adjust the front of the seat cushion, press the front of the button up/down. To adjust the rear of the seat cushion, press the rear of the button up/down.
Seat forwards/backwards: press the button forwards/backwards.
- Ⓒ Backrest further upright/further reclined: press the button forwards/backwards. »



» » ⚠ in Electric driver's seat adjustment* on page 153

Adjusting the head restraints

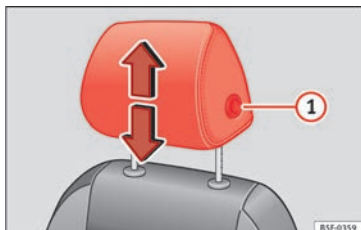


Fig. 15 Front seat: adjustment of the head restraint.

- Grab the sides of the head restraints with both hands and push upwards to the desired position. To lower it, repeat the same action, pressing the ① button on the side.



» » ⚠ in Correct adjustment of front head restraints on page 78



» » page 78, » » page 153

Adjustment of the seat belt

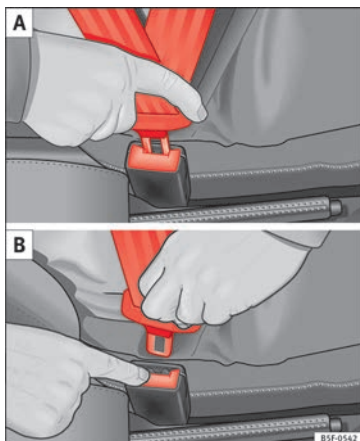


Fig. 16 Positioning and removing the seat belt buckle.

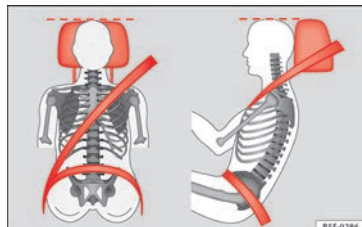


Fig. 17 Correct seat belt and head restraint positions, viewed from front and the side.

To adjust the seat belt around your shoulders, adjust the height of the seats.

The shoulder part of the seat belt should be well centred over it, never over the neck. The seat belt lies flat and fits comfortably on the upper part of the body.

The lap part of the seat belt lies across the pelvis, never across the stomach. The seat belt lies flat and fits comfortably on the pelvis.



» » page 81



» » page 83

Seat belt tensioners

During a collision, the seat belts on the front seats are retracted automatically.

The tensioner can be triggered only once.



» ⚠ in Maintenance and disposal of belt tensioners on page 85



» page 84

Adjusting the exterior mirrors

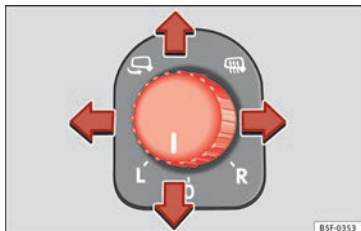


Fig. 18 Detail of the driver door: control for the exterior mirror.

Adjusting the exterior mirrors: Turn the knob to the corresponding position:

L/R Turning the knob to the desired position, adjust the mirrors on the driver

side (L, left) and the passenger side (R, right) to the direction desired.



Depending on the equipment fitted on the vehicle, the mirrors may be heated according to the outside temperature.



Folding in mirrors.



» ⚠ in Adjusting the exterior rear-view mirrors on page 152



» page 151



» ⚠ in Adjusting the steering wheel position on page 76

Adjusting the steering wheel

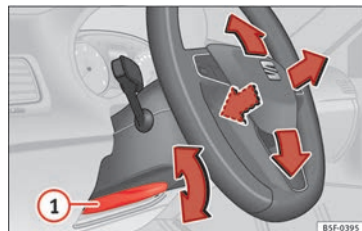


Fig. 19 Lever in the lower left side of the steering column.

- Adjusting the position of the steering wheel: Pull the » **Fig. 19** ① lever down, move the steering wheel to the desired position and lift the lever back up until it locks.

Airbags

Front airbags



Fig. 20 Driver airbag located in steering wheel.

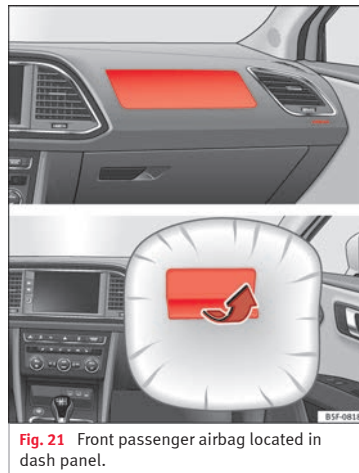


Fig. 21 Front passenger airbag located in dash panel.

The front airbag for the driver is located in the steering wheel » **Fig. 20** and the airbag for the front passenger is located in the dash panel » **Fig. 21**. Airbags are identified by the word "AIRBAG".

When the driver and front passenger airbags are deployed, the covers remain attached to the steering wheel and dashboard, respectively » **Fig. 20** » **Fig. 21**.

In conjunction with the seat belts, the front airbag system gives the front occupants additional protection for the head and chest in

the event of a severe frontal collision » **△** in **Front airbags** on page 87.

Their special design allows the controlled escape of the propellant gas when an occupant puts pressure on the bag. Thus, the head and chest are protected by the airbag. After the collision, the airbag deflates sufficiently to allow visibility.



» page 87

Deactivating the front passenger front airbag



Fig. 22 Front passenger front airbag switch.



Fig. 23 Dash panel: control lamp for deactivated front passenger airbag in centre console.

To deactivate the front passenger front airbag:

- Switch the ignition off.
- Open the glove compartment on the front passenger side.

- Insert the key into the slot of the switch for deactivating the front passenger airbag »» Fig. 22. About 3/4 of the key should enter; this is as far as it will go.

- Turn the key gently to the **OFF** position. If you have difficulty, ensure that you have inserted the key as far as it will go.

- Check, with the ignition switched on, that the **OFF** ⚠️ control lamp remains lit where it says **PASSENGER AIR BAG OFF** ⚠️ in the centre of the dash panel »» Fig. 23.



»» ⚠️ in Activation and deactivation of front passenger airbag* on page 89



»» page 89

Knee airbag*

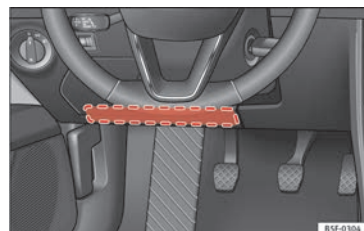


Fig. 24 On the driver side: location of the knee airbag

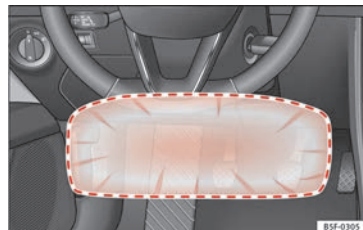


Fig. 25 On the driver side: radius of action of the knee airbag.

The knee airbag is located on the driver side below the dash panel »» Fig. 24. Airbags are identified by the word “AIRBAG”.

The area framed in red (deployment area) »» Fig. 25 is covered by the knee airbag when it is deployed. Objects should never be placed or mounted in this area.



»» page 87

Side airbags*

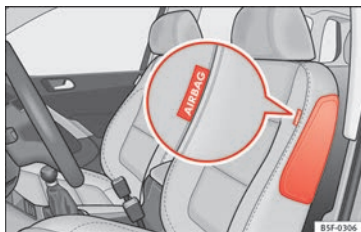


Fig. 26 Side airbag in driver's seat.

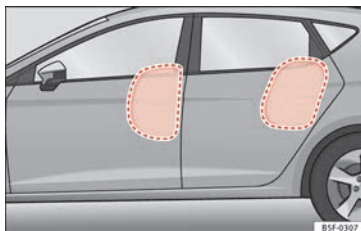



Fig. 27 Illustration of completely inflated side airbags on the left side of the vehicle.

The side airbags are located in the backrest cushions of the driver seat » Fig. 26 and the front passenger seat as well as in the backrest of the side rear seats*. The locations are identified by the text "AIRBAG" in the upper region of the backrests.

In conjunction with the seat belts, the side airbag system provides additional protection for the upper body in the event of a severe side collision »  in Side airbags* on page 87.

In a side collision, the side airbags reduce the risk of injury to passengers to the areas of the body facing the impact. In addition to their normal function of protecting the occupants in a collision, the front and rear outer seat belts also hold the passengers in the event of a side collision; this is how these airbags provide maximum protection.




» page 87

Head-protection airbags*



Fig. 28 Location of head-protection airbags.

The head-protection airbags are located on both sides in the interior above the doors » Fig. 28 and are identified with the text "AIRBAG".

In conjunction with the seat belts, the head-protection airbag system gives the vehicle occupants additional protection for the head and upper body in the event of a severe side collision »  in Head-protection airbags* on page 88.



»  in Head-protection airbags* on page 88

Child seats

Important information regarding the front passenger's airbag

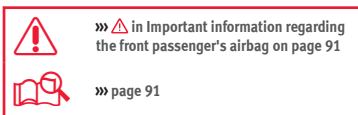


Fig. 29 Airbag stickers - version 1: on the passenger-side sun blind **A** and on the rear frame of the front passenger's door **B**.



Fig. 30 Airbag stickers - version 2: on the passenger-side sun blind **A** and on the rear frame of the front passenger's door **B**.

A sticker with important information about the passenger airbag is located on the passenger's sun visor and/or on the passenger side door frame.



Securing child seats with the seat belt

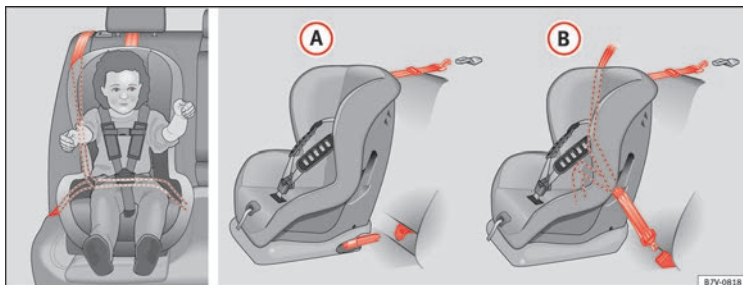


Fig. 31 On the rear seats: Possible installations for the child seat.

Figure » **Fig. 31 A** shows the basic child restraint system mounting using lower retaining rings and the upper retaining strap. Figure » **Fig. 31 B** shows the child restraint system mounting using the vehicle seat belt.

The seat belt may be used to secure **universal** type child seats to the vehicle seats marked with a **U** in the table below.

If the front passenger seat lacks a height adjustment, child seats cannot be mounted in this location¹⁾.

To correctly use a child seat in the back, the front backrest must be adjusted so that there

is no contact with the child seat in the back in the case that it goes opposite to the direction of the car. In the case of front facing restraint systems, the front backrest must be adjusted so that there is no contact with the child's feet.

To adjust the passenger seat to accommodate a child's seat and get the seat belt in a perfect position, adjust the passenger backrest as far forward as possible¹⁾.

Starting with **Group 0+** child seats should not be mounted facing backwards in the passenger seat given that due to the size of some of them, they can be difficult to install.¹⁾

The systems include the child restraint system mounting with an upper retaining strap (Top Tether) and lower anchoring points on the seat.

¹⁾ Compliance with current national legislation and the manufacturer's instructions is required when using or installing child seats.

Weight group	Seating position		
	Front passenger seat ^{a)}	Rear side seat	Rear central seat
Group 0 to 10 kg	U ^{b)}	U	U
Group 0+ to 13 kg	U ^{b)}	U	U
Group I 9 to 18 kg	U ^{b)}	U	U
Group II 15 to 25 kg	U ^{b)}	U	U
Group III 22 to 36 kg	U ^{b)}	U	U

U: Suitable for universal restraint systems for use in this weight group.

^{a)} Compliance with current national legislation and the manufacturer's instructions is required when using or installing child seats.

^{b)} Only compatible for models with adjustable seat height. Place the seat in the backmost and highest position possible.



» » ⚠ in Safety instructions on page 92

Securing child seats with "ISOFIX" and Top Tether*

Child seats can be secured quickly, easily and safely on the rear outer seats with the "ISOFIX" and Top Tether* system.

Two "ISOFIX" retaining rings are fitted on each rear seat. In some vehicles, the rings

are secured to the seat frame and, in others, they are secured to the rear floor. The "ISOFIX" rings are located between the rear seat backrest and the seat cushioning. The Top Tether* rings are located at the rear of the

backrests of the rear seats (behind the seat backrest or in the boot).

To understand the compatibility of the "ISOFIX" systems in the vehicle, consult the table below.



The essentials

The body weight permitted and information regarding sizes **A** to **F** is indicated on the la-

bel on child seats with “**universal**” or “**semi-universal**” certification.

Weight group	Size class	Electrical equipment	Mounting direction	Vehicle Isofix positions
				Rear side seats
Baby carrier	F	ISO/L1	Backward-facing	X
	G	ISO/L2	Backward-facing	X
Group 0 to 10 kg	E	ISO/R1	Backward-facing	IU
Group 0+ to 13 kg	E	ISO/R1	Backward-facing	IU
	D	ISO/R2	Backward-facing	IU
	C	ISO/R3	Backward-facing	IU
Group I 9 to 18 kg	D	ISO/R2	Backward-facing	IU
	C	ISO/R3	Backward-facing	IU
	B	ISO/F2	Forward-facing	IU
	B1	ISO/F2X	Forward-facing	IU
	A	ISO/F3	Forward-facing	IU
Group II 15 to 25 kg	---	---	Forward-facing	---
Group III 22 to 36 kg	---	---	Forward-facing	---

IU: Suitable for ISOFIX universal child restraint systems approved for use in this weight group.

X: ISOFIX position not suitable for ISOFIX child restraint systems for this weight group or size class.



» » in Safety instructions on page 92

Attaching the child seat with the “ISOFIX system”



Fig. 32 ISOFIX securing rings.

You are obliged to follow the seat manufacturer’s instructions.

- Remove the protective caps of the “ISOFIX” rings by placing a finger in the hole and pulling up »» Fig. 32.
- Press the child seat onto the “ISOFIX” retaining rings until the child seat can be heard to engage securely. If the child seat is equipped with Top Tether* anchor points, secure it to the correspondent ring »» Fig. 33. Observe the manufacturer’s instructions.
- Pull on both sides of the child seat to ensure that it is properly anchored.

Child seats with the “ISOFIX” and Top Tether* attachment system are available from Technical Services.

Securing child seats with the Top Tether* retaining straps



Fig. 33 Position of the Top Tether rings on the back of the rear seat.

Child seats with the Top Tether system come with a strap for securing the seat to the vehicle anchor point, located at the back of the rear seat backrest and provide greater restraint.

The objective of this strap is to reduce forward movements of the child seat in a crash, to reduce the risk of injuries to the head from hitting the inside of the vehicle.

Using the Top Tether in rear-facing mounted seats

Currently, there are very few rear-facing child safety seats that have Top Tether. Please carefully read and follow the seat manufacturer instructions to learn the proper way to install the Top Tether strap.

Securing the Top Tether* to the anchorage point

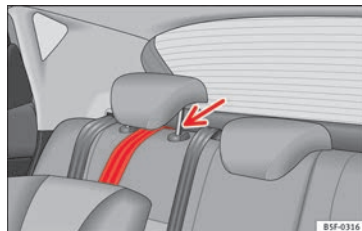


Fig. 34 Retainer strap: correct adjustment and fitting.

Securing the retainer strap

- Follow the manufacturer’s instructions to deploy the child seat Top Tether retainer strap.
- Guide the strap under the rear seat head restraint »» Fig. 34 (lift the head restraint where necessary).
- Slide the strap and secure it properly with the anchorage of the backrest »» Fig. 33.
- Firmly tighten the strap following the manufacturer’s instructions.

Releasing the retaining strap

- Loosen the strap following the manufacturer’s instructions. »»

- Push the lock and release it from the anchoring support.



» » in Safety instructions on page 92

Starting the vehicle

Ignition lock

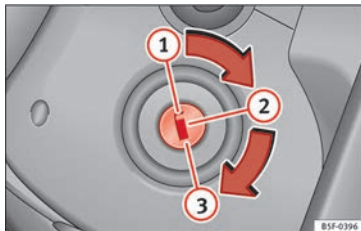


Fig. 35 Ignition key positions.

Switch ignition on: Place the key in the ignition and start the engine.

Locking and unlocking the steering wheel

- Engaging the steering wheel lock: Remove the key from the ignition and turn the wheel until it locks. Depending on the country, in vehicles with an automatic gearbox and without the electronic brake, to remove the key the gear lever must be in the **P** position. If

necessary, press the locking key on the selector lever and release it again.

- Unlocking the steering wheel: Put the key into the ignition and turn it at the same time as the steering wheel in the direction indicated by the arrow. If it is not possible to turn the steering wheel, it may be because it is locked.

Turning on/switching off the ignition, glow plugs reheating

- Switch ignition on: Turn the key to the ② position.
- Switch ignition off. Turn the key to the ① position.
- Diesel vehicles ☞: The glow plugs reheat when the ignition is switched on.

Starting the engine

- Manual gearbox: press the clutch pedal all the way down and move the gearbox lever into neutral.
- Automatic gearbox: Press the brake pedal and move the selector lever to the **P** position or into **N**.
- Turn the key to the ③ position. The key automatically returns to the ② position. Do not press the accelerator.

Start-Stop System*

When you stop and release the clutch pedal, the Start-Stop system* turns off the engine. The ignition remains switched on.



» » in Switching the ignition on and starting the engine with the key on page 179



» » page 178

Lights and visibility

Light switch

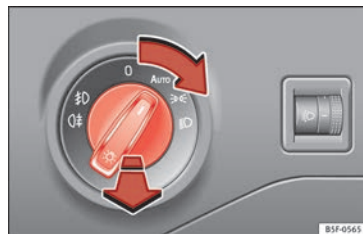


Fig. 36 Dash panel: light control.

- Turn the switch to the required position
» » Fig. 36.

Symbol	Ignition switched off	Ignition is switched on
0	Fog lights, dipped beam and side lights off.	Light off or daytime driving light on.
AUTO	The "Coming home" and "Leaving home" guide lights may be switched on.	Automatic control of dipped beam and daytime running light.
☞☜	Side light on.	
☞☜	Dipped beam headlight off	Dipped beam switched on.

☞☜ **Front fog lights:** move the switch to the first position, from positions **AUTO**, ☞☜ or ☞☜.

☞☜ **Rear fog light:** move the switch completely from positions **AUTO**, ☞☜ or ☞☜.

- Switching off fog lights: Push the switch or turn it to the 0 position.



» » ⚠ in Side light and dipped beam headlight on page 140



» » page 140

Turn signal and main beam lever

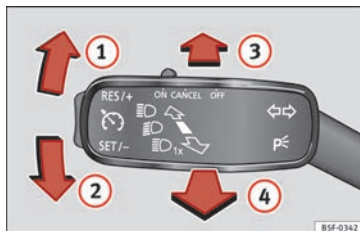


Fig. 37 Turn signal and main beam lever.

More the lever to the required position:

- Right turn signal: Right-hand parking light (ignition switched off).
- Left turn signal: Left-hand parking light (ignition switched off).
- Main beam switched on: Control lamp ☞☜ lit up on the instrument panel.
- Headlight flasher: lit up when the lever is pushed. Control lamp ☞☜ lit up.

Lever all the way down to switch it off.



» » ⚠ in Turn signal and main beam lever on page 141



» » page 141

Hazard warning lights

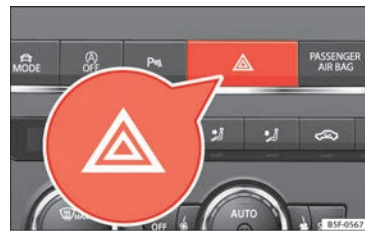


Fig. 38 Dash panel: switch for hazard warning lights.

Switched on, for example:

- When approaching a traffic jam
- In an emergency
- The vehicle has broken down
- When towing or being towed



» » ⚠ in Hazard warning lights ⚠ on page 145



» » page 145

Interior lights

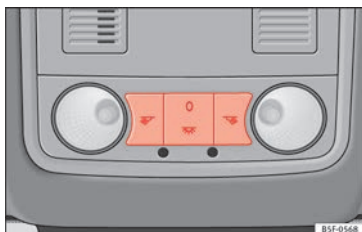


Fig. 39 Detail of headliner: front interior lighting.

Knob	Function
0	Switches interior lights off.
	Switches interior lights on.
Central position or 	Door contact switch-on. The interior lights come on automatically when the vehicle is unlocked, a door is opened or the key is removed from the ignition. The light goes off a few seconds after all the doors are closed, the vehicle is locked or the ignition is switched on.

Knob	Function
	Turning the reading light on and off

a) Depending on version.



» page 147

Windscreen wipers and window wiper blade

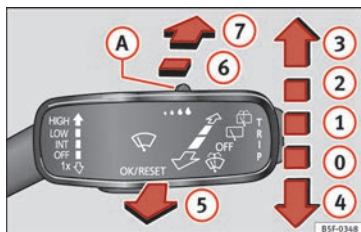


Fig. 40 Operating the windscreen wiper and rear wiper.

More the lever to the required position:	
0	OFF Windscreen wiper off.

More the lever to the required position:	
1	INT Windscreen wipers interval wipe. Using the control » Fig. 40 (A) adjust the interval (vehicles without rain sensor), or the sensitivity of the rain sensor.
2	LOW Slow wipe.
3	HIGH Continuous wipe.
4	1x Short wipe. Brief press, short clean. Hold the lever down for more time to increase the wipe frequency.
5	Automatic wipe. The windscreen washer function is activated by pushing the lever forwards, and simultaneously the windscreen wipers start.
6	Interval wipe for rear window. The wiper will wipe the window approximately every six seconds.
7	The rear window wash function is activated by pressing the lever, and the rear wiper starts simultaneously.



» page 148

SOS

» page 72

Easy Connect

CAR menu settings

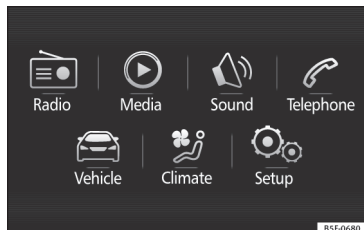





Fig. 41 Easy Connect: Main menu.

The actual number of menus available and the name of the various options will depend on the vehicle's electronics and equipment.

- Switch the ignition on.
- If the Infotainment System is off, switch it on.
- Press the Infotainment button  /  and then the **Vehicle** function button  **»» Fig. 41**,

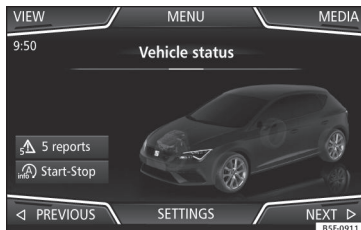



Fig. 42 Easy Connect: CAR menu.

or, press the Infotainment button  to go to the **Vehicle** menu **»» Fig. 42**.

- Press the **SETTINGS** function button to open the **Vehicle settings** menu.
- To select a function in the menu, press the desired button.

When the function button check box is activated , the function is active.

Pressing the menu button  will always take you to the last menu used.

Any changes made using the settings menus are automatically saved on closing those menus.

Menu	Submenu	Possible setting	Description
ESC system	–	Activation and deactivation of the traction control system (ASR) and the electronic stability control (ESC) system, selecting the Sport / Off-road* mode of the electronic stability control (ESC Sport)	»» page 187
Tyres	Tyre pressure monitoring	Tyre pressure storing (Calibration)	»» page 283
	Winter tyres	Activation and deactivation of the speed warning, adjusting the speed warning value	»» page 287

The essentials

Menu	Submenu	Possible setting	Description
Lights	Light assist	Dynamic Light Assist, Light Assist, motorway function, turning-on time, headlamp range adjustment, automatic lights when raining, one-touch signalling, travel mode.	» page 140
	Vehicle interior lighting	Brightness of instrument panel and controls	» page 147
	Coming Home/Leaving Home function	Switch-on time of the “Coming home” and “Leaving home” functions	» page 143 » page 144
Driver assistance	ACC (adaptive cruise control)	Activation and deactivation: default distance level, driving profiles.	» page 214
	Front Assist (emergency brake assist system)	Activation and deactivation: Front Assist, advance warning, distance warning display	» page 210
	Lane Assist (system warning you if you leave the lane)	Activation and deactivation of lane departure warning, adaptive lane guidance	» page 224
	Detection of traffic signs	Display on the instrument panel, activation and deactivation of the speed warning	» page 233
	Trailer	Trailer recognition (display of traffic signs for vehicles with trailer), use to calculate the route, maximum speed for trailer	» page 246
	Fatigue detection	Activation and deactivation	» page 236
Parking and manoeuvring	ParkPilot	Automatic activation, front volume, front sound treble, rear volume, rear sound treble, adjust Infotainment volume	» page 237
	Auto Hold	Switching on and off when starting off	» page 208
	Electric parking brake	Switching on and off automatically	» page 183
	Braking while manoeuvring function	Switching on and off	» page 242
	Displaying the parking space	Switching on and off	
Ambient lighting	–	Switching on and off, selecting brightness, colour, area or total	» page 147

The essentials

Menu	Submenu	Possible setting	Description
Mirrors and wind-screen wipers	Mirrors	Synchronised regulation, lower the rear-view mirror when reversing, fold in after parking, rear-view mirror heating, dim in the dark	» page 21, » page 151
	Windscreen wipers	Activate and deactivate automatic windscreen wipers in case of rain, wipe when reversing	» page 32
Opening and closing	Electric windows control	Convenience opening, automatic closure in case of rain, automatic closure with central locking	» page 137
	Central locking system	Unlocking doors, automatic lock/unlock when driving, "Easy Open" audible confirmation, "Easy Entry" convenient entry function, automatic opening of the rear lid, interior monitoring	» page 125
Instrument panel	–	Current consumption, average consumption, volume to refuel, convenience consumers, ECO Advice, travelling time, distance travelled, average speed, digital speed display, speed warning, oil temperature, coolant temperature, reset data "when setting off", reset data for "total calculation", traffic signal detection	» page 36
Date and time	–	Time source, time, select time zone, time format, date, date format	–
Units	–	Distance, speed, temperature, volume, fuel consumption, GNC consumption, electric consumption, pressure	–
Service	–	Chassis number, date of next SEAT service inspection, date of next oil change service	» page 44
Factory settings	All	Restore all settings	–
	Individual	Lights, driver assistance, parking and manoeuvring, background lighting, rear view mirrors and windscreen wipers, opening and closing, instrument panel	–



» ⚠ in CAR menu on page 120

Driver information System

Introduction

With the ignition switched on, it is possible to read the different functions of the display by scrolling through the menus.

In vehicles with multifunction steering wheel, the multifunction display can only be operated with the steering wheel buttons.

The number of menus displayed on the instrument panel will vary according to the vehicle electronics and equipment.

A specialised workshop will be able to programme or modify additional functions, according to the vehicle equipment. SEAT recommends visiting a SEAT Official Service.

Some menu options can only be read when the vehicle is at a standstill.

As long as a priority 1 warning is displayed, it will not be possible to read the menus » page 41. Some warning messages can be confirmed and made to disappear with the windscreen wiper lever button or the multifunction steering wheel button.

The information system also provides the following information and displays (depending on the vehicle's equipment):

Driving data » page 38

- MFD from departure

- MFD from refuelling
- MFD total calculation

Assist systems » page 40

Navigation » Booklet Navigation system

Audio » Booklet Radio or » Booklet Navigation system

Telephone » Booklet Radio or » Booklet Navigation system

Vehicle status » page 41

⚠ WARNING

Any distraction may lead to an accident, with the risk of injury.

- Do not operate the instrument panel controls when driving.

Using the menus on the instrument panel



Fig. 43 Windscreen wiper lever: control buttons.



Fig. 44 Right side of multifunction steering wheel: control buttons.

The driver information system is controlled with the multifunction steering wheel buttons » Fig. 44 or with the windscreen wiper lever » Fig. 43 (if the vehicle is not equipped with multifunction steering wheel).

Enabling the main menu

- Switch the ignition on.
- If a message or vehicle pictogram appears, press button » Fig. 43 ① on the windscreen wiper lever or button **OK** on the multifunction steering wheel » Fig. 44.
- *If managed from the windscreen wiper lever:* to display the main screen or to return to the main menu from another menu, hold down the rocker button » Fig. 43 ②.
- *If managed from the multifunction steering wheel:* the main menu list is not displayed. To go from point to point in the main menu, press button **<** or **>** several times » Fig. 44.

Select a submenu

- Press the rocker switch » Fig. 43 ② on the windscreen wiper lever up or down or turn the thumbwheel of the multifunction steering wheel » Fig. 44 until the desired option appears marked on the menu.
- The selected option is displayed between two horizontal lines. In addition, a triangle is displayed on the right: ◀
- To consult the submenu option, press button » Fig. 43 ① on the windscreen wiper lever or button **OK** on the multifunction steering wheel » Fig. 44.

Making changes according to the menu

- With the rocker switch on the windscreen wiper lever or the thumbwheel of the multifunction steering wheel, make the desired changes. To increase or decrease the values more quickly, turn the thumbwheel faster.
- Mark or confirm the selection with button » Fig. 43 ① on the windscreen wiper lever or button **OK** on the multifunction steering wheel » Fig. 44.

Button for the driver assistance systems*

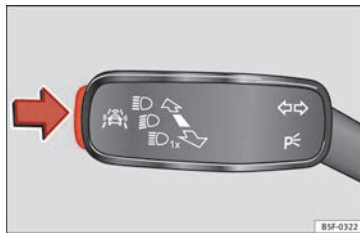


Fig. 45 On the turn signal and main beam headlight lever: button for the driver assistance systems

With the turn signal and main beam headlight lever button, you can activate or deactivate the driver assistance systems displayed

in the **Assist systems** menu » page 205.

Activate or deactivate a driver assistance system

- Briefly press the button » Fig. 45 in the direction of the arrow to open the menu **Assist systems**.
- Select the driver assistance system and activate or deactivate it » page 36. A mark indicates that driver assistance system is switched on.

Selection menu

Menu	Function
Driving data	Information and possible configurations of the multifunction display (MFD) » page 38.
Assist systems	Information and possible configurations of the driver assistance systems » page 40. »

Menu	Function
Navigation	Information instructions from the activated navigation system: when a route guidance is activated, the turning arrows and proximity bars are displayed. The appearance is similar to the Easy Connect system. If route guidance is not activated, the direction of travel (compass) and the name of the street along which you are driving are shown » Booklet Navigation system.
Audio	Station display on the radio. Track name on the CD. Track name in Media mode » Booklet Radio or » Booklet Navigation system.
Telephone	Information and possible configurations of the mobile phone preinstallation » Booklet Radio or » Booklet Navigation system.
Lap timer	In a racing circuit, measurement and memorisation of lap times by the vehicle and comparison with previously measured best times » page 40.
Vehicle status	Display of the current warning or information texts and other system components, according to equipment » page 33.

Driving data

The MFD (multifunction display) shows different values for the journey and the consumption.

Changing between display modes on the MFD

- *In vehicles without multifunction steering wheel:* Press the rocker switch (TRIP) on the windscreen wiper lever » Fig. 43.
- *Vehicles with a multifunction steering wheel:* turn the wheel » Fig. 44.

Multifunction display memory

The multifunction display is equipped with three memories that work automatically: MFD from departure, MFD from refuelling and MFD total calculation. On the screen display, you can read which memory is currently displayed.

- Toggle between memories with the ignition on and the memory displayed: Press the (OK/RESET) button on the windscreen wiper lever or the (OK) button of the multifunction steering wheel.


Menu	Function
MFD from departure	Display and storage of the values for the journey and the consumption from when the ignition is switched on to when it is switched off. If the journey is continued in less than 2 hours after the ignition is switched off, the new data is added to the data already stored in the memory. The memory will automatically be deleted if the journey is interrupted for more than 2 hours.
MFD from refuelling	Display and storage of the values for the journey and the consumption. By refuelling, the memory will be erased automatically.
MFD total calculation	The memory records the values for a specific number of partial trips, up to a total of 19 hours and 59 minutes or 99 hours and 59 minutes, or 1999.9 km or 9999 km, depending on the model of instrument panel. On reaching either of these limits ^{a)} , the memory is automatically erased and starts to count from 0 again.

^{a)} It varies according to the instrument panel version.

Erasing a memory manually

- Select the memory that you wish to erase.
- Hold the (OK/RESET) button of the multifunction steering wheel or the (OK) button of the multifunction wheel pressed down for about 2 seconds.

Personalising the displays

In the Easy Connect system you can adjust which of the possible displays of the MFD can be shown on the instrument panel display with the **(CAR)** button and the **(SETTINGS)** function button »»  page 120.

Data summary

Menu	Function
Current fuel consumption	The current fuel consumption display operates throughout the journey, in litres/100 km; and with the engine running and the vehicle stopped, in litres/hour.
Average fuel consumption^{a)}	After turning on the ignition, average fuel consumption in litres/100 km will be displayed after travelling about 100 metres. Otherwise horizontal lines are displayed. The value shown is updated approximately every 5 seconds. ACT[®] : Depending on the equipment, number of active cylinders.
Operating range^{a)}	Approximate distance in km that can still be travelled with the fuel remaining in the tank, assuming the same style of driving is maintained. This is calculated using the current fuel consumption.
Travelling time	This indicates the hours (h) and minutes (min) since the ignition was switched on.

Menu	Function
Journey	Distance covered in km (m) after switching on the ignition.
CNG quality	Whenever you refuel the quality of the natural gas is automatically verified and is displayed when the ignition is switched on. The display is made in a percentage of between 70% and 100%. The greater the percentage displayed the lower the consumption may be.
Average speed	The average speed will be shown after a distance of about 100 metres has been travelled. Otherwise horizontal lines are displayed. The value shown is updated approximately every 5 seconds.
Digital display of speed	Current speed displayed in digital format.
Speed warning at --- km/h or Speed warning at --- mph	If the stored speed is exceeded (between 30 - 250 km/h, or 19 - 155 mph), an audible warning is given together with a visual warning.
Detection of traffic signs	The traffic signs detected are displayed.
Oil temperature	Updated engine oil temperature digital display
Coolant temperature gauge	Digital display of the current temperature of the liquid coolant.

Menu	Function
Convenience consumers	Information about the vehicle's main convenience consumers. It is displayed by means of a consumption indicator bar.
Eco tips	Tips on how to save fuel.
Reset data "when setting off"	Reset journey data when setting off.
Reset data for "total calculation"	Reset travel journey to zero.

^{a)} In vehicles with a natural gas engine, range and average consumption refer only to data or natural gas consumption. If you are in "petrol mode", the information of both data only appears on the dash panel and not on the multifunction screen.

Storing a speed with the speed warning

- Select the display **Speed warning at --- km/h (--- mph)**
- Press the button **(OK/RESET)** on the windscreen wiper lever or the button **(OK)** on the multifunction steering wheel to store the current speed and activate the warning.
- To switch system on: adjust to the desired speed within 5 seconds using the rocker switch **(TRIP)** on the windscreen wiper lever or by turning the thumbwheel on the multifunction steering wheel. Next, press the button **(OK/RESET)** or **(OK)** again or wait several seconds. The speed is stored and the warning activated.



• To switch system off: press the button (OK/RESET) or (OK). The stored speed is deleted.

Assist systems menu

Menu	Function
ACC	Display of Adaptive Cruise Control (ACC) » page 214.
Front Assist	Switching the monitoring system on and off » page 210.
Lane Assist*	Switching the Lane Assist system on or off » page 225.
Detection of traffic signs	Display of traffic signs » page 233:
Fatigue detection*	Switching the fatigue detection on or off (pause recommendation) » page 236.

Timer*

You can access the timer via the selection menu » page 37.

It allows you to manually time lap times on a racing circuit, memorise them and compare them to the vehicle's previous best times.

The following menus can be displayed:

- **Stop**

- **Lap**
- **Pause**
- **Partial time**
- **Statistics**

Change from one menu to another

- *Vehicles without multifunction steering wheel:* press the rocker switch (TRIP) in the windscreen wiper lever.
- *Vehicles with multifunction steering wheel:* turn the wheel » Fig. 44.

Menu "Stop"

Start	The timer starts. If there are existing laps and they are included in the statistics, it will begin with the number of laps in question. It is only possible to begin with a new first lap if the statistics have been reset first in the Statistics menu.
Since start	The timer begins when the vehicle sets off. If the vehicle is already moving, the timer begins once the vehicle has stopped.
Statistics	The Statistics menu is displayed on the screen.

Menu "Lap"

New Lap	The timer of the current lap stops and a new lap starts immediately. The time for the lap you have just completed is included in the statistics.
Partial time	For about 5 seconds a partial time is displayed. The timer continues in parallel.
Stop	The current lap timer will be interrupted. The lap does not end. The Pause menu is displayed.

Menu "Pause"

Continue	The interrupted timer continues.
New Lap	A new timer starts. The halted lap ends and is included in the statistics.
Interr. Lap	The timer of the current lap ends and is cancelled. It is not included in the statistics.
End	The current timer ends. The lap is included in the statistics.

Menu "Partial time"

Partial time	For about 5 seconds a partial time is displayed. The timer continues in parallel.
New Lap	The timer of the current lap stops and a new lap starts immediately. The time for the lap you have just completed is included in the statistics.

Menu "Partial time"

Stop

The current lap timer will be interrupted. The lap does not end. The **Pause** menu is displayed.

Menu "Statistics"

View of the latest lap times:

- total time
- best lap time
- worst lap time
- average lap duration

A maximum of 10 laps is possible, and a total duration of 99 hours, 59 minutes and 59 seconds.

If one of the 2 limits is reached, you will have to reset the statistics in order to begin a new timer.

Back

This returns to the previous menu.

Resetting to zero

All the memorised statistical data are reset.

WARNING

Do your best to avoid handling the timer while driving.

- Only set the timer or consult statistics when the vehicle is stationary.
- While driving, do not handle the timer in complicated driving situations.

Status display

Bonnet, rear lid and doors open

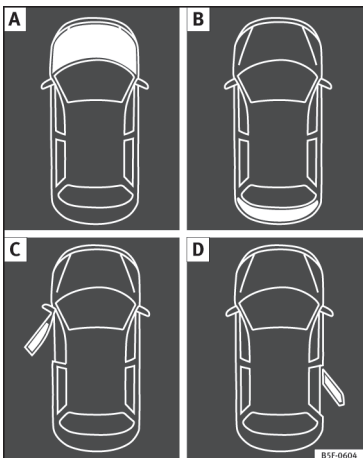


Fig. 46 A: bonnet open; B: rear lid open; C: front left door open; D: rear right door open (5-door vehicles only).

When the ignition is switched on or when driving, the bonnet, rear lid or doors that are open will be indicated on the instrument panel display, and, as applicable, this will be indicated audibly. The display may vary according to the type of instrument panel fitted.

Illustration

Key to »» Fig. 46

A

Do not continue driving!
The bonnet is open or is not properly closed »» page 270.

B

Do not continue driving!
The rear lid is open or is not properly closed »» page 135.


C, D

Do not continue driving!
A vehicle door is open or is not properly closed »» page 125.



»» page 115

Warning and information messages

The system runs a check on certain components and functions when the ignition is switched on and while the vehicle is moving. Faults in the operation are displayed on the screen using red and yellow symbols and messages on the instrument panel display (»»  page 119) and, in some cases, with audible warnings. The display may vary according to the type of instrument panel fitted. »»

Priority 1 warning (red symbols)

Symbol flashing or lit; partly combined with audible warnings.

🛑 **Stop the vehicle!** It is dangerous » ⚠️ in Warning and control lamps on page 119 !

Check the function that is faulty and repair it. If necessary, request assistance from specialised personnel.

Priority 2 warning (yellow symbols)

Symbol flashing or lit; partly combined with audible warnings.

A faulty function, or fluids which are below the correct levels may cause damage to the vehicle! » ⚠️ in Warning and control lamps on page 119

Check the faulty function as soon as possible. If necessary, request assistance from specialised personnel.

Informative text

Information relating to different vehicle processes.

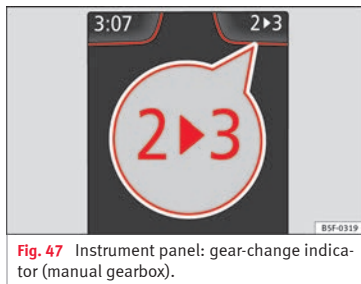
Gear-change indicator

Fig. 47 Instrument panel: gear-change indicator (manual gearbox).

A gear change will be recommended if the gear you are in is not the most economical choice. If no gear-change is recommended, it means that you are already in the most economical gear.

Vehicles with a manual gearbox

The following display symbols » Fig. 47 mean:

- ▶ **Change to a higher gear:** the suggested gear appears to the **right** of the current gear when a **higher gear is recommended**.
- ◀ **Change to a lower gear:** the suggested gear appears to the **left** of the current gear when a **lower gear is recommended**.

The gear recommendation may occasionally skip a gear (2nd ▶ 4th).

Vehicles with an automatic gearbox*

The display is only visible in tiptronic mode » 📄 page 193.

The following display symbols mean:

- ↑ **Shifting up a gear**
- ↓ **Shifting down a gear**

ⓘ CAUTION

The gear-change indicator is intended to help save fuel, but it is not intended to recommend the right gear for all driving situations. In certain situations, only the driver can choose the correct gear (for instance when overtaking, driving up a steep gradient or towing a trailer).

📄 Note

The display disappears from the instrument panel when you press the clutch pedal.

Outside temperature display

When the outside temperature is below +4°C (+39°F), the “ice crystal” symbol (warning of risk of freezing) is also displayed. At first, this symbol flashes and then it remains lit until the outside temperature rises above +6°C (+43°F) » ⚠️ in Indications on the display on page 117.

When the vehicle is at a standstill or when travelling at very low speeds, the temperature displayed may be higher than the true outside temperature as a result of the heat produced by the engine.

The temperatures measured range from -40°C to +50°C (-40°F to +122°F).



Engine oil temperature display

Vehicles without multifunction steering wheel

• Press the rocker switch » Fig. 43 ② until the main menu appears. Enter into **Driving data**. With the button ② move to the oil temperature gauge.



Vehicles with multifunction steering wheel

• Enter the submenu **Driving data** and turn the thumbwheel until the oil temperature display appears.

The engine reaches its operating temperature when in normal driving conditions, the oil temperature is between **80°C (180°F)** and **120°C (250°F)**. If the engine is required to work hard and the outside temperature is high, the engine oil temperature can increase. This does not present any problem as long as the warning lamps  » table on page 48 or  » table on page 48 do not appear on the display.

Additional consumers

• *Operation with the windscreen wiper lever**: Press the rocker switch » Fig. 43 ② until the main menu appears. Enter into the section **Driving data**. With the rocker switch, move to the display **Convenience consumers**.

• *Operation with the multi-function steering wheel**: move with the buttons  or  to **Driving data** and enter with **OK**. Turn the right thumbwheel until the **Convenience consumers** display appears.

In addition, a scale will inform you of the current sum of all the additional appliances.

Saving tips



Tips on how to save fuel will be displayed in conditions that increase fuel consumption. Follow them to reduce consumption. The indications appear automatically only with the efficiency programme. After a time, the tips will disappear automatically.

If you wish to hide a saving tip immediately after it appears, press any button on the windscreen wiper lever*/multifunction steering wheel*.

Note

- If you hide a saving tip, it will reappear after you switch the ignition on again.
- The saving tips do not appear in all situations, but rather with a large separation of time.


Speed warning device

The speed warning device warns the driver when they have exceeded the pre-set speed limit by 3 km/h (2 mph). An audible warning signal sounds, and the warning lamp  and the driver message **Speed limit exceeded!** will be displayed simultaneously on the instrument panel. The warning lamp  switches off when reducing speed below the stored maximum limit.

Speed warning programming is recommended if you wish to be reminded of a maximum speed, such as when travelling in a country with different speed limits or for a maximum speed for winter tyres.

Setting speed limit warning

You can use the radio or the Easy Connect* to set, alter or cancel the speed limit warning.

- *Vehicles with radio*: press the button  control button **Driver Assistant** » **Speed warning**. »

- **Vehicles with Easy Connect:** Press the **CAR** button and the function button **SETTINGS > Driver assistance > ACC > Distance**.

The warning limit can be set from 30 to 240 km/h (20 to 149 mph). The adjustment is made at 10 km/h (5 mph) intervals.

Note

- Please bear in mind that, even with the speed warning function, it is still important to keep an eye on the vehicle speed with the speedometer and to observe the legal speed limits.
- The speed limit warning function in the version for some countries warns you at a speed of 120 km/h (75 mph). This is a factory-set speed limit.

Service intervals

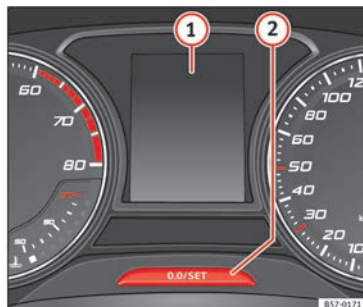


Fig. 48 Instrument panel

The service interval indication appears on the instrument panel display » Fig. 48 ①.

SEAT distinguishes between services *with* engine oil change (e.g. Oil change service) and services *without* engine oil change (e.g. Inspection).


In vehicles with **Services established by time or mileage**, the service intervals are already pre-defined.

In vehicles with **LongLife Service**, the intervals are determined individually. Thanks to technological progress, maintenance work has been greatly reduced. Because of the technology used by SEAT, with this service you only need to change the oil when the ve-

hicle so requires. To calculate this change (max. 2 years), the vehicle's conditions of use and individual driving styles are considered. The advance warning first appears 20 days before the date established for the corresponding service. The kilometres (miles) remaining until the next service are always rounded up to the nearest 100 km (miles) and the time is given in complete days. The current service message cannot be viewed until 500 km after the last service. Prior to this, only lines are visible on the display.

Inspection reminder


When the Service date is approaching, when the ignition is switched on a **Service reminder** is displayed.

Vehicles without text messages: a spanner  will be displayed on the instrument panel plus an indication in **km**.

The kilometres indicated are the maximum number of kilometres that can be travelled until the next service. After a few seconds, the display mode changes. A clock symbol appears and the number of days until the next service is due.

Vehicles with text messages: **Service in --- km or --- days** will be shown on the instrument panel display.

Service due

When **the service date is due**, an audible warning is given when the ignition is switched on and the spanner displayed on the screen flashes for a few seconds .

Vehicles with text messages: **Service now** will be shown on the instrument panel display.

Reading a service notification

With the ignition switched on, the engine off and the vehicle at a standstill, the current **service notification** can be read:

Press and hold the button **0.0/SET** for more than 5 seconds to consult the service message **» Fig. 48 ②**.

When the **service date has passed**, a minus sign is displayed in front of the number of kilometres or days.

Vehicles with text messages: the following message is displayed: **Service --- km (miles) or --- days ago**.

Resetting service interval display

If the service was not carried out by a SEAT dealership, the display can be reset as follows:

- Switch off the ignition, press and hold the button **0.0/SET** **» Fig. 48 ②**.
- Switch ignition back on.

- Release the button **0.0/SET** and press it again for the next 20 seconds.

Note

- **The service message disappears after a few seconds, when the engine is started or when **OK/RESET** is pressed on the windscreen wiper lever, or **OK** on the multifunction steering wheel.**

- **In vehicles with the LongLife system in which the battery has been disconnected for a long period of time, it is not possible to calculate the date of the next service. Therefore the service interval display may not be correct. In this case, bear in mind the maximum service intervals permitted in the **» Booklet Maintenance Programme**.**

- **If you reset the display manually, the next service interval will be indicated as in vehicles with fixed service intervals. For this reason we recommend that the service interval display be reset by a SEAT authorised Dealer.**

Cruise control

Operating the cruise control system (CCS)*

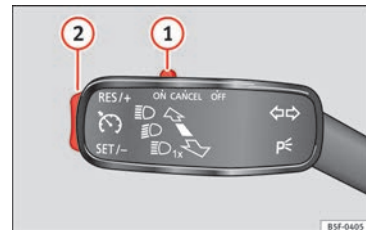


Fig. 49 On the left of the steering column: switches and controls for operating the CCS

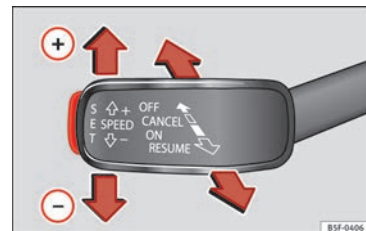


Fig. 50 On the left of the steering column: third lever to operate the CCS. **»**

Operation of the turn signal lever

- Switching on the CCS: Move switch »» Fig. 49 ① to **ON**. The system is on. If no speed has been programmed, the system will not control it.
- Activating the CCS: Press button »» Fig. 49 ② in the **SET/-** area. The current speed is memorised and controlled.
- Temporarily switching off the CCS: Move switch »» Fig. 49 ① to **CANCEL** or push the brake. The cruise control system is switched off temporarily.
- Reactivating the CCS: Press button »» Fig. 49 ② in **RES/+**. The memorised speed is saved and controlled again.
- Increasing stored speed during CCS regulation: press button ② in **RES/+**. The vehicle accelerates until the new stored speed.

- Reducing stored speed during CCS regulation: press button ② in **SET/-** to lower the speed by 1 km/h (1 mph). Speed is reduced until reaching the new stored speed.
- Switching off the CCS: Move switch »» Fig. 49 ① to **OFF**. The system is disconnected and the memorised speed is deleted.

Operation using the third lever

- Switching on the CCS: move the third lever to **ON** »» Fig. 50. The system switches on but it does not control the speed as no speed has been programmed.
- Activating the CCS: press the **SET** »» Fig. 50 button. It memorises and maintains the current speed.
- Temporarily switching off the CCS: move the lever to **CANCEL** »» Fig. 50 and release it or

press the brake pedal. The cruise control system is switched off temporarily.

- Reactivating the CCS: move the lever to **RESUME** »» Fig. 50 and release it. The memorised speed is saved and controlled again.
- Switching off the CCS: move the third lever to position **OFF** »» Fig. 50. The system is disconnected and the memorised speed is deleted.



»» ⚠ in Operation on page 210



»» page 209

Warning lamps

On the instrument panel

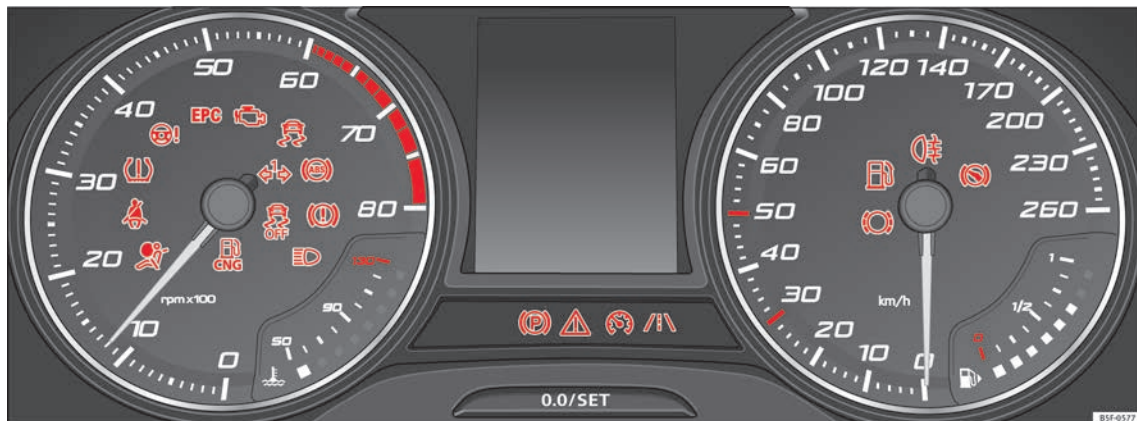


Fig. 51 Instrument panel, on dash panel.

Red warning lamps













	Central warning lamp: additional information on the instrument panel display	-
	Parking brake on.	» page 183




	Do not continue driving! The brake fluid level is too low or there is a fault in the brake system.	» page 186
	<i>Lit up or flashing:</i> Do not continue driving! Fault in the steering.	» page 198

	Driver or passenger has not fastened seat belt.	» page 80
	Use the foot brake!	» page 216











Yellow warning lamps


	Central warning lamp: additional information on the instrument panel display	–
	Front brake pads worn.	» page 186
	<i>it lights up:</i> Fault in the ESC, or disconnection caused by the system. <i>flashes:</i> ESC or ASR activated.	» page 187
	ASR manually deactivated.	» page 187
	ESC in Sport mode or OFF	
	ABS faulty or does not work.	» page 140
	Rear fog light switched on.	
	<i>lights up or flashes:</i> fault in the emission control system.	» page 202
	<i>it lights up:</i> pre-heating of diesel engine.	» page 203
	<i>flashes:</i> fault in the diesel engine management.	
EPC	fault in the petrol engine management.	» page 203
	<i>lights up or flashes:</i> fault in the steering system.	» page 198
	Tyre pressure too low, or fault in the tyre pressure monitoring system.	» page 283

	Fuel tank almost empty.	» page 118
	Fault in airbag system and seat belt tensioners.	» page 90
	Lane Assist is switched on, but not active.	» page 224

Other warning lamps

	Left or right turn signal.	» page 141
	Hazard warning lights on.	» page 31 » page 145
	Trailer turn signals	» page 246
	<i>it lights up:</i> Press the foot brake! <i>flashes:</i> the selector lever locking button has not engaged.	» page 191 » page 216
	<i>it lights up:</i> cruise control activated or speed limiter switched on and active. <i>flashes:</i> the speed set by the speed limiter has been exceeded.	» page 209
	<i>green warning lamp:</i> Lane Assist is switched on and active.	» page 224
	Main beam on or flasher on.	» page 141
	Natural gas operating mode	» page 119



»  in Warning and control lamps on page 119



» page 119

On the instrument panel display

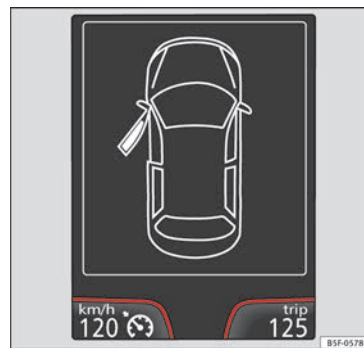


















Fig. 52 On the instrument panel display: door open.



Do not continue driving!
With the corresponding indication: door(s), rear lid or bonnet open or not properly closed.

» page 125
» page 135
» page 270

	Ignition:  Do not carry on driving! Engine coolant level too low, coolant temperature too high	» page 274
	Flashing: Fault in the engine coolant system.	
	Do not continue driving! Engine oil pressure too low. If the warning lamp flashes, stop driving, even if the oil level is correct. Do not even run the engine at idle speed!	» page 272
	Fault in the battery.	» page 277
	Driving light totally or partially faulty.	» page 103
	Fault in the cornering light system.	» page 140
	Diesel particulate filter blocked	» page 203
	Level of windscreen washer fluid too low.	» page 148
	Flashing: Fault in the oil level detection. Control manually.	» page 272
	Ignition: Insufficient engine oil.	
	Fault in the gearbox.	» page 198
	Light Assist on.	» page 142

SAFE	Immobiliser active.	» page 131
	Service interval display	» page 44
	Mobile telephone is connected via Bluetooth to the original telephone device.	» page 121 » page 123
	Mobile telephone battery charge meter. Available only for devices pre-installed in factory.	» Booklet Audio or navigation system
	Freezing warning. The outside temperature is lower than +4°C (+39°F).	» page 42
	Start-Stop system activated.	» page 205
	Start-Stop system unavailable.	
ECO	Low consumption driving status	» page 115







» page 115


On the instrument panel



Fig. 53 Warning lamp for disabling the front passenger airbag.

	Front passenger front airbag is disabled (PASSENGER AIR BAG OFF ).	» page 90
	The front passenger front airbag is activated (PASSENGER AIR BAG ON ).	» page 90



»  in Activation and deactivation of front passenger airbag* on page 89



» page 89

Gearbox lever

Manual gearbox

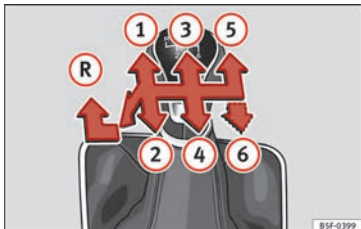


Fig. 54 Gear shift pattern of a 5 or 6-speed manual gearbox.

The position of the gears is indicated on the gearbox lever » **Fig. 54**.

- Press the clutch pedal and keep your foot right down.
- Move the gearbox lever to the required position.
- Release the clutch.

Selecting reverse gear

- Press the clutch pedal and keep your foot right down.
- With the gearbox lever in neutral, push it downwards, move it to the left as far as it will go and then forwards to select reverse » **Fig. 54 (R)**.

- Release the clutch.



» ⚠ in Changing gear on page 190



» page 190

Automatic gearbox*

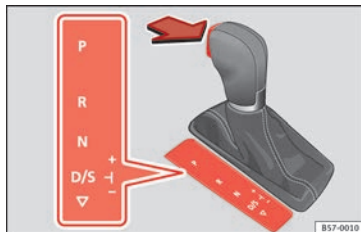


Fig. 55 Automatic gearbox: selector lever positions.

P Parking lock

R Reverse gear

N Neutral (idling)

D/S Drive (forward)

+/- Tiptronic mode: pull the lever forwards (+) to go up a gear or backwards (-) to go down a gear.



» ⚠ in Selector lever positions on page 192



» page 191

SOS

» page 50

Manual release of the selector lever

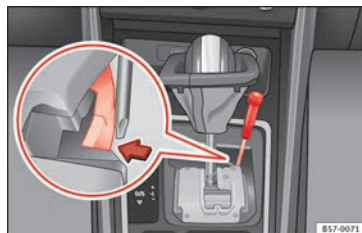




Fig. 56 Selector lever: manual release from position P.


Should the power supply be interrupted, there is a manual unlocking device located under the console of the selector lever, on the right. Releasing the selector lever requires a certain degree of practical skill.


- Unlocking: use the flat part of a screwdriver blade.

Removing the cover from the selector lever

- Apply the handbrake   to ensure that the car does not move.
- Carefully pull the corners of the selector lever boot and twist it upwards above the lever handle.

Releasing the selector lever

- Using a screwdriver, press and hold the yellow unlocking tab sideways  **Fig. 56**.

- Now press the interlock button on the selector lever  and move the selector lever to position **N**.
- After carrying out the manual release, attach the selector lever boot on the gearbox console again.

If the power supply should ever fail (e.g. discharged battery) and the vehicle has to be pushed or towed, the selector lever must first

be moved to position **N**, after operating the manual release mechanism.

WARNING

The selector lever may be moved out of position P only when the handbrake is firmly applied. If this does not work, secure the vehicle with the brake pedal. On a slope the vehicle could otherwise start to move inadvertently after shifting the selector lever out of position P - accident risk!

Air conditioning

How does Climatronic* work?

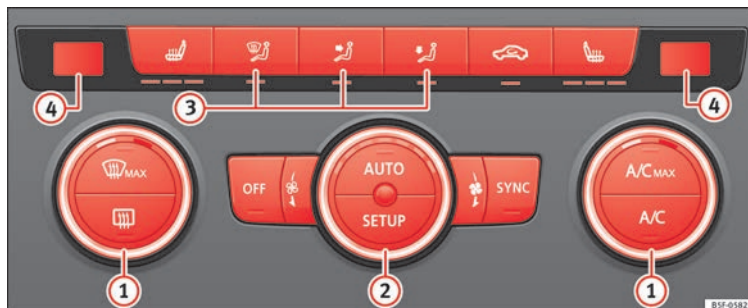








Fig. 57 In the centre console: Climatronic controls

To switch a specific function on, press the appropriate button. Press the button again to switch off the function.

The LED on each control lights up to indicate that the respective function of a control has been switched on.

<p>① Temperature</p>	<p>The left and right sides can be adjusted separately: Turn the control to adjust the temperature</p>
<p>② Fan</p>	<p>The power of the fan is automatically adjusted. The fan is also adjusted manually by turning the control.</p>
<p>③ Air distribution</p>	<p>The airflow adjusts automatically for comfort. You can also switch it on manually using the buttons ③.</p> <ul style="list-style-type: none"> ➔: The air is directed at the chest of driver and passengers by the dash panel air vents. ⬇️: Air distribution to footwells. ⬆️: Upward air distribution.

The essentials

	Indications on the temperature display screen selected for the right and left sides.
 Defrost function	The air drawn in from outside the vehicle is directed at the windscreen and air recirculation is automatically switched off. To defrost the windscreen more quickly, the air is dehumidified at temperatures over approximately +3°C (+38°F) and the fan runs at maximum output.
	Heated rear window: this only works when the engine is running and switches off automatically after a maximum of 10 minutes.
	Air recirculation
	Seat heating buttons
A/C	Press the button to switch on or off the cooling system.
A/C MAX	Press the button to make maximum cooling capacity available. The recirculation of air and the cooling system turn on automatically and air distribution adjusts automatically to the position  .
SYNC	When the warning light for button SYNC lights up, the settings on the driver side also apply to the passenger side. Press the button or the temperature control on the passenger side
AUTO	Automatic adjustment of temperature, fan, and air distribution. Press the button: the warning lamp on the button will light up AUTO .
SETUP	Press the configuration button SETUP : the air conditioning operation menu will be displayed on the Easy Connect system screen.
Switching off	Turn the blower control to the 0 position or press the OFF button.



»  in Introduction on page 173



» page 173


How does the manual air conditioning work*?











Fig. 58 In the centre console: Manual air conditioning controls.

To switch a specific function on, press the appropriate button. Press the button again to switch off the function.

The LED on each control lights up to indicate that the respective function of a control has been switched on.

<p>① Temperature</p>	<p>Turn the control to adjust the temperature.</p> <p>A/C MAX: Maximum cooling power. The recirculation of air and the cooling system turn on automatically and air distribution adjusts automatically to the position .</p>
<p>② Fan</p>	<p>Setting 0: blower and manual air conditioning switched off Level 6: maximum fan level.</p>

The essentials

3 Air distribution	 : Defrost function. The airflow is directed at the windscreen. Air recirculation is automatically switched off or is not switched on. Increase the fan power to clear the windscreen of condensation as soon as possible. To dehumidify the air, the cooling system will automatically switch on.  : The air is directed at the chest of driver and passengers by the dash panel air vents.  : Distribution of air towards the chest and the footwell area.  : Air distribution to footwells.  : Air distribution towards the windscreen and the footwell.
A/C	Press the button to switch on or off the cooling system.
	Heated rear window: this only works when the engine is running and switches off automatically after a maximum of 10 minutes.
	Air recirculation
	Seat heating buttons



»  in Introduction on page 173



» page 173






How does the heating and the fresh air system work?



Fig. 59 In the centre console: heating system and fresh air controls.

To switch a specific function on, press the appropriate button. Press the button again to switch off the function.

The LED on each control lights up to indicate that the respective function of a control has been switched on.

<p>① Temperature</p>	<p>Turn the control to adjust the temperature. The temperature cannot be lower than that of the exterior air temperature, as this system cannot cool or dehumidify the air</p>
<p>② Fan</p>	<p>Setting 0: blower, heating and fresh air systems switched off Level 6: maximum fan level</p>
<p>③ Air distribution</p>	<p>: Defrost function. The airflow is directed at the windscreen. : The air is directed at the chest of driver and passengers by the dash panel air vents. : Distribution of air towards the chest and the footwell area. : Air distribution to footwells. : Air distribution towards the windscreen and the footwell.</p>

The essentials



Heated rear window: this only works when the engine is running and switches off automatically after a maximum of 10 minutes



Air recirculation »» page 176



»»  in Introduction on page 173



»» page 173

Fluid Level control

Filling capacities

Tank level

Petrol and diesel engines	50 l, of which, approx. 7 l reserve <i>Vehicles with all-wheel-drive:</i> 55 l, of which, approx. 8.5 l reserve
Natural gas engine^{a)}	approx. 15 kg

^{a)} The capacity depends on the efficacy and characteristics of the natural gas pumps. The capacity indicated is based on a minimum loading pressure of 200 bar.

Capacity of the windscreen washer fluid container

Versions without headlight washer system	approx. 3 litres
Versions with headlight washer system	approx. 5 litres

Fuel

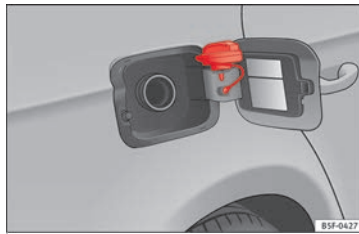


Fig. 60 Fuel tank flap with tank cap attached.

The flap that covers the tank cap is unlocked and locked automatically using the central locking.

Opening the fuel tank cap

- Open the fuel tank flap by pressing on the left side.
- Unscrew the cap by turning it to the left.

- Place it in the space on the hinge of the open flap »» **Fig. 60.**

Closing the fuel tank cap

- Unscrew the cap by turning it to the right as far as it will go.
- Close the lid.



»» ⚠ in Refuelling on page 265



»» page 264

Oil

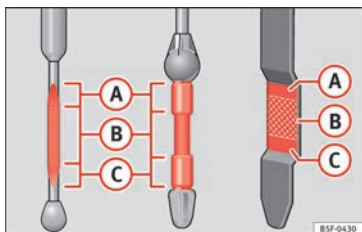


Fig. 61 Engine oil dipstick.

The level is measured using the dipstick located in the engine compartment

» page 270.

The oil should leave a mark between zones **A** and **C**. It should never exceed zone **A**.

- Zone **A**: Do not add oil.
- Zone **B**: You can add oil but keep the level in that zone.



Fig. 62 In the engine compartment: Engine oil filler cap.

- Zone **C**: Add oil up to zone **B**.

Topping up engine oil

- Unscrew cap from oil filler opening.
- Add oil slowly.
- At the same time, check the level to ensure you do not add too much.

- When the oil level reaches at least zone **B**, unscrew the engine oil filler cap carefully.

Engine oil additives

No type of additive should be mixed with the engine oil. The deterioration caused by these additives is not covered by the warranty. »

Engine oil specifications

Service interval	Engine type	Specification
Petrol engines with Set Service Intervals (dependent on time/distance travelled)	1.4l CNG / 1.4l 110kW without ACT	VW 502 00
	1.0l / 1.2l / 1.4l 92kW / 1.4l 110kW with ACT / 1.8l / 2.0l	VW 504 00
	1.2l / 1.4l 110kW without ACT / 1.6l / 1.8l / 2.0l	VW 502 00 ^{a)}
Petrol engines with Flexible Service Intervals (LongLife)	1.0l / 1.2l / 1.4l	VW 508 00 / VW 504 00 ^{b)}
	1.8l / 2.0l	VW 504 00
Diesel engines with Set Service and Flexible Service Intervals ^{c)}	With particulate filter (DPF)	VW 507 00
Diesel engines with Set Service Intervals	Without particulate filter (DPF)	VW 505 01 ^{a)} / VW 506 01 ^{a)}

a) If the quality of the fuel available in the country does **not** fulfil the EN 228 (for petrol) and EN 590 (for diesel) standards.

b) Use of engine oil compliant with the VW 504 00 specification instead of VW 508 00 may have a slight negative effect on the vehicle's exhaust gas values.

c) Only use recommended oils, otherwise you may damage the engine.



» ⚠ in Changing engine oil on page 274




» page 272

Coolant



Fig. 63 Engine compartment: coolant expansion tank cap.

The coolant tank is located in the engine compartment »  page 270.

When the engine is cold, replace the coolant when the level is below **MIN**.

Coolant specifications

The engine cooling system is supplied from the factory with a specially treated mixture of water and at least 40 % of the additive **G13** (TL-VW 774 J), purple. This mixture gives the necessary frost protection down to -25°C (-13°F) and protects the light alloy parts of the engine cooling system against corrosion. It also prevents scaling and considerably raises the boiling point of the coolant.

To protect the cooling system, the percentage of additive must always be at least 40 %, even in warm climates where anti-freeze protection is not required.

If for weather reasons further protection is necessary, the proportion of additive may be increased, but only up to 60 %; otherwise antifreeze protection will diminish and this will worsen cooling.

When the coolant is topped up, use a mixture of **distilled water** and at least 40 % of the G13 or G12 plus-plus (TL-VW 774 G) additive (both are purple) to obtain an optimum anti-corrosion protection » **!** in **Topping up coolant** on page 275. The mixture of G13 with G12 plus (TL-VW 774 F), G12 (red) or G11 (green-blue) engine coolants will significantly reduce anti-corrosion protection and should therefore be avoided » **!** in **Topping up coolant** on page 275.



» **!** in Topping up coolant on page 275



» page 274

Brake fluid



Fig. 64 Engine compartment: brake fluid reservoir cap.

The brake fluid reservoir is located in the engine compartment » **!** page 270.

The level should be between the **MIN** and **MAX** marks. If it is below **MIN**, please visit a Technical Service.



» **!** in Top up brake fluid on page 276



» page 275

Windscreen washer



Fig. 65 In the engine compartment: windscreen washer reservoir top.

The windscreen washer reservoir is located in the engine compartment » **!** page 270.

To top up, mix water with a product recommended by SEAT.

In cold temperatures, add anti-freeze.



» **!** in Checking and topping up the windscreen washer reservoir on page 276




» page 276

Battery

The battery is located in the engine compartment » **!** page 270. It does not require »

maintenance. It is checked as part of the Inspection Service.



» »  in Important safety warnings for handling a vehicle battery on page 278



» » page 277

Emergencies

Fuses

Fuse location

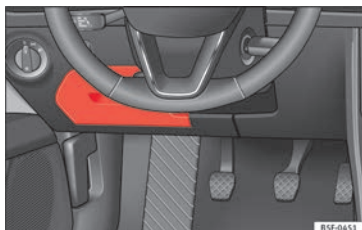


Fig. 66 On the driver-side dash panel: fuse box cover.

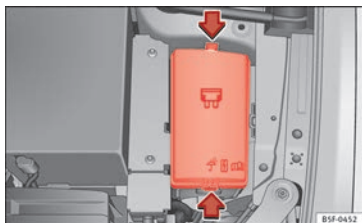


Fig. 67 In the engine compartment: fuse box cover.

Underneath the instrument panel

The fuse box is located behind the storage compartment »» **Fig. 66**.

In the engine compartment

Press the locking tabs to release the fuse box cover »» **Fig. 67**.

Identifying fuses situated below the dash panel by colours

Colour	Amp rating
Black	1
Purple	3
Light brown	5
Brown	7.5
Red	10
Blue	15
Yellow	20
White or transparent	25
Green	30
Orange	40



»» ⚠ in Introduction on page 101



»» page 101

Replacing a blown fuse

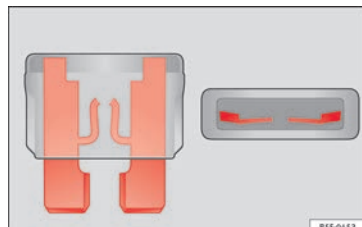


Fig. 68 Image of a blown fuse.

Preparation

- Switch off the ignition, lights and all electrical equipment.
- Open the corresponding fuse box »» 🛠 page 102.

Identifying a blown fuse

A fuse is blown if its metal strip is ruptured »» **Fig. 68**.

- Point a lamp at the fuse to see if it has blown.

To replace a fuse

- Remove the fuse.
- Replace the blown fuse by one with an *identical* amperage rating (same colour and markings) and *identical* size. »»

- Replace the cover again or close the fuse box lid.

Bulbs

Bulbs (12 V)

Note: Depending on the level of equipment fitted in the vehicle, LEDs may be used for part or all of the interior and/or exterior lighting. LEDs have an estimated life that exceeds that of the vehicle. If an LED light fails, go to an authorised workshop for its replacement.

Light source used for each function

Halogen headlights.	Type
Daytime running light/side light	P21W SLL
Dipped beam headlights	H7 LL
Main beam headlights	H7 LL
Turn signal	PY21W LL

Full-LED main headlights	Type
No bulbs may be replaced. All functions are with LEDs	

Front fog light	Type
Fog/cornering lights*	H8

Rear lights	Type
Brake light/tail light	P21W LL
Side lights	2x W5W LL
Turn signal	PY21W LL
Retro fog light	H21W
Reverse lights	P21W LL

LED rear lights	Type
Reverse lights	W16W
The remaining functions work with LEDs	





» page 103

Action in the event of a puncture

What to do first

- Park the vehicle on a horizontal surface and in a safe place as far away from traffic as possible.
- Apply the handbrake.
- Switch on the hazard warning lights.
- *Manual gearbox:* select the 1st gear.

- *Automatic gearbox:* Move the selector lever to position **P**.
- If you are towing a trailer, unhitch it from your vehicle.
- Have the vehicle tool kit »  page 95 and the spare wheel* ready »  page 286.
- Observe the applicable legislation for each country (reflective vest, warning triangles, etc.).
- All occupants should leave the vehicle and wait in a safe place (for instance behind the roadside crash barrier).

WARNING

- **Always observe the above steps and protect yourself and other road users.**
- **If you change the wheel on a slope, block the wheel on the opposite side of the car with a stone or similar to prevent the vehicle from moving.**

Repairing a tyre with the anti-puncture kit

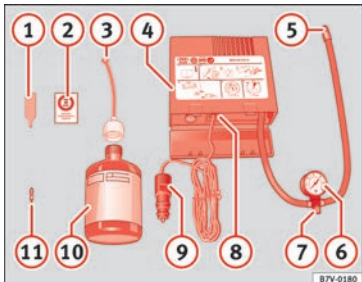


Fig. 69 Standard representation: contents of the anti-puncture kit.

The anti-puncture kit is located under the floor panel in the luggage compartment.

Sealing the tyre

- Unscrew the tyre valve cap and insert. Use the » Fig. 69 ① tool to remove the insert. Place it on a clean surface.
- Shake the tyre sealant bottle vigorously » Fig. 69 ⑩.
- Screw the inflator tube » Fig. 69 ③ into the sealant bottle. The bottle's seal will break automatically.

- Remove the lid from the filling tube » Fig. 69 ③ and screw the open end of the tube into the tyre valve.
- With the tyre sealant bottle upside down, fill the tyre with the contents of the sealant bottle.
- Remove the bottle from the valve.
- Place the insert back into the tyre valve using the tool » Fig. 69 ①.

Inflating the tyre

- Screw the compressor tyre inflator tube » Fig. 69 ⑤ into the tyre valve.
- Check that the air bleed screw is closed » Fig. 69 ⑦.
- Start the engine and leave it running.
- Insert the connector » Fig. 69 ⑨ into the vehicle's 12-volt socket » page 159.
- Turn the air compressor on with the ON/OFF switch » Fig. 69 ⑧.
- Keep the air compressor running until it reaches 2.0 to 2.5 bar (29-36 psi/200-250 kPa). **A maximum of 8 minutes.**
- Disconnect the air compressor.
- If it does not reach the pressure indicated, unscrew the tyre inflator tube from the valve.
- Move the vehicle 10m so that the sealant is distributed throughout the tyre.

- Screw the compressor tyre inflator into the valve.
- Repeat the inflation process.
- If the indicated pressure still cannot be reached, the tyre is too badly damaged. Stop and request assistance from an authorised technician.
- Disconnect the air compressor. Unscrew the tyre inflator tube from the tyre valve.
- When the tyre pressure is between 2.5 and 2.0 bars, continue driving without exceeding 80 km/h (50 mph).
- Check the pressure again after 10 minutes » page 97.



» in TMS (Tyre Mobility System)* on page 95



» page 95

Changing a wheel

Vehicle tool kit

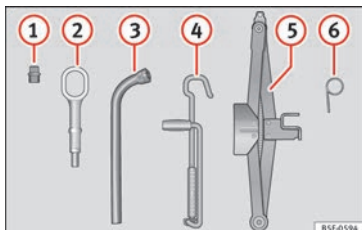


Fig. 70 Underneath the floor panel of the luggage compartment: vehicle tool kit.

- ① An adapter for the anti-theft wheel bolts*
- ② Towline anchorage
- ③ Box spanner for wheel bolts*
- ④ Crank handle for jack
- ⑤ Jack*
- ⑥ Wire hook for pulling off the wheel covers*/wheel bolt cap clip.



» » in What to do first on page 64



» » page 95

Wheel covers*

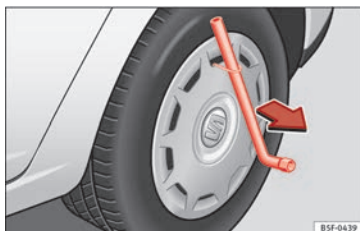


Fig. 71 Remove the wheel cover.

The wheel covers must be removed for access to the wheel bolts.

Removing

- Remove the wheel cover using the wire hook » » **Fig. 71**.
- Hook this into one of the cut-outs of the wheel cover.

Fitting

- Fit the wheel cover onto the wheel rim by pressing it firmly.
- Put pressure on the point of the cut-out for the valve.
- Next fit the rest of the wheel cover.

Wheel bolt caps*



Fig. 72 Wheel: wheel bolts with caps.

Removal

- Fit the plastic clip (vehicle tools) over the cap until it clicks into place » » **Fig. 72**.
- Remove the cap with the plastic clip.

Anti-theft wheel bolts

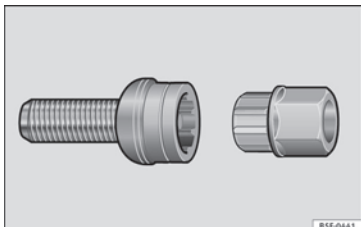


Fig. 73 Anti-theft wheel bolt with cap and adapter.

- Remove the wheel cover* or the cap*.
- Insert the special adapter (vehicle tools) onto the anti-theft wheel bolt and push it on as far as it will go.
- Insert the wheel brace (vehicle tools) onto the adapter as far as it will go.
- Remove the wheel bolt » page 67.

Note

Make a note of the code number of the anti-theft wheel bolt and keep it in a safe place, but not in your vehicle. If you need a new adapter, you can obtain it from the SEAT Official Service, indicating the code number.

Loosening the wheel bolts



Fig. 74 Wheel: loosen the wheel bolts.

- Insert the box spanner (vehicle tools) onto the wheel bolt as far as it will go. An adapter is required to unscrew or tighten the anti-theft wheel bolts » page 67.
- Turn the wheel bolt approximately one turn to the left » Fig. 74 (arrow). To apply the required torque, hold the wheel brace at the end. If it is not possible to loosen a wheel bolt, carefully apply pressure with one foot on the end of the box spanner. Hold on to the vehicle for support and take care not to slip.

WARNING

Slightly loosen the wheel bolts (one turn) before raising the vehicle with the jack*. If not, an accident may occur.

Raising the vehicle

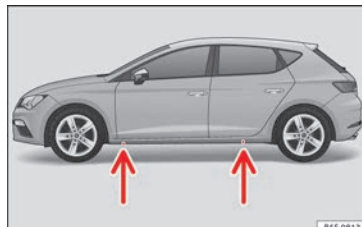


Fig. 75 Crossbar: marks.

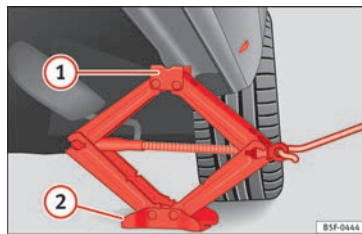


Fig. 76 Strut: mounting the jack on the vehicle.

- Place the jack* (vehicle tools) on firm ground. If necessary use a large, strong board or similar support. If the surface is slippery (for example tiles) place the jack on a rubber mat or similar to prevent it from slipping » ⚠.



• Find the support point on the strut (sunken area) closest to the wheel to be changed
»» **Fig. 75.**

• Turn the jack*, located below the strut support point, to raise it until tab ① »» **Fig. 76** is below the housing provided.

• Align the jack* so that tab ① “grips” onto the housing provided on the strut and the mobile base ② is resting on the ground. The base plate ② should fall vertically with respect to the support point ①.

• Continue turning the jack* until the wheel is slightly lifted off the ground.

WARNING

• **Make sure that the jack* remains stable. If the surface is slippery or soft, the jack* could slip or sink, respectively, with the resultant risk of injury.**

• **Only raise the vehicle with the jack* supplied by the manufacturer. Other vehicles could slip, with the consequent risk of injury.**

• **Only mount the jack* on the support points designed for this purpose on the strut, and always align the jack correctly. If you do not, the jack* could slip as it does not have an adequate grip on the vehicle: risk of injury!**

• **The height of the parked vehicle can change as a result of variations in temperature and loading.**

CAUTION

The vehicle must not be raised on the crossbar. Only place the jack* on the points designed for this purpose on the strut. Otherwise, the vehicle may be damaged.

Removing and fitting a wheel

Change the wheel after loosening the wheel bolts and raising the vehicle with the jack.

Taking off the wheel

- Unscrew the wheel bolts using the box spanner and place them on a clean surface.
- Take off the wheel.

Putting on the spare wheel

When fitting tyres with a compulsory rotation direction, observe the instructions in
»» page 68.

- Mount the wheel.
- Screw on the wheel bolts in position and tighten them loosely with a box spanner.
- Carefully lower the vehicle using the jack*.
- Tighten the wheel bolts in diagonal pairs using the wheel brace.

The wheel bolts should be clean and turn easily. Before fitting the spare wheel, inspect the wheel condition and hub mounting surfa-

ces. These surfaces must be clean before fitting the wheel.

Tyres with compulsory direction of rotation



A directional tread pattern can be identified by the arrows on the sidewall that point in the direction of rotation. Always observe the direction of rotation indicated when fitting the wheel to guarantee optimum properties of this type of tyres with regard to grip, noises, wear and aquaplaning.

If it is absolutely necessary to fit the spare tyre* against the direction of rotation, drive with care as this means the tyre does not offer optimum driving properties. This is of particular importance when the road surface is wet.

To return to directional tread tires, replace the punctured tyre as soon as possible and restore the obligatory direction of rotation of all tyres.

Subsequent work

- *Alloy wheels:* replace the wheel bolt caps.
- *Plate wheels:* replace the wheel hubcap
»» page 66.


- Return all tools to their proper storing location.
- If the replaced wheel does not fit in the spare wheel housing, store it safely in the luggage compartment»»  page 160.
- Check the tyre pressure of the newly mounted tyre as soon as possible.
- In vehicles fitted with a tyre pressure indicator, adjust the pressure and store the reading in the radio/Easy Connect system*»»  page 283.
- Have the tightening torque of the wheel bolts checked as soon as possible with a torque wrench (it should be 120 Nm). Meanwhile, drive carefully.
- Have the flat tyre replaced as quickly as possible.

Snow chains

Use

Snow chains should only be used on the front wheels.

Check that they are correctly seated after driving for a few yards; correct the position if necessary, in accordance with the manufacturer's fitting instructions. Keep your speed below 50 km/h (30 mph).

If there is a danger of being trapped despite having mounted the chains, it is best to disable the driving wheels (ASR) in the ESC»»  page 188, **Switching on/off the ESC and ASR.**

Snow chains will improve *braking ability* as well as *traction* in winter conditions.

For technical reasons snow chains may only be used with the following wheel rim/tyre combination.

195/65 R15	Chains with links of maximum 15 mm
205/55 R16	Chains with links of maximum 15 mm
225/45 R17	Chains with links of maximum 9 mm
225/40 R18	Chains with links of maximum 9 mm

Remove wheel covers and any integral trim ring before fitting snow chains.

Remove the chains when roads are free of snow. Driving characteristics worsen, and the wheels become damaged quickly and may even be rendered unusable.

Emergency towing of the vehicle

Towing




Fig. 77 Right side of the front bumper: towline anchorage screwed in.



Fig. 78 Right side of the rear bumper: towline anchorage screwed in. »

Towline anchorages

Attach the bar or rope to the towline anchorages.

The towline anchorages are located under the floor panel in the luggage compartment, next to the vehicle tools »  page 95.

Screw the towline anchorage into the screw connection » Fig. 77 » Fig. 78 and tighten it with the wheel brace.

Tow rope or tow bar

The tow bar offers increased safety and a lower risk of damage.

The tow rope is recommended when there is no tow bar. It must be elastic so that it does not damage the vehicle.

Notes for the driver of the towing vehicle

- The tow rope must be taut before you drive off.
- Release the clutch very carefully when starting the vehicle (manual gearbox), or accelerate gently (automatic gearbox).

Driving style

Towing requires some experience, especially when using a tow rope. Both drivers should realise how difficult it is to tow a vehicle. Inexperienced drivers should not attempt to tow.

Do not pull too hard with the towing vehicle and take care to avoid jerking the tow rope. When towing on an unpaved road, there is always a risk of overloading and damaging the anchorage points.

Switch on the ignition so that the turn signals, windscreen wipers and windscreen washer can work. Ensure that the steering wheel is unlocked and moves freely.

Place the gear lever in neutral on vehicles with a manual gearbox. With an automatic gearbox, place the lever in **N**.

To brake, press the brake pedal firmly. The brake servo does not work when the engine is switched off.

The power steering only works when the ignition is switched on and the vehicle is moving, provided that the battery is sufficiently charged. Otherwise, it will need more force.

Ensure that the tow rope remains taut at all times.



»  in General information on page 98



» page 98

Tow-starting

If the engine will not start, first try starting it using the battery of another vehicle » page 70. You should only attempt to tow-start a vehicle if charging the battery does not work. This is done by leveraging wheel movement.

When tow-starting a vehicle with a **petrol engine**, do not tow it more than a *short* distance, otherwise unburned fuel can enter the catalytic converter.

- Engage 2nd or 3rd gear before moving off.
- Press the clutch and hold the pedal down.
- Switch the ignition on.
- Once both vehicles are moving, release the clutch.
- As soon as the engine has started, press the clutch and move the gear lever to neutral.

How to jump start

Jump leads

The jump lead must have a sufficient wire cross section.

If the engine fails to start because of a discharged battery, the battery can be connected to the battery of another vehicle to start the engine.

Jump leads must comply with standard **DIN 72553** (see cable manufacturer's instructions). The wire cross section must be at least 25 mm² for petrol engines and at least 35 mm² for diesel engines.

Note

- The vehicles must not touch each other, otherwise electricity could flow as soon as the positive terminals are connected.
- The discharged battery must be properly connected to the on-board network.

How to jump start: description

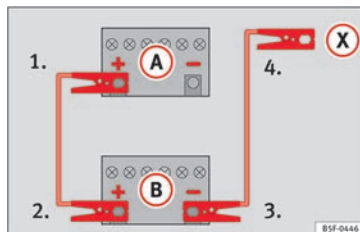


Fig. 79 Diagram of connections for vehicles without Start Stop system

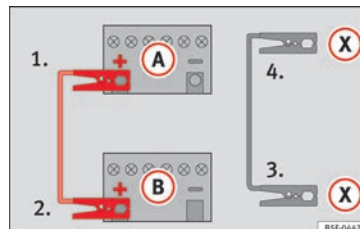


Fig. 80 Diagram of connections for vehicles with Start Stop system

Jump lead terminal connections

1. Switch off the ignition of both vehicles » **⚠**.
2. Connect one end of the **red** jump lead to the positive **+** terminal of the vehicle with the flat battery **(A)** » **Fig. 79**.
3. Connect the other end of the **red** jump lead to the positive terminal **+** in the vehicle providing assistance **(B)**.
- 4a. *For vehicles without Start-Stop system:* connect one end of the **black** jump lead to the negative terminal **-** of the vehicle providing the current **(B)** » **Fig. 79**.
- 4b. *For vehicles with Start-Stop system:* connect one end of the **black** jump lead **(X)** to a suitable ground terminal, to a solid piece of metal in the engine block, or to the engine block itself » **Fig. 80**.

5. Connect the other end of the **black** jump lead **(X)** to a solid metal component bolted to the engine block or to the engine block itself of the vehicle with the flat battery. Do not connect it to a point near the battery **(A)**.
6. Position the leads in such a way that they cannot come into contact with any moving parts in the engine compartment.

Starting

7. Start the engine of the vehicle with the boosting battery and let it run at idling speed.
8. Start the engine of the vehicle with the flat battery and wait for 2 or 3 minutes until the engine is running.


Removing the jump leads

9. Before you remove the jump leads, switch off the dipped beam headlights if they are switched on.
10. Turn on the heater blower and heated rear window in the vehicle with the flat battery. This helps minimise voltage peaks which are generated when the leads are disconnected.
11. When the engine is running, disconnect the leads in reverse order to the details given above. »

Make sure the battery clamps have sufficient metal-to-metal contact with the battery terminals.

If the engine fails to start after about 10 seconds, switch off the starter and try again after about 1 minute.

WARNING

- Please note the safety warnings referring to working in the engine compartment
»»  page 270.
- The battery providing assistance must have the same voltage as the flat battery (12V) and approximately the same capacity (see imprint on battery). Failure to comply could result in an explosion.
- Never use jump leads when one of the batteries is frozen. Danger of explosion! Even after the battery has thawed, battery acid could leak and cause chemical burns. If a battery freezes, it should be replaced.
- Keep sparks, flames and lighted cigarettes away from batteries, danger of explosion. Failure to comply could result in an explosion.
- Observe the instructions provided by the manufacturer of the jump leads.
- Do not connect the negative cable from the other vehicle directly to the negative terminal of the flat battery. The gas emitted from the battery could be ignited by sparks. Danger of explosion.

- Never attach the negative cable to fuel system components or the brake lines in the other vehicle.
- The non-insulated parts of the battery clamps must not be allowed to touch. The jump lead attached to the positive battery terminal must not touch metal parts of the vehicle, this can cause a short circuit.
- Position the leads in such a way that they cannot come into contact with any moving parts in the engine compartment.
- Do not lean on the batteries. This could result in chemical burns.

Note

The vehicles must not touch each other, otherwise electricity could flow as soon as the positive terminals are connected.

Changing the wiper blades

Windscreen wipers service position

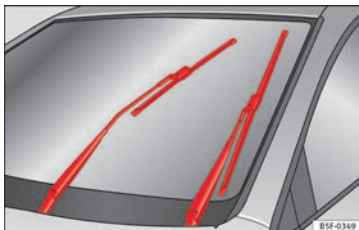



Fig. 81 Wipers in service position.

The wiper arms can be raised when the wipers are in service position »» **Fig. 81**.

- Close the bonnet »»  page 270.
- Switch the ignition on and off.
- Press the windscreen wiper lever downwards briefly **4** »» page 32.

Before driving, always lower the wiper arms. Using the windscreen wiper lever, the windscreen wiper arms return to their initial position.



»» page 97

Changing the windscreen and rear window wiper blades

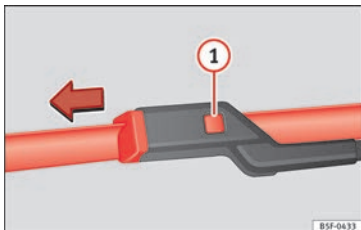


Fig. 82 Changing the windscreen wiper blades

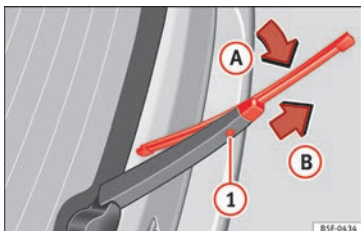


Fig. 83 Changing the rear wiper blade

Raising and lowering windscreen wiper arms

- Place the windscreen wipers in the service position »» page 72.
- Grip the wiper arms **only** by the blade's fastening point.

Cleaning windscreen wiper blades

- Raise the wiper arms.
- Use a soft cloth to remove dust and dirt from the windscreen wiper blades.
- If the blades are very dirty, a sponge or damp cloth may be used »» ❶ in Changing the windscreen and rear window wiper blades on page 98.

Changing the windscreen wiper blades

- Lift and unfold the wiper arms.
- Press and hold release button »» Fig. 82 ❶ and pull gently on the wiper blade in the direction of the arrow.
- Fit a new wiper blade of the **same length and design** on to the wiper arm and hook it into place.
- Rest the wiper arms back onto the windscreen.

Changing the rear wiper blade

- Raising/lowering the wiper arm.
- Turn the blade slightly »» Fig. 83 (arrow A).
- Hold down the release button ❶ while gently pulling the blade in the direction of arrow B.
- Insert a new blade of the **same length and type** in the rear wiper arm in the opposite direction to the arrow B and hook into place button ❶.

- Replace the wiper arm on the rear window.



»» ⚠ in Changing the windscreen and rear window wiper blades on page 98



»» page 97

Safety

Safe driving

Safety first!

WARNING

• This manual contains important information about the operation of the vehicle, both for the driver and the passengers. The other sections of the on-board documentation also contain further information that you should be aware of for your own safety and for the safety of your passengers.

• Ensure that the on-board documentation is kept in the vehicle at all times. This is especially important when lending or selling the vehicle to another person.

Advice about driving

Before setting off


For your own safety and the safety of your passengers, always note the following points before every trip:

- Make sure that the vehicle's lights and turn signals are working properly.
- Check tyre pressure.

- Ensure that all windows provide a clear and good view of the surroundings.
- Make sure all luggage is secured »» page 160.
- Make sure that no objects can interfere with the pedals.
- Adjust front seat, head restraint and mirrors properly according to your size.
- Ensure that the passengers in the rear seats always have the head restraints in the in-use position »» page 78.
- Instruct passengers to adjust the head restraints according to their height.
- Protect children with appropriate child seats and properly applied seat belts »» page 91.
- Assume the correct sitting position. Instruct your passengers also to assume a proper sitting position »» page 75.
- Fasten your seat belt securely. Instruct your passengers also to fasten their seat belts properly »» page 80.

What affects driving safety?

As a driver, you are responsible for yourself and your passengers. When your concentration or driving safety is affected by any cir-

cumstance, you endanger yourself as well as others on the road »» , for this reason:

- Always pay attention to traffic and do not get distracted by passengers or telephone calls.
- Never drive when your driving ability is impaired (e.g. by medication, alcohol, drugs).
- Observe traffic laws and speed limits.
- Always reduce your speed as appropriate for road, traffic and weather conditions.
- When travelling long distances, take breaks regularly - at least every two hours.
- If possible, avoid driving when you are tired or stressed.

WARNING

When driving safety is impaired during a trip, the risk of injury and accidents increases.

Safety equipment

Never put your safety or the safety of your passengers in danger. In the event of an accident, the safety equipment may reduce the risk of injury. The following points cover part of the safety equipment in your SEAT:

- three-point seat belts,
- belt tension limiters for the front and rear side seats,

- Belt tensioners for the front seats,
- front airbags,
- knee airbags,
- side airbags in the front seat backrests,
- Side airbags in the rear seat backrests*,
- head-protection airbags,
- “ISOFIX” anchor points for child seats in the rear side seats with the “ISOFIX” system,
- height-adjustable front head restraints,
- rear head restraints with in-use position and non-use position,
- adjustable steering column.

The safety equipment mentioned above works together to provide you and your passengers with the best possible protection in the event of an accident. However, these safety systems can only be effective if you and your passengers are sitting in a correct position and use this equipment properly.

Safety is everyone's business!

Correct position of the vehicle occupants

Correct sitting position for the driver

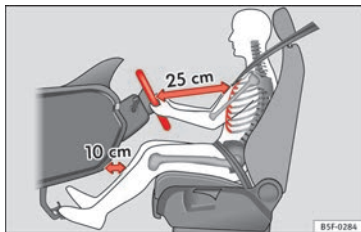


Fig. 84 The proper distance between driver and steering wheel.

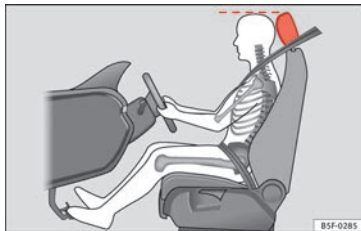


Fig. 85 Correct head restraint position for the driver.

For your own safety and to reduce the risk of injury in the event of an accident, we recom-

mend the following adjustments for the driver:

- Adjust the steering wheel so that there is a distance of at least 25 cm between the steering wheel and the centre of your chest » **Fig. 84.**
- Move the driver's seat forwards or backwards so that you are able to press the accelerator, brake and clutch pedals to the floor with your knees still slightly angled » **△.**
- Ensure that you can reach the highest point of the steering wheel.
- Adjust the head restraint so that its upper edge is at the same level as the top of your head, or as close as possible to the same level as the top of your head » **Fig. 85.**
- Move the seat backrest to an upright position so that your back rests completely against it.
- Fasten your seat belt securely » **page 80.**
- Keep both feet in the footwell so that you have the vehicle under control at all times.

Adjustment of the driver's seat » **page 152.**

△ WARNING

- **An incorrect sitting position of the driver can lead to severe injuries.**

- Adjust the driver's seat so that there is at least 25 cm distance between the centre of the chest and the centre of the steering wheel » Fig. 84. If you are sitting closer than 25 cm, the airbag system cannot protect you properly.
- If your physical constitution prevents you from maintaining the minimum distance of 25 cm, contact a specialised workshop. The workshop will help you decide if special specific modifications are necessary.
- When driving, always hold the steering wheel with both hands on the outside of the ring at the 9 o'clock and 3 o'clock positions. This reduces the risk of injury when the driver airbag is triggered.
- Never hold the steering wheel at the 12 o'clock position, or in any other manner (e.g. in the centre of the steering wheel). In such cases, if the airbag is triggered, you may sustain injuries to the arms, hands and head.
- To reduce the risk of injury to the driver during sudden braking manoeuvres or an accident, never drive with the backrest tilted far back! The airbag system and seat belts can only provide optimal protection when the backrest is in an upright position and the driver is wearing his or her seat belt correctly.
- Adjust the head restraint properly to achieve optimal protection.

Adjusting the steering wheel position

Read the additional information carefully


»  page 21.

WARNING

- Never adjust the position of the steering wheel when the vehicle is moving, as this could cause an accident.
- Move the lever up firmly so the steering wheel position does not accidentally change during driving. risk of accident!
- Make sure you are capable of reaching and firmly holding the upper part of the steering wheel: risk of accident!
- If you adjust the steering wheel so that it points towards your face, the driver airbag will not protect you properly in the event of an accident. Make sure that the steering wheel points towards your chest.

Correct position for the front passenger

For your own safety and to reduce the risk of injury in the event of an accident, we recommend the following adjustments for the front passenger:

- Move the front passenger seat back as far as possible » .

- Move the seat backrest to an upright position so that your back rests completely against it.
- Adjust the head restraint so that its upper edge is at the same level as the top of your head, or as close as possible to the same level as the top of your head » page 78.
- Always keep both feet in the footwell in front of the front passenger seat.
- Fasten your seat belt securely » page 80.

It is possible to deactivate the front passenger airbag in **exceptional circumstances** » page 90.

Adjusting the front passenger seat » page 152.

WARNING

- An incorrect sitting position of the front passenger can lead to severe injuries.
- Adjust the front passenger seat so that there is at least 25 cm between your chest and the dash panel. If you are sitting closer than 25 cm, the airbag system cannot protect you properly.
- If your physical constitution prevents you from maintaining the minimum distance of 25 cm, contact a specialised workshop. The workshop will help you decide if special specific modifications are necessary.

- Always keep your feet in the footwell when the vehicle is moving; never rest them on the dash panel, out the window or on the seat. An incorrect sitting position exposes you to an increased risk of injury in case of a sudden braking or an accident. If the airbag is triggered, you could sustain severe injuries due to an incorrect sitting position.

- To reduce the risk of injury to the front passenger in events such as sudden braking manoeuvres or an accident, never travel with the backrest tilted far back! The airbag system and seat belts can only provide optimal protection when the backrest is in an upright position and the front passenger is wearing his or her seat belt properly. The further the seat backrests are tilted to the rear, the greater the risk of injury due to incorrect positioning of the belt web or to the incorrect sitting position!

- Adjust the head restraint correctly in order to achieve maximum protection.

Correct sitting position for rear seat passengers

To reduce the risk of injury in the event of a sudden braking manoeuvre or an accident, passengers on the rear seat bench must consider the following:

- Sit up straight.
- Adjust the head restraint to the correct position » page 78.


- Always keep both feet in the footwell in front of the rear seat.
- Fasten your seat belt securely » page 80.
- Use an appropriate child restraint system when you take children in the vehicle » page 91.

WARNING

- If the passengers in the rear seats are not sitting properly, they could sustain severe injuries.
- Adjust the head restraint correctly in order to achieve maximum protection.
- Seat belts can only provide optimal protection when seat backrests are in an upright position and the vehicle occupants are wearing their seat belts correctly. If passengers in the rear seats are not sitting in an upright position, the risk of injury due to incorrect positioning of the seat belt increases.

Examples of incorrect sitting positions

Seat belts can provide optimal protection only when the belt webs are properly positioned. Incorrect sitting positions substantially reduce the protective function of seat belts and increase the risk of injury due to incorrect seat belt position. As the driver, you are responsible for all passengers, especially children.

- Never allow anyone to assume an incorrect sitting position in the vehicle while travelling » .

The following list contains examples of sitting positions that could be dangerous for all vehicle occupants. The list is not complete, but we would like to make you aware of this issue.

Therefore, whenever the vehicle is in motion:

- Never stand in the vehicle.
- Never stand on the seats.
- Never kneel on the seats.
- Never tilt your seat backrest far to the rear.
- Never lean against the dash panel.
- Never lie on the rear bench.
- Never sit on the front edge of a seat.
- Never sit sideways.
- Never lean out of a window.
- Never put your feet out of a window.
- Never put your feet on the dash panel.
- Never put your feet on the surface of a seat.
- Do not allow anyone to travel in the footwell.
- Never travel without wearing the seat belt.
- Do not allow anyone to travel in the luggage compartment.

»

⚠ WARNING

- Any incorrect sitting position increases the risk of severe injuries. Sitting in an incorrect position exposes the vehicle occupants to severe injuries if airbags are triggered, by striking a vehicle occupant who has assumed an incorrect sitting position.
- Before the vehicle moves, assume the proper sitting position and maintain it throughout the trip. Before every trip, instruct your passengers to sit properly and to stay in this position during the trip » page 75, Correct position of the vehicle occupants.

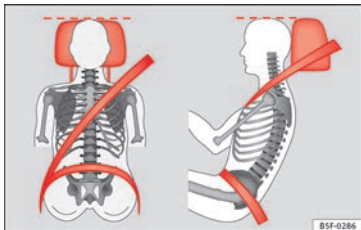

Correct adjustment of front head restraints

Fig. 86 Correctly adjusted head restraint as viewed from the front and the side.

Read the additional information carefully »  page 20.

Properly adjusted head restraints are an important part of passenger protection and can reduce the risk of injuries in most accident situations.

- Adjust the head restraint so that its upper edge is, as far as possible, at the same level as the top of your head, or at the very least, at eye level » **Fig. 86**.

⚠ WARNING

- Travelling with the head restraints removed or improperly adjusted increases the risk of severe injuries. An improper adjustment of the head restraints may cause death in an accident and increase the risk of suffering injuries during abrupt braking actions or unexpected manoeuvres.
- The head restraints must always be adjusted according to the height of the passenger.

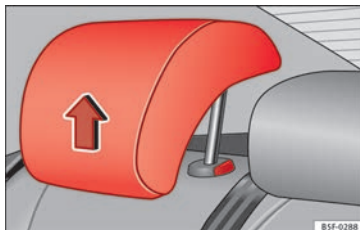
Correct adjustment of rear head restraints

Fig. 87 Head restraints in the correct position.



Fig. 88 Head restraint position warning label.

Properly adjusted head restraints are an important part of the passenger protection and can reduce the risk of injuries in most accident situations

Rear head restraints

- The rear head restraints have 2 positions: **use** and **non-use**.
- One position for **use** (head restraint raised)
 - » **Fig. 87**. In this position, the head restraints are used normally, protecting passengers along with the rear seat belts.
- And one position for **non-use** (head restraint lowered).
- To fit the head restraints in position for use, pull on the edges with both hands in the direction of the arrow.

WARNING


- **Under no circumstances should the rear passengers travel while the head restraints are in the non-use position. See the warning label located on the rear side fixed window » Fig. 88.**
- **Do not swap the centre rear head restraint with either of the outer seat rear head restraints. Risk of injury in case of an accident!**

CAUTION

Note the instructions on the adjustment of the head restraints » page 153.

Pedal area

Pedals

- Ensure that you can always press the accelerator, brake and clutch pedals unimpaird to the floor.
- Ensure that the pedals can return unimpaird to their initial positions.
- Ensure that the floor mats are securely fastened during the trip and do not obstruct the pedals » .

Only use floor mats which leave the pedals clear and which are secured to prevent them from slipping. You can obtain suitable floor mats from a specialised dealership. Fasteners* for floor mats are fitted in the footwells.

If a brake circuit fails, the brake pedal must be pressed down thoroughly in order to stop the vehicle.

Wear suitable footwear

Always wear shoes which support your feet properly and give you a good feeling for the pedals.

WARNING

- **Restricting pedal operation can lead to critical situations while driving.**

• **Never lay or fit floor mats or other floor coverings over the original floor mats. This would reduce the pedal area and could obstruct the pedals. Risk of accident.**

• **Never place objects in the driver footwell. An object could move into the pedal area and impair pedal operation. In the event of a sudden driving or braking manoeuvre, you will not be able to operate the brake, clutch or accelerator pedal. Risk of accident!**

Seat belts

Why wear a seat belt

Number of seats

Your vehicle has **five** seats, two in the front and three in the rear. Each seat is equipped with a three-point seat belt.

In some versions, your vehicle is approved **only** for four seats. Two front seats and two rear seats.

WARNING

- Never transport more than the permitted amount of people in your vehicle.
- Every vehicle occupant must properly fasten and wear the seat belt belonging to his or her seat. Children must be protected with an appropriate child restraint system.

Seat belt control lamp*




Fig. 89 Instrument panel: right rear seat occupied and corresponding seat belt fastened display.


The control lamp illuminates to remind the driver to fasten his seat belt.


Before starting the vehicle:

- Fasten your seat belt securely.
- Instruct your passengers to fasten their seat belts properly before driving off.
- Protect children by using a child seat according to the child's height and weight.



When the ignition is switched on, the control lamp  in the instrument panel lights up (depending on the model version) if the driver or passenger have not fastened their seat belts.

When starting to drive, if the vehicle's speed surpasses approx. 25 km/h (15 mph) and the seat belts are not fastened or are unfastened

during the drive, a warning sound will be heard for a few seconds. The warning light will also flash .

The lamp  goes out when the driver and passenger seat belts are fastened with the ignition switched on.

Rear seat belts fastened display*

Depending on the model version, when the ignition is switched on, the seat belt status display  **Fig. 89** on the instrument panel informs the driver whether the passengers in the rear seats have fastened their seat belts. The  symbol indicates that the passenger in this seat has fastened "his or her" seat belt.

When a seat belt in the rear seats is fastened or unfastened, the seat belt status is displayed for approximately 30 seconds. The indication can be hidden by pressing the **(0.0/SET)** button on the dash panel.

The seat belt status flashes for a maximum of 30 seconds when a seat belt in the rear seats is unfastened while the vehicle is in motion. An audible warning will also be heard if the vehicle is travelling at over 25 km/h (15 mph).

The protective function of seat belts



Fig. 90 Drivers with properly worn seat belts will not be thrown forward in the event of sudden braking.

Properly worn seat belts hold the occupants in the proper position. They also help prevent uncontrolled movements that may result in serious injury and reduce the risk of being thrown out of the vehicle in case of an accident.

Vehicle occupants wearing their seat belts correctly benefit greatly from the ability of the belts to absorb kinetic energy. In addition, the front part of your vehicle and other passive safety features (such as the airbag system) are designed to absorb the kinetic energy released in a collision. Taken together, all these features reduce the releasing kinetic energy and consequently, the risk of injury. This is why it is so important to fasten seat belts before every trip, even when "just driving around the corner".

Ensure that your passengers wear their seat belts as well. Accident statistics have shown that wearing seat belts is an effective means of substantially reducing the risk of injury and improving the chances of survival when involved in a serious accident. Furthermore, properly worn seat belts improve the protection provided by airbags in the event of an accident. For this reason, wearing a seat belt is required by law in most countries.

Although your vehicle is equipped with airbags, the seat belts must be fastened and worn. The front airbags, for example, are only triggered in some cases of head-on collision. The front airbags will not be triggered during minor frontal or side collisions, rear-end collisions, rollovers or accidents in which the airbag trigger threshold value in the control unit is not exceeded.

Therefore, you should always wear your seat belt and ensure that all vehicle occupants have fastened their seat belts properly before you drive off!

Important safety instructions for the use of seat belts

- Always wear the seat belt as described in this section.
- Ensure that the seat belts can be fastened at all times and are not damaged.

⚠ WARNING

- If seat belts are worn incorrectly or not at all, the risk of severe injuries increases. The optimal protection from seat belts can be achieved only if you use them properly.
- Fasten your seat belt before every trip - even when driving in town. Other vehicle occupants must also wear the seat belts at all times, otherwise they run the risk of being injured.
- The seat belt cannot offer its full protection if the seat belt is not positioned correctly.
- Never allow two passengers (even children) to share the same seat belt.
- Always keep both feet in the footwell in front of your seat as long as the vehicle is in motion.
- Never unbuckle a seat belt while the vehicle is in motion. Risk of fatal injury.
- The seat belt must never be twisted while it is being worn.
- The seat belt should never lie on hard or fragile objects (such as glasses or pens, etc.) because this can cause injuries.
- Do not allow the seat belt to be damaged or jammed, or to rub on any sharp edges.
- Never wear the seat belt under the arm or in any other incorrect position.
- Bulky and unfastened clothing (such as an overcoat over a sweater) impairs the proper fit and function of the seat belts, reducing their capacity to protect.

- The slot in the seat belt buckle must not be blocked with paper or other objects, as this can prevent the latch plate from engaging securely.
- Never use seat belt clips, fastening rings or similar items to alter the position of the belt webbing.
- Frayed or torn seat belts or damage to the connections, belt retractors or parts of the buckle could cause severe injuries in the event of an accident. Therefore, you must check the condition of all seat belts at regular intervals.
- Seat belts which have been worn in an accident and have been stretched must be replaced by a specialised workshop. Renewal may be necessary even if there is no apparent damage. The belt anchorage should also be checked.
- Do not attempt to repair a damaged seat belt yourself. The seat belts must not be removed or modified in any way.
- The belts must be kept clean, otherwise the retractors may not work properly.

Head-on collisions and the laws of physics

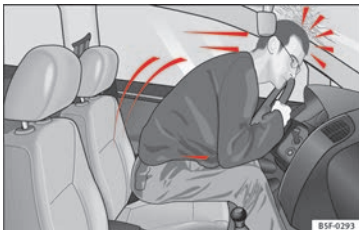


Fig. 91 A driver not wearing a seat belt is thrown forward violently.



Fig. 92 The unbelted passenger in the rear seat is thrown forward violently, hitting the driver who is wearing a seat belt.

It is easy to explain how the laws of physics work in the case of a head-on collision: when a vehicle starts moving, a type of energy

called “kinetic energy” is created both in the passengers and inside the vehicle.

The amount of “kinetic energy” depends on the speed of the vehicle and on the weight of the vehicle and of its passengers. The higher they are, the more energy there is to be “absorbed” in the event of an accident.

The most significant factor, however, is the speed of the vehicle. If the speed doubles from 25 km/h (15 mph) to 50 km/h (30 mph), for example, the corresponding kinetic energy is multiplied by four.

Given that the passengers of the vehicle in our example do not have their seat belts fastened, in the event of a collision the entire amount of the passengers' kinetic energy will be only absorbed by the mentioned impact.

Even at speeds of 30 km/h (19 mph) to 50 km/h (30 mph), the forces acting on bodies in a collision can easily exceed one tonne (1000 kg). At greater speed these forces are even higher.

Vehicle occupants not wearing seat belts are not “attached” to the vehicle. In a head-on collision, they will move forward at the same speed their vehicle was travelling just before the impact. This example applies not only to head-on collisions, but to all accidents and collisions.

Even at low speeds the forces acting on the body in a collision are so great that it is not

possible to brace oneself with one's hands. In a frontal collision, unbelted passengers are thrown forward and will make violent contact with the steering wheel, dash panel, windscreen or whatever else is in the way »» Fig. 91.

It is also important for rear passengers to wear seat belts properly, as they could otherwise be thrown forward violently through the vehicle interior in an accident. Passengers in the rear seats who do not use seat belts endanger not only themselves but also the front occupants »» Fig. 92.

How to properly adjust your seatbelt

Fastening and unfastening your seat belt

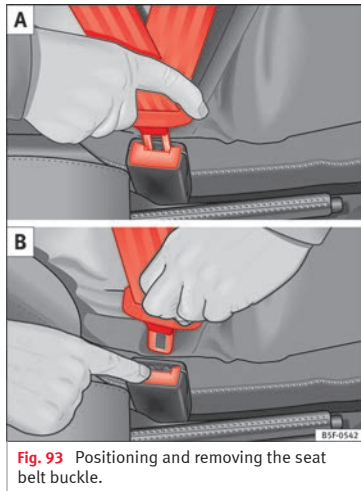



Fig. 93 Positioning and removing the seat belt buckle.



Fig. 94 Position of seat belt during pregnancy.

Read the additional information carefully »»  page 20.

Fasten your seat belt


The seat belt cannot offer its full protection if the seat belt is not positioned correctly.

- Adjust the seat and head restraint correctly.
- To fasten the belt, take hold of the latch plate and pull it slowly across your chest and lap.
- Insert the latch plate into the buckle for the appropriate seat and push it down until it is securely locked with an audible click »» Fig. 93 A.
- Pull the belt to ensure that the latch plate is securely engaged in the buckle. »»

The seat belts are equipped with an automatic retractor on the shoulder strap. Full freedom of movement is permitted when the shoulder belt is pulled slowly. However, during sudden braking, during travel in steep areas or bends and during acceleration, the automatic retractor on the shoulder belt is locked.

The automatic belt retractors on the front seats are fitted with seat belt tensioners
» page 84.

Releasing the seat belt

- Press the red button on the belt buckle
» Fig. 93 B. The latch plate is released and springs out » .
- Guide the belt back by hand so that it rolls up easily and the trim is not damaged.

Positioning seat belts

Seat belts offer their maximum protection only when they are properly positioned.


WARNING

- **The seat belts offer best protection only when the backrests are in an upright position and the seat belts have been fastened properly.**
- **Never put the latch plate in the buckle of another seat. If you do this, the seat belt will not protect you properly and the risk of injury is increased.**

- **Never unbuckle a seat belt while the vehicle is in motion. If you do, you increase the risk of sustaining severe or fatal injuries.**
- **An incorrectly worn seat belt can cause severe injuries in the event of an accident.**
- **For pregnant women, the lap part of the seat belt must lie as low as possible over the pelvis, never across the stomach, and always lie flat so that no pressure is exerted on the abdomen » Fig. 94.**
- **Always engage the retractor lock when you are securing a child seat in group 0, 0+ or 1 » page 91.**
- **Read and observe the warnings » page 81.**

Seat belt tensioners

How the seat belt tensioner works

Read the additional information carefully
»  page 21.

The seat belts for the occupants in the front seats are equipped with belt tensioners. Sensors will trigger the belt tensioners only during severe head-on, lateral and rear-end collisions and only if the seat belt is worn. This retracts and tightens the seat belts, reducing the forward motion of the occupants.

The belt tensioners will not be triggered in the event of minor collisions, if the vehicle

overturns, or in accidents where no major forces act on the vehicle.

Note

- **If the seat belt tensioners are triggered, a fine dust is produced. This is normal and it is not an indication of fire in the vehicle.**
- **The relevant safety requirements must be observed when the vehicle or components of the system are scrapped. Specialised workshops are familiar with these regulations, which are also available to you.**

Maintenance and disposal of belt tensioners

The belt tensioners are components of the seat belts that are installed in the seats of your vehicle. If you work on the belt tensioners or remove and install parts of the system when performing other repair work, the seat belt may be damaged. The consequence may be that, in the event of an accident, the belt tensioners function incorrectly or may not function at all.

So that the effectiveness of the seat belt tensioner is not reduced and that removed parts do not cause any injuries or environmental pollution, regulations, which are known to the specialised workshops, must be observed.

⚠ WARNING

- Improper use or repairs not carried out by qualified mechanics increase the risk of severe or fatal injuries. The belt tensioners may fail to trigger or may trigger in the wrong circumstances.
- Never attempt to repair, adjust, remove or install parts of the belt tensioners or seat belts.
- The seat belt tensioner, seat belt and automatic retractor cannot be repaired.
- Any work on the belt tensioners and seat belts, including the removal and refitting of system parts in conjunction with other repair work, must be performed by a specialised workshop only.
- The belt tensioners will only provide protection for one accident and must be changed if they have been activated.

Airbag system

Brief introduction

Why is it so important to wear a seat belt and to sit correctly?

For the inflating airbags to achieve the best protection, the seat belt must always be worn properly and the correct sitting position must be assumed.

The airbag system is not a substitute for seat belts, but it is an integral part of the vehicle's overall passive safety system. Please bear in mind that the airbag system can only work effectively when the vehicle occupants are wearing their seat belts correctly and have adjusted the head restraints properly. Therefore, it is most important to properly wear the seat belts at all times, not only because this is required by law in most countries, but also for your safety »» page 80, **Why wear a seat belt.**

The airbag inflates in a matter of seconds, so if you are not properly seated when the airbag is triggered, you may sustain fatal injuries. Therefore, it is essential that all vehicle occupants assume a correct sitting position while travelling.

Sharp braking before an accident may cause a passenger not wearing a seat belt to be thrown forward into the area of the deploying

airbag. In this case, the inflating airbag may inflict critical or fatal injuries on the occupant. This also applies to children.

Always maintain the greatest possible distance between yourself and the front airbag. This way, the front airbags can completely deploy when triggered, providing their maximum protection.

The most important factors that will trigger an airbag are: the type of accident, the angle of collision and the speed of the vehicle.

Whether or not the airbags are triggered depends primarily on the vehicle deceleration rate resulting from the collision and detected by the control unit. If the vehicle deceleration occurring during the collision and measured by the control unit remains below the specified reference values, the front, side and/or curtain airbags will not be triggered. Take into account that the visible damage in a vehicle involved in an accident, no matter how serious, is not a determining factor for the airbags to have been triggered.

⚠ WARNING


- **Wearing the seat belt incorrectly or assuming an incorrect sitting position can lead to critical or fatal injuries.**
- **All vehicle occupants, including children, who are not properly belted can sustain critical or fatal injuries if the airbag is triggered. Children up to 12 years old should always**



travel on the rear seat. Never transport children in the vehicle if they are not restrained or the restraint system is not appropriate for their age, size or weight.

- If you are not wearing a seat belt, or if you lean forward or to the side while travelling or assume an incorrect sitting position, there is a substantially increased risk of injury. This increased risk of injury will be further increased if you are struck by an inflating airbag.
- To reduce the risk of injury from an inflating airbag, always wear the seat belt properly » page 80.
- Always adjust the front seats properly.


Description of airbag system

Read the additional information carefully »  page 22.


The airbag system is not a substitute for the seat belts. The airbag system offers additional protection for the driver and passenger in combination with the seat belts.

The airbag system comprises the following modules (as per vehicle equipment):

- Electronic control unit
- Front airbags for driver and passenger
- Knee airbag for the driver
- Side airbags

- Head airbag
- Airbag control lamp  on the instrument panel » page 90
- Key-operated switch for front passenger airbag
- Control lamp to disconnect/connect the front airbag.

The airbag system operation is monitored electronically. The airbag control lamp will illuminate for a few seconds every time the ignition is switched on (self-diagnosis).

There is a fault in the system if the control lamp :

- does not light up when the ignition is switched on » page 90,
- turns off after 4 seconds after the ignition is switched on,
- turns off and then lights up again after the ignition is switched on,
- illuminates or flashes while the vehicle is moving.

The airbag system is not triggered if:

- the ignition is switched off
- there is a minor frontal collision
- there is a minor side collision
- there is a rear-end collision
- the vehicle turns over.

WARNING

- The seat belts and airbags can only provide maximum protection if the occupants are seated correctly » page 75, Correct position of the vehicle occupants.
- If a fault has occurred in the airbag system, have the system checked immediately by a specialised workshop. Otherwise there is a danger that during a collision, the system may fail to trigger, or not trigger correctly.

Airbag activation

The airbags deploy extremely rapidly, within thousandths of a second, to provide additional protection in the event of an accident. A fine dust may develop when the airbag deploys. This is normal and it is not an indication of fire in the vehicle.

The airbag system is only ready to function when the ignition is on.

In special accidents instances, several airbags may activate at the same time.

In the event of minor head-on and side collisions, rear-end collisions, overturning or roll-over of the vehicle, airbags **do not activate**.

Activation factors

The conditions that lead to the airbag system activating in each situation cannot be generalised. Some factors play an important role,

such as the properties of the object the vehicle hits (hard/soft), angle of impact, vehicle speed, etc.

Deceleration trajectory is key for airbag activation.

The control unit analyses the collision trajectory and activates the respective restraint system.

If the deceleration rate is below the predefined reference value in the control unit the airbags will not be triggered, even though the accident may cause extensive damage to the car.

The following airbags are triggered in serious head-on collisions:

- Driver airbag.
- Front passenger front airbag
- Knee airbag for the driver.

The following airbags are triggered in serious side-on collisions:


- Front side airbag on the side of the accident.
- Rear side airbag on the side of the accident.
- Curtain (head) airbag on the side of the accident.

In an accident with airbag activation:

- the interior lights switch on (if the interior light switch is in the courtesy light position);
- the hazard warning lights switch on;
- all doors are unlocked;
- the fuel supply to the engine is cut.

Safety instructions about airbags


Front airbags

Read the additional information carefully »  page 22.

WARNING

- The deployment space between the front passengers and the airbags must not in any case be occupied by other passenger, pets and objects.
- The airbags provide protection for just one accident; replace them once they have deployed.
- It is also important not to attach any objects such as cup holders or telephone mountings to the surfaces covering the airbag units.
- Do not attempt to modify components of the airbag system in any way.


Knee airbag*

Read the additional information carefully »  page 23.

WARNING

- The knee airbag is deployed in front of the driver's knees. Always keep the deployment areas of the knee airbags free.
- Never not fix objects to the cover or in the deployment area of the knee airbag.
- Adjust the driver's seat so that there is a distance of at least 10 cm (4 inches) between your knees and the location of the this airbag. If your physical constitution prevents you from meeting these requirements, make sure you contact a specialised workshop.

Side airbags*

Read the additional information carefully »  page 24.

WARNING

- If you do not wear a seat belt, if you lean forward, or are not seated correctly while the vehicle is in motion, you are at a greater risk of injury if the side airbag system is triggered in an accident.
- In order for the side airbags to provide their maximum protection, the prescribed sitting »

position must always be maintained with seat belts fastened while travelling.

- In a side-on collision the side airbags will not work if the sensors do not correctly measure the pressure increase on the interior of the doors, due to air escaping through the areas with holes or openings in the door panel.
- Never drive if the interior door panels have been removed or if the panels have not been correctly fitted.
- Never drive the vehicle if the loudspeakers in the door panels have been removed, unless the holes left by the loudspeakers have been closed properly.
- Always check that the openings are closed or covered if loudspeakers or other equipment are fitted inside the door panels.
- Occupants of the outer seats must never carry any objects or pets in the deployment space between them and the airbags, or allow children or other passengers to travel in this position. It is also important not to attach any accessories (such as cup holders) to the doors. This would impair the protection offered by the side airbags.
- The built-in coat hooks should be used only for lightweight clothing. Do not leave any heavy or sharp-edged objects in the pockets.
- Great forces, such as hard blows or kicks, must not be exerted upon the backrest bolster because the system may be damaged. In this case, the side airbags would not be triggered.

- Under no circumstances should protective covers be fitted over seats with side airbags unless the covers have been approved for use in your vehicle. Because the airbag deploys from the side of the backrest, the use of conventional seat covers would obstruct the side airbag, seriously reducing the airbag's effectiveness.
- Any damage to the original seat upholstery or around the seams of the side airbag units must be repaired immediately by a specialised workshop.
- The airbags provide protection for just one accident; replace them once they have deployed.
- Any work on the side airbag system or removal and installation of the airbag components for other repairs (such as removal of the front seat) should only be performed by a specialised workshop. Otherwise, faults may occur during the airbag system operation.
- Do not attempt to modify components of the airbag system in any way.

Head-protection airbags*

Read the additional information carefully

»  page 24.

WARNING

- In order for the head-protection airbags to provide their maximum protection, the pre-

scribed sitting position must always be maintained with seat belts fastened while travelling.

- For safety reasons, the curtain airbag must be disabled in those vehicles fitted with a screen dividing the interior of the vehicle. See your technical service to make this adjustment.
- There must be no other persons, animals or objects between the occupants of the outer seats and the deployment space of the head-protection airbags so that the head-protection airbag can deploy completely without restriction and provide the greatest possible protection. Therefore, sun blinds which have not been expressly approved for use in your vehicle may not be attached to the side windows
- The built-in coat hooks should be used only for lightweight clothing. Do not leave any heavy or sharp-edged objects in the pockets. Please, do not hang the clothes on coat hangers.
- The airbags provide protection for just one accident; replace them once they have deployed.
- Any work on the head-protection airbag system or removal and installation of the airbag components for other repairs (such as removal of the roof lining) should only be performed by a specialised workshop. Otherwise, faults may occur during the airbag system operation.
- Do not attempt to modify components of the airbag system in any way.

- The side and head airbags are managed through sensors located in the interior of the front doors. To ensure the correct operation of the side and curtain airbags neither the doors nor the door panels should be modified in any way (e.g. fitting loudspeakers). If the front door is damaged, the airbag system may not work correctly. All work carried out on the front door must be done in a specialised workshop.

Deactivating airbags

Activation and deactivation of front passenger airbag*

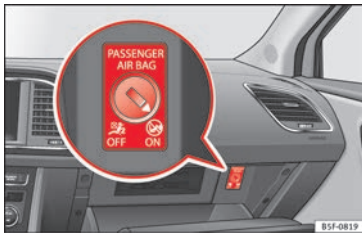


Fig. 95 Switch for activating and deactivating the front passenger airbag.



Fig. 96 Dash panel: control lamp for deactivated front passenger airbag in centre console.

Deactivate the front passenger front airbag only if you have to use a rear-facing child seat in the front passenger seat.

SEAT recommends fitting the child seat in the rear seat to avoid having to deactivate the front passenger airbag.

Front passenger front airbag switch

When the front passenger airbag is **deactivated**, this means that only the front passenger front airbag is deactivated. All the other airbags in the vehicle remain activated.

Disconnect the front passenger front airbag

- Switch the ignition off.
- Open the glove compartment on the front passenger side.
- Insert the key into the slot of the switch for deactivating the front passenger airbag

»» **Fig. 95.** About 3/4 of the key should enter; this is as far as it will go.

- Turn the key gently to the **OFF** position. If you have difficulty, ensure that you have inserted the key as far as it will go.
- Check, with the ignition switched on, that the **OFF** control lamp remains lit where it says **PASSENGER AIR BAG OFF** in the centre of the dash panel »» **Fig. 96.**

Connect the front passenger front airbag




- Switch the ignition off.
- Open the glove compartment on the front passenger side.
- Insert the key into the slot of the switch for deactivating the front passenger airbag »» **Fig. 95.** About 3/4 of the key should enter, as far as it will go.
- Turn the key gently to the **ON** position. If you have difficulty, ensure that you have inserted the key as far as it will go.
- Check, with the ignition switched on, that the **OFF** control lamp does not remain lit where it says **PASSENGER AIR BAG OFF** in the centre of the dash panel »» **Fig. 96.** The **ON** control lamp lights up for 60 seconds and then goes off.

WARNING

- **The driver of the vehicle is responsible for disabling or switching on the airbag.**



- Always switch off the ignition before disabling the front passenger airbag! Failure to do so could result in a fault in the airbag deactivation system.
- Never leave the key in the airbag disabling switch as it could get damaged or enable or disable the airbag during driving.
- If for any reason an airbag is deactivated, reactivate it as soon as possible so that it can fulfil its protective function.





Airbag system control lamps

	It lights up on the combi-instrument
Fault in airbag system and seat belt tensioners.	Have the system checked immediately by a specialised workshop.
OFF 	It lights up on the dash panel
Front passenger front airbag disabled.	Check whether the airbag should remain disabled
ON 	It lights up on the dash panel
Front passenger front airbag enabled.	The control lamp switches off automatically 60 seconds after the ignition is switched on

Several warning and control lamps light up for a few seconds when the ignition is switch-

ed on, signalling that the function is being verified. They will switch off after a few seconds.

If the airbag and seat belt tensioner system control lamp  remains on or flashes, it indicates a malfunction in the airbag and seat belt tensioner system **»»** . Have the system checked immediately by a specialised workshop.

If the front passenger airbag is deactivated, the warning lamp **PASSENGER AIR BAG OFF**  remains lit on the dash panel to remind you that the airbag is deactivated. If, with the front passenger airbag deactivated, this lamp does not remain lit or if it is lit together with the control lamp  on the dash panel, there is a fault in the airbag system **»»** . If the control lamp is flashing, there is a fault in the disabling of the airbag system **»»** . Have the system checked immediately by a specialised workshop.

WARNING

In the event of a fault in the airbag and seat belt tensioner system, the airbags and seat belts may not trigger correctly, may fail to trigger or may even trigger unexpectedly.

- The vehicle occupants run the risk of sustaining severe or fatal injuries. Have the system checked immediately by a specialised workshop.
- Do not mount a child seat in the front passenger seat or remove the mounted child

seat! The front passenger front airbag may deploy during an accident in spite of the fault.

CAUTION

Always pay attention to any lit control lamps and to the corresponding descriptions and instructions to avoid damage to the vehicle or harm to the occupants.

Transporting children safely

Safety for children

Introduction

For safety reasons, as we have learned from accident statistics, we recommend that children under 12 years of age travel in the rear seats. Depending on their age, height and weight, children travelling in rear seats must use a child seat or a seat belt. For safety reasons, the child seat should be installed in the rear seat, behind the front passenger seat or in the centre back seat.

The physical laws involved and the forces acting in a collision apply also to children **»» page 82**. But unlike adults, children do not have fully developed muscle and bone structures. This means that children are subject to a greater risk of injury.

To reduce the risk of injuries, children must always use special child restraint systems when travelling in the vehicle.


We recommend the use of child safety products from the SEAT Original Accessories Programme, which includes systems for all ages made by “Peke” (not for all countries).

These systems have been especially designed and approved, complying with the ECE-R44. regulation.


Follow the manufacturer's instructions and observe any statutory requirements when installing and using child seats. Always read and note **»» page 91**.

We recommend you always carry the manufacturer's Child Seat Instruction Manual together with the on-board documentation.

Important information regarding the front passenger's airbag

Read the additional information carefully **»»  page 25**.

Read and always observe the safety information included in the following chapters:

- Safety distance with respect to the passenger airbag **»» page 85**.
- Objects between the passenger and the passenger side airbag **»»  in Front airbags on page 87**.

The passenger side front airbag, when enabled, is a serious risk for a child that is facing backward since the airbag can strike the seat with such force that it can cause serious or fatal injuries. Children up to 12 years old should always travel on the rear seat.

Therefore we strongly recommend you to transport children on the rear seats. This is the safest location in the vehicle. Alternatively, the front passenger airbag can be dis-

abled with a key-operated switch **»» page 89**. When transporting children, use a child seat suitable for the age and size of each child **»» page 92**.

WARNING

- If a child seat is secured to the front passenger seat, the risk to the child of sustaining critical or fatal injuries in the event of an accident increases.
- An inflating front passenger airbag can strike the rear-facing child seat and project it with great force against the door, the roof or the backrest.
- Never install a child seat facing backwards on the front passenger seat unless the front passenger front airbag has been disabled. Risk of potentially fatal injuries to the child! However, if it is necessary, in exceptional cases, to transport a child in the front passenger seat, the front passenger front airbag must always be disabled **»» page 90**. If the passenger seat has a height adjustment option, move it to the highest, most upright position. If you have a fixed seat, do not install any child restraint system in this location.
- For those vehicles that do not include a key lock switch to deactivate the airbag, the vehicle must be taken to a technical service.
- All vehicle occupants, especially children, must assume the proper sitting position and be properly belted in while travelling.




- Never hold children or babies on your lap, this can result in potentially fatal injuries to the child!
- Never allow a child to be transported in a vehicle without being properly secured, or to stand up or kneel on a seat while travelling. In an accident, the child could be flung through the vehicle, causing possibly fatal injuries to themselves and to the other vehicle occupants.
- If children assume an improper sitting position when the vehicle is moving, they expose themselves to greater risk of injury in the event of a sudden braking manoeuvre or in an accident. This is particularly important if the child is travelling on the front passenger seat and the airbag system is triggered in an accident; as this could cause serious injury or even death.
- A suitable child seat can protect your child!
- Never leave a child alone in the child seat or inside the vehicle because depending on the season, very high temperatures may be reached inside a parked vehicle, which could be fatal.
- Children who are less than 1.5 metres tall must not wear a normal seat belt without a child seat, as this could cause injuries to the abdominal and neck areas during a sudden braking manoeuvre or in an accident.
- Do not allow the seat belt to become twisted and the seat belt should be properly in place »» page 80.
- Only one child may occupy a child seat »» page 92, Child seats.

- When a child seat is mounted in the rear seats, the door child-proof lock should be activated »» page 133.

Child seats

Safety instructions

Read the additional information carefully
»»  page 25.

WARNING

When travelling, children must be secured in the vehicle with a restraint system suitable for age, weight and size.

- Read and always observe information and warnings concerning the use of child seats »» page 91.

WARNING

The retaining rings are designed only for use with "ISOFIX" and Top Tether* system child seats.

- Never secure other child seats that do not have the "ISOFIX" or Top Tether* system, or retaining belts or objects to the fastening rings - this can result in potentially fatal injuries to the child.
- Ensure that the child seat is secured correctly using the "ISOFIX" and Top Tether* securing rings.

WARNING

An undue installation of the safety seat will increase the risk of injury in the event of a crash.

- Never tie the retainer strap to a hook in the luggage compartment.
- Never secure or tie luggage or other items to the lower anchorages (ISOFIX) or the upper ones (Top Tether).

Categorisation of child seats into groups

Use only child seats that are officially approved and suitable for the child.

Child seats are subject to the regulation ECE-R 44. ECE-R stands for: Economic Commission for Europe Regulation.

The child seats are grouped into 5 categories:

Group 0: Up to 10 kg (up to around 9 months)

Group 0+: Up to 13 kg (up to around 18 months)

Group 1: from 9 to 18 kg (up to approx. 4 years old)

Group 2: from 15 to 25 kg (up to approx. 7 years old)

Group 3: From 22 to 36 kg (over around 7 years old)

Child seats that have been tested and approved under the ECE R44 standard bear the test mark on the seat (the letter E in a circle with the test number below it).

Follow the manufacturer's instructions and observe any statutory requirements when installing and using child seats.

We recommend you to always include the manufacturer's Child Seat Instruction Manual together with the on-board documentation.

SEAT recommends you use child seats from the **Original Accessories Catalogue**. These child seats have been designed and tested for use in SEAT vehicles. You can find the right child seat for your model and age group at SEAT dealers.

Event Data Recorder

Description and operation

Your vehicle has an event data recorder (EDR).

The EDR's function is to record data in the event of a mild or serious accident. These data are used to support the analysis of how different vehicle systems behaved.

The EDR records, over a reduced time range (normally 10 seconds or less), dynamic driving data and data from the restraint systems, such as:

- How different vehicle systems worked.
- Whether the driver and the occupants were wearing their seatbelts.
- How hard the acceleration or brake pedal was pressed.
- Vehicle speed.

These data will provide a better understanding of the circumstances of the accident.

Data from the driving assist systems are also recorded. This includes data such as whether the systems were inactive or active and if such action had an impact on the vehicle's dynamic behaviour, changing its path in the aforementioned situations, accelerating or decelerating the vehicle.

Depending on vehicle equipment, this includes data from systems such as:

- Adaptive Cruise Control (ACC)
- Emergency brake assist system (Front Assist).
- Park Pilot system
- Lane Assist

The EDR data are only recorded in specific accident situations. No data are recorded in normal driving conditions.

No audio or video data inside or around the vehicle are recorded. Under no circumstances are personal data such as name, age, or gender recorded. Nevertheless, third parties (such as criminal proceedings authorities) may relate the contents of the EDR data to other data sources and create a personal reference in the context of an accident investigation.

In order to read the EDR data it is necessary to access (if legally permitted to do so) the vehicle's OBD ("On-Board-Diagnose") interface while the vehicle is switched on.

SEAT will not have access to EDR data unless the owner (or, in "Leasing" cases, the lessee or hirer) gives their consent. There may be exceptions to this, depending on legal or contractual provisions.

Due to legal requirements in safety-related products, SEAT may use the EDR data for field

research and in order to improve vehicle system quality. Any data used for the purposes of research will be treated anonymously (in other words, no reference will be made to the vehicle, their owner or the lessee/hirer).

Emergencies

Self-help

Vehicle tool kit, anti-puncture kit*

The tools and anti-puncture kit* are stored under the floor panel in the luggage compartment.

To access the vehicle tools:

- Lift up the floor surface by the plastic handle until it is fastened to the tabs on both sides.

Depending on the vehicle equipment, the anti-puncture kit* is located under the floor panel in the luggage compartment.

The tool kit includes:

- Jack*
- Wire hook for pulling off the wheel cover*/wheel bolt cap clip.
- Box spanner for wheel bolts*
- Towline anchorage
- Adapter for the anti-theft wheel bolts*
- Towing bracket device

Some of the items listed are only provided in certain model versions, or are optional extras.



Note

The jack does not generally require any maintenance. If required, it should be greased using universal type grease.

Tyre repair

TMS (Tyre Mobility System)*

Read the additional information carefully

» page 65

The Anti-puncture kit* (Tyre Mobility System) will reliably seal punctures caused by the penetration of a foreign body of up to about **4 mm** in diameter. **Do not remove foreign objects, e.g. screws or nails, from the tyre.**

After inserting the sealant residue in the tyre, you must again check the tyre pressure about 10 minutes after starting the engine.

You should only use the tyre mobility set if the vehicle is parked in a safe place, you are familiar with the procedure and you have the necessary tyre mobility set! Otherwise, you should seek professional assistance.

Do not use the tyre sealant in the following cases:

- If the wheel rim has been damaged.
- In outside temperatures below -20°C (-4°F).

- In the event of cuts or perforations in the tyre greater than 4 mm.
- If you have been driving with very low pressure or a completely flat tyre.
- If the sealant bottle has passed its use by date.

WARNING

Using the tyre mobility system can be dangerous, especially when filling the tyre at the roadside. Please observe the following rules to minimise the risk of injury:

- Stop the vehicle safely as soon as possible. Park it at a safe distance from surrounding traffic to fill the tyre.
- Ensure the ground on which you park is flat and solid.
- All passengers and particularly children must keep a safe distance from the work area.
- Turn on the hazard warning lights to warn other road users.
- Use the tyre mobility system only if you are familiar with the necessary procedures. Otherwise, you should seek professional assistance.
- The tyre mobility set is intended for temporary emergency use only until you can reach the nearest specialised workshop.
- Replace the repaired tyre with the tyre mobility set as soon as possible.



- The sealant is a health hazard and must be cleaned immediately if it comes into contact with the skin.
- Always keep the tyre mobility set out of the reach of small children.
- Never use an equivalent jack, even if it has been approved for your vehicle.
- Always stop the engine, apply the hand-brake lever firmly and engage gear if using a manual gearbox, in order to reduce the risk of vehicle involuntary movement.

⚠ WARNING

A tyre filled with sealant does not have the same performance properties as a conventional tyre.

- Never drive faster than 80 km/h (50 mph).
- Avoid heavy acceleration, hard braking and fast cornering.
- Drive for only 10 minutes at a maximum speed of 80 km/h (50 mph) and then check the tyre.

♻ For the sake of the environment

Dispose of used or expired sealant observing any legal requirements.

i Note

A new bottle of sealant can be purchased at SEAT dealerships.

i Note

Take into account the separate instruction manual of the tyre mobility set* manufacturer.

Contents of the tyre mobility system*

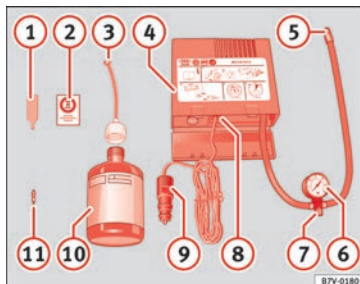


Fig. 97 Standard representation: contents of the anti-puncture kit.

The anti-puncture kit is located underneath the floor covering in the luggage compartment. It includes the following components

» **Fig. 97:**

- ① Tyre valve remover
- ② Sticker indicating maximum speed "max. 80 km/h" or "max. 50 mph"
- ③ Filler tube with cap

- ④ Air compressor
- ⑤ Tube for inflating tyres
- ⑥ Warning provided by tyre pressure monitoring system (it can also be integrated in the compressor).
- ⑦ Air bleed screw (in its place, the compressor may have a button).
- ⑧ ON/OFF switch
- ⑨ 12 volt connector
- ⑩ Bottle of sealant
- ⑪ Spare tyre valve

The **valve insert remover** ① has a gap at the lower end for a valve insert. The valve insert can only be screwed or unscrewed in this way. This also applies to its replacement part ⑪.

⚠ WARNING

When inflating the wheel, the air compressor and the inflator tube may become hot.

- Protect hands and skin from hot parts.
- Do not place the hot flexible inflator tube or hot air compressor on flammable material.
- Allow them to cool before storing the device.
- If it is not possible to inflate the tyre to at least 2.0 bars (29 psi / 200 kPa), the tyre is too badly damaged. The sealant is not in a good condition to seal the tyre. Do not continue driving. Seek specialist assistance.

ⓘ CAUTION

Switch off the air compressor after a maximum of 8 operational minutes to avoid overheating! Before switching on the air compressor again, let it cool for several minutes.

Check after 10 minutes of driving

Screw the inflator tube » **Fig. 97** **5** again and check the pressure on the gauge **6**.

1.3 bar (19 psi / 130 kPa) and lower:

- **Stop the vehicle!** The tyre cannot be sealed sufficiently with the tyre mobility set.
- You should obtain professional assistance » **⚠**.

1.4 bar (20 psi / 140 kPa) and higher:

- Set the tyre pressure to the correct value again.
- Carefully resume your journey until you reach the nearest specialised workshop without exceeding 80 km/h (50 mph).
- Have the damaged tyre replaced.

⚠ WARNING

Driving with an unsealed tyre is dangerous and can cause accidents and serious injury.

- Do not continue driving if the tyre pressure is 1.3 bar (19 psi / 130 kPa) and lower.

- Seek specialist assistance.

Manual unlocking/locking**Introduction**

Read the additional information carefully

» **📖** page 16, » **📖** page 17.

The doors, rear lid and panoramic tilting sunroof can be locked manually and partially opened, for example if the key or the central locking is damaged.

⚠ WARNING

Opening and closing doors carelessly can cause serious injury.

- If the vehicle is locked from outside, the doors and windows cannot be opened from the inside.
- Never leave children or disabled people alone in the car. They could be trapped in the car in an emergency and will not be able to get themselves to safety.
- Depending on the time of the year, temperatures inside a locked and closed vehicle can be extremely high or extremely low resulting in serious injuries and illness or even death, particularly for young children.

⚠ WARNING

Getting in the way of the doors and the rear lid is dangerous and can lead to serious injury.

- Open and close the doors and the rear lid only when there is nobody in the way.

ⓘ CAUTION

When opening and closing in an emergency, carefully disassemble components and then reassemble them carefully to avoid damage to the vehicle.

Changing the windscreen wiper blades**Changing the windscreen and rear window wiper blades**

Read the additional information carefully

» **📖** page 73.

The windscreen wiper blades are supplied as standard with a layer of graphite. This layer is responsible for ensuring that the wipe is silent. If the graphite layer is damaged, the noise of the water as it is wiped across the windscreen will be louder.

Check the condition of the wiper blades regularly. **If the wipers scrape across the glass, »**

they should be changed if they are damaged, or cleaned if they are dirty » ❶.

Damaged wiper blades should be replaced immediately. These are available from qualified workshops.

⚠ WARNING

Worn or dirty windscreen wiper blades reduce visibility and increase the risk of accident and serious injury.

- Always replace damaged or worn windscreen wiper blades or blades that no longer clean the windscreen properly.

❗ CAUTION

- Damaged or dirty windscreen wipers could scratch the glass.

- If products containing solvents, rough sponges or sharp objects are used to clean the blades, the graphite layer will be damaged.

- Never use fuel, nail varnish remover, paint thinner or similar products to clean the windows.

- In icy conditions, always check that the wiper blades are not frozen to the glass before using the wipers. In cold weather, it may help to leave the vehicle parked with the wipers in service position » 📖 page 72.

❗ CAUTION

- To prevent damage to the bonnet and the wiper arms, only leave them in the service position.
- Before driving, always lower the wiper arms.

Towing or tow-starting

General information

Read the additional information carefully » 📖 page 69.

Tow-starting means starting the engine of the vehicle while another pulls it.

Towing means one vehicle pulling another that is not roadworthy.

If the vehicle comes with the Keyless Access system, towing is only allowed with the ignition on!

The vehicle battery drains if the vehicle is towed with the engine switched off and the ignition connected. Depending on the battery charge status, the drop in voltage may be so large, even after just a few minutes, that no electrical device in the vehicle may work e.g. the hazard warning lights. In vehicles with the Keyless Access system, the steering wheel could lock up.

⚠ WARNING

If the vehicle has no electrical power, the brake lights, turn signals and all other lights will no longer function. Do not have the vehicle towed away. Failure to follow this instruction could result in an accident.

⚠ WARNING

The risk of accidents is high when tow-starting, for example, the towed vehicle can easily be driven into the towing vehicle.

❗ CAUTION

If there is no oil in the gearbox or no lubricant in the automatic transmission the car may only be towed with the driven wheels lifted clear of the road, or transported on a special car transporter or trailer.

❗ CAUTION


Do not tow a vehicle for more than 50 m in attempt to start it. There is risk of damage to the catalytic converter.

📖 Note

- Please observe related legal requirements.
- Switch on the hazard warning lights of both vehicles. However, observe any regulations to the contrary.

- The tow rope must not be twisted. Otherwise the front tow line anchorage could be pulled off the vehicle.

Indications for tow-starting

Vehicle's should not generally be tow-started. The jump start should be used instead »  page 70.

For technical reasons, towing the following vehicles is **not** allowed:

- Vehicles with an automatic gearbox.
- If the vehicle battery is discharged, because in vehicles with the Keyless Access locking and ignition system the steering remains locked and the electronic parking brake cannot be deactivated nor can the electronic lock of the steering column be released if they are activated.
- If the battery is flat, it is possible that the engine control units may not operate correctly.

However, if the vehicle must absolutely be tow-started (in the case of manual gearbox):

- Engage the 2nd or 3rd gear.
- Keep the clutch pressed down.
- Switch on the ignition and the hazard warning lights.

- Once both vehicles are moving, release the clutch.
- Once the engine starts, press the clutch and disengage the gear to avoid colliding with the towing vehicle.

Note

The vehicle can only be tow-started if the electronic parking brake and, if appropriate, the electronic lock of the steering column are deactivated. If the vehicle has no power supply or there is an electric system fault, the engine must be tow-started to deactivate the electronic parking brake and the electronic lock of the steering column.

Anchoring the front tow line



Fig. 98 Right side of the front bumper: towline anchorage screwed in.

The front towline anchorage is only mounted if the vehicle has to be towed.

There is a cover with an opening into which the towline anchorage is screwed on the right part of the front bumper.

- To open the cover, press the left side.
- Take the towline anchorage out of the vehicle tool kit » page 95.
- Screw the towline anchorage into the screw connection as far as it will go » **Fig. 98** and tighten with the wheel brace.

After use, unscrew the towline anchorage and fit the cover back on the bumper. Put the towline anchorage back in the vehicle tool kit. The towline anchorage should always be kept in the vehicle.

Rear towline anchorage

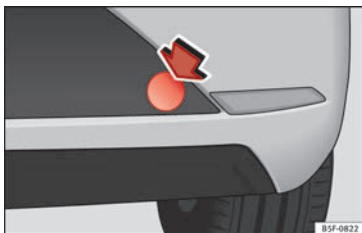


Fig. 99 Right side of the rear bumper: cover-cap.



Fig. 100 Right side of the rear bumper: towline anchorage screwed in.

The rear towline anchorage should only be mounted if you wish to tow another vehicle.

Vehicles with towline anchorage

On the right of the rear bumper there is a cover which covers a threaded hole.

- Take the towline anchorage out of the vehicle tool set » page 95.
- To open the cover, press the top right side » **Fig. 99**.
- Screw the towline anchorage into the screw connection as far as it will go » **Fig. 100** and tighten with the wheel brace.

After use, unscrew the towline anchorage and put it back in the vehicle tool kit. Replace the cover on the bumper. The towline anchorage should always be kept in the vehicle.

⚠ WARNING

- If the towline anchorage is not screwed in as far as the stop, there is a risk of the screw connection shearing off during towing (accident risk).
- If your car has a towing bracket, only use special towing ropes. Risk of accident!

ⓘ CAUTION

In vehicles fitted with a towing bracket, only use special tow bars to prevent damage to the ball joint. These tow bars have been specially approved for use with towing brackets.

Towing vehicles with a manual gearbox

Towing is relatively straightforward.

Please observe the relevant instructions » page 98.

The vehicle can be towed using a tow bar or tow rope in the normal way, with all four wheels on the road; it can also be towed with either the front or rear wheels lifted off the road. The maximum towing speed is **50 km/h** (30 mph).

Towing a vehicle equipped with automatic gearbox

Certain restrictions must be observed when towing your vehicle.

Please observe the relevant instructions » page 98.


The vehicle can be towed with a tow bar or tow rope in the normal way, with all four wheels on the ground. When doing so, please note the following points:

- Make sure the **selector lever is in the N** position.
- The vehicle must not be towed faster than **50 km/h** (30 mph).
- The vehicle must not be towed further than **50 km (30 miles)**. Reason: when the engine

is not running, the gearbox oil pump does not work and the gearbox is not adequately lubricated for higher speeds or longer distances.

If the vehicle has to be towed with a **break-down truck**, it must only be suspended at the *front* wheels. Reason: the drive shafts are located on the front wheels. If the car is towed with the rear wheels lifted off the road (i.e. travelling backwards), the drive shafts also turn *backwards*. The planetary gears in the automatic gearbox then turn at such high speeds that the gearbox will be severely damaged in a short time.

Note

- If it is not possible to tow the vehicle in the normal way, or if it has to be towed further than 50 km (30 miles), it must be transported on a special car transporter or trailer.
- Should the power supply to the selector lever be interrupted in position P, the selector lever will be locked. Before the vehicle can be recovered/manoeuvred you must manually release the selector lever »  page 50.

Fuses and bulbs

Fuses

Introduction

In general, a fuse can be assigned to various electrical components. Likewise, an electrical component can be protected by several fuses.

Only replace fuses when the cause of the problem has been solved. If a newly inserted fuse blows after a short time, you must have the electrical system checked by a specialised workshop as soon as possible.

WARNING

The high voltages in the electrical system can give serious electrical shocks, causing burns and even death!

- Never touch the electrical wiring of the ignition system.
- Take care not to cause short circuits in the electrical system.

WARNING

Using unsuitable fuses, repairing fuses or bridging a current circuit without fuses can cause a fire and serious injury.

- Never use a fuse with a higher value. Only replace fuses with a fuse of the same amperage (same colour and markings) and size.
- Never repair a fuse.
- Never replace a fuse by a metal strip, staple or similar.

CAUTION

- To prevent damage to the vehicle's electric system, before replacing a fuse always turn off the ignition, the lights and all electrical elements and remove the key from the ignition.
- If you replace a fuse with higher-rating fuse, you could cause damage to another part of the electrical system.
- Protect the fuse boxes when open to prevent the entry of dust or humidity as they can damage the electrical system.

Note

- One component may have more than one fuse.
- Several components may run on a single fuse.

Vehicle fuses

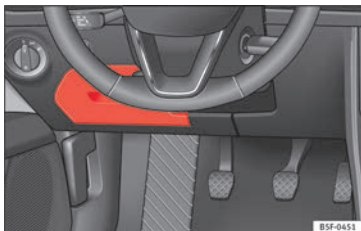


Fig. 101 On the driver-side dash panel: fuse box cover.

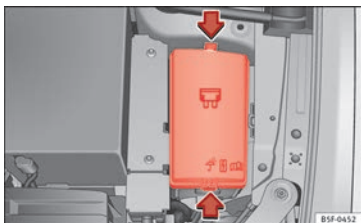


Fig. 102 In the engine compartment: fuse box cover.


Read the additional information carefully
 »  page 63

Only replace fuses with a fuse of the same amperage (same colour and markings) and size.

Opening and closing the fuse box situated below the dash panel

- *Opening*: fold the cover down »» **Fig. 101**.
- *Closing*: push back the cover in until it clicks into place.

To open the engine compartment fuse box

- Open the bonnet  »» page 270.
- Press the locking tabs to release the fuse box cover »» **Fig. 102**.
- Then lift the cover out.
- To **fit** the cover, place it on the fuse box. Push the locking tabs down until they click audibly into place.

Fuses in the vehicle interior

No.	Consumers/Amps	
4	Taxis	3
5	Gateway	5
6	Automatic gearbox lever	5
7	Air conditioning and heating control panel, heating the back window.	10
8	Diagnosis, handbrake switch, light switch, reverse light, interior lighting, lit-up door sill	10
9	Steering column	5
10	Radio display	7.5
11	Left lights	40

No.	Consumers/Amps	
12	Radio	20
14	Air conditioner fan	40
15	KESY	10
16	Connectivity Box.	7.5
17	Instrument panel	7.5
18	Rear camera	7.5
19	KESY	7.5
21	4x4 Haldex Control Unit	15
22	Trailer	15
23	Sunroof	30
24	Right lights	40
25	Left door	30
26	Heated seats	20
27	Interior light	30
28	Trailer	25
32	Parking aid control unit, front camera, radar	7.5
33	Airbag	5
34	Reverse switch, climate sensor, electrochromic mirror, rear power sockets (USB)	7.5
35	Diagnosis, headlight control unit, headlight adjuster	10

Fuses and bulbs

No.	Consumers/Amps	
36	Right LED headlight	7.5
37	Left LED headlight	7.5
38	Trailer	25
39	Right door	30
40	12V socket	20
42	Central locking	40
43	SEAT Sound, beats sound CAN and MOST.	30
44	Trailer	15
45	Electric driver's seat	15
47	Rear window wiper	15
49	Starter motor; clutch sensor	5
52	Driving mode.	15
53	Heated rear window	30

Fuse arrangement in engine compartment

No.	Consumers/Amps	
1	ESP control unit	25
2	ESP control unit	40/60
3	Engine control unit (diesel/petrol)	30/15
4	Engine sensors	5/10

No.	Consumers/Amps	
5	Engine sensors	7.5/10
6	Brake light sensor	5
7	Engine power supply	5/10
8	Lambda probe	10/15
9	Engine	5/10/20
10	Fuel pump control unit	10/15/20
11	PTC	40
12	PTC	40
13	Automatic gearbox control unit	15/30
15	Horn	15
16	Fuel pump control unit	5/15/20
17	Engine control unit	7.5
18	Terminal 30 (positive reference)	5
19	Front windscreen washer	30
20	Alarm horn	10
22	Engine control unit	5
23	Starter motor	30
24	PTC	40
31	Electronic differential CUPRA	15
33	Automatic gearbox pump	30

ⓘ CAUTION


- Always carefully remove the fuse box covers and refit them correctly to avoid problems with your vehicle.
- Protect the fuse boxes when open to avoid the entry of dust or humidity. Dirt and humidity inside fuse boxes can cause damage to the electrical system.

ⓘ Note


- In the vehicle, there are more fuses than those indicated in this chapter. These should only be changed by a specialised workshop.
- Positions not containing a fuse do not appear in the following tables.
- Some of the equipment listed in the tables below pertain only to certain versions of the model or are optional extras.
- Please note that the above lists, while correct at the time of printing, are subject to change.

Changing bulbs

Topic introduction

Read the additional information carefully
 »  page 64.

Changing bulbs requires a certain degree of practical skill. »

If you choose to change the engine compartment lamps yourself, remember that it is a dangerous area »»  **in Working in the engine compartment on page 270.**

Always use identical bulbs with the same designation. The name can be found on the base of the bulb holder.

Depending on how equipped the vehicle is, there are different sets of headlights and tail lights:

- Halogen headlights.
- Full-LED main headlights*
- Halogen headlights with LED daytime running lights*
- Rear bulb light
- LED rear light*

Full-LED headlight system*

Full-LED headlights handle all light functions (daylight, side light, turn signal, dipped beam and route light) with light emitting diodes (LEDs) as a light source.

Full-LED headlights are designed to last the lifetime of the car and light bulbs cannot be replaced. In case of headlight failure, go to an authorised workshop to have it replaced.

WARNING

- Take particular care when working on components in the engine compartment if the engine is warm. Risk of burns.
- Bulbs are highly sensitive to pressure. The glass can break when you touch the bulb, causing injury.
- When changing bulbs, please take care not to injure yourself on sharp edges, in particular on the headlight housing.

CAUTION

- Remove the ignition key before working on the electric system. Otherwise, a short circuit could occur.
- Switch off the lights and the parking light before changing a bulb.
- Take good care to avoid damaging any components.

For the sake of the environment

Please ask your specialist retailer how to dispose of used bulbs in the proper manner.

Note

- Please check at regular intervals that all lighting (especially the exterior lighting) on your vehicle is functioning properly. This is not only in the interest of your own safety, but also that of all other road users.

- Before changing a bulb, make sure you have the correct new bulb.
- Do not touch the glass part of the bulb with your bare hands, use a cloth or paper towel instead, since the fingerprints left on the glass will vaporise as a result of the heat generated by the bulb, they will be deposited on the reflector and will impair its surface.
- Depending on the level of equipment fitted in the vehicle, LEDs may be used for part or all of the interior and/or exterior lighting. LEDs have an estimated life that exceeds that of the car. If an LED light fails, go to an authorised workshop for its replacement.

Change the front bulbs

Dipped headlight bulb

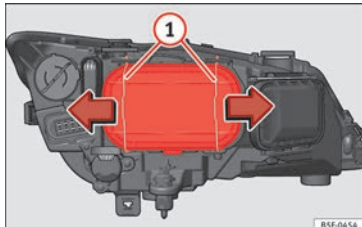


Fig. 103 Dipped beam headlights.

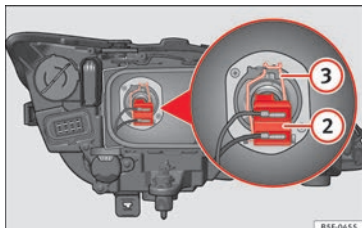


Fig. 104 Dipped beam headlights.

- Raise the bonnet.
- Move the loops »» Fig. 103 ① in the direction of the arrow and remove the cover.

- Remove connector »» Fig. 104 ② from the bulb.
- Unclip the retainer spring »» Fig. 104 ③ pressing inwards to the right.
- Extract the bulb and fit the replacement so that the lug on the base fits into the recess on the reflector.

Day light bulb

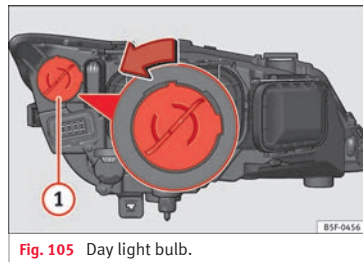


Fig. 105 Day light bulb.

- Raise the bonnet.
- Turn the bulb holder »» Fig. 105 ① to the left and pull.
- Remove the bulb by pressing on the bulb holder and turning it anti-clockwise at the same time.
- Installation involves all of the above steps in reverse sequence.

Turn signal bulb

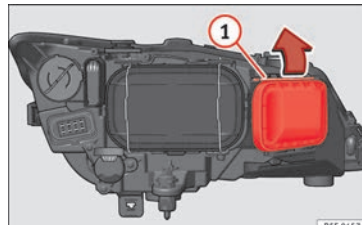


Fig. 106 Turn signal bulb.

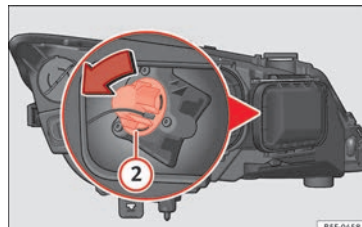


Fig. 107 Turn signal bulb.

- Raise the bonnet.
- Move the loop »» Fig. 106 ① in the direction of the arrow and remove the cover.
- Turn the bulb holder »» Fig. 107 ② anti-clockwise and pull.

- Remove the bulb by pressing on the bulb holder and turning it anti-clockwise at the same time.
- Installation involves all of the above steps in reverse sequence.

Main beam headlight bulb

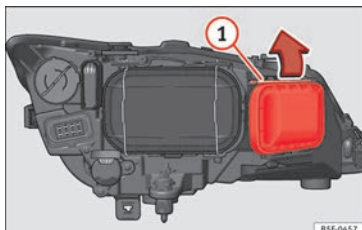


Fig. 108 Main beam headlight bulb.

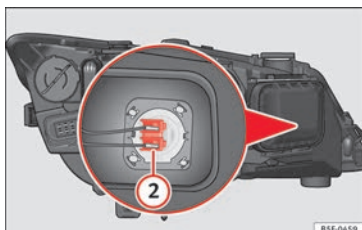


Fig. 109 Main beam headlight bulb.

- Raise the bonnet.
- Move the loop » **Fig. 108** (1) in the direction of the arrow and remove the cover.
- Slide connector » **Fig. 109** (2) to the left or right and pull.
- Remove the bulb by disconnecting the connector.
- Installation involves all of the above steps in reverse sequence.

Fog light bulb*

✓ Valid only for versions with incandescent bulbs

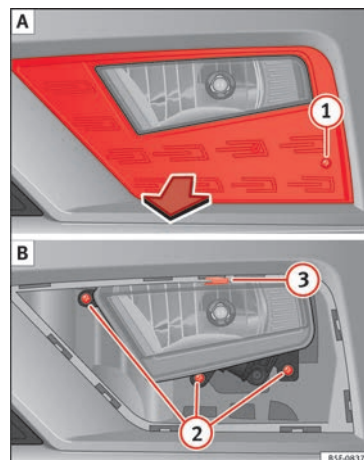


Fig. 110 Fog light: extracting the grille.

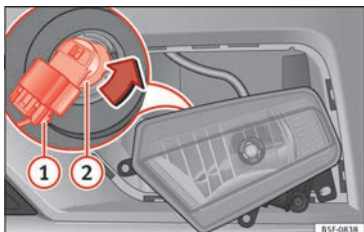


Fig. 111 Fog light: remove the bulb holder

Follow the steps indicated:

1. Remove the screw » **Fig. 110** ① **A** from the fog light grille using a screwdriver and extract the grille.
2. Remove the 3 screws » **Fig. 110** ② **B**.
3. Remove the metal clip situated on the upper part of the fog light by pulling away from the vehicle ③ **B** and extract the fog light.
4. Remove the connector » **Fig. 111** ① from the bulb.
5. Turn the bulb holder ② anti-clockwise and pull.
6. Remove the bulb by pressing on the bulb holder and turning it anticlockwise at the same time.
7. Installation involves all of the above steps in reverse sequence.
8. Check that the bulb works properly.

Note

- Due to the difficulty of accessing fog light bulbs, have them replaced at a Technical Service or specialised workshop.
- LED fog lights should only be replaced by specialised personnel.

Changing incandescent rear light bulbs

Rear lights summary

Tail lights on side panel

Turn signal	PY21W NA LL
Side light and brake light	P21W LL

Tail lights on the rear lid

Left side

Side lights	2x W5W LL
Fog lights	H21 W

Right side

Side lights	2x W5W LL
Reverse light	P21W LL

The table corresponds to a right-hand traffic vehicle. The position of lights may vary according to the country.

Rear bulbs (in the side panel)

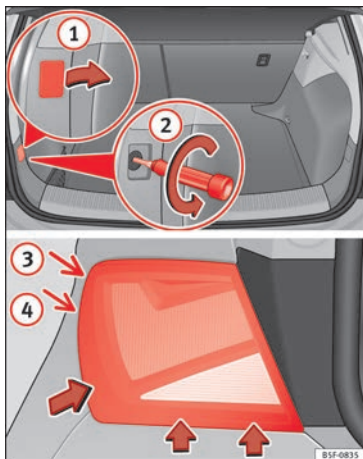


Fig. 112 Luggage compartment: location of the bolt securing the tail light unit. Remove the rear light unit from side panel.

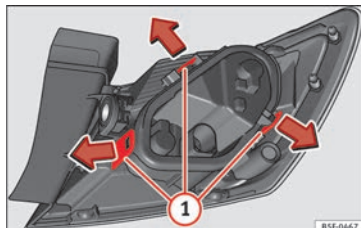


Fig. 113 Retaining tabs on reverse side of tail light.

- Check which of the bulbs is defective.
- Open the rear lid.
- Remove the cover by prying the flat side of a screwdriver into the recess and remove the cover from the opening » **Fig. 112 ①**.
- Carefully loosen the screw located behind the cover with a screwdriver, turning it anti-clockwise (arrows) » **Fig. 112 ②**.
- Tilt the light in the direction of the arrows until it comes out of its housing (positions **③** and **④**) » **Fig. 112**.
- Remove the bulb holder » **Fig. 113** unlocking the retaining tabs **①**.
- Change the damaged bulb.
- To refit follow the steps in reverse order, taking special care when fitting the bulb holder. The securing tabs must click into place.

ⓘ CAUTION

Take care when removing the rear light unit to make sure there is no damage to the paintwork or any of its components.

i Note

Make sure you have a soft cloth ready to place under the glass on the rear light unit, to avoid any scratches.

Rear light bulbs (in the rear lid)

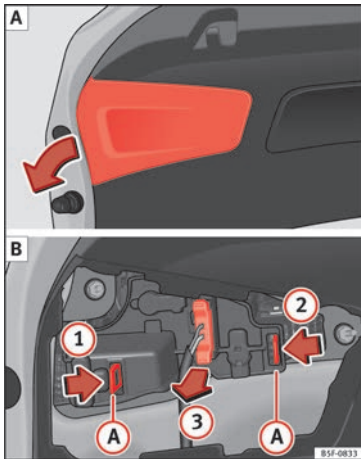


Fig. 114 Remove the cover from the boot lid and detach the bulb holder.

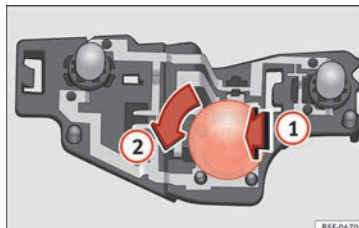


Fig. 115 Position of the bulbs in the bulb holder

The rear lid must be open to change the bulbs.

- Remove the rear lid cover in the direction indicated » **Fig. 114 [A]**.
- Unlock the retaining tabs **(A)** of the bulb holder, following the direction of arrows **1** and **2** » **Fig. 114 [B]**.
- Remove the bulb holder, moving it in the direction of arrow **3** » **Fig. 114 [B]**.
- Lightly press the defective bulb into the bulb holder **1**, then turn it to the left **2** and remove it » **Fig. 115**.
- Fit the new bulb, pressing it into the bulb holder and turn it to the right as far as it will go.
- Use a cloth to remove any fingerprints from the glass part of the bulb.
- Check that the new bulb works properly.

- Reinstall the bulb holder, making sure that locking clips **(A)** » **Fig. 114 [B]** are properly clipped on.
- Replace the cover of the rear lid lining.

Rear LED light bulb (in the rear lid)



Fig. 116 Remove the cover from the rear lid

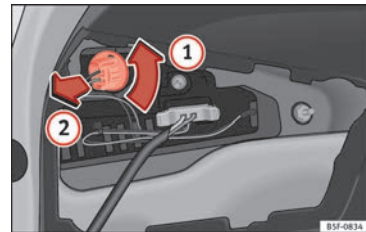


Fig. 117 Remove the bulb holder.

The rear lid must be open to change the bulbs.

- Remove the rear lid cover in the direction indicated »» Fig. 116.
- Turn the reverse lights bulb holder anti-clockwise in the direction of the arrow ① »» Fig. 117.
- Remove the bulb holder from its housing ②.
- Change the defective bulb and reinstall the bulb holder in its housing, following these instructions in reverse order.
- Check that the new bulb works properly.

Changing number plate light bulbs

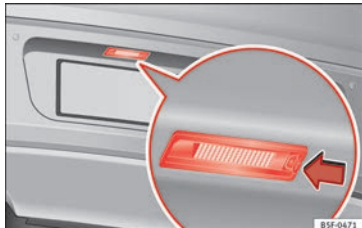


Fig. 118 In the rear bumper: number plate light.

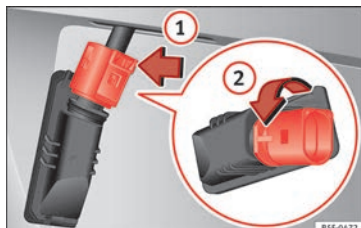


Fig. 119 Number plate light: Remove the bulb holder.

Follow the steps indicated:

1. Press the number plate light in the direction of the arrow »» Fig. 118.
2. Remove the number plate light.
3. Turn the connector lock »» Fig. 119 in the direction of arrow ① and pull on the connector.
4. Rotate the bulb holder in the direction of arrow ② and extract it with the bulb.
5. Replace the defective bulb with a new bulb with the same features.
6. Insert the bulb holder in the number plate light and turn in the opposite direction of arrow ② until it stops.
7. Plug the connector into the bulb holder.

Note

Depending on how equipped the vehicle is, the number plate lights may be LEDs. LEDs have an estimated life that exceeds that of the car. If a light with LEDs fails, go to an authorised workshop for replacement.

Side turn signals

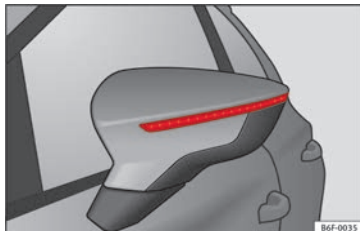


Fig. 120 Turn signal integrated in the rear view mirror

The side turn signals are LEDs and are integrated in the exterior mirrors.

In case of failure, go to an authorised workshop to have them replaced.

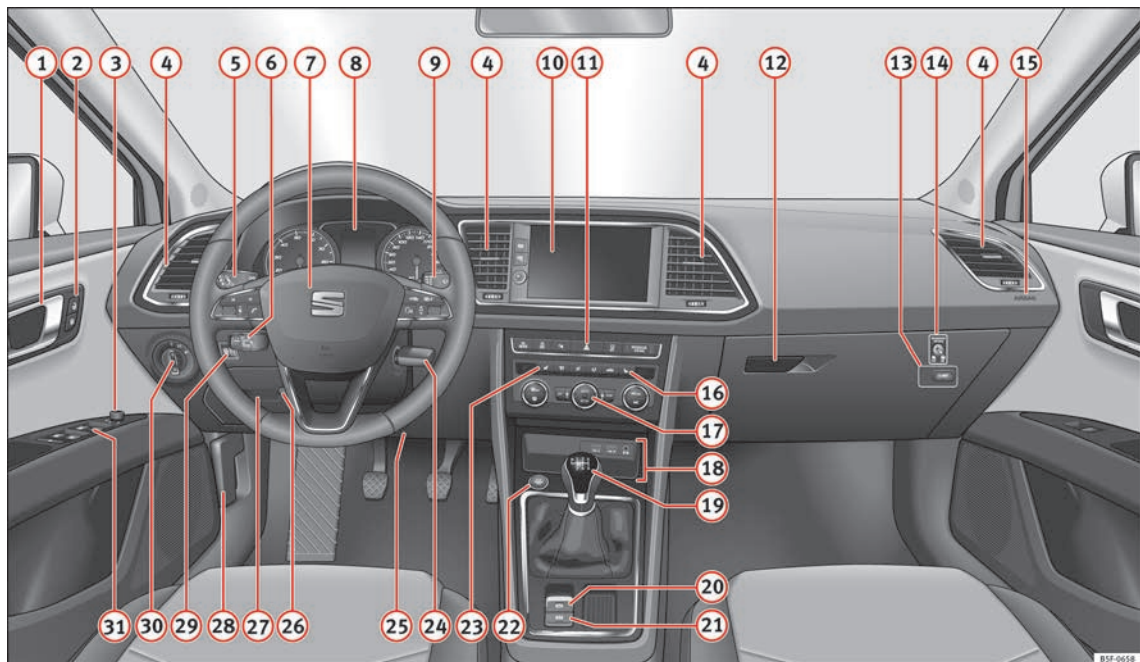


Fig. 121 Instruments and controls.

Operation

Controls and displays

General instrument panel

- | | | | | | | | | | |
|---|---|-----|----|--|--|--------|--|-------------------------|-----|
| 1 | Door release lever | | 9 | Control lever for: | | 18 | Depending on the equipment: | | |
| 2 | Central locking switch | 128 | | – Windscreen wipers and washer | 148 | | – USB/AUX-IN input | 123 | |
| 3 | Electric control to adjust exterior mirrors | 151 | | – Wipe and wash system | 148 | | – Connectivity Box/Wireless Charger* | 123 | |
| 4 | Air outlets | 176 | 10 | – On-board computer | 36 | | – Storage compartment | | |
| 5 | Control lever for: | | | Depending on equipment fitted: radio or display for Easy Connect (navigation, radio, TV/video) | 120 | 19 | Depending on equipment fitted, gear lever or selector lever for: | | |
| | – Turn signals and main beam headlights | 141 | | – SEAT driving modes | 230 | | – Manual gearbox | 190 | |
| | – Lane Assist | 224 | 11 | – Start-Stop system | 205 | | – Automatic gearbox | 191 | |
| | – Main beam assist | 142 | | – Park assist system | 237 | 20 | Electronic parking brake switch | 183 | |
| | – Cruise control system (CCS) | 209 | | – Hazard warning lights | 145 | 21 | Auto Hold switch | 208 | |
| 6 | Depending on equipment fitted: | | | – Tyre pressure switch | 285 | 22 | Starter button (Keyless Access locking and ignition system) | 180 | |
| | – Lever for cruise control | 209 | 12 | – Airbag off display | 89 | 23 | Driver's seat heating control | 154 | |
| 7 | Steering wheel with horn and | | | Depending on the equipment, glove compartment with: | 158 | 24 | Ignition lock (vehicles without Keyless Access) | 178 | |
| | – Driver airbag | 22 | | – CD player* and/or SD card* | | 25 | Knee airbag | 23 | |
| | – On-board computer controls | 36 | | » Booklet Radio | | 26 | Adjustable steering column | 21 | |
| | – Controls for radio, telephone, navigation and speech dialogue system » Booklet Radio | | 13 | Tyre pressure switch | 285 | 27 | Storage compartment | | |
| | – Paddle levers for tiptronic gear-shift (automatic gearbox) | 193 | | 14 | Front passenger airbag switch | 89 | 28 | Bonnet lock release | 271 |
| 8 | Instrument panel | 114 | | 15 | Front passenger airbag | 22 | 29 | Headlight range control | 146 |
| | | | | 16 | Passenger seat heating control | 154 | 30 | Headlight switch | 140 |
| | | | | 17 | Depending on the equipment, controls for: | | 31 | Electric windows | 136 |
| | | | | | – Heating and ventilation system or manual air conditioner | 56, 54 | | | |
| | | | | | – Automatic air conditioner | 52 | | | |

Note

• Some of the equipment listed in this section is only fitted on certain models or are optional extras. »

- A separate Instructions Manual is enclosed if the vehicle is equipped with a factory-fitted radio, CD player, AUX IN connection or navigation system.

- The arrangement of switches and controls on right-hand drive models* may be slightly different from the layout shown in

» page 112. However, the symbols used to identify the controls are the same.

Instruments and warning/control lamps

Instruments

View of instrument panel

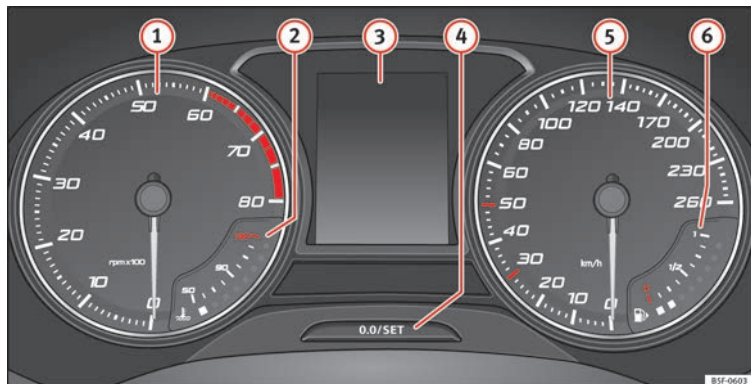



Fig. 122 Instrument panel, on dash panel.

Details of the instruments » **Fig. 122:**

- 1 **Rev counter** (with the engine running, in hundreds of revolutions per minute).

The beginning of the red zone of the rev counter indicates the maximum speed in first gear after running-in and with the

engine hot. However, it is advisable to change up a gear or move the selector lever to **D** (or lift your foot off the accelerator) before the needle reaches the red zone »» ❶.

- ❷ **Engine coolant temperature display** »» page 117 or **natural gas gauge** in vehicles with natural gas engine (CNG) »» page 119
- ❸ **Displays on the screen** »»  page 41, »» page 115.
- ❹ **Adjuster button and display** »» page 117.
- ❺ **Speedometer.**
- ❻ **Fuel gauge** »» page 118.

WARNING

Any distraction may lead to an accident, with the risk of injury.

- Do not operate the instrument panel controls when driving.

❶ CAUTION

- To prevent damage to the engine, the rev counter needle should only remain in the red zone for a short period of time.
- When the engine is cold, avoid high revs and heavy acceleration and do not make the engine work hard.

For the sake of the environment


Changing up a gear in time reduces fuel consumption and noise.

Rev counter

The rev counter indicates the number of engine revolutions per minute »» Fig. 122 ❶.

Together with the gear-change indicator, the rev counter offers you the possibility of using the engine of your vehicle at a suitable speed.

The start of the red zone on the dial indicates the maximum engine speed which may be used briefly when the engine is warm and after it has been run in properly. Before reaching this range, you should change to a higher gear for vehicles with a manual gearbox or for automatic gearboxes put the selector lever in “D” or take your foot off the accelerator pedal.

We recommend that you avoid high revs and that you follow the recommendations on the gear-change indicator. Consult the additional information in »»  page 42, Gear-change indicator.

❶ CAUTION

Never allow the rev counter needle »» Fig. 122 ❶ to go into the red zone on the







scale for more than a very brief period, otherwise there is a risk of engine damage.


For the sake of the environment

Changing up a gear early will help you to save fuel and minimise emissions and engine noise.

Indications on the display

A variety of information can be viewed on the instrument panel display »» Fig. 122 ❸, depending on the vehicle equipment:



- Bonnet, rear lid and doors open »»  page 41.
- Warning and information messages »»  page 41.
- Distance travelled »» page 117.
- Time »» page 116.
- Navigation instructions.
- Outside temperature »»  page 42.
- Compass »» page 116.
- Shift lever position »» page 191.
- Recommended gear (manual gearbox) »»  page 42.
- Multifunction display (MFD) and menus with different setting options »»  page 36.
- Service interval display »»  page 44. »»

- Second speed display »» page 116.
- Speed warning function »»  page 43.
- Start-Stop system status display »» page 205.
- Active cylinder management display (ACT®)* »» page 200
- Signs recognised by the traffic signal detection system »» page 233
- Low consumption driving status (ECO) »» page 117
- Engine code (MKB) »» page 117.


Distance travelled



The *odometer* registers the total distance travelled by the car.



The *odometer (trip)* shows the distance travelled since the last odometer reset. The last digit of the trip recorder indicates distances of 100 metres or one tenths of a mile.

- Briefly press the button »» Fig. 122  to reset the trip recorder to 0.
- Keep the button  pressed for about 3 seconds and the previous value will be displayed.

Time

- To set the time, keep the button »» Fig. 122  pressed for more than 3 seconds to select the hour or minute display.

- To continue setting the time, press the upper or lower part of the button . Hold button down to scroll through the numbers quickly.
- Press the button  again in order to finish setting the time.

The time can also be set on the Easy Connect system using the  button and the function button **SETTINGS > Date and time** »»  page 33.


Compass

With the ignition on and the navigation system on, the cardinal point corresponding to the direction of travel of the vehicle is displayed on the instrument panel.

Selector lever position

The selected gear is displayed on the side of the selector lever and on the instrument panel display. In positions **D** and **S**, and with the Tiptronic, the corresponding gear is also displayed.



Recommended gear (manual gearbox)

The recommended gear in order to save fuel is displayed on the instrument panel while you are driving »»  page 42.


Second speed display (mph or km/h)



In addition to the speedometer, the speed can also be displayed in a different unit of measurement (in miles or in km per hour).

This option cannot be deactivated in models destined for countries in which the second speed must always be visible.

The second speed display can be adjusted in the Easy Connect system by means of the  button and the function button **SETTINGS > Units** »»  page 33.

Speed warning

When the speed setting is exceeded, this will be indicated on the instrument panel display. This is very useful, for example when using winter tyres that are not designed for driving at the maximum speed of the vehicle »»  page 43.

The speed warning settings can be adjusted in the Easy Connect system by means of the  button and the function button **SETTINGS > Driver Assistance** »»  page 33.

Start-Stop operating display

Updated information relating to the status is displayed on the instrument panel »» page 205.

Low consumption driving status (ECO)*

Depending on the equipment, when driving, the “ECO” display appears on the instrument panel when the vehicle is in low consumption status due to active cylinder management (ACT®)* » page 200.

Identifying letters on engine (MKB)

Hold the button » Fig. 122 4 down for more than 15 seconds to display the vehicle’s engine code (MKB). To do this, the ignition must be switched on and the engine switched off.

⚠ WARNING

Observe the safety warnings » ⚠ in Warning and control lamps on page 119.

⚠ WARNING

Even though outside temperatures are above freezing, some roads and bridges may be icy.

- At outside temperatures above +4°C (+39°F), even when the “ice crystal” symbol is not visible, there may still be patches of ice on the road.
- The outside temperature sensor takes a guideline measurement.

📄 Note

- Different versions of the instrument panel are available and therefore the versions and

instructions on the display may vary. In the case of displays without warning or information texts, faults are indicated exclusively by the warning lamps.

- Depending on the equipment, some settings and instructions can also be carried out in the Easy Connect system.
- When several warnings are active at the same time, the symbols are shown successively for a few seconds and will stay on until the fault is rectified.

Odometer



Fig. 123 Instrument panel: odometer and reset button.

The distance covered is displayed in “kilometres” or miles “m”. It is possible to change the measurement units (kilometres “km”/miles “m”) in the radio/Easy Connect*. Please refer to the Easy Connect* Instructions Manual for more details.

Odometer/trip recorder

The odometer shows the total distance covered by the vehicle.

The trip recorder shows the distance that has been travelled since it was last reset. It is used to measure short trips. The last digit of the trip recorder indicates distances of 100 metres or tenths of a mile.

The trip recorder can be set to zero by pressing **0.0/SET** » Fig. 123.


Fault display

If there is a fault in the instrument panel, the letters DEF will appear in the trip recorder display. Have the fault repaired immediately, as far as is possible.

Coolant temperature gauge



Fig. 124 Instrument panel: coolant temperature gauge


For vehicles with no coolant temperature gauge, a control lamp  appears for high coolant temperatures [» page 274](#). Please note [» 1](#).

The coolant temperature gauge only works when the ignition is switched on [» Fig. 124](#). In order to avoid engine damage, please read the following notes for the different temperature ranges.


Engine cold

If only the diodes in the lower part of the scale light up, this indicates that the engine has not yet reached operating temperature. Avoid high revs and heavy acceleration and do not make the engine work hard.

Normal temperature

If in normal operations, the diodes light up until the central zone, it means that the engine has reached operating temperature. At high outside temperatures and when making the engine work hard, the diodes may continue lighting up and reach the upper zone. This is no cause for concern, provided the control lamp  does not light up on the instrument panel digital display.

Heat range

When the diodes light up in the upper area of the display and the control lamp appears .

on the instrument panel display, the coolant temperature is excessive [» page 274](#).

CAUTION

- To ensure a long useful life for the engine, avoid high revs, driving at high speed and making the engine work hard for approximately the first 15 minutes when the engine is cold. The phase until the engine is warm also depends on the outside temperature. If necessary, use the engine oil temperature* [» !\[\]\(32b3140000635d85b5fcc7ce37a1b40f_img.jpg\) page 43](#) as a guide.
- Additional lights and other accessories in front of the air inlet reduce the cooling effect of the coolant. At high outside temperatures and high engine loads, there is a risk of the engine overheating.
- The front spoiler also ensures proper distribution of the cooling air when the vehicle is moving. If the spoiler is damaged this can reduce the cooling effect, which could cause the engine to overheat. Seek specialist assistance.

Fuel level - Petrol/Diesel

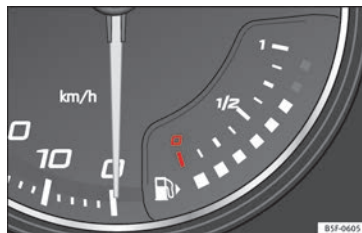



Fig. 125 Instrument panel: petrol/diesel gauge

The display [» Fig. 125](#) only works when the ignition is switched on. When the display reaches the reserve mark, the lower diode lights up in red and the control lamp  appears [» page 114](#). When the fuel level is very low, the lower diode flashes in red.

The fuel range is displayed on the instrument panel [» Fig. 122 ③](#).

The capacity of the fuel tank of your vehicle is given in the Technical data section [» !\[\]\(9db214d549b9aeebe72aa11d3a5c4b1a_img.jpg\) page 58](#).

CAUTION


Never run the fuel tank completely dry. An irregular fuel supply could cause misfiring. In this way the unburned fuel can reach the exhaust system, which could cause the catalytic converter to overheat resulting in damage.




Fuel - Natural Gas level

✓ Valid in vehicles equipped with natural gas engine (GNC)



Fig. 126 Instrument panel: Natural gas gauge

The gauges » Fig. 126 and » Fig. 125 only work when the ignition is on. When the display reaches the reserve mark, the lower LED lights up in red and the control lamp  appears. When the fuel level is very low, the lower diode flashes in red.

- The green warning lamp  » Fig. 126 ① lights up when the vehicle is running in natural gas operating mode.
- The green warning lamp  ① turns off when the natural gas is exhausted. The engine changes to operate with petrol.
- The yellow control lamp  lights up when the reserve level has been reached.

Things to note



If the vehicle is left parked for a long time immediately after refuelling, the natural gas level indicator may not accurately indicate the same level shown after refuelling when the vehicle is started up again. This is not due to a leak in the system, but to a drop in pressure in the gas tank for technical reasons after a cooling phase just after refuelling.

Control lamps

Warning and control lamps

Read the additional information carefully

»  page 47.

The control and warning lamps are indicators of warnings, » , faults »  or certain functions. Some control and warning lamps come on when the ignition is switched on, and switch off when the engine starts running, or while driving.

Depending on the model, additional text messages may be viewed on the instrument panel display. These may be purely informative or they may be advising of the need for action » page 114, Instruments.

Depending upon the equipment fitted in the vehicle, instead of a warning lamp, some-

times a symbol may be displayed on the instrument panel.

When certain control and warning lamps are lit, an audible warning is also heard.

WARNING

If the warning lamps and messages are ignored, the vehicle may stall in traffic, or may cause accidents and severe injuries.

- Never ignore the warning lamps or text messages.
- Stop the vehicle safely as soon as possible.
- Park the vehicle away from traffic and ensure that there are no highly flammable materials under the vehicle that could come into contact with the exhaust system (e.g. dry grass, fuel).

• A faulty vehicle represents a risk of accident for the driver and for other road users. If necessary, switch on the hazard warning lamps and put out the warning triangle to advise other drivers.

• Before opening the bonnet, switch off the engine and allow it to cool.

• In any vehicle, the engine compartment is a hazardous area and could cause severe injuries » page 270.

CAUTION

Failure to heed the control lamps and text messages when they appear may result in faults in the vehicle.



Introduction to the Easy Connect system*

System settings (CAR)*

CAR menu


Read the additional information carefully

»  page 33

To select the settings menus, depending on the version, either press the Easy Connect button  and the **SETTINGS** function button, **OR** press the  button, then **Vehicle** and then the **SETTINGS** function button.

The actual number of menus available and the name of the various options in these menus will depend on the vehicle's electronics and equipment.

When the function button check box is activated , the function is active.

Pressing the menu button  will always take you to the last menu used.

Any changes made using the settings menus are automatically saved on closing those menus.

Menu Vehicle settings	Page
ESC system	» page 187

Menu Vehicle settings	Page
Tyres	» page 283
Driver assistance	» table on page 33
Parking and manoeuvring	» page 237
Vehicle lights	» table on page 33
Mirrors and windscreen wipers	» table on page 33
Opening and closing	» table on page 33
Multifunction display	» table on page 33
Date and time	» table on page 33
Units	» table on page 33
Service	» page 115
Factory settings	» table on page 33

WARNING

Any distraction may lead to an accident, with the risk of injury. Operating the Easy Connect system while driving could distract you from traffic.

Communications and multimedia

Steering wheel controls*

Operating the audio, telephone and navigation system with voice control

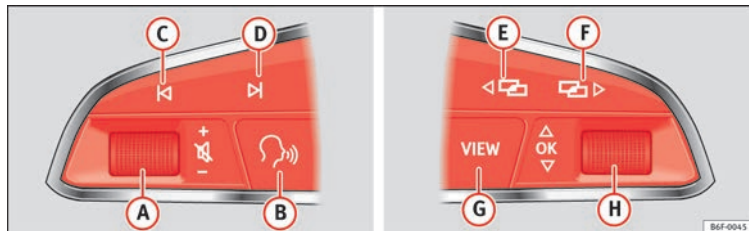


Fig. 127 Controls on the steering wheel.

The steering wheel includes a multifunction module from where it is possible to control

the audio, telephone and radio/navigation functions without needing to distract the driver.

Button	Radio	Media (except AUX)	AUX	Telephone ^{a)}	Navigation ^{a)}
A Turn	Turn volume up/down. You do not need to be in audio mode (radio).	Turn volume up/down. You do not need to be in audio mode (media).	Turn volume up/down. You do not need to be in audio mode (media).	Turn volume up/down. You do not need to be in telephone mode.	Turn announcement volume up/down. You do not need to be in navigation mode but there has to be an announcement active when you adjust the volume.
A Press	Mute volume.	Mute volume.	Mute volume.	Mute incoming call.	Mute the current navigation announcement.
B ^{a)}	Activate/deactivate voice control. This function can be used from any mode (audio, media, navigation, assistants, vehicle status, travel data). When the system is in telephone mode this button's function is deactivated during the ongoing call, and without Radio/Media functionality (except AUX).				

»

Operation

Button	Radio	Media (except AUX)	AUX	Telephone ^{a)}	Navigation ^{a)}
C / D	Search for the previous/next station ^{b)} .	<i>Short press:</i> Switch to the previous/next song. <i>Hold down:</i> Fast rewind/forward ^{c)} .	No function	– <i>There is no active call:</i> Radio/Media functionality (except AUX) – <i>Active call:</i> no function	No function for the other modes (navigation, assistants, vehicle status, travel data).
E / F ^{a)}	Change instrument panel menu. This function can be used from any mode (audio, media, navigation, assistants, vehicle status, timer*, travel data).				
G	<i>Coloured instrument panel:</i> switch to the previous menu. <i>Monochrome instrument panel:</i> switch to the previous function.				
H <i>Turn</i> ^{d)}	<i>Coloured instrument panel:</i> List of stations available (only if the instrument panel is in audio menu).	<i>Coloured instrument panel:</i> next track (only if the instrument panel is in audio menu).	No function	– <i>There is no active call:</i> List of latest calls. – <i>Active call:</i> access the call options list (call on hold, hang up, mute microphone, private number, etc.).	– <i>Active route:</i> access the view to halt guidance to destination. – <i>No active route:</i> list of recent destinations.
H <i>Press</i>	Acts on the instrument panel or confirms the instrument panel menu option depending on the menu option.				

a) According to the vehicle's equipment package.

b) This action can be performed when you are listening to the radio; there is no need to be in audio-radio mode.

c) These actions can be performed when you are listening to media; there is no need to be in audio-radio mode.

d) In CUPRA versions the timer options can be accessed.

Multimedia

USB/AUX-INPort



Fig. 128 Centre console: USB/AUX-IN input.



Fig. 129 Centre console, rear section: USB connectors.

Depending on the special characteristics and the country, the vehicle may have a USB/AUX-IN port.

The USB/AUX-IN port can be found in the storage compartment area of the centre console » **Fig. 128.**

The operating description is located in the respective Instruction Manuals of the audio system or the navigation system.

Depending on the equipment and the country, the vehicle may also have USB connections **exclusively for charging or as a power socket.**

These USB ports are located at the rear of the console, between the front seats » **Fig. 129.**

Connectivity Box* / Wireless Charger*



Fig. 130 Related video



Fig. 131 Centre console: Connectivity Box.

Depending on the features and the country, the vehicle may have one of these two options: *Connectivity Box* or *Wireless Charger*.

With the *Connectivity Box* you can charge your mobile device wirelessly with Qi¹⁾ technology, while also reducing the radiation in the vehicle and getting better reception.

With the *Wireless Charger* you only have the wireless charging function if your mobile device has Qi technology.

The *Connectivity Box/Wireless Charger* is in the storage compartment area of the centre console » **Fig. 131.**

The operating description is located in the respective Instruction Manuals of the audio system or the navigation system. »

¹⁾ Qi technology allows you to charge your mobile phone wirelessly.

 **Note**

Your mobile device must support the Qi wireless inductive charging interface standard for proper operation.

Opening and closing


Central locking system

Description

Read the additional information carefully

»  page 15

The vehicle can be locked and unlocked via the central locking system. There are several methods, depending on the vehicle equipment:

- key with remote control » page 127,
- lock on driver door (emergency opening »  page 15) or
- interior central locking switch » page 128.

Unlocking one side of the vehicle only

When you lock the vehicle with the key, the doors and the rear lid are locked. When you open the door, you can either unlock *only* the driver door, or all the vehicle doors. To select the required option, use Easy Connect* » page 128.

Auto Lock*

The Auto Lock function locks the doors and the rear lid when the vehicle exceeds a speed of about 15 km/h (9 mph).

The vehicle is unlocked again when the ignition key is removed. Alternatively, the vehicle can also be unlocked via the central locking switch or by pulling one of the inside door handles. The Auto Lock function can be switched on and off on the sound system or on the Easy Connect* system » page 128.


In the event of an accident in which the airbags inflate, the doors will be automatically unlocked to facilitate access and assistance.

Anti-theft alarm system*

If the anti-theft alarm system senses interference with the vehicle it triggers an audible and visible alarm.

The anti-theft alarm system is automatically switched on when locking the vehicle. It switches off when the vehicle is unlocked from a distance.

When the driver door is unlocked with the key, you should switch on the ignition within 15 seconds. Otherwise the alarm will be triggered. On some export versions, the alarm is triggered immediately when you open a door.

To deactivate the alarm, press the  button on the remote control key, or switch on the ignition. After a certain time, the alarm will automatically switch off.

Switch off the vehicle interior monitoring and tow-away protection if you wish to prevent

the alarm from being triggered accidentally » page 135.

Turn signals

The turn signals will flash twice when the vehicle is unlocked and once when the vehicle is locked.

If it does not flash, this indicates that one of the doors, the rear lid or the bonnet is not closed correctly.

Accidental lock-out

The central locking system prevents you from being locked out of the vehicle in the following situations:

- If the driver door is open, the vehicle cannot be locked with the central locking switch » page 128.

Lock the vehicle with the remote control key, when all the doors and the rear lid have been closed. This prevents the accidental locking of the vehicle.

WARNING

Do not leave anyone (especially children) in the vehicle if it is locked from the outside and the anti-theft security system* is enabled, as the doors and windows cannot then be opened from the inside. Locked doors could delay assistance in an emergency, potentially putting lives at risk.



 Note

- Never leave any valuable items in the vehicle unattended. Even a locked vehicle is not a safe.
- If the diode on the driver door sill lights up for about 30 seconds when the vehicle is locked, the central locking system or anti-theft alarm* is not working properly. You should have the fault repaired at a SEAT Official Service or specialised workshop.
- The vehicle interior monitoring of the anti-theft alarm* system will only function as intended if the windows and the sunroof* are closed.

Car key



Fig. 132 Vehicle key



Fig. 133 Vehicle key with alarm button.

Vehicle key

With the vehicle key the vehicle may be locked or unlocked remotely » page 125.

The vehicle key includes an emitter and battery. The receiver is in the interior of the vehicle. The range of the vehicle key with remote control and new battery is several metres around the vehicle.

If it is not possible to open or close the vehicle using the remote control key, this should be re-synchronised » page 132 or the battery changed » page 132.

Different keys belonging to the vehicle may be used.

Control lamp on the vehicle key

When a button on the vehicle key is pressed, the control lamp flashes » Fig. 132 (arrow) once briefly, but if the button is held down for

a longer period the control lamp flashes several times, such as in convenience opening.

If the vehicle key control lamp does not light up when the button is pressed, replace the key's battery » page 132.

Unfolding and folding the key shaft

Press button (1) » Fig. 132 or » Fig. 133 to unlock and unfold the key shaft.

To fold the shaft away, press button (1) and fold the key shaft in until it locks in place.

Alarm button*

Only press alarm button (2) in the event of an emergency! When the alarm button is pressed, the vehicle horn is heard and the turn signals are switched on for a short time. When the alarm button is pressed again, the alarm is switched off.

Spare key

To obtain a spare key and other vehicle keys, the vehicle chassis number is required.

Each new key contains a microchip which must be coded with the data from the vehicle electronic immobiliser. A vehicle key will not work if it does not contain a microchip or the microchip has not been encoded. This is also true for keys which are specially cut for the vehicle.

The vehicle keys or new spare keys can be obtained from a SEAT Official Service, a specialised workshop or an approved key service qualified to create this kind of key.

New keys or spare keys must be synchronised before use » page 132.

ⓘ CAUTION

All of the vehicle keys contain electronic components. Protect them from damage, impacts and humidity.

ⓘ Note


- Only use the key button when you require the corresponding function. Pushing the button unnecessarily could accidentally unlock the vehicle or trigger the alarm. It is also possible even when you are outside the radius of action.
- Key operation can be greatly influenced by overlapping radio signals close to the vehicle working in the same range of frequencies, for example, radio transmitters or mobile telephones.
- Obstacles between the remote control and the vehicle, bad weather conditions and discharged batteries can considerably reduce the range of the remote control.
- If the buttons of the vehicle key are pressed » Fig. 132 or » Fig. 133 or one of the central locking buttons » page 128 is pressed repeatedly in short succession, the central locking briefly disconnects as protection


against overloading. The vehicle is then unlocked. Lock it if necessary.

Unlocking/Locking by remote control


Read the additional information carefully

»  page 15

The vehicle will be locked again automatically if you do not open one of the doors or the rear lid within 30 seconds after unlocking the car. This function prevents the vehicle from remaining unlocked if the unlocking button is pressed by mistake. This does not apply if you press the  button for at least one second.

In vehicles with a **security central locking feature** (selective unlocking of side doors) » page 127, when the  button is pressed once, only the driver door and the fuel tank flap are unlocked. When the button is pressed a second time, all the vehicle doors are unlocked.

⚠ WARNING

Observe the safety warnings »  in Description on page 125.

ⓘ Note


- Do not use the remote control key until the vehicle is visible.

- Other functions of the remote control key » page 137, Convenience opening and closing.


Selective unlocking system

The selective unlocking system allows you to only unlock the driver door and the fuel tank flap. All other doors and the rear lid remain locked.

Unlocking the driver door and tank flap

– Press (*once*) the  button on the remote control key or turn the key *once* in the opening direction.

Unlocking all the doors, the rear lid and the tank flap simultaneously.

– Within 5 seconds, press (*twice*) the  button on the remote control key, or turn the key *twice* within 5 seconds in the opening direction.

The anti-theft security system* and the anti-theft alarm* are immediately disabled if you unlock only the driver door, without unlocking the other doors.

In vehicles with Easy Connect*, you can programme the security central locking system directly » page 128.

Adjusting the central locking

You can use Easy Connect* to select which doors are unlocked with the central locking system. Using the radio or the Easy Connect* system, you can select whether the vehicle automatically closes with the “Auto Lock” programme at speeds of more than 15 km/h (9 mph).

Programming the unlocking of the doors (vehicles with Easy Connect)

– Select: **CAR** button > **SETTINGS** function button > **Opening and closing** > **Central locking** > **Unlocking doors**.

Programming the Auto Lock (vehicles with Easy Connect)

– Select: **CAR** button > **SETTINGS** function button > **Opening and closing** > **Central locking** > **Locking while driving**.


Programming the Auto Lock (vehicles with radio)

– Select: **SETUP** button > control button > **Central locking** > **Locking while driving**.


Unlocking doors

You can choose to unlock **all** the doors or only the **driver door** when you unlock the

vehicle. In **all** the options, the fuel tank flap is also unlocked.

With the **Driver** setting, when you press the  button on the remote control key once, only the driver door is unlocked. If that button is pressed twice, the rest of the doors and the rear lid will be unlocked.


In vehicles with a conventional key, turn the key in the door lock, in the direction of opening, twice within 2 seconds.

If the  button is pressed, all the vehicle doors are locked. At the same time, a confirmation signal* is heard.

Auto Lock while driving

If you select **on**, all the vehicle doors are locked at speeds above 15 km/h (9 mph).

Central locking switch


Read the additional information carefully >>>  page 15

Please note the following when using the central locking switch to lock your vehicle:


- It is not possible to open the doors or the rear lid from the *outside* (for safety reasons, e.g. when stopped at traffic lights).
- The LED in the central locking switch lights up when all the doors are closed and locked.

- You can open the doors individually from the inside by pulling the inside door handle.
- In the event of an accident in which the airbags inflate, doors locked from the inside will be automatically unlocked to facilitate access and assistance.

WARNING

- The central locking switch also operates when the ignition is switched off and automatically locks all the vehicle doors when the  button is pressed.
- The central locking switch does not operate if the vehicle is locked from the outside and the anti-theft security system is switched on.
- Locked doors could delay assistance in an emergency, potentially putting lives at risk. Do not leave anyone, especially children, in the vehicle.

Note

Your vehicle will lock automatically when it reaches a speed of about 15 km/h (9 mph) (Auto Lock) >>> page 125. You can unlock the vehicle again using the  button on the central locking switch.

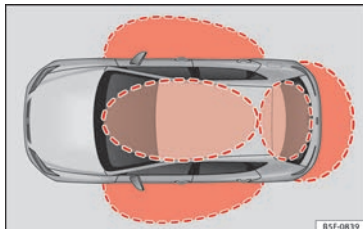
Related video Keyless Access



B5F-0842

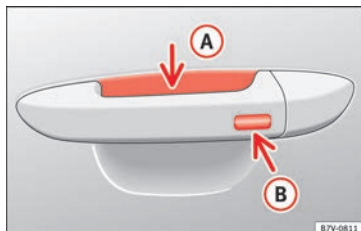
Fig. 134 Technology

Unlocking and locking the vehicle with Keyless Access*



B5F-0839

Fig. 135 Keyless Access locking and ignition system: In the proximity of the car.



B7V-0813

Fig. 136 Keyless Access locking and ignition system: sensor surface (A) for unlocking inside the door handle and sensor surface (B) for locking on the exterior of the handle.

Depending on the equipment, the vehicle may have the Keyless Access system.

Keyless Access is a key-free locking and ignition system to unlock and lock the vehicle without actively using its key. To do this, all that is required is to have a valid vehicle key in the detection area where you are attempting to access the vehicle » Fig. 135 and to touch one of the sensor surfaces on the door handles » Fig. 136 » 1.

The vehicle can be unlocked and locked via the front doors only. When doing so, the remote control key must be no further than approx. 1.5 m from the door handle.

It does not matter where you carry the key, for instance whether it is in your jacket pocket or in a briefcase.

Once the doors have been locked, they cannot be opened again immediately. This will enable you to check that the doors are properly closed.

If you wish, when unlocking, you can unlock *only* the corresponding door or the entire vehicle. The necessary adjustments can be performed in vehicles with a driver information system » page 33.

General information

If a valid key is in the proximity of the car » Fig. 135, the Keyless Access locking and starting system gives the key entry as soon as one of the sensor surfaces on the front door handles is touched. The following features are then available without having to use the vehicle key actively:

- **Keyless-Entry:** unlocking the vehicle using the handles of the front doors or the *soft-touch*/handle on the rear lid.
- **Keyless-Exit:** locking the vehicle using the sensor of the driver or passenger door handle.
- **Press & Drive:** keyless starting of the engine with the starter button » page 178.

The central locking and locking systems operate in the same way as a *normal* locking and unlocking system. Only the controls change. »

Unlocking the vehicle is confirmed with a *double* flash of the indicator lights; locking by a *single* flash.

If the vehicle is locked and then all doors and the rear lid are closed leaving the last key used inside the vehicle and none outside, the vehicle will **not** lock **immediately**. All the vehicle's indicator lights will flash *four times*. The vehicle will lock after a few seconds if you do not open any door or the rear lid.

The vehicle will lock again after a few seconds if you unlock the vehicle but fail to open any door or boot hatch.

Unlocking and opening the doors (Keyless-Entry)

- Grip one of the front door handles. In doing this, the sensor surface » **Fig. 136** (A) (arrow) on the handle is touched and the vehicle unlocks.
- Open the door.

On vehicles with selective opening or information system configuration, pulling the door handle twice will unlock all doors.

On vehicles without a “Safe” security system: shutting and locking doors (Keyless-Exit)

- Switch the ignition off.
- Close the driver's door.

- Touch (*once*) the locking sensor surface (B) (arrow) on one of the front door handles. The door that is used must be closed.

On vehicles with a “Safe” security system: shutting and locking doors (Keyless-Exit)

- Switch the ignition off.
- Close the driver's door.
- Touch (*once*) the sensor surface (B) (arrow) on one of the front door handles. The vehicle locks with the “Safe” » **page 131** system. The door that is used must be closed.
- Touch (*twice*) the sensor surface (B) (arrow) of one of the front door handles to lock the vehicle without activating the “Safe” security system » **page 131**.

Unlocking and locking the boot hatch


When the vehicle is locked, the rear lid automatically unlocks on opening if there is a valid vehicle key in the proximity » **Fig. 135**.

Open or close the rear lid *normally*.

After closing, the hatch locks automatically. If the complete vehicle is unlocked, the rear lid will **not** lock automatically after closing it.

What happens when locking the vehicle with a second key

If there is a vehicle key inside the vehicle and it is locked from the outside with a second vehicle key, the key inside the vehicle is


blocked for engine ignition » **page 178**. In order to enable engine ignition, the  button on the key inside the vehicle needs to be pressed.

Automatically disabling sensors

If the vehicle is not locked or unlocked for a long period of time, the proximity sensors on the passenger doors are automatically disabled.

If one of the sensor surfaces on the door handles is often activated in an unusual manner with the vehicle locked (e.g. by the branches of a bush rubbing against it), all proximity sensors are disabled for a certain period of time.

Sensors will again be enabled:


- After a time.
- **OR:** if the vehicle is unlocked with the  button on the key.
- **OR:** if the boot is opened.
- **OR:** if the vehicle is unlocked manually with the key.

Keyless Access temporary disconnection function*

You can deactivate the vehicle's Keyless Access unlocking for a locking and unlocking cycle.

- Move the gear lever to position **P** (if the vehicle has automatic gearbox), since otherwise the vehicle cannot be locked.

- Close the door.


- Push the central locking button  on the remote control and touch the locking sensor surface **» Fig. 136 B** on the driver door handle once within the following 5 seconds. Do not grip the door handle, otherwise the vehicle will not lock. Deactivation is also possible if the vehicle is locked through the driver's door lock.


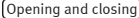
- To check that the function has been deactivated, wait at least 10 seconds, grip and pull on the door handle. The door should not open.

The next time the door can only be unlocked via the remote control or the lock cylinder. The next time the door is locked/unlocked, Keyless Access will be active again.

Convenience functions

To close all the electric windows and the sunroof using the **convenience function**, keep a finger for a few seconds on the locking sensor surface **B** (arrow) of the door handle until the windows and roof have closed.

The **doors opened** by touching the sensor surface of the door handle depend on the settings that have been activated in the infotainment system with the  button and the

 and  function buttons.

ⓘ CAUTION

The sensor surfaces on the door handles could engage if hit with a water jet or high pressure steam if there is a valid vehicle key in the proximity. If at least one of the electric windows is open and the sensor surface **B** (arrow) on one of the handles is activated continuously, all windows will close.

ⓘ Note

- If the vehicle battery has little or no charge, or the vehicle key battery is almost or entirely out of charge, you will probably not be able to lock or unlock the vehicle with the Keyless Access system. The vehicle can be unlocked or locked manually **» page 97**.

- To control the proper locking of the vehicle, the release function is disabled for approx. 2 seconds.

- If the message **Keyless access system faulty** is displayed on the screen of the dash panel, abnormalities may occur in the operation of the Keyless Access system. Contact a specialised workshop. SEAT recommends visiting a SEAT dealership for this.

- Depending on the function set on the infotainment system for the mirrors, the exterior mirrors will unfold and the surround lighting will come on when unlocking the vehicle using the sensor surface on the driver and passenger door handles **» page 150**.

- If there is no valid key inside the vehicle or the system fails to detect one, a warning will display on the dash panel screen. This could happen if any other radio frequency signal interferes with the key signal (e.g. from a mobile device accessory) or if the key is covered by another object (e.g. an aluminium case).

- If the sensors are very dirty, e.g. have a layer of salt, the correct functioning of the sensors on the door handles may be affected. In this case, clean the vehicle.

- If the vehicle is equipped with an automatic gearbox, it may only be locked in the gear stick is in position **P**.


Anti-theft security system (Safelock)*


The following message is displayed on the instrument panel to remind the driver that when the vehicle is closed from the outside, the anti-theft security system is switched on.

⚠ Do not forget the Safelock. Please see Instruction Manual. The vehicle cannot be opened from inside. This makes it more difficult for unauthorised persons to break into the vehicle **» ⚠ in Description on page 125**.

The anti-theft security system can be switched off each time the vehicle is locked:

- Turn the key a second time to the lock position, in the door lock, **within two seconds**. If **»**

necessary, remove the protective cover on the driver door handle »  page 15 or

- Press the  button on the remote control key for a second time **within 2 seconds**.

The flashing frequency of the diode in the door sill immediately confirms the process. Initially, the diode flashes in a fast sequence for a brief period, then it stops for approximately 30 seconds and, lastly continues flashing slowly.

Replacing the battery

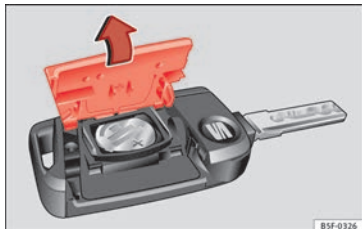


Fig. 137 Vehicle key: opening the battery compartment.

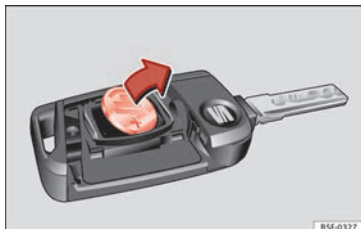




Fig. 138 Vehicle key: removing the battery.

SEAT recommends you ask a specialised workshop to replace the battery.

The battery is located to the rear of the vehicle key, under a cover.

Changing the battery

- Unfold the vehicle key blade » **page 126**.
- Remove the cover from the back of the vehicle key » **Fig. 137** in the direction of the arrow » .
- Extract the battery from the compartment using a suitable thin object » **Fig. 138**.
- Place the new battery in the compartment as shown » **Fig. 138**, pressing in the opposite direction to that shown by the arrow » .
- Fit the cover as shown » **Fig. 137**, pressing it onto the vehicle key casing in the opposite direction to that shown by the arrow until it clicks into place.


CAUTION



- If the battery is not changed correctly, the vehicle key may be damaged.
- Use of unsuitable batteries may damage the vehicle key. For this reason, always replace the dead battery with another of the same voltage, size and specifications.
- When fitting the battery, check that the polarity is correct.

For the sake of the environment

Please dispose of your used batteries correctly and with respect for the environment.

Synchronising the vehicle key

If the  button is pressed frequently outside of the vehicle range, it is possible that the vehicle can no longer be locked or unlocked using the key. In this case, the key must be re-synchronised as described below:

- Unfold the vehicle key blade » **page 126**.
- If necessary, remove the cover from the driver door lever »  **page 15**.
- Press the  button on the vehicle key. For this, it must remain with the vehicle.
- Open the vehicle within one minute using the key blade. The key has been synchronised.
- If necessary, fit the cap.

Childproof lock

✓ Applies to vehicles with 5 doors:

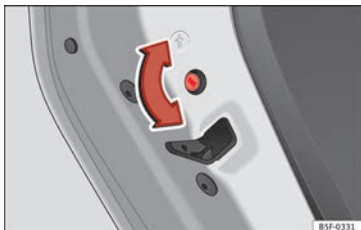


Fig. 139 Childproof lock on the left hand side door.

The childproof lock prevents the rear doors from being opened from the inside. This system prevents minors from opening a door accidentally while the vehicle is running.

This function is independent of the vehicle electronic opening and locking systems. It only affects rear doors. It can only be activated and deactivated manually, as described below:

Activating the childproof lock

- Unlock the vehicle and open the door in which you wish to activate the childproof lock.
- With the door open, rotate the groove in the door using the ignition key, clockwise for the left hand side doors » **Fig. 139** and

anti-clockwise for the right hand side doors.

Deactivating the childproof lock

- Unlock the vehicle and open the door whose childproof lock you want to deactivate.
- With the door open, rotate the groove in the door using the ignition key, anti-clockwise for the left hand side doors » **Fig. 139** and clockwise for the right hand side doors.

Once the childproof lock is activated, the door can only be opened from the outside. The childproof lock can be activated or deactivated by inserting the key in the groove when the door is open, as described above.

Anti-theft alarm system*

Description

The anti-theft alarm makes it more difficult to break into the vehicle or steal it.

The anti-theft alarm is automatically turned on when the vehicle is locked with the key.

- The turn signal light will flash twice on opening and deactivating the alarm.

- The turn signal light will flash once on closing and activating the alarm.

When does the system trigger an alarm?

The anti-theft alarm siren will be triggered for about 30 seconds accompanied by sound and optical (flashing) warning signals and will be repeated about ten times when the vehicle is locked and the following unauthorised actions are attempted:


- Opening a door that is mechanically unlocked using the vehicle key without switching on the ignition in the next 15 seconds (in certain markets, such as the Netherlands, there is no 15 second waiting time and the alarm is activated immediately on opening the door).
- A door is opened.
- The bonnet is opened.
- The rear lid is opened.
- When the ignition is switched on with a non-authorized key.
- When the vehicle battery is disconnected.
- Movement inside the vehicle (in vehicles with interior monitoring » **page 135**).
- When the vehicle is towed (in vehicles with anti-tow system » **page 135**).
- When the vehicle is raised (in vehicles with anti-tow system » **page 135**).

- When the vehicle is transported on a ferry or by rail (vehicles with an anti-tow system or vehicle interior monitoring »» page 135).
- When a trailer connected to the anti-theft alarm system is disconnected.

How to turn OFF the alarm

Unlock the vehicle with the unlocking button on the key or turn on the ignition with a valid key.

Note

- After 28 days, the indicator light will be switched off to prevent the battery from exhausting if the vehicle has been left parked for a long period of time. The alarm system remains activated.
- If, after the audible warning goes off, another monitored area is accessed (e.g. the rear lid is opened after a door has been opened), the alarm is triggered again.
- The anti-theft alarm is not activated when the vehicle is locked from within using the central locking button .
- If the driver door is unlocked mechanically with the key, only the driver door is unlocked, the rest of the doors remain locked. Only when the ignition has been turned on will the other doors be available - but not unlocked - and the central locking button will be activated.

- If the vehicle battery is run down or flat then the anti-theft alarm will not operate correctly.
- Vehicle monitoring remains active even if the battery is disconnected or not working for any reason.
- The alarm is triggered immediately if one of the battery cables is disconnected while the alarm system is active.


Vehicle interior monitoring and anti-tow system*


It is a monitoring or control function incorporated in the anti-theft alarm* which detects unauthorised vehicle entry by means of ultrasound.

Activation

- It is automatically switched on when the anti-theft alarm is activated.

Deactivation

- Open the vehicle with the key, either mechanically or by pressing the  button on the remote control. The time period from when the door is opened until the key is inserted in the contact should not exceed 15 seconds, otherwise the alarm will be triggered.

- Press the  button on the remote control twice. The volumetric sensor and tilt sensors will be deactivated. The alarm system remains activated.

The vehicle interior monitoring and the anti-tow system are automatically switched on again next time the vehicle is locked.

The vehicle interior monitoring and anti-tow sensor (tilt sensor) are automatically switched on when the anti-theft alarm is switched on. In order to activate it, all the doors and the rear lid must be closed.

If you wish to switch off the vehicle interior monitoring and the anti-tow system, it must be done each time that the vehicle is locked; if not, they will be automatically switched on.

The vehicle interior monitoring and the anti-tow system should be switched off if animals are left inside the locked vehicle (otherwise, their movements will trigger the alarm) or when, for example, the vehicle is transported or has to be towed with only one axle on the ground.

False alarms

Interior monitoring will only operate correctly if the vehicle is completely closed. Please observe related legal requirements.

The following cases may cause a false alarm:

- Open windows (partially or fully).

- Panoramic/tilting sunroof open (partially or completely).
- Movement of objects inside the vehicle, such as loose papers, items hanging from the rear vision mirror (air fresheners), etc.

Note

- **If the vehicle is relocked and the alarm is activated without the volumetric sensor function, relocking will activate the alarm with all its functions, except the volumetric sensor. This function is reactivated when the alarm is switched on again, unless it is deliberately switched off.**
- **If the alarm has been triggered by the volumetric sensor, this will be indicated by a flashing of the warning lamp on the driver door when the vehicle is opened. The flash is different to the flash indicating the alarm is activated.**
- **The vibration of a mobile phone left inside the vehicle may cause the vehicle interior monitoring alarm to trigger, as both sensors react to movements and shakes inside the vehicle.**
- **If on activating the alarm, any door or the rear lid is open, only the alarm will be activated. The vehicle interior monitoring and the anti-tow system will only be activated once all the doors are closed (including the rear lid).**

Deactivating the vehicle interior monitoring and anti-tow system*

When the vehicle is locked, the alarm will be triggered if movements are detected in the interior (e.g. by animals) or if the vehicle's inclination is changed (e.g. during transport). You can prevent the alarm from being triggered accidentally by switching off the vehicle interior monitoring and/or tow-away protection.

- To switch off the interior monitoring and tow-away protection, switch off the ignition and, using the Infotainment system, select: **[CAR]** button > **[SETTINGS]** function button > Opening and closing > Central locking > Switch off alarm.
- When the vehicle is locked now, the vehicle interior monitoring and the tow-away protection are switched off until the next time the door is opened.


If the anti-theft security system (Safelock)* >>> page 131 is switched off, the vehicle interior monitoring and the tow-away protection are automatically switched off.


⚠ WARNING

Observe the safety warnings >>> ⚠ in Description on page 125.


Rear lid (luggage compartment)

Rear lid automatic locking

Where the vehicle has been locked by pressing the  button on the remote control with the rear lid open, the rear lid will lock automatically when closed.

The automatic rear lid locking time extension function can be activated. Where this function is activated and once the rear lid has been unlocked by pressing the  button on the remote control key >>> page 127, the rear lid can be re-opened for a certain length of time.

Where required, the automatic tailgate locking time extension function can be activated or deactivated at an Authorised SEAT Service, which will provide all the necessary information.

Before the vehicle locks automatically, there is a risk of intruders getting into the vehicle. Therefore, we recommend you always lock the vehicle by pressing the  button on the remote control or by using the central locking button.

⚠ WARNING

Observe the safety warnings >>> ⚠ in Introduction on page 97.



- Always close the rear lid properly. Risk of accident or injury.
- The rear lid must not be opened when the reverse or rear fog lights are lit. This may damage the tail lights.
- Do not close the rear lid by pushing it down with your hand on the rear window. The glass could smash. Risk of injury!
- Ensure the rear lid is locked after closing it. If not, it may open unexpectedly while driving.
- Closing the rear lid without observing and ensuring it is clear could cause serious injury to you and to third parties. Make sure that no one is in the path of the rear lid.
- Never drive with the rear lid open or half-closed, exhaust gases may penetrate into the interior of the vehicle. Danger of poisoning!
- If you only open the rear lid, do not leave the key inside. The vehicle cannot be opened if the key is left inside.

Controls for the windows

Opening and closing of the electric windows*

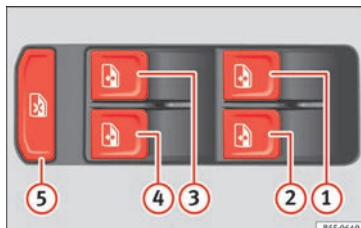


Fig. 140 Detail of the driver door: controls for the windows (5-door vehicle with front and rear electric windows).

Read the additional information carefully

» page 18

The front and rear electric windows can be operated by using the controls on the driver door. The other doors each have a switch for their own window.

Always close the windows fully if you park the vehicle or leave it unattended » .

You can use the electric windows for approx. 10 minutes after switching off the ignition if neither the driver door nor the front passenger door has been opened and the key has not been removed from the ignition.

Safety switch * (only in 5-door vehicles)

The safety switch » **Fig. 140** on the driver door can be used to disable the electric window buttons on the rear doors.

- *Safety switch not pressed:* buttons on rear doors are activated.
- *Safety switch pressed:* buttons on rear doors are deactivated.

The safety control symbol lights up in yellow if the buttons on the rear doors are switched off.

WARNING

Observe the safety warnings » in Introduction on page 97.

- Incorrect use of the electric windows can result in injury.
- Never close the rear lid without observing and ensuring it is clear, to do otherwise could cause serious injury to you and third parties. Make sure that no one is in the path of a window.
- The engine may accidentally be started and be out of control.
- If the ignition is switched on, the electric equipment could be activated with risk of injury, for example, in the electric windows.
- The doors can be locked using the remote control key. This could become an obstacle for assistance in an emergency situation.

- Therefore always take the key with you when you leave the vehicle.
- The electric windows will work until the ignition has been switched off and one of the front doors has been opened.
- If necessary, use the safety switch to disable the rear electric windows. Make sure that they have been disabled.

Note

If the window is not able to close because it is stiff or because of an obstruction, the window will automatically open again »» page 137. If this happens, check why the window could not be closed before attempting to close it again.

Roll-back function

The roll-back function reduces the risk of injury when the electric windows close.

- If a window is obstructed when closing automatically, the window stops at this point and lowers immediately »» ⚠.
- Next, check why the window does not close before attempting it again.
- If you try within the following 10 seconds and the window closes again with difficulty or there is an obstruction, the automatic closing will stop working for 10 seconds.

- If the window is still obstructed, the window will stop at this point.
- If there is no obvious reason why the window cannot be closed, try to close it again by pulling the tab within ten seconds. The window closes with maximum force. **The roll-back function is now deactivated.**
- If more than 10 seconds pass, the window will open fully when you operate one of the buttons. One-touch closing is reactivated.

⚠ WARNING


Observe the safety warnings »» ⚠ in Opening and closing of the electric windows* on page 136.


- The roll-back function does not prevent fingers or other parts of the body getting pinched against the window frame. Risk of accident.

Convenience opening and closing


Use the convenience opening/closing function to easily open/close all the windows and the sliding/tilting sunroof* from the outside.

Convenience open function


- Press and hold the  button on the remote control key until all the windows and the sliding/tilting sunroof* have reached the desired position, or

- First unlock the vehicle using the  button on the remote control key and then keep the key in the driver door lock until all the windows and the sliding/tilting sunroof* have reached the required position.

Convenience close function

- Press and hold button  on the remote control key until all the windows and the sliding/tilting sunroof* are closed »» ⚠, or
- Keep the key in the driver door in the "lock" position until all the windows and the sliding/tilting sunroof* are closed.

Programming convenience opening in the Easy Connect*

- Select:  button > function button **SETTINGS > Opening and closing > Central locking > Opening the window by holding down button or Front window on/off or Roof on/off***.

⚠ WARNING

- Take care when closing the sliding/tilting sunroof* and windows. There is a risk of suffering injury.
- For safety reasons, you should only use the remote control open and close functions within about 2 metres of the vehicle. To avoid injuries, always keep an eye on the windows »»

and the sliding/tilting sunroof* when pressing the button to close them. The windows stop moving as soon as the button is released.

One-touch opening and closing*

One-touch opening and closing means you do not have to hold down the button.

Buttons » Fig. 140 ①, ②, ③ and ④ have two positions for opening windows and two for closing them. This makes it easier to open and close windows to the desired position.

One-touch closing

– Pull up the window button briefly up to the second position. The window closes fully.

One-touch opening

– Push down the window button briefly up to the second position. The window opens fully.

Resetting one-touch opening and closing

The automatic open and close function will not work if the battery has been temporarily disconnected. The function can be restored as follows:


– Close the window as far as it will go by lifting and holding the electric window switch.

– Release the switch and then lift it again for 1 second. This will re-enable the automatic function.

If you push (or pull) a button to the first stage, the window will open (or close) until you release the button. If you push or lift the button briefly to the second stage, the window will open (one-touch opening) or close (one-touch closing) automatically. If you operate the button while the window is opening or closing, it stops at this position.

Panoramic sliding sunroof*

Opening or closing the panoramic sliding sunroof

Read the additional information carefully »  page 18

The panoramic sliding sunroof will only work with the ignition on. It can be opened or closed for a few minutes after the ignition has been switched off, provided the driver door and the front passenger door are not opened.

WARNING

Careless or uncontrolled use of the panoramic sliding sunroof can cause serious injuries.

- Only open or close the panoramic sliding sunroof and the sun blind* when nobody is in the way.

- The panoramic sliding sunroof can be operated for up to about ten minutes after the ignition has been switched off, provided the driver door and the front passenger door are not opened.

CAUTION

Check that when the rear lid is opened it does not bump against loads carried on the roof. When a roof carrier is fitted, DO NOT open the panoramic roof*.

Note

- Leaves and other loose objects that accumulate on the sun roof rails should be regularly cleaned away either by hand or with a vacuum.
- In case of a fault in the operation of the panoramic sliding sunroof, the anti-trap function will not operate correctly. Contact a specialised workshop.

Opening and closing the sun blind*

✓ Valid for vehicles: with sun blinds

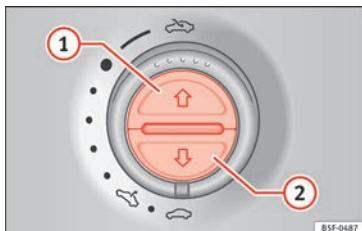


Fig. 141 On the interior roof lining: switches for the sun blind.

Function	Action
Opening completely (automatic function)	Press button » Fig. 141 ① briefly.
Stop automatic operation	Press button ① or button ② briefly.
To set the intermediate position	Press button ① or button ② until the correct position is set.
Closing completely (automatic function)	Press the button ② briefly.

Once the ignition has been switched off, you can still open or close the sun blind for a few minutes provided the driver door and the front passenger door are not opened.

Convenience closing of the panoramic sliding sunroof

The panoramic sliding sunroof can be opened or closed from outside the vehicle using the vehicle key:

- Keep the vehicle unlocking or locking button pressed. The panoramic sliding sunroof is adjusted or closes.
- Release the unlock or lock button to stop the function.

During convenience closing, the windows and the panoramic sliding sunroof close at the same time.

Note

The rotary button of the panoramic sliding sunroof remains in the last position selected if the roof is closed using convenience closing from outside the vehicle, and will have to be re-positioned the next time you drive.

Roll-back function of the panoramic sliding sunroof and the sun blind*

The anti-trap function reduces the risk of injury when opening and closing the panoramic sliding sunroof and sun blind » » ⚠. When it encounters an obstacle while closing, it rolls back and opens again.

- Check why the panoramic sliding sunroof or the sun blind does not close.
- Try and close them again.
- If the panoramic sliding sunroof or sun blind is still obstructed, it will stop at the corresponding position. Close it without the anti-trap function.

Closing without the roll-back function

- The switch should be in the “closed position” » » 📖 page 18 ①.
- *Panoramic sliding sunroof*: Within five seconds of triggering the anti-trap function, pull the control all the way back » » 📖 page 18 (arrow ⑤) until the panoramic sliding sunroof closes fully.
- *Sun blind*: Within five seconds of triggering the anti-trap function, press button » » Fig. 141 ② until the sun blind closes fully.
- **The panoramic sliding sunroof and sun blind close without the anti-trap function.**
- If the panoramic sliding sunroof still cannot be closed, visit a specialised workshop.

⚠ WARNING

Closing the panoramic sliding sunroof or sun blind without the anti-trap function can cause serious injuries.

- **Always close the panoramic sliding sunroof carefully.** »

- Nobody should be in the way of the panoramic sliding sunroof or sun blind, especially when they are closed without the anti-trap function.
- The anti-trap function does not prevent fingers or other parts of the body getting pinched against the window frame and causing injury.


Note

The anti-trap function is activated if the windows and the panoramic sliding sunroof are closed from the outside of the vehicle using the ignition key for convenience closing »» page 137.

Lights and visibility

Lights



Side light and dipped beam headlight

Read the additional information carefully »»  page 30

The driver is personally responsible for the correct use and adjustment of the lights in all situations.

Audible warnings to advise the driver that the lights have not been switched off

If the key is not in the ignition and the driver door is open, an audible warning signal is heard in the following cases: this is a reminder to turn off the lights.

- When the parking light is on »» page 141.
- When the light switch is in position  or .

WARNING

The side lights or daytime running lights are not bright enough to illuminate the road ahead and to ensure that other road users are able to see you.

- Always use your dipped beam head lights if it is raining or if visibility is poor.

WARNING


If the headlights are set too high and not used correctly, there is a risk of dazzling or distracting other road users. This could result in a serious accident.

- Always make sure that the headlights are correctly adjusted.

Note

The legal requirements regarding the use of vehicle lights in each country must be observed.

Daytime running lights

The daytime running lights consist of individual lights, integrated in the front headlights. With the daylight driving lights on, only these lights switch on »» .

The daytime running lights switch on every time the ignition is switched on, if the switch is in positions **0** or **AUTO**, according to the level of exterior lighting.

When the light switch is in position **AUTO**, a light sensor automatically switches dipped beam on and off (including the control and instrument lighting) or the daytime running lights depending on the level of exterior lighting.

WARNING

- Never drive with daytime lights if the road is not well lit due to weather or lighting conditions. Daytime lights do not provide enough light to illuminate the road properly or be seen by other road users.
- The rear lights do not come on with the daytime driving light. A vehicle which does not have the rear lights on may not be visible to other drivers in the darkness, in the case of heavy rain or in conditions of poor visibility.

Turn signal and main beam lever



Read the additional information carefully

»  page 31

Push the lever all the way down to turn off the corresponding function.

Convenience turn signals

For the one-touch signalling, when the ignition is switched on, move the lever as far as possible upwards or downwards and release the lever. The turn signal will flash three times.

One-touch signalling is activated and deactivated in the Easy Connect system via the  button and the function button **SETTINGS** > **Lights** > **One-touch signalling** »  page 33.

In vehicles that do not have the corresponding menu, this function can be deactivated in a specialised workshop.

WARNING

Improper or lack of use of the turn signals, or forgetting to deactivate them can confuse other road users. This could result in a serious accident.

- Always give warning when you are going to change lane, overtake or when turning, activating the turn signal in good time.
- As soon as you have finished changing lane, overtaking or turning, switch the turn signal off.

WARNING

Incorrect use of the headlights may cause accidents and serious injury, as the main beam may distract or dazzle other drivers.

Note


- If the convenience turn signals are operating (three flashes) and the other convenience turn signals are switched on, the active part stops flashing and only flashes once in the new part selected.
- The turn signal only works when the ignition is switched on. The hazard warning lights also work when the ignition is switched off.

- If a trailer turn signal malfunctions, the control lamp will stop flashing (trailer turn signals) and the vehicle turn signal will flash at double speed.

- The *main beam headlights* can only be switched on if the dipped beam headlights are already on.
- In cold or damp weather conditions, the headlights, tail lights and turn signals may mist up inside temporarily. This is normal and in no way effects the useful life of the vehicle lighting system.

Automatic dipped beam control AUTO*

The automatic dipped beam control is merely intended as an aid and is not able to recognise all driving situations.

When the light switch is in position **AUTO**, the vehicle lights and the instrument panel and switch lighting switch on and off automatically in the following situations »  in **Daytime running lights** on page 141:

Automatic switching on	Automatic switching off
The photo sensor detects <i>darkness</i> , for example, when driving through a tunnel.	When adequate lighting is detected. »

Automatic switching on	Automatic switching off
The rain sensor detects rain and activates the windscreen wipers.	When the windscreen wipers have been inactive for a few minutes.

⚠ WARNING

If the road is not well lit and other road users cannot see the vehicle well enough or at all, accidents may occur.

- **The automatic dipped beam control (AUTO) only switches on the dipped beam when there are no changes in brightness, and not, for example when it is foggy.**

Main beam assist*

Main beam assist (Light Assist)



The main beam assist acts within the limits of the system and depending on environmental and traffic conditions. Once switched on, the system is activated as of a speed of about 60 km/h (37 mph) and is deactivated below about 30 km/h (18 mph) »» ⚠.

When the system is activated and the camera detects other vehicles that may be dazzled, the main beam is automatically switched off. Otherwise, the main beam is automatically switched on.

The main beam assist generally detects illuminated areas and deactivates the main

beam when passing through a town, for example.

Switching the main beam assist on and off

Function	Use
Activate: 	– Switch the ignition on and turn the light switch to position AUTO . – From the base position, move the main beam and turn signal lever forwards »» page 141. When the warning lamp  is displayed on the instrument panel display, the main beam assist is switched on.
To switch system off:	– Switch off the ignition. – OR: turn the light switch to a different position to AUTO »» page 140. – OR: with main beam on, move the main beam and turn signal lever backwards. – OR: move the main beam and turn the signal lever forwards to manually switch the main beam on. The main beam assist will then be deactivated.

Malfunctions

The following conditions may prevent the main beam headlight control from turning off the headlights in time or from turning off altogether:

- In poorly lit towns with highly reflective signs.
- Other insufficiently lit road users (such as pedestrians or cyclists).

- On tight bends and steep slopes (bumps) and when oncoming vehicles are partially obscured.

- When the drivers of other oncoming vehicles (such as a truck) can see over a guard rail in the centre of the road.

- If the camera is damaged or the power supply is cut off.

- In fog, snow and heavy rain.

- With dust and sand turbulence.

- With loose gravel in the field of vision of the camera.

- When the field of vision of the camera is misted up, dirty or covered by stickers, snow, ice, etc.

⚠ WARNING

The convenience features of the main beam assist should not encourage the taking of risks. The system is not a replacement for driver concentration.

- **You are always in control of the main beam and adapting it to the light, visibility and traffic conditions.**

- **It is possible that the main beam headlight control does not recognise all driving situations and is limited under certain circumstances.**

- **When the field of vision of the camera is dirty, covered or damaged, operation of the main beam control may be affected. This also applies when changes are made to the**

vehicle lighting system, for example, if additional headlights are installed.

ⓘ CAUTION

To avoid affecting the operation of the system, take the following points into consideration:

- Clean the field of vision of the camera regularly and make sure it is free of snow and ice.
- Do not cover the field of vision of the camera.
- Check that the windscreen is not damaged in the area of the field of vision of the camera.

ⓘ Note

Main beam and headlight flasher can be turned on and off manually at any time with the turn signal and main beam lever » page 141.

Fog lights



Fig. 142 Dash panel: light control.

The warning lamps Ⓜ or Ⓝ also show, on the light switch or instrument panel, when the fog lights are on.

- Switching on front fog lights* Ⓜ : pull the light switch to the first point » Fig. 142 ①, from positions Ⓝ , Ⓜ or **AUTO**.
- Switching on the rear fog light Ⓝ : completely pull the light switch ② from position Ⓝ , Ⓜ or **AUTO**.
- To switch off the fog lights, press the light switch or turn it to position **0**.

ⓘ Note

The rear fog light can dazzle drivers behind you. You should use the rear fog light only when visibility is very poor. For this reason, if you exceed approximately 60 km/h (38 mph), the instrument panel will display the following warning: Switch off the fog light!

Cornering lights*¹⁾

When turning slowly or on very tight bends, the cornering lights are activated automatically. The cornering lights may be integrated in the fog lights and are switched on only at speeds of less than 40 km/h (25 mph).

When reverse gear is engaged, the cornering lights on both sides of the vehicle switch on, in order to better illuminate the area for parking.

Function “Coming home”

This function may be connected/disconnected through the radio menu. The “Coming Home” and/or “Leaving Home” delay time may also be set (default: 30 sec).

¹⁾ This function is not available on vehicles equipped with full-LED headlights and bulb fog lights.

Vehicle with halogen headlights


In the “Coming Home” function, the daytime running lights (DRL), the rear side lights and the licence plate lights are turned on.

Vehicle with full-LED headlights

In the “Coming Home” function, the dipped beams and the daytime running lights (DRL), the rear side lights and the licence plate lights are switched on.

Automatic* activation of “Coming Home”

For vehicles with a light and rain sensor (rotary light switch in position **AUTO**).

- Switch off the engine and remove the key from the ignition with the rotary light switch in position **AUTO** »  page 30.
- The automatic “Coming Home” function is only active when the light sensor detects darkness.
- When the car door is opened, the “Coming Home” lighting comes on.


Manual “Coming Home” activation

For vehicles with a light and rain sensor (rotary light switch without position **AUTO**).

- Switch off the engine and remove the key from the ignition.
- Activate the headlight flashers for approximately 1 second.
- Activated for any position of the rotary light switch.

- When the car door is opened, the “Coming Home” lighting comes on. The headlights are turned off 60 seconds after the vehicle door is opened.

Deactivation

- If no door has been closed, they go out automatically after 60 seconds.
- After the last door has been closed, the headlights will be switched off after the “Coming Home” delay (as established in the radio menu) has elapsed.
- On turning the light switch to position 0 »  page 30.
- When the ignition is switched on (when starting the engine).

Function “Leaving Home”

The “Leaving Home” function is only available for vehicles with a light and rain sensor (rotary light switch in position **AUTO**).

This function may be connected/disconnected through the radio menu. The “Leaving Home” function switch-off delay may also be set (default: 30 sec).

Vehicle with halogen headlights

In the “Leaving Home” function, the daytime running lights (DRL), the rear side lights and the licence plate lights are switched on.

Vehicle with full-LED headlights

In the “Leaving Home” function, the dipped beams, the daytime running lights (DRL), the rear side lights and the licence plate lights are switched on.

Activation

- When the vehicle is unlocked using the remote control.
- The “Leaving Home” function is only activated when the rotary light switch is in position **AUTO** and the light sensor detects darkness.

Deactivation

- When the “Leaving Home” delay period ends (default: 30 sec).
- When the vehicle is locked using the remote control.
- When the light control is switched into a position other than **AUTO**.
- With the ignition is switched on.

Hazard warning lights

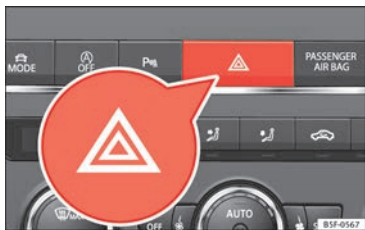



Fig. 143 Dash panel: switch for hazard warning lights.

Read the additional information carefully



»  page 31

The hazard warning lights are used to draw the attention of other road users to your vehicle in emergencies.

If your vehicle breaks down:

1. Park your vehicle at a safe distance from moving traffic.
2. Press the button to switch on the hazard warning lights » .
3. Switch the ignition off.
4. Apply the handbrake.
5. For a manual gearbox, engage 1st gear; for an automatic gearbox, move the gear lever to **P**.

6. Use the warning triangle to draw the attention of other road users to your vehicle.
7. Always take the vehicle key with you when you leave the vehicle.

All turn signals flash simultaneously when the hazard warning lights are switched on. The two turn signal turn signal lamps  and the turn signal lamp in the switch  will flash at the same time. The simultaneous hazard warning lights also work when the ignition is switched off.

Emergency braking warning

If the vehicle brakes suddenly and continuously at a speed of more than 80 km/h (50 mph), the brake light flashes several times per second to warn the vehicles driving behind. If you continue braking, the hazard warning lights will come on automatically when the vehicle comes to a standstill. They switch off automatically when the vehicle starts to move again.

WARNING

- The risk of an accident increases if your vehicle breaks down. Always use the hazard warning lights and a warning triangle to draw the attention of other road users to your stationary vehicle.
- Due to the high temperatures that the catalytic converter can reach, never park in an area where the catalytic converter could come

into contact with highly inflammable materials, for example dry grass or spilt petrol. This could start a fire.


Note

- The battery will run down if the hazard warning lights are left on for a long time, even if the ignition is switched off.
- The use of the hazard warning lights described here is subject to the relevant statutory requirements.

Parking lights

When the parking light is switched on, (right or left turn signal), the front side light and the rear light on the corresponding side of the vehicle stay lit. The parking lights can only be activated with the ignition switched off and the turn signal and main beam lever in the central position, before being triggered.

Parking light on both sides

With the ignition switched off and the light switch in position , when locking the vehicle from the outside, the parking lights on both sides of the vehicle light up. In doing so, only the side lights of both headlights light up, and additionally the tail lights will do so partially.

Motorway light*

The motorway light is available on vehicles equipped with full-LED lights.

The function is connected/disconnected via the corresponding Easy Connect system menu.

- **Activation:** when going above 110 km/h (68 mph) for more than 30 seconds, the dipped beam raises slightly to increase the driver's visibility distance.
- **Deactivation:** when reducing the speed of the car below 100 km/h (62 mph), the dipped beam returns to its normal position.

Driving abroad

The light beam of the dipped beam lights is asymmetric: the side of the road on which you are driving is lit more intensely.

When a car that is manufactured in a country that drives on the right travels to a country that drives on the left (or vice versa), it is normally necessary to cover part of the headlight bulbs with stickers or to change the adjustment of the headlights to avoid dazzling other drivers.

In such cases, the regulations specify certain light values that must be complied with for designated points of the light distribution. This is known as "Tourist light".

The light distribution that the halogen and full-LED headlights of the SEAT Leon range have allows the specific "tourist light" values to be met without the need for stickers or changes in the settings.

Note

"Tourist light" is only allowed temporarily. If you are planning a long stay in a country that drives on the other side, you should take the vehicle to an Authorised Technical Service to change the headlights.

Headlight range control



Fig. 144 Next to the steering wheel: Headlight range control

The lights range control adapts according to the value of the headlight beam and the vehicle load status. This offers the driver optimum visibility and the headlights do not dazzle oncoming drivers »» » ⚠.


The headlights can only be adjusted when the dipped beam is switched on.

To reset, turn switch »» » **Fig. 144:**

Value	Vehicle load status ^{a)}
–	Two front occupants, luggage compartment empty
1	All seats occupied, luggage compartment empty
2	All seats occupied, luggage compartment full. With trailer and minimum drawbar load.
3	Driver only, luggage compartment full With trailer and maximum drawbar load.

^{a)} If the vehicle load does not correspond to those shown in the table, it is possible to select intermediary positions.

OR:

Using the Easy Connect system, by means of the **CAR** button and the function button **SETTINGS > Lights > Headlight height adjustment** »» »  page 33).

Setting 0	Two front occupants, luggage compartment empty
Setting 1	All seats occupied, luggage compartment empty
Setting 2	All seats occupied, luggage compartment full. With trailer and minimum drawbar load.

Setting 3

Driver only, luggage compartment full
Driving with trailer and minimum draw-
bar load.

Dynamic headlight range control



The control is not mounted in vehicles with dynamic headlight range control. The headlight range is automatically adjusted according to the vehicle load status when they are switched on.

WARNING

Heavy objects in the vehicle may mean that the headlights dazzle and distract other drivers. This could result in a serious accident.

- **Adjust the light beam to the vehicle load status so that it does not blind other drivers.**


Lighting of the instrument panel, screens and controls

Depending on the model, the lighting of the instrument panel and controls can be adjusted in the Easy Connect system, using the  button and the **SETTINGS** function button  **page 33**.

¹⁾ Depending on the level of equipment fitted in the vehicle, LEDs can be used for the following interior lights: front courtesy light, rear courtesy light, footwell light, sun blind and glove compartment light.

With the ignition on and without light activation, the instrument panel lighting remains activated in daytime light conditions. The lighting is reduced as the exterior light diminishes. In some cases, e.g. when driving through a tunnel without the **AUTO** function active, the instrument panel lighting may even switch off. The objective of this function is to provide the driver with a visual indication that he or she should activate the dipped beam.

Interior and reading lights¹⁾



Read the additional information carefully  **page 32**

Glove compartment and luggage compartment lighting*

When opening and closing the glove compartment on the front passenger side and the rear lid, the respective light will automatically switch on and off.



Footwell lighting*

The lights in the footwell area below the dash (driver and front passenger sides) will switch

on when the doors are opened and will decrease in intensity while driving. This brightness can be adjusted using the Easy Connect system, by means of the  button and the function button **SETTINGS > Lights > Interior Lighting**  **page 33**).

Ambient light*

The ambient light lights up the area of the centre console, the footwell area and, depending on the version, the front door panels.

The ambient lighting in the door panels may change colour. Brightness and colour can be adjusted using the Easy Connect system, by means of the  button and the function button **SETTINGS > Lights > Interior Lighting**  **page 33**).

Note

The reading lights switch off when the vehicle is locked using a key or after several minutes if the key is removed from the ignition. This prevents the battery from discharging.

Visibility

Sun visors

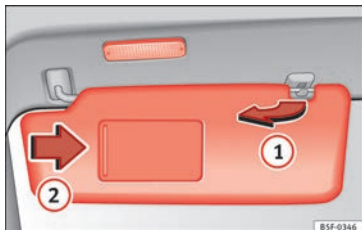


Fig. 145 Sun visor

Options for adjusting driver and front passenger sun visors:

- Lower the sun visor towards the windscreen.
- The sun visor can be pulled out of its mounting and turned towards the door
» Fig. 145 ①.
- Swing the sun visor towards the door, longitudinally backwards.

Vanity mirror light

There may be a vanity mirror, with a cover, on the rear of the sun visor. When the cover is opened ② a light comes on.

The lamp goes out when the vanity mirror cover is closed or the sun visor is pushed back up.

⚠ WARNING

Folded sun blinds can reduce visibility.

- Always store sun blinds and visors in their housing when not in use.

i Note

The light above the sun visor automatically switches off after a few minutes in certain conditions. This prevents the battery from discharging.

Sun blind*

✓ Applies to the model: LEON ST

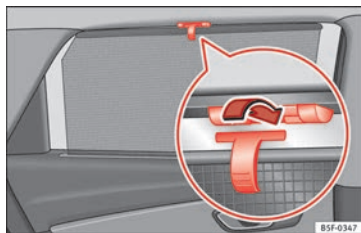


Fig. 146 Rear window: sun blind.

Rear window sun blind*

- Pull out the visor and hook it into the hooks in the centre of the top of the door frame
» Fig. 146.

Windscreen wiper and window wiper systems


Window wiper lever

Read the additional information carefully
» page 32

ⓘ CAUTION

If the ignition is switched off with the windscreen wipers active, they complete their wipe before returning to the rest position. Ice, snow and other obstacles on the windscreen may damage the wiper and the windscreen wiper motor.

- If necessary, remove snow and ice from the windscreen wipers before starting your journey.
- Carefully lift the frozen windscreen wipers from the glass. SEAT recommends a de-icer spray for this operation.
- Do not switch on the windscreen wipers if the windscreen is dry. Cleaning with the windscreen wipers while dry can cause damage.

- In icy conditions, always check that the wiper blades are not frozen to the glass before using the wipers. In cold weather, it may help to leave the vehicle parked with the wipers in service position »  page 72.

Note

- The windscreen and window wipers only function when the ignition is switched on and the bonnet or rear lid, respectively, are closed.
- The interval wipe speed varies according to the vehicle speed. The faster the vehicle is moving, the more often the windscreen is cleaned.
- The rear wiper is automatically switched on when the windscreen wiper is on and the car is in reverse gear.

Windscreen wiper functions

Windscreen wiper performance in different situations

If the vehicle is at a standstill	The activated position provisionally changes to the previous position.
During automatic wipe	The air conditioner comes on for approximately 30 seconds in air recirculation mode to prevent the smell of the windscreen washer fluid entering the inside of the vehicle.

Windscreen wiper performance in different situations

For the interval wipe	Intervals between wipes depend on the vehicle's speed. The higher the vehicle speed the shorter the intervals.
-----------------------	--

Heated windscreen washer jets

The heating only thaws the frozen jets, it does not thaw the water in the washer hoses. When the ignition is switched on the heated windscreen washer jets automatically adjust the heat depending on the ambient temperature.

Headlight wash/wipe system

The headlight washers/wipers clean the headlight lenses.

After the ignition is switched on, the first and every fifth time the windscreen washer is switched on, the headlights are also washed. Therefore, the windscreen wiper lever should be pulled towards the steering wheel when the dipped beam or main beam are on. Any incrusted dirt (such as insects) should be cleaned regularly (e.g. when refuelling).

To ensure the headlight washers work correctly in winter, any snow which has got into the bumper jet supports should be cleaned away. If necessary, remove snow with an anti-icing spray.

Note

The wiper will try to wipe away any obstacles that are on the windscreen. The wiper will stop moving if the obstacle blocks its path. Remove the obstacle and switch the wiper back on again.

Rain sensor*

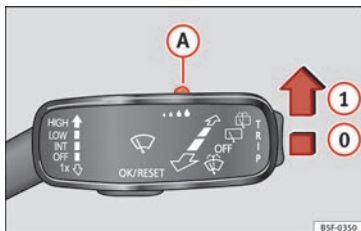


Fig. 147 Windscreen wiper lever: adjusting the rain sensor (A)

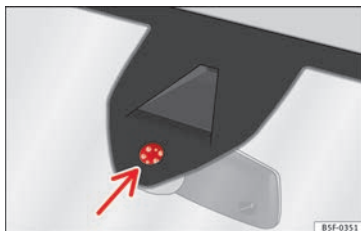


Fig. 148 Rain sensor sensitive surface

The rain sensor controls the frequency of the windscreen wiper intervals, depending on the amount of rain » » ⚠. The sensitivity of the rain sensor can be adjusted manually. Manual wipe » » page 148.

Move the lever to the required position

» » Fig. 147:

- ⓪ Rain sensor off.
- ① Rain sensor on; automatic wipe if necessary.
- (A) Setting sensitivity level of rain sensor
 - Set control to the right: highly sensitive.
 - Set control to the left: less sensitive.

When the ignition is switched off and then back on, the rain sensor stays on and starts operating again when the windscreen wipers are in position ① and the vehicle is travelling at more than 16 km/h (10 mph).

Rain sensor modified behaviour

Possible causes of faults and mistaken readings on the sensitive surface » » Fig. 148 of the rain sensor include:

- Damaged blades: a film of water on the damaged blades may lengthen the activation time, reduce the washing intervals or result in a fast and continuous wipe.
- Insects: insects on the sensor may trigger the windscreen wiper.
- Salt on roads: in winter, salt spread in the roads may cause an extra long wipe when the windscreen is almost dry.
- Dirt: dry dust, wax, coating on glass (Lotus effect) or traces of detergent (car wash) may

reduce the effectiveness of the rain sensor or make it react more slowly, later or not at all.

- Cracked windscreen: the impact of a stone will trigger a single wipe cycle with the rain sensor on. Next the rain sensor detects the reduction in the sensitive surface area and adapts accordingly. The behaviour of the sensor will vary with the size of the damage caused by the stone.

⚠ WARNING

The rain sensor may not detect enough rain to switch on the wipers.

- If necessary, switch on the wipers manually when water on the windscreen obstructs visibility.

i Note

- Clean the sensitive surface of the rain sensor regularly and check the blades for damage » » Fig. 148 (arrow).
- To remove wax and coatings, we recommend a window cleaner containing alcohol.

Mirror

Anti-dazzle rear view mirror

Your vehicle is fitted with an interior rear vision mirror with a manual or automatic* control for anti-dazzle position.

Interior rear vision mirror with manual setting for anti-dazzle position

- Position the small lever of the lower edge of the mirror to face towards the rear.

WARNING

In the event that an automatic anti-dazzle rear vision mirror breaks, an electrolyte fluid may leak. This could cause irritation to the skin, eyes and respiratory organs. If you come into contact with this liquid, it must be rinsed with large quantities of water. If necessary, get medical help.

CAUTION

In the event that an automatic anti-dazzle rear vision mirror breaks, an electrolyte fluid may leak. This liquid attacks plastic surfaces. Clean it with a wet sponge as soon as possible.

Note

- If the light incident in the interior rear vision mirror is obstructed (e.g. with the sun blind*), the anti-dazzle rear vision mirror with automatic setting will not operate perfectly.
- When the interior lights are on or reverse gear engaged, the mirrors do not darken with

automatic adjustment for anti-dazzle position.

Adjusting the exterior rear-view mirrors

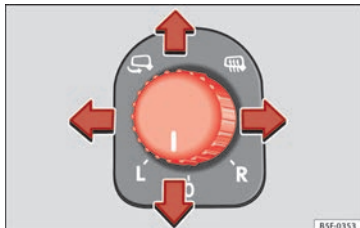


Fig. 149 Driver door: control for the exterior mirror.

Read the additional information carefully
» page 21

Synchronized regulation of the exterior mirrors

- In the **Settings – Convenience** menu, select whether or not the exterior mirrors should move in synchronisation.
- Turn the knob to position **L**¹⁾.

- Adjust the left-hand exterior mirror. The right exterior mirror will be adjusted at the same time (synchronised).
- If necessary the right exterior mirror adjustment may need correcting. turn the control to position **R**¹⁾.
- In the Easy Connect system the exterior mirrors can be adjusted using the **CAR** button and the **SETTINGS** function button.

Tilt function for front passenger exterior mirror*

When parking backwards, and in order to be able to see the kerb, the passenger side mirror can be automatically tilted towards the passenger to provide a better view of the kerb. The control must be in the position **R**¹⁾ for this feature to be operational.

The mirror returns to its original position as soon as you drive forward at over 15 km/h (9 mph) or switch off the ignition. It also returns to its original position if the position of the control is adjusted.

Storing the rear view mirror settings for the tilt function

- Switch the ignition on.
- Access the Easy Connect system, Menu, **CAR**, function **Rear view mirrors and** »

¹⁾ Regulation in right-hand drive vehicles is symmetrical.

windscreen wipers and select **Lower while reversing**» page 120.

- Select the **R**¹⁾ position on the control.
- Select reverse gear.
- Adjust the front passenger exterior mirror so that you can see, for example, the kerb area well.
- Release the reverse gear.
- The adjusted position for the rear view mirror is stored.

Fold in the exterior mirrors after parking (convenience function)*

Via the Easy Connect system, **CAR** Menu and **Rear view mirrors and windscreen wipers** function, you can choose to have the exterior mirrors fold in when the vehicle is parked» page 120.

When the vehicle is locked with the remote control, by pressing for more than approximately 1 second the exterior mirrors are folded in automatically. When the vehicle is opened with the remote control, the exterior mirrors are deployed automatically.

⚠ WARNING

Convex or wide-angle* exterior mirrors give a larger field of vision. However, they make ob-

jects look smaller and further away than they really are. If you use these mirrors to estimate the distance to vehicles behind you when changing lane, you could misjudge the distance. Risk of accident!

ⓘ CAUTION

- If one of the mirror housings is knocked out of position (e.g. when parking), the mirrors must first be fully retracted with the electric control. Do not readjust the mirror housing by hand, as this will interfere with the mirror adjuster function.
- Before washing the vehicle in an automatic car wash, please make sure to retract the exterior mirrors to prevent them from being damaged. Electrically retractable exterior mirrors must not be folded in or out by hand. Always use the electrical power control.


ⓘ Note

If the electrical adjustment should fail to operate, both of the mirrors can be adjusted by hand by lightly pressing the edge of the mirror glass.

Seats and head restraints

Adjusting the seats and headrests

Manual adjustment of the seats

Read the additional information carefully»  page 19

⚠ WARNING


The safe driving chapter contains important information, tips, suggestions and warnings that you should read and observe for your own safety and the safety of your passengers» page 74.

⚠ WARNING

- Adjust the front seats only when the vehicle is stationary. Failure to follow this instruction could result in an accident.
- Be careful when adjusting the seat height. Careless or uncontrolled adjustment can cause injuries.
- The front seat backrests must not be reclined for driving. Otherwise, seat belts and the airbag system might not protect as they should, with the subsequent danger of injury.

¹⁾ Regulation in right-hand drive vehicles is symmetrical.

Electric driver's seat adjustment*

Read the additional information carefully
 »»  page 19

WARNING

- If the electric front seats are used negligently or without paying due attention, it can cause serious injury.
- The front seats can also be electrically adjusted when the ignition is switched off. Never leave a child or any other person who may need help in the vehicle.
- In the event of an emergency, electrical adjustment can be stopped by pressing any control.

CAUTION


To avoid damaging the electrical components of the front seats, please refrain from kneeling on the seat or applying sharp pressure at a single point to the seat cushion and backrest.

Note

- It may not be possible to electrically adjust the seat if the vehicle battery is very low.
- If the engine is started while the seats are being electrically adjusted, the adjustment will stop.

Adjusting the front head restraints

Read the additional information carefully
 »»  page 20

Adjust the head restraint »»  page 20 so that as far as possible the top of the head restraint is level with the top of your head. When this is not possible, try to get as close as possible to this position.

Adjustment of the rear head restraints

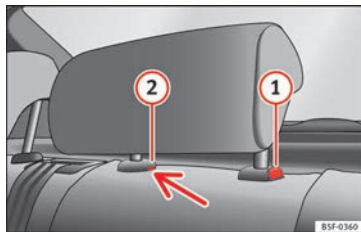




Fig. 150 Rear centre head restraint: release point.




When transporting people in the back seat, place the head restraints of the occupied seats at a minimum of the next socket up »» .

Adjusting the head restraints

- To set the head restraint higher, grasp the sides with both hands and move it upwards, until you see it engage.
- To set the head restraint lower down, press the  »» **Fig. 150** button and move it downwards.

Removing the head restraint

To remove the head restraint, the corresponding backrest must be partially folded forward.

- Unlock the backrest »» page 156.
- Move the head restraint upwards until it arrives to the top.
- Press button  »» **Fig. 150**, while simultaneously pressing on the security hole  »» **Fig. 150** with a flat screwdriver a maximum of 5 mm wide, and remove the head restraint.
- Move the backrest until it engages properly »» .

Fitting the head restraint

To mount the external head restraints, the corresponding backrest must be partially folded forward.

- Unlock the backrest »» page 156.
- Insert the head restraint bars into the guides until they perceptibly engage. It »»

should not be possible to remove the head restraint from the backrest.

- Move the backrest until it engages properly »» » ⚠.

⚠ WARNING

• Please observe the general notes »» page 78.

• Remove the rear head restraints only when it is necessary for the placement of a child seat »» page 91. After removing a child seat, remount the head restraint immediately. Travelling with the head restraints removed or improperly adjusted increases the risk of severe injuries.

Seat functions

Introduction

⚠ WARNING

Inappropriate use of the seat functions can cause severe injuries.

- Assume the proper sitting position before your trip and remain in it throughout. This also applies to the other occupants.
- Always keep hands, fingers, feet and other parts of the body away from the operating radius and the adjustment of seats.

Seat heating

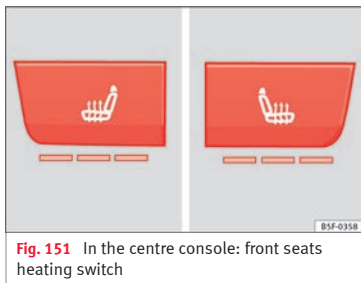


Fig. 151 In the centre console: front seats heating switch

The seat cushions can be heated electrically when the ignition is switched on. The backrest is also heated in some versions.

The seat heating should not be engaged in any of the following conditions:

- The seat is unoccupied.
- The seat has a covering.
- There is a child seat installed in the seat.
- The seat cushion is wet or damp.
- The indoor or outdoor temperature is greater than 25°C (77°F).

Activate

Press the button or . Seat heating is switched on fully.

Adjusting the heating output

Press the button or repeatedly until the desired intensity level is reached.

Deactivating

Press the button or until all warning lamps switch off.

⚠ WARNING

People who, because of medications, paralysis or chronic diseases (e.g. diabetes) cannot perceive pain or temperature, or have a limited perception thereof, may suffer burns to the back, buttocks or legs when using seat heating, an occurrence that may entail a very lengthy recovery period or from which it may not be possible to recover fully. Seek medical advice if you have doubts regarding your health.

- People with limited pain and temperature thresholds must never use seat heating.

⚠ WARNING

If the fabric of the cushion is wet, this can adversely affect the operation of the seat heating, increasing the risk of burns.

- Make sure the seat cushion is dry prior to using the seat heater.
- Do not sit on the seat with clothing that is wet or damp.
- Do not leave clothing that is wet or damp on the seat.

- Do not spill liquid on the seat.

⚠ CAUTION

- To avoid damaging the heating elements of the seat heaters, please do not kneel on the seat or apply sharp pressure to a single point on the seat cushion or backrest.
- Liquids, sharps objects and insulating materials (e.g. covers or child seats) can damage the seat heating.
- In the event of smells, switch off the seat heating immediately and have it inspected by a specialised workshop.

♻ For the sake of the environment

The seat heating should remain on only when needed. Otherwise, it is an unnecessary fuel waste.

Front centre armrest

The centre armrest can be adjusted to various levels.

Adjusting the centre armrest

- To adjust the tilt, lift the armrest from the starting position so that it is engaged.
- To return the armrest to the starting position, remove the armrest from the upper fixed position and lower it.

The armrest can be moved backwards and forwards.

Folding down the passenger seat backrest*

- ✓ Applies to the model: LEON / LEON ST

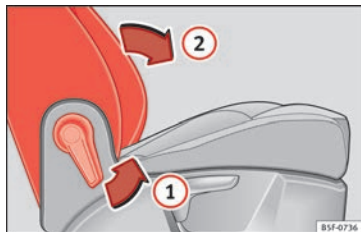


Fig. 152 Front passenger seat: lever for folding down the backrest.

The front passenger seat can be folded down to increase the storage space.

- Pull lever **1** » Fig. 152 and push the seat backrest **2** until the backrest is horizontal.

⚠ WARNING

When the front passenger seat is folded down it cannot be occupied.

Folding down and raising the rear seat backrest

- ✓ Applies to the model: LEON/LEON SC

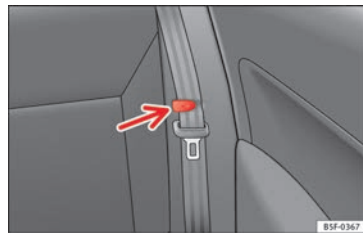


Fig. 153 Clip to support the seat belt.

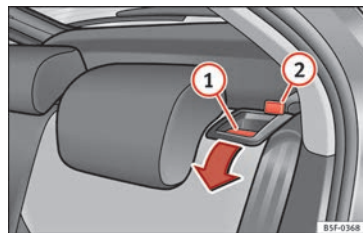


Fig. 154 Backrest release lever.

The backrests can be folded forward individually or together. »

Folding the backrest forwards

- Place the side seat belts in the trim clip »» Fig. 153.
- Slide the head restraint(s) downwards »» page 153.
- Press the release lever »» Fig. 154 ① in the direction of the arrow.
- Fold the backrest forwards.

Converting the table to a seat

- Raise the backrest until it engages in its upright position »» ⚠. The red marking on the tab »» Fig. 154 ② should no longer be visible when the backrest is properly secured.

⚠ WARNING

The safe driving chapter contains important information, tips, suggestions and warnings that you should read and observe for your own safety and the safety of your passengers »» page 74.

⚠ WARNING

- Make sure that the rear backrest is securely locked in position so that the seat belt can provide proper protection on the centre rear seat.
- The rear backrest must always be securely latched so that objects stored in the luggage

compartment will not fly forward through the interior during sudden braking.

⚠ CAUTION

- With the backrest inclined there is a danger of damaging the rear head restraints when adjusting the front seats backwards.
- When folding the backrest forwards, make sure to place the side seat belts in the trim clip to prevent them from being damaged by becoming trapped in the backrest lock.

Folding down and lifting the rear seat backrest

✓ Applies to the model: LEON ST

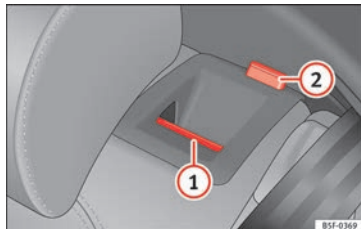


Fig. 155 On the rear seat backrest: release catch ①; red mark ②.

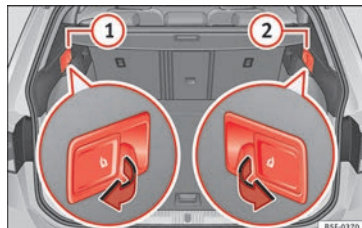


Fig. 156 In the luggage compartment: levers for remote release of the left part ① and right part ② of the rear seat backrest.

The rear seat backrest is split and each part be lowered separately to extend the luggage compartment.

When the rear seat backrest is lowered nobody else can travel in the corresponding seats (not even a child).

Lowering the rear seat backrest with the unlock button

- Lower the head restraint properly.
- Push the unlock button »» Fig. 155 ① forwards and at the same time lift the backrest.
- The rear seat backrest is not engaged when the red marking of the button ② is visible.

Lowering the rear seat backrest with the remote release lever

- Lower the head restraint properly.

- Open the rear lid.
- Pull the remote release lever of the left part » Fig. 156 ① or right part ② of the backrest in the direction of the arrow. The released part of the rear seat backrest is folded automatically down and forwards.
- If this occurs, close the rear lid.

The rear seat backrest is not engaged when the red marking of the button » Fig. 155 ② is visible.

Folding up the rear seat backrest

- Lift the backrest and press it firmly into the lock until it engages » ⚠.
- It should not be possible to see the red mark of the unlock button ②.
- The backrest must be properly engaged.

⚠ WARNING

Serious injuries can be caused if the rear seat backrest is lowered or lifted without due care and attention.

- Never lower or lift the rear seat backrest while driving.
- Do no trap or damage the seat belt when raising the rear seat backrest.
- When lowering or lifting the rear seat backrest, keep your hands, fingers, feet and other body parts out of its path.
- For the rear seat belts to offer the necessary protection all the parts of the rear backrest

must be properly engaged. This is particularly important in the case of the centre rear seat. If someone is seated in a seat whose backrest is not properly engaged they will fly forward, along with the backrest, during an accident or a sudden driving or braking manoeuvre.

- A red signal on the button ② warns that the backrest is not engaged. Always check that the red marking is not visible when the backrest is in the upright position.
- When the rear seat backrest is lowered or is not properly engaged nobody else can travel in the corresponding seats (not even a child).

ⓘ CAUTION

Serious damage can be caused to the vehicle and other objects if the rear seat backrest is lowered or lifted without due care and attention.

- Before lowering the rear seat backrest, always adjust the front seats so that neither the head restraints nor the cushions of the rear backrest can hit them.

Transport and practical equipment

Storage compartments

Storage areas under the front seats*



Fig. 157 Storage compartment under the front seats.

There is a storage compartment with a cover under each front seat.

The drawer* is opened by pulling on the handle of the cover » Fig. 157.

To close the drawer, press the cover until it locks into position.

⚠ WARNING

- The drawers will hold a maximum weight of 1.5 kg. »

- Do not drive with the drawer cover open. There is an injury risk for passengers if the cargo is released in case of sudden braking or an accident.

Folding table*

✓ Applies to the model: LEON ST



Fig. 158 Left-hand front seat: folding table.

- To open the tray, open it up in the direction of the arrow » Fig. 158.

⚠ WARNING

- The folding trays may not be folded down whilst the vehicle is in motion and anyone is seated on the second row of seats. There is a risk of injury during a sudden braking manoeuvre! The tray must therefore be closed and properly secured whilst the vehicle is in motion.

- Do not put hot drinks in the drink holders. During normal or sudden driving manoeuvres, sudden braking or an accident, the hot drink could be spilled. Danger of scalding.

ⓘ CAUTION

When driving, do not leave open cans in the cup holders. The drink might be spilt on braking, for example, and could damage the vehicle.

Drink holders

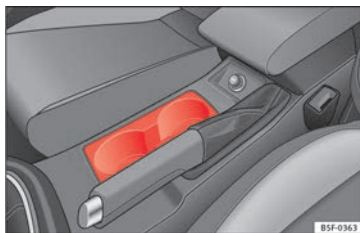


Fig. 159 Centre console: front drink holders.

Front drink holders

- Place drinks in the holder » Fig. 159. Placement of two drinks is possible. There is also the possibility of placing larger plastic bottles in the trims of the doors.

⚠ WARNING

- Do not place any hot drinks in the drink holder while the vehicle is moving. Hot drinks could spill and cause burns, which may cause an accident.
- Do not use hard china cups or glasses. These could cause injury in the event of an accident.

ⓘ CAUTION

You should avoid putting open drinks containers in the drink holders. The drinks could otherwise spill over and cause damage to e.g. the electrical equipment or the seat covers.

Glove compartment



Fig. 160 Glove compartment

Opening/closing

- To open the glove compartment, pull the handle in the direction of the arrow.
- To close the glove compartment, move the cover upwards until it engages.

Depending on the vehicle equipment, the CD player is located in the glove compartment. Separate operating instructions are enclosed for this equipment in the corresponding Instruction Manual.

WARNING

The cover of the glove compartment should always be closed while driving. Failure to follow this instruction could result in an accident.

Other storage compartments

You will find more object holders, compartments and supports in other parts of the vehicle:

- In the top of the glove compartment in vehicles that do not have a CD reader. The load of the compartment should not exceed 1.2 kg.
- In the centre console under the centre armrest*.
- In the driver side panel there is a removable box for access to fuses and relays. The

load of the compartment should not exceed 0.2 kg.

- Coat hooks in the door frames »» » ⚠.
- Other storage compartments are found in the rear seat, to the left and the right of the seats.

WARNING

- Please make sure that any items of clothing hanging from the coat hooks do not obstruct your view to the rear.
- The coat hooks should only be used for lightweight clothing. Do not leave any heavy or sharp objects in the pockets.
- Do not use clothes hangers to hang up the clothing, as this could interfere with the function of the head-protection airbags.

Power sockets

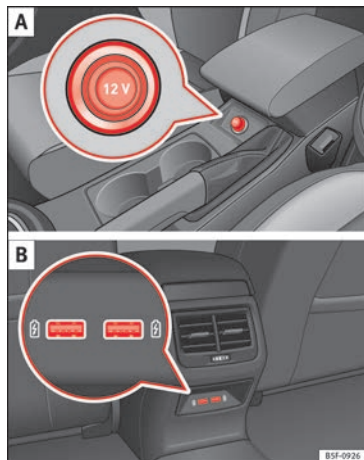


Fig. 161 **A** Centre console: front 12 volt power socket **B** Centre console, rear section: USB power sockets. »»



Fig. 162 Detailed view of the side trim in the luggage compartment: 12-volt power socket (applies only to the LEON ST model).

In the centre console

- Remove the connector located in the centre console from the power socket » **Fig. 161 A**.
- Insert the plug of the electrical appliance into the power socket.

In the luggage compartment (applies only to the LEON ST model)

- Lift the power socket cover » **Fig. 162**.
- Insert the plug of the electrical appliance into the power socket.

Electrical equipment can be connected to the 12 volt power socket. The appliances connected to each power socket must not exceed a power rating of 120 Watt.

USB power sockets

Depending on the equipment and the country, the vehicle may also have USB connections **exclusively for charging or as a power socket**.

These USB ports are located at the rear of the console, between the front seats » **Fig. 161 B**. These connectors can work at a maximum power of up to 10.5 W per port.

They are **not** intended for file playback.

⚠ WARNING

The power socket works only when the ignition is on. Improper use may cause serious injury or even fire. Children should therefore not be left in the vehicle unattended if the button is also left behind. Otherwise there is a possibility that they may be injured.

⚠ CAUTION

Always use the correct type of plugs to avoid damaging the sockets.

i Note

- **The use of electrical appliances with the engine switched off will cause a battery discharge.**
- **Should the connected appliance overheat, immediately switch it off and disconnect it from the socket.**

- **Before switching the ignition on or off, unplug the appliances from the USB ports to protect them from any damage caused by fluctuations in voltage.**

Storing objects

Loading the luggage compartment

All luggage and other loose objects must be safely secured in the luggage compartment. Unsecured objects which shift back and forth could impair the driving safety or driving characteristics of the vehicle by shifting the centre of gravity.

- Distribute the load evenly in the luggage compartment.
- Place heavy objects as far forward as possible in the luggage compartment.
- Place the heavy objects first.
- Secure heavy objects to the fitted fastening rings » **page 167**.

⚠ WARNING

- **Loose luggage and other objects in the luggage compartment could cause serious injuries.**
- **Always stow objects in the luggage compartment and secure them on the fastening rings.**

- Use suitable straps to secure heavy objects.
- During sudden manoeuvres or accidents, loose objects can be thrown forward, injuring vehicle occupants or passers-by. This increased risk of injury will be further increased if a loose object is struck by an inflating air-bag. If this happens, objects may shoot outward like a missile. Risk of fatal injury.
- Please note that the centre of gravity may shift when transporting heavy objects; this may affect vehicle handling and lead to an accident. Therefore, it is essential to adjust your speed and driving style accordingly, to avoid accidents.
- Never exceed the allowed axle weights or allowed maximum weight. If said weights are exceeded, the driving characteristics of the vehicle may change, leading to accidents, injuries and damage to the vehicle.
- Never leave your vehicle unattended, especially when the rear lid is open. Children could climb into the luggage compartment, closing the door behind them; they will be trapped and run the risk of death.
- Never allow children to play in or around the vehicle. Close and lock all the doors and the rear lid when you leave the vehicle. Before you lock the vehicle, make sure that there are no adults or children in the vehicle.

Note

- Air circulation in the vehicle helps reduce fogging of the windows. Used air escapes through ventilation slits in the side trim of the luggage compartment. Ensure that the ventilation slots are never covered.
- Straps for securing the load to the fastening rings are commercially available.

Luggage compartment shelf

✓ Applies to the model: LEON/LEON SC

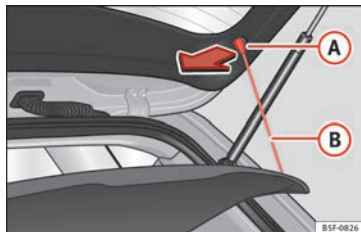


Fig. 163 In the luggage compartment: removing and installing the rear shelf.

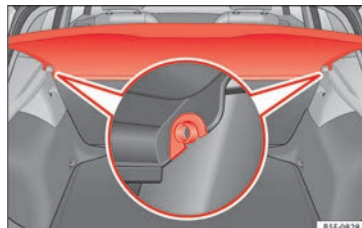


Fig. 164 In the luggage compartment: removing and installing the rear shelf.

The luggage compartment cover blocks the view into the luggage compartment.

Removing

- Detach the cord loops » **Fig. 163 B** from their hooks **A**.
- Remove the rear shelf from the side supports » **Fig. 164** by pulling it upwards and then take it out.
- If necessary, the rear shelf can be stored under the luggage compartment variable floor » **page 163**

Fitting

- Insert the cover horizontally so that the “recess” fits onto the axis of the supports » **Fig. 164** and press down until it engages.
- Hook the loops » **Fig. 163 B** to the rear lid » **△**.

⚠ WARNING

- The luggage compartment cover must always be fixed properly (risk of accident).
- The luggage compartment cover should not be used as a storage shelf. Articles placed on this cover could cause injury to vehicle occupants in an accident or if the brakes are applied suddenly.

Retractable rear shelf

✓ Applies to the model: LEON ST

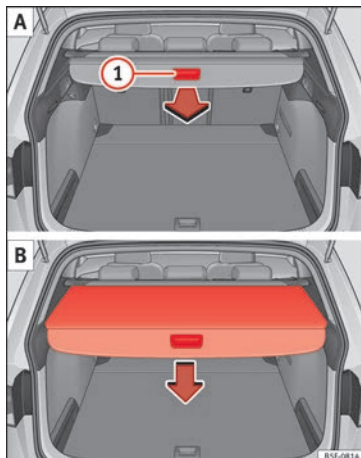


Fig. 165 In the luggage compartment: opening and retracting the rear shelf.

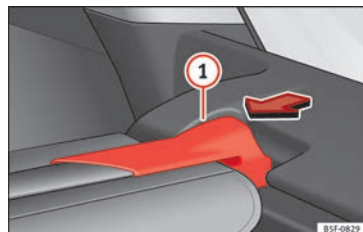


Fig. 166 In the luggage compartment: removing the rear shelf.

Opening the rear shelf

- Pull evenly on the rear shelf using its handle » **Fig. 165** ① **A** in a backwards direction until it audibly clicks into place.

Retracting the rear shelf

- Press on the handle of the rear shelf in the direction of the arrow to release it » **Fig. 165** **B**.

The shelf will automatically move towards the end and will retract completely.

Removing the rear shelf

- Press the rear shelf support » **Fig. 166** ① in the direction of the arrow.
- Remove the rear shelf through the support and upwards.

- The rear shelf can be stored under the luggage compartment variable floor when the latter is in the top position (except for vehicles equipped with natural gas engine CNG) »» page 164.

Fitting the rear shelf

- Place the rear shelf in the housing provided in the left side cover.
- Engage the support of the rear shelf »» Fig. 166 ① in the right housing.
- Check that the support »» Fig. 166 ① is properly engaged.

⚠ WARNING

Animals, loose or unsecured or objects carried on the rear shelf can cause serious injury in case of sudden manoeuvring or braking or in case of an accident.

- Do not leave hard, sharp or heavy objects or in bags on the rear shelf.
- Never carry animals on the rear shelf.

ⓘ CAUTION

To retract the rear shelf, press on its handle in a downwards only direction; if you press it upwards it may lead to its axles breaking.

Storing the rear shelf

- ✓ Applies to the model: LEON/LEON SC



Fig. 167 In the luggage compartment: covers for storing the rear shelf.



Fig. 168 In the luggage compartment: fitting the storage compartment shelf.

The rear shelf can be stored under the luggage compartment variable floor.

- Remove the left and right covers »» Fig. 167.

- Press the rear shelf until it engages in its housing »» Fig. 168.
- Put the left and right covers in their original position.

Storing the rear shelf

✓ Applies to the model: LEON ST

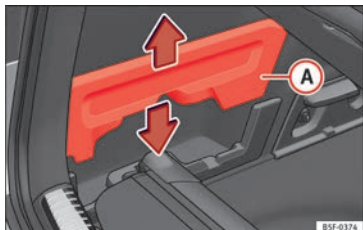


Fig. 169 In the luggage compartment: housing for storing the rear shelf.

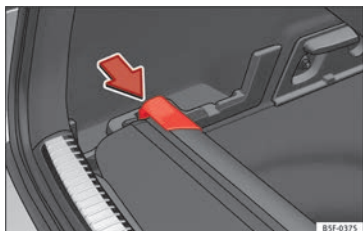


Fig. 170 In the luggage compartment: housing for storing the rear shelf.

The rear shelf can be stored under the luggage compartment variable floor.

- Remove covers »» Fig. 169 (A) left and right.

- Press the head of the rear shelf in the direction of the arrow until it engages in its housing »» Fig. 170.
- Put the left and right covers in their original position.

Use of the net partition behind the rear seat*

✓ Applies to the model: LEON ST

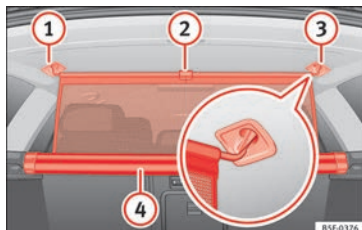


Fig. 171 In the luggage compartment: pulling out and securing the net partition.

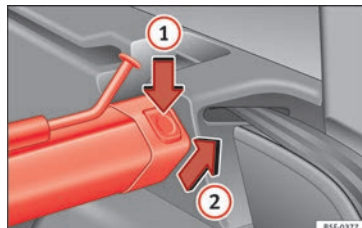


Fig. 172 In the luggage compartment: removing the net partition.

Pulling out and securing the net partition

- Pull up handle »» Fig. 171 (2) to remove the net from the casing (4).
- Hook in the net partition on the right side (3) (magnified image).
- Hook in the net partition in the left side housing (1) pulling the rod.

The net partition is properly assembled when the T-shaped ends are firmly secured in the corresponding housings (3) and (1).

Retracting the net partition

- Unhook the rod from the housings (3) and (1).
- Roll up the net into the casing (4) lowering it with your hand.

Removing the net partition

- Fold the rear seat backrests forward.
- Press the left or right release catch »» Fig. 172 in the direction of the arrow ①.
- Remove the casing from the support in the direction of the arrow »» Fig. 172 ②.

Fitting the net partition

- Fold the rear seat backrests forward.
- Fit the casing in the right and left supports.
- Press the casing into the left and right supports in the opposite direction to the arrow »» Fig. 172 ② until it engages.

The red markings on the release buttons should no longer be visible.

⚠ WARNING

- Always secure objects, even when the net partition is properly assembled.
- There should be nobody behind the assembled partition when the vehicle is moving.

ⓘ CAUTION

Incorrect handling of the net partition could cause damage.

- Do not “release” the net partition when lowering it, as the net and other vehicle parts could be damaged. Roll down the net partition by hand.

Use of the net partition with the rear seat backrests lowered

✓ Applies to the model: LEON ST

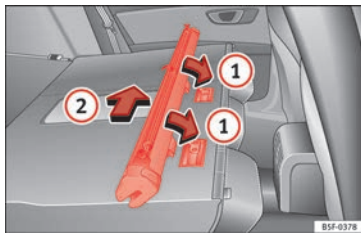


Fig. 173 Assembling the net partition in the rear seat backrests.

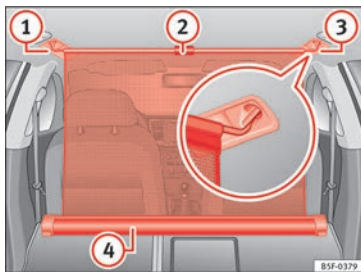


Fig. 174 In the luggage compartment: net partition hooked into the rear seat backrests.

Fitting the net partition

- Fold the rear seat backrests forward.

- Remove the net partition from the side supports.
- Place the net casing in the rail slots in the direction of the arrows »» Fig. 173 ①.
- Push the casing towards the left side of the vehicle in the direction of arrow »» Fig. 173 ② and as far as it will go.
- Check that the net is secure.

Pulling out and securing the net partition

- Pull up handle »» Fig. 174 ② to remove the net from the casing »» Fig. 174 ④.
- Hook in the net partition on the right side »» Fig. 174 ③ (magnified image).
- Hook in the net partition in the left side housing »» Fig. 174 ① pulling the rod.

The net partition is properly assembled when the T-shaped ends are firmly secured in the corresponding housings »» Fig. 174 ③ and ①.

Retracting the net partition

- Remove the rod from the housings in the trims of the roof side members.
- Roll up the net into the casing »» Fig. 174 ④ lowering it with your hand.

Removing the net partition

- Pull the net casing out approximately 5 cm in the opposite direction to the arrow
» Fig. 173 ②.
- Remove the casing from the rails by pulling in the opposite direction to the arrows
» Fig. 173 ①.
- Lift the rear seat backrests.

⚠ WARNING

During a sudden driving or braking manoeuvre, or in the event of an accident, objects could be flung through the interior and cause serious or fatal injuries.

- Always secure objects, even when the net partition is properly assembled.
- There should be nobody behind the assembled partition when the vehicle is moving.

⚠ WARNING

The rear seat backrests should only be lifted again once the net partition has been disassembled.

ⓘ CAUTION

Incorrect handling of the net partition could cause damage.

- Do not “release” the net partition when lowering it, as the net and other vehicle parts could be damaged. Roll down the net partition by hand.

Tailboard for transporting long items*



Fig. 175 On the rear seat backrest: opening the tailboard.



Fig. 176 In the luggage compartment: opening the tailboard.

On the rear seat, behind the central armrest, there is a tailboard for transporting long items in the interior, such as skis.

To avoid soiling the interior, dirty objects should be wrapped (e.g. in a blanket) before they are inserted through the tailboard.

When the armrest is down, nobody may travel in the centre rear seat.

Opening the tailboard

- Lower the centre armrest.
- Pull the release lever in the direction of the arrow and push the tailboard cover
» Fig. 175 ① down and forwards.
- Open the rear lid.
- Insert the long objects through the gap from the luggage compartment.
- Secure the objects with the seatbelt.
- Close the rear lid.

Closing the tailboard

- Lift the tailboard cover until it engages. The red mark on the luggage compartment side should never be visible.
- Close the rear lid.
- Lift the centre armrest if necessary.

i Note

The tailboard can also be opened from the luggage compartment. To do so, press the release lever down, in the direction of the arrow, and the cover upwards » Fig. 176.

Fastening rings*

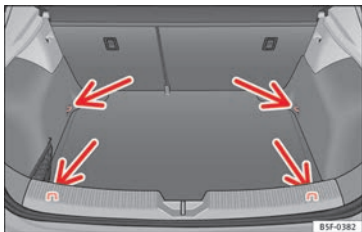


Fig. 177 In the luggage compartment: fastening rings (LEON/LEON SC model except versions with spare wheel and CNG).

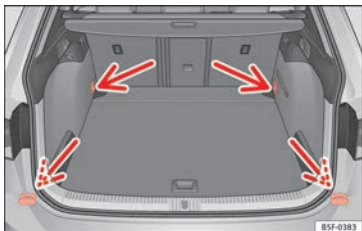


Fig. 178 In the luggage compartment: fastening rings (LEON ST model).

In the front and rear part of the luggage compartment there are fastening rings to secure the luggage »» **Fig. 178**.

In order to use the fastening rings, they must be lifted beforehand¹⁾.

⚠ WARNING

If unsuitable or damaged belts or retaining straps are used, they could break in the event of braking or an accident. Objects could then be launched across the passenger compartment and cause serious or fatal injuries.

- Always use belts or retaining straps that are suitable and in a good condition.
- Belts and retaining straps should be securely fastened to the fastening rings.
- Objects in the luggage compartment that are unsecured could move suddenly and modify the handling of the vehicle.
- Secure all objects, little and large.
- Never exceed the maximum tensile load of the fastening ring when securing objects.
- Never secure a child seat to the fastening rings.

i Note

- The maximum tensile load that the fastening rings can support is 3.5 kN.

• Belts and securing systems for the appropriate load can be obtained from specialised dealerships. SEAT recommends visiting a SEAT dealership for this.

• The fastening rings are rendered unusable for versions with spare wheel and CNG.

¹⁾ Valid only for the LEON ST model.

Retaining hooks

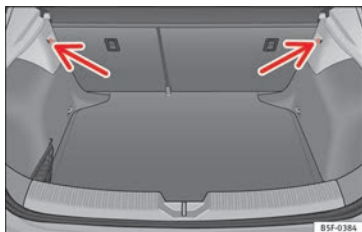


Fig. 179 In the luggage compartment: retaining hooks (LEON/LEON SC model).

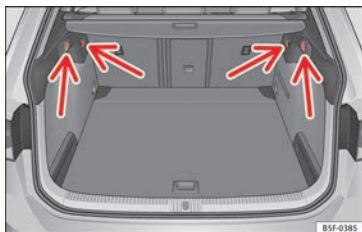


Fig. 180 In the luggage compartment: retaining hooks (LEON ST model).

At the rear of the luggage compartment, on the left and right, there are fixed retaining hooks » **Fig. 180**.

The retaining hooks have been designed to secure light shopping bags.

In the front and rear part of the luggage compartment there are fastening rings to secure the luggage » **Fig. 177** and » **Fig. 178**.

⚠ WARNING

Never use the retaining hooks as fastening rings. In case of sudden braking or an accident, the hooks could break.

ⓘ CAUTION

Each hook is designed for a maximum load of 2.5 kg.

Net bag*

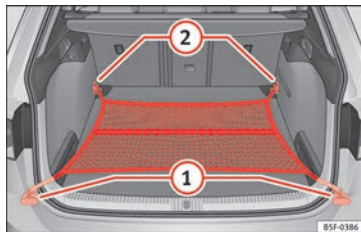


Fig. 181 In the luggage compartment: net bag hooked up at floor level (LEON ST model).

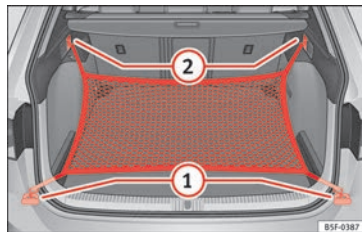


Fig. 182 In the luggage compartment: rings (1) and hooks (2) for securing the net bag (LEON ST model).

The luggage compartment prevents light luggage from moving. The net bag has a zip and can be used to store small objects.

The net bag can be hooked up to the luggage compartment in different ways.

Hooking the net bag into the luggage compartment floor

- As applicable, lift the front fastening rings » **Fig. 181** (2).
- Secure the net hooks to the fastening rings (2) » ⚠. The bag zip should be facing upwards.
- Secure the net hooks to the fastening rings (1).

Hook the net bag next to the load threshold

- Secure the short net hooks to the fastening rings »» Fig. 182 ① »» ⚠. The bag zip should be facing upwards.
- Secure the straps in the bag hooks ②.

Removing the net bag

The hooked up net bag is taut »» ⚠.

- Remove the hooks and the net bag straps from the fastening rings and from the bag hooks.
- Store the net bag in the luggage compartment.

⚠ WARNING

To secure the elastic net bag on the fastening rings it must be stretched out. Once hooked up it is taut. If the net bag is hooked up or unhooked incorrectly the hooks could cause injuries.

- Always secure the net hooks properly so that they do not suddenly release from the fastening rings when hooking or unhooking them.
- On hooking or unhooking them, protect your eyes and face in case the hooks are released suddenly.
- Always hook up the net bag hooks in the described order. If a hook is unexpectedly released the risk of injury is increased.

Luggage compartment variable floor

✓ Applies to the model: LEON/LEON SC



Fig. 183 Luggage compartment: variable floor

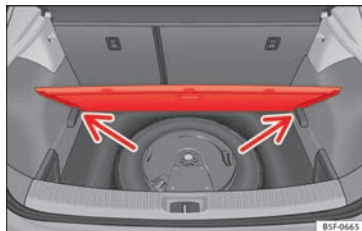


Fig. 184 Luggage compartment: variable floor

Variable floor in the tilted position

When the variable floor is tilted you can access the spare wheel/anti-puncture kit area.

- Lift the variable floor using handle »» Fig. 183 ①, pull it back and push the backrest of the rear seat until the movable part of the floor is resting on it.
- Rest the floor on its housings »» Fig. 184 (arrows).

Luggage compartment variable floor

✓ Applies to the model: LEON ST

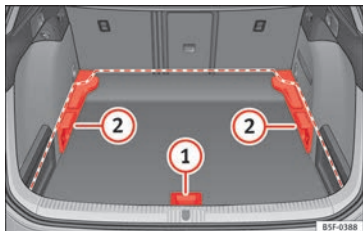


Fig. 185 Luggage compartment variable floor: positions.

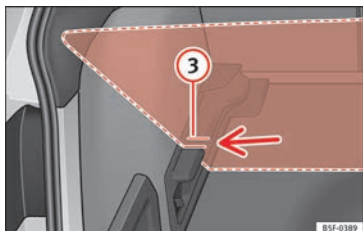


Fig. 186 Luggage compartment variable floor: grooves tilted.

Variable floor in the high position

- Lift the floor using handle »» Fig. 185 ① and pull it back until the front of the floor has fully passed the supports ②.

- Move the floor forward over the supports as far as the rear seat backrest and then lower the floor with the handle ①.

Variable floor in the low position

- Lift the floor using handle »» Fig. 185 ① and pull it back until the front of the floor has fully passed the supports ②.
- Now match the front part with the lower grooves of the supports and slide the floor forwards as far as the rear seat backrest and lower the floor at the same time with the handle ①.

Variable floor in the tilted position

When the variable floor is tilted you can access the spare wheel/anti-puncture kit area.

- Lift the variable floor using handle »» Fig. 185 ① and pull it back until the front of the floor has fully passed the tilted grooves »» Fig. 186 ③.
- Run the floor through these grooves with the help of handle ① as the rear seat backrest and until the floor is resting in the grooves.

⚠ WARNING

During a sudden driving or braking manoeuvre, or in the event of an accident, objects could be flung though the interior and cause serious or fatal injuries.

- Always secure objects, even when the luggage compartment floor is properly lifted.
- Only objects that do not protrude more than 2/3 the height of the floor may be carried between the rear seat and the raised luggage compartment floor.
- Only objects that do not weigh than approximately 7.5 kg may be carried between the rear seat and the raised luggage compartment floor.

ⓘ CAUTION

- The maximum weight that can be loaded on the luggage compartment variable floor in the top position is 150 kg.
- Do not let the luggage compartment floor fall when closing it. Always carefully guide it downwards in a controlled manner. Otherwise, the lining and the floor of the luggage compartment could be damaged.

i Note

SEAT recommends the use of straps to secure objects to retaining rings.

Roof carrier

Introduction

The vehicle roof has been designed to optimise aerodynamics. For this reason, cross

bars or conventional roof carrier systems cannot be secured to the roof water drains.

As the roof water drains are integrated in the roof to reduce air resistance, only SEAT-approved cross bars and roof carrier systems can be used.

Cases in which cross bars and the roof carrier system should be disassembled.

- When they are not used.
- When the vehicle is washed in a car wash.
- When the vehicle height exceeds the maximum height, for example, in some garages.

⚠ WARNING

When heavy or bulky loads are transported on the roof carrier system, car driving performance is affected, as the centre of gravity shifts and there is greater wind resistance.

- Always secure the load properly using belts or retaining straps that are suitable and in a good condition.
- Bulky, heavy, long or flat loads have a negative effect on aerodynamics, the centre of gravity and driving performance.
- Avoid sudden braking and manoeuvres.
- Adapt your speed and driving style at all times to suit visibility, weather, road and traffic conditions.

⚠ CAUTION

- Remove the cross bars and the roof carrier system before entering a car wash.
- Vehicle height is increased by the installation of cross bars or a roof carrier system and the load secured on them. For this purpose, check that your vehicle's height does not surpass the headspace limit, for example, for underpasses or for entering garage doors.
- Cross bars, a roof carrier system and the load secured on them should not interfere with the roof aerial or hamper the path of the panoramic sun roof » page 138 and the rear lid.
- On opening the rear lid make sure that it does not knock into the roof load.

♻ For the sake of the environment

When cross bars and a roof carrier system are installed, the increased air resistance means that the vehicle uses more fuel.

Attach the cross bars and the roof carrier system

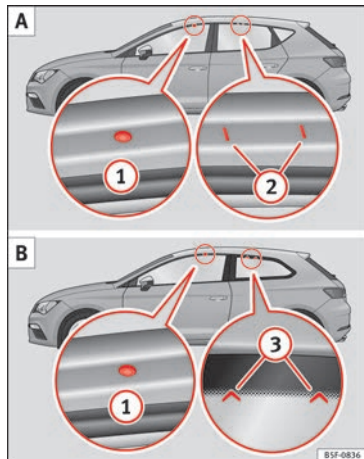


Fig. 187 Leon/Leon SC: attachment points for the roof railings for the roof carrier system. »

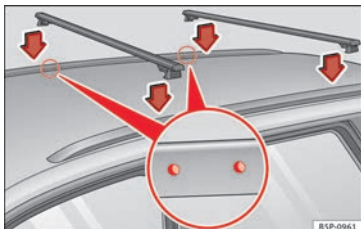


Fig. 188 Leon ST: attachment points for the roof railings for the roof carrier system.

The crossbars are the basis of a series of special roof carrier systems. For safety reasons, special fixtures must be used to safely transport luggage, bicycles, skis, surf boards or boats on the roof. Suitable accessories can be acquired at SEAT dealerships.

Always secure the crossbars and the roof carrier system properly. Always take the assembly instructions that come with the crossbars and the roof carrier system in question into account.

LEON model

The front and rear attachment points ① and ② are only visible when the doors are open »» Fig. 187 A.

Leon SC model

The front and rear attachment points ① are only visible when the doors are open. The

rear attachment points ③ are marked on the top edge of the glass with arrow heads »» Fig. 187 B.

LEON ST model

The crossbars are assembled on the roof railings. The attachment points can be seen on bottom of the roof railing »» Fig. 188.

⚠ WARNING

Incorrect attachment and use of the crossbars and the roof carrier system may cause the whole system to detach from the roof and cause an accident and injuries.

- Always take the manufacturer assembly instructions into account.
- Use only crossbars and the roof carrier system when they are in perfect condition and are properly secured.
- Secure the crossbars and the roof carrier system properly.
- Check threaded joints and attachments travelling and if necessary tighten them after you have travelled a short distance. When making long trips, check the threaded joints whenever you stop for a rest.
- Always fit the special roof carrier systems correctly for wheels, skis and surfboards, etc.
- Do not modify or repair the crossbars or roof carrier system.

i Note

Always read the assembly instructions that come with the crossbars and the roof carrier system carefully and keep them in the vehicle.

Loading the roof carrier system

The load can only be secured if the crossbars and the roof carrier system are properly installed »» ⚠.


Maximum authorised roof load

The maximum permissible roof load is **75 kg**. This figure comes from the combined weight of the roof carrier, the cross bars and the load itself on the roof »» ⚠.

Always check the weight of the roof carrier system, the cross bars and the weight of the load to be transported and weigh them if necessary. Never exceed the maximum authorised roof load.

If you are using cross bars and a roof carrier with a lower weight rating, you will not be able to carry the maximum authorised roof load. In this case, do not exceed the maximum weight limit for the roof carrier which is listed in the fitting instructions.

Distributing a load

Distribute loads uniformly and secure them correctly »» .

Check attachments

Once the cross bars and roof carrier system have been installed, check the bolted connections and attachments after a short journey and subsequently with a certain frequency.

WARNING

Exceeding the maximum authorised roof load can result in accidents and considerable vehicle damage.

- Never exceed the maximum authorised load on the roof and on the axles or the vehicle's maximum authorised weight.
- Never exceed the load capacity of the cross bars and the roof carrier system, even if the maximum authorised roof load has not been reached.
- Secure heavy items as far forward as possible and distribute the vehicle load uniformly.

WARNING

If the load is loose or not secured, it could fall from the roof carrier system or cause accidents and injuries.

- Always use belts or retaining straps that are suitable and in a good condition.
- Secure the load properly.

Air conditioning

Heating, ventilation and cooling

Introduction

Read the additional information carefully »»  page 52

Viewing Climatronic information

On the screen of Climatronic control unit and on the screen of the factory-fitted Easy Connect system, the theoretical values of the temperature zones are shown.

The unit of temperature measurement can be changed in the Easy Connect system.

Dust and pollen filter

The dust and pollen filter with its activated charcoal cartridge serves as a barrier against impurities in the air taken into the vehicle interior.

The dust and pollen filter must be changed regularly so that air conditioner performance is not adversely affected.

If the filter loses efficiency prematurely due to use in areas with very high levels of air pollution, the filter must be changed more frequently than stated in the Service Schedule.

WARNING

Reduced visibility through the windows increases the risk of serious accidents.

- Always ensure that all windows are free of ice and snow, and that they are not fogged, so as to maintain good visibility of everything outside.
- The maximum heat output required to defrost windows as quickly as possible is only available when the engine has reached its normal running temperature. Only drive when you have good visibility.
- Always ensure that you use the heating system, fresh air system, air conditioner and the heated rear window to maintain good visibility to the outside.
- Never leave the air recirculation on for a long period of time. If the cooling system is switched off and air recirculation mode switched on, the windows can mist over very quickly, considerably limiting visibility.
- Switch air recirculation mode off when it is not required.

WARNING

Stuffy or used air will increase fatigue and reduce driver concentration possibly resulting in a serious accident.

- Never leave the fresh air fan turned off or use the air recirculation for long periods of time; the air in the vehicle interior will not be refreshed.

ⓘ CAUTION

- Switch the air conditioner off if you think it may be broken. This will avoid additional damage. Have the air conditioner checked by a specialised workshop.
- Repairs to the air conditioner require specialist knowledge and special tools. SEAT recommends visiting a SEAT Official Service.

ⓘ Note

- When the cooling system is turned off, air coming from the outside will not be dried. To prevent fogging of the windows, SEAT recommends leaving the cooling system (compressor) turned on. To do this, press the A/C button. The button lamp should light up.
- The maximum heat output required to defrost windows as quickly as possible is only available when the engine has reached its normal running temperature.
- Keep the air intake slots in front of the windscreen free of snow, ice and leaves to ensure heating and cooling are not impaired, and to prevent the windows from misting over.

Operating the Climatronic through the Easy Connect* system

- ✓ Applies to vehicles with a Media System Touch/Colour.

In the Easy Connect system it is also possible to perform various adjustments to the Climatronic.

Open the air conditioner menu

- Press the **SETUP** button on the Climatronic control panel.
- **OR:** press the **MENU** button in Easy Connect. With the rotating switch select the **air conditioner** menu and open it.

On the touch screen you can see and change the current settings, for example, the temperature set for the driver and passenger sides, the air distribution and the fan speed.

To switch a function on or off, or to select a submenu, you must press the corresponding function button.

Function button: function

OFF	Switch off and switch on the Climatronic.
SYNC	Synchronise driver and front passenger temperatures.

Function button: function

SETTINGS	The air conditioning settings submenu is opened. The following settings can also be adjusted:
	Air conditioning profile: Adjust the power of the fan in AUTO mode. You can choose between low, medium and high.
	Automatic air recirculation: Switching automatic air recirculation on and off» page 176.
	BACK ↩: Close the submenu.

Operating the Climatronic through the Easy Connect* system

- ✓ Applies to vehicles with Media System Plus/Navigation System/Navigation System Plus.



Fig. 189 Easy Connect screen: air conditioner menu.

In the Easy Connect system it is also possible to perform various adjustments to the Climatronic » **Fig. 189**.

Open the air conditioner menu

- Press the **SETUP** button on the Climatronic control panel.

On the top of the screen you can see and change the current settings, such as, for example, the temperature set for the driver side and for that of passenger. Temperatures up to +22°C (+72°F) are shown with blue arrows, and temperatures over +22°C (+72°F) with red arrows.

To switch a function on or off, or to select a submenu, you must press the corresponding function button.

Function button: function	
OFF	Climatronic is switched off.
ON	Climatronic is switched on.
SYNC	Synchronise driver and front passenger temperatures.

Function button: function

SETTINGS	The air conditioning settings submenu is opened. The following settings can also be adjusted:
	Air conditioning profile.: Adjust the power of the fan in AUTO mode. You can choose between low, medium and high.
	Automatic air recirculation: Switching automatic air recirculation on and off » page 176.
	Automatic supplementary heater: Activate/deactivate the automatic activation of the auxiliary heater for colder countries (only for engines with auxiliary heater). With the option deactivated, depending on the outside temperature the heating may need more time than normal to reach a comfortable temperature.
	BACK ➔: Close the submenu.


Air conditioning user instructions

The interior cooling system only works when the engine is running and fan is switched on.

The air conditioner operates most effectively with the windows and the panoramic sliding sunroof closed. However, if the vehicle has heated up after standing in the sun for some time, the air inside can be cooled more quick-

ly by opening the windows and the panoramic sliding sunroof briefly.

Climatronic: change the temperature unit on the screen of the radio or on the factory-fitted navigation system

Changing the temperature display from Celsius to Fahrenheit on radio or on the factory-fitted navigation system is done using the menu on the instrument panel »  page 36.

The cooling system cannot be activated

If the air conditioning system cannot be switched on, this may be caused by the following:

- The engine is not running.
- The fan is switched off.
- The air conditioner fuse has blown.
- The outside temperature is lower than approximately +3°C (+38°F).
- The air conditioner compressor has been temporarily switched off because the engine coolant temperature is too high.
- Another fault in the vehicle. Have the air conditioner checked by a specialised workshop.

Special Characteristics

If the humidity and temperature outside the vehicle are high, **condensation** can drip off »

the evaporator in the cooling system and form a pool underneath the vehicle. This is normal and does not indicate a leak!

Note

After starting the engine, any residual humidity in the air conditioner could mist over the windscreen. Switch on the defrost function as

soon as possible to clear the windscreen of condensation.

Air outlets

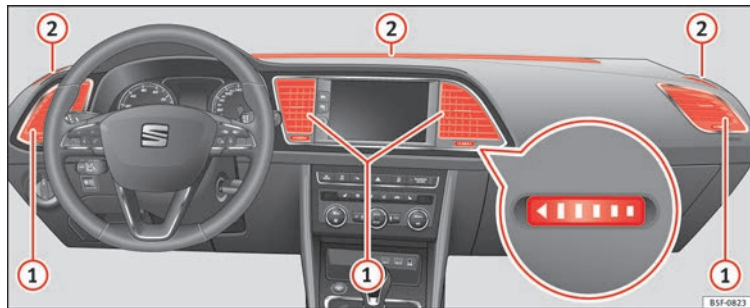


Fig. 190 On the dash panel: air vents

Air vents

To ensure proper heating, cooling and ventilation in the vehicle interior, air vents » Fig. 190 ① should remain open.

- Turn the corresponding thumbwheel (detail) in the required direction to open and close the air vents. When the thumbwheel is in the ► position, the corresponding air vent is closed.

- Change the air direction using the ventilation grille lever.

There are other additional, non-adjustable air vents in the dash panel ②, in the footwell and in the rear area of the interior.

Note

Food, medicine and other heat or cold sensitive objects should never be placed in front of the air outlets as they may be damaged or

made unsuitable for use by the air coming from the air vents.

Air recirculation mode

Basic points



Air recirculation:




Manual recirculation


Air recirculation mode prevents the ambient air from entering the interior.

When the outside temperature is very high, selecting manual air recirculation mode for a short period refreshes the vehicle interior more quickly.

For safety reasons, air recirculation mode is switched off when the button  is pressed or the air distributor turned to .

Switching the manual air recirculation mode on and off

To switch system on: press the  button until the warning lamp lights up.

To switch system off: press the  button until the warning lamp goes off.

Functioning mode of automatic air recirculation (air conditioning menu)

With the automatic air recirculation mode activated, the entry of fresh air into the cabin interior is enabled. If the system detects a high concentration of hazardous substances in the ambient air, air recirculation mode is switched on automatically. When the level of impurities drops to within a normal range, recirculation mode is switched off.


The system is unable to detect unpleasant smells.

The air recirculation will **not** connect automatically in versions without humidity sensor and in the following external conditions:

- The outside temperature is lower than +3°C (+38°F).
- The cooling system is switched off and the outside temperature is below +10°C (+50°F).
- The cooling system is switched off, the outside temperature is below +15°C (+59°F) and the windscreen wipers are switched on.

Activation/deactivation of automatic air recirculation is done in the air conditioner menu, under Configuration.

WARNING

Observe the safety warnings  in Introduction on page 173.

- If the cooling system is switched off and air recirculation mode switched on, the windows can mist over very quickly, considerably limiting visibility.
- Switch air recirculation mode off when it is not required.

CAUTION

Do not smoke when air recirculation is switched on in vehicles with an air conditioner. The smoke taken in could lie on the cooling system vaporiser and on the activated charcoal cartridge of the dust and pollen fil-

ter, leading to a permanently unpleasant smell.

Note

Climatronic: air recirculation mode is activated to prevent exhaust gas or unpleasant odours from entering the vehicle interior when it is in reverse and while the automatic windscreen wiper is working.

Driving

Starting and stopping the engine

Switching the ignition on and starting the engine with the key

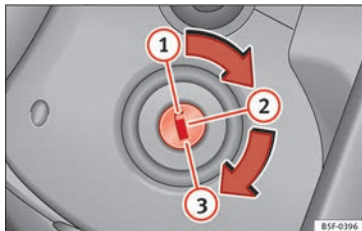


Fig. 191 Ignition key positions.

Read the additional information carefully

» page 30

Diesel engines can take a few seconds longer than usual to start on cold days. Therefore the clutch pedal (manual gearbox) or the brake pedal (automatic gearbox) must remain pressed until the engine starts up. During preheating, the warning lamp remains lit.

The preheating time depends on the coolant and exterior temperatures. With the engine at

operating temperature, or at outside temperatures above +8°C, the warning lamp will light up for about one second. This means that the engine starts *immediately*.

If the engine does not immediately start up, interrupt the starting process and try again after 30 seconds. To start the engine again, return the key to position **» Fig. 191 1**.

Start-Stop System*

If the vehicle is stopped and the Start-Stop system* switches off the engine, the ignition remains switched on.

Automatic gearbox: before leaving the vehicle, make sure that the ignition is switched off and the selector lever is in position **P**.

Driver messages on the instrument panel display

Press the clutch

This message appears on vehicles with a manual gearbox if the driver tries to start the engine without having the clutch pedal pressed. The engine will only start if you press the clutch pedal.

Press the brake

This message appears on vehicles with an automatic gearbox if the driver tries to start the engine without having the brake pedal pressed.

Select N or P

This message appears if you try to start or stop the engine when the selector lever of the automatic gearbox is not in position **P** or **N**. The engine can only start or stop in certain positions.

Engage position P; the vehicle can move; doors can only close in position P.

For safety reasons, this driver message appears and an audible warning sounds if the selector lever of the automatic gearbox is not in position **P** after you switch off the ignition. Put the selector lever in position **P**, otherwise the vehicle could roll away.

Gear change: selector lever in the drive position!

This driver message is displayed when the selector lever is not in the position **P** when the driver door is opened. Additionally, a buzzer will sound. Put the selector lever in position **P**, otherwise the vehicle could roll away.

Ignition is switched on

This driver message is displayed and a buzzer is sounded when the driver door is opened with the ignition switched on.

⚠ WARNING

- Never run the engine in confined spaces, as the exhaust gases are poisonous.

ⓘ CAUTION

Avoid high engine speeds, full throttle and extreme load conditions until the engine has reached its normal operating temperature, otherwise this can damage the engine.

🌿 For the sake of the environment

Do not warm up the engine by idling it. You should drive off as soon as you start the engine. This will help avoid unnecessary exhaust emissions.

ⓘ Note

- If it is difficult to turn the ignition key to the position **1**, move the steering wheel to both sides to release the steering lock.
- When starting from cold, the engine may be a little noisy for the first few seconds until oil pressure has built up in the hydraulic valve lifters. This is quite normal, and no cause for concern.
- If the vehicle battery is disconnected and reconnected, the key must remain in the position **1** for around 5 seconds before starting up.
- Vehicles with automatic gearbox without electronic brake, depending on the country: after switching off the ignition, you can only

remove the ignition key if the selector lever is in position "P" (parking lock). Next, the selector lever is locked.

Switching off the engine with the key**Switching off the engine**

- Stop the vehicle.
- Turn the ignition key to position **0** **»» Fig. 191 1**.

Engaging the steering wheel lock

In vehicles with automatic gearbox, the ignition key can only be removed when the selector lever is in position P.

- Remove the key from the ignition in position **0** **»» Fig. 191 1** **»» ⚠**.
- Turn the steering wheel until you hear it engage.

Possible vehicle theft is prevented with the steering lock engaged.

⚠ WARNING

- Never switch the engine off until the vehicle is stationary. The brake servo and power steering functions will not be completely covered under warranty. More force may also be needed to turn the steering wheel or to brake. As you cannot steer and brake in the normal

manner, there is a greater risk of accidents and serious injury.

- Never remove the key from the ignition if the vehicle is in motion. Otherwise, the steering could suddenly lock, making it impossible to steer the vehicle: risk of accident!

- Always take the key with you when you leave the vehicle. This is particularly important if there are children in the vehicle, as they might otherwise be able to start the engine or use power-operated equipment (e.g. the electric windows), which could cause injuries.

ⓘ CAUTION

If the engine has been running under high load for a long time, there is a risk of heat building up in the engine compartment after it has been switched off; this could cause engine damage. For this reason, you should idle the engine for approximately 2 minutes before you switch it off.

ⓘ Note

- After the engine is switched off the radiator fan may run on for up to 10 minutes, even if the ignition is switched off. It is also possible that the fan turns itself on once more if the coolant temperature increases due to the heat accumulated in the engine compartment or due to its prolonged exposure to solar radiation.

- If the vehicle is stopped and the Start-Stop system* switches off the engine, the ignition remains switched on. Make sure that the ignition is switched off before leaving the vehicle, otherwise the battery could discharge.

Starter button*



Fig. 192 In the lower part of the centre console: starter button.




Fig. 193 On the right of the steering column: emergency start.

The vehicle engine can be started with a starter button (Press & Drive). To do so, there must be a valid key inside the vehicle in the area of the front or rear seats.

Opening the driver's door **when exiting the vehicle** activates the electronic lock on the steering column if the ignition is disabled.

Switching the ignition on/off manually

Briefly push the starter button without touching the brake or clutch pedal »» » .

For vehicles with both manual and automatic transmission, the starter button text **START ENGINE STOP** flashes like a heartbeat when the system is preset for switching the ignition on and off.

Automatic ignition switch-off

If the driver leaves the vehicle, taking the vehicle key with them but leaving the ignition on, the ignition is switched off automatically after a certain time. If at that time the dipped beam is on, the parking lights will stay on for approx. 30 minutes. The side light can be turned off by blocking the vehicle »» page 125 or manually »» page 140.


Emergency starting function

If no valid key is detected inside the vehicle, an emergency start-up will be required. The relevant message will appear in the dash panel display. This may happen when, for example, the battery of the vehicle key button is very low or flat:

- Immediately after pushing the starter button, keep the vehicle key next to the right trim of the steering column »» **Fig. 193**, as close as possible to the Kessy logo.
- The ignition connects and the engine starts automatically.

Emergency disconnection

If the engine does not switch off after briefly pressing the starter button, an emergency disconnect will be required:

- Press the starter button twice within 3 seconds or press it once for more than 1 second »» » .

- The engine turns off automatically.

Engine restart feature

If no valid key is detected inside the vehicle after the engine stops, you will only have 5 seconds to restart it. A warning will display on the dash panel screen.

After this interval, it will not be possible to start the engine without a valid key inside the vehicle.

Automatic deactivation of the ignition on vehicles with the Start-Stop system

The ignition is switched off automatically when the vehicle is stopped and the automatic engine shutdown is active, if:

- The driver's seat belt is not fastened,
- the driver does not step on any pedal,
- the driver door is opened.

After automatically turning off the ignition, if the dipped beam Ⓜ is on, the side light remains on for approx. 30 minutes (if the battery is sufficiently charged). If the driver locks the vehicle or manually turns off the light, the side light goes out.

WARNING

Any accidental movement of the vehicle could result in serious injury.

- When switching on the ignition, *do not* press the brake or clutch pedal, otherwise the engine could start immediately.

WARNING

If vehicle keys are used negligently or without due care, this may cause accidents and serious injury.

- Never leave any key inside the vehicle when exiting. Otherwise, a child or unauthorised person could lock the vehicle, start the engine or connect the ignition and, in this way, operate electronic equipment (e.g. the windows).

Note

- Before leaving the vehicle, always disconnect the ignition manually and, if appropriate, take into account the instructions on the screen of the dash panel.
- If the vehicle is stationary for a long time with the ignition on, the vehicle battery might be discharged and it might not be possible to start the engine.
- In diesel vehicles, there may be a delay in the engine starting if it requires preheating.
- If during the STOP phase you press the **START ENGINE STOP** button, the ignition is switched off and the button flashes.
- If the indication "Start-Stop system deactivated: Start the engine manually" is displayed on the dash panel display, the **START ENGINE STOP** button will blink.

Starting the engine

- ✓ Valid for vehicles: with starter button

Step	Starting the engine with the starter button » page 180.
1.	Press and hold the brake pedal until step 5 is performed.
1a.	In vehicles with a manual gearbox: press and hold the clutch down until the engine starts.
2.	Put the gearbox lever in neutral or the selector lever in position P or N .
3.	Briefly press the starter button » Fig. 192 without pressing the accelerator. For the engine to start there must be a valid key in the vehicle. After starting the engine, the light of the START ENGINE STOP button changes to a fixed light indicating that the engine has started.
4.	If the engine does not start, stop and wait for approx. 1 minute before trying again. If necessary, perform an emergency start » page 180.
5.	Disconnect the parking brake when you are about to start driving » page 183.

WARNING

Never leave the vehicle with the engine running, especially if a gear or gear range is engaged. The vehicle could then suddenly move or something strange could happen that would cause damage, fire or serious injury. »

⚠ WARNING

Cold start sprays could explode or cause a sudden increase in the engine speed.

- Never use sprays to cold start the engine.

ⓘ CAUTION

• The starter motor or the engine may be damaged if you try to start the engine while driving or if you restart it immediately after switching it off.

• If the engine is cold, avoid high engine speeds, pushing the engine too hard and rapid acceleration.

• Do not start the engine by pushing the vehicle or towing it. Unburnt fuel could enter the catalytic converter and damage it.

ⓘ Note

• Do not wait until the engine warms up with the vehicle stationary; if you have good visibility through the windows, start driving immediately. This helps the engine reach operating temperature faster and reduces emissions.

• Electrical components with a high power consumption are switched off temporarily when the engine starts.

• When starting with a cold engine, noise levels may briefly increase. This is quite normal, and no cause for concern.

• When the outside temperature is below +5°C (+41°F), if the engine is diesel, some

smoke may appear under the vehicle when the fuel-operated auxiliary heater is on.

Stopping the engine

✓ Valid for vehicles: with starter button

Step	Switch off the engine with the starter button »» page 180.
1.	Stop the vehicle completely »» ⚠.
2.	Press and hold the brake pedal until the step 4 is performed.
3.	If you are driving an automatic vehicle, place the selector lever in position P.
4.	Connect the electronic parking brake »» page 183.
5.	Briefly press the start-up button »» Fig. 192. The (START ENGINE STOP) button blinks again. If the engine fails to switch off, perform an emergency disconnect »» page 180.
6.	If the vehicle is equipped with a manual gearbox, put it into 1st or reverse.

⚠ WARNING

Never switch off the engine while the vehicle is moving. This could cause loss of control of the vehicle, accidents and serious injury.

- The airbags and belt tensioners do not work when the ignition is switched off.

• The brake servo does not work with the engine off. Therefore, you need to press the brake pedal harder to brake the vehicle.

• Power steering does not work when the engine is not running. You need more strength to steer when the engine is switched off.

• If the ignition is switched off, the steering column could be locked, making it impossible to control the vehicle.

ⓘ CAUTION

If the engine is made to work hard for a long time, it may overheat after being switched off. To prevent damage to the engine before switching it off, leave it idle for approx. 2 minutes in neutral.

ⓘ Note

After switching off the engine, the cooling fan may continue to operate in the engine compartment for a few more minutes, even with the ignition off. The radiator fan is automatically switched off.

“My Beat” Function



Fig. 194 Related video

For vehicles with a convenience key there is the “My Beat” function. This feature provides an additional indication of the vehicle ignition system.

When accessing the vehicle, e.g. by opening the doors with the remote control, the **START ENGINE STOP** button flashes, calling attention to the relevant starter system button.

Upon switching the ignition on/off, the light of the **START ENGINE STOP** button flashes. With the engine switched off, after a few seconds, the **STOP ENGINE START** button stops flashing and goes out.

With the engine running, the **START ENGINE STOP** button light stays on, indicating that the engine is running. The time that lapses between the moment the user starts the engine with the **START ENGINE STOP** button and the lighting changes from flashing to fixed will depend on specific engine size characteristics. Upon switching the ignition off with the **START ENGINE STOP** button, it starts flashing again.

In vehicles with the **Start-Stop system**, the “My Beat” function also offers additional information:

- When the engine stops during the Stop phase, the light of the **START ENGINE STOP** button stays on, since, even though the engine is off, the Start-Stop system is active.
- When the engine cannot be started again with the Start-Stop system, **» page 205**, and needs to be started manually, the **START ENGINE STOP** button flashes to indicate this fact.

Braking and parking

Electronic parking brake*

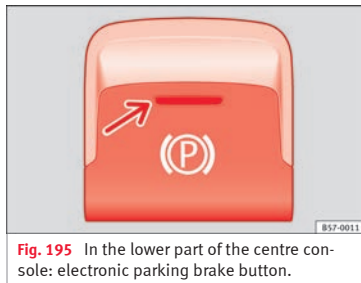


Fig. 195 In the lower part of the centre console: electronic parking brake button.

The electronic parking brake replaces the handbrake.

Activating the electronic parking brake

The electronic parking brake can be activated whenever the vehicle is at a standstill, even when the ignition is switched off. Activate it whenever you leave or park the vehicle.

- Pull and hold the **» Fig. 195** button.
- The parking brake is activated when the control light of the **» Fig. 195** button (arrow) and the **red P** control light of the display in the dash panel are on.
- Release the button.

Releasing the electronic parking brake


- Switch the ignition on.
- Press the button **» Fig. 195**. At the same time step hard on the brake pedal or, if the engine is running, press the accelerator pedal slightly.
- The control light of the **» Fig. 195** button (arrow) and the **red P** control light of the display in the dash panel go out.


Automatic release of the electronic parking brake on starting the engine

The electronic parking brake is automatically switched off when starting if, after the driver's door is closed and the driver's seat belt **»**

fastened, **any** of the following situations take place:

- On vehicles with an automatic gearbox: A gear range is engaged or the vehicle is switched to another one and the accelerator pedal is lightly pressed.
- In vehicles with a manual gearbox: The clutch pedal is pressed fully before starting off and the accelerator is pedal lightly pressed.
- To facilitate certain manoeuvres there are exceptions that allow the automatic parking brake to be released without the driver's seat belt being fastened.

The parking brake can be prevented from being automatically released by continuously pulling up the  **Fig. 195** switch when starting off.


The electronic parking brake is not disconnected until the  button is released. This can facilitate starting off when a heavy load is towed **» page 246**.



Automatic activation of the electronic parking brake when exiting the vehicle incorrectly

In vehicles with automatic transmission, the electronic parking brake is activated automatically when exiting the vehicle incorrectly if:

- The selector lever is in the **D/S** or **R** position or in the Tiptronic selector gate.
- **AND:** the vehicle is stationary.
- **AND:** the driver door is open.

Emergency braking function

Only use the emergency brake function if you are unable to stop the vehicle with the foot brake **» **.

- Pull and hold the  **» Fig. 195** button in this position to **forcefully** stop the vehicle. At the same time, an acoustic warning can be heard.
- To stop the braking process, release the  button or press the accelerator.

WARNING

The improper use of the electronic parking brake can cause accidents and serious injury.


- Never use the electronic parking brake to stop the vehicle, unless it is an emergency. The braking distance may be considerably longer. Always use the foot brake.
- Never accelerate from the engine when a gear range or a gear is engaged and the engine is running. The vehicle could move, even if the electronic parking brake is activated.

CAUTION

To prevent the vehicle from unintentionally moving when parking it, first apply the elec-

tronic parking brake and then remove your foot from the brake pedal.

Note

- In vehicles with a manual gearbox, releasing the clutch and accelerating at the same time automatically disconnects the electronic parking brake.
- If the vehicle battery is flat, it will not be possible to disconnect the electronic parking brake. Use the jump-start **»  page 70**.
- When the electronic parking brake is applied or released, noises may be heard.
- The system performs automatic and audible tests sporadically in the parked vehicle if some time elapses without the electronic parking brake being used.

Using the handbrake



Fig. 196 Handbrake between the front seats.


The handbrake should be applied firmly to prevent the vehicle from accidentally rolling away.


Always apply the handbrake when you leave your vehicle and when you park.


Applying the handbrake

- Pull the handbrake lever up firmly
» **Fig. 196.**

Releasing the handbrake

- Pull the lever up slightly and press the release knob in the direction of the arrow
» **Fig. 196** and guide the handbrake lever down fully » .

Always pull the handbrake *all the way up*, so there is less risk of driving off with it still engaged » .

The handbrake warning lamp  lights up when the handbrake is applied and the ignition switched on. The warning lamp turns off when the handbrake is released.

If you drive faster than 6 km/h (4 mph) with the handbrake on, the following message* will appear on the instrument panel: **HANDBRAKE ON**. You will also hear an audible warning.

WARNING

- Never use the handbrake to stop the vehicle when it is in motion. The braking distance

is considerably longer, because braking is only applied to the rear wheels. Risk of accident!

- If the handbrake is only partially released, this will cause the rear brakes to overheat, which can impair the function of the brake system and could lead to an accident. This also causes premature wear on the rear brake pads.

CAUTION

Always apply the handbrake before you leave the vehicle. Put it in 1st gear as well.

Parking

The handbrake should always be firmly applied when the vehicle is parked.

Always note the following points when parking the vehicle:

- Use the brake pedal to stop the vehicle.
- Apply the handbrake.
- Put it in 1st gear.
- Switch the engine off and remove the key from the ignition. Turn the steering wheel slightly to engage the steering lock.
- Never leave a vehicle key in the vehicle.

Additional notes on parking the vehicle on gradients:

Turn the steering wheel so that the vehicle rolls against the kerb if it started to roll.

- If the vehicle is parked facing **downhill**, turn the front wheels so that they point *towards the kerb*.
- If the vehicle is parked facing **uphill**, turn the front wheels so that they point *away from the kerb*.
- Secure the vehicle as usual by applying the handbrake firmly and putting it in 1st gear.

WARNING

- Take measures to reduce the risk of injury when you leave your vehicle unattended.
- Never park where the hot exhaust system could ignite inflammable materials, such as dry grass, low bushes, spilled fuel etc.
- Never allow vehicle occupants to remain in the vehicle when it is locked. They would be unable to open the vehicle from the inside, and could become trapped in the vehicle in an emergency. In the event of an emergency, locked doors will delay assistance to vehicle occupants.
- Never leave children alone in the vehicle. They could set the vehicle in motion, for example, by releasing the handbrake or the gearbox lever.

»

- **Depending on weather conditions, it may become extremely hot or cold inside the vehicle. This can be fatal.**

Brakes

New brake pads

For the first 400 km (250 miles), new brake pads have not yet reached their maximum braking capacity, and need to be “run in” first. However, you can compensate for the slightly reduced braking effect by applying more pressure on the brake pedal. Avoid overloading the brakes while running them in.

Wear

The rate of wear on the **brake pads** depends a great deal on how you drive and the conditions in which the vehicle is operated. This is a particular problem in urban traffic and short stretches, or with very sporty driving.

Depending on the speed, the braking force and the environmental conditions (for example, the temperature, air humidity, etc.) noises may be produced on braking.

Wet roads or road salt

In certain situations (for example, on driving through flooded areas, in severe downpours or after washing the vehicle) the braking ac-

tion could be delayed if the discs and pads are damp, or frozen in winter. In this case the brakes should be “dried” by pressing the brake pedal several times.

At high speed and with the windscreen wipers activated, the brake pads will briefly touch the brake discs. This takes place, although unnoticeable to the driver, at regular intervals to improve the response time of the brakes when they are wet.

The effectiveness of the brakes can also be temporarily reduced if the vehicle is driven for some distance without using the brakes when there is a lot of salt on the road in winter. The layer of salt that accumulates on the discs and pads can be removed by gently applying the brakes a few times.

Corrosion

There may be a tendency for corrosion to form on the discs and dirt to build up on the brake pads if the vehicle is used infrequently or the brakes are not used very often.

If the brakes are not used frequently, or if rust has formed on the disks, it is advisable to clean off the pads and disks by braking firmly a few times at a moderately high speed >>> ⚠.

Fault in the brake system

If the brake pedal travel should ever increase *suddenly*, this may mean that one of the two

brake circuits has failed. Drive immediately to the nearest specialised workshop and have the fault repaired. Drive there slowly and remember that you will have to apply more pressure on the brake pedal and allow for longer stopping distances.

Low brake fluid level

Malfunctions can occur in the brake system if the brake fluid level is too low. The brake fluid level is monitored electronically.

Brake servo

The brake servo increases the pressure you apply to the brake pedal. It works only when the engine is running.

⚠ WARNING

- **Apply the brakes heavily to clean the brake system only in a suitable traffic situation. Do not put other road users in danger: there is risk of causing an accident.**
- **Ensure the vehicle does not move while in neutral, when the engine is stopped. Failure to follow this instruction could result in an accident.**
- **If the brake fluid loses its viscosity and is subjected to heavy use, vapour bubbles can form in the brake system. This reduces the efficiency of the brakes.**

ⓘ CAUTION

- Never let the brakes “drag” by leaving your foot on the pedal when it is not necessary to brake. This overheats the brakes, resulting in longer stopping distances and greater wear.
- Before driving down a long, steep gradient, it is advisable to reduce speed and select a lower gear. This makes use of engine braking and relieves the brakes. If you still have to use the brakes, it is better to brake firmly at intervals than to apply the brakes continuously.

i Note

- If the brake servo is out of action, for example when the car is being towed, you will have to press the brake pedal considerably harder than normal to make up for the lack of servo assistance.
- If you wish to equip the vehicle with accessories such as a front spoiler or wheel covers, it is important that the flow of air to the front wheels is not obstructed, otherwise the brakes can overheat.

Braking and stability systems

Electronic Stability Control (ESC)

The ESC helps to improve safety. It reduces the tendency to skid and improves the stability and roadholding of the vehicle. The ESC

detects critical handling situations, such as vehicle understeer or oversteer, or wheelspin on the driving wheels. It stabilises the vehicle by braking individual wheels or by reducing the engine torque. The warning lamp will flash on the instrument panel when the ESC is intervening 𐄂.

ESC includes the Anti-lock brake system (ABS), the brake assist system, the traction control system (ASR), electronic differential lock (EDL), electronic self-locking*, selective torque control* and tractor-trailer sway mitigation*. ESC also helps stabilise the vehicle by changing the torque.

Anti-lock brake system (ABS)

ABS prevents the wheels from locking up under braking until the vehicle has reached a virtual standstill. You can continue to steer the vehicle even when the brakes are on full. Keep your foot on the brake pedal and do not pump the brakes. You will feel the brake pedal pulsate while the ABS is working.

Brake assist system

The brake assist system can reduce the required braking distance. The braking force is automatically boosted if you press the brake pedal quickly in an emergency. You must keep pressing the brake pedal until the danger has passed.

Traction control system (ASR)

In the event of wheelspin, the traction control system reduces the engine torque to match the amount of grip available. This helps the car to start moving, accelerate or climb a gradient.

Electronic differential lock (EDL)

When the EDL detects wheelspin, it brakes the spinning wheel and directs the power to the other driven wheel. This function is active up to approximately 100 km/h (62 mph).

To prevent the disc brake of the braked wheel from overheating, the EDL cuts out automatically if subjected to excessive loads. The vehicle can still be driven. The EDL will switch on again automatically when the brake has cooled down.

Tractor-trailer sway mitigation*

If the vehicle is pulling a trailer, it will control the following: Tractor-trailers tend to sway. When the swaying of the trailer is felt by the vehicle and detected by the ESC, it will automatically brake the towing vehicle within the limits of the system and mitigate the sway. Tractor-trailer sway mitigation is not available in all countries.

Electronic torque management (XDS)

When taking a curve, the driveshaft differential mechanism allows the outer wheel to turn »

at a higher speed than the inner wheel. In this way, the wheel that is turning faster (outer wheel) receives less drive torque than the inner wheel. This may mean that in certain situations the torque delivered to the inner wheel is too high, causing the wheels to spin. On the other hand, the outer wheel is receiving a lower drive torque than it could transmit. This causes an overall loss of lateral grip on the front axle, resulting in understeer or “lengthening” of the trajectory.

The XDS system can detect and correct this effect via the sensors and signals of the ESC.

Via the ESC, the XDS will brake the inside wheel and counter the excess driving torque of that wheel. This means that the driver's desired trajectory is much more precise.

The XDS system works in combination with the ESC and is always active, even when ASR traction control is disconnected, or the ESC in Sport mode or disconnected.

Multi-collision Brake

In an accident, the multi-collision brake can help the driver by braking to avoid the risk of skidding during the accident, which could lead to further collisions.

The multi-collision brake works for front, side or rear accidents, when the airbag control unit records its activation level and the accident takes place at a speed of over 10 km/h (6 mph). The ESC automatically brakes the

vehicle, as long as the accident has not damaged the ESC, the brake hydraulics or the on-board network

The following actions control automatic braking during the accident:



- When the driver presses the accelerator, the automatic braking does not take place.
- When the braking pressure through pressing the brake pedal is greater than the system's braking pressure the vehicle will brake automatically.
- Multi-collision braking will not be available if ESC is malfunctioning.

⚠ WARNING

- **The ESC, ABS, ASR, EDL, electronic self-locking differential or selective torque control systems cannot exceed the limits imposed by the laws of physics. Always bear this in mind, especially on wet or slippery roads. If you notice the systems cutting in, you should reduce your speed immediately to suit the road and traffic conditions. Do not be encouraged to take risks by the presence of more safety systems. If you do, an accident may occur.**
- **Please remember that the accident risk always increases if you drive fast, especially in corners or on a slippery road, or if you follow too close behind the vehicle in front of you. The ESC, ABS, brake assist, EDL, electronic self-locking and selective torque control systems cannot prevent accidents: risk of accidents!**

- **Accelerate with caution on slippery surfaces (for example, icy or snow-covered). Despite the control systems, the driven wheels could spin, affecting the stability of the vehicle: risk of accident!**

Note

- **The ABS and ASR will only operate correctly if the four wheels have identical tyres. Any differences in the rolling radius of the tyres can cause the system to reduce engine power when this is not desired.**
- **The regulating processes of the systems can make noises when they intervene.**
- **If the warning lamp  lights up, or  alternatively, there could be a fault » page 119.**

Switching on/off the ESC and ASR

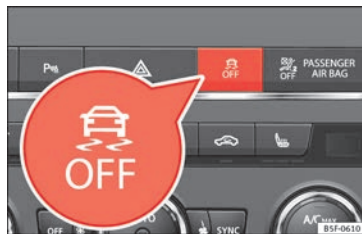


Fig. 197 Centre console: Button for switching on/off the ESC and ASR

The ESC is switched on automatically when the engine is started, and only works when the engine is running and includes the ABS, EDS and ASR systems.

The ASR and ESC function should only be switched off in situations in which traction is insufficient, among others:


- When driving in deep snow or on surfaces that are not very firm.
- To “free” the vehicle if it gets stuck.

Then switch the ASR and ESC function back on.


Depending on finishes and versions, it is possible either to disconnect only the ASR or else activate ESC Sport mode.

ESC in “Sport” mode

Sport mode can be connected via the Easy Connect »» page 120 system menu. In front-wheel drive vehicles, the interventions by the ESC and the ASR are limited. In four-wheel drive vehicles, the interventions by the ESC are limited and the ASR is switched off completely »» ⚠.


The control lamp  lights up. For vehicles with a driver information system*, the driver will be shown the **electronic stability control (ESC) option: sport**. **Warning! Limited stability.**

Disable ESC “Sport” mode

Through the Easy Connect system menu »» page 120. The warning lamp  will switch off. For vehicles with a driver information system*, the driver will be shown the **electronic stability control (ESC) option: on**.


Disable ASR

The Easy Connect system menu is used to switch off the ASR »» page 120. The traction control system will be disabled.

The control lamp  lights up. For vehicles with a driver information system* the driver will be informed that **ASR is disabled**.






Activate ASR

The Easy Connect system menu »» page 120 is used to switch on the ASR. The traction control system will be enabled.

The control lamp  switches off. For vehicles with a driver information system* the driver will be informed that **ASR is enabled**.

Disconnection of the ESC

In some versions of the model, besides the traction control system (ASR), the electronic stability programme (ESC) can also be switched off.

- Press the  button »» Fig. 197 for approximately 1 second to switch to ESC Sport mode.
- Press the button  »» Fig. 197 for approximately 3 seconds to switch off the Electronic Stability programme (ESC), including the ASR function. The  control lamp lights up and the **ESC OFF** message is displayed permanently on the instrument panel display.
- The ASR and ESC function are reconnected by pressing the button  »» Fig. 197.
- **OR:** activate or deactivate the ESC Sport or ESC function in the Easy Connect system using the **CAR** button and the **SETTINGS** and **ESC System** function buttons. The  control lamp and the **ESC OFF** message on the instrument panel go out.

⚠ WARNING

You should switch on the ESC Sport mode only if the traffic conditions and your driving ability allow you to do so safely: risk of skidding!

- **With ESC in Sport mode, the stabilising function will be limited to allow for a sportier drive. The driving wheels could spin and the vehicle could “skid”.**
- **If the ESC is deactivated, the vehicle stabilisation function is not available.**

»

Note

- If the ASR is disconnected or the ESC's Sport mode is selected, cruise control* will be switched off.
- In ESC OFF mode, the ESC will be temporarily reactivated to assist the driver during braking and will then switch back to passive mode when the brake pedal is released (depending on the model version).

Hill driving assistant

✓ Valid for vehicles: Without Auto Hold function

The hill driving assistant helps the driver to move off and upward on a hill when the vehicle is stationary.

The system maintains brake pressure for approximately two seconds after the driver takes his foot off the brake pedal to prevent the vehicle from lurching backward when it is started. During these 2 seconds, the driver has enough time to release the clutch pedal and accelerate without the vehicle moving and without having to use the handbrake, making start-up easier, more comfortable and safer.

These are the basic operation conditions:

- being on a ramp or hill/slope,
- driver door closed,
- vehicle completely stationary,

- engine running and foot on the brake,
- besides having a gear engaged or being in neutral for manual gear change and with the selector lever at position **S**, **D** or **R** for an automatic gearbox.

This system is also active when reversing uphill.

WARNING

- If you do not start the vehicle immediately after taking your foot off the brake pedal, the vehicle may start to roll back under certain conditions. Depress the brake pedal or use the hand brake immediately.
- If the engine stalls, depress the brake pedal or use the hand brake immediately.
- When following a line of traffic uphill, if you want to prevent the vehicle from rolling back accidentally when starting off, hold the brake pedal down for a few seconds before starting off.

Note

The Official Service or a specialist workshop can tell you if your vehicle is equipped with this system.

Manual gearbox**Changing gear**

Read the additional information carefully




»»  page 50

In some countries the clutch pedal must be fully pressed down for the engine to start.

Selecting reverse gear

- Engage reverse gear only when the vehicle is stopped.

Changing down gears

While driving, changing down a gear must always be done gradually, i.e. to the gear directly below and when the engine speed is not too high »»  . Changing down while bypassing one or various gears at high speeds or at high engine speeds can damage the clutch and the gearbox, even if the clutch pedal remains depressed »» .

WARNING

When the engine is running, the vehicle will start to move as soon as a gear is engaged and the clutch released. This is also the case with the electronic parking brake switched on.

- Never engage reverse gear when the vehicle is moving.

⚠ WARNING

If the gear is changed down inappropriately by selecting a gear that is too low, you may lose control of the vehicle, causing an accident and serious injuries.

ⓘ CAUTION

When travelling at high speeds or at high engine speeds, selecting a gear that is too low can cause considerable damage to the clutch and the gearbox. This can also occur if the clutch pedal is pressed and held and it does not engage.

ⓘ CAUTION

To prevent damage and avoid premature wear, please observe the following:

- Do not rest your hand on the gear lever while driving. The pressure applied by your hand is transmitted to the gearbox selector forks.
- Always ensure that the vehicle is completely stopped before engaging the reverse gear.
- Always press the clutch to the floor when changing gears.
- Never hold the vehicle “on the clutch” on hills with the engine on.


Automatic gearbox/DSG automatic gearbox*

Introduction

Your vehicle is equipped with an electronically controlled manual gearbox. Torque between the engine and the gearbox is transmitted via two independent clutches. They replace the torque converter found on conventional automatic gearboxes and allow for smooth, uninterrupted acceleration of the vehicle.

The **tiptronic** system allows the driver to change gears *manually* if desired
 » page 193, **Engaging gears with the triptronic mode***.


Selector lever positions

Read the additional information carefully
 »  page 50

The selector lever position engaged is highlighted on the display in the instrument cluster. With the selector lever in the manual gearbox positions G, D, E and S, the engaged gear is also indicated on the display.


P – Parking lock

When the selector lever is in this position, the driven wheels are locked mechanically.

The parking lock must be engaged only when the vehicle is *stationary* » .

The interlock button (the button on the selector lever handle) must be pressed in *and* simultaneously the brake pedal must be depressed before moving the selector lever either in or out of position P.

R – Reverse gear

Reverse gear must be engaged only when the vehicle is *stationary* and the engine is idling
 » .

To move the selector lever to position R, the interlock button must be pressed in *and* at the same time the brake pedal must be depressed. The reverse lights come on when the selector lever is in the R position with the ignition on.

N – Neutral (idling)

With the selector lever in this position, the gear is in neutral.

D/S – Permanent drive (forward) position

The selector lever in the D/S position enables the gears to be controlled in normal mode (D) or Sport (S) mode. To select Sport mode (S), move the selector lever backwards. Moving the lever again will select normal mode (D). The selected driving mode is shown on the instrument panel display. »

In **normal mode** (D), the gearbox automatically selects the best gear ratio. This depends on the engine load, the road speed and the dynamic gear control programme (DCP).

Sport mode (S) must be selected for a sporty driving style. This setting makes use of the engine's maximum power output. When accelerating the gear shifts will be noticeable.

Press the brake pedal to move the selector lever from N to D/S when the vehicle is stationary or at speeds below 3 km/h (2 mph) » **▲**.

Under certain circumstances (e.g. when driving in mountains) it can be advantageous to switch temporarily to tiptronic mode » **page 193**, in order to *manually select* gear ratios to suit the driving conditions.

▲ WARNING

• Take care not to accidentally press the accelerator pedal when the vehicle is stopped. The vehicle could otherwise start moving immediately (in some cases even if the parking brake is engaged) resulting in the risk of an accident.

• Never move the selector lever to R or P when driving. Failure to follow this instruction could result in an accident.

• With selector lever in any position (except P) the vehicle must always be held with the foot brake when the engine is running. This is because an automatic gearbox still transmits

power even at idling speed, and the vehicle tends to “creep”. The accelerator pedal must on no account be pressed inadvertently when a gear is engaged with the vehicle stationary. The vehicle could otherwise start moving immediately (in some cases even if the parking brake is engaged) resulting in the risk of an accident.

• While you are selecting a gear and the vehicle is stopped with the engine running, do not accelerate. Failure to follow this instruction could result in an accident.

• As a driver you should never leave your vehicle if the engine is running and a gear is engaged. If you have to leave your vehicle while the engine is running, you must apply the handbrake and engage the parking lock (P).

• To avoid accidents, apply the handbrake and put the selector lever in position P before opening the bonnet and working on the vehicle with the engine running. Please always observe the important safety warnings » **page 270**, Working in the engine compartment.

i Note

• If the selector lever is moved accidentally to N when driving, release the accelerator and let the engine speed drop to idling before selecting gear range D or S again.

• Should the power supply to the selector lever be interrupted in position P, the selector lever will be locked. If this should happen the manual release can be used » **🔧** **page 50**.

Selector lever lock

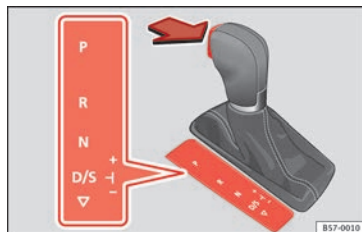


Fig. 198 Selector lever lock.

The selector lever lock prevents gears from being engaged inadvertently, so that the vehicle is not set in motion unintentionally.

The selector lever lock is released as follows:

- Switch the ignition on.
- Press the brake pedal *and* at the same time press in the interlock button.

Automatic selector lever lock

With the ignition switched on, the selector lever is locked in the positions P and N. The brake pedal must be pressed to release the lever while pressing the release button if the selector lever is in the position P. As a reminder for the driver, with the lever in positions P or N the following message will be shown on the display:

When stationary, apply footbrake while selecting a gear.

Level lock only engages with the vehicle stationary and at speeds of up to 5 km/h (3 mph). At speeds of over 5 km/h (3 mph) the lever lock is automatically deactivated in position N.

The selector lever lock is not engaged if the selector lever is moved quickly through position N (e.g. when shifting from R to D). This makes it possible, for instance, to rock the vehicle “backwards and forwards” if it is stuck. The selector lever lock engages automatically if the brake pedal is not depressed and the lever is in position N for more than about two seconds.

Interlock button

The interlock button on the selector lever handle prevents the driver from inadvertently engaging certain gears. Press the button in to disengage the selector lever lock. The selector lever positions in which the interlock button has to be pressed are shown in the illustration, highlighted in colour » Fig. 198.

Safety interlock for ignition key

If the vehicle does not have electronic braking, and depending on the country, once the ignition has been turned off, the key may be removed only if the gear selector is in posi-

tion P. While the key is not in the ignition, the selector lever is locked in position P.

Note

• If the selector lever lock does not engage, there is a fault. The transmission is interrupted to prevent the vehicle from accidentally moving. Follow the procedure below in order for the selector lever lock to engage again:

- With a 6-speed gearbox: press the brake pedal and release it again.
- With a 7-speed gearbox: press the brake pedal. Move the selector lever to position P or N and subsequently engage a gear.

• Despite a gear being engaged, the vehicle does not move forwards or back. Proceed to the next mode:

- When the vehicle does not move in the required direction, the system may not have the gear range correctly engaged. Press the brake pedal and engage the gear range again.
- If the vehicle still does not move in the required direction, there is a system malfunction. Seek specialist assistance and have the system checked.

Engaging gears with the triptonic mode*

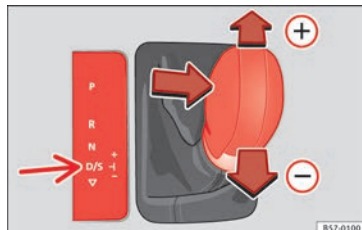


Fig. 199 Centre console: changing gear with tiptronic

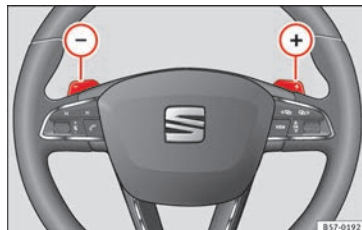




Fig. 200 Steering wheel: automatic gearbox levers

The tiptronic gives the driver the option to change gears manually. »



Changing gear manually with the selector lever

It is possible to change to tiptronic mode, both when the vehicle is stopped and while driving.

- To switch to tiptronic mode, move the selector lever from position D/S to the right. As soon as the change is made the selector level will be shown in the position **M** on the instrument panel display (for example **M4** means that the fourth gear is engaged).
- Move the selector lever forwards  to select a higher gear **»» Fig. 199**.
- Move the selector lever backwards  to select a lower gear.

Changing gear manually with the gearshift paddles*

The gearshift paddles can be used when the selector lever is in the position D/S or **M**.

- Press the gearshift paddle  to select a higher gear **»» Fig. 200**.
- Press the gearshift paddle  to select a lower gear.
- With the selector lever in position D/S, if no paddle is operated during a short period of time, the gearbox control system switches back to automatic mode. To switch to permanent manual gear change using the gearshift paddles, move the selector lever from position D/S to the right.

When accelerating, the gearbox automatically shifts up into the next gear shortly before the maximum engine speed is reached.

If you select a lower gear, the automatic gearbox will not shift down until there is no risk of over-revving the engine.


When the kick-down feature is used, the gearbox shifts down to a lower gear, depending on road speed and engine speed.

Driving tips

The gearbox changes gear ratios automatically as the vehicle moves.

The engine can only start with the selector lever in position P or N. At low temperatures, below -10°C (14°F), the engine can only start with the selector lever in position P.


Starting the vehicle


- Press and hold the brake pedal.
- Press and hold the interlock button (the button on the selector lever handle), move the selector lever to the desired position, for instance **D** **»» page 191**, and release the interlock button.
- Wait for the gearbox to engage the gear (a slight movement can be felt).
- Release the brake and press the accelerator **»» **.

Stopping briefly



- Apply the foot brake to hold the vehicle briefly when stationary (for instance at traffic lights). Do not press the accelerator.

Stopping/Parking

If the driver door is opened and the selector lever is not in position P, the vehicle could move. The driver message will be:  **Gear change: selector lever in the drive position!** Additionally, a buzzer will sound.

- Press and hold the brake pedal **»» **.
- Apply the handbrake.
- Move the selector lever to position P.

Holding the car on a hill

- *Always* apply the brake pedal firmly to prevent the vehicle “from moving backwards”; if necessary, apply the handbrake **»» **. Do **not** try to stop the vehicle “rolling back” by increasing the engine speed when a gear is engaged (pressing the accelerator) **»» **.

Moving off uphill in vehicles without Hill start assistant*

- Apply the handbrake.
- Once you have engaged a gear press the accelerator carefully and disengage the handbrake.

Moving off uphill in vehicles with Hill start assistant*

- Once you have engaged a gear, release the footbrake and press the accelerator
»» page 190, Hill driving assistant.

Driving down hills: in some situations (on mountain roads or when towing a trailer or caravan) it can be advantageous to switch temporarily to the manual gearbox programme so that the gear ratios can be selected manually to suit the driving conditions
»» ⚠.

On level ground it is sufficient to move the selector lever to position P. On slopes, first engage the parking brake and then put the selection lever into the P position. This avoids overloading the locking mechanism and it will be easier to move the selector lever from position P.

⚠ WARNING

Observe the safety warnings »» ⚠ in Selector lever positions on page 192.

- **Never allow the brake to rub and do not use the brake pedal too often or for long periods. Constant braking causes overheating in the brakes. This could significantly reduce braking power, increase braking distance or even result in the total failure of the brake system.**
- **To avoid rolling back on gradients always hold the vehicle with the footbrake or handbrake if you have to stop.**

⚠ CAUTION

- **If you stop the vehicle on a gradient, do not attempt to stop it from rolling by depressing the accelerator when a gear has been selected. This could cause overheating and damage the automatic gearbox. Apply the handbrake firmly or press the brake pedal in order to prevent the vehicle from rolling back.**
- **If you allow the car to roll with the selector lever in position N with the engine switched off, the automatic gearbox will be damaged as it will not be lubricated.**
- **In certain driving situations or traffic conditions, such as frequently starting, prolonged “creeping” of the vehicle or traffic jams with continuous stoppages, the gearbox could overheat causing damage! If the warning lamp ⚠ lights up, stop the vehicle as soon as possible and wait for the gearbox to cool
»» page 198.**

Kick-down feature

The kick-down feature allows maximum acceleration to be reached.

When the accelerator pedal is pressed right down past the point of resistance at full throttle, the gearbox will shift down to a lower gear, depending on road speed and engine speed. The upshift to the next higher gear is delayed until the engine reaches maximum rpm.

⚠ WARNING

Please note that if the road surface is slippery or wet, the kick-down feature could cause the driving wheels to spin, which could result in skidding.

Launch control program

✓ Valid for vehicles: with Launch-Control/6-Speed DSG with diesel engines superior to 125 kW and petrol engines superior to 140 kW.

The Launch control programme enables maximum acceleration.

Important: the engine must have reached operating temperature and the steering wheel must not be turned.

The engine speed for launch-control is different on petrol and diesel engines. To use the launch-control you must disconnect the anti-slip regulation (ASR) through the Easy Connect system menu »» page 120. The warning lamp ⚠ will stay switched on or will flash slowly depending on whether or not the vehicle has a driver information system*.

On vehicles with the driver information system, the ESC lamp lights up permanently and the corresponding text message **Stability control deactivated** (temporary) appears on the instrument panel to indicate the deactivation status.


»»

- When the engine is running, switch off the traction control (ASR)¹⁾.
- Turn the selector lever to the position “S” or tiptronic, or else select the **sport** driving mode from the SEAT Drive Profile*
»» page 230.
- Press the brake pedal firmly with your left foot and hold it down for at least one second.
- With your right foot, press the accelerator down to the full throttle or kick-down position. The engine speed will stabilise at about **3,200** rpm (petrol engine) or about **2,000** rpm (diesel engine).
- Take your left foot off the brake pedal.

WARNING

- Always adapt your driving style to the traffic conditions.
- Only use the launch control programme when road and traffic conditions permit, and make sure your manner of driving and accelerating the vehicle does not inconvenience or endanger other road users.
- Make sure that the ESC remains switched on. Please note that when the ASR and ESC are deactivated, the wheels may start to spin,

causing the vehicle to lose grip. Risk of accident!

- After moving off, the ESC “sport” mode should be deactivated by briefly pressing the  OFF button.

Note

- After using the Launch control programme, the temperature in the gearbox may have increased considerably. In this case, the programme could be disabled for several minutes. The programme can be used again after the cooling phase.
- Accelerating with the Launch control programme places a heavy load on all parts of the vehicle. This can result in increased wear and tear.

Downhill speed control*

The downhill speed control function helps the driver when driving down steep gradients.

Downhill speed control is activated when the selector lever is in D/S and the driver applies the foot brake. The automatic gearbox automatically engages a lower gear that is suitable for the slope. The downhill speed control

function attempts to maintain the speed at which the vehicle was travelling when the foot brake was applied (subject to the laws of physics and technical drive limitations). It may be necessary to adjust the speed again using the foot brake in certain situations. Given that the downhill speed control can only change down to 3rd gear, on very steep descents the tiptronic mode may be required. In this case, manually reduce the tiptronic to 2nd or 1st gear to use the engine brake and reduce the charge on the brakes.

Downhill speed control is deactivated as soon as the road levels out again or you press the accelerator pedal.

On vehicles with cruise control system*
»» page 209, downhill speed control is activated when you set a cruising speed.

WARNING

The downhill speed control cannot defy the laws of physics. Therefore, speed cannot be maintained constant in all situations. Always be prepared to use the brakes!

¹⁾ Vehicles without driver information system: the warning lamp flashes slowly/Vehicles with driver information system: the warning lamp stays on.

Inertia mode

The inertia mode enables the kinetic energy of the vehicle to be harnessed enabling certain stretches to be driven without using the accelerator. This enables fuel to be saved. Use the inertia mode to “let the vehicle roll” before, for example, arriving in a town.

Switching on inertia mode

Important: selector lever must be in position D, gradients below 12 %.

- Select, in SEAT Drive Profile*, **Eco mode** » page 230.
- Take your foot off the accelerator.

The driver message **Inertia** will be displayed. At speeds higher than 20 km/h (12 mph), the gearbox will automatically disengage and the vehicle will roll freely, without the effect of the engine brake. While the vehicle rolls, the engine runs at idling speed.

Stopping inertia mode

- Press the brake or the accelerator pedal.

To make use of the braking force and switch off the engine again, simply press the brake pedal briefly.

Applying both the **inertia mode** (= prolonged section with less energy) and the **switching off using inertia** (= shorter section without

the need for fuel) facilitates improved fuel consumption and emission balance.

⚠ WARNING

- **If the inertia mode has been switched on, take into account, when approaching an obstacle and releasing the accelerator pedal, that the vehicle will not decelerate in the usual manner: risk of accident!**
- **When using inertia mode while travelling down hills, the vehicle can increase speed: risk of accident!**
- **If other users drive your vehicle, warn them about inertia mode.**

i Note

- **Inertia mode is only available in eco (SEAT Drive Profile*) driving mode.**
- **The driver message Inertia is only displayed with the current consumption. In inertia mode the gear will no longer be displayed (for example “E” will appear instead of “E7”).**
- **On downhill sections with gradients above 15 %, the inertia mode will automatically be switched off temporarily.**

Emergency program

A backup programme is in place if a fault should occur in the control system.

If all the positions of the selector lever are shown over a light background on the instrument panel display, there is a system fault and the automatic gearbox will operate in with the backup programme. When the backup programme is activated, it is possible to drive the vehicle, however, at low speeds and within a selected range of gears. In some cases **driving in reverse gear may not be possible**.

ⓘ CAUTION

If the gearbox operates with the backup programme, take the vehicle to a specialised workshop and have the fault repaired without delay.

Clutch

⚠ Clutch overheating! Please stop!

The clutch has overheated and could be damaged. Stop the vehicle and wait for the gearbox to cool with the engine at idling speed and the selector lever in position P. When the warning lamp and the driver message switch off, have the fault corrected by a specialised workshop without delay. If the warning lamp and the driver message do not switch off, do not continue driving. Seek specialist assistance.

Gearbox malfunctions

⚠ Gearbox: Fault! Stop the vehicle and place the lever in the position P.

There is a fault in the gearbox. Stop the vehicle in a safe place and do not continue driving. Seek specialist assistance.

⚠ Gearbox: System fault! You may continue driving.

Have the fault corrected by a specialised workshop without delay.

⚠ Gearbox: System fault! You can continue driving with restrictions. Reverse gear disabled

Take the vehicle to a specialised workshop and have the fault repaired without delay.

⚠ Gearbox: System fault! You can continue driving in D until switching off the engine

Stop the vehicle in a safe place well away from moving traffic. Seek specialist assistance.

⚠ Gearbox: too hot. Adapt your driving accordingly

Continue driving at moderate speeds. When the warning lamp switches off, you can continue driving in a normal manner.

⚠ Gearbox: press the brake and engage a gear again.

If the fault was caused by a gearbox with a high temperature, this driver message will be displayed when the gearbox has cooled again.

Address

Electromechanical steering

Electro-mechanical power steering assists the driver when steering.

Electro-mechanical power steering adapts *electronically* to the speed of the car, torque and turning angle.

If the power steering should fail at any time or the engine is switched off (for instance when being towed), the car can still be steered. However, more effort than normal will be required to turn the steering wheel.

Driver warning lamps and messages

⚠ (in red) Faulty steering! To park the vehicle

If the warning lamp remains on and the driver indication appears, the power steering could be faulty.

Do **not** continue driving. Seek specialist assistance.

⚠ (in yellow) Steering: System fault! You may continue driving.

If the warning lamp comes on, the steering could react with more difficulty or more sensitivity than normal. In addition, when driving in a straight line the steering wheel may be off-centre.

Drive slowly to a specialised workshop and have the fault repaired.

⚠ (in yellow) Steering lock: fault! Go to an Official Service

The electronic steering lock is malfunctioning.

Go to a specialised workshop as soon as possible and have the fault repaired.

⚠ WARNING

Take it immediately to a specialised workshop and have the fault repaired: risk of accident!

📄 Note

If the lamp ⚠ (in red) or else ⚠ (in yellow) lights up briefly, you may continue driving.

Progressive steering

Depending on the vehicle equipment, the progressive steering can adapt steering hardness to the current driving situation. The

power steering only works when the engine is running.

In *city traffic* you do not need to turn so much on parking, manoeuvring or in very tight turns.

On the *road* or on the *motorway*, progressive steering transmits, for example, in bends, a sportier, more direct and noticeably more dynamic driving sensation.

Run-in and economical driving

Running in the engine

A new vehicle should be run in over a distance of 1500 km (1000 miles). For the first 1,000 km the engine speed should not exceed 2/3 of the maximum permissible engine speed. In doing so, do not accelerate at full throttle and do not drive with a trailer! From 1000 to 1500 km (600 to 1000 miles) you can gradually increase the engine rpm and road speed.

During its first few hours of running, the internal friction in the engine is greater than later on when all the moving parts have bedded down.

How the vehicle is driven for the first 1,500 km influences the future engine performance. Subsequently, also drive at a moderate rate, especially when the engine is still cold:

this will lead to less engine wear and tear and will prolong its useful life.

You should also avoid driving with the engine speed too *low*. Change down to a lower gear when the engine no longer runs “smoothly”. If the engine revs too much, cut fuel injection to protect the engine.

Environmental compatibility

Environmental protection is a top priority in the design, choice of materials and manufacture of your new SEAT.

Constructive measures to encourage recycling

- Joints and connections designed for easy dismantling.
- Modular construction to facilitate dismantling.
- Increased use of single-grade materials.
- Plastic parts and elastomers are marked in accordance with ISO 1043, ISO 11469 and ISO 1629.

Choice of materials

- Use of recycled materials.
- Use of compatible plastics in the same part if its components are not easily separated.

- Use of recycled materials and/or materials originating from renewable sources.
- Reduction of volatile components, including odour, in plastic materials.
- Use of CFC-free coolants.

Ban on heavy metals, with the exceptions dictated by law (Annex II of ELV Directive 2000/53/EC): cadmium, lead, mercury, hexavalent chromium.



Manufacturing methods

- Reduction of the quantity of thinner in the protective wax for cavities.
- Use of plastic film as protection during vehicle transport.
- Use of solvent-free adhesives.
- Use of CFC-free coolants in cooling systems.
- Recycling and energy recovery from residues (RDF).
- Improvement in the quality of waste water.
- Use of systems for the recovery of residual heat (thermal recovery, enthalpy wheels, etc.).
- The use of water-soluble paints.

Economical and environmentally-friendly driving

Fuel consumption, environmental pollution and wear to the engine, brakes and tyres depends largely on driving style. Fuel consumption can be reduced by 10-15% with an economical driving style and proper anticipation of traffic conditions. The following section gives you some tips on lessening the impact on the environment and reducing your operating costs at the same time.

Active cylinder management (ACT®)*

Depending on vehicle equipment, the active cylinder management (ACT®) may automatically deactivate some of the engine cylinders if the driving situation does not require too much power. When it is switched off, no fuel is injected into these cylinders, hence total fuel consumption may be reduced. The number of active cylinders can be seen on the instrument panel display   page 37.

Foresight when driving

Acceleration causes the vehicle to consume more fuel. If you think ahead when driving, you will need to brake less and thus accelerate less. Wherever possible, let the car roll slowly to a stop, with a **gear engaged** (for instance when you can see that the next traffic lights are red). This takes advantage of the engine braking effect, reducing wear on the

brakes and tyres. Emissions and fuel consumption will drop to zero due to the overrun fuel cut-off.

Changing gear to save energy

An effective way of saving is to change *in advance* to a higher gear. Running the engine at high rpm in the lower gears uses an unnecessary amount of fuel.

Manual gearbox: shift up from first to second gear as soon as possible. In any case, we recommend that you change to a higher gear upon reaching 2,000 rpm. Choosing the right gear enables fuel savings. Select the highest possible gear appropriate for the driving situation (the engine should continue functioning with cyclical regularity).

Automatic gearbox: accelerate gradually and without reaching the “kick-down” position.

Avoid driving at high speed

Avoid travelling at top speed, whenever possible. Fuel consumption, emission of harmful gases and noise pollution multiply disproportionately as speed is increased. Driving at moderate speeds will help to save fuel.

Reduce idling time

In vehicles with the Start-Stop system idling is automatically reduced. In vehicles without the Start-Stop system it is worth switching off the engine, for example, at level crossings

and at traffic lights that remain red for long periods of time. When an engine has reached operating temperature, and depending on the cylinder capacity, keeping it switched off for a minimum of about 5 seconds already saves more than the amount of fuel necessary for restarting.

The engine takes a long time to warm up when it is idling. Mechanical wear and pollutant emissions are also especially high during this initial warm-up phase. It is therefore best to drive off immediately after starting the engine. Avoid running the engine at high speed.

Regular maintenance

Regular servicing helps in saving fuel even before the engine is started. A well-serviced engine gives you the benefit of **improved fuel efficiency** as well as maximum reliability and an enhanced resale value. A badly serviced engine can consume up to 10% more fuel than necessary.

Avoid short journeys

The engine and catalytic converter need to reach their optimal **operating temperature** in order to minimise fuel consumption and emissions.

A cold engine consumes a disproportionate amount of fuel. The engine reaches its working temperature after about four kilometres

(2.5 miles), when fuel consumption will return to a normal level.

Check tyre pressure

Always make sure the tyres are inflated to the correct pressures » page 280 to save fuel. If the pressure is below half bar, fuel consumption may increase by 5%. Due to the greater rolling resistance, under-inflation **also** increases tyre wear and impairs handling.

Do not use **winter tyres** all year round as they increase fuel consumption by up to 10%.

Avoid carrying unnecessary loads

Given that every kilo of **extra weight** will increase the fuel consumption, it is advisable to always check the luggage compartment to make sure that no unnecessary loads are being transported.

Since the luggage rack increases the **aerodynamic drag** of the vehicle, you should remove it when not needed. At speeds of 100-120 km/h (62-75 mph), this will save 12% of fuel.

Save electrical energy

The engine drives the alternator, thereby generating electricity. This implies that any increase in power consumption also increases fuel consumption! For this reason, switch off any unneeded electrical devices. Devices that use a lot of electricity includes the blower at

a high setting, the rear window heating or the seat heating*.

Power management

This system helps to ensure reliable starting

The power management controls the distribution of electrical energy and thus helps to ensure that there is always enough power available to start the engine.

If a vehicle with a conventional electrical system is left parked for a long time, the battery will gradually lose its charge because certain electrical devices, such as the electronic gearbox lock continues to draw current even when the ignition is off. In some cases there may not be enough power available to start the engine.

Your vehicle is equipped with an intelligent power management system to control the distribution of electrical energy. This significantly improves reliability when starting the engine, and also prolongs the useful life of the battery.

The main functions incorporated in the power management system are **battery diagnosis**, **residual current management** and **dynamic power management**.

Battery diagnosis

The battery diagnosis function constantly registers the condition of the battery. Sensors detect the battery voltage, battery current and battery temperature. This enables the system to calculate the current power level and charge condition of the battery.

Residual current management

The residual current management reduces power consumption while the vehicle is parked. It controls the supply of power to the various electrical devices while the ignition is switched off. The system takes the battery diagnosis data into consideration.




Depending on the power level of the battery, switch off the individual electrical devices one after the other to prevent the battery from losing too much charge and to ensure that the engine can be started reliably.

Dynamic power management

While the vehicle is moving, this function distributes the available power to the various electrical devices and systems according to their requirements. The power management ensures that on-board systems do not consume more electrical power than the alternator can supply, and thus maintains the maximum possible battery power level.

»

 Note

- Neither is the power management system able to overcome the given physical limits. Please remember that the power and useful life of the battery are limited.
- When there is a risk that the vehicle will not start, the alternator power failure or low battery charge level warning lamp will be shown    page 119.

Flat battery

Starting ability has first priority.

Short trips, city traffic and low temperatures all place a heavy load on the battery. In these conditions a large amount of power is consumed, but only a small amount is supplied. The situation is also critical if electrical devices are in use when the engine is not running. In this case power is consumed when none is being generated.

In these situations you will be aware that the power management system is intervening to control the distribution of electrical power.

When the vehicle is parked for long periods

If you do not drive your vehicle for a period of several days or weeks, the power management will gradually shut off the electrical devices one by one or reduce the amount of current they are using. This limits the amount of

power consumed and helps to ensure reliable starting even after a long period. Some convenience functions, such as remote vehicle opening, may not be available under certain circumstances. These functions will be restored when you switch on the ignition and start the engine.

With the engine switched off

For example, if you listen to the sound system with the engine switched off the battery will run down.

If the energy consumption means there is a risk that the engine will not start, a text will appear in vehicles with a driver information system*.

This driver indicator tells you that you must start the engine so that the battery can recharge.

When the engine is running

Although the alternator generates electrical power, the battery can still become discharged while the vehicle is being driven. This can occur when a lot of power is being consumed but only a small amount supplied, especially if the battery is not fully charged initially.

To restore the necessary energy balance, the system will then temporarily shut off the electrical devices that are using a lot of power, or reduce the current they are consuming. Heat-

ing systems in particular use a large amount of electrical power. If you notice, for instance, that the seat heating* or the rear window heater is not working, they may have been temporarily switched off or regulated to a lower heat output. These systems will be available again as soon as sufficient electrical power is available.

You may also notice that the engine runs at a slightly faster idling speed when necessary. This is quite normal, and no cause for concern. The increased idling speed allows the alternator to meet the greater power requirement and charge the battery at the same time.

Engine management and emission control system




Introduction

WARNING

- Because of the high temperatures which can occur in the exhaust purification system (catalytic converter or diesel particulate filter), do not park the vehicle where the exhaust can come into contact with flammable materials under the car (e.g. on grass or at the forest edge). Fire hazard!

- **Do not apply wax underneath the vehicle around the area of the exhaust system: Fire hazard!**

Note

While the control lamps , , **EPC** or  remain lit, there may be engine problems, fuel consumption may increase and the engine may lose power.

Catalytic converter


- ✓ Applies to vehicles with petrol engine

The vehicle must only be used with unleaded petrol, otherwise the catalytic converter will be irreparably damaged.


Never drive until the tank is empty; an irregular supply of fuel can cause faulty combustion. In these cases, unburned fuel reaches the exhaust system, which can overheat and damage the catalytic converter.

Diesel particulate filter

- ✓ Applies to vehicles with diesel engine

The diesel engine particulate filter eliminates most of the soot from the exhaust gas system. Under normal driving conditions, the filter cleans itself. The diesel particulate filter is cleaned automatically without need for indication by the warning lamp . This may be

noticed because the engine idle speed increases and an odour may be detected.

If automatic filter purification cannot be carried out (because only short trips are taken, for example), soot will accumulate on the filter and the Diesel particulate filter warning lamp will  switch on.

Facilitate the automatic filter cleaning process by driving in the following manner: drive for approximately 15 minutes at a minimum speed of 60 km/h (37 mph) in 4th or 5th gear (automatic gearbox: gear S). Maintain the engine speed at approximately 2,000 rpm. The rise in temperature causes the soot on the filter to burn. On completion of the cleaning the warning lamp will switch off. If the warning lamp does not switch off, go immediately to a specialised workshop to rectify the problem.

Engine management* **EPC**

This warning lamp monitors the engine management system for petrol engines.

The warning lamp **EPC** (Electronic Power Control) lights up when the ignition is switched on while system operation is being verified. It should go out once the engine is started.

If there is a fault in the electronic engine management system while you are driving, this warning lamp will light up. Take the vehi-

cle to a specialised workshop as soon as possible and have the engine checked.

Emission control system*

Control lamp flashes:

When there is misfiring that can damage the catalytic converter. Reduce speed and drive carefully to the nearest specialised workshop to have the engine checked.


The control lamp lights up:

If a fault has developed during driving which has reduced the quality of the exhaust gas (e.g. lambda probe fault). Reduce speed and drive carefully to the nearest specialised workshop to have the engine checked.


Engine pre-heating/fault system*

The warning lamp lights up to show that the glow plugs are preheating the diesel engine.

The control lamp lights up

If the control lamp  lights up when the engine is started it means that the glow plugs are preheating. The engine can be started straight away when the lamp switches off. »

Control lamp flashes

If a fault develops in the engine management system while you are driving, the glow plug system lamp will flash . Take the vehicle to a specialised workshop as soon as possible and have the engine checked.

Driving tips

Driving through flooded roads

To prevent damage to the vehicle when driving through water, for example, along a flooded road, please observe the following:

- The water should never come above the lower edge of the bodywork.
- Drive at pedestrian speed.


WARNING

After driving through water, mud, sludge, etc., the braking effect can be delayed slightly due to moisture build-up on the discs and brake pads. Applying the brakes carefully several times will remove the moisture and restore the full braking effect.

CAUTION

• Driving through flooded areas may severely damage vehicle components such as the en-

gine, transmission, running gear or electrical system.

- Whenever driving through water, the Start-Stop system* must be switched off  page 205.

Note


- Check the depth of the water before entering the flooded zone.
- Do not stop in the water, drive in reverse, or stop the engine in any situation.
- Note that vehicles travelling in the opposite direction may splash water that could exceed the maximum permitted water height for your vehicle.
- Avoid driving through salt water (corrosion).



Four-wheel drive

- ✓ Valid for vehicles: with four-wheel drive

On four-wheel drive models, the engine power is distributed to all four wheels

General notes



On four-wheel drive vehicles, the engine power is distributed to all four wheels. The distribution of power is controlled automatically according to your driving style and the road conditions. Also see  page 187, Braking and stability systems.

The four-wheel drive is specially designed to complement the superior engine power. This combination gives the vehicle exceptional handling and performance capabilities, both on normal roads and in more difficult conditions, such as snow and ice. Even so (or perhaps especially for this reason), it is important to observe certain safety points  .


Winter tyres

Thanks to four-wheel drive, your vehicle will have plenty of traction in winter conditions, even with the standard tyres. Nevertheless, we still recommend that winter tyres or all-season tyres be fitted on all *four* wheels to give even better *braking response*.

Snow chains

On roads where snow chains are mandatory, this also applies to cars with four-wheel drive   page 69.

Changing tyres

On vehicles with four-wheel drive, all four tyres must have the same rolling circumference. Also avoid using tyres with varying tread depths  page 281.

Off-roader?

Your SEAT is not an off-road vehicle: it does not have enough ground clearance to be used as such. It is therefore best to avoid

rough tracks and uneven terrain as much as possible.

WARNING

- Even with four-wheel drive, you should always adjust your speed to suit the conditions. Do not let the extra safety features tempt you into taking any risks when driving. Risk of accident!
- The braking capability of your vehicle is limited by the tyres' grip. It is therefore no different from a car without four-wheel drive. So do not be tempted to drive too fast on firm or slippery roads just because the vehicle still has good acceleration in these conditions. Risk of accident!
- On wet roads bear in mind that the front wheels may start to "aquaplane" and lose contact with the road if the car is driven too fast. If this should happen, there will be no sudden increase in engine speed to warn the driver, as occurs with a front-wheel drive car. For this reason you should always choose a driving speed suitable for the road conditions. Risk of accident!

Driver assistance systems

Start-Stop System*

Description and operation

The Start-Stop system helps save fuel and reduce CO₂ emissions.

In Start-Stop mode, the engine will automatically switch off when the vehicle stops or is stopping; for example when stopping at traffic lights. The ignition remains switched on during the stopping phase. The engine automatically switches back on when required. In this situation, the light of the **START ENGINE STOP** button stays on¹⁾.

As soon as the ignition is switched on, the Start-Stop function is automatically activated.

Further information about the Start-Stop system can be found in the Easy Connect system: by pressing the **CAR** button in the **Vehicle status** menu.

Basic requirements for the Start-Stop mode

- The driver door must be closed.
- The driver must have their seat belt fastened.

- The bonnet must be closed.
- The engine must have reached a minimum service temperature.
- The reverse gear must not be engaged.
- The vehicle must not be on a very steep slope.

WARNING

- **Never switch the engine off until the vehicle is stationary. The brake servo and power steering functions will not be completely covered under warranty. More force may also be needed to turn the steering wheel or to brake. As you cannot steer and brake in the normal manner, there is a greater risk of accidents and serious injury.**
- **Never remove the key from the ignition if the vehicle is in motion. Otherwise, the steering could lock making it impossible to steer the vehicle.**
- **To avoid injury, make sure that the Start-Stop system is switched off when working in the engine compartment »» page 207.**

CAUTION

The Start-Stop system must always be switched off when driving through flooded areas »» page 207.

¹⁾ Only in vehicles with Keyless Access.

Stopping/Starting the engine

Vehicles with a manual gearbox

- Before stopping the vehicle or when it is stopped, put it into neutral and release the clutch pedal. The engine will switch off. The warning lamp (A) will appear on the instrument panel display. The engine may stop before the vehicle comes to a halt in the deceleration phase (at 7 km/h).
- When the clutch pedal is pressed the engine will start up again. The warning lamp will switch off.

Vehicles with an automatic gearbox

- Use the foot brake to bring the vehicle to a stop and keep the brake pedal pressed down with your foot. The engine will switch off. The warning lamp (A) will appear in the display. The engine may stop before the vehicle comes to a halt in the deceleration phase (at 7 km/h or 2 km/h, depending on the vehicle's gearbox).
- When you take your foot off the brake pedal the engine will start up again. The warning lamp will switch off. In vehicles with the Auto Hold* system, when the system is active, the engine will not start if you remove your foot from the brake pedal. The car starts when you press the accelerator pedal.

Additional information related to the automatic gearbox

The engine stops when the selector lever is in the positions P, D, N and S, in addition to when in manual mode. With the selector lever in position P, the engine will also remain switched off when you take your foot off the brake pedal. In order to start the engine up again the accelerator must be pressed, or another gear engaged or the brake released.

If the selector lever is placed in position R during the stopping phase, the engine will start up again.

Change from position D to P to prevent the engine from accidentally starting when changing and passing by position R.

Additional information about vehicles with Adaptive Cruise Control (ACC)

In vehicles with ACC function, the engine will start up again in certain operating conditions if the radar sensor detects that the vehicle ahead drives off again.

Note

- **In vehicles with an automatic gearbox, you can control whether the engine should switch off or not by reducing or increasing the brake force applied. While the vehicle remains stopped, the engine will not stop if the brake pedal is slightly pressed, in traffic jams with frequent stopping and starting for example. As**

soon as strong pressure is applied to the brake pedal, the engine will stop.


- **In vehicles with manual gearbox, during the stopping phases the brake pedal must remain depressed to prevent the vehicle from moving.**
- **If the engine “stalls” in vehicles with manual gearbox, it can be directly started up again by immediately pressing the clutch pedal.**

General notes



The system can interrupt the Start-Stop mode frequently for different reasons.

The engine does not switch off

Before the stopping phase, the system verifies whether certain conditions are met. The engine **does not** switch off, in the following situations for example:


- The engine has not yet reached the minimum required temperature for the Start-Stop mode.
- The interior temperature selected for the air conditioner has not yet been reached.
- The interior temperature is very high/low.
- Defrost function button activated
»  page 52.
- The parking aid* is switched on.

- The battery is very low.
- The steering wheel is overly turned or is being turned.
- If there is a danger of misting.
- After engaging reverse gear.
- In case of a very steep gradient.

The indication  is shown on the instrument panel display, and in addition, the driver information system* shows, .

The engine starts by itself

During a stopping phase the normal Start-Stop mode can be interrupted in the following situations: The engine restarts by itself without involvement from the driver.

- The interior temperature differs from the value selected on the air conditioner.
- Defrost function button activated
»  page 52.
- The brake has been pressed several times consecutively.
- The battery is too low.
- High power consumption.

Note

In vehicles with an automatic gearbox, if the selector lever is placed in position D, N or S after engaging reverse gear, the vehicle must be driven at a speed faster than 10 km/h (6

mph) for the system to return to conditions in which the engine can be stopped.

Manually switching on/off the Start-Stop system

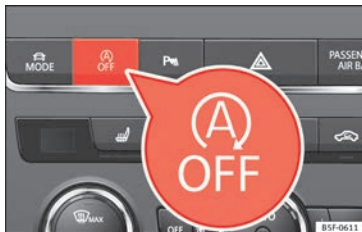



Fig. 201 Centre console: Start-Stop system button.

If you do not wish to use the system, you can switch it off manually.

- To manually switch on/off the Start-Stop system, press the  button. The button symbol remains lit up yellow when the system is switched off.

Note

The system is automatically switched on each time the engine is deliberately stopped during a stopping phase. The engine will start automatically.

Driver messages on the instrument panel display

Start-Stop system deactivated. Start the engine manually

This driver message is displayed when certain conditions are not met during the stopping phase and the Start-Stop system **cannot** restart the engine. The engine must be started manually.

Start-Stop system: Fault! Function not available


There is a fault in the Start-Stop system. Take the vehicle to a workshop to have the fault repaired.

Auto Hold Function*

Description and operation



Fig. 202 In the lower part of the centre console: Auto Hold function button.


The control light of the  **Fig. 202** button remains on when the Auto Hold function is connected.

Once connected, the Auto Hold function assists the driver in keeping the vehicle stationary at repeated intervals or for a certain period of time with the engine running, for example, when going up a slope, when stopped at traffic lights or in heavy traffic with intermittent stops.

When connected, the Auto Hold function automatically prevents the vehicle from rolling when stationary without pressing the brake pedal.

After detecting that the vehicle is stationary and the brake pedal has been released, the Auto Hold function holds the vehicle. The driver can lift their foot off the brake pedal.



When the driver touches the accelerator pedal or accelerates slightly to continue driving, the Auto Hold function releases the brake. The vehicle moves according to the slope of the road.

If the vehicle is stationary and one of the conditions required by the Auto Hold function is impaired, it disconnects itself and the button's control light goes out **» Fig. 202**. The electronic parking brake connects automatically, if necessary, to park the vehicle safely **»** .


Conditions for keeping the vehicle stationary with the Auto Hold function

- The driver door must be closed.
- The driver's seat belt must be fastened.
- The engine is running.

Switching the Auto Hold function on and off


Press the button  **»** . The control lamp on the button goes out when the Auto Hold function is switched off.

Automatically engaging and disengaging the Auto Hold function

If the Auto Hold function was switched on with the  button before disengaging the ignition, the function will remain on after the ignition is re-engaged.

If the Auto Hold function was not switched on, it will automatically remain off next time the ignition is engaged.

The Auto Hold function is automatically switched on if the following conditions are met:

All conditions must be met at the same time **»** .

	Manual gearbox	Automatic gearbox
1.	The vehicle is kept stationary with the brake pedal on a flat surface or on a slope.	
2.	The engine rotates "correctly".	
	Upon pressing the clutch and accelerating at the same time, the brake releases gradually.	Upon accelerating, the brake releases gradually.

The Auto Hold function is automatically turned off if the following conditions are met:

	Manual gearbox	Automatic gearbox
1.	If any of the conditions mentioned on » page 208, Conditions for keeping the vehicle stationary with the Auto Hold function are no longer met.	
2.	If the engine is running irregularly or an anomaly is detected.	
3.	If the engine is turned off or stalls.	If the engine is switched off.
4.	The clutch and the accelerator are pressed at the same time.	If the accelerator is pressed.
5.	If any of the tyres has only minimal contact with the ground, e.g. in the case of axle articulation.	

⚠ WARNING

The smart technology incorporated into the Auto Hold function cannot defy the laws of physics; it only works within the limits of the system. The greater convenience provided by the Auto Hold function should never tempt you to take any risk that may compromise safety.

- Never leave the vehicle running and with the Auto Hold function switched on.

- The Auto Hold function cannot always keep the vehicle stationary uphill or downhill or stop it sufficiently, for example, on slippery or frozen surfaces.

📄 Note

Before entering a car wash, always switch off the Auto Hold function, because if the electronic parking brake is automatically connected, it may cause damage.

Cruise control system (CCS)*

Operation



Fig. 203 Instrument panel display: CCS status indications.

Read the additional information carefully » 📖 page 45

The cruise control system (CCS) is able to maintain the set speed from 20 km/h (15 mph).

The CSS only reduces vehicle speed by ceasing to accelerate, not by actively braking the vehicle » ⚠.

Control lamp

When the warning lamp 🚦 is lit, cruise control is active.

Several warning and control lamps light up for a few seconds when the ignition is switched on, signalling that the function is being verified. They will switch off after a few seconds.

Displayed on the CCS screen

Status Fig. 203:

- Ⓐ CCS temporarily switched off. The set speed is displayed in small figures.
- Ⓑ System error. Contact a specialised workshop.
- Ⓒ CCS switched on. The speed memory is empty.
- Ⓓ The CCS is switched on. The set speed is displayed in large figures.

⚠ WARNING


Use of the cruise control could cause accidents and severe injuries if it is not possible to drive at a constant speed maintaining the safety distance.

- Do not use the cruise control in heavy traffic, if the distance from the vehicle in front is insufficient, on steep roads, with several bends or in slippery circumstances (snow, ice, rain or loose gravel), or on flooded roads.
- Never use the CCS when driving off-road or on unpaved roads.
- Always adapt your speed and the distance to the vehicles ahead in line with visibility, weather conditions, the condition of the road and the traffic situation.
- To avoid unexpected operation of the cruise control system, turn it off every time you finish using it.
- It is dangerous to use a set speed which is too high for the prevailing road, traffic or weather conditions.
- When travelling down hills, the CCS cannot maintain a constant speed. The vehicle tends to accelerate under its own weight. Select a lower gear or use the foot brake to slow the vehicle.

⚠ WARNING

Observe the safety warnings » in Warning and control lamps on page 119.

Operating the cruise control system*

Read the additional information carefully
»  page 45

The value indicated in the table in brackets (in mph, miles per hour) only refers to instrument panels with indications in miles.

Changing gear in CCS mode

The CCS decelerates as soon as the clutch pedal is pressed, intervening again automatically after a gear is engaged.

Travelling down hills with the CCS

When travelling down hills the CCS cannot maintain a constant speed. Slow the vehicle down using the brake pedal and reduce gears if required.

Automatic off

The cruise control system (CCS) is switched off automatically or temporarily:

- If the system detects a fault that could affect the working order of the CCS.
- If you press and maintain the accelerator pedal for a certain time, driving faster than the stored speed.
- If the dynamic driving control systems intervene (e.g. ASR or ESC).
- If the airbag is triggered.

Emergency brake assist system (Front Assist)***Topic introduction**

Fig. 204 On the instrument panel display: pre-warning messages.

The objective of the emergency brake assist system is to prevent head-on collisions against objects that may be in the vehicle's path or minimise the consequences of such impacts.


Within the limitations imposed by the environmental conditions and by the system itself, the function acts in staggered fashion, depending on how critical the situation is. Initially it warns the driver, and if the driver's reaction does not occur or is insufficient, it activates an independent emergency braking.

The function is intended to prevent collisions with parked vehicles or vehicles in the same lane travelling in the same direction, or with pedestrians crossing the vehicle's path. It may fail to activate in other danger situations.

The Front Assist function is active within a range of speeds between 4 km/h (2.5 mph) and 250 km/h (156 mph). Depending on speed, traffic conditions and driver behaviour, some of the sub-functions described below are omitted in order to optimise the system's general behaviour.

The Front Assist is a driving assistance function that can never replace the driver's attention.

Safety distance warning


If the system detects a situation of danger because the vehicle is too close to the vehicle ahead, it will warn the driver by means of an indication on the instrument panel display .

The timing of the warning varies depending on driver behaviour and the traffic situation.

Advance warning

If the system detects a possible collision with the vehicle in front, it may alert the driver by means of an audible warning and an indication on the instrument panel display

»» Fig. 204.

The warning moment varies depending on the traffic situation and driver behaviour. At the same time, the vehicle will prepare for a possible emergency braking »» .

Critical warning

If the driver fails to react to the pre-warning (advance warning), the system may actively intervene in the brakes and generate a brief jolt to warn the driver of the imminent danger of a collision.

Automatic braking


If the driver also fails to react to the critical warning, the system may initiate independent emergency braking by progressively increasing the braking effect in accordance with how critical the situation is.

Driver emergency brake assist system

Faced with an imminent collision, the system may detect that the driver is not braking hard enough to avoid the collision. In this case, it will automatically increase the braking effect.

Due to certain driving circumstances and the limitations of its operation, there are some cases in which the system cannot prevent a collision, although it can significantly minimise the consequences by reducing the speed and the force of the impact.

WARNING

Observe the safety warnings »»  in Warning and control lamps on page 119.

WARNING

The Front Assist system cannot change the laws of physics or replace the driver in terms of keeping control of the vehicle and reacting to a possible emergency situation.

WARNING

Following a Front Assist emergency warning, pay immediate attention to the situation and try to avoid the collision by braking or by dodging the obstacle, as applicable.

- If the Front Assist does not work as described in this chapter (e.g. it repeatedly intervenes unnecessarily), switch it off.
- Adapt your speed and safe distance to the vehicle in front of you at all times to suit visibility, weather, road and traffic conditions.
- The Front Assist alone cannot avoid accidents and serious injuries.
- In complex driving situations, occasionally the Front Assist may issue warnings and intervene in braking unnecessarily, for example at traffic islands.
- If the operation of the Front Assist is impaired, for example, by dirt or because the radar sensor has lost its settings, the system may issue unnecessary warnings and intervene inopportunistly in the braking.

- The Front Assist does not react to animals or vehicles crossing your path or approaching head-on down the same lane.
- The Front Assist does not react to pedestrians walking in the same direction or approaching head-on down the same lane.
- The driver must always be ready to take over the control of the vehicle.
- When the Front Assist causes a braking, the brake pedal is “harder”.
- Automatic interventions by the Front Assist on the brakes may be interrupted by pressing the clutch, accelerator or moving the wheel.

Note

- When the Front Assist is connected, the indications on the instrument panel screen may be concealed by warnings from other functions, such as an incoming call.
- When the Front Assist causes a braking, the brake pedal is “harder”.
- Automatic interventions by the Front Assist on the brakes may be interrupted by pressing the clutch, accelerator or moving the wheel.
- The Front Assist may brake the vehicle until it stops completely. However, the brake system does not halt the vehicle permanently. Use the foot brake!
- If the Front Assist does not work as described in this chapter (e.g. in intervenes several times unnecessarily), switch it off. Have the system checked by a specialised workshop. SEAT recommends visiting a SEAT dealership.

Radar sensor

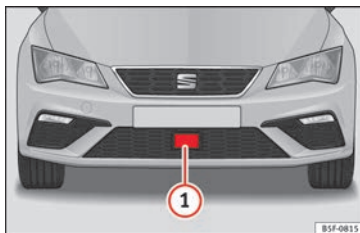


Fig. 205 On the front bumper: radar sensor.

A radar sensor is installed on the front bumper to determine the traffic situation

»» Fig. 205 ①.

The radar sensor's visibility may be impaired by dirt, mud or snow, or by environmental influences such as rain or mist. In this case, the Front Assist does not work. The instrument panel displays the following message: **Front Assist: No sensor vision!** If necessary clean the radar sensor»» ①.

When the radar sensor begins to operate properly again, the Front Assist will automatically be available again. The message will disappear from the instrument panel display.

Front Assist operation may be affected by a strong radar reverse reflection. This may occur, for example, in a closed car park or due

to the presence of metallic objects (e.g. rails on the road or sheets used in road works).

The area in front of and around the radar sensor should not be covered with adhesives, additional or similar headlights, as this may negatively affect Front Assist operation.

If the front of the vehicle is not properly repaired or structural modifications are made to it, for example if the suspension is lowered, Front Assist operation may be affected. SEAT recommends visiting a SEAT dealership for this purpose.

CAUTION

If you have the sensation that the radar sensor is damaged or has lost its settings, disconnect the Front Assist. This will avoid possible dangerous situations caused by a system malfunction. If this occurs have it adjusted.

- The sensor may become damaged or lose its settings when knocked, for example, during a parking manoeuvre. This may compromise the system's efficacy or disconnect it.
- Repairs to the radar sensor require specialist knowledge and special tools. SEAT recommends visiting a SEAT dealership for this purpose.
- A registration plate or plate holder on the front that is larger than the space for the registration plate, or a registration plate that is curved or warped can cause the radar to malfunction.

- Clean away the snow with a brush and the ice preferably with a solvent-free de-icer spray.

Operating the Emergency braking assistance system (Front Assist)



Fig. 206 On the instrument panel display: Front Assist switched off message.

The Front Assist is active whenever the ignition is switched on.

When the Front Assist is switched off, so too are the advance warning function (pre warning) and the distance warning.

SEAT recommends leaving the Front Assist always switched on. Exceptions » page 213, **Switching the Front Assist off temporarily in the following situations.**

Switching the Front Assist on and off

With the ignition switched on, the Front Assist can be switched on and off as follows:

- Select the corresponding menu option using the button for the driver assistance systems » » page 36.
- **OR:** switch the system on and off in Easy Connect using the **CAR** button and the **SETTINGS** and **Driver assistance** function buttons » » page 33.

When Front Assist is switched off, the instrument panel will inform that it has been switched off with the following indicator » » **Fig. 206.**

Activating or deactivating the pre-warning (advance warning)

The pre-warning function (advance warning) can be switched on or off in the Easy Connect system with the **CAR** button and the **SETTINGS** and **Driver assistance** function buttons » » page 33.

The system will store the setting for the next time the ignition is switched on.

SEAT recommends keeping the pre-warning function switched on at all times.

Depending on the infotainment system installed in the vehicle, the advance warning function may be adjusted as follows:

- Advance

- Medium
- Delayed
- Deactivated

SEAT recommends driving with the function in “Medium” mode.

Switching distance warning on and off

If the safe distance with regard to the vehicle in front is exceeded, the relevant warning will appear on the instrument panel display » » . In this case, increase the safe distance.

The distance warning can be switched on and off in the Easy Connect system using the **CAR** button and the **SETTINGS** and **Driver assistance** function buttons » » page 33.

The system will store the setting for the next time the ignition is switched on.

SEAT recommends keeping the distance warning switched on at all times.

Switching the Front Assist off temporarily in the following situations

In the following situations the Front Assist should be deactivated due to the system's limitations:

- When the vehicle is to be towed. »

- If the vehicle is on a test bed.
- When the radar sensor is damaged.
- If the radar sensor takes a heavy knock, for example in a rear collision.
- If it intervenes several times unnecessarily.
- If the radar sensor is covered temporarily with some kind of accessory, such as an additional headlight or the like.
- When the vehicle is to be loaded on a lorry, ferry or train.

System limitations

The Front Assist has certain physical limitations inherent to the system. Thus, in certain circumstances, some of the system's reactions may be inopportune from the driver's standpoint. So pay attention in order to intervene if necessary.

The following conditions may cause the Front Assist not to react or to do so too late:

- In the first few instants of driving after switching on the ignition, due to the system's initial auto-calibration.
- On taking tight bends or complex paths.
- Pressing the accelerator all the way down.
- If the Front Assist is switched off or damaged.

- If the ASR has been disconnected or the ESC activated in **Sport** mode manually »» page 188.
- If the ESC is controlling.
- If several brake lights of the vehicle or electrically connected trailer are damaged.
- If the radar sensor is dirty or covered.
- If there are metal objects, e.g. rails on the road or sheets used in road works.
- If the vehicle is reversing.
- If the vehicle over-accelerates.
- In case of snow or heavy rain.
- In case of narrow vehicles, such as motor-bikes.
- Misaligned vehicles.
- Vehicles crossing the other's path.
- Vehicles approaching in the opposite direction.
- Special loads and accessories of other vehicles that jut out over the sides, backwards or over the top.

Adaptive Cruise Control ACC*

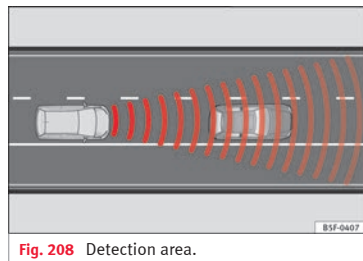
Related video



BSF-0841


Fig. 207 Safety

Introduction



BSF-0407

Fig. 208 Detection area.

The adaptive cruise control (ACC) **is an extension of the normal cruise control system (CCS)** »» .

The ACC function allows the driver to program a cruise speed of between 30 and 210 km/h

(18 and 150 mph) and to select the distance required with regard to the vehicle in front.

The ACC will adapt the vehicle's cruise speed at all times, maintaining a safe distance with the vehicle in front based on its speed.

When driving behind another vehicle, the ACC function reduces speed until it is the same as that of the vehicle ahead and maintains the set distance between the vehicles. If the vehicle ahead accelerates, the adaptive cruise control also accelerates, going no higher than the target speed programmed.

If the vehicle is equipped with automatic gearbox, the ACC can brake the vehicle **until it stops completely** if a vehicle in front of it stops.

The distance programmed should be increased when the road surface is wet.

Driver intervention prompt

During driving, the ACC is subject to certain limitations inherent in the system. In other words, in certain circumstances the driver will have to adjust speed him or herself, as well as the distance from other vehicles.

In this case, the instrument panel screen *will warn you to intervene* by applying the brake and a warning tone will be heard
»» page 216.

WARNING

The intelligent technology in the ACC cannot overcome the system's inherent limitations or change the laws of physics. If used negligently or involuntarily, it may cause serious accidents and injuries. The system is not a replacement for driver awareness.

- Adapt your speed and safe distance to the vehicle in front of you at all times to suit visibility, weather, road and traffic conditions.
- Do not use the ACC when visibility is bad, on steep roads, with several bends or in slippery circumstances such as snow, ice, rain or loose gravel, or on flooded roads.
- Never use the ACC when driving off-road or on unpaved roads. The ACC has been designed for use on paved roads only.
- The ACC does not react on approaching a fixed obstacle, such as the tail of a traffic jam, a damaged vehicle or a vehicle stopped at the traffic lights.
- The ACC only reacts to people if a pedestrian monitoring system is available. In addition, the system does not react to animals or vehicles crossing your path or approaching head-on down the same lane.
- If the ACC does not reduce speed sufficiently, brake the vehicle immediately by applying the pedal.
- If you are driving using the spare wheel, the ACC system could automatically switch off during the journey. Switch off the system when starting off.

- If the vehicle continues to move involuntarily after a driver intervention prompt, brake the vehicle by applying the pedal.
- If the dash panel displays a *driver intervention prompt*, adjust the distance yourself.
- The driver should be ready to accelerate or brake by him/herself at all times.

CAUTION

If you have the sensation that the radar sensor is damaged, disconnect the ACC. This will avoid possible damage. If this occurs have it adjusted.

- Repairs to the radar sensor require specialist knowledge and special tools. SEAT recommends visiting a SEAT dealership for this purpose.

Note

- If the ACC system does not work as described in this chapter, do not use it until it has been checked by a specialised workshop. SEAT recommends visiting a SEAT dealership for this purpose.
- Maximum speed with the ACC activated is limited to 210 km/h (150 mph).
- When the ACC is switched on, strange noises may be heard during automatic braking cause by the braking system.

Indications on the display, warning and control lamps

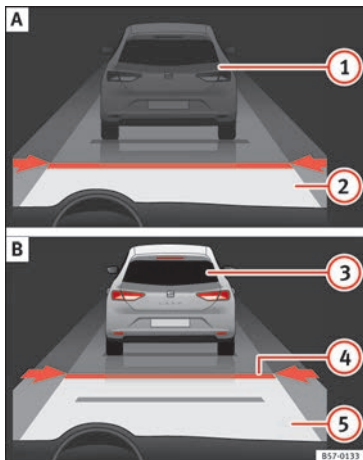


Fig. 209 On the instrument panel display: (A) ACC inactive (Standby). (B) ACC active.

Status display

Indications on the display »» **Fig. 209:**

- ① Vehicle ahead detected. ACC is not active and is not regulating your speed.
- ② Distance from the vehicle ahead. ACC is not active and is not regulating your distance.

- ③ Vehicle ahead detected. ACC is active and is regulating your speed.
- ④ Distance level 2 set by the driver.
- ⑤ ACC is active and is regulating your distance based on speed.

Warning and control lamps

»» in **Warning and control lamps** on page 119.



The speed reduction by the ACC to maintain the distance from the vehicle in front is not sufficient.

Brake! apply the foot brake! Driver intervention prompt.



The ACC is not currently available.^{a)}

With the vehicle stationary, switch off the engine and start it up again. Check the SEAT badge area on the front »» **Fig. 210** (in case it is dirty or icy or it has been hit). If it is still unavailable, refer to a specialised workshop to have the system inspected.

^{a)} The symbol on the instrument panels with colour display is in colour.



The ACC is active.

No vehicle is detected in front. The programmed speed remains constant.



If the symbol is white: the ACC is active.

A vehicle in front has been detected. The ACC adjusts speed and distance from the vehicle in front.



If the symbol is grey: ACC is inactive (Standby)

The system is switched on, but is not adjusting.



It lights up green

The ACC is active.

Some warning and control lamps will light up briefly when the ignition is switched on to check certain functions. They will switch off after a few seconds.



WARNING

Observe the safety warnings »» in Warning and control lamps on page 119.



Note

When the ACC is connected, the indications on the instrument panel screen may be concealed by warnings from other functions, such as an incoming call.

Radar sensor



Fig. 210 On the front bumper: radar sensor.

A radar sensor is installed on the front bumper to determine the traffic situation

»» **Fig. 210 ①**.

The radar sensor's visibility may be impaired by dirt, mud or snow, or by environmental influences such as rain or mist. In this case the adaptive cruise control (ACC) does not work. The instrument panel displays the following message: **ACC: No sensor vision!** If necessary, clean the sensor »» **①**.

When the radar sensor begins to operate properly again, the ACC will automatically be available again. The message on the instrument panel screen will switch off and the ACC will be reactivated again.

ACC operation may be affected by a strong radar reverse reflection. This may occur, for example, in a closed car park or due to the

presence of metallic objects (e.g. rails on the road or sheets used in road works).

The area in front of and around the radar sensor should not be covered with adhesives, additional or similar headlights, as this may negatively affect ACC operation.

If the front of the vehicle is not properly repaired or structural modifications are made to it, for example, if the suspension is lowered, ACC operation may be affected. In this scenario, SEAT recommends visiting a SEAT dealership.

- **Clean away the snow with a brush and the ice preferably with a solvent-free de-icer spray.**

ⓘ CAUTION

If you have the sensation that the radar sensor is damaged or has lost its settings, disconnect the ACC. This will avoid possible damage. If this occurs have it adjusted.

- **The sensor may become damaged or lose its settings when knocked, for example, during a parking manoeuvre. This may compromise the system's efficacy or disconnect it.**
- **Repairs to the radar sensor require specialist knowledge and special tools. SEAT recommends visiting a SEAT dealership for this purpose.**
- **A registration plate or plate holder on the front that is larger than the space for the registration plate, or a registration plate that is curved or warped can cause the radar to malfunction.**

Operating the Adaptive Cruise Control ACC



Fig. 211 On the left of the steering column: third lever for operating the Adaptive Cruise Control.

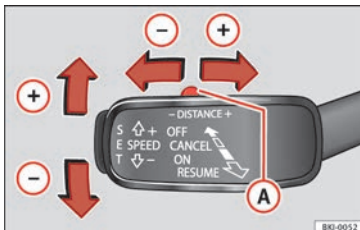



Fig. 212 On the left of the steering column: third lever for operating the Adaptive Cruise Control.

When the Adaptive Cruise Control (ACC) is connected, the green control lamp  will light up on the instrument panel, and the

programmed speed and ACC status will be displayed **» Fig. 209**.

What ACC settings are possible?

- Setting your speed **» page 218**.
- Setting your distance **» page 218**.
- Connecting and activating the ACC **» page 218**.
- Disconnecting and deactivating the ACC **» page 219**.
- Adjusting the default distance level at the start of your journey **» page 219**.
- Adjusting the driving profile **» page 219**.
- Conditions in which the ACC does not react **» page 219**.

Setting speed

To set your speed, move the third lever located in position **1** upwards or downwards until the desired speed is shown on the instrument panel display. The speed adjustment is made at 10 km/h (6 mph) intervals.

Once you are driving, if you wish to set the current speed as the vehicle's cruise speed and activate the ACC, press the **SET** button **» Fig. 212**. If you wish to increase or reduce speed by intervals of 1 km/h (0.6 mph), move the lever to position **2** **» Fig. 211** or press the **SET** button, respectively.

The set speed can be changed when the vehicle is stopped or during driving, as you like.

Any modification to the programmed speed will be shown on the bottom left part of the instrument panel display **» Fig. 209**.

Setting your distance level

To increase/reduce the distance level, press the rocker switch towards the left/right **» Fig. 212 (A)**.

The instrument panel display shows the modification of the distance level. There are 5 distance levels to choose from. SEAT recommends level 3. The set distance can be changed when the vehicle is stopped or during driving, as you like **» (A)**.

Connecting and activating the ACC

To connect and activate the ACC, the position of the gearbox selector lever, the vehicle speed and the position of the third level of the ACC must all be taken into account.

- With a manual gearbox, the gearbox selector lever must be in any gear except first, and speed must be greater than approximately 30 km/h. With an automatic gearbox, the gearbox selector lever must be in position **D** or **S**.
- To activate the ACC, with the third lever in position **1** press the **SET** button or move the third lever of the ACC to position **2** **» Fig. 211**. At this point, the image of the ACC on the instrument panel display will switch to *Active* mode **» Fig. 209**.

When the ACC function is active, the vehicle travels at a set speed and distance from the vehicle ahead. Both speed and distance can be changed at any time.

Disconnecting and deactivating the ACC

To disconnect the ACC move the lever to the 0 position » Fig. 211 (engaged). An **ACC deactivated** message appears and the function is totally deactivated.

If you do not wish to disconnect the ACC, just to switch it temporarily to inactive mode (Standby), move the third lever to position 3 » Fig. 211 or press the brake pedal.


It will also switch to inactive mode (Standby) if the vehicle is stopped and the driver door is opened.

Adjusting the default distance level at the start of your journey.

In wet road conditions, you should always set a larger distance with regard to the vehicle in front than when driving in dry conditions.

The following distances can be preselected:

- Very short
- Short
- Media
- Long
- Very long


In the Easy Connect system you can adjust the distance level that will be applied when the ACC is connected using the **CAR** button and the **SETTINGS** and **Driver assistance** function buttons »  page 33.

Changing the driving profile

In vehicles with SEAT Drive Profile, the driving profile selected can have an influence on the ACC's acceleration and braking behaviour » page 230.

In vehicles without SEAT Drive Profile, the behaviour of the ACC can also be affected by selecting any of the following drive profiles in the Easy Connect system:

- Normal
- Sport
- Eco
- Convenience

In this case, you should access the ACC settings using the **CAR** button and the **SETTINGS** > **Driver assistance** > **ACC** function buttons »  page 33.

The following conditions may lead the ACC not to react:

- If the accelerator is pressed.
- If there is no gear engaged.
- If the ESC is controlling.

- If the driver is not wearing his/her seat belt.
- If several brake lights of the vehicle or electrically connected trailer are damaged.
- If the vehicle is reversing.
- Driving faster than 210 km/h (150 mph).

Driver messages

ACC not available

The system can no longer continue to guarantee safe vehicle detection and will be deactivated. The sensor has lost its setting or is damaged. Take the vehicle to a specialised workshop and have the fault repaired.

ACC and Front Assist: currently not available. No sensor vision

This message will be displayed to the driver if the radar sensor's vision is impaired due, for example, to leaves, snow, heavy fog or dirt. Clean the SEAT badge » Fig. 210.

ACC: currently not available. Gradient too steep

The maximum road slope has been exceeded, hence safe ACC operation cannot be guaranteed. The ACC cannot be switched on.

ACC: only available in D, S or M

Select the D/S or M position on the selector lever. »

ACC: parking brake applied

The ACC is deactivated if the parking brake is applied. The ACC is available once again after the parking brake is released.

ACC: currently not available. Intervention of stability control

The message for the driver is displayed when the electronic stability control (ESC) intervenes. In this case, the ACC is automatically switched off.

ACC: Take action!

The message for the driver is displayed if, when the vehicle starts up on a hill with a mild slope, the vehicle rolls back even although the ACC is activated. Apply the brake to stop the vehicle from moving/colliding with another vehicle.

ACC: speed limit

The message for the driver is displayed if, in vehicles with manual gearbox, the current speed is too low for the ACC mode.

The speed to be stored must be at least 30 km/h (18 mph). The speed limiter switches off if the speed falls below 20 km/h (12 mph).

ACC: available as of the 2nd gear

The ACC is operational as of the 2nd gear (manual gearbox).

ACC: engine speed

The message for the driver is displayed if, when the ACC accelerates or brakes, the driver does not shift up or down a gear in time, which means exceeding or not reaching the permissible engine speed. The ACC switches itself off. A buzzer warning is heard.

ACC: clutch pressed

Vehicles with a manual gearbox: pressing the clutch pedal for longer abandons control mode.

Door open

Vehicles with automatic gearbox: the ACC cannot be activated with the vehicle stationary and the door open.

braking will have priority over intervention by the speed control or adaptive cruise control.

- Always be ready to use the brakes!
- Observe country-specific provisions governing obligatory minimum distances between vehicles.

Note

- The programmed speed is erased once the ignition or the ACC are switched off.
- When the traction control system (ASR) is deactivated during acceleration or else the ESC is activated in Sport* Mode (» page 120), the ACC switches off automatically.
- In vehicles with the Start-Stop system, the engine switches off automatically during the ACC stopping phase and restarts automatically to begin driving.

WARNING

There is a danger of rear collision when the minimum distance to the vehicle in front is exceeded and the speed difference between both vehicles is so great that a speed reduction by the ACC will not suffice. In this case the brake pedal should be applied immediately.

- The ACC may not be able to detect all situations properly.
- “Stepping” on the accelerator may cause the ACC not to intervene in braking. Driver

Function for preventing overtaking in an inside lane



Fig. 213 On the instrument panel display: ACC active, vehicle detected in an outer lane.

The adaptive cruise control (ACC) has a function that helps avoid overtaking while driving in inside lanes at certain speeds.

If another vehicle is detected travelling at a slower speed in an outer lane, it is displayed on the multifunction display » **Fig. 213**.

To avoid overtaking while driving in an inside lane the system will gently brake, and in accordance with the speed will prevent the car from overtaking. The driver can override this function at any time.

Deactivating the Adaptive Cruise Control ACC temporarily in certain situations

In the following situations the Adaptive Cruise Control (ACC) should be deactivated due to the system's limitations » **⚠**:

- When changing lanes, on tight bends and roundabouts, in acceleration and deceleration lanes on motorways or in sections with road works to prevent involuntary acceleration to reach the programmed speed.
- When going through a tunnel, as operation could be affected.
- On roads with several lanes, when other vehicles are driving more slowly in the overtaking lane. In this case, slower vehicles will be overtaken on the right.
- In case of heavy rain, snow or spray, as the vehicle in front might not be detected properly or, in certain circumstances, might not be detected at all.

⚠ WARNING

If the ACC does not switch off in the situations described, serious accidents and injuries may occur.

- **Always switch off the ACC in critical situations.**

i Note

If you do not switch off the ACC in the aforementioned situations, you may commit a legal offence.

Special driving situations

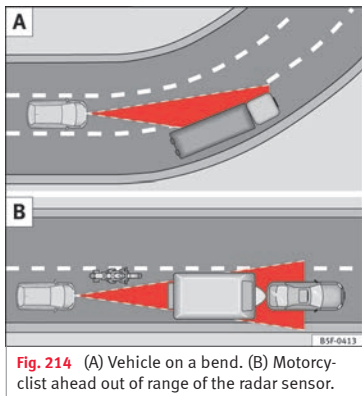


Fig. 214 (A) Vehicle on a bend. (B) Motorcyclist ahead out of range of the radar sensor.

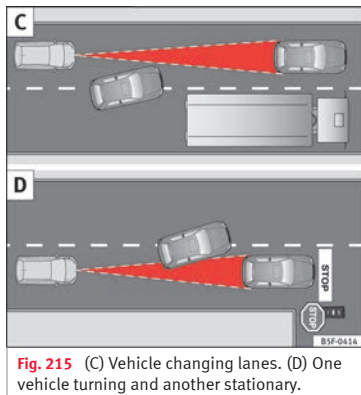


Fig. 215 (C) Vehicle changing lanes. (D) One vehicle turning and another stationary.

The adaptive cruise control (ACC) has certain physical limitations inherent in the system. For example, certain reactions of the ACC, in certain circumstances, may be unexpected or come late from the driver's point of view. So pay attention in order to intervene if necessary.

For example, the following traffic situations call for the utmost attention:

Starting driving after a stopping phase (only vehicles with automatic gearbox)

After a stopping phase, the ACC may begin driving automatically when the vehicle in front drives off **»** **△**.

When the ACC halts the vehicle (e.g. traffic jam), the instrument panel display shows the **ACC ready to start** message. If the vehicle ahead drives off again, the ACC will also do so automatically.

If the vehicle ahead does not drive off again, the vehicle can be kept indefinitely in the **ACC ready to start** status by operating the third lever repeatedly towards position **2** **»** **Fig. 211** or by pressing the brake pedal. If the **Press the brake** message is shown on the instrument panel, press the brake. If you do not, an acoustic warning will be heard and the ACC will switch to inactive mode (Standby). At this point, the vehicle may begin to move towards the stopped vehicle ahead **»** **△**.

Overtaking

When the turn signal lights up before the vehicle begins an overtaking manoeuvre, the ACC accelerates the vehicle automatically and thus reduces the distance from the vehicle in front.

When the vehicle enters the overtaking lane, if the ACC does not detect another vehicle in front, it accelerates until it reaches the programmed speed and maintains it.

System acceleration can be interrupted at any time by pressing the brake or moving the third lever backwards **»** **page 218**.

Driving through a bend

On entering or exiting bends, the radar sensor may no longer determine the vehicle in front or react to a vehicle in the adjacent lane »» Fig. 214 A. In these situations the vehicle may brake unnecessarily or fail to react to react to the vehicle in front. In this case, the driver has to intervene by accelerating or interrupting the braking process by applying the brake or pushing the third lever backwards »» page 218.

Driving in tunnels

When driving through tunnels the radar sensor may be limited. Switch off the ACC in tunnels.

Narrow or misaligned vehicles

The radar sensor can only detect narrow or misaligned vehicles when they are within range »» Fig. 214 B. This applies particularly to narrow vehicles such as motorbikes. In these cases, you should brake as necessary.

Vehicles with special loads and accessories

Special loads and accessories of other vehicles that jut out over the sides, backwards or over the top may be out of the ACC's range.

Switch off the ACC when driving behind vehicles with special loads and accessories or when overtaking them. In these cases, you should brake as necessary.

Other vehicles changing lanes

Vehicles changing lanes a short distance away from your own can only be detected when they are within range of the sensors. Consequently, the ACC will take longer to react »» Fig. 215 C. In these cases, you should brake as necessary.

Stationary vehicles

The ACC does not detect stationary objects while driving, such as traffic tails or damaged vehicles.

If a vehicle detected by the ACC turns or moves over and there is a stationary vehicle in front of it, the ACC will not react to it »» Fig. 215 D. In these cases, you should brake as necessary.

Vehicles driving in the opposite direction and vehicles crossing your path

The ACC does not react to vehicles approaching from the opposite direction or vehicles crossing your path.

Metal objects

Metal objects, e.g. rails on the road or sheets used in road works, can confuse the radar sensor and cause the ACC to react wrongly.

Factors that may affect how the radar sensor operates

If laser sensor operation is impaired, due to heavy rain, spray, snow or mud, the ACC is deactivated temporarily. The relevant text message will appear in the dash panel display. If necessary, clean the radar sensor.

When the radar sensor begins to operate properly again, the ACC will automatically be available again. The message on the instrument panel screen will switch off and the ACC will be reactivated again.

ACC operation may be affected by a strong radar reverse reflection, for example in a closed car park.

Trailer mode

When driving with trailer the ACC controls less dynamically.

Overheated brakes

If the brakes overheat, for example after abrupt braking or in long and steep slopes, the ACC may be deactivated temporarily. The relevant text message will appear in the dash panel display. In this case, adaptive cruise control cannot be activated.

Adaptive cruise control can be reactivated once brake temperature has cooled sufficiently. The message will disappear from the instrument panel display. If the message **ACC not available** remains on for quite a long »»

time it means that there is a fault. Contact a specialised workshop. SEAT recommends visiting a SEAT dealership.

⚠ WARNING

If you do not heed the Press the brake message, the vehicle may initiate an involuntary movement and could crash into the vehicle ahead. In any event, before driving off, check that the road is clear. The radar sensor may not detect obstacles on the road. This could cause an accident and serious injuries. If necessary, apply the brake.

Lane Assist system*

Introduction



Fig. 216 In the windscreen: field of vision of the Lane Assist system camera.

Using the camera located in the windscreen, the Lane Assist system detects the possible lines dividing the lanes. When the vehicle involuntarily approaches a dividing line it has detected, the system notifies the driver with a *corrective steering movement*. The purpose is not only to warn the driver, but also to keep the vehicle inside the lane. This movement can be over-regulated at any time.

No warning is produced with the turn signals activated, given that the Lane Assist system understands that a lane change is required.

Indications on the display and lamps

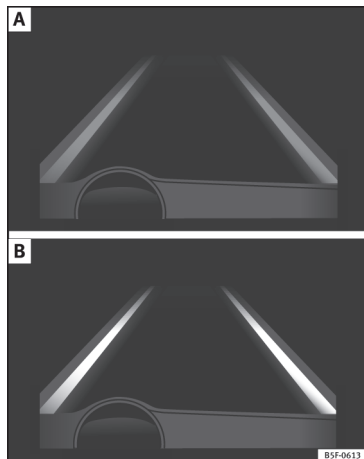


Fig. 217 On the instrument panel display: Indication on the Lane Assist system display (example 1).

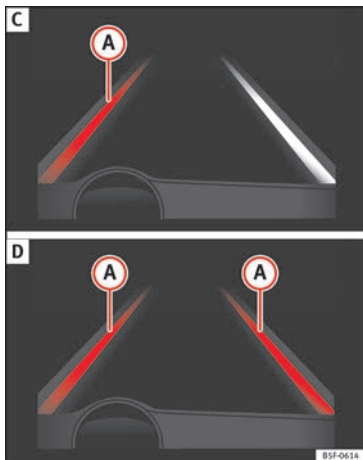


Fig. 218 On the instrument panel display: Indication on the Lane Assist system display (example 2).

Status display

- The system is active, but not available, either because the minimum speed has not been reached or because the lane lines are not recognised »» Fig. 217 A.
- The system is active and available, both lane lines are recognised. The steering angle is not being corrected at this moment »» Fig. 217 B.

- The system is operational, the highlighted line (A) indicates that there was a risk of involuntarily crossing the lane line and that the steering is being adjusted to correct the angle »» Fig. 218 C.
- The two highlighted lines (A) light up simultaneously when both lane lines are recognised and the Lane Assist function is active »» Fig. 218 D.

Control lamps



It lights up yellow: Lane Assist active but not available.

The system can not accurately recognise the lane. Please see page 226, the Lane Assist system is not available (the control lamp is lit up yellow).



It lights up green

Lane Assist system active and available.



WARNING

Observe the safety warnings »» ⚠ in Warning and control lamps on page 119.

Operating mode

Steering wheel vibration

The following situations can cause vibration in the steering wheel and require the driver to take active control of driving:

- When the steering angle assist value required to keep the vehicle in the lane is higher than the system's maximum operating value.
- If the system ceases to display the lane lines while assisting with steering.

Switching the Lane Assist system on or off

Through the Easy Connect system

- Press the Easy Connect button (CAR)
- Press the (SETTINGS) function button
- Press the function button (Driver assistance) to open the menu.

OR: Using the **Driving Assist** button on the turn signal lever* »» 📄 page 37.

Lane Assist with Lane Centring Guide

The **Lane Centring Guide** function is intended to keep the vehicle in the centre of the lane.

If the driver has a tendency to veer slightly off centre in the lane, the system adapts to driver preferences.

The **Lane Centring Guide** function is activated/deactivated in the Easy Connect system using the (CAR) button and the (SETTINGS) function button »» page 120.

Self-deactivation: the Lane Assist system can be automatically deactivated if there is a system malfunction. The control lamp disappears.

Hands-Off Function

- In the absence of steering wheel activity the system alerts the driver with acoustic signals and a text message on the dash panel asking to actively take over the steering.
- If the driver does not react to this, the system also alerts the driver with a little shaking motion through the brakes and, if the vehicle has it, activates the Emergency Assist function »» page 228.
- In vehicles without Emergency Assist, the adaptive lane guidance function will be disabled after the corresponding warnings to the driver.

The lane assist system is active but it is not available (the control lamp is lit up yellow)

- When driving at speeds below 65 km/h (38 mph).
- When the Lane Assist system does not detect the dividing lines of the road. For example, in the event warnings indicating road works, and snow, dirt, moisture or reflections.
- When the radius of a curve is too small.
- When no road markings can be seen.

- When the distance to the next marking to too great.
- When the system does not detect any clear and active steering movement during a long period of time.
- Temporarily, in the event of very dynamic driving styles.
- If a turn signal is activated.
- With the stability control system (ESC) in Sport mode or switched off.

Switching off the Lane Assist system in the following situations

Due to the limits of the Lane Assist system, switch it off in the following situations:

- When more attention is required of the driver
- When driving in a sporty style
- In unfavourable weather conditions
- On roads in poor condition
- In areas of road works

WARNING

The intelligent technology in the Lane Assist system cannot change the limits imposed by the laws of physics and by the very nature of the system. Careless or uncontrolled use of the Lane Assist system may cause accidents and injury. The system is not a replacement for driver awareness.

- Always adapt your speed and the distance to the vehicles ahead in line with visibility, weather conditions, the condition of the road and the traffic situation.
- Always keep your hands on the steering wheel so it can be turned at any time.
- The Lane Assist system does not detect all road markings. The road surfaces, road structures or objects in poor condition can be incorrectly detected as road markings under certain circumstances by the Lane Assist system. In such situations, switch the Lane Assist system off immediately.
- Please observe the indications on the instrument panel and act as is necessary.
- Always pay attention to the vehicle's surroundings.
- When the area of vision of the camera becomes dirty, covered or is damaged, the Lane Assist system function can be affected.

CAUTION

In order to avoid influencing the operation of the system, the following points must be taken into account:

- Regularly clean the area of vision of the camera and keep it in a clean state, without snow or ice.
- Do not cover the area of vision of the camera.
- Check that the area of vision of the wind-screen camera is not damaged.

Note

- The Lane Assist system deactivates when driving below 60 km/h (37 mph).
- The lane departure warning system has been exclusively developed for driving on paved roads only.
- If the Lane Assist system does not work as described in this chapter, do not use it and contact a specialised workshop.
- Before starting a journey, verify that the field of vision of the camera is not covered »» Fig. 216.
- Always keep the field of vision of the camera clean.
- If there is a fault in the system, have it checked by a specialised workshop.

Traffic Jam Assist**Related video**

Fig. 219 Safety

Description and operation

Traffic Jam Assist helps the driver keep the car within its lane and to move in convoy in case of traffic congestion or slow traffic.

Traffic Jam Assist is an additional function of Lane Assist »» page 224 and combines Lane Assist functions with Adaptive Cruise Control (ACC) »» page 214. Therefore, it is essential that you read these two chapters carefully and note the limitations of the systems and the information about them.




Operation of Traffic Jam Assist

At speeds of below 60 km/h (40 mph), Traffic Jam Assist can maintain a (temporary) distance preset by the driver with respect to the vehicle ahead and help stay within the lane »» ⚠.

To do this, the system automatically controls the accelerator, brakes and steering, and slows the vehicle, **stopping it fully if necessary**, when faced with a vehicle in front that has stopped. It automatically moves off again when the vehicle ahead moves.

Traffic Jam Assist is designed only for use on motorways and wide roads. Therefore, never use it in city traffic.

Technical requirements for using Traffic Jam Assist

- Lane departure warning must be activated:  button > **SETTINGS > Driver assistance > Lane departure warning (Lane Assist)** »»  page 33.
- The Lane Centring Guide must be activated:  button > **SETTINGS > Driver assistance > Lane departure warning (Lane Assist)**
- Adaptive Cruise Control (ACC) must be connected and active »» page 218.
- The speed must be below 60 km/h (38 mph).

Traffic Jam Assist is not active (the Lane Assist control light turns yellow)

- If any of the conditions mentioned on page 227, Technical requirements for using Traffic Jam Assist are no longer met.
- If any of the conditions required for operation of the Lane Assist are not met »» page 224.
- If any of the conditions necessary for the adaptive cruise control (ACC) to work are no longer fulfilled »» page 214.

Situations in which Traffic Jam Assist must be switched off

Due to the limitations of the system, Traffic Jam Assist must always be switched off in the following situations: »»

- When more attention is required by the driver.
- When driving in a very sporty style.
- In adverse weather conditions, e.g. in case of snow or heavy rain.
- When driving on roads in poor condition.
- In sections with roadworks.
- In city journeys.

WARNING

The smart technology incorporated into Traffic Jam Assist cannot defy the laws of physics; it only works within the limits of the system. Accidents and severe injury may occur if Traffic Jam Assist is used negligently or involuntarily. The system is not a replacement for driver awareness.

- Adapt your speed and safe distance to the vehicle in front of you at all times to suit the visibility, weather, road and traffic conditions.
- Do not use Traffic Jam Assist in city journeys.
- Do not use Traffic Jam Assist if there is poor visibility, for example, in case of snow, ice, rain or loose gravel, or on steep or slippery sections or flooded roads.
- Do not use Traffic Jam Assist offroad or on roads where the surface is not firm. Traffic Jam Assist has been designed for use on paved roads only.

- Traffic Jam Assist does not react to people or animals or vehicles crossing your path or that approach you head-on down the same lane.
- If Traffic Jam Assist does not reduce speed sufficiently, brake the vehicle immediately by applying the pedal.
- If the vehicle continues to move when you wish it to stop after a driver intervention prompt, brake the vehicle by applying the pedal.
- If driver intervention is requested on the dash panel display, immediately resume control of the vehicle.
- Keep your hands on the wheel at all times to be ready to intervene in the steering at any time. The driver is always responsible for keeping the vehicle in its own lane.
- Always be prepared to take charge of driving (accelerating or braking) yourself.

Note

- If Traffic Jam Assist does not work as described in this chapter, stop using it and contact a specialised workshop.
- If the system is faulty, take it to a specialised workshop and have it checked.

Emergency Assist


Description and operation

Emergency Assist detects whether there is inactivity by the driver and can automatically keep the car within the lane and stop it altogether if necessary. This way the system can actively help avoid an accident.

Emergency Assist is an additional function of Lane Assist » page 224 and combines Lane Assist functions with Adaptive Cruise Control (ACC) » page 214. Therefore, it is essential that you read these two chapters carefully and note the limitations of the systems and the information about them.

Operation of Emergency Assist

Emergency Assist detects when the driver ceases to perform any activity and repeatedly requests that he/she regain active control of the vehicle, through the use of optical and acoustic warnings and by applying the brakes.

If the driver continues to do nothing, the system automatically takes over the accelerator, brakes and steering in order to brake the vehicle and keep it in its lane » . When the Emergency Assist is actively adjusting, the hazard warning lights come on » page 145 and the vehicle makes slight zigzag movements in the lane in order to warn other drivers.

If the remaining braking distance is sufficient, if necessary the system slows down the vehicle **until it stops completely** and automatically switches on the electronic parking brake »» page 183.

Switching the Emergency Assist on and off

The Emergency Assist is switched on automatically when the Lane Assist is switched on »» page 224.

Technical requirements for using the Emergency Assist

- The adaptive cruise control (ACC) must be switched on »» page 214.
- The Lane Assist must be switched on »» page 224.
- The selector lever must be in the **D/S** position or in the Tiptronic selector gate.
- The system must have detected a lane separation line on both sides of the vehicle »» Fig. 218.

The following conditions may cause the Emergency Assist not to react or to switch off automatically:

- If the driver accelerates, brakes or moves the steering wheel.
- If any of the conditions mentioned in »» page 229, Technical requirements for using the Emergency Assist are not fulfilled.

- If any of the conditions required for operation of the Lane Assist are not met »» page 224.
- If any of the conditions necessary for the adaptive cruise control (ACC) to work are no longer fulfilled »» page 214.

WARNING

The smart technology incorporated into the Emergency Assist cannot overcome the limits imposed by the laws of physics; it only works within the limits of the system. The driver is responsible for driving the vehicle.

- Adapt your speed and safe distance to the vehicle in front of you at all times to suit the visibility, weather, road and traffic conditions.
- Keep your hands on the wheel at all times to be ready to intervene in the steering at any time.
- The Emergency Assist alone cannot always avoid accidents or serious injuries.
- If the operation of the Emergency Assist is impaired, for example if the radar sensor of the adaptive cruise control (ACC) or the Lane Assist camera are covered or have lost their settings, the system may intervene inopportunistically in braking or in steering.
- The Emergency Assist does not react to people or animal or vehicles crossing your path or which approach you head-on in the same lane.

WARNING

If the Emergency Assist intervenes inopportunistically, serious accidents and injuries may occur.

- If the Emergency Assist does not operate properly, switch off the Lane Assist »» page 224. Doing so will also switch off the Emergency Assist.
- Have the system checked by a specialised workshop. SEAT recommends visiting a SEAT dealership for this.

Note

- Automatic interventions by the Emergency Assist on the brakes may be interrupted by pressing the accelerator or brake or by moving the wheel.
- Hazard warning lights that come on automatically can be switched off by pressing the accelerator or the brake, moving the steering wheel or pressing the hazard warning light switch.
- If this occurs, the Emergency Assist may decelerate the vehicle until it comes to a complete stop.
- When the Emergency Assist is activated, it is only available again after the ignition has been switched off and back on again.

SEAT Drive Profile*

Introduction

SEAT Drive Profile enables the driver to choose between four profiles or modes, **Normal**, **Sport**, **Eco** and **Individual**, that modify the behaviour of various vehicle functions, providing different driving experiences.

In the FR and X-PERIENCE models equipped with dynamic chassis control, the **Comfort** profile is also available.

In the Leon Cupra model the four profiles are **Comfort**, **Sport**, **Cupra** and **Individual**.

The **Individual** profile can be configured according to personal preferences. The other profiles are fixed.

Description

Depending on the equipment fitted in the vehicle, SEAT Drive Profile can operate on the following functions:

Engine

Depending on the profile selected, the engine responds more spontaneously or more in harmony with the movements of the accelerator. Additionally, when **Eco** mode is selected, the Start-stop function is automatically activated.

In vehicles with automatic transmission, the gear change points are modified to position them in lower or higher engine speed ranges. Additionally, the **Eco**¹⁾ mode activates the Inertia function, enabling consumption to be further reduced.

In manual gearbox vehicles, **Eco**¹⁾ mode causes the gear change recommendation indications that appear on the instrument panel to vary, facilitating more efficient driving.

Dynamic chassis control (DCC)

DCC continuously adapts the shock absorbers to the condition of the road and current driving conditions, according to the pre-set programme.

In the event of a fault in the DCC, the following message is displayed on the instrument screen **Fault: damping setting**.

Address

Power steering becomes more robust in **Sport** mode to enable a sportier driving style. In the Leon Cupra the power steering becomes more robust in **Cupra** mode.

Air conditioning

In vehicles with Climatronic, this can operate in **eco**¹⁾ mode, especially restricting fuel consumption.

Adaptive Cruise Control (ACC)²⁾

According to the active driving profile, the acceleration gradient of the adaptive cruise control varies.

Electronic self-locking differential²⁾

The self-locking differential adapts its behaviour depending on the driving profile chosen. Normal mode or Cupra mode can be selected to prioritise improved traction in sport driving.

¹⁾ In the Leon Cupra model, **Eco** mode is selected through the **Individual** profile.

²⁾ Applies to the Leon Cupra model.

Setting driving mode



Fig. 220 Centre console: MODE button.

You can select from **Normal**, **Sport**, **Eco** and **Individual**.

You can select the required mode either by repeatedly pressing the button **MODE** » Fig. 220, or on the touch screen, in the menu that opens when the above button is pressed.

An icon on the Easy Connect system display informs about the active mode.

The **MODE** button light remains lit up yellow when the active mode is different to **Normal**.

Driving profile	Characteristics
Normal	Offers a balanced driving experience, suitable for everyday use.

Driving profile	Characteristics
Sport	Provides a complete dynamic performance in the vehicle, enabling the user a more sporty driving style.
Eco	Places the vehicle in a particularly low state of consumption, facilitating a fuel-saving driving style that is respectful to the environment.
Individual	Enables some configurations to be modified by pressing the Profile settings button. The functions that can be adjusted depend on the equipment fitted in the vehicle.
Convenience ^{a)}	It permits more relaxed and comfortable driving, for example for long motorway journeys. Its main characteristic is the soft suspension setting (DCC).

^{a)} Only for FR and X-PERIENCE models equipped with dynamic chassis control.

⚠ WARNING

When operating SEAT Drive Profile, pay attention to all traffic: doing otherwise could cause an accident.

📄 Note

- When the vehicle is switched off it will always store the driving profile that was selected when the ignition key was removed. Nevertheless, when the engine is restarted, the

engine and the gear will not restart in the setting selected. For engine and gear to revert to the desired position, select the corresponding drive profile again or press the Easy Connect system button repeatedly.

- Your speed and driving style must always be adjusted to visibility, weather, and traffic conditions.
- The Eco profile is not recommended when towing a vehicle.

Setting driving mode

✓ Applies to the model: Leon Cupra



Fig. 221 Centre console: Cupra Drive Profile button.

You can select from **Convenience**, **Sport**, **Cupra** and **Individual**. »

Cupra Drive Profile button

You can select the required mode either by repeatedly pressing the button with the Cupra logotype » Fig. 221, or on the touch screen, in the menu that opens when the above button is pressed.

An icon on the Easy Connect system display informs about the active mode.

The light of the button with the Cupra logotype remains lit up only when the **Cupra** profile is active.

Driving profile	Characteristics
Convenience	It permits more relaxed and comfortable driving, for example for long motorway journeys. Its main characteristic is the soft suspension setting (DCC).
Sport	It represents the vehicle's default behaviour, suitable for dynamic driving.
Cupra	It gives the vehicle a decidedly sportier nature, and makes for maximum performance.
Individual	Enables some configurations to be modified by pressing the Profile settings button. The functions that can be adjusted depend on the equipment fitted in the vehicle.

WARNING

When operating SEAT Drive Profile, pay attention to all traffic: doing otherwise could cause an accident.

Note

- When the vehicle is switched off it will always store the driving profile that was selected when the ignition key was removed. Nevertheless, when the engine is restarted the engine and the gear will not restart in its sportier mode in order to save fuel. For engine and gear to revert to a sportier mode, select the corresponding driving profile again on the Easy Connect system screen.
- Your speed and driving style must always be adjusted to visibility, weather, and traffic conditions.

Kick-down

The kick-down feature allows maximum acceleration to be reached.

If the **eco*** » page 231 mode has been selected in SEAT Drive Profile*, and the accelerator is pressed beyond a hard point, the engine power is automatically controlled to give your vehicle maximum acceleration.

WARNING

Please note that if the road surface is slippery or wet, the kick-down feature could cause the driving wheels to spin, which could result in skidding.

Traffic sign detection system*¹⁾

Introduction

The traffic sign detection system records the standard traffic signs in front of the vehicle with a camera located on the base of the interior mirror and provides information about speed limits and overtaking prohibitions. Within its limitations, the system also displays additional signals, such as time-specific prohibitions, signs for vehicles towing trailers » page 246 or limitations that only apply in the event of rain. Even on journeys without signs, the system may display any applicable speed limits.

In Germany, on motorways and vehicle roads, besides speed limits and overtaking provisions the system also displays the end of prohibition signs. The valid speed limit at the time in other countries is always shown.

WARNING

The technology in the traffic sign detection system cannot change the limits imposed by the laws of physics and only works within the system's limits. Do not let the extra convenience afforded by the traffic sign detection system tempt you into taking any risks when driving. The system is not a replacement for driver awareness.

- Adapt your speed and driving style to suit visibility, weather, road and traffic conditions.
- Poor visibility, darkness, snow, rain and fog may lead to the system failing to display traffic signs or not displaying them correctly.
- If the camera's field of vision is dirty, covered or damaged, system operation may be impaired.

WARNING

The driving recommendations and traffic indications shown on the traffic sign detection system may differ from the actual current traffic situation.

- The system may not detect or correctly show all the traffic signs.
- Traffic signs and traffic regulations have priority over the recommendations and displays provided by the system.

Note

In order not to compromise the system's operation, please take the following points into account:

- Regularly clean the area of vision of the camera and keep it in a clean state, without snow or ice.

- Do not cover the field of vision of the camera.
- Always replace damaged or worn blades when required to avoid lines on the camera's field of vision.
- Check that the windscreen is not damaged in the area of the camera's field of vision.

Note

- The use of outdated maps on the navigation system may cause the system to show traffic signs incorrectly.
- In the waypoints mode of the navigation system, the traffic sign detection system is only partly available.

¹⁾ System available depending on the country.

Indication on display

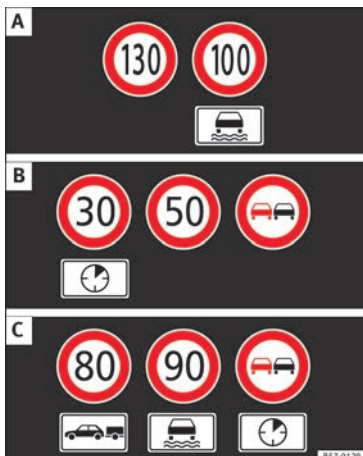



Fig. 222 On the instrument panel display: examples of speed limits or overtaking prohibitions with their respective additional signs.

The traffic signs detected by the system are displayed on the dash panel display » **Fig. 222** and, depending on the navigation system fitted in the vehicle, on the infotainment system as well »  **page 33**.

Traffic sign detection system messages	Cause and solution
There are no traffic signs available	The system is booting up. OR ELSE: the camera has not recognised any obligation or prohibition signs.
Error: Detection of traffic signs	There is a fault in the system. Have the system checked by a specialised workshop.
Speed warning currently unavailable.	The speed warning function of the traffic sign detection system is faulty. Have the system checked by a specialised workshop.
Detection of traffic signs: Clean the windscreen!	The windscreen is dirty in the camera area. Clean the windscreen.
Detection of traffic signs: Limited at the moment	The navigation system is not transmitting any data. Check that the navigation system's maps are up-to-date. OR ELSE: the vehicle is currently in a region that is not included in the navigation system's map.
No data available	The traffic sign detection system does not work in the current country.

WARNING

If messages are ignored, the vehicle may stall in traffic and cause accidents and severe injuries.

- Never ignore the messages displayed.
- Stop the vehicle at the next opportunity and in a safe place.



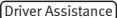
Note

Failure to heed the control lamps and corresponding text messages when they light up may result in damage to the vehicle.

Operation

The traffic sign detection system does not work in all countries. Keep this in mind when travelling abroad.

Activating and deactivating traffic sign display on the instrument panel

The permanent display of traffic signs on the instrument panel can be activated or deactivated in the infotainment system using the  button and the  and  function buttons.

Display of traffic signs

When the traffic sign detection system is connected, a camera located on the base of the interior rear-view mirror records the traffic

signs in front of the vehicle. After checking and evaluating the information from the camera, the navigation system and the current vehicle data, up to three valid traffic signs are displayed »» Fig. 222 B in conjunction with their corresponding additional signs.

First: The sign that is currently valid for the driver is shown in the left side of the screen For example, a maximum speed limit of **130 km/h (100 mph)**

»» Fig. 222 A.

Second: A sign valid only in certain circumstances, e.g. **100 km/h (60 mph)** is shown second, together with the additional rain sign.

Additional sign: If the windscreen wiper is working while you are driving, the signal with the additional rain sign will be shown first, on the left, as it is the one that is applicable at the time.


Third: A sign valid only with restrictions, e.g. No overtaking at certain times, will be displayed third »» Fig. 222 C.

Speed warning

If the system detects that the permitted speed is exceeded, it may warn the driver with a “gong” and visually with a message on the dash panel display.

The speed warning can be adjusted or deactivated completely in the infotainment system using the **CAR** button and the **SETTINGS** and

Driver Assistance function buttons

»»  page 33. The speed is adjusted in steps of 5 km/h (3 mph) within a range of between 0 km/h (mph) and 20 km/h (12 mph) above the maximum speed permitted.

Trailer mode

In vehicles equipped with a towing bracket device from the factory and a trailer that is electrically connected to the vehicle, it is possible to activate or deactivate the display of specific traffic signs for vehicles with trailer, such as speed limits or overtaking prohibitions. Activation or deactivation is performed on the infotainment system using the

CAR button and the **SETTINGS** and

Driver Assistance function buttons

»»  page 33.

For trailer mode, the display of speed limits applicable to the type of trailer or to the legal provisions can be adjusted. The speed is adjusted in steps of 10 km/h (5 mph) within a range of between 60 km/h (40 mph) and 130 km/h (80 mph). If it is adjusted to a speed greater than that which is permitted in the country in question for driving with a trailer, the system automatically displays the usual speed limits, e.g. in Germany 80 km/h (50 mph).

If the speed warning for the trailer is deactivated, the system displays the speed limits as if there were no trailer hitched.

Limited operation

The traffic sign detection system has certain limitations. The following cases may lead the system to operate with limitations or not at all:

- In the case of poor visibility, e.g. in snow, rain, fog or intense mist.
- In cases of dazzling, e.g. caused by head-on traffic or by the sun.
- When driving at high speeds.
- If the camera is covered or dirty.
- If the traffic signs are out of the camera's field of vision.
- If the traffic signs are partially or totally covered, e.g. by trees, snow, dirt or other vehicles.
- In the case of traffic signs that do not fulfil the regulations.
- In the case of damaged or bent traffic signs.
- In the case of variable messages on overhead or gantry signs (LED-based variable traffic signs or other lighting units).
- If the maps on the navigation system are not up-to-date.
- In the case of adhesives affixed to vehicles that depict traffic signs, e.g. speed limits on lorries.

Fatigue detection (break recommendation)*

Introduction

The Fatigue detection informs the driver when their driving behaviour shows signs of fatigue.

WARNING

Do not let the comfort afforded by the Fatigue detection system tempt you into taking any risks when driving. Take regular breaks, sufficient in length when making long journeys.

- The driver always assumes the responsibility of driving to their full capacity.
- Never drive if you are tired.
- The system does not detect the tiredness of the driver in all circumstances. Consult the information in the section » page 236, System limitations.
- In some situations, the system may incorrectly interpret an intended driving manoeuvre as driver tiredness.
- No warning is given in the event of the effect called microsleep!
- Please observe the indications on the instrument panel and act as is necessary.

Note

- Fatigue detection has been developed for driving on motorways and well paved roads only.
- If there is a fault in the system, have it checked by a specialised workshop.

Function and operation



Fig. 223 On the instrument panel display: fatigue detection symbol.

Fatigue detection determines the driving behaviour of the driver when starting a journey, making a calculation of tiredness. This is constantly compared with the current driving behaviour. If the system detects that the driver is tired, an audible warning is given with a sound and an optic warning is shown with a symbol and complementary message on the instrument panel display » **Fig. 223**. The message on the instrument panel display is

shown for approximately 5 seconds, and depending on the case, is repeated. The system stores the last message displayed.

The message on the instrument panel display can be switched off by pressing the **OK/RESET** button on the windscreen wiper lever or the button **OK** on the multi function steering wheel » **page 36**.

The message can be recalled to the instrument panel display using the multifunction display » **page 36**.

Conditions of operation

Driving behaviour is only calculated on speeds above about 65 km/h (40 mph) up to around 200 km/h (125 mph).

Switching on and off

Fatigue detection can be activated or deactivated in the Easy Connect system with the **CAR** button and the **SETTINGS** function button » **page 33**. A mark indicates that the adjustment has been activated.

System limitations

The Fatigue detection has certain limitations inherent to the system. The following conditions can limit the Fatigue detection or prevent it from functioning.

- At speeds below 65 km/h (40 mph)
- At speeds above 200 km/h (125 mph)

- When cornering
- On roads in poor condition
- In unfavourable weather conditions
- When a sporty driving style is employed
- In the event of a serious distraction to the driver

Fatigue detection will be restored when the vehicle is stopped for more than 15 minutes, when the ignition is switched off or when the driver has unbuckled their seat belt and opened the door.

In the event of slow driving during a long period of time (below 65 km/h, 40 mph) the system automatically re-establishes the tiredness calculation. When driving at a faster speed the driving behaviour will be recalculated.

Parking aid

Related video



Fig. 224 Safety

General information

Assorted assistance systems – which vary depending on the equipment fitted in the car – will help you when parking or manoeuvring.

The **rear parking aid** is an audible assistant that warns about obstacles located *behind* the vehicle » page 238.

During parking, **Parking System Plus** assists the driver by visually and audibly warning them about obstacles detected *in front* and *behind* the vehicle » page 239.

⚠ WARNING

- Always pay attention, also when looking straight ahead, to traffic and the vehicle surroundings. The assistance systems are not a replacement for driver awareness. When inserting or removing the vehicle from a parking space, or when performing similar manoeuvres the driver always assumes the responsibility.
- Adapt your speed and driving style at all times to suit visibility, weather, road and traffic conditions.
- The ultrasound sensors have blind spots in which obstacles and people are not registered. Pay special attention to children and animals.
- Always keep visual control of the vehicle surroundings: use the mirrors for additional help.

ⓘ CAUTION

Parking Aid functions may be negatively affected by different factors that may lead to damage to the vehicle or its immediate surroundings:

- Under certain circumstances, the system does not detect or display certain objects:
 - Objects such as chains, trailer draw bars, fences, posts and thin trees.
 - Objects that are located above the sensors, such as protrusions in a wall.
 - Objects with certain surfaces or structures, such as wire mesh fences or powder snow.
- Certain surfaces of objects and garments do not reflect the ultrasound sensors' signals. The system cannot detect, at least correctly, these objects or people wearing such clothes.
- Ultrasound sensor signals may be affected by external sound sources. In certain circumstances this may prevent them from detecting people or objects.
- Please note that low obstacles detected by the system may no longer be registered by the sensors as the car moves closer, so the system will not give any further warning. In certain circumstances, objects such as high kerbs that could damage the bottom of the vehicle are not detected either.
- If the first warning from the ParkPilot is ignored, the vehicle could suffer considerable damage.

- The knocks or damage on the radiator grille, bumper, wheel arch and vehicle underbody can adjust the orientation of the sensors. This can affect the parking aid function. Have the function checked by a specialised workshop.

Note

- In certain situations, the system can give a warning even though there is no obstacle in the detected area, e.g:
 - with rough or cobbled floors or ground with long grass;
 - with external ultrasound sources, such as cleaning vehicles or other vehicles;
 - In downpours, intense snow or dense exhaust gases;
 - if the registration plate (front or rear) is not properly affixed to the bumper surface;
 - or in locations such as the brow of a hill.
- In order to guarantee good system operation, keep the ultrasound sensors clean, free of snow or ice, and do not cover them with adhesives or other objects.
 - If you use high-pressure or vapour equipment to clean the ultrasound sensors, apply it directly only very briefly and always from a distance of more than 10 cm.
 - Retrofitting of accessories to the vehicle, such as a bicycle rack, may interfere with the operation of the Parking Aid.

- In order to familiarise yourself with the system, it is advised that you practice parking in an area or car park that is free from traffic. There must be good weather and light conditions.
 - The volume and tone of the warnings can be modified, in addition to the indications »» page 241.
 - In vehicles *without* a driver information system, these parameters can be modified in a SEAT Official Service or in a specialised workshop.
 - Please observe information on towing a trailer »» page 242.
 - The display on the Easy Connect screen shows a slight time delay.

Rear parking aid*

The rear Parking Aid assists the driver in parking by means of audible warning sounds.



Description

There are sensors integrated in the rear bumper. When the sensors detect an obstacle, you are alerted by audible warnings.

Make particularly sure that the sensors are not covered by adhesives, residues and the like, as this could affect the system's operation. Cleaning instructions »» page 259.

The approximate measurement range of the rear sensors is:

side area	0.60 m
central area	1.60 m

As you approach the obstacle, the time interval between the audible warnings will be reduced. When you reach around 0.30 m the warning will be constant: Do not continue to move forward (or backward) »»  in General information on page 237, »»  in General information on page 237 !

If you maintain separation from the obstacle, the volume of the warning begins to reduce after four seconds (does not affect the tone of the constant warning).

Activating/Deactivating

When engaging reverse gear, the parking aid is automatically switched on. This is confirmed with a short warning.

On disengaging reverse gear, the Parking Aid system is disconnected immediately.

Parking aid plus*

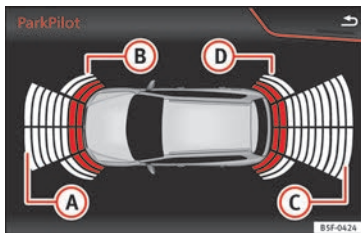


Fig. 225 Represented area.

Parking system plus assists you audibly and visually when parking.

There are sensors integrated in the front and rear bumpers. When they detect an obstacle, you are alerted by audible warnings and visually on the Easy Connect system.

In the event of danger of a frontal collision, the audible warnings come from the front of the vehicle, and in the event of the danger of a rear-end collision they come from the rear.

Make particularly sure that the sensors are not covered by adhesives, residues and the

like, as this could affect the system's operation. Cleaning instructions »» page 259.

The approximate measurement range of the sensors is:

- Ⓐ 1.20 m
- Ⓑ 0.60 m
- Ⓒ 1.60 m
- Ⓓ 0.60 m

As you approach the obstacle, the time interval between the audible warnings will be reduced. When you reach around 0.30 m the warning will be constant: do not continue to move forward (or backward)!

If you maintain separation from the obstacle, the volume of the warning begins to reduce after four seconds (does not affect the tone of the constant warning).

Parking Aid operation



Fig. 226 Centre console: parking aid button.

Manual connection of Parking Aid

- Press the **P** button *once*.

Manual disconnection of Parking Aid

- Press the **P** button *again*.

Manual disconnection of Parking Aid display (the audible sounds remain active)

- Press a button on the main menu of the factory-assembled infotainment system.
- **OR:** press the **BACK** function button. »»

Automatic connection of Parking Aid

- Engage reverse gear or turn the selector lever to position **R**.
- OR:** depending on the equipment, if the vehicle rolls back¹⁾.
- OR:** If the vehicle approaches an obstacle that is in its forwards path at a speed below 10 km/h (6 mph) »» page 240, **Automatic activation**. The obstacle is detected as of a distance of approx. 95 cm if the automatic connection is activated in the infotainment system. A reduced display is shown.

Automatic disconnection of Parking Aid

- Move the selector lever to position **P**.
- OR:** accelerate to more than approx. 10 km/h (6 mph) forward.

Temporary suppression of sound in Parking Aid

- Press the  function button.

Change from reduced view to full view

- Engage reverse gear or turn the selector lever to position **R**.

- OR:** depending on the equipment, if the vehicle rolls back¹⁾.
- OR:** press the car icon in reduced view.

If necessary, switch to the rear-assist image (Rear View Camera “RVC”)

- Engage reverse gear or turn the selector lever to position **R**.
- OR:** Press the RVC function button.

A short confirmation signal will be heard and the button symbol will light up yellow when the system is switched on.

Automatic activation



Fig. 227 Miniature indication of automatic activation.


When the Parking System Plus is switched on automatically, a miniature of the vehicle will be displayed and the segments will be shown on the left side of the screen »» **Fig. 227**.

Automatic activation occurs when slowly approaching an obstacle located in front of the vehicle. It only operates every time the speed is reduced below approximately 10 km/h (6 mph) for the first time.

¹⁾ With certain equipment, the system will be activated automatically when the vehicle reverses for a certain distance (about 10 cm if an obstacle is detected in the rear area and about 20 cm if no obstacle is detected in the rear area).

If the parking aid is switched off using the **P** button, the following actions must be carried out in order for it to automatically switch on:

- Switch off the ignition and switch it on again.
- **OR:** accelerate above 10 km/h (6 mph) before reducing speed below this number again.
- **OR:** place the selector lever in position **P** and then move it from this position.
- **OR:** switch on and off the automatic activation in the Easy Connect system menu.

The automatic activation with parking aid miniature indication can be switched on and off from the Easy Connect system menu
 »  page 33:

- Switch the ignition on.
- Select: **CAR** button and function button **SETTINGS > Parking and manoeuvring**.
- Select the **Automatic activation** option. When the function button check box is activated , the function is on.

If the system has been activated automatically, an audible sound warning will only be given when obstacles in front are at a distance of less than 50 cm.

⚠ CAUTION

The automatic connection of the Parking Aid only works when you are driving slowly. If driving style is not adapted to the circumstances, an accident and serious injury or damage may be caused.

Segments of the visual indication

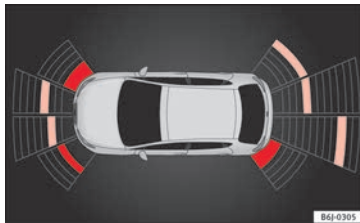


Fig. 228 Parking Aid display on the Easy Connect system screen.

The distance of separation from the obstacle can be estimated using the segments around the vehicle.

The optical indication of the segments works as follows:



White segments: a white segment is displayed when the obstacle is not within the vehicle's trajectory or the direction of travel is in the opposite direction to its location.

Yellow segments: obstacles located in the vehicle's trajectory and which are more than 30 cm away from the vehicle are displayed in yellow.

Red segments: obstacles that are less than 30 cm away from the vehicle are displayed in red.

Moreover, with the SEAT Media System Plus/Nav System radios, a yellow trail indicates the vehicle's expected journey based on the steering wheel angle.

Whenever the obstacle is located in the vehicle's direction of travel, the corresponding audible warning will sound.

As the vehicle approaches an obstacle, the segments are displayed closer to the vehicle. When the penultimate segment is displayed, this means that the vehicle has reached the collision zone. In the collision zone, the obstacles are represented in red, including those out of the path. Do not continue to move forward (or backward) »  **in General information on page 237**, »  **in General information on page 237 !**

Adjusting the display and audible warnings

The settings for the display and audible warnings are controlled via the Easy Connect*.

Automatic activation

on – activates the **Automatic activation** option » page 240.

off – deactivates the **Automatic activation** option » page 240.

Front volume*

Volume in the front and rear area.

Front sound settings/sharpness*

Frequency (tone) of the sound in the front area.

Rear volume*

Volume in the rear area.

Rear sound settings/sharpness*

Frequency (tone) of the sound in the rear area.

Adjust volume

With the parking aid switched on, the active audio/video source volume will be reduced to the intensity of the selected setting.

Error messages


When the Parking Aid is activated or when it is switched on, if a message reporting a Park-

ing aid error is displayed on the instrument panel, there is a fault in the system.

If the fault doesn't disappear before disconnecting the ignition, next time that parking aid is engaged in reverse, it will not be indicated.

Parking System Plus*

If there is a fault in the parking aid system a message will appear on the instrument panel indicating the error. In addition the **P** key LED will blink.

If there is a fault in a sensor, the symbol  is displayed on the Easy Connect display in front of/behind the vehicle. If a rear sensor is faulty, only the obstacles in the areas **(A)** and **(B)** are displayed » **Fig. 225**. If a front sensor is faulty, only the obstacles in the areas **(C)** and **(D)** are displayed.

Have the fault corrected by a specialised workshop without delay.

Towing bracket

In vehicles equipped with a towing bracket device from the factory, when the trailer is connected electrically, the Parking Aid rear sensors will not be activated when reverse gear is engaged, when the selector lever is turned to position **R** or when the button **P** is pressed.

Parking System Plus

The distance to possible obstacles at the rear of the vehicle will not be displayed on the screen and nor will it be indicated by means of audible sound signals.

The Easy Connect system screen will only display objects detected at the front, and the vehicle's trajectory will be hidden.

Braking while manoeuvring function*

✓ Only valid with Parking System Plus

As soon as an obstacle is detected while reversing, the braking while manoeuvring function activates the emergency braking. Depending on the equipment, the braking while manoeuvring function can also activate emergency braking while moving forwards.

The emergency braking function is used to minimise collisions. Vehicle speed must not be higher than 10 km/h.

The braked manoeuvre function is active or inactive when the parking light is lit or off, respectively. If an emergency braking is activated, the function will remain inactive until the gear is changed.

The Parking System's limitations apply.

The braking while manoeuvring function is controlled in the Easy Connect system with

the **CAR** button and the **SETTINGS** and **Park and manoeuvre** function buttons.

- **on** – permits the use of the braking while manoeuvring function.
- **off** – does not permit the use of the braking while manoeuvring function.

Temporary suppression of emergency braking

- When the function is deactivated with the **Braking while manoeuvring** button that appears on the **Parking System** screen of the Easy Connect system.
- Whenever any of the car doors, rear lid or bonnet are opened.

Rear Assist “Rear View Camera”*

Related video



B5F-0841

Fig. 229 Safety

Operating and safety warnings

⚠ WARNING

- The Rear Assist does not make it possible to precisely calculate the distance from obstacles (people, vehicles, etc.) and nor can it overcome the system's own limits, hence using it may cause serious accidents and injuries if used negligently or without due care. The driver should be aware of his/her surroundings at all times to ensure safe driving.
- The camera lens expands and distorts the field of vision and displays the objects on the screen in a different, vague manner. The perception of distances is also distorted by this effect.
- Due to the screen resolution or insufficient light conditions, some items may be displayed in an unsatisfactory manner or not at all. Take special care with thin posts, fences, railings or trees that might not be displayed on screen and could damage the vehicle.
- The rear assist has blind spots where it is not possible to represent people or objects (small children, animals and certain objects cannot be detected in its field of vision). Monitor the vehicle's surrounding area at all times.
- Keep the camera lens clean, free of ice and snow, and do not cover it.
- The system is not a replacement for driver awareness. Supervise the parking operation at all times, as well as the vehicle's surrounding area. Adapt your speed and driving style

at all times to suit visibility, weather, road and traffic conditions.

- Do not be distracted from the traffic by looking at the screen.
- The images on the rear assist screen are only two-dimensional. Due to a lack of spatial depth, protruding parts or holes in the road, for example, are more difficult to detect or may not be seen at all.
- Vehicle load modifies the representation of the orientation lines displayed. The width represented by the lines diminishes with vehicle load. Pay special attention to the vehicle's surroundings when the inside of the vehicle's luggage compartment is carrying a heavy load.
- In the following situations, the objects or other vehicles shown in the navigation system display appear to be further away or closer than they really are: Pay special attention:
 - On moving from a horizontal plane to a slope.
 - On moving from a slope to a horizontal plane.
 - If the vehicle is heavily loaded at the rear.
 - When the vehicle approaches objects that are not on the ground surface or are jutting out from it. These objects may also be outside the camera's angle of vision when reversing.

Note

- It is important to take great care and pay special attention if you are not yet familiar with the system.
- Rear assist will not be available if the vehicle's rear lid is open.

Instructions for use

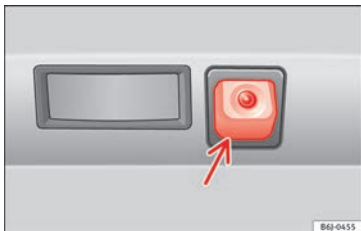



Fig. 230 On the rear bumper: location of the rear assist camera.

A camera on the rear bumper aids the driver during reverse parking or manoeuvring » **Fig. 230**. The camera image is viewed together with orientation lines projected by the system on the Easy Connect system screen. The bottom of the screen displays part of the bumper corresponding to the number plate area that will be used as reference by the driver.

Rear assist settings

Rear assist offers the user the possibility to change the image's *brightness, contrast* and *colour* settings.

To change these settings:

- Park the vehicle in a safe place.
- Apply the parking brake.
- Switch the ignition on.
- If necessary, switch on the Easy Connect system.
- Engage reverse gear or turn the selector lever to position **R**.
- Press the  function button displayed on the right of the image.
- Make the desired adjustments on the menu by pressing the $-/+$ function buttons or by moving the corresponding scroll button.

Necessary conditions for parking and manoeuvring with the rear assist

The system should not be used in the following cases:

- If the image displayed is not very reliable or is distorted, for example low visibility or dirty lens.
- If the area behind the vehicle is not displayed very clearly or is incomplete.
- If the vehicle is heavily loaded at the rear.

- If the position and installation angle of the camera have been changed, e.g. after a rear-end collision. Have the system checked by a specialised workshop.

Familiarising yourself with the system

To familiarise yourself with the system, the orientation lines and their function, SEAT recommends practising parking and manoeuvring with the rear assist in a place without too much traffic or in a car park when there are good weather and visibility conditions.

Cleaning the camera lens

Keep the camera lens clean and clear of snow and ice:

- Moisten the lens using a normal alcohol-based glass cleaning product and clean the lens with a dry cloth.
- Remove snow using a small brush.
- Use de-icing spray to remove any ice.

ⓘ CAUTION

- **Never use abrasive cleaning products to clean the camera lens.**
- **Do not use hot or warm water to remove ice or snow from the camera lens. Doing so could damage the camera.**

Parking and manoeuvring with the rear assist

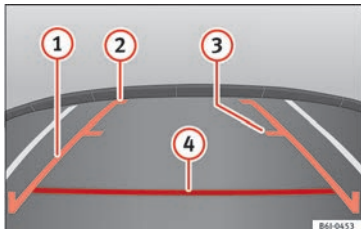


Fig. 231 Display on the Easy Connect system screen: orientation lines.

Switching the system on and off

- The rear assist will switch on when the ignition is on or the engine running, on engaging reverse gear (manual gearbox) or on changing the selector lever to the **R** position (automatic gearbox).
- The system switches off 8 seconds after disengaging reverse gear (manual gearbox) or removing the selector lever from the **R** position (automatic gearbox). The system will also disconnect immediately after the ignition is switched off.

- The camera will stop transmitting images above the speed of 15 km/h (9 mph) with reverse engaged.

In combination with the Parking System Plus » page 237, the camera image will cease to be transmitted immediately when reverse gear is disengaged or when the selector lever is moved from the **R** position, and the optical information provided by the Parking Aid system will be displayed.

Also in combination with the system, the rear assist image can also be concealed:

- By pressing one of the Infotainment system buttons on the display.
- **OR:** By pressing the miniature vehicle that appears on the left of the screen (which switches to the full-screen mode of the Parking System Plus's optical system).

If you wish to display the rear assist image again:

- Disengage reverse, or change the selector lever's position, engage reverse again or move the selector lever to position **R**.
- **OR:** Press the **RVC** function button¹⁾

Meaning of the orientation lines

» Fig. 231

- 1 **Side lines:** extension of the vehicle (the approximate width of the vehicle plus the rear view mirrors) on the road surface.
- 2 **End of the side lines:** the area marked in green ends approximately 2 m behind the vehicle on the road surface.
- 3 **Intermediate line:** indicates a distance of approximately 1 m behind the vehicle on the road surface.
- 4 **Red horizontal line:** indicates a safe distance of approximately 40 cm at the rear of the vehicle on the road surface.

Parking manoeuvre

- Place the vehicle in front of the parking space and engage reverse gear (manual gearbox) or move the selector to the **R** position (automatic gearbox).
- Reverse slowly, and turn the steering wheel so that the side orientation lines lead towards the parking space.
- Guide the vehicle into the parking space so that the side orientation lines run parallel to it.

¹⁾ **WARNING:** the **RVC** function button will only be activated and available when the reverse gear is engaged or the selector lever is set to position **R**.

Towing bracket device

Towing bracket device*

Introduction

The towing bracket device fitted to your vehicle, be it factory-fitted or a genuine SEAT accessory, meets all the national technical and legal requirements for towing.

Your vehicle is fitted with a 13-pin connector for the electrical connection between the trailer and the vehicle. If the trailer is equipped with a **7-pin connector** you can use the corresponding adaptor, which is available as a genuine SEAT accessory.

The maximum authorised towing load is **80 kg**.

⚠ WARNING

- Before each journey, make sure that the detachable ball joint is properly fitted and secured in its housing.
- If the detachable ball joint is not properly fitted and secured, do not use it.
- Do not use the towing bracket device for towing if it is damaged or has missing parts.
- Do not modify or adapt the towing device connection.
- Never unhook the detachable ball joint when the trailer is hitched.

⚠ CAUTION

Handle the detachable ball joint with care in order to avoid damaging the bumper paintwork.

i Note

Towing the vehicle with the detachable ball joint » page 100.

Description

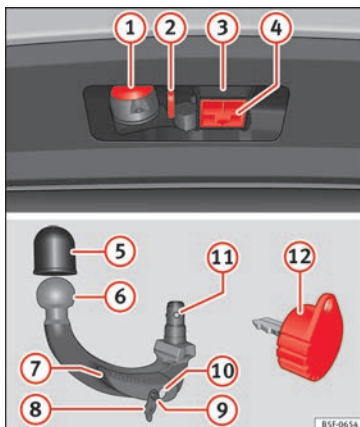


Fig. 232 Towing bracket device support / detachable ball joint / key.

Depending on the country or version, the towing bracket device's detachable ball joint is located:

- underneath the floor panel of the luggage compartment.
- **or else** on the surface of the floor panel of the luggage compartment in a bag secured to the fastening rings.

The ball joint is fitted and removed by hand.

The towing device bracket is supplied with a key.

Key to » Fig. 232

- 1 13-pin connector
- 2 Safety lug
- 3 Hook housing
- 4 Hook housing cap
- 5 Ball protective cover
- 6 Detachable ball
- 7 Locking lever
- 8 Lock cover
- 9 Release bolt
- 10 Lock
- 11 Locking balls
- 12 Key

Note

Contact an Authorised Service Partner if you lose your key.

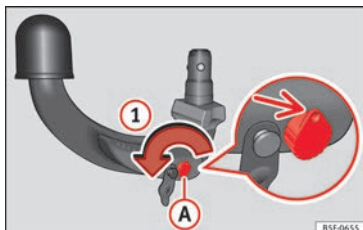
Placing in standby position

Fig. 233 Step 1.

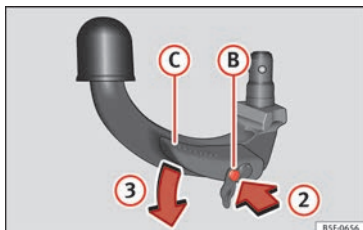


Fig. 234 Step 2.

Before assembling it, place the detachable ball in the standby position with the following two steps.

Step 1.

- Turn the key in the direction of arrow (1) until the part of the key with the holes reaches the top position »» Fig. 233 (arrow).

Step 2.

- Grip the detachable ball below the protective cover.
- Press the release bolt (B) in the direction of arrow (2), and at the same time press lever (C) in the direction of arrow (3) as far as it will go »» Fig. 234.

The lever will remain blocked in this position.

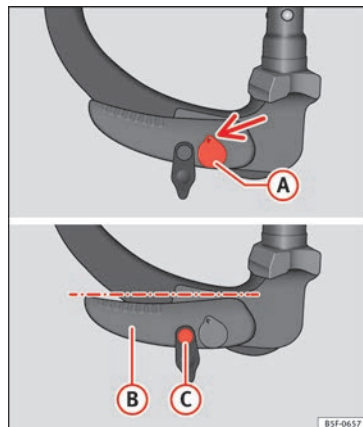
Standby position

Fig. 235 Standby position: Position of the lever and the release bolt.

Standby position adjusted properly

- Key (A) »» Fig. 235 is in the released position (the part of the key with the holes is facing upwards).
- Lever (B) »» Fig. 235 is in the bottom position.
- The release bolt (C) »» Fig. 235 can be moved.

»

Thus adjusted, the detachable ball is ready for installation.

① CAUTION

The key cannot be removed or turned in the standby position.

Assembling the detachable ball - Step 1

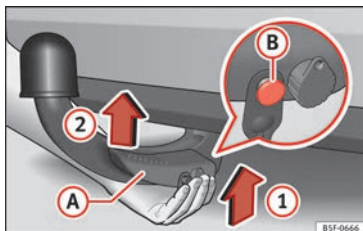


Fig. 236 Fitting the detachable ball / Release bolt in the deployed position.

Fitting the detachable ball

- Remove the hook housing cap **④** **»» Fig. 232** downwards.
- Set the detachable ball to its standby position **»» page 247**.
- Grip the detachable ball **from below** **»» Fig. 236** and insert it into the hook hous-

ing following the direction of arrow **①** until it engages audibly **»» ⚠**.

Lever **A** turns **automatically** in the direction of arrow **②** upwards, and the release bolt **B** moves outwards (the red and green part will be visible) **»» ⚠**.

If lever **A** does not turn automatically or the release bolt **B** does not come out, the detachable ball should be removed by turning the lever as far as possible downwards from the housing cavity, and the detachable ball's support surfaces and the cavity should then be cleaned.

⚠ WARNING

- When attaching the detachable ball, keep your hands well away from the reach of the lever's rotation. There is a risk of injuring your fingers!
- Never try to pull the lever upwards by force to turn the key. The detachable ball would not be secured properly!

Assembling the detachable ball - Step 2

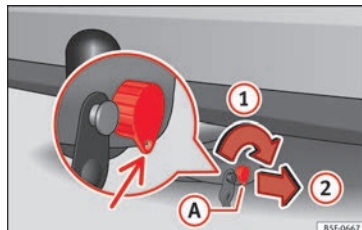


Fig. 237 Locking the lock.

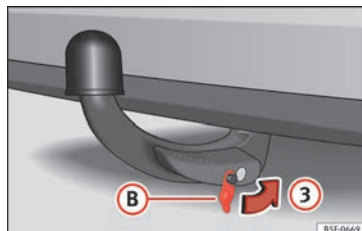


Fig. 238 Placing the cover over the lock.

Do not omit this first step **»» page 248, Assembling the detachable ball - Step 1 !**

- Turn key **A** in the direction of arrow **①** until the part of the key with the holes reaches the bottom position **»» Fig. 237**.

- Remove the key in the direction of arrow ②.
- Place cover ① in the lock in the direction of arrow ③ » Fig. 238 » ①.
- Check that the detachable ball is securely attached » page 249, Checking proper attachment.

ⓘ CAUTION

- After removing the key, always place the cover over the lever's lock. If the lock becomes soiled it will be impossible to insert the key.
- Keep the towing bracket device's housing cavity clean at all times. Dirtiness can prevent the detachable ball from being properly secured!
- If the detachable ball is removed, always place the cap on the hook's housing.

Checking proper attachment

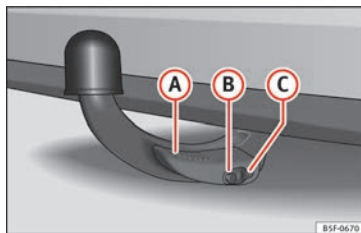


Fig. 239 Detachable ball properly attached.

Whenever you go to use the detachable ball, make sure that it is properly attached first.

Detachables ball properly attached.

- The detachable ball will not fall out of the housing cavity after a major "knock or jerk".
- Lever ① » Fig. 239 is fully raised.
- The release bolt ② » Fig. 239 is sticking fully out (the red and green part is visible).
- The key has been removed.
- Cover ③ » Fig. 239 is placed over the lock.

⚠ WARNING

The towing bracket device should only be used if the detachable ball has been properly locked!

Removing the detachable ball - Step 1

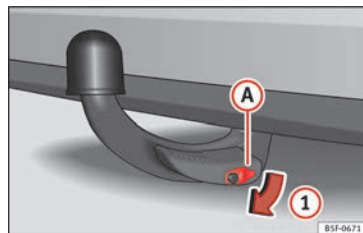


Fig. 240 Removing the lock cover.

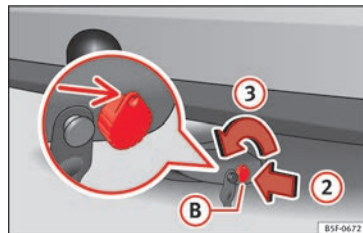


Fig. 241 Releasing the lock.

- Remove cover ① from the lock in the direction of arrow ① » Fig. 240.
- Insert key ② into the lock in the direction of arrow ② » Fig. 241.
- Turn the key in the direction of arrow ③ until the part of the key with the holes is facing upwards. »

⚠ WARNING

Never remove the detachable ball joint when the trailer is hitched.

i Note

Before you remove the detachable ball, you are advised to place the protective cover on the ball coupling.

Removing the detachable ball - Step 2

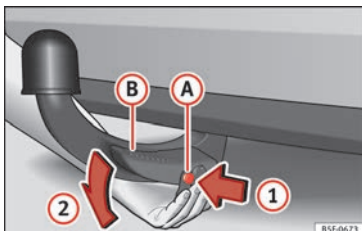


Fig. 242 Releasing the detachable ball.

Do not omit this first step » page 249, Removing the detachable ball - Step 1 !

Releasing the detachable ball

- Grip the detachable ball from below.
- Press the release bolt (A) in the direction of arrow ① as far as it will go, and at the same

time press lever (B) in the direction of arrow ② as far as it will go.

In this position, the detachable ball is loose and will fall/drop freely downwards. If this does not occur when you release it, press it with the other hand from above.

The detachable ball locks into the standby position at the same time and is therefore ready to be reinserted into the hook housing » ④.

- Fit the cap ④ » Fig. 232 onto its housing.

⚠ WARNING

Never leave the detachable ball loose in the luggage compartment. It could cause damage in the luggage compartment in the case of abrupt braking, and even jeopardise passenger safety!

⚠ CAUTION

- If you hold the lever and do not press down on it as far as you can, after you remove the detachable ball, the latter will continue upwards and will not lock into the standby position. The detachable ball should be placed in this position before the next assembly.
- Keep the detachable ball in the standby position, with the key inserted into the box while you place it facing downwards with the side opposite to the one where the key is inserted. The key could get damaged!

- When operating the lever, do not apply too much pressure (for example, do not stand on it)!

i Note

Remove any dirt from the detachable ball before you put it away with the vehicle tools.

Operation and care

Put the cover on the housing cavity so that dirt cannot get in.

Before hooking up a trailer, always check the ball coupling and apply suitable grease if necessary.

Use the protective cover when putting the detachable ball away to keep the luggage compartment clean.

Remove any dirt from the housing cavity surfaces and use a suitable cleaning product.

⚠ CAUTION

The top part of the hook housing is greased. Make sure that the grease has not been removed.

Trailer towing

What do you need to bear in mind when towing a trailer?

Your vehicle may be used to tow a trailer when fitted with the correct equipment.

If you wish to **retrofit** a towing bracket, consult » page 254.

Connectors

Your vehicle is fitted with a 13-pin connector for the electrical connection between the trailer and the vehicle.

If the trailer has a **7-pin plug** you will need to use an adapter cable. It is available at any Technical Service.

Trailer weight/drawbar load

Never exceed the authorised trailer weight. If you do not load the trailer up to the maximum permitted trailer weight, you can then climb correspondingly steeper slopes.

The maximum trailer weights listed are only applicable for **altitudes** up to 1000 m above sea level. With increasing altitude the engine power and therefore the vehicle climbing ability are impaired because of the reduced air density. The maximum trailer weight has to be reduced accordingly. The weight of the vehicle and trailer combination must be re-

duced by 10% for every further 1000 m (or part thereof). The gross combination weight is the actual weight of the laden vehicle plus the actual weight of the laden trailer. When possible, operate the trailer with the maximum permitted **drawbar load** on the ball joint of the towing bracket, but do not exceed the specified limit.

The figures for **trailer weights** and **drawbar loads** that are given on the data plate of the towing bracket are for certification purposes only. The correct towing bracket figures for your specific model, which may be *lower than these figures*, are given in the vehicle documentation or on » page 289, **Technical specifications**.

Distributing the load

Distribute loads in the trailer so that heavy objects are as near to the axle as possible. Loads carried in the trailer must be secured to prevent them moving.

Tyre pressure

The maximum permissible tyre pressure values are shown on the sticker on the back of the left front door frame. Set the tyre pressure of the trailer tyres in accordance with the trailer manufacturer's recommendations.

Exterior mirrors

Check whether you can see enough of the road behind the trailer with the standard rear vision mirrors. If this is not the case, you should have additional exterior mirrors fitted. Both exterior mirrors should be mounted on hinged extension brackets. Adjust the mirrors to give sufficient vision to the rear.

Tow rope

Always use a cable between the vehicle and the trailer » page 252.

Trailer rear lights

The trailer's rear lights should comply with the statutory safety regulations » page 252.

WARNING

Never transport people in a trailer. This could result in fatal accidents.

Note

- **Towing a trailer places additional demands on the vehicle. We recommend additional services between the normal inspection intervals if the vehicle is used frequently for towing a trailer.**
- **Find out whether special regulations apply to towing a trailer in your country.**

Hitching and connecting the trailer



Fig. 243 Schematic diagram: assignment of the pins of the trailer's electrical socket.

Key of the Schematic diagram » Fig. 243:

Pin	Meaning
1	Left turn signal
2	Rear fog light
3	Earth, pins 1, 2, 4 to 8
4	Right turn signal
5	Rear light, right
6	Brake lights
7	Rear light, left
8	Reverse lights
9	Permanent live
10	Cable without positive charge
11	Earth, pin 10

Key of the Schematic diagram » Fig. 243:

Pin	Meaning
12	Unassigned
13	Earth, pin 9

Electrical socket for trailer

The vehicle is fitted with a 13-pole power socket for the electrical connection between the trailer and the vehicle. If the system detects that a trailer has been connected electrically, the electrical equipment on the trailer will receive voltage through this connection.

Pin 9 has a permanent live. This powers, for example, the trailer's interior lighting. Pin 10 is only powered when the engine is running. The charge wire (pin 10) charges, for example, a caravan battery.

Pin 9 and 10 should not be connected to each other to avoid discharging or damaging the vehicle's battery.

The earth wires, pin 3, pin 11 and pin 13, should never be connected to each other to avoid overloading the electrical system.

If the trailer has a **7-contact connector**, you will need to use an adapter cable. In this case the function corresponding to pin 10 will not be available.

Trailer maximum electricity consumption

Brake lights (total)	84 Watts
Turn signal, on each side	42 Watts
Side lights (total)	100 Watts
Rear lights (total)	42 Watts
Rear fog light	42 Watts

Never exceed the values indicated!

Note

- **If the rear lights of the trailer are not correctly connected, the vehicle electronics may be damaged.**
- **If the trailer absorbs excessive electric current, the vehicle electronics may be damaged.**
- **Never connect the trailer's electric system directly to the electrical connections of the tail lights or any other power sources. Only use the connections intended for providing electric current to the trailer.**

Ball coupling of towing bracket device*

The ball coupling is provided with instructions on fitting and removing the ball coupling of the towing bracket.

⚠ WARNING

The towing bracket ball coupling must be stored securely in the luggage compartment to prevent them being flung through the vehicle and causing injury.

i Note

• By law, the ball coupling must be removed if a trailer is not being towed if it obscures the number plate.

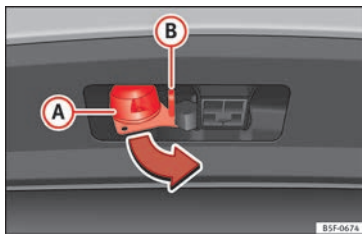
Driving with a trailer

Fig. 244 Turn the 13-pin connector.

Before driving

- Grip the 13-pin connector at area **A** and remove it in the direction of the arrow **»» Fig. 244**.
- Remove the protective cover **5** **»» Fig. 232** upwards.

After driving

- Grip the 13-pin connector at area **A** and insert it in the opposite direction to the arrow **»» Fig. 244**.
- Fit the protective cover **5** **»» Fig. 232** on the ball coupling.

Safety lug

The safety lug **B** **»» Fig. 244** is used to hook up the trailer's retainer cable.

On hooking it up to the safety lug, the retainer cable should **have slack** in all the trailer positions with respect to the vehicle (sharp bends, reverse gear, etc.).

Headlights


The front part of the vehicle may be raised when the trailer is connected and the light may dazzle the rest of the traffic.

Adapt the height of the headlights using the headlight range rotary adjuster¹⁾.

⚠ WARNING

- **Never use the safety lug to tow!**
- **Adjust your speed to suit the road and traffic conditions.**
- **All work on the electrical system must be carried out only by specialised workshops.**
- **Never connect the trailer's electric system to the electrical connections of the rear lights or any other power sources.**
- **After hooking up the trailer and connecting the socket, check that all the trailer's rear lights are working properly.**

i Note

- **If there is any fault in the trailer's lighting, check the fuses in the instrument panel fuse box **»»**  page 63.**
- **The contact between the retainer cable and the safety lug may give rise to mechanical wear in the lug's surface protection. This wear will not prevent the safety lug from operating properly or cause any fault and is excluded from the warranty.**
- **When connecting and disconnecting the trailer, the towing vehicle's handbrake should be applied.**
- **When the tow hitch ball has not been fitted, the socket should remain concealed in its housing on the bumper.**

¹⁾ This does not apply for vehicles with bi-xenon headlights.

Anti-theft alarm

When the vehicle is locked, the alarm is triggered when the electrical connection between vehicle and trailer is interrupted.

Always turn off the anti-theft alarm system before connecting or disconnecting a trailer » page 133.

Conditions for the integration of a trailer in the anti-theft alarm system.

- The vehicle is factory-equipped with an anti-theft alarm system and a towing bracket device.
- The trailer is connected electrically to the towing vehicle by the trailer connector.
- The electrical system of the vehicle and the trailer are prepared for operation.
- The vehicle is locked with the ignition key and the anti-theft alarm system is activated.

ⓘ CAUTION

For technical reasons, trailers fitted with rear LED lights are not integrated in the anti-theft alarm system.

Driving tips

Driving with a trailer always requires extra care.

Weight distribution

The weight distribution of a loaded trailer with an unladen vehicle is very unfavourable. However, if this cannot be avoided, drive extra slowly to allow for the unbalanced weight distribution.

Speed

The stability of the vehicle and trailer is reduced with increasing speed. For this reason, it is advisable not to drive at the maximum permissible speed in an unfavourable road, weather or wind conditions. This applies especially when driving downhill.

You should always reduce speed immediately if the trailer shows the slightest sign of **snaking**. Never try to stop the “snaking” by increasing speed.

Always brake in due course. If the trailer has an **overrun brake**, apply the brakes *gently at first* and then, firmly. This will prevent the jerking that can be caused by locking of trailer wheels. Select a low gear in due course before going down a steep downhill. This enables you to use the engine braking to slow down the vehicle.

Reheating

At very high temperatures and during prolonged slopes, driving in a low gear and high engine speed, always monitor the coolant temperature gauge » page 119.

Electronic stability control*

The ESC* system helps to stabilise the trailer in case of skidding or rocking.

Retrofitting a towing bracket*

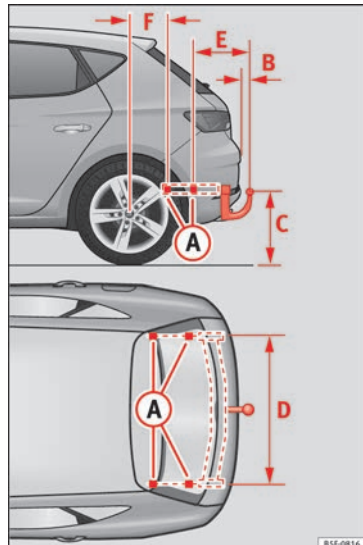


Fig. 245 Attachment points for towing bracket.

If a towing bracket is to be fitted after the vehicle is purchased, this must be completed according to the instructions of the towing bracket manufacturer.

The attachment points for the towing bracket **(A)** are on the lower part of the vehicle.

The distance between the centre of the ball coupling and the ground should never be lower than the indicated value, even with a fully loaded vehicle and including the maximum drawbar load.

Elevation values for securing the towing bracket:

(B)	65 mm (minimum)	
(C)	350 mm to 420 mm (fully laden vehicle)	
(D)	1040 mm	
(E)	317 mm	
(F)	LEON/LEON SC	LEON ST
	319 mm	596 mm

Fitting a towing bracket

• Driving with a trailer involves an extra effort for the vehicle. Therefore, before fitting a towing bracket, please contact a Technical Service to check whether your cooling system needs modification.

- The legal requirements in your country must be observed (e.g. the fitting of a separate control lamp).
- Certain vehicle components, e.g. the rear bumper, must be removed and reinstalled. The towing bracket securing bolts must be tightened using a torque wrench, and a power socket must be connected to the vehicle electrical system. This requires specialised knowledge and tools.
- Figures in the illustration show the elevation value and the attachment points which must be considered if you are retrofitting a towing bracket.

WARNING

The towing brackets should be fitted at a specialised workshop.

- If the towing bracket is incorrectly installed, there is a serious danger of accident.
- For your own safety, please observe the tow bracket manufacturer's instructions.

CAUTION

• If the power socket is incorrectly installed, this could cause damage to the vehicle electrical system.

Note

• SEAT recommends that the towing hooks be fitted at a specialised workshop. Consult

your SEAT dealer in case additional modifications to your vehicle are necessary.

• **Due to the specific design of the exhaust, the fitting of a conventional towing hook is not recommended for some sportier versions. Please consult your Technical Service.**

Advice

Care and maintenance

Accessories and modifications to the vehicle

Accessories, replacement parts and repair work

Always ask your dealer or specialist retailer for advice before purchasing accessories and replacement parts.

Your vehicle is designed to offer a high standard of active and passive safety. For this reason, we recommend that you ask a SEAT Official Service for advice before fitting accessories or replacement parts. Your SEAT Official Service has the latest information from the manufacturer and can recommend accessories and replacement parts which are suitable for your requirements. They can also answer any questions you might have regarding official regulations.

We recommend you to use only **SEAT accessories** and **Genuine SEAT parts**[®]. SEAT has tested these parts and accessories for suitability, reliability and safety. SEAT Official Services have the necessary experience and facilities to ensure that the parts are installed correctly and professionally.

Any **retro-fitted equipment** which has a direct effect on the vehicle and/or the way it is driven, such as a cruise control system or **electronically-controlled suspension**, must be approved for use in your vehicle and bear the **e** mark (the European Union's authorisation symbol).

If **any additional electrical devices** are fitted which do not serve to control the vehicle itself (for instance a refrigerator box, laptop or ventilator fan, etc.), they must bear the **CE** sign (manufacturer conformity declaration in the European Union).

WARNING

Accessories, for example telephone holders or cup holders, should never be fitted on the covers, or within the working range of the airbags. Otherwise, there is a danger of injury if the airbag is triggered in an accident.

Technical modifications

Modifications must always be carried out according to our specifications.

Unauthorised modifications to the electronic components, software, wiring or data transfer in the vehicle may cause malfunctioning. Due to the way the electronic components are linked together in networks, other indirect systems may be affected by the faults. This can seriously impair safety, lead to excessive

wear of components, and also invalidate your vehicle registration documents.

You will appreciate that your SEAT dealership cannot be held liable for any damage caused by modifications and/or work performed incorrectly.

We therefore recommend that all work should be performed by a SEAT Official Service using **genuine SEAT parts**[®].

WARNING

Incorrectly performed modifications or other work on your vehicle can lead to malfunctions and cause accidents.

Radio transmitters and office equipment

Radio transmitters (fixed installation)

Any retrofit installations of radio transmitters in the vehicle require prior approval. SEAT generally authorises in-vehicle installations of approved types of radio transmitters provided that:


- The aerial is installed correctly.
- The aerial is installed on the exterior of the vehicle (and shielded cables are used together with non-reflective aerial trimming).
- The effective transmitting power does not exceed 10 Watts at the aerial base.

A SEAT Official Service and specialised workshop will be able to inform you about options for installing and operating radio transmitters with a *higher* transmitting power.

Mobile radio transmitters

Commercial mobile telephones or radio equipment might interfere with the electronics of your vehicle and cause malfunctions. This may be due to:

- No external aerial.
- External aerial incorrectly installed.
- Transmitting power more than 10 W.

You must, therefore, do not operate portable mobile telephones or radio equipment *inside the vehicle* without a properly installed external aerial »» .

Please note also that the maximum range of the equipment can only be achieved with an *external* aerial.

Business equipment

Retrofit installation of business or private equipment in the vehicle is permitted, provided the equipment cannot interfere with the driver's immediate control of the vehicle and that any such equipment carries the **CE** mark. Any retrofit equipment that could influence the driver's control of the vehicle must have a type approval for your vehicle and must carry the **e** mark.

WARNING

Mobile telephones or radio equipment which is operated inside the vehicle without a properly installed external aerial can create excessive magnetic fields that could cause a health hazard.

Note

- The posterior fitting of electric and electronic equipment in this vehicle affects its licence and could lead to the withdrawal of the vehicle registration document under certain circumstances.
- Please use the mobile telephone/radio operating instructions.

Care and cleaning

General information

Regular and careful care helps to **maintain the value** of the vehicle. This may also be one of the requirements for upholding any warranty claims in the event of corrosion or paint defects.

SEAT Official Services and specialist retailers carry stocks of suitable **car care materials**. Please follow the instructions for use on the packaging.

WARNING

- Cleaning products and other materials used for car care can be damaging to your health if misused.
- Always keep care products in a safe place, out of the reach of children. Failure to comply could result in poisoning.

For the sake of the environment

- If possible, use environmentally friendly products.
- The remains of car care products should not be disposed of with ordinary household waste.

Vehicle exterior care

Washing the vehicle

The longer substances such as insects, bird droppings, resinous tree sap, road dirt, industrial deposits, tar, soot or road salt and other aggressive materials remain on the vehicle, the more damage they do to the paintwork. High temperatures (for instance due to strong sunlight) further intensify the corrosive effect.

After the period when salt is put on the roads it is important to have the underside of the vehicle washed thoroughly. »»

Automatic car washes

Before going through a car wash, be sure to take the usual precautions (closing the windows, roof and rear-view mirrors). If the vehicle has special accessories such as spoilers or a roof rack or two-way radio aerial, etc., it is advisable to consult the car wash tunnel operator.

It is best to use a car wash without revolving bristles if possible.

Washing the vehicle with a high pressure cleaner

When washing the vehicle with a high-pressure cleaner, always follow the operating instructions for the equipment. This applies particularly to the **operating pressure** and the **spraying distance**. Do not hold the nozzle too close to soft materials such as rubber hoses or seals. The same applies to the parking aid sensors*, which are located in the rear bumper.

Do not use a nozzle that sprays the water out in a **direct stream** or one that has a **rotating jet** for forcing off dirt.

Factory-fitted adhesive sheets

The following indications should be taken into account to avoid damaging adhesive sheets:

- Do not use high pressure cleaners.

- Do not use scrapers to remove ice or snow from the sheets.
- Do not polish the adhesive sheets.
- Do not use dirty cloths or sponges.
- It is preferable to wash them with a soft sponge and gentle neutral soap.

Washing the car by hand

When washing the car by hand, use plenty of water to soften the dirt first, and rinse off as well as possible.

Then clean the vehicle with a soft **sponge**, **glove** or **brush** using only slight pressure. You should start on the roof and work down. Special car **soap** should only be used for very persistent dirt.

Rinse the sponge or glove thoroughly and often.

Wheels, sills and similar should be cleaned last. Use a second sponge for this.

⚠ WARNING

- The vehicle should only be washed with the ignition switched off. Failure to follow this instruction could result in an accident.
- Do not clean the underside of chassis, the inside of wheel arches or wheel trims without protecting your hands and arms. You may cut yourself on sharp-edged metal parts. Otherwise, there is a risk of sustaining cuts.

- When washing the car during the winter season: water and ice in the brake system can reduce braking effectiveness: risk of accident!

ⓘ CAUTION

- Do not wash the vehicle in direct sunlight – otherwise the paint can be damaged.
- Do not use sponges, abrasive household sponges or similar to clean insect remains. This could damage the surface.
- Clean off stubborn dirt (insects, etc.) from the headlights at regular intervals, for instance when filling the fuel tank. The headlights should only be washed with water, do not wipe them with a dry cloth or sponge. It is best to use soapy water.
- Never wash tyres with a jet that sprays the water out in a direct stream. This could damage the tyres even if the spray is kept at a distance and only used for a very short time.
- Before washing the vehicle in an automatic car wash, please make sure to retract the exterior mirrors to prevent them from being damaged. Electrically retractable exterior mirrors must not be folded in or out by hand, always use the electrical power control.

ⓘ CAUTION

- Before washing the vehicle in an automatic car wash, please proceed as follows to lock the wiper arms so that they are not moved towards the top of the windscreen:

- the bonnet must be closed.
- switch the ignition on and off.
- press the windscreen wiper lever forward briefly (windscreen washer function). This will lock the wiper arms.

For the sake of the environment

The car should only be washed in special wash bays. These areas are prepared to prevent oily water from getting into the public drains. In some places, washing vehicles outside the areas intended for this purpose is prohibited.

Camera sensors and lenses

- Use a small brush to remove snow and a de-icer spray to remove ice.
- Clean the sensors with a solvent-free product and a soft, dry cloth.
- Moisten the camera lens using a standard alcohol-based glass cleaning agent and clean the lens with a dry cloth. In the *active lane assist**, the area in front of the lens is normally cleaned with the windscreen washer.

CAUTION

- When you clean the vehicle with a pressure washer:

- Stay a suitable distance from the sensors on the front and rear bumpers.
- Do not clean the camera lenses or surrounding area with the pressure washer.
- Never use warm or hot water to remove snow and ice from the reverse camera lens, as it could crack the lens.
- Never use abrasive cleaning agents on the lens.

Waxing and polishing

Care

Waxing protects the paintwork. It is time to apply a **coat of good wax** when water no longer **forms droplets** and rolls off the clean paintwork.

Even if a **wax solution** is used regularly in the vehicle washing tunnel, it is advisable to protect the paint with a hard wax coating at least twice a year.

In the summer, you will find it is much easier to remove dead insects (which accumulate on the bumper and the front of the bonnet) if the car has been treated with care products *recently*.

Polishing

Polishing is only necessary if the paint has lost its shine, and the gloss cannot be brought back by putting on wax.

If the polish does not contain wax, a wax product should be applied after polishing.

CAUTION

- Do not use polishes and hard wax on painted parts with a matt finish or on plastic parts.
- Do not apply paint polishes to the side trim that runs around the panoramic roof and ends on the windscreen. However, it can be treated with hard wax.

Trims

In respect for the environment, the silver-plated trims on the body are made of pure aluminium (they do not contain chrome).

Dirt or marks on the trim mouldings should be removed with a **cleaning product with a neutral PH** (do not use a chrome cleaner). Body polish is also unsuitable for use on trim mouldings. The intensive cleaning fluids often used before the car goes into a car wash may contain alkaline substances, which can cause dull or milky patches when they dry out.

SEAT Official Services carry stocks of cleaning products which have been tested for use on your vehicle and are not harmful to the environment.

Plastic parts

Plastic parts are cleaned with a power washer. If this is not sufficient, plastic parts should only be treated with a special solvent-free **plastic cleaning agent**. Do not use paintwork cleaners, polishes or wax on plastic parts.

Carbon parts

The carbon parts on your vehicle have a painted surface. They do not need any special care and are cleaned just like any other painted part »» page 257.

Paint damage

Minor damage to the paint, such as scratches or stone chips, should be touched up *without delay* before the metal starts to corrode. Suitable **touch-up brushes** or **sprays** for your car can be obtained from a SEAT Official Service.

The number of the original paint finish on the vehicle is given on the data sticker »» page 289.

If corrosion is already visible it must be thoroughly removed by a specialised workshop.

Windows

Clear vision is an essential safety factor.

The windscreen must not be cleaned with insect remover or wax, otherwise the windscreen wipers will not function properly (judging).

Traces of rubber, oil, grease or silicone can be removed with a **window cleaning solution** or a **silicone remover**. Wax residue can only be removed with a special cleaner. Your SEAT Official Service will be able to provide you with more detailed information.

The windows should also be cleaned on the inside at regular intervals.

Use a separate cloth or chamois to dry the windows. Cloths used for waxing and polishing contain residues that will cause smears on the glass.

WARNING

Do not use water-repellent coatings on the windscreen. In bad visibility conditions (e.g. in the rain, dark or with a low sun), these coatings may cause dazzle: risk of accident! Such coatings can also cause the windscreen wiper blades to make noise.

CAUTION

• Remove snow and ice from windows and exterior mirrors with a plastic scraper only. To

avoid scratches caused by dirt on the glass, the scraper should only be pushed in one direction and not moved to and fro.

- **The heating element for the rear window is located on the inner side of the window. To avoid damaging them, do not apply stickers to these heating elements.**
- **Never use warm or hot water to remove snow and ice from windows and mirrors. This could cause the glass to crack!**

Rims

The wheels require regular attention to preserve their appearance. It is important to remove road salt and brake dust by washing the wheels at regular intervals, otherwise the finish will be impaired.

After washing, the wheels should only be cleaned with an "acid-free" cleaning agent for alloy wheels. This is available from SEAT Official Services and specialist retailers. Never leave the cleaning agent on the rims for any longer than specified in the instructions before rinsing it off. If the wheel cleaner fluid contains acid it can attack the surfaces of the wheel bolts.

Car polish or other abrasive agents should not be used for maintaining the rims. If the protective coating is damaged, e.g. by flying stones, the damaged area should be repaired immediately.

⚠ WARNING

Please note when cleaning the wheels that **water, ice and road salt can impair the effectiveness of the brakes; this can cause an accident.**

Exhaust pipe

It is important to remove road salt and brake dust by washing the wheels at regular intervals, otherwise the exhaust tail pipe material could be damaged. To remove impurities, do not use rim, paint or chrome cleaners or other abrasive products. Clean the exhaust tail pipes with cleaning products that are suitable for stainless steel.

SEAT Official Services carry stocks of cleaning products that have been tested and approved for use on your vehicle.

Caring for the vehicle interior**Screen for the radio/Easy Connect* and control panel***

The display can be cleaned with a soft cloth and a professionally available "LCD cleaner". Moisten the cloth with a small amount of the cleaning fluid.

The Easy Connect control panel* should first be cleaned with a brush so that no dirt goes into the device or between the keys and housing. Next, we recommend cleaning the Easy Connect control panel* using a cloth dampened with water and washing-up liquid.

ⓘ CAUTION

- To avoid scratching the screen, do not wipe the display with a dry cloth.
- To avoid damage, ensure that no liquid goes into the Easy Connect control panel*.

Plastic and leatherette parts

Plastic parts and leatherette can be cleaned with a damp cloth. If this is not sufficient, plastic parts and leatherette should only be treated with a **special solvent-free plastic cleaner**.

Textile covers and trim parts

Textile covers and trim parts (e.g. seats, door trim) should be cleaned regularly with a vacuum cleaner. This will remove surface dirt which could otherwise be rubbed into the textile material during use. Do not use steam cleaners, as the steam could carry the dirt deeper into the textile material.

Normal cleaning

We recommend that you use a soft sponge or a commercially available lint-free, micro-fibre cloth for normal cleaning. Only use brushes on floor coverings and mats, as other textile surfaces could become damaged.

In the case of normal surface dirt you can use a foam cleaner. Use a sponge to spread the foam on the textile surface and to work it into the material lightly. However, make sure that the textile material does not become soaking wet. Then dab off the foam with a dry and absorbent cloth (e.g. a micro-fibre cloth) and vacuum off any residue once the surface is completely dry.

Cleaning stains

Treat drink stains (such as coffee or fruit juice, etc.) with a cleaning solution for delicate fabrics. This solution should be applied with a sponge. If the stains are difficult to remove, a washing paste can be applied directly onto the stain and worked into the fabric. The surface will then have to be wiped with clear water to remove any residue left by the paste. To do so, use a damp cloth or sponge and then dab the stain with an absorbent cloth.

Remove chocolate or make-up stains with a cleaning paste (for e.g., soft soap). Then remove the soap with water (wet sponge).



A spirit-based cleaner can be used to remove grease, oil, lipstick or ball point pen. Then dab the dissolved grease or colour particles off with an absorbent cloth or similar. You may also have to treat the stain once more using washing paste and water.

If the covers or textile trim panels are badly soiled we recommend that you have them cleaned by a professional cleaning company with a shampoo and spray.

Note

Open Velcro fasteners on clothes can damage the seat upholstery. Make sure they are closed.

Natural leather

General information

Our range of leathers is large. The main type used is particularly nappa in various forms, that is, leather with a smooth surface in different colours.

The amount of dye used determines the appearance and properties of leather. If the leather is left in a more natural state, it retains its typical napped appearance and confers excellent all-weather properties to the seats. Fine veins, healed scars, insect bites, wrinkles and a subtle variation in shad-

ing remain visible; these are the characteristic features of genuine natural leather.

Natural napped leather does not have a protective surface coating of dye. It is therefore somewhat more prone to damage. This should be borne in mind if children or pets often travel in the car, or if there are other factors that could lead to damage.

Types of leather with a coloured surface coating are likely to be more resistant to damage. This has a great advantage for day-to-day use. However, this means that the typical natural characteristics of the surface are less apparent, though this does not affect quality.

Cleaning and care

Due to the natural properties of the specially selected hides employed, the finished leather has a certain sensitivity to grease and dirt, etc. so a degree of care is required in everyday use and when looking after the leather. Dark clothing (especially if damp or incorrectly dyed) may stain leather upholstery on the seats. Dust and grit in the pores and seams can scratch and damage the surface. Therefore leather should be cleaned at regular intervals, depending on the actual amount of use. When they have been in use for a certain time, your car seats will acquire a typical and unmistakable patina. This is characteristic for leather as a natural product and is a sign of genuine quality.

To maintain the value of natural leather you should note the following points:

CAUTION

- **Avoid exposing leather to direct sunlight for long periods, otherwise it may tend to lose some of its colour. If the car is left for a prolonged period in the bright sun, it is best to cover the leather.**
- **Sharp-edged objects on clothing, such as belts, zip fasteners, rivets or similar, can also leave permanent scratches and rough marks on the surface of the leather.**

Note

- **Use a suitable impregnating cream with ultra-violet protection at regular intervals and after cleaning. The cream nourishes and moisturises the leather, keeps it supple and able to breathe. A protective film will also form.**
- **Clean the leather every 2 to 3 months and remove fresh dirt as soon as possible.**
- **Remove stains from fresh ball-pen and other inks, lipstick, shoe cream and similar stains as soon as possible.**
- **Preserve the colour of the leather. A special coloured cream will renew the colour of the leather when required and will eliminate differences in colour.**

Cleaning and care of leather upholstery

Natural leather requires an extra degree of attention and care.

Normal cleaning

- Moisten a cotton or woollen cloth with water and wipe over the leather surfaces.

More stubborn dirt

- More stubborn dirt can be removed using a mild soap solution (pure liquid soap: two tablespoons dissolved in one litre of water).
- Do not let the water soak through the leather or penetrate into the seams.
- Then wipe off with a soft, dry cloth.

Removal of stains

- Remove fresh **water-based** stains such as coffee, tea, juices, blood etc. with an absorbent cloth or kitchen roll, or use the cleaning agent from the care set for dried-on stains.
- Remove fresh **grease-based** stains that have not penetrated the surface such as butter, mayonnaise, chocolate, etc. with an absorbent cloth or kitchen roll or with the cleaning agent from the care set.

- Treat **fat-based, dried-in** stains with grease-dissolving spray.
- Treat **less common stains** on leather, such as ball-pen and other inks, felt-tip pens, nail polish, dispersion paint, shoe cream etc. with a special leather stain remover.

Leather maintenance

- The leather should be treated regularly (about twice a year) with a special leather-care product.
- Apply these products very sparingly.
- Then wipe off with a soft cloth.

Should you have questions regarding the care and cleaning of the leather upholstery in your vehicle, we recommend that you contact your SEAT Official Service. Our representatives will be happy to advise you and tell you about the product range for leather conservation, for example:

- Cleaning and care set.
- Coloured leather-care cream.
- Stain remover for ball-pen inks, shoe cream etc.
- Grease dissolving spray.
- New products and further developments

ⓘ CAUTION

On no account use solvents (such as petrol, turpentine), wax polish, shoe cream or similar materials.

Cleaning Alcantara upholstery

Removing dust and dirt

- Moisten a cloth *just a little* and wipe down the seat covers.

Removing stains

- Moisten a cloth with lukewarm water or diluted **white spirits**.
- Dab at the stain. Start at the outside and work inwards.
- Dry the clean area with a soft cloth.

Do not use leather cleaning products on Alcantara seat covers.

You may use a suitable soap on dust and dirt.

Dust and grit in the pores and seams can scratch and damage the surface. If the car is left standing in the sun for long periods, Alcantara leather should be protected against direct sunlight to prevent it from fading. However, slight colour variations will arise in normal use. »

ⓘ CAUTION

- Do not use solvents, wax polish, shoe cream, stain removers, leather cleaning products or any similar products on Alcantara.
- To avoid damage, stubborn stains should be removed by a specialised workshop.
- On no account use brushes, hard sponges or similar utensils.

the belt in question must be replaced by a specialised workshop.

Seat belts

- Keep the seat belts clean.
- For cleaning, use a mild solution of soap and water.
- Check the condition of the seat belts at regular intervals.

The retract function may not operate properly in very dirty belts. Make sure that the inertia reel seat belts are completely dry before allowing them to retract.

ⓘ CAUTION

- Do not remove the seat belts from the vehicle to clean them.
- Do not use chemical cleaning agents on the seat belts, as this can damage the webbing. Ensure that the seat belts do not come into contact with corrosive fluids.
- If you find any damage to the belt webbing, belt fittings, the belt retractor or the buckle,


Checking and refilling levels**Filling the tank****Refuelling**

Read the additional information carefully


»  page 58

If the automatic filler nozzle is operated correctly, it will switch itself off as soon as the fuel tank is “full”. Do not try to put in more fuel after the nozzle cuts out, as this will fill the expansion chamber in the fuel tank.

The correct fuel grade for your vehicle is given on a sticker on the inside of the fuel tank flap. Further notes on fuel can be found at » **page 266.**

The capacity of your vehicle's fuel tank is given in »  **page 58.**

Vehicles with natural gas engines and hybrids

Every 6 months it is necessary to run on petrol until the control lamp switches off  and then the tank must be refilled. This is necessary to ensure that the system works properly, as well as the fuel quality required for driving with petrol.

⚠ WARNING

Fuel is highly flammable and can cause serious burns and other injuries.

- Do not smoke when filling the fuel tank or a canister. Naked flames are forbidden in the vicinity due to the risk of explosion.
- Observe legislation governing the use, storage and carrying of a spare fuel canister in the vehicle.
- For safety reasons we do not recommend carrying a spare fuel canister in the vehicle. In an accident the canister could be damaged and could leak.
- If, in exceptional circumstances, you have to carry a spare fuel canister, please observe the following points:
 - Never fill fuel into the spare fuel canister if it is inside or on top of the vehicle. An electrostatic charge could build up during filling, causing the fuel vapour to ignite. Danger of explosion. Always place the canister on the ground to fill it.
 - Insert the filling nozzle as far as possible into the spare fuel canister.
 - If the spare fuel canister is made of metal, the filling nozzle must be in contact with the canister during filling. This helps prevent an electrostatic charge building up.

- Never spill fuel in the vehicle or in the luggage compartment. Fuel vapour is explosive. Risk of fatal accident!

ⓘ CAUTION

- If any fuel is spilt onto the vehicle, it should be removed immediately. It could otherwise damage the paintwork.
- Never run the tank completely dry. An irregular fuel supply could cause misfiring. As a result, unburnt fuel could enter the exhaust system and damage the catalytic converter.
- When filling the fuel tank after having run it completely dry on a vehicle with a diesel engine, the ignition must be switched on for at least 30 seconds before starting the engine. When you then start the engine it may take longer than normal (up to one minute) to start firing. This is because air needs to be bled from the fuel system while starting.

♻ For the sake of the environment

Do not overfill the fuel tank, it may cause the fuel to overflow if it becomes warm.

ⓘ Note

There is no emergency mechanism for the manual release of the fuel tank flap. If necessary, request assistance from specialised personnel.

ⓘ Note

Diesel vehicles are fitted with a protective device that prevents the insertion of the wrong fuel hose¹⁾. It is only possible to refuel with Diesel nozzles.

- If the pump nozzle is worn, damaged, or if it is very small, it is possible that it will not be able to open the protective device. Before trying to insert the pump nozzle by turning it, try a different pump or request specialist help.
- If you fill the tank from a reserve fuel canister, the protective device will not open. One way to resolve this is to pour the fuel in very slowly.

Refuelling with natural gas

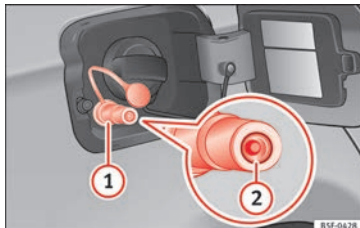


Fig. 246 Tank flap open: gas filler mouth (1), filler mouth retainer (2)

¹⁾ Depending on country


Before refuelling, the engine and the ignition, mobile telephone and heating must be switched off separately » » » ⚠.

Read the instructions on how to use the natural gas pump carefully.

The vehicle is not prepared for refuelling with liquefied natural gas (LNG) » » » ⚠. Before refuelling with natural gas, make sure you add the appropriate type of fuel » » » page 266.


Opening the fuel tank cap

The natural gas filler mouth is behind the fuel tank cap, next to the petrol filler mouth.

- Unlock the vehicle with the key or with the central locking button  situated on the driver door » » » page 125.
- Press on the rear area of the flap and open it.


Refuelling

Special feature: if the ambient temperature is very high, the natural gas pump protection against overheating disconnects this automatically.

- Remove the plug from the gas filler mouth » » » Fig. 246 .
- Connect the pump filling nozzle to the gas filler mouth.
- The fuel tank will be *full* when the pump compressor automatically cuts the supply.

- If you wish to finish refuelling in advance, press the button on the pump to stop the flow.

Closing the fuel tank cap

- Check that the gas filler mouth retainer  is not trapped with the filler nozzle. If necessary, place it in the filler mouth again.
- Insert the plug in the filler mouth.
- Close the tank flap. Make sure you hear it click into place.

WARNING

Natural gas is a highly explosive, easily flammable substance. Incorrect handling of the natural gas can cause accidents serious burns and other injuries.

- Before refuelling with natural gas, engage the filling mouth correctly. If you can smell gas, stop refuelling immediately.

WARNING

The vehicle is not prepared to use liquefied natural gas (LNG), and this fuel must not be added under any circumstances. Liquefied natural gas can cause the natural gas tank to explode, resulting in serious injury.

Note

- The filling nozzles of natural gas pumps can differ in the way they are operated. If you

do not know, ask a qualified employee at the petrol station to do the refuelling.

- Noises heard when refuelling are normal and do not indicate the presence of a fault in the system.
- The vehicle natural gas system is prepared both for refuelling with a small compressor (slow refuel) and a large compressor (fast refuel) in natural gas service stations.

Fuel

Types of petrol

The correct grade of petrol is listed inside the fuel tank flap.

The vehicle is equipped with a catalytic converter and must only be run on **unleaded petrol**. The petrol must comply with European Standard EN 228 or German standard DIN 51626-1 and must be **unleaded**. You can refuel with a maximum ethanol proportion of 10 % (E10). The types of petrol are differentiated by their **octane rating (RON)**.

The following titles appear on the corresponding adhesive on the fuel tank flap:

Super unleaded 95 octane or normal 91 octane unleaded petrol

We recommend you use super 95 octane petrol. If this is not available: normal 91 octane petrol, with a slight decrease in power.

Super unleaded petrol with a minimum of 95 octanes

You should use super petrol with a minimum of 95 octanes.

If super is not available, *in an emergency* you may refuel with normal 91 octane petrol. In this case only use moderate engine speeds and a light throttle. Refuel with super as soon as possible.

Super unleaded 98 octane or super 95 octane unleaded petrol

We recommend you use super plus 98 octane petrol. If this is not available: super 95 octane petrol, with a slight decrease in power.

If super is not available, *in an emergency* you may refuel with normal 91 octane petrol. In this case only use moderate engine speeds and a light throttle. Refuel with super as soon as possible.

Petrol additives

The quality of the fuel influences the behaviour, power and service life of the engine. This is why the petrol you use should carry suitable additives already included by the

petrol industry, free of metals. These additives will help to prevent corrosion, keep the fuel system clean and prevent deposits from building up in the engine.

If good-quality petrol with metal-free additives is not available or engine problems arise, the necessary additives must be added when refuelling » ⓘ.

Not all petrol additives have been shown to be effective. The use of unsuitable petrol additives may cause significant damage to the engine and the catalytic converter. Metal additives should never be used. Metal additives may also be contained in petrol additives for improving anti-detonation ratings or octane ratings » ⓘ.

SEAT recommends “genuine Volkswagen Group Fuel Additives for petrol engines”. These additives can be bought at SEAT dealers, where information on how to use them can also be obtained.

ⓘ CAUTION

- **Do not refuel if the filler indicates that the fuel contains metal. LRP (lead replacement petrol) fuels contain high concentrations of metal additives. Using them may damage the engine!**
- **Never refuel with fuels containing a large proportion of ethanol (for example, E50, E85). This could damage the fuel system.**

- **Just filling one full tank of leaded fuel or fuel containing other metal additives would seriously impair the efficiency of the catalytic converter.**

- **Only use fuel additives that have been approved by SEAT. Octane boosting or anti-knock additives may contain metal additives that could seriously damage the engine or the catalytic converter. These additives must not be used.**

- **High engine speed and full throttle can damage the engine when using petrol with an octane rating lower than the correct grade for the engine.**

ⓘ Note

- **You may use petrol with a high octane number than the one recommended for your engine.**

- **In those countries where unleaded petrol is not available, you may refuel with a fuel with a low lead content.**

Diesel fuel

Please note the information on the inside of the fuel tank flap.


We recommend the use of **diesel** fuel which complies to European standard EN 590. If diesel fuel which meets European standard EN 590 is not available, the Cetane number (CZ) must, at minimum, be 51. If the engine »

is equipped with a particulate filter, the sulphur content of the fuel must be below 50 parts per million.

Winter-grade diesel

Summer fuel becomes thicker in winter and it is more difficult to start the engine. For this reason, petrol stations in some countries also offer winter diesel with improved fluidity when cold (winter-grade diesel).

Water in the fuel filter¹⁾

If your vehicle has a diesel engine and is equipped with a **fuel filter with a water separator**, the instrument panel may display the following warning:  **Water in the fuel filter**. If this is the case, take the vehicle to a specialised workshop so that they can drain the fuel filter.

CAUTION



- The vehicle is not designed for the use of FAME fuel (biodiesel). The fuel system would be damaged if you used biodiesel.
- Do not mix fuel additives, the so-called “thinners”, petrol or similar additives with diesel fuel.
- If poor-quality diesel fuel is used, it may be necessary to drain the fuel filter more frequently than is specified in the Maintenance

Programme. We recommend having this done by a specialised workshop. If water is allowed to collect in the filter, this can cause engine performance problems.

Natural gas

Natural gas can be compressed or in liquid form, addition to others.

Liquefied natural gas (LNG) is the result of heavy cooling of natural gas. Therefore its volume is considerably reduced compared with compressed natural gas (CNG). In vehicles with a natural gas engine, liquefied natural gas cannot be directly refilled, as the gas would expand excessively in the vehicle gas tank.

Therefore, vehicles with a natural gas engine must only be refuelled using compressed natural gas  .

Natural gas quality and consumption



Natural gas is divided into the groups H and L depending on its quality.

Gas type H has a superior heating power and inferior nitrogen and carbon dioxide content than type L. The higher the heating power of



the natural gas, the lower the consumption will be.

However, the heating power and the proportion of nitrogen and carbon dioxide can fluctuate within the quality groups. Therefore, vehicle consumption can also vary when using a single type of gas only.

The engine management automatically adapts to the natural gas used according to its quality. Therefore, different quality gases can be mixed in the tank, without the need for comprehensive draining before applying a different quality gas.

Updated information relating to natural gas quality is displayed on the instrument panel   page 36.

Natural gas and safety

If you can smell gas or suspect that there is a leak  :

- Stop the vehicle immediately.
- Switch the ignition off.
- Open the doors to appropriately ventilate the vehicle.
- Extinguish cigarettes immediately.
- Move away from the vehicle or switch off objects that may cause sparks or a fire.

¹⁾ Valid for the market: Algeria.

- If you continue to smell gas, do not continue driving!
- Seek specialist assistance. Have the fault repaired.

Regular checks of the natural gas system

The natural gas tanks may be damaged or corroded by external factors. The walls of the gas tanks are weakened by deformations, damage or corrosion. As a result, the tanks could burst and result in serious injuries or even death. For this reason, the vehicle owner must have a specialised workshop check (visual check) **the gas system every 4 years at least**. The vehicle owner must have a specialised workshop replace the natural gas tanks before they reach the end of their service life. For further information about the service life of gas tanks, go to a SEAT dealer service or a specialised workshop

WARNING

Failure to act when you can smell gas in the vehicle or when refuelling can cause serious injuries.

- Carry out the necessary operations.
- Leave the danger zone.
- If necessary, warn the emergency services.

WARNING

The vehicle is not prepared to use liquefied natural gas (LNG) and this fuel must not be

added under any circumstances. Liquefied natural gas can cause the natural gas tank to explode, resulting in serious injury.

WARNING

Damaged, corroded or rusted tanks can result in serious injury or even death.

- Have the natural gas deposits checked at least every 4 years (visual check).
- Natural gas tanks have a limited service life. Have the natural gas tanks replaced when required. You can obtain further information about this at SEAT dealers or specialised workshops.

WARNING

If the vehicle underbody touches the ground or in the event of a rear collision, there could be damage to the natural gas tanks.

- Check whether there is a smell of gas.
- If you notice a smell of gas, take the vehicle to a specialised workshop immediately and have the natural gas system checked.

Note

Have the natural gas system checked regularly by a specialised workshop, according to the Maintenance Programme.

Engine compartment

Checking levels

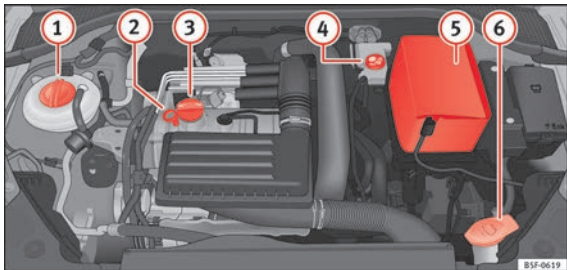


Fig. 247 Diagram for the location of the various elements.

From time to time, the levels of the different fluids in the vehicle must be checked. Never fill with incorrect fluids, otherwise serious damage to the engine may be caused.


- ❶ Coolant expansion tank
- ❷ Engine oil dipstick
- ❸ Engine oil filler cap
- ❹ Brake fluid reservoir
- ❺ Vehicle battery (underneath the cover)
- ❻ Windscreen washer reservoir

The checking and refilling of service fluids are carried out on the components mentioned above. These operations are described in »» page 270.


Overview

You will find further explanations, instructions and restrictions on the technical specifications as of »» page 289.

Working in the engine compartment

Read the additional information carefully
»»  page 17

Always be aware of the danger of injury and scalding as well as the risk of accident or fire when working in the engine compartment (e.g. when checking and refilling fluids). Always observe the warnings listed below and follow all general safety precautions. The en-

gine compartment of the vehicle is a potentially hazardous area »» .

WARNING

- Switch the engine off, remove the key from the ignition and apply the hand brake. If the vehicle has a manual gearbox, place the lever in neutral; if it has an automatic gearbox, place the selector lever in position P. Wait for the engine to cool down.
- Keep children away from the engine compartment.
- Never spill liquids used for vehicle operation on the engine compartment, as these may catch fire (e.g. the antifreeze in coolant).

- Take care not to cause short circuits in the electrical system, especially when working on the battery.
- If working inside the engine compartment, remember that, even when the ignition is switched off, the radiator fan may start up automatically, and therefore there is a risk of injury.
- Never cover the engine with additional insulating materials such as a blanket. Risk of fire!
- Do not unscrew the cap on the coolant expansion tank when the engine is hot. The cooling system is under pressure.
- Protect face, hands and arms by covering the cap with a large, thick rag to protect against escaping coolant and steam.
- If it is necessary to work in the engine compartment while the engine is running, the rotating components (for example, poly-V belt, alternator, radiator fan) and the high voltage ignition system are an additional hazard.
- Observe the following additional warnings if work on the fuel system or the electrical system is necessary:
 - Always disconnect the battery from the on-board network.
 - Do not smoke.
 - Never work near naked flames.
 - Always keep an approved fire extinguisher immediately available.

⚠ CAUTION

When topping up fluids make sure the correct fluid is put into the correct filler opening, otherwise this can cause serious malfunctions or engine damage.

🌿 For the sake of the environment

Inspect the ground underneath your vehicle regularly so that any leaks are detected at an early stage. If you find spots of oil or other fluids in the area where it was parked, have your vehicle inspected at the workshop.

ℹ Note

In right-hand drive vehicles* some brake fluid reservoirs are on the other side of the engine compartment» Fig. 247.

Opening the bonnet

Read the additional information carefully » 📖 page 17

The bonnet is released from inside the vehicle.

Check that the windscreen wiper arms are not unfolded. Otherwise the paint may be damaged.

The bonnet can only be unlocked when the driver door is open.

⚠ WARNING

Never open the bonnet if you see steam or drips of coolant being released from the engine compartment. Failure to comply could result in burns. Wait until no steam or coolant can be seen before opening the bonnet.

Closing the bonnet

- Slightly lift the bonnet.
- Release the bonnet stay before pressing it back into its support.
- Carefully close the bonnet.
- Press the bonnet down until it locks into place.
- Make sure that the bonnet catches onto its clasp. *Do not press down too hard* » ⚠.

⚠ WARNING

- For safety reasons the bonnet must always be completely closed when the vehicle is moving. Therefore, after closing the bonnet, always check that the locking element is properly engaged. This is the case if the bonnet is flush with the adjacent body panels.
- Should you notice that the bonnet is not safely secured when the vehicle is moving, stop the vehicle immediately and close the bonnet. Failure to follow this instruction could result in an accident.

Engine oil


General notes

The engine comes with a special, multi-grade oil that can be used all year round.

Because the use of high-quality oil is essential for the correct operation of the engine and its long useful life, when topping up or changing oil, use only those oils that comply with VW standards.

The specifications (VW standards) set out in the following page should appear on the container of the service oil; when the container displays the specific standards for petrol and diesel engines together, it means that the oil can be used for both types of engines.

We recommend that the oil change indicated in the Maintenance Programme, be performed by a technical service or specialised workshop.

The correct oil specifications for your engine are listed in the  **page 60, Engine oil specifications.**

Service intervals

Service intervals can be flexible (LongLife service) or fixed (dependent on time/distance travelled).



If the PR code that appears on the back of the Maintenance Programme booklet is PR Q16,

this means that your vehicle has the LongLife service programmed. If it lists the codes Q11, Q12, Q13, Q14 or Q17, the interval service is dependent on time/distance travelled.


Flexible service intervals (LongLife service intervals*)


Special oils and processes have been developed which, depending on the characteristics and individual driving profiles, enable the extension of the oil change service (LongLife service intervals).


Because this oil is essential for extending the service intervals, it **must only** be used observing the following indications:

- Avoid mixing it with oil for fixed service intervals.
- Only in exceptional circumstances, if the engine oil level is too low  **page 273** and LongLife oil is not available, it is permitted to top up (once) with oil for **fixed service intervals**  **page 60** (up to a maximum of 0.5 litres).

Fixed service intervals*

If your vehicle does not have the “LongLife service interval” or it has been disabled (by request), you may use oils for **fixed service intervals**, which also appear in  **page 60, Engine oil specifications.** In this case, your vehicle must be serviced after a fixed interval of 1 year/15,000 km (10,000


miles)(whatever comes first)  **Booklet Maintenance Programme.**

- In exceptional circumstances, if the engine oil level is too low  **page 273** and you cannot obtain the oil specified for your vehicle, you can add a small quantity of oil conforming to the specification ACEA A2 or ACEA A3 (petrol engines) or ACEA B3 or ACEA B4 (diesel engines) (up to 0.5 l).

Vehicles with diesel particulate filter*

The Maintenance Programme states whether your vehicle is fitted with a diesel particulate filter.

Only VW 507 00 engine oil, with reduced ash formation, may be used in diesel engines equipped with particulate filter. Using other types of oil will cause a higher soot concentration and reduce the life of the DPF. Therefore:

- Avoid mixing this oil with other engine oils.
- Only in exceptional circumstances, if the engine oil level is too low  **page 273**, **Checking engine oil level** and you cannot obtain the oil specified for your vehicle, you can use a small quantity of oil (once) conforming to the VW 506 00, VW 506 01, VW 505 00, VW 505 01 or ACEA B3/ACEA B4 specification (up to 0.5 l).

Checking engine oil level

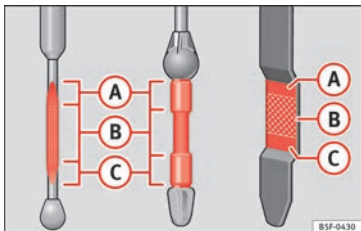


Fig. 248 Engine oil dipstick.

Read the additional information carefully

» page 59

The engine oil dipstick indicates the level of the oil.

Checking oil level

- Park the vehicle in a horizontal position.
- Briefly run the engine at idle speed until the operating temperature is reached and then stop.
- Wait for about two minutes.
- Pull out the dipstick. Wipe the dipstick with a clean cloth and insert it again, pushing it in as far as it will go.
- Then pull it out once more and check the oil level » **Fig. 248**. Top up with engine oil if necessary.

Depending on how you drive and the conditions in which the vehicle is used, oil consumption can be up to 0.5 l/1000 km. Oil consumption is likely to be higher for the first 5,000 km. For this reason the engine oil level must be checked at regular intervals, preferably when filling the tank and before a journey.

WARNING

Any work carried out in the engine compartment or on the engine must be carried out cautiously.

- When working in the engine compartment, always observe the safety warnings » page 270.

CAUTION

If the oil level is above area , do not start the engine. This could result in damage to the engine and catalytic converter. Contact a Technical Service.

Topping up engine oil



Fig. 249 In the engine compartment: Engine oil filler cap.

Read the additional information carefully

» page 59

Before opening the bonnet, read and observe the warnings » in **Working in the engine compartment** on page 270.

The position of the oil filler opening is shown in the corresponding engine compartment illustration » page 270.

Engine oil specification » page 60.

WARNING

Oil is highly inflammable! Ensure that no oil comes into contact with hot engine components when topping up.

ⓘ CAUTION

If the oil level is above area » Fig. 248 (A), do not start the engine. This could result in damage to the engine and catalytic converter. Contact a specialised workshop.

🌿 For the sake of the environment

The oil level must never be above area » Fig. 248 (A). Otherwise oil can be drawn in through the crankcase breather and escape into the atmosphere via the exhaust system.

📘 Note

Before a long trip, we recommend finding an engine oil that conforms to the corresponding VW specifications and recommend keeping it in the vehicle. This way, the correct engine oil will always be available for a top-up if needed.

Changing engine oil

Read the additional information carefully » 📖 page 59.

The engine oil must be changed at the intervals given in the service schedule.

We recommend that you have the engine oil changed by a Technical Service.

The oil change intervals are shown in the Maintenance Programme.

⚠️ WARNING

Only change the engine oil yourself if you have the specialist knowledge required!

- Before opening the bonnet, read and observe the warnings » page 270.
- Wait for the engine to cool down. Hot oil may cause burn injuries.
- Wear eye protection to avoid injuries, such as acid burns, caused by splashes of oil.
- When removing the oil drain plug with your fingers, keep your arm horizontal to help prevent oil from running down your arm.
- Wash your skin thoroughly if it comes into contact with engine oil.
- Engine oil is poisonous! Used oil must be stored in a safe place out of the reach of children.

ⓘ CAUTION

No additives should be used with engine oil. This could result in engine damage. Any damage caused by the use of such additives would not be covered by the factory warranty.

🌿 For the sake of the environment

- Because of disposal problems and the special tools and specialist knowledge required, we recommend that you have the engine oil and filter changed by a Technical Service.
- Never pour oil down drains or into the ground.

- Use a suitable container when draining the used oil. It must be large enough to hold all the engine oil.

Cooling system**Topping up coolant**

Read the additional information carefully » 📖 page 60

Top up coolant when the level is below the MIN (minimum) mark.

Checking coolant level

- Park the vehicle in a horizontal position.
- Switch the ignition off.
- Read off the coolant level on coolant expansion tank. When the engine is cold, the coolant level should be between the marks. When the engine is hot, it may be slightly above the upper mark.

Topping up coolant

- Wait for the engine to cool down.
- Cover the coolant expansion tank cap with a cloth and carefully unscrew it to the left » ⚠️.
- Top up the coolant only if there is still coolant in the expansion tank, otherwise you

could **damage the engine**. If there is no coolant in the expansion tank, do not continue driving. You should obtain professional assistance » ❶.

- If there is still some coolant in the expansion tank, top up to the upper mark.
- Top up with coolant until the level becomes stable.
- Screw the cap back on correctly.

Any loss of coolant fluid normally indicates a leak in the cooling system. Take the vehicle straight to a specialised workshop to have the cooling system examined. If there are no leaks in the engine cooling system, a loss of coolant can only occur if the coolant boils and is forced out of the system as a result of overheating.

WARNING

- The cooling system is under pressure. Do not unscrew the cap on the coolant expansion tank when the engine is hot: risk of burns!
- The antifreeze and coolant fluid can be a health hazard. Therefore, the antifreeze should be stored in the original container in a safe place out of reach of children. Failure to comply could result in poisoning.
- If working inside the engine compartment, remember that, even when the ignition is switched off, the radiator fan may start up au-

tomatically, and therefore there is a risk of injury.

WARNING

If there is not enough anti-freeze in the coolant system, the engine may fail leading to serious damage.

- Please make sure that the percentage of additive is correct with respect to the lowest expected ambient temperature in the zone in which the vehicle is to be used.
- When the outside temperature is very low, the coolant could freeze and the vehicle would be immobilised. In this case, the heating would not work either and inadequately dressed passengers could die of cold.

CAUTION

Do not top up the expansion tank with coolant fluid if it is empty! Air could enter the cooling system. In this case, stop driving. Seek specialist assistance. Otherwise, there is a risk of engine damage.

CAUTION

The original additives should never be mixed with coolants which are not approved by SEAT. Otherwise, you run the risk of causing severe damage to the engine and the engine cooling system.

- If the fluid in the expansion tank is not purple but is, for example, brown, this indicates


that the G13 additive has been mixed with an inadequate coolant. The coolant must be changed as soon as possible if this is the case! This could result in serious faults and engine damage.

For the sake of the environment

Coolants and additives can contaminate the environment. If any fluids are spilled, they should be collected and correctly disposed of, with respect to the environment.

Brake fluid

Top up brake fluid

Read the additional information carefully »  page 61

Checking the brake fluid level

The brake fluid level must be between the MIN and MAX markings.

However, if the brake fluid level goes down noticeably in a short time, or drops below the MIN mark, there may be a leak in the brake system. Seek specialist assistance. A warning light on the instrument panel display monitors the brake fluid level » page 119. »

In right-hand drive vehicles the brake fluid reservoir is on the other side of the engine compartment.

Changing brake fluid

The regular intervals at which the brake fluid should be replaced are listed in the Maintenance Programme. We recommend you have it replaced at a SEAT Official Service, during an Inspection Service.

WARNING

- Brake fluid should be stored in the closed original container in a safe place out of reach of children. Risk of poisoning!
- If the brake fluid is left in the system for too long and the brakes are subjected to heavy use, vapour bubbles may form in the brake system. This would seriously affect the efficiency of the brakes and the safety of the vehicle. This may cause an accident.

CAUTION

Brake fluid should not come into contact with the vehicle paintwork, as it is abrasive.




Windscreen washer reservoir

Checking and topping up the windscreen washer reservoir

Read the additional information carefully  page 61

Check the water level in the windscreen washer reservoir regularly and top up as required.

The container for the windscreen washer contains the cleaning fluid for the windscreen, the rear window and the headlight washer system*.

- Open the bonnet   page 270.
- The windscreen washer reservoir is marked with the symbol  on the cap.
- Check there is enough windscreen water in the reservoir.

Recommended windscreen wipers

- For the hottest seasons we recommend summer G 052 184 A1 for clear glass. Proportions of the mixture in the washer fluid tank: 1:100 (1 part concentrate per 100 parts water).
- All year round, G 052 164 A2 for clear glass. Approximate proportion of the winter mixture, up to -18°C (0°F): 1:2 (1 part concentrate per 2 parts water); otherwise, a 1:4

proportion of mixture in the washer fluid tank.

Capacity

The reservoir holds approximately 3 litres in versions without headlight washer and 5 litres in versions with headlight washer.

WARNING

If the water from the windscreen washer does not contain enough anti-freeze, it may freeze on the windscreen and rear window, reducing forward and rear visibility.

- In winter, ensure the windscreen washer contains enough anti-freeze.
- In cold conditions, you should not use the windscreen wiper system unless you have warmed the windscreen with the ventilation system. The antifreeze could freeze on the windscreen and reduce visibility.

WARNING

Never mix an unsuitable antifreeze or other similar additives with the windscreen washer water. A greasy layer may be formed on the windscreen which will impair visibility.


- Use clean water with a window cleaner recommended by SEAT.
- If necessary, add a suitable antifreeze to the water in the reservoir.

ⓘ CAUTION

- Do not mix cleaning products recommended by SEAT with other products. This could lead to flocculation and may block the windscreen washer jets.
- When topping up service fluids, make absolutely certain that you fill the fluids into the correct reservoirs. Using the wrong fluids could cause serious malfunctions and engine damage!
- Not having windscreen wiper fluid reduces visibility through the windscreen, and leads to loss of visibility in headlights in models with headlight washer.

Battery

General information

Read the additional information carefully
»  page 61.

The battery is located in the engine compartment and is almost **maintenance-free**. It is checked as part of the Inspection Service. Nevertheless, check the terminals are clean and have the correct tightening torque, especially in summer and winter.

Disconnecting the battery

The battery should only be disconnected in exceptional cases. When the battery is dis-

connected, some of the vehicle's functions are "lost" (» table on page 277). These functions will require resetting after the battery is reconnected.


Deactivate the anti-theft alarm* before you disconnect the battery. Otherwise the alarm will be triggered.

Function	Reprogramming
One-touch function of the electric windows	» page 138, One-touch opening and closing*.
Remote control key	If the vehicle does not respond to the key, they should be synchronised » page 132.
Digital clock	» page 116.
ESC warning lamp	After driving for a few metres, the warning lamp goes out again.

If the vehicle is not used for long periods

The vehicle has a system for monitoring the current consumption when the engine is left unused for long periods of time » page 201. Some functions, such as the interior lights, or the remote door opening, may be temporarily disabled to prevent the battery from running flat. These functions will come back on as soon as the ignition is switched on and the engine started.






Winter conditions

During the winter, the starting power may be reduced, and if necessary, the battery should be charged »  in Important safety warnings for handling a vehicle battery on page 278

Important safety warnings for handling a vehicle battery

All work on batteries requires specialist knowledge. Please refer to a SEAT Official Service or a workshop specialising in batteries: risk of burns or exploding battery!

The battery must not be opened. Never try to change the fluid level of the battery. Otherwise explosive gas is released from the battery that could cause an explosion.

-  Wear eye protection.
-  Battery acid is very corrosive and caustic. Wear protective gloves and eye protection. In the event of electrolyte splashes, rinse off with plenty of water.
-  Fires, sparks, open flames and smoking are prohibited.
-  The battery should only be charged in a well-ventilated zone. Risk of explosion!
-  Keep children away from acid and batteries! »

⚠ WARNING

- When repairing or working on the electrical system, proceed as follows:
 - 1. Remove the key from the ignition. The negative cable on the battery must be disconnected.
 - 2. When the repair is finished, reconnect the negative pole of the battery.
- Switch off all electrical devices before reconnecting the battery. Reconnect first the positive cable and then the negative cable. Never reverse the polarity of the connections. This could cause an electrical fire.
- Ensure that the vent hose is always connected to the battery.
- Never use damaged batteries. This could cause an explosion! Replace a damaged battery immediately.

⚠ CAUTION

- Never disconnect the battery if the ignition is switched on or if the engine is running. This could damage the electrical system or electronic components.

Charging the battery

Terminals for charging the battery are fitted in the engine compartment.

- Note the warnings **»»** **⚠** in Important safety warnings for handling a vehicle battery on page 278 and **»»** **⚠**.
- Switch off all electrical devices. Remove the ignition key.
- Raise the bonnet **»»** page 271.
- Open the battery cover.
- Connect the charger clamps as described to the **positive pole of the battery (+)** and exclusively to an **earth on the bodywork (-)**.
- Only use a charger which is compatible for use with 12 V nominal voltage batteries. The charge must not exceed a voltage of 15 V.
- Now connect the battery charger to the power socket and switch on.
- After charging the battery: switch off the battery charger and disconnect the power socket cable.
- Finally disconnect the charger cables from the battery.
- Replace the battery cover correctly.
- Close the bonnet **»»** page 271.

Important: Before you charge the battery make sure you read the manufacturer's instructions for using the battery charger.

⚠ WARNING

Never charge a battery that has frozen: replace battery! Failure to do so may lead to an explosion.

i Note

Use only the terminals in the engine compartment to charge the battery.

Replacing the battery

The new battery should have the same specifications (amperage, load and voltage) as the used battery.

Your vehicle is equipped with an intelligent power management system to control the distribution of electrical energy **»»** page 201. The power management function ensures that the battery is charged much more efficiently than on vehicles without a power management system. To maintain this function after replacing the battery, we recommend that the replacement battery used is of the same make and type as the original fitted battery. To make proper use of the power management function after the battery has been changed, have the battery coded to the power management mode at a specialised workshop.

ⓘ CAUTION

- Some vehicles, for example those with the Start-Stop system* are fitted with a special battery (AGM-type or EFB-type battery). If any other type of battery is fitted, the Start-Stop function may be considerably reduced and the vehicle may not stop on repeated occasions.
- Make sure that the vent hose is always attached to the original opening on the side of the battery. Gases or battery acid can otherwise escape and possibly cause damage.
- The battery holder and clamps must always be correctly secured.
- Before starting any work on the battery, always observe the warnings listed under »» page 277, Important safety warnings for handling a vehicle battery.
- Do not forget to replace the battery coverings, where applicable. It is a protection for high temperatures. This in turn extends the vehicle service life.

🌿 For the sake of the environment

⚠ Batteries contain toxic substances including sulphuric acid and lead. They must be disposed of appropriately and must not be disposed of with ordinary household waste. Make sure disconnected batteries cannot tip over. Sulphuric acid could be spilt!

Wheels

Wheels and tyres

General notes

- When driving with **new tyres**, be especially careful during the first 500 km (300 miles).
- If you have to drive over a kerb or similar obstacle, drive very slowly and as near as possible at a right angle to the obstacle.
- Check from time to time if the tyres are damaged (punctures, cuts, cracks or dents). Remove any foreign objects embedded in the treads.
- Damaged wheels and tyres must be replaced immediately.
- Keep grease, oil and fuel off the tyres.
- Replace any missing valve caps as soon as possible.
- Mark the wheels before taking them off so that they rotate in the same direction when put back.
- When removed, the wheels or tyres should be stored in a cool, dry and preferably dark place.

New tyres

New tyres do not give maximum **grip** straight away and should therefore be “run in” by

driving carefully and at moderate speeds for about the first 500 km (300 miles). This will also increase the useful life of the tyres.

The **tread depth** of new tyres may vary, according to the type and make of tyre and the tread pattern.

Concealed damage

Damage to tyres and rims is often not readily visible. If you notice unusual **vibration** or the car **pulling to one side**, this may indicate that one of the tyres is damaged. Reduce speed immediately if there is any reason to suspect that damage may have occurred. Inspect the tyres for damage. If no external damage is visible, drive slowly and carefully to the nearest specialised workshop and have the car inspected.

Tyres with directional tread pattern

An arrow on the tyre sidewall indicates the direction of rotation on single drive tyres. Always note the direction of rotation indicated when mounting the wheel. This guarantees optimum grip and helps to avoid aquaplaning, excessive noise and wear.

Retrofitting accessories

If you wish to change or fit wheels, rims or wheel trims, we recommend that you consult with a SEAT Official Service centre for advice regarding current techniques.

Service life of tyres

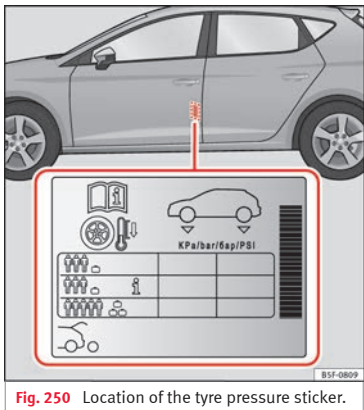


Fig. 250 Location of the tyre pressure sticker.

Correct inflation pressures and sensible driving habits will increase the useful life of your tyres.

- Check tyre pressure at least once a month, and also prior to any long trip.
- The tyre pressure should only be checked when the tyres are *cold*. Do not reduce the pressure of warm tyres.
- Adjust tyre pressure to the load being carried by the vehicle.

- In vehicles with a tyre pressure indicator, save the modified tyre pressure
»» page 283.
- Avoid fast cornering and hard acceleration.
- Inspect the tyres for irregular wear from time to time.

The useful life of your tyres depends on the following factors:

Tyre pressure

Tyre pressure values are indicated on the sticker on the inside of the fuel tank flap

»» Fig. 250.

Insufficient or excessive pressure greatly reduces the useful life of the tyres and adversely affects vehicle performance and ride. Correct inflation pressures are very important, especially at **high speeds**.

Depending on the vehicle, tyre pressure can be adjusted to medium load to improve driving comfort (tyre pressure **i**). When driving with comfort tyre pressure fuel consumption may increase slightly.

The tyre pressure must be adjusted according to the load the vehicle is carrying. If the vehicle is going to carry the maximum load, the tyre pressure should be increased to maximum value indicated on the sticker on the inside of the fuel tank flap.

Do not forget the spare wheel when checking the tyre pressures: Keep this spare wheel inflated to the highest pressure required for the road wheels.

In the case of a minimised temporary spare wheel (125/70 R16 or 125/70 R18) inflate to a pressure of 4.2 bar as indicated on the tyre pressure label on the fuel tank flap.

Driving style

Fast cornering, heavy acceleration and hard braking (squealing tyres) all increase tyre wear.

Wheel balance

The wheels on new vehicles are balanced. However, certain circumstances may lead to imbalance (run-out), which is detected as vibrations in the steering wheel.

Unbalanced wheels should be rebalanced, as they otherwise cause excessive wear on steering, suspension and tyres. A wheel must also be rebalanced when a new tyre is fitted or if a tyre is repaired.

Incorrect wheel alignment

Incorrect running gear alignment causes excessive tyre wear, impairing the safety of the vehicle. If you notice excessive tyre wear, you should check wheel alignment at a SEAT Official Service.

⚠ WARNING

- Always adapt the tyre pressure accordingly when the vehicle load changes.
- A tyre with low air pressure has to flex a lot more when the vehicle is heavily loaded or at high speeds, therefore causing overheating to occur. Under these conditions, the tyre bead may be released or the tyre may burst. Risk of accident!

🌿 For the sake of the environment

Under-inflated tyres will increase fuel consumption.

Wear indicators

Fig. 251 Tyre tread: tread wear indicators

Tread wear indicators indicate if a tyre is worn.

The original tyres on your vehicle have 1.6 mm high “tread wear indicators” running across the tread. Depending on the manufacturer, there will be 6 to 8 of them spaced at equal distances around the tyre. Markings on the tyre sidewall (for instance the letters “TWI” or a triangle) indicate the positions of the tread wear indicators.

The minimum tread depth required by law is 1.6 mm (measured in the tread grooves next to the tread wear indicators). (Different figures may apply in other countries.)

⚠ WARNING

The tyres must be replaced at the latest when the tread is worn down to the tread wear indicators. Failure to follow this instruction could result in an accident.

- Especially in difficult driving conditions such as wet or icy roads. It is important that the tyre tread be as deep as possible and be approximately the same on the tyres of both the front and the rear axles.
- The scant driving safety due to insufficient tread depth is particularly evident in vehicle handling, when there is a risk of “aquaplaning” in deep puddles of water and when driving through corners, and braking is also adversely affected.
- The speed has to be adapted accordingly, otherwise there is a risk of losing control over the vehicle.

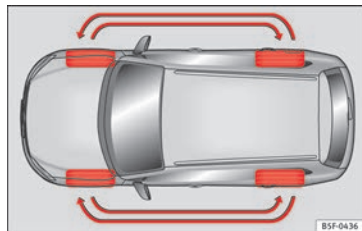
Interchanging tyres

Fig. 252 Interchanging tyres.


To ensure that the wear is equal on all tyres the wheels should be changed round from time to time according to the system **»» Fig. 252**. The useful life of all the tyres will then be about the same time.

New tyres or new wheels

- All four wheels must be fitted with tyres of the same type, size (rolling circumference) and preferably the same tread pattern.
- Tyres should be replaced at least in pairs and not individually (i.e. both front tyres or both rear tyres together).
- Do not use tyres whose effective size exceeds the dimensions of the factory-approved makes of tyre.

»»

– If you wish to fit the vehicle with rims or tyres different to those installed in manufacture, it is advisable to consult a SEAT Official Service **before** purchasing them.

The tyres and wheel rims are an essential part of the vehicle's design. The tyres and rims approved by SEAT are specially matched to the characteristics of the vehicle and make a major contribution to good roadholding and safe handling »» .

The sizes of the rims and tyres approved for your vehicle are listed in the vehicle documentation (e.g. EC Certificate of Conformity or COC document¹⁾). The vehicle documentation varies depending on the country of residence.

A knowledge of tyre designations makes it easier to choose the correct tyres. The following wording can be read on the sides of the tyre:

205/55 R16 91V

This contains the following information:

205	Tyre width in mm
55	Height/width ratio in %
R	Tyre construction: Radial
16	Rim diameter in inches


91	Load rating code
V	Speed index

The **manufacturing date** is also indicated on the tyre sidewall (possibly only on the outer part):

DOT . . . 2216 . . .

it means, for example, that the tyre was manufactured in the 22nd week of 2016.

But note that with some types of tyre, the actual tyre size can differ from the nominal size marked on the tyre (for instance 205/55 R 16 91 V), and there may be significant differences in the contours of the tyres, even though the tyres are marked with the same nominal size designation. When replacing the tyres, it is therefore important to make sure that the actual size of the new tyres does not exceed the dimensions of the factory-approved makes of tyre.

Failure to observe this requirement can affect the clearance needed for the tyres. If the tyres rub against the bodywork, in certain circumstances the tyres, running gear or bodywork and pipes may be damaged, and vehicle safety could be severely impaired »» .

If you use tyres that are approved by SEAT you can be sure that the actual tyre dimen-

sions will be correct for your vehicle. If you decide to fit a different type of tyre, you must obtain the appropriate manufacturer's certificate from the tyre retailer to confirm that the tyres are suitable for your vehicle. Keep this certificate in a safe place.

Your SEAT Official Service will be able to advise you on which tyres may be fitted to your vehicle.

It is best to have all servicing of wheels and tyres performed by a **specialised workshop**. They are familiar with the procedure and have the necessary special tools and spare parts as well as the proper facilities for disposing of the old tyres respecting the environment.

WARNING

- It is very important to ensure that the tyres you have chosen have adequate clearance. When selecting replacement tyres, do not rely entirely on the nominal tyre size marked on the tyre, since the effective tyre size can differ significantly depending on the manufacturer. Inadequate tyre clearance can result in damage to the tyres or the vehicle, causing a serious safety risk. Risk of accident! It may also invalidate the vehicle's registration for use on public roads.

¹⁾ COC = *certificate of conformity*.

- Avoid running the vehicle on tyres that are more than 6 years old. If you have no alternative, you should drive slowly and with extra care at all times.
- If wheel trims are fitted after the car is purchased, ensure that there is an adequate flow of air for cooling the brake system.

For the sake of the environment

Old tyres must be disposed of according to the laws in the country concerned.

Note


- A SEAT Service Centre should be consulted to find out whether wheels or tyres of different sizes to those originally fitted by SEAT can be fitted, and to find out about the combinations allowed between the front axle (axle 1) and the rear axle (axle 2).
- Never mount used tyres if you are not sure of their “previous history”.
- For technical reasons, it is not generally possible to use the wheels from other vehicles. In some cases, this may also be true for the same model of wheel.

Wheel bolts

The **wheel bolts** are matched to the rims. When installing different wheels (for instance alloy wheels or wheels with winter tyres) it is important to use the correct wheel bolts with

the right length and correctly shaped bolt heads. This ensures that wheels are fitted securely and that the brake system functions correctly.

The wheel bolts must be clean and turn easily.

A special adapter is required to turn the anti-theft wheel bolts* »  page 67.

Tyre monitoring systems

Introduction

WARNING

Unsuitable handling of the wheels and tyres may lead to sudden tyre pressure losses, to tread separation or even to a blow-out.

- Check tyre pressures regularly and ensure they are maintained at the pressures indicated. Tyre pressure that is too low could cause overheating, resulting in tread detachment or even burst tyres.
- Tyre pressure should be that indicated on the label when the tyres are cold at all times » page 291.
- Regularly check the cold inflation pressure of the tyres. If necessary, change the tyre pressure of the vehicle tyres while they are cold.

- Regularly check your tyres for damage and wear.
- Never exceed the maximum permitted speed or loads specified for the type of tyre fitted on your vehicle.

For the sake of the environment

Under-inflated tyres lead to increased fuel consumption and tyre wear.

Note

- Driving for the first time with new tyres at a high speed can cause them to slightly expand, which could then produce an air pressure warning.
- Only replace used tyres with those authorised by SEAT for the corresponding type vehicle.
- Do not only rely on the tyre monitoring system. Regularly check your tyres to ensure that the tyre pressure is correct and that the tyres are not damaged due to puncture, cuts, tears and impacts/dents. Remove objects from the tyres only when they have not pierced the tyres.

Tyre monitoring control lamp

If a light appears



The pressure in one or more tyres has clearly reduced in comparison to the tyre pressure set by the driver or the tyre has structural damage.

Additionally, an audible warning can be heard and a text message can be seen on the instrument panel display.

Stop! Reduce speed immediately! Stop the vehicle safely as soon as possible. Avoid sudden manoeuvres and braking! Check all tyres and pressures. Replace any damaged tyres.

If flashing



System malfunction

The control lamp flashes for approximately one minute and then lights up permanently.


If tyre pressure is correct, switch the ignition off and on again. If the control lamp remains lit up, the tyre monitoring indicator can be calibrated. Have the system checked by a specialised workshop.

Several warning and control lamps light up for a few seconds when the ignition is switched on while the function is verified. They will switch off after a few seconds.

WARNING


When the tyres are inflated at different pressures or at a pressure that is too low then a tyre may be damaged resulting in a loss of

control of the vehicle and a serious or fatal accident.

- If the warning lamp  lights up, stop immediately and check the tyres.
- If the tyres are inflated at different pressures or if a tyre pressure is too low, this will increase tyre wear, negatively affecting vehicle stability and increasing braking distances.
- If tyres are inflated at different pressures or a tyre pressure is too low, a tyre may be damaged and burst resulting in a loss of control of the vehicle.
- The driver is responsible for ensuring that all of the vehicle tyres are correctly inflated to the right pressure. The recommended tyre pressure is indicated on the label
»» page 291.
- The tyre monitoring system can only operate correctly if all of the tyres are inflated to the correct pressure when cold.
- Driving with tyres at the wrong pressure can damage them and result in an accident. Ensure that the tyre pressures of all the tyres correspond to the vehicle load.
- Before starting a journey, always inflate tyres to the correct pressure.
- Tyres with insufficient pressure are subjected to more flexing. Due to this, the tyre could become excessively hot, causing tread separation and also tyre blow-out.
- With an overloaded vehicle at high speed, the tyres can overheat and burst resulting in a loss of vehicle control.

- Tyre pressures which are too high or too low reduce the useful life of the tyre, affecting vehicle performance.
- If a tyre has not been punctured and it does not have to be changed immediately, drive to the nearest specialised workshop at a moderate speed and have the tyre checked and inflated to the correct pressure.

WARNING

Observe the safety warnings  in Warning and control lamps on page 119.

Note

- If excessively low tyre pressure is detected with the ignition on, an audible warning will sound. In the event that there is a fault in the system, an audible warning will sound.
- Driving on dirt tracks for a long period of time or driving in a sporty style can temporarily deactivate the TPMS. The control lamp shows a fault, but disappears when road conditions or the driving style change.

Tyre monitoring indicator

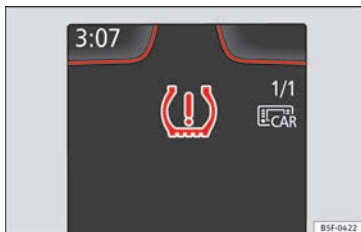


Fig. 253 Instrument panel: warning of loss of tyre pressure.

The tyre monitor indicator compares wheel revolutions and, with this information, the tread of each wheel using the ABS sensors. If the rolling circumference of one or more wheels has changed, the tyre monitoring indicator will indicate this on the instrument panel through a warning lamp and a warning to the driver»» **Fig. 253**. When only one specific tyre is affected, its position within the vehicle will be indicated.

(L) Loss of pressure: Check left tyre pressure!

Wheel tread change

The wheel tread changes when:

- Tyre pressure is manually changed
- Tyre pressure is insufficient
- Tyre structure is damaged
- The vehicle is unbalanced because of a load
- The wheels on an axle are subject to a heavier load (e.g. with a heavy load).
- The vehicle is fitted with snow chains
- The temporary spare wheel is fitted
- The wheel on one axle is changed

There may be a delay in the reaction of the tyre (L) monitoring indicator or it may not indicate anything under certain circumstances (e.g. sporty driving, snow-covered or unpaved roads, or when driving with snow chains).

Calibrating the tyre monitoring indicator



Fig. 254 Glove compartment: tyre control switch.

After changing the tyre pressure or replacing one or more wheels, the tyre monitoring indicator must be recalibrated. Do the same, for example, when the front and rear wheels are swapped.

- Switch the ignition on.
- Store the new tyre pressure in the Easy Connect system with the (CAR) button and the function button (Setup)»» **page 33** or using the switch located in the glove compartment¹⁾»» **Fig. 254**.
- *In vehicles without radio:* press and hold down the (L) SET button with the ignition on, until an acoustic signal is heard.

¹⁾ In vehicles without the Infotainment system:

When driving, the system self-calibrates the tyre pressure provided by the driver and the wheels fitted. After a long journey with varied speeds the programmed values are collected and monitored.

With the wheels under very heavy loads, the tyre pressure must be increased to the total recommended tyre pressure before the calibration » page 291.

Note

- The tyre monitoring indicator does not function when there is a fault in the ESC or ABS » page 187.
- An erroneous indication may be given when snow chains are in use because they increase the tread of the wheel.

Temporary spare wheel

General information

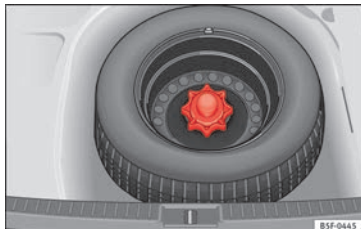


Fig. 255 Compact temporary spare wheel: raised floor panel.

The temporary spare wheel has been designed to be used for short periods of time. Have the tyres checked, and if necessary, replaced as soon as possible at a SEAT Official Service or at a specialised workshop.

Please note the following restrictions when using the compact temporary spare wheel. The compact temporary spare wheel is designed specifically for this model. For this reason, do not use a temporary spare wheel from a different type of vehicle.

Removing the temporary spare wheel

- Lift and hold up the floor panel to remove the temporary spare wheel » **Fig. 255**.

- Turn the thumb wheel anti-clockwise.
- Take out the temporary spare wheel.

Chains

For technical reasons, snow chains must not be used on the temporary spare wheel.

If you have a puncture on one of the front wheels when using snow chains, fit the temporary spare wheel in place of one of the rear wheels. Fit the snow chains on the rear wheel that you have removed and replace the punctured front wheel with this wheel.

WARNING

- After fitting the temporary spare wheel, check the tyre pressures as soon as possible. Failure to do so may cause an accident. The tyre pressures are listed on the inside of the fuel tank flap.
- Do not drive at over 80 km/h (50 mph) when the temporary spare wheel is fitted on the vehicle: risk of accident!
- Avoid heavy acceleration, hard braking and fast cornering: risk of accident!
- Never use more than one temporary spare wheel at the same time, risk of accident.
- No other type of tyre (normal summer or winter tyre) may be fitted on the compact temporary spare wheel rim.
- If you are driving using the spare wheel, the ACC system could automatically switch off during the journey. Switch off the system when starting off.

Extraction of the spare wheel in vehicles with SEAT SOUND 10 speakers (with subwoofer)*

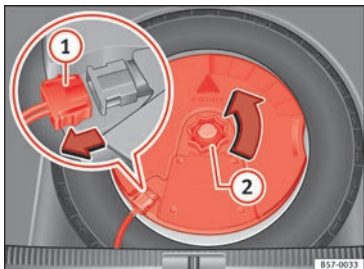


Fig. 256 In the luggage compartment: remove the subwoofer.

To remove the spare wheel, you must first remove the *subwoofer*.

- Disassemble the *subwoofer's* floor panel (carpet) as follows:
- *LEON/LEON SC model*: first, pull the carpet in the direction of the backrest and then pull it upwards to remove it. *LEON ST model*: lift and secure the floor storage compartment as explained in »» page 170.
- Disconnect the *subwoofer's* speaker cable »» Fig. 256 ①.

- Turn the securing wheel anti-clockwise ②.
- Remove the *subwoofer* speaker and the spare wheel.
- When re-mounting the spare tyre, place the *subwoofer* on the base of the wheel rim with care. When doing so, the tip of the “FRONT” arrow on the *subwoofer* should point forward.
- Reconnect the speaker cable and firmly rotate the securing wheel clockwise so that the *subwoofer* system and wheel are firmly in place.

Winter service

Winter tyres

- Winter tyres must be fitted **on all four** wheels.
- Only use winter tyres that are approved for your vehicle.
- Please note that the maximum permissible speed for winter tyres may be lower than for summer tyres.
- Also note that winter tyres are no longer effective when the **tread** is worn down.

- After fitting the wheels you must always check the tyre pressures. When doing so, take into account the correct tyre pressures listed on the rear of the front left door frame »» page 280.

In winter road conditions winter tyres will considerably improve vehicle handling. The design of summer tyres (width, rubber compound, tread pattern) gives less grip on ice and snow. This applies particularly to vehicles equipped with **wide section tyres** or with **high speed tyres** (code letters H, V or Y on the sidewall).

Only use winter tyres of the correct type approved for your vehicle. The sizes of these tyres are specified in the vehicle's documents (e.g. EC Certificate of Conformity or COC¹⁾). The vehicle documentation varies depending on the country of residence. See also »» page 281.

Winter tyres lose a great deal of their properties when the **tread** is worn down to a depth of 4 mm.

The performance of winter tyres is also severely impaired by **ageing**, even if the tread is still much deeper than 4 mm.

Winter tyres are subject to the following **maximum speed limits** according to speed rating code letter: »» ⚠

¹⁾ COC = certificate of conformity.

Speed rating code letter » page 281	Maximum speed limit
Q	160 km/h (100 mph)
S	180 km/h (112 mph)
T	190 km/h (118 mph)
H	210 km/h (130 mph)
V	240 km/h (149 mph) (please note relevant restrictions)
W	270 km/h (168 mph)
Y	300 km/h (186 mph)

Vehicles capable of exceeding these speeds must have an appropriate **sticker** attached so that it is visible to the driver. Suitable stickers are available from the SEAT Official Service and specialised workshop. Please note the regulations to this effect in your country.

“All-weather” tyres can also be used instead of winter tyres.

Using winter tyres with V-rating

Please note that the generally applicable 240 km/h (150 mph) speed rating for winter tyres with the letter V is subject to **technical restrictions; the maximum permissible speed for your vehicle may be significantly lower**. The maximum speed limit for these tyres depends directly on the maximum axle

weights for your car and on the listed weight rating of the tyres being used.

It is best to contact a SEAT Official Service to check the maximum speed which is permissible for the V-rated tyres fitted on your car on the basis of this information.

WARNING

Exceeding the maximum speed permitted for the winter tyres fitted on your car can cause tyre failure, resulting in a loss of control of the vehicle – risk of accident.

For the sake of the environment

Summer tyres should be fitted again as soon as possible after the winter period; they give better handling on roads which are free of snow and ice. Summer tyres perform with less rolling noise, tyre wear and – most important – reduce fuel consumption.

Technical data

Technical specifications

Important

The information in the vehicle documentation always takes precedence over the information in this Instruction Manual.

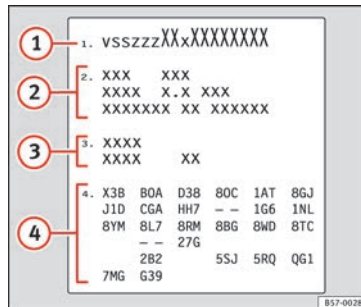
All technical specifications provided in this documentation are valid for the standard model in Spain. The vehicle data card included in the Maintenance Programme or the vehicle registration documents shows which engine is installed in the vehicle.

The figures may be different depending whether additional equipment is fitted, for different models, for special vehicles and for other countries.

Abbreviations used in the Technical Specifications section

kW	Kilowatt, engine power measurement.
PS	Pferdestärke (horsepower), formerly used to denote engine power.
rpm	Revolutions per minute - engine speed.
Nm	Newton metres, unit of engine torque.
CZ	Cetane number, indication of the diesel combustion power.
RON	Research octane number, indication of the knock resistance of petrol.

Vehicle identification data



1	1. VSSZZZXXXXXXXXXXXX
2	2. XXX XXX XXXX X.X XXX XXXXXXXX XX XXXXXX
3	3. XXXX XXXX XX
4	4. X3B B0A D38 80C 1AT 8GJ J1D CGA HH7 -- 1G6 1NL 8YM 8L7 8RM 8BG 8WD 8TC -- 27G 2B2 5SJ 5RQ QG1 7MG 639

Fig. 257 Vehicle data sticker (luggage compartment).



Fig. 258 Chassis number.

VIN in the Easy Connect

- Select: **CAR** button > function button **SET-TINGS** > **Service** > **Chassis number**.

Chassis number

The VIN is located in the Easy Connect, on the vehicle data sticker and under the windscreen, on the driver side »» Fig. 258. Additionally, the chassis number is located in the engine compartment, on the right-hand side. The number is engraved on the top side rail, and is partially covered.

Identification plate

The type plate is located on the right side door pillar. Vehicles for certain export countries do not have a type plate.

Vehicle data label

The vehicle data sticker is under the carpet trim in the luggage compartment, in the spare wheel well. A sticker with the vehicle data is attached to the inside cover of the Maintenance Programme.

The following information is provided on the vehicle data sticker: » Fig. 257

- ① Vehicle identification number (chassis number)
- ② Vehicle type, model, capacity, engine type, finish, engine power and gearbox type
- ③ Engine code, gearbox code, external paint code and internal equipment code
- ④ Optional extras and PR numbers

Identifying letters

The identifying letters of the engine can be viewed on the instrument panel when the engine is switched off and the ignition is on.

- Hold down the button **0.0/SET** on the dash panel for more than 15 seconds.

Fuel consumption data

Fuel consumption

Approved consumption values are derived from measurements performed or supervised by certified EU laboratories, according to the legislation in force at the time (for more information, see the Publications Office of the European Union on the EUR-Lex website: © European Union, <http://eur-lex.europa.eu/>) and apply to the specified vehicle characteristics.

The values relating to fuel consumption and CO₂ emissions can be found in the documentation provided to the purchaser of the vehicle at the time of purchase.

Fuel consumption and CO₂ emissions depend on the equipment/features of each individual vehicle, as well as on the driving style, road conditions, traffic conditions, environmental conditions, load or number of passengers.

Note

In practice, and considering all the factors mentioned here, consumption values can differ from those calculated in the current European regulations.

Weights

Kerb weight refers to the basic model with a fuel tank filled to 90% capacity and without

optional extras. The figure quoted includes 75 kg to allow for the weight of the driver.

Special versions, optional equipment fittings or retro-fitting accessories will increase the weight of the vehicle » » » ⚠.

⚠ WARNING

- **Please note that the centre of gravity may shift when transporting heavy objects; this may affect vehicle handling and lead to an accident. Always adjust your speed and driving style to suit road conditions and requirements.**
- **Never exceed the gross axle weight rating or the gross vehicle weight rating. If the permissible axle load or the permissible total weight is exceeded, the driving characteristics of the vehicle may change, which could lead to accidents, injuries and damage to the vehicle.**

Trailer mode

Trailer weights

Trailer weight

The trailer weights and drawbar loads approved are selected in intensive trials according to precisely defined criteria. The approved trailer weights are valid for vehicles in the EU for maximum speeds of 80 km/h (50 mph) (in certain circumstances up to 100

km/h (62 mph)). The figures may be different in other countries. All data in the official vehicle documentation takes precedence over these data at all times »» ⚠.

Drawbar loads

The *maximum* permitted drawbar load on the ball joint of the towing bracket must not exceed **80 kg**.

In the interest of road safety, we recommend that you always tow approaching the maximum drawbar load. The response of the trailer on the road will be poor, if the drawbar load is too small.

If the maximum permissible drawbar load cannot be met (e.g. with small, empty and light-weight single axle trailers or tandem axle trailers with a wheelbase of less than 1 metre), a minimum of 4% of the actual trailer weight is legally required for the drawbar load.

⚠ WARNING

- For safety reasons, you should not drive at speeds above 80 km/h (50 mph) when towing a trailer. This also applies in countries where higher speeds are permitted.
- Never exceed the maximum trailer weights or the drawbar load. If the permissible axle load or the permissible total weight is exceeded, the driving characteristics of the vehicle may change, leading to accidents, injuries and damage to the vehicle.

Wheels

Tyre pressure, snow chains and wheel bolts

Tyre pressure

The sticker with the tyre pressure values can be found on the back of the left front door frame. The tyre pressure values given there are for *cold* tyres. The slightly raised pressures of warm tyres must not be reduced. »» ⚠

The pressure for *winter tyres* is 0.2 bar (2.9 psi / 20 kPa) higher than that of summer tyres.

Snow chains

Snow chains may be fitted only to the front wheels, and only for the following tyres:

195/65 R15	Chains with links of maximum 15 mm
205/55 R16	Chains with links of maximum 15 mm
205/50 R17	Chains with links of maximum 15 mm
225/45 R17	Chains with links of maximum 9 mm
225/40 R18	Chains with links of maximum 9 mm
225/35 R19	Chains with links of maximum 7 mm
205/55 R17	Snow chains are not permitted
225/45 R18	Snow chains are not permitted

Wheel bolts

After the wheels have been changed, the **tightening torque** of the wheel bolts should be checked as soon as possible with a torque wrench »» ⚠. The tightening torque for steel and alloy wheels is **120 Nm**.

⚠ WARNING

- Check the tyre pressure at least once per month. Checking the tyre pressure is very important. If the tyre pressure is too high or too low, there is an increased danger of accidents - particularly at high speeds.
- If the tightening torque of the wheel bolts is too low, they could loosen while the vehicle is in motion. Risk of accident! If the tightening torque is too high, the wheel bolts and threads can be damaged.

Note

We recommend that you ask your Technical Service for information about appropriate wheel, tyre and snow chain size.

Engine data

Petrol engine 1.2 63 kW (86 PS)

Power output in kW (PS) at rpm	Maximum torque (Nm at rpm)	No. of cylinders/displacement (cm ³)	Fuel
63 (86)/4,300-5,300	160/1,400-3,500	4/1,197	Super 95 RON/Normal 91 RON ^{a)}

a) Slight power loss.

Outputs and weights	LEON	LEON SC	LEON ST
Top speed (km/h)	178 (V)	178 (V)	178 (V)
Acceleration from 0-80 km/h (seconds)	7.6	7.5	7.8
Acceleration from 0-100 km/h (seconds)	11.9	11.8	12.1
Maximum authorised weight (kg)	1,700	1,700	1,800
Weight in running order (with driver) (kg)	1,188	1,168	1,233
Maximum authorised weight on front axle (kg)	890	880	870
Maximum authorised weight on rear axle (kg)	860	870	980
Permitted roof load (kg)	75	75	75
Maximum trailer weight without brakes (kg)	590	580	610
Weight of trailer with brakes on gradients up to 8% (kg)	1,300	1,300	1,300
Weight of trailer with brakes on gradients up to 12% (kg)	1,100	1,100	1,100

Technical specifications

Petrol engine 1.2 TSI 81 kW (110 PS)

Power output in kW (PS) at rpm	Maximum torque (Nm at rpm)	No. of cylinders/displacement (cm ³)	Fuel
81 (110)/4,600-5,600	175/1,400-4,000	4/1,197	Super 95 RON/Normal 91 RON ^{a)}

^{a)} Slight power loss.

Outputs and weights	LEON Manual	LEON Start-Stop	LEON Automatic	LEON SC Manual	LEON SC Start-Stop	LEON ST Manual	LEON ST Start-Stop	LEON ST Automatic
Top speed (km/h)	194 (V)	194 (V)	194 (V)	194 (V)	194 (V)	194 (V)	194 (V)	194 (V)
Acceleration from 0-80 km/h (seconds)	6.6	6.6	6.6	6.7	6.5	6.7	6.7	6.7
Acceleration from 0-100 km/h (seconds)	9.9	9.9	9.9	10.1	9.8	10.1	10.1	10.1
Maximum authorised weight (kg)	1,740	1,740	1,760	1,720	1,730	1,790	1,800	1,820
Weight in running order (with driver) (kg)	1,213	1,213	1,241	1,186	1,193	1,240	1,247	1,275
Maximum authorised weight on front axle (kg)	900	900	930	890	890	880	890	910
Maximum authorised weight on rear axle (kg)	890	890	880	880	890	960	960	960
Permitted roof load (kg)	75	75	75	75	75	75	75	75
Maximum trailer weight without brakes (kg)	600	600	620	590	590	620	620	630
Weight of trailer with brakes on gradients up to 8% (kg)	1,500	1,500	1,500	1,500	1,500	1,500	1,500	1,500
Weight of trailer with brakes on gradients up to 12% (kg)	1,300	1,300	1,300	1,300	1,300	1,300	1,300	1,300

Technical data

Petrol engine 1.6 MPI 81 kW (110 PS)

Power output in kW (PS) at rpm	Maximum torque (Nm at rpm)	No. of cylinders/displacement (cm ³)	Fuel
81 (110)/5,800	155/3,800-4,000	4/1,598	Super 95 RON/Normal 91 RON ^{a)}

a) Slight power loss.

Outputs and weights	LEON manual	LEON automatic	LEON SC manual	LEON SC automatic	LEON ST manual	LEON ST automatic
Top speed (km/h)	189 (IV)	185 (V)	189 (V)	185 (V)	189 (V)	185 (V)
Acceleration from 0-80 km/h (seconds)	6.7	7.4	6.6	7.5	6.9	7.6
Acceleration from 0-100 km/h (seconds)	10.5	11.4	10.4	11.6	10.8	11.8
Maximum authorised weight (kg)	1,740	1,770	1,710	1,730	1,790	1,830
Weight in running order (with driver) (kg)	1,192	1,230	1,175	1,210	1,228	1,275
Maximum authorised weight on front axle (kg)	880	920	880	910	870	910
Maximum authorised weight on rear axle (kg)	910	900	880	870	970	970
Permitted roof load (kg)	75	75	75	75	75	75
Maximum trailer weight without brakes (kg)	590	610	580	600	610	630
Weight of trailer with brakes on gradients up to 8% (kg)	1,400	1,400	1,400	1,400	1,400	1,400
Weight of trailer with brakes on gradients up to 12% (kg)	1,200	1,200	1,200	1,200	1,200	1,200

Technical specifications

Petrol engine 1.0 TSI 85 kW (115 PS)

Power output in kW (PS) at rpm	Maximum torque (Nm at rpm)	No. of cylinders/displacement (cm ³)	Fuel
85 (115)/5,000-5,500	200/2,000-3,500	3/999	Super 95 RON/Normal 91 RON ^{a)}

^{a)} Slight power loss.

Outputs and weights	LEON manual	LEON automatic	LEON SC manual	LEON SC automatic	LEON ST manual	LEON ST automatic
Top speed (km/h)	202	202	202	202	202	202
Acceleration from 0-80 km/h (seconds)	6.6	6.6	6.5	6.5	6.8	6.8
Acceleration from 0-100 km/h (seconds)	9.6	9.6	9.5	9.5	9.8	9.8
Maximum authorised weight (kg)	1,720	1,740	1,710	1,740	1,770	1,800
Weight in running order (with driver) (kg)	1,202	1,225	1,180	1,203	1,236	1,259
Maximum authorised weight on front axle (kg)	890	910	880	900	870	900
Maximum authorised weight on rear axle (kg)	880	880	880	890	950	950
Permitted roof load (kg)	75	75	75	75	75	75
Maximum trailer weight without brakes (kg)	600	610	590	600	610	620
Weight of trailer with brakes on gradients up to 8% (kg)	1,300	1,300	1,300	1,300	1,300	1,300
Weight of trailer with brakes on gradients up to 12% (kg)	1,000	1,000	1,000	1,000	1,000	1,000

Technical data

Petrol engine 1.4 92 kW (125 PS) Start-Stop

Power output in kW (PS) at rpm	Maximum torque (Nm at rpm)	No. of cylinders/displacement (cm ³)	Fuel
92 (125)/5,000-6,000	200/1,400-4,000	4/1,395	Super 95 RON/Normal 91 RON ^{a)}

^{a)} Slight power loss.

Outputs and weights	LEON	LEON SC	LEON ST	LEON ST X-PERIENCE
Top speed (km/h)	203 (V&V)	203 (V&V)	203 (V&V)	200 (V&V)
Acceleration from 0-80 km/h (seconds)	6.2	6.1	6.4	6.6
Acceleration from 0-100 km/h (seconds)	9.1	8.9	9.4	9.7
Maximum authorised weight (kg)	1,770	1,750	1,830	1,820
Weight in running order (with driver) (kg)	1,233	1,213	1,257	1,263
Maximum authorised weight on front axle (kg)	920	910	900	890
Maximum authorised weight on rear axle (kg)	900	890	980	980
Permitted roof load (kg)	75	75	75	75
Maximum trailer weight without brakes (kg)	610	600	620	630
Weight of trailer with brakes on gradients up to 8% (kg)	1,700	1,700	1,700	1,700
Weight of trailer with brakes on gradients up to 12% (kg)	1,400	1,400	1,400	1,400

Technical specifications

Petrol engine 1.4 TSI 110 kW (150 PS) ACT®

Power output in kW (PS) at rpm	Maximum torque (Nm at rpm)	No. of cylinders/displacement (cm ³)	Fuel
110 (150)/5,000-6,000	250/1,500-3,500	4/1,395	Super 95 RON/Normal 91 RON ^{a)}

a) Slight power loss.

Outputs and weights	LEON manual	LEON automatic	LEON SC manual	LEON SC automatic	LEON ST manual	LEON ST automatic
Top speed (km/h)	215 (V&V)	215 (V&V)	215 (V&V)	215 (V&V)	215 (V&V)	215 (V&V)
Acceleration from 0-80 km/h (seconds)	5.6	5.6	5.5	5.5	5.8	5.8
Acceleration from 0-100 km/h (seconds)	8	8	7.9	7.9	8.2	8.2
Maximum authorised weight (kg)	1,770	1,790	1,750	1,770	1,840	1,860
Weight in running order (with driver) (kg)	1,241	1,263	1,223	1,243	1,277	1,297
Maximum authorised weight on front axle (kg)	930	950	910	930	910	930
Maximum authorised weight on rear axle (kg)	890	890	890	890	980	980
Permitted roof load (kg)	75	75	75	75	75	75
Maximum trailer weight without brakes (kg)	620	630	610	620	630	640
Weight of trailer with brakes on gradients up to 8% (kg)	1,700	1,700	1,700	1,700	1,700	1,700
Weight of trailer with brakes on gradients up to 12% (kg)	1,500	1,500	1,500	1,500	1,500	1,500

Technical data

Petrol engine 1.4 TSI 110 kW (150 PS)

Power output in kW (PS) at rpm	Maximum torque (Nm at rpm)	No. of cylinders/displacement (cm ³)	Fuel
110 (150)/5,000-6,000	250/1,500-3,500	4/1,395	Super 95 RON/Normal 91 RON ^{a)}

^{a)} Slight power loss.

Outputs and weights	LEON manual	LEON automatic	LEON SC manual	LEON SC automatic	LEON ST automatic
Top speed (km/h)	215 (V&VI)	215 (V&VI)	215 (V&VI)	215 (V&VI)	215 (V&VI)
Acceleration from 0-80 km/h (seconds)	5.6	5.6	5.5	5.5	5.8
Acceleration from 0-100 km/h (seconds)	8	8	7.9	7.9	8.2
Maximum authorised weight (kg)	1,770	1,790	1,750	1,760	1,850
Weight in running order (with driver) (kg)	1,241	1,263	1,223	1,238	1,297
Maximum authorised weight on front axle (kg)	930	950	910	930	930
Maximum authorised weight on rear axle (kg)	890	890	890	880	970
Permitted roof load (kg)	75	75	75	75	75
Maximum trailer weight without brakes (kg)	620	630	610	610	640
Weight of trailer with brakes on gradients up to 8% (kg)	1,700	1,700	1,700	1,700	1,700
Weight of trailer with brakes on gradients up to 12% (kg)	1,500	1,500	1,500	1,500	1,500

Technical specifications

Petrol engine 1.8 132 kW (180 PS) Start-Stop

Power output in kW (PS) at rpm	Maximum torque (Nm at rpm)	No. of cylinders/displacement (cm ³)	Fuel
132 (180)/5,100-6,200	250/1,250-5,000	4/1,798	Super 95 RON/Normal 91 RON ^{a)}

a) Slight power loss.

Outputs and weights	LEON Manual	LEON Automatic	LEON Without Start-Stop	LEON SC Manual	LEON SC Automatic	LEON SC Without Start-Stop	LEON ST Manual	LEON ST Automatic
Top speed (km/h)	226 (VI)	224 (VI)	224 (VI)	226 (VI)	224 (VI)	224 (VI)	226 (VI)	224 (VI)
Acceleration from 0-80 km/h (seconds)	5.5	5.3	5.3	5.4	5.2	5.2	5.7	5.6
Acceleration from 0-100 km/h (seconds)	7.5	7.2	7.2	7.4	7.1	7.1	7.8	7.7
Maximum authorised weight (kg)	1,830	1,850	1,850	1,830	1,840	1,840	1,900	1,890
Weight in running order (with driver) (kg)	1,310	1,327	1,322	1,290	1,307	1,302	1,355	1,372
Maximum authorised weight on front axle (kg)	970	990	980	960	980	970	960	980
Maximum authorised weight on rear axle (kg)	910	910	920	920	910	920	990	960
Permitted roof load (kg)	75	75	75	75	75	75	75	75
Maximum trailer weight without brakes (kg)	650	660	660	640	650	650	670	680
Weight of trailer with brakes on gradients up to 8% (kg)	1,800	1,800	1,800	1,800	1,800	1,800	1,800	1,800
Weight of trailer with brakes on gradients up to 12% (kg)	1,500	1,500	1,500	1,500	1,500	1,500	1,500	1,500

Technical data

Petrol engine 1.8 TSI 132 kW (180 PS) All-wheel drive

Power output in kW (PS) at rpm	Maximum torque (Nm at rpm)	No. of cylinders/displacement (cm ³)	Fuel
132 (180)/4,500-6,200	280/1,350-4,500	4/1,798	Super 95 RON/Normal 91 RON ^{a)}

^{a)} Slight power loss.

Outputs and weights	LEON ST X-PERIENCE 4WD
Top speed (km/h)	221 (V&VI)
Acceleration from 0-80 km/h (seconds)	4.9
Acceleration from 0-100 km/h (seconds)	7.2
Maximum authorised weight (kg)	2,000
Weight in running order (with driver) (kg)	1,486
Maximum authorised weight on front axle (kg)	1,000
Maximum authorised weight on rear axle (kg)	1,050
Permitted roof load (kg)	75
Maximum trailer weight without brakes (kg)	740
Weight of trailer with brakes on gradients up to 8% (kg)	1,700
Weight of trailer with brakes on gradients up to 12% (kg)	1,500

Technical specifications

Petrol engine 2.0 213 kW (290 PS)

Power output in kW (PS) at rpm	Maximum torque (Nm at rpm)	No. of cylinders/displacement (cm ³)	Fuel
213 (290)/5,900-6,400	350/1,700-5,800	4/1,984	Super 98 RON/Super 95 RON ^{a)}

^{a)} Slight power loss.

Outputs and weights	LEON automatic	LEON SC automatic	LEON ST automatic
Top speed (km/h)	250 (VI)	250 (VI)	250 (VI)
Acceleration from 0-80 km/h (seconds)	4.4	4.2	4.4
Acceleration from 0-100 km/h (seconds)	5.7	5.6	5.9
Maximum authorised weight (kg)	1,910	1,890	2,010
Weight in running order (with driver) (kg)	1,421	1,395	1,466
Maximum authorised weight on front axle (kg)	1,050	1,020	1,020
Maximum authorised weight on rear axle (kg)	910	920	1,040
Permitted roof load (kg)	75	75	75
Maximum trailer weight without brakes (kg)	-	-	-
Weight of trailer with brakes on gradients up to 8% (kg)	-	-	-
Weight of trailer with brakes on gradients up to 12% (kg)	-	-	-

Technical data

Petrol engine 2.0 221 kW (300 PS)

Power output in kW (PS) at rpm	Maximum torque (Nm at rpm)	No. of cylinders/displacement (cm ³)	Fuel
221 (300)/5,500-6,200	380/1,800-5,500	4/1,984	Super 98 RON/Super 95 RON ^{a)}

^{a)} Slight power loss.

Outputs and weights	LEON manual	LEON automatic	LEON SC manual	LEON SC automatic	LEON ST manual	LEON ST automatic	LEON ST Automatic all-wheel drive
Top speed (km/h)	250 (VI)	250 (VI)	250 (VI)	250 (VI)	250 (VI)	250 (VI)	250 (VI)
Acceleration from 0-80 km/h (seconds)	4.7	4.4	4.5	4.2	4.7	4.4	3.5
Acceleration from 0-100 km/h (seconds)	5.8	5.7	5.7	5.6	6.0	5.9	4.9
Maximum authorised weight (kg)	1,890	1,910	1,870	1,890	1,980	2,000	2,040
Weight in running order (with driver) (kg)	1,395	1,421	1,375	1,395	1,440	1,466	1,545
Maximum authorised weight on front axle (kg)	1,020	1,050	1,000	1,020	990	1,020	1,040
Maximum authorised weight on rear axle (kg)	920	910	920	920	1,040	1,030	1,050
Permitted roof load (kg)	75	75	75	75	75	75	75
Maximum trailer weight without brakes (kg)	–	–	–	–	–	–	–
Weight of trailer with brakes on gradients up to 8% (kg)	–	–	–	–	–	–	–
Weight of trailer with brakes on gradients up to 12% (kg)	–	–	–	–	–	–	–

Technical specifications

Petrol/CNG engine 1.4 TSI 81 kW (110 PS)

Power output in kW (PS) at rpm	Maximum torque (Nm at rpm)	No. of cylinders/displacement (cm ³)	Fuel	
			CNG	Super 95 RON/Nor- mal 91 RON ^{a)}
81 (110)/4,800-6,000	200/1,500-3,500	4/1,395	CNG	Super 95 RON/Nor- mal 91 RON ^{a)}

a) Slight power loss.

Outputs and weights	LEON manual	LEON automatic	LEON ST manual	LEON ST automatic
Top speed (km/h)	194 (V)	194 (VI)	194 (VI)	194 (VI)
Acceleration from 0-80 km/h (seconds)	7.1	7.1	7.3	7.3
Acceleration from 0-100 km/h (seconds)	10.9	10.9	11	11
Maximum authorised weight (kg)	1,840	1,870	1,870	1,900
Weight in running order (with driver) (kg)	1,359	1,388	1,395	1,421
Maximum authorised weight on front axle (kg)	920	950	870	900
Maximum authorised weight on rear axle (kg)	970	970	1,050	1,050
Permitted roof load (kg)	75	75	75	75
Maximum trailer weight without brakes (kg)	670	690	690	710
Weight of trailer with brakes on gradients up to 8% (kg)	1,700	1,700	1,700	1,700
Weight of trailer with brakes on gradients up to 12% (kg)	1,400	1,400	1,400	1,400

Technical data

Diesel engine 1.6 66 kW (90 PS)

Power output in kW (PS) at rpm	Maximum torque (Nm at rpm)	No. of cylinders/displacement (cm ³)	Fuel
66 (90)/2,750-4,800	230/1,400-2,750	4/1,598	Diesel according to standard EN 590, min. 51 CN

Outputs and weights	LEON	LEON SC	LEON ST
Top speed (km/h)	180 (IV)	180 (V)	180 (V)
Acceleration from 0-80 km/h (seconds)	8.2	8.0	8.5
Acceleration from 0-100 km/h (seconds)	12.6	12.4	13.0
Maximum authorised weight (kg)	1,780	1,760	1,860
Weight in running order (with driver) (kg)	1,260	1,240	1,305
Maximum authorised weight on front axle (kg)	960	960	950
Maximum authorised weight on rear axle (kg)	870	850	960
Permitted roof load (kg)	75	75	75
Maximum trailer weight without brakes (kg)	630	620	650
Weight of trailer with brakes on gradients up to 8% (kg)	1,700	1,700	1,800
Weight of trailer with brakes on gradients up to 12% (kg)	1,400	1,400	1,500

Technical specifications

Diesel engine 1.6 77 kW (105 PS)

Power output in kW (PS) at rpm	Maximum torque (Nm at rpm)	No. of cylinders/displacement (cm ³)	Fuel
77 (105)/3,000-4,000	250/1,500-2,750	4/1,598	Diesel according to standard EN 590, min. 51 CN

Outputs and weights	LEON Manual	LEON Automatic	LEON ST Manual	LEON ST Automatic
Top speed (km/h)	191 (V)	191 (VI)	191 (V)	191 (VI)
Acceleration from 0-80 km/h (seconds)	7.3	7.3	7.5	7.4
Acceleration from 0-100 km/h (seconds)	10.7	10.7	11.1	11.0
Maximum authorised weight (kg)	1,800	1,820	1,880	1,910
Weight in running order (with driver) (kg)	1,281	1,306	1,326	1,351
Maximum authorised weight on front axle (kg)	980	1,000	960	990
Maximum authorised weight on rear axle (kg)	870	870	970	970
Permitted roof load (kg)	75	75	75	75
Maximum trailer weight without brakes (kg)	640	650	660	670
Weight of trailer with brakes on gradients up to 8% (kg)	1,800	1,800	1,800	1,800
Weight of trailer with brakes on gradients up to 12% (kg)	1,500	1,500	1,500	1,500

Technical data

Diesel engine 2.0 TDI CR 81 kW (110 PS)

Power output in kW (PS) at rpm	Maximum torque (Nm at rpm)	No. of cylinders/displacement (cm ³)	Fuel
81 (110)/3,250-4,500	250/1,500-3,000	4/1,968	Diesel according to standard EN 590, min. 51 CN

Outputs and weights	LEON ST
Top speed (km/h)	189 (V)
Acceleration from 0-80 km/h (seconds)	7.1
Acceleration from 0-100 km/h (seconds)	10.7
Maximum authorised weight (kg)	1,910
Weight in running order (with driver) (kg)	1,358
Maximum authorised weight on front axle (kg)	990
Maximum authorised weight on rear axle (kg)	970
Permitted roof load (kg)	75
Maximum trailer weight without brakes (kg)	670
Weight of trailer with brakes on gradients up to 8% (kg)	1,800
Weight of trailer with brakes on gradients up to 12% (kg)	1,500

Technical specifications

Diesel engine 1.6 85 kW (115 PS)

Power output in kW (PS) at rpm	Maximum torque (Nm at rpm)	No. of cylinders/displacement (cm ³)	Fuel
85 (115)/3,250-4,000	250/1,500-3,250	4/1,598	Diesel according to standard EN 590, min. 51 CN

Outputs and weights	LEON manual	LEON automatic	LEON SC manual	LEON SC automatic	LEON ST manual	LEON ST automatic	LEON ST X-PERIENCE manual
Top speed (km/h)	197 (V)	197 (VII)	197 (V)	197 (VII)	197 (V)	197 (VII)	193 (V)
Acceleration from 0-80 km/h (seconds)	6.8	6.8	6.5	6.8	6.8	6.9	6.5
Acceleration from 0-100 km/h (seconds)	9.8	9.8	9.5	9.9	9.9	10.0	9.5
Maximum authorised weight (kg)	1,810	1,830	1,750	1,770	1,870	1,890	1,890
Weight in running order (with driver) (kg)	1,260	1,280	1,240	1,261	1,305	1,326	1,331
Maximum authorised weight on front axle (kg)	960	980	960	980	950	970	950
Maximum authorised weight on rear axle (kg)	900	900	840	840	970	970	990
Permitted roof load (kg)	75	75	75	75	75	75	75
Maximum trailer weight without brakes (kg)	630	640	620	630	650	660	660
Weight of trailer with brakes on gradients up to 8% (kg)	1,800	1,800	1,800	1,800	1,800	1,800	1,800
Weight of trailer with brakes on gradients up to 12% (kg)	1,500	1,500	1,500	1,500	1,500	1,500	1,500

Technical data

Diesel engine 2.0 TDI CR 105 kW (143 PS)

Power output in kW (PS) at rpm	Maximum torque (Nm at rpm)	No. of cylinders/displacement (cm ³)	Fuel
105 (143)/3,500-4,000	320/1,750-3,000	4/1,968	Diesel according to standard EN 590, min. 51 CN

Outputs and weights	LEON	LEON SC
Top speed (km/h)	211 (V)	211 (V)
Acceleration from 0-80 km/h (seconds)	6.2	6.1
Acceleration from 0-100 km/h (seconds)	8.7	8.6
Maximum authorised weight (kg)	1,830	1,800
Weight in running order (with driver) (kg)	1,301	1,281
Maximum authorised weight on front axle (kg)	990	990
Maximum authorised weight on rear axle (kg)	890	860
Permitted roof load (kg)	75	75
Maximum trailer weight without brakes (kg)	650	640
Weight of trailer with brakes on gradients up to 8% (kg)	1,800	1,800
Weight of trailer with brakes on gradients up to 12% (kg)	1,600	1,600

Technical specifications

Diesel engine 2.0 110 kW (150 PS)

Power output in kW (PS) at rpm	Maximum torque (Nm at rpm)	No. of cylinders/displacement (cm ³)	Fuel
110 (150)/3,500-4,000	340/1,750-3,000	4/1,968	Diesel according to standard EN 590, min. 51 CN

Outputs and weights	LEON Start-Stop	LEON Automatic	LEON SC Start-Stop	LEON SC Automatic	LEON ST Start-Stop	LEON ST Automatic	LEON ST All-wheel drive	LEON ST X-PERIENCE 4WD	LEON ST X-PERIENCE 4WD automatic
Top speed (km/h)	215 (VI)	211 (VI)	215 (VI)	211 (VI)	215 (VI)	213 (VI)	211 (VI)	208 (VI)	205 (VI)
Acceleration from 0-80 km/h (seconds)	6.1	6.0	6.0	6.0	6.2	6.2	6.3	6.3	5.8
Acceleration from 0-100 km/h (seconds)	8.4	8.4	8.3	8.3	8.6	8.6	8.7	8.7	8.9
Maximum authorised weight (kg)	1,820	1,850	1,810	1,810	1,910	1,940	2,010	2,010	2,040
Weight in running order (with driver) (kg)	1,305	1,335	1,285	1,305	1,358	1,388	1,474	1,491	1,519
Maximum authorised weight on front axle (kg)	1,000	1,030	990	1,010	990	1,020	1,010	1,010	1,040
Maximum authorised weight on rear axle (kg)	870	870	870	850	970	970	1,050	1,050	1,050
Permitted roof load (kg)	75	75	75	75	75	75	75	75	75
Maximum trailer weight without brakes (kg)	650	660	640	650	670	690	730	740	750
Weight of trailer with brakes on gradients up to 8% (kg)	1,800	1,800	1,800	1,800	1,800	1,800	1,900	2,000	2,000



Technical data

Outputs and weights	LEON Start-Stop	LEON Automatic	LEON SC Start-Stop	LEON SC Automatic	LEON ST Start-Stop	LEON ST Automatic	LEON ST All-wheel drive	LEON ST X-PERIENCE 4WD	LEON ST X-PERIENCE 4WD automatic
Weight of trailer with brakes on gradients up to 12% (kg)	1,600	1,600	1,600	1,600	1,600	1,600	1,700	2,000	2,000

Technical specifications

Diesel engine 2.0 130 kW (177 PS)

Power output in kW (PS) at rpm	Maximum torque (Nm at rpm)	No. of cylinders/displacement (cm ³)	Fuel
130 (177)/3,600-4,000	350/1,750-3,000	4/1,968	Diesel according to standard EN 590, min. 51 CN

Outputs and weights	LEON	LEON SC
Top speed (km/h)	223 (VI)	223 (VI)
Acceleration from 0-80 km/h (seconds)	5.9	5.8
Acceleration from 0-100 km/h (seconds)	7.8	7.6
Maximum authorised weight (kg)	1,880	1,860
Weight in running order (with driver) (kg)	1,365	1,345
Maximum authorised weight on front axle (kg)	1,020	1,010
Maximum authorised weight on rear axle (kg)	910	900
Permitted roof load (kg)	75	75
Maximum trailer weight without brakes (kg)	680	670
Weight of trailer with brakes on gradients up to 8% (kg)	1,800	1,800
Weight of trailer with brakes on gradients up to 12% (kg)	1,600	1,600

Technical data

Diesel engine 2.0 135 kW (184 PS)

Power output in kW (PS) at rpm	Maximum torque (Nm at rpm)	No. of cylinders/displacement (cm ³)	Fuel
135 (184)/3,500-4,000	380/1,750-3,000	4/1,968	Diesel according to standard EN 590, min. 51 CN

Outputs and weights	LEON Start-Stop	LEON Automatic	LEON SC Start-Stop	LEON SC Automatic	LEON ST Start-Stop	LEON ST Automatic	LEON ST X-PERIENCE 4WD
Top speed (km/h)	228 (VI)	226 (VI)	228 (VI)	226 (VI)	228 (VI)	226 (VI)	224 (VI)
Acceleration from 0-80 km/h (seconds)	5.7	5.7	5.6	5.6	5.9	5.9	4.9
Acceleration from 0-100 km/h (seconds)	7.5	7.5	7.4	7.4	7.8	7.8	7.1
Maximum authorised weight (kg)	1,880	1,900	1,860	1,890	1,970	1,990	2,050
Weight in running order (with driver) (kg)	1,370	1,390	1,350	1,370	1,415	1,435	1,529
Maximum authorised weight on front axle (kg)	1,020	1,040	1,010	1,030	1,010	1,030	1,050
Maximum authorised weight on rear axle (kg)	910	910	900	910	1,010	1,010	1,050
Permitted roof load (kg)	75	75	75	75	75	75	75
Maximum trailer weight without brakes (kg)	680	690	670	680	700	710	750
Weight of trailer with brakes on gradients up to 8% (kg)	1,800	1,800	1,800	1,800	1,800	1,800	2,000
Weight of trailer with brakes on gradients up to 12% (kg)	1,600	1,600	1,600	1,600	1,600	1,600	2,000

Dimensions

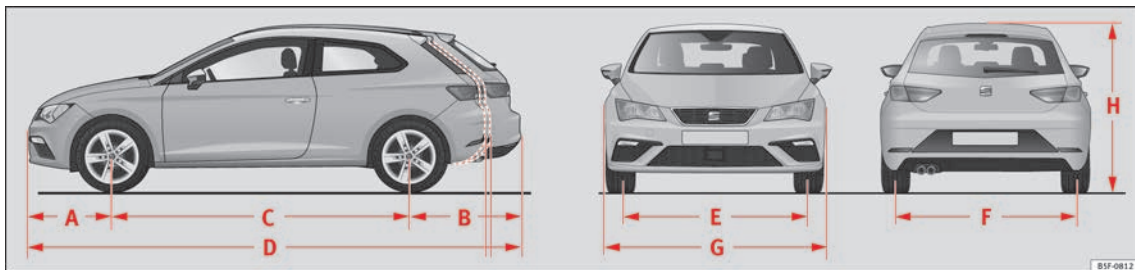


Fig. 259 Dimensions.

		LEON	LEON SC	LEON ST	LEON ST X-PERIENCE
A/B	Front and rear projection (mm)	861/785	861/785	861/1,052	861/1,060
C	Wheelbase (mm)	2,636	2,601	2,636	2,630
D	Length (mm)	4,282	4,247	4,549	4,551
E/F	Front/rear ^{a)} track width (mm)		1,533/1,504 1,549/1,520		1,541/1,504 1,547/1,510
G	Width (mm)	1,816	1,810	1,816	1,816
H	Height at kerb weight (mm)	1,459	1,446	1,454 ^{b)}	1,481 ^{b)}
	Turning radius (m)	10.9			

^{a)} This data will change depending on the type of wheel rim.

^{b)} Dimension to the roof bars.

Index

A

- ACC 214
 - radar sensor 217
- Accessories 159, 256
- Adaptive cruise control 214
 - function for preventing overtaking in an inside lane 221
 - indications on the display 216
 - malfunction 215
 - radar sensor 217
 - special driving situations 222
 - warning and control lamp 216
- Adaptive Cruise Control
 - deactivating temporarily 221
 - operating 218
- Additional consumers (efficiency program) 43
- Adjusting
 - front head restraints 78
 - front seats 152
 - lights 146
 - rear head restraints 153
 - seats 75
- Adjusting the head restraints
 - front head restraints 153
- Adjustment
 - CAR menu 120
 - front head restraints 153
 - rear head restraints 78
- Airbag covers 22
- Airbags 85
 - description 86
- Airbag system 22, 85
 - activation 86
 - control lamp 90
 - deactivation of front airbag 89
 - description 86
 - front airbags 22, 87
 - functioning 86
 - head-protection airbags 24, 88
 - knee airbags 23, 87
 - side airbags 24, 87
- Air conditioning
 - Climatronic 52, 173
 - heating and fresh air 56
 - manual air conditioning 54
 - user instructions 175
- Air outlets 176
- Air recirculation 176
- Alcantara: cleaning 263
- Anchoring
 - the front tow line 99
- Anti-freeze 60
- Anti-locking system 187
- Anti-puncture 65, 95
 - Anti-puncture kit 65, 95
 - check after 10 minutes 97
 - Anti-puncture set 95
- Anti-theft alarm 125, 133
 - trailer 254
 - vehicle interior monitoring and anti-tow protection 135
- Anti-theft security system 15, 125, 131
- Anti-tow protection 135
- Aspects to note before setting off 74
- ASR
 - see Traction control system 187
- Assistance systems
 - ACC 214
 - adaptive cruise control 214
 - Auto Hold function 208
 - cruise control system 209
 - Emergency Assist 228
 - emergency brake assist (Front Assist) 210
 - fatigue detection 236
 - parking aid 237, 238
 - traffic jam assist 227
 - traffic sign detection system 233
 - tyre monitoring 284
 - tyre monitoring indicator 285
 - tyre monitoring systems 283
- Assisted starting 70
- Audible warning signal
 - control and warning lamps 119
 - lights 140
 - unfastened safety belt 80
- Auto Hold 208
- Auto Hold function 208
- Auto Lock (central locking) 125
- Automatic car washes
 - switching the Auto Hold function off 209
- Automatic dipped beam control 141
- Automatic gearbox 191
 - downhill speed control 196
 - driving tips 194
 - emergency program 197
 - kick-down feature 195
 - launch control program 195
 - manual release of the selector lever 50
 - safety interlock for ignition key 178
 - selector lever lock 192
 - selector lever positions 191
 - steering wheel with gear shift paddles 193
 - tiptronic 191, 193
- AUX-IN 123

B

- Battery 132
- Before setting off 74

- Belt tensioners
 - control lamp 90
- Belt tightening 84
- Bench seat 156
- Biodiesel 267
- Bonnet 17, 270
 - opening the bonnet 271
- Brake
 - emergency braking function 184
- Brake assist 187
- Brake fluid 61
- Brakes 186
 - brake assist 187
 - brake fluid 275
 - brake servo 186
 - electronic parking brake 183
 - moving off 190
 - new brake pads 186
- C**
- Camera
 - cleaning 259
 - cleanliness 233
 - Lane Assist 224
- Capacities 58
 - fuel tank 118
 - natural gas tank 265
 - windscreen washer water 276
- Car-care products 257
- Catalytic converter
 - malfunction 203
- CCS 45
- CD-ROM player (navigation) 158
- Central locking
 - adjusting 128
 - anti-theft alarm 133
 - central locking switch 128
 - electric windows 137
 - emergency locking 16
 - Keyless Access 129
 - Panoramic sliding/tilting sunroof 137
 - remote control key 127
 - selective unlocking system 127
- Central locking system 125
- Centre console 11
- Cetane number (diesel fuel) 267
- Changing a bulb
 - fog light 106
 - number plate light 110
 - rear bulb in the side panel 108
 - rear bulbs 107
- Changing a wheel
 - subsequent work 68
- Changing gear
 - engaging gears (manual gearbox) 190
- Changing main headlight
 - turn signal 105
- Changing settings
 - CAR menu 33
- Changing the blades 97
- Changing the main beam headlight bulb
 - main beam headlight 106
- Changing the main headlight bulb
 - day light 105
 - dipped headlight 105
- Changing the wiper blades 72
- Charging the battery 278
- Checking levels
 - engine compartment 270
- Childproof locks
 - electric windows 136
- Child seats 25, 92
 - categorisation into groups 92
 - ISOFIX system 27
 - safety instructions 25, 91
 - securing with seat belt 26
 - Top Tether system 27, 29
 - Top Tether System 29
- Cleaning 257
 - alcantara 263
 - carbon parts 260
 - Easy Connect control panel 261
 - exhaust pipe 261
 - fabrics 261
 - leather 262
 - natural leather 263
 - plastic parts 260, 261
 - radio screen 261
 - rims 260
 - seat belts 264
 - trims 259
 - washing the vehicle 257
 - windows 260
- Climatronic 52
- Close 125
- Closing 125
 - bonnet 271
 - panoramic sliding sunroof 138
 - windows 136
- Clutch (warning lamp) 197
- Coming Home 143
- Connectivity Box 123
- Control and warning lamps 47, 119
 - adaptive cruise control 216
 - airbags 89
 - airbag system 90
 - applying the brake 216
 - ASR 188

- audible warning signal 119
- cruise control system (CCS) 209
- depress the brake 210
- diesel particulate filter 203
- electromechanical steering 198
- emission control 203
- engine management 203
- engine pre-heating/fault system 203
- ESC 188
- gear change 198
- instrument panel 47, 49
- instrument panel display 48
- Lane Assist 224
- lights 140
- refuelling 264
- seat belt 80
- Start-Stop 206
- tyre monitoring system 284
- Controls and displays
 - general instrument panel 113
- Controls for the windows 18, 136
- Controls on the steering wheel
 - operating the audio, telephone and navigation system 121
- Convenience closing
 - panoramic sliding sunroof 139
- Convenience opening
 - panoramic sliding sunroof 139
- Coolant
 - checking level 274
- Cooling
 - coolant temperature gauge 117
- Cooling system
 - checking coolant 274
 - topping up coolant 274
- Cornering
 - lights 143
- Correct position 75
 - driver 75
 - front passenger 76
- Correct sitting position
 - rear seat passengers 77
- Cruise control 45, 209
 - operation 210
- Cruise control system 209
 - warning and indication lamp 209
- D**
- Dangers in not using the seat belt 82
- Dash panel 47
- Data label 289
- Deactivating the front passenger front airbag ... 23
- Deactivation of front airbag 89
- Defective bulbs
 - changing a bulb 103
- Detachable ball
 - assembling 248
 - checking attachment 249
 - placing in standby position 247
 - removing 249, 250
 - standby position 247
- Diesel
 - diesel particulate filter 203
 - engine oil 272
 - preheating 178
 - refuelling 267
- Diesel particulate filter 203
 - malfunction 203
- Digital clock 116
- Dimensions 313
- Direction of rotation
 - tyres 68
- Display 114, 115
- Display of traffic signs on the instrument panel
 - activate 234
 - deactivate 234
- Disposal
 - belt tensioners 84
- Distance control
 - see Adaptive cruise control 214
- Door cylinder 15
- Door handle 15
- Door lock 15
- Door release lever 113
- Doors
 - childproof locks 133
 - opening and closing 15
- Downhill speed control 196
- Downhill speed control function 196
- Drawer 157
- Drink holders 158
- Driver
 - see Correct sitting position 75, 76, 77
- Driver-side general instrument panel
 - left-hand drive 9
 - right-hand drive 10
- Driver information system
 - engine oil temperature display 43
 - operation through the windscreen wiper lever . 36
- Driving
 - driving abroad 146
 - economical 200
 - safe 74
 - with a trailer 251, 253, 254
 - with trailer 246
- Driving abroad
 - headlights 146
- Driving data
 - data summary 39
 - memories 38

- Driving mode 231
- Driving profile 231
- Driving through water 204
- DSG 191
- Duplicate keys 126
- Dust and pollen filter 173
- Dynamic lights range control 146
- E**
- E10
 - see Ethanol (fuel) 266
- Easy Connect 33, 120
- Efficiency program
 - additional consumers 43
 - saving tips 43
- Electrical accessories
 - see Power socket 159
- Electrical socket
 - trailer 252
- Electric windows 18, 136
 - convenience opening and closing 137
- Electromechanical steering 198
 - lamp 198
- Electronic differential lock control 187
- Electronic immobiliser 15
- Electronic parking brake 183
- Electronic self-locking 187
- Electronic Stability Control (ESC) 187
- Electronic torque management (XDS) 187
- Emergencies 95
 - anti-puncture kit 95
 - automatic gearbox emergency program 197
 - bulbs 64
 - changing a wheel 66
 - emergency towing of the vehicle 69
 - fuses 63
 - hazard warning lights 145
 - jump leads 70
 - manual unlocking and locking 97
 - puncture 64
 - replacing a blown fuse 63
 - replacing the battery 278
 - vehicle tool kit 95
- Emergency Assist 228
 - switching off 229
 - switching on 229
- Emergency braking assistance system
 - indications on the display 210
 - malfunction 212
 - operating 213
 - radar sensor 212
 - switching off temporarily 213
 - system limitations 214
- Emergency braking function 184
- Emergency braking warning 145
- Emergency operation
 - front passenger door 16
 - selector lever 50
- Emission control system
 - catalytic converter 203
 - control lamp 203
 - diesel particulate filter 203
- Emissions data 290
- Engine
 - assisted starting 70
 - noises 182
 - preheating 178
 - running in 199
 - Start-Stop system 205
 - starting 178
 - starting up (driver messages with the mechanical contact) 178
 - switching off (key) 179
- Engine and ignition
 - automatic ignition switch-off 180
 - My Beat 183
 - preheating the engine 181
 - starting the engine 181
 - starting the engine with Press & Drive 181
 - stopping the engine 182
- Engine compartment 17, 270
 - battery 61, 277
 - brake fluid 61, 275
 - closing the bonnet 271
 - coolant 60, 274
 - engine oil 59, 272, 273
 - opening the bonnet 271
 - safety notes 270
 - windscreen washer reservoir 61, 276
- Engine coolant 60
 - G 12 plus-plus 60
 - G 13 60
 - specifications 60
- Engine data 292
- Engine fault
 - control lamp 203
- Engine management 202
 - control lamp 203
- Engine oil 59, 272
 - changing 272, 274
 - checking oil level 273
 - consumption 273
 - dipstick 273
 - inspection service 272
 - maintenance intervals 272
 - oil properties 60
 - specifications 60, 272
 - temperature display 43
 - topping up 273

- Environment
 ecological driving 200
 environmental compatibility 199
- Environmental tips
 filling the tank 265
 refuelling 264
- Equipment 159, 256
- ESC
 electronic stability control 187
 Multi-collision Brake 188
 Sport Mode 189
- Ethanol (fuel) 266
- Event Data Recorder 94
- Exhaust pipe: cleaning 261
- Extending
 the luggage compartment 155
- Exterior lighting
 changing a bulb 103
- Exterior mirrors
 adjusting 21
- Exterior rear-view mirrors
 adjusting the exterior rear-view mirrors 151
 exterior 151
 heated 151
- Exterior view 7, 8
- External aerial 256
- F**
- Fastening rings 167
- Fatigue detection 236
- Filling the fuel tank 264
- Filling the tank 264
- Floor mats 79
- Fluid level control 58
- Fog light bulb 106
- Folding table 158
- Four-wheel drive 204
 snow chains 204
 winter tyres 204
- Front airbags 22, 87
- Front armrest 155
- Front Assist
 indications on the display 210
- Front passenger front airbag
 control lamp 90
 deactivation 23
- Front seat
 manual adjustment 19
- Fuel 58
 consumption 290
 diesel 267
 ethanol 266
 fuel gauge 118
 natural gas 268
 petrol 266
 refuelling 266
 saving 200
- Fuel consumption
 engine cut-off due to inertia 200
 why does fuel consumption increase? 203
- Fuel tank cap
 opening and closing 58
- Full-LED Headlights 103
- Function Coming Home 143
- Function Leaving Home 144
- Fuses 63, 101
 fuse box 102
 identifying blown fuses 63
 identifying by colours 63
 preparation before replacing 63
 replacing 63
- G**
- Gear-change indicator 42
- Gearbox DSG
 see Automatic gearbox 191
- Gearbox lever 50
- Gear change 50
 automatic 50
 kick-down 232
 manual gearbox 190
 manual gear change 50
- Gear engaged 50
- Gear recommendation 42
- Gear shift paddles (automatic gearbox) 193
- General instrument panel
 control lamps 47
 controls and displays 113
 engine compartment 270
 warning lamps 47
- Glove compartment 158
- H**
- Handbrake 184
 warning lamp 185
 see also Parking brake 183
- Hazard warning lights 31, 145
- Head-on collisions and their laws of physics 82
- Head-protection airbags
 description 24
 safety instructions 88
- Headlights
 changing a bulb 103
 driving abroad 146
 headlight washers 149
- Head restraints 20
 adjustment 153
 front head restraints 78
 rear head restraints 78

- Headrests 20
 adjustment 153
 front 78
 Heated rear window 53, 55
 Heating and fresh air 56
 Hill driving assistant 190
 Horn 113
 How to jump start 70
 description 71
- I**
- Identification plate 289
 Identifying letters on engine 290
 Ignition 30, 178
 Ignition lock 30, 178
see also Starter button 180
 Incorrect position 77
 Indications on the display 115
 ACT 200
 adaptive cruise control 216
 assist systems submenu 40
 compass 116
 distance travelled 116
 doors, bonnet and rear lid open 41
 driver information system 36
 driving data 38
 ECO 117
 emergency brake assist system (Front Assist) 210
 engine oil 43
 MKB 117
 outside temperature 42
 recommended gear 116
 second speed display 116
 selector lever positions 116
 service intervals 44
 speed warning 116
 Start-Stop 116
 time 116
 traffic signs 234
 tyre monitoring 285
 warning and control lamps 216
 warning and information messages 41
- Indications on the screen
 SEAT Drive Profile 230
 selector lever positions 191
 Inertia mode 197
 Infotainment system 33
 Inspection 272
 Inspection service 272
 Instrument panel 114
 display 114, 115
 instruments 114
 menus 36
 odometer 117
 service interval indication 44
 warning and control lamps 119
- Instruments 114
 Interior lights 32
 Interior view 14
 ISOFIX 27, 29
 ISOFIX system 27, 29
- J**
- Jack 66, 95
 mounting points 67
 Journey data 36
 Jump leads 70
- K**
- Key-operated switch 89
 Keyless Access
 Keyless Entry 129
 Keyless Exit 129
 Press & Drive 180
 special characteristics 131
 starting the engine 181
 unlocking and locking the vehicle 129
- Keyless Access lock and ignition system:
see Keyless Access 129
- Keyless Entry
see Keyless Access 129
- Keyless Exit
see Keyless Access 129
- Keys
 assign key 126
 car key 126
 driver messages (mechanical contact) 178
 remote control 126
 replacing the battery 132
 spare key 126
 synchronising 132
 unlocking and locking 15, 127
- Kick-down
 automatic gearbox 195
 manual gearbox 232
- Knee airbag 87
 safety information 23
- L**
- Lane Assist 224
 cleaning the camera area 259
- Lane Assist system
see Lane Assist 224
- Launch control (automatic gearbox) 195
 Leather: care 262
 Leaving Home 144
 Lifting the vehicle 67
 Light Assist 142
 Lighting of the instrument panel 147

- Lights 30, 140
 - audible signals 140
 - AUTO 141
 - changing a bulb 103
 - coming home 143
 - cornering lights 143
 - daytime running lights 140
 - dipped beam headlight 140
 - fog light 143
 - hazard warning lights 31
 - interior lights 147
 - leaving home 144
 - light control 140
 - lighting of instruments 147
 - lighting of the controls 147
 - lights range control 146
 - main beam lever 141
 - main beam lights 140
 - main beams 31
 - motorway light 146
 - parking lights 145
 - reading lights 147
 - side lights 140
 - switch 30
 - turn signal lever 141
 - Lights range control 146
 - Load compartment in the luggage compartment
 - see Loading the luggage compartment 160
 - Loading the luggage compartment 160
 - Loading the vehicle
 - fastening rings 167
 - luggage compartment 16
 - roof carrier system 172
 - tailboard for transporting long items 166
 - Locking and unlocking
 - in the door cylinder 15
 - with Keyless Access 129
 - Locking the front passenger door manually 16
 - Luggage 160
 - Luggage compartment 16
 - automatic locking 135
 - luggage compartment lighting 147
 - luggage compartment variable floor ... 169, 170
 - manual release mechanism 17
 - net bag 168
 - net partition 164, 165
 - retractable rear shelf 162
 - shelf 161
 - storing the rear shelf 163, 164
 - see also Loading the luggage compartment . 160
 - Luggage compartment floor 169, 170
 - Luggage compartment variable floor 169, 170
 - Luggage net
 - luggage compartment 168
 - Lumbar support 152
- M**
- Main beam assist 142
 - Main beam lever 141
 - Main panel
 - turn signal and main beam lever 141
 - Maintenance intervals 272
 - Malfunction
 - adaptive cruise control 215
 - catalytic converter 203
 - clutch 197
 - diesel particulate filter 203
 - emergency braking assistance system (Front Assist) 212
 - gearbox 198
 - Manual air conditioning 54
 - Manual gearbox 190
 - Manual release mechanism
 - rear lid 17
 - Manual unlocking and locking 97
 - MFD
 - see Driver information system 36
 - Mirror 150
 - Mobile 256
 - Mobile telephones 256
 - Moving off
 - hill driving assistant 190
 - Multi-collision Brake 188
 - Multi-function display (MFD) 36
 - Multimedia 123
 - My Beat 183
- N**
- Natural gas 268
 - fuel gauge 119
 - fuel tank cap 265
 - LNG 266
 - refuelling 265, 268
 - smell 268
 - special features 266
 - Natural leather
 - cleaning 263
 - Navigation system
 - CD-ROM player 158
 - Net bag
 - luggage compartment 168
 - Net partition 164, 165
 - Noises
 - adaptive cruise control 215
 - brakes 186
 - ESC 188
 - parking brake 184
 - refuelling natural gas 266
 - tyres 68, 279
 - Number of seats 80

- O**
- Odometer 117
 - reset button 117
 - total 114
 - trip recorder 114
 - Oil change 274
 - Oil properties 60
 - On-board computer
 - see Driver information system 36
 - One-touch opening and closing
 - electric windows 138
 - Open and close 125
 - panoramic sliding sunroof 138
 - Opening 125
 - bonnet 271
 - fuel tank flap 265
 - panoramic sliding sunroof 138
 - the fuel tank cap 264
 - windows 136
 - Opening and closing 15
 - bonnet 271
 - by remote control 127
 - fuel cap 58
 - fuel tank flap 265
 - in the door cylinder 15
 - rear lid 16
 - windows 136
 - with the central locking switch 128
 - Outside temperature 42
- P**
- Paint 259
 - care 259
 - damage 260
 - Paintwork
 - code 290
 - Panoramic sliding sunroof
 - closing 138
 - convenience closing 139
 - convenience opening 139
 - convenience opening and closing 137
 - fault 138
 - opening 138
 - roll-back function 139
 - Parking 185, 194
 - Parking aid 237
 - adjusting the display and audible warnings 241
 - automatic activation 240
 - malfunction 242
 - parking aid plus 239
 - rear parking aid 238
 - sensors and camera: cleaning 259
 - surrounds warning 239
 - towing bracket 242
 - visual indication 241
 - Parking aid system
 - see Parking aid 237
 - Parking brake 184
 - activate 183
 - automatic activation 184
 - automatic release 183
 - emergency braking function 184
 - release 183
 - Parking distance warning system
 - see Parking aid 237
 - Parking (automatic gearbox) 194
 - ParkPilot
 - see Parking aid 237
 - Parts 256
 - Passenger
 - see Correct sitting position 75, 76, 77
 - Passenger-side instrument panel
 - left-hand drive 12
 - right-hand drive 13
 - Passenger seat backrest
 - folding down 155
 - lifting 155
 - Pedals 79
 - Petrol
 - additives 266
 - refuelling 266
 - Plastic parts: cleaning 260, 261
 - Polishing 259
 - Positioning seat belts
 - during pregnancy 84
 - seat belts 84
 - Power 159
 - Power management 201
 - Power socket 159
 - Power steering
 - see Electromechanical steering 198
 - Pre-heating system
 - control lamp 203
 - Preheating 178
 - Preheating the engine 181
 - Press & Drive
 - starter button 180
 - starting the engine 181
 - Progressive steering 198
 - Puncture
 - action 64
- R**
- Racks 159
 - Radar sensor 212, 217
 - Radio-operated remote control
 - see Keys 126
 - Radio screen: cleaning 261

- Radio transmitters 256
 - Rain sensor 150
 - control of the function 150
 - Raising the vehicle 67
 - Rear
 - headrests 78
 - Rear-view mirror
 - anti-dazzle 150
 - interior anti-dazzle 150
 - Rear Assist 243
 - instructions for use 244
 - parking 245
 - screen 244
 - special characteristics 244
 - Rear Assist system 243
 - Rear bulbs 107
 - Rear bulbs in the side panel
 - disassembling the rear light 108
 - Rear lid 16, 17
 - see also Luggage compartment 135
 - Rear lights in the rear lid
 - disassembling the bulb holder 109
 - Rear lights on the side panel
 - summary 107
 - Rear seat
 - folding down and raising the backrest 155
 - Rear seat backrest
 - folding down 156
 - folding down and lifting the backrest 156
 - lifting 156
 - Rear seat passengers
 - see Correct sitting position 75, 76, 77
 - Rear shelf
 - storing 163, 164
 - Rear View Camera 243
 - Refuelling
 - fuel gauge 118
 - gas gauge 119
 - natural gas 265
 - opening the fuel tank cap 264
 - Remote control key
 - unlocking and locking 127
 - Removing and attaching head restraints 153
 - Repair work 256
 - Replacement
 - parts 256
 - Replacement parts 256
 - Replacing the battery
 - of the vehicle key 132
 - Reset the trip recorder 117
 - Retaining hooks 168
 - Retractable rear shelf 162
 - Rev counter 115
 - Reverse gear (automatic gearbox) 191
 - Revolution counter 114
 - Rims
 - changing a wheel 66
 - cleaning 260
 - Roll-back function
 - panoramic sliding sunroof 139
 - sun blind 139
 - windows 137
 - RON (petrol) 266
 - Roof carrier 170
 - Roof carrier system 170
 - Roof load 172
 - technical data 172
 - Roof luggage rack
 - attach the cross bars 171
 - Roof rack 170
 - Running in
 - new brake pads 186
 - new engine 199
 - new tyres 279
- ## S
- Safe driving 74
 - Safe lock 131
 - see also Anti-theft security system 125
 - Safety
 - child safety 91
 - child seats 91
 - deactivating the front passenger airbag 23
 - safe driving 74
 - Safety equipment 74
 - Safety information
 - knee airbags 23
 - Safety instructions
 - belt tensioners 84
 - head-protection airbags 88
 - side airbags 87
 - use of seat belts 81
 - using child seats 25, 91
 - Safety interlock for ignition key 178
 - Saving fuel
 - inertia mode 197
 - Saving tips (efficiency program) 43
 - Seat belt position
 - for pregnant women 20
 - seat belts 20
 - Seat belts 80
 - adjustment 20, 83
 - cleaning 264
 - control lamp 80
 - protective function 81
 - purpose 80, 85

safety instructions	81	switching off and on	207	Taking care of your vehicle	257
unfastened	82	the engine does not switch off	206	exterior	257
Seat belt tensioners	21, 84	the engine starts by itself	206	interior	261
SEAT Drive Profile	230	Starter button	180	Technical data	
Seat heating	154	Starting the engine	178	capacity	276
Seats		Starting the vehicle	30	roof load	172
adjustment	152	Steering		Technical modifications	256
electric seat	19	electromechanical steering	198	Technical specifications	289
heating	154	engaging the steering lock	179	Textiles: cleaning	261
rear seat backrest	156	Steering wheel		Tightening torque of wheel bolts	291
Selective unlocking system	127	adjusting	76	Timer	40
Selector lever lock	192	adjustment	21	lap times	40
Selector lever (automatic gearbox)		gear shift paddles (automatic gearbox)	193	menu	40
malfunction	192	Steering wheel controls	121	statistics	40
manual release mechanism	50	Storage area		Tiptronic (automatic gearbox)	191, 193
positions	191	front seat	157	Top speed	43
Service intervals	44	Storage compartments	157, 159	Top Tether	27, 29
Service notification: read	45	glove compartment	158	Top Tether system	27, 29
Side airbags		glove compartment lighting	147	Tow-starting	70, 98
description	24	Sun blind	139, 148	Tow-starting the engine	99
safety instructions	87	roll-back function	139	Towing a trailer	251
Signal lever	31	Sun protection	148	Towing bracket	
Sliding panoramic sunroof	18	Sun visors	148	retrofitting	254
Smell of gas	268	Switch		Towing bracket device	246
Snow chains	69, 291	hazard warning lights	145	ball coupling	252
four-wheel drive	204	Switching off the engine		description	246
Spanner symbol	44	with the key	179	operation and care	250
Special characteristics		Switching off the lights	140	Towing the vehicle	69, 98
tow-starting	99	Switching on the lights	140	Towline anchorage	70, 95
Speed warning device	43	Switching the ignition on and off	30, 178	rear	100
Sport Mode	189	System Easy Connect	120	Tow rope	251
Start-Stop	205	T		Traction control system	187
Start-Stop system		Tailboard for transporting long items	166	Traffic Jam Assist	227
driver messages	207	Tail lights		malfunctions	228
lamps	206	changing a bulb	107	situations in which Traffic Jam Assist must be switched off	227
operation	205				
starting and stopping the engine	206				

- Traffic sign detection system 233
 indication on display 234
 limited operation 235
 operation 234
 speed warning 235
 trailer 235
 windscreen damage 233
- Traffic Sign Detection System 234
- Traffic signs
 indication on display 234
- Trailer 246
 connecting 252, 253
 driving with a trailer 253
 electrical socket 252
 hitching 252
 mode 290
 parking aid 242
 rear lights 251
 safety lug 253
 tow rope 251
- Trailer weights 290
- Transporting children 91
- Transporting items
 fastening rings 167
 roof carrier 170
 roof carrier system 170
- Transporting objects
 net bag 168
 retaining hooks 168
 roof carrier system 172
 tailboard for transporting long items 166
- Trims
 cleaning 259
- Turn signal convenience function 141
- Turn signal lever 141
- Tyre Mobility Set 65
 components 96
 inflating a tyre 96
 sealing a tyre 96
- Tyre Mobility System
see Anti-puncture kit 95
- Tyre monitoring system 283
 tyre monitoring indicator 285
- Tyre pressure 280, 291
- Tyre profile 281
- Tyre repair 95
 Tyre repair kit 95
see also Anti-puncture kit 95
- Tyres 279
 accessories 279
 changing 66
 dimensions 281
 interchanging 281
 new tyres 281
 repair kit 95
 service life 280
 tyre pressure 280
 wear indicators 281
 with compulsory direction of rotation 68
 with directional tread pattern 279
- Tyre tread depth 281
- Tyre wear 281
- U**
 Unfastening your seat belt 83
 Unfasten the seat belt 20
 Unlocking and locking 15
 by remote control 127
 with Keyless Access 129
 with the central locking switch 128
- Upholstery: cleaning
 alcantara 263
 upholstery 261
- USB 123
 USB/AUX-IN Port 123
- V**
 Vanity mirror 148
- Vehicle
 data label 289
 identification data 289
 identification number 289
 raising 67
 unlocking and locking with Keyless Access 129
 vehicle identification number 289
- Vehicle battery 61, 277
 assisted starting 70
 charge level 201
 charging 278
 connecting and disconnecting 277
 disconnect and connect 45
 power management 201
 replacing 278
 winter conditions 277
- Vehicle care
 natural leather 263
 windscreen wipers service position 72
- Vehicle interior monitoring and anti-tow system
 activation 134
- Vehicle seats 80
- Vehicle tool kit 66, 95
- Ventilation slits 161
- W**
 Warning triangle 145
 Washing the vehicle 257
 Weights 290

- What negatively affects driving safety? 74
 - Wheel balance 280
 - Wheel bolts 291
 - anti-theft 67
 - caps 66
 - loosening 67
 - tightening torque 283
 - Wheel cover 66
 - Wheels 279, 291
 - chains 291
 - changing 66, 68
 - new wheels 281
 - snow chains 69
 - temporary spare wheel 286
 - wheel cover 66
 - Wheel spanner 95
 - Wheel trim
 - removing 66
 - Windows
 - electric 18, 136
 - removing ice 260
 - Window wiper 148
 - Window wiper blade 32
 - windscreen and rear window wiper blades
 - changing 73
 - cleaning 73
 - Windscreen and rear window wiper blades 97
 - Windscreen washer 61, 148
 - Windscreen washer water
 - capacity 276
 - checking 276
 - topping up 276
 - Windscreen wiper and rear window wiper systems
 - service position 72
 - Windscreen wipers 32, 148
 - functions 149
 - headlight washer system 149
 - heated windscreen washer jets 149
 - lifting the wiper blade 72
 - rain sensor 150
 - replacing the wiper blades 72
 - service position 72
 - special characteristics 149
 - window wiper lever 148
 - Winter conditions
 - battery 277
 - defrosting the windows 260
 - diesel 267
 - snow chains 69
 - taking care of your vehicle 257
 - tyres 287
 - Winter operation
 - headlight washers 149
 - heated windscreen washer jets 149
 - salt on the roads 150
 - Winter tyres 287
 - four-wheel drive 204
 - Wireless Charger 123
- X**
- XDS 187


SEAT S.A. is permanently concerned about continuous development of its types and models. For this reason we ask you to understand, that at any given time, changes regarding shape, equipment and technique may take place on the car delivered. For this reason no right at all may derive based on the data, drawings and descriptions in this current handbook.

All texts, illustrations and standards in this handbook are based on the status of information at the time of printing. Except for error or omission, the information included in the current handbook is valid as of the date of closing print.

Re-printing, copying or translating, whether total or partial is not allowed unless SEAT allows it in written form.

SEAT reserves all rights in accordance with the "Copyright" Act.

All rights on changes are reserved.

 This paper has been manufactured using bleached non-chlorine cellulose.

© SEAT S.A. - Reprint: 15.11.17

Inglés 5F0012720B) (11.17)



5F0012720BJ



SEAT recommends
SEAT **GENUINE OIL**



SEAT recommends
Castrol EDGE Professional