



CITROËN

C3

**HANDBOOK**



## Access to the Handbook



### MOBILE APPLICATIONS

Install the **MyCitroën App** application (content available offline).

Also available in the **Scan MyCitroën** application.



### ONLINE

View or download the handbook at the following address:

<http://service.citroen.com/ACddb/>



Scan this QR Code for direct access.

Select:

- the language,
- the vehicle and body style,
- the issue period of the handbook corresponding to the date of 1<sup>st</sup> registration of the vehicle.



This symbol indicates the latest information available.

# Welcome

---

Thank you for choosing Citroën C3.

This document presents the key information and recommendations required for you to be able to explore your vehicle in complete safety. We strongly recommend familiarising yourself with this document and the Warranty and Maintenance chapter.

Your vehicle will be fitted with only some of the equipment described in this document, depending on its trim level, version and the specification for the country in which it was sold.

The descriptions and illustrations are for guidance only.

Automobiles CITROËN reserves the right to modify the technical specifications, equipment and accessories without having to update this guide.

If ownership of your vehicle is transferred, please ensure this **Handbook** is passed on to the new owner.

## Key



Safety warning



Additional information



Environmental protection feature



Location of the equipment / button described using a black area.

<hr/>		<hr/>		<hr/>	
	<b>Overview</b>	<b>Lighting and visibility</b>	<b>4</b>	<b>In the event of a breakdown</b>	<b>8</b>
<hr/>		<hr/>		<hr/>	
	<b>Driving tips</b>	Exterior lighting control stalk	20	Tool kit	42
<hr/>		Direction indicators	20	Spare wheel	42
	<b>Instruments</b>	Headlamp beam height adjustment	20	Changing a bulb	45
	<b>1</b>	Wiper control stalk	21	Changing a fuse	48
Instrument panel	5	Changing a wiper blade	21	12 V battery	56
Warning and indicator lamps	5	<hr/>		Towing the vehicle	58
Indicators	7	<b>Safety</b>	<b>5</b>	<hr/>	
Trip computer	7	General safety recommendations	23	<b>Technical data</b>	<b>9</b>
<hr/>		Hazard warning lamps	23	Engines technical data	60
	<b>Access</b>	Horn	23	Dimensions	60
	<b>2</b>	Seat belts	24	Identification markings	60
Key	9	Airbags	26	<hr/>	
Key with remote control function	9	Child seats	28	<b>10" Touch Screen</b>	<b>10</b>
Central locking	10	Child lock	30	<hr/>	
Back-up procedures	10	<hr/>		<b>Alphabetical index</b>	<b>■</b>
Doors	11	<b>Driving</b>	<b>6</b>	<hr/>	
Boot	11	Driving recommendations	31	<hr/>	
Windows	12	Starting / Switching off the engine	31	<hr/>	
<hr/>		5-speed manual gearbox	32	<hr/>	
	<b>Ease of use and comfort</b>	6-speed manual gearbox	32	<hr/>	
	<b>3</b>	Gear efficiency indicator	33	<hr/>	
Front seats	14	Overspeed alert	33	<hr/>	
Steering wheel adjustment	15	Parking sensors	33	<hr/>	
Rear seats	15	<hr/>		<hr/>	
Heating and Ventilation	16	<b>Practical information</b>	<b>7</b>	<hr/>	
Manual air conditioning	17	Refuelling	35	<hr/>	
Front demist - defrost	18	Bonnet	35	<hr/>	
Interior fittings	18	Engine compartment	36	<hr/>	
Front courtesy lamps	19	Checking levels	37	<hr/>	
Boot fittings	19	Checks	39	<hr/>	
<hr/>		Advice on care and maintenance	41	<hr/>	

## Instruments and controls

These illustrations and descriptions are provided for information only. The presence and location of certain elements may vary, depending on the version or trim level.

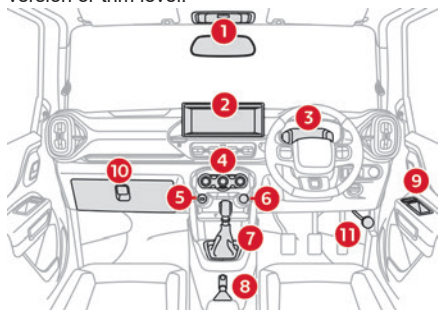

1. Interior rear view mirror  
Courtesy lamp
2. Open storage or Touch screen
3. Instrument panel
4. Manual air conditioning  
Front demisting/defrosting
5. USB socket
6. 12 V socket
7. Gear shift lever
8. Parking brake
9. Electric windows
10. Closed storage or Glove box
11. Bonnet release

## Steering mounted controls

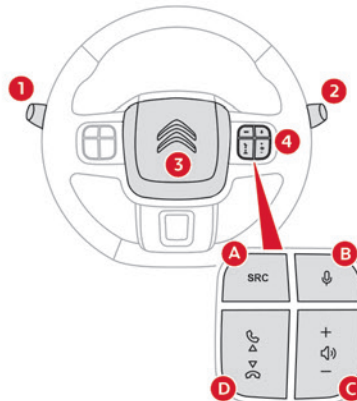

1. Wiper control stalk
2. Lighting control stalk  
Direction indicators
3. Horn
4. Audio system controls
- A. Audio source selection
- B. Voice command
- C. Short press on the buttons: decrease /  
increase volume  
Long press on the decrease button: mute  
audio system
- D. Select previous / next media  
Accept / reject incoming call

## Side controls

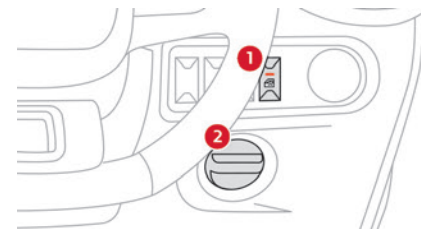

1. Rear window control deactivation
2. Headlamp adjustment

## Driving tips

### Improving fuel economy

The following tips will help you in improving fuel economy.

- Avoid excessive idling.
- Avoid sudden acceleration.
- Avoid unnecessary deceleration and stopping.
- Keep steady cruise speed as much as possible.

### Keep the air filter clean

If the air cleaner is clogged with dust, there will be greater intake resistance, resulting in decreased power output and increased fuel consumption.

### Keep tire pressures correct

Underinflating of the tires can waste fuel due to increased running resistance of the tires. Keep your tires inflated to the correct pressure shown on the label on the driver's door lock pillar.

**!** Do not use tires other than those specified by Citroën. Never use different sizes or types of tires on the front and rear wheels.

### Driving on hills

When climbing steep hills, the vehicle may begin to slow down and show a lack of power. If this happens, you should shift to a lower gear so that the engine will again be operating in its normal power range

While driving down a hill, never turn off the vehicle.

Try not to hold the brake pedal down too long or too often while going down a long hill. This could cause the brakes to overheat, resulting in reduced braking efficiency.

**!** Use the parking brake when parking your vehicle and shift the gear shift lever into the first gear or reverse gear position for the sake of safety.

### Driving on slippery roads

Under wet road conditions, you should drive at a lower speed than on dry roads due to possible slippage of tires during braking. When driving on icy, snow-covered, or muddy roads, reduce your speed and avoid sudden acceleration, abrupt braking, or sharp steering movements.

**!** Vehicle may **break-down**, meet with an **accident** or **catch fire** due to:

- Installation of:
  - High wattage bulbs
  - Non genuine lamps / horns
  - Modified suspension / wheels
  - Non genuine parts / accessories etc.
- Short circuiting due to tampering of wiring harness.

**!** Do not store or carry inflammable materials in the vehicle.

**!** Avoid driving into or starting the vehicle in a heavily water logged area. Vehicle

may break-down or engine may fail due to:

- Water entry into the engine.
- Short circuiting of the electrical systems.
- EVAP (Evaporative Emission Control System) malfunction.

If the vehicle is stuck into deep water, do not start / crank the vehicle until the level of water drops below the level of exhaust pipe.

If the vehicle is submerged in water, report to the nearest authorized workshop.

## Instrument panel

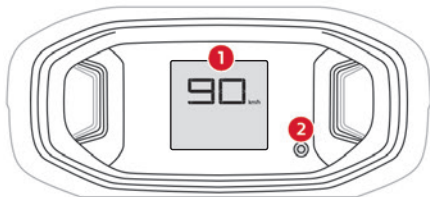

1. Display screen
2. Trip computer button

## Display screen

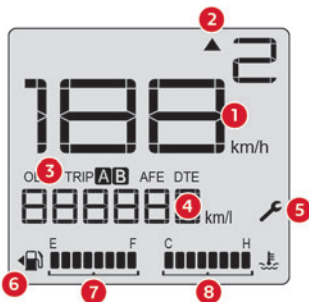

1. Speedometer
2. Gear shift indicator
3. Trip meter A/B  
Odometer (ODO)  
Average Fuel Economy (AFE)  
Distance To Empty (DTE)  
Illumination level

4. Applicable units for displayed information
5. Service indicator
6. Fuel lid cap direction indication
7. Fuel gauge
8. Engine coolant temperature (°C)

## Warning and indicator lamps

Displayed as symbols, the warning and indicator lamps inform the driver of the occurrence of a malfunction (warning lamps) or of the operating status of a system (operation or deactivation indicator lamps). Certain lamps light up in two ways (fixed or flashing) and/or in several colours.

### Associated warnings

The illumination of a lamp may be accompanied by an audible signal and/or a message displayed in a screen.

Relating the type of alert to the operating status of the vehicle allows you to determine whether the situation is normal or whether a fault has occurred: refer to the description of each lamp for further information.

### When the ignition is switched on

Certain red or orange warning lamps come on for a few seconds when the ignition is switched on. These warning lamps should go off as soon as the engine is started.

For more information on a system or a function, refer to the corresponding section.

## Warning lamp continuously lit

The illumination of a red or orange warning lamp may indicate the occurrence of a fault that needs further investigation.

### If a warning lamp remains lit

The references (1), (2) and (3) in the warning and indicator lamp description indicate whether you should contact a qualified professional in addition to the immediate recommended actions.

(1): **You must stop the vehicle.**

Stop as soon as it is safe to do so and switch off the ignition.

(2): Contact a CITROËN dealer.

(3): Visit a CITROËN dealer.

## List of warning and indicator lamps

### Red warning/indicator lamps

#### STOP



Fixed, associated with another warning lamp, accompanied by an audible signal (single tone buzzer).

It indicates a serious fault with the engine, low engine oil & coolant temperature warning, braking system, airbag malfunction or a major electrical fault.

Carry out (1) and then (2).

**Maximum engine coolant temperature**

Fixed.

The temperature of the cooling system is too high.

Carry out (1), then wait until the engine has cooled down before topping up the level, if necessary. If the problem persists, carry out (2).

**Engine oil pressure**

Fixed.

Oil pressure is insufficient.

Carry out (1) and then (2).

**12 V battery charge**

Fixed.

The battery charging circuit has a fault (dirty terminals, slack or cut alternator belt, etc.). Carry out (1).

Clean and retighten the terminals. If the warning lamp does not go off when the engine is started, carry out (2).

**Parking brake**

Fixed.

The parking brake is applied or not properly released.

**Brake system**

Fixed when the ignition is ON.

The Electronic Brake Distribution (EBD) or the brake system has a fault or the brake fluid level has dropped significantly. If necessary, top up with fluid that complies with the manufacturer's recommendations. If the problem persists, carry out (2).



Fixed when driving.

The brake system has a fault.

Carry out (1) then (2).

**Airbags**

Fixed.

The airbag system is faulty.

Carry out (3).

**Door(s) open**

Fixed.

An audible signal supplements the alert if the speed is higher than 5 km/h.

A door or the boot is not properly closed.

**Seat belts not fastened/unfastened**

Fixed or flashing, accompanied by an increasing audible signal.

A seat belt has not been fastened or has been unfastened.

**Orange warning/indicator lamps****Anti-lock braking system (ABS)**

Fixed.

The anti-lock braking system has a fault. The vehicle retains conventional braking. Drive carefully at moderate speed, then carry out (3).

**Engine self-diagnostic system**

Fixed.

The engine system or emissions control system has a fault. The warning lamp should go off when the engine is started. Carry out (3) quickly.

**Power steering**

Fixed.

The power steering has a fault.

Drive carefully at moderate speed, then carry out (3).

**Low fuel level**

Fixed, with the reserve level shown in orange, accompanied by an audible signal.

When it first comes on, there are **approximately 5 litres of fuel** remaining in the tank (reserve).

Until the fuel level is topped up, this alert will be repeated every time the ignition is switched on, with increasing frequency as the fuel level decreases and approaches zero. Refuel without delay to avoid running out of fuel.

**Never drive until completely empty**, as this could damage the fuel pump, the emissions control and injection systems.

**Green warning/indicator lamps****Direction indicators**

Direction indicators with audible signal.



The direction indicators are on.

**Dipped beam headlamps**

Fixed.

The lamps are on.

**Blue warning/indicator lamps****Main beam headlamps**

Fixed.

The lamps are on.



## Black/white warning lamps

### Service



Flashing.  
A fault has been detected.

Carry out (3).



Fixed.  
The servicing interval has been exceeded.

Your vehicle must be serviced as soon as possible. Carry out (3).

## Indicators

### Service indicator

The vehicle servicing must be done according to the distance covered (kilometres or miles) or the time elapsed since the last service.

The servicing alert is given at whichever of these two terms is reached first.

### Service indicator



Fixed, when the ignition is switched on.  
The next service is due.

Have your vehicle serviced very soon.

## Engine coolant temperature indicator

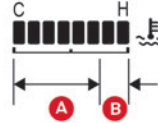

With the engine running:

- In zone **A**, the temperature is correct.
- In zone **B**, the temperature is too high; the associated warning lamp comes on in red on the instrument panel, accompanied by an audible signal.

**You must stop the vehicle as soon as it is safe to do so.**

Wait a few minutes before switching off the engine.

**!** After switching off the ignition, carefully open the bonnet and check the coolant level.

**i** For more information on **Checking levels**, refer to the corresponding section.

## Trip computer

### Data displayed



- Make a short press on the button located on the instrument panel to display and switch between the following information:
- Odometer
  - Trip A
  - Trip B
  - Average Fuel Economy (AFE)
  - Distance To Empty (DTE)
  - Illumination level (park lamp on then press the trip button to adjust the illumination level of the cluster)

## Resetting data

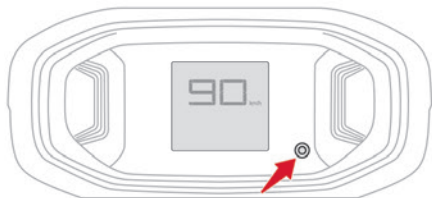

► Make a long press (more than 2 seconds) on the button located on the instrument panel to reset the information displayed in the following screens:.

- Trip A
- Trip B
- Average Fuel Economy (AFE)

## Definitions

### Odometer

(km)

The total distance the vehicle has driven.

### Trip meter A/B

(km)

The distance travelled in short trips or between fuel stops.

Trips "A" and "B" are independent and are used identically.

### Average Fuel Economy (AFE)

(km/L)

The average fuel consumption calculated based on the last trip.

### Distance To Empty (DTE)

(km)

The distance which can still be travelled with the fuel remaining in the tank (based on the current driving conditions).

This value may vary following a change in the style of driving or the terrain, resulting in a significant change in the current fuel consumption.

If dashes instead of figures continue to be displayed when driving, contact a CITROËN dealer.

## Key

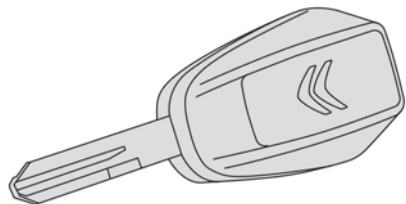

The key allows the central locking or unlocking of the vehicle using the door lock. It also allows the engine to be started or switched off.

## Key with remote control function

### Remote control function

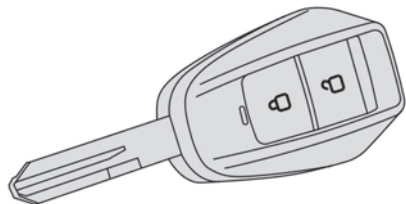

The remote control can be used for the following remote functions, depending on version:

- Unlocking / Locking the vehicle.
- Locating the vehicle.

### Key

The key allows starting and switching off the engine. It can also be used to lock/unlock the vehicle.

## Unlocking the vehicle

### With the remote control



- ▶ Press this button to unlock the vehicle.

The direction indicators blink twice to signal unlocking of the vehicle.

### With the key

- ▶ Turn the key in the driver's door lock **clockwise** to unlock.

## Locking the vehicle

### With the remote control



- ▶ Press this button to lock the vehicle.

The direction indicators blink once to signal the locking of the vehicle.

If one of the doors or the boot is still open, the central locking does not work; the vehicle locks, then immediately unlocks, identifiable by the locks making a rebound sound.



When the vehicle is locked, if it is unlocked without the opening of a door or the boot, it will automatically lock itself again after thirty seconds.

### With the key

- ▶ Turn the key in the driver's door lock **anticlockwise** to lock.



Check that the doors and boot are fully closed.

## Locating the vehicle

This function helps you to spot your vehicle from a distance, with the vehicle locked.



- ▶ Press this button.

The direction indicators or daytime running lamps/sidelamps, depending on version, flash or light up for a few seconds.

## Advice



### Remote control

The remote control is a sensitive, high-frequency device; avoid handling it in your pocket, due to the risk of unintentionally unlocking the vehicle.

Avoid pressing the remote control buttons while out of range of the vehicle, due to the risk of rendering the remote control inoperative. It would then be necessary to reset it.

The remote control does not work when the key is in the ignition switch.

**!** As a safety precaution, remove the key from the ignition when leaving the vehicle, even for a short time.

**!** Do not modify the electronic vehicle immobiliser, as this might result in malfunctions.  
Remember to remove the key and turn the steering wheel to engage the steering lock.

**!** Driving with the doors locked could make it more difficult for the emergency services to enter the vehicle in an emergency.

## Automatic (anti-intrusion security)

The doors and boot lock automatically when driving (speed above 4-5 km/h).

## Driver's door

► Turn the key anticlockwise to lock it, or clockwise to unlock it.

## All doors

► Use the manual knob in the driver's door to lock in the four doors and close the doors.

## Changing the remote control battery

Battery ref.: CR2032/3 Volts.

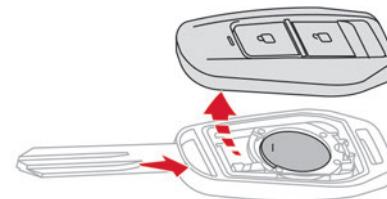

- Hold the key blank and pull the key top cover in opposite direction.
- Remove the discharged battery from its housing.
- Insert the new battery, observing the polarity, and clip the cover onto the housing.

**!** Do not throw remote control batteries away, as they contain metals that are harmful to the environment. Take them to an approved disposal point.

## Central locking

### Manual

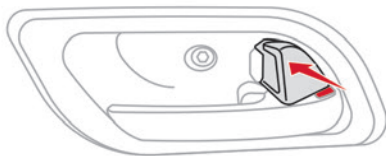

► Push/pull this knob located on the driver's door handle to lock/unlock the doors from inside the vehicle.

When the doors are locked, the red indicator is no longer visible.

**!** The central locking does not take place if one of the doors is open.

## Back-up procedures

### Lost keys, remote control

Visit a CITROËN dealer with the vehicle's registration certificate, a personal identification document and, if possible, the label bearing the key code.

The CITROËN dealer will be able to retrieve the key code and the transponder code required to order a new key.

### Central locking not functioning

Use these procedures in the following cases:

- Central locking malfunction.
- Battery disconnected or discharged.

**!** In the event of a malfunction of the central locking system, the battery must be disconnected to ensure that the vehicle is locked fully.

## Doors

### Opening

#### From outside

► After unlocking the vehicle, pull the door handle.

#### From inside

► Pull the interior opening control of a door; this unlocks the vehicle completely.



► Lift the opening lever located besides the driver's seat to open the tailgate.

### Closing

 If a door is not properly closed, this warning lamp comes on accompanied by an audible signal when the vehicle is travelling at more than 5 km/h.

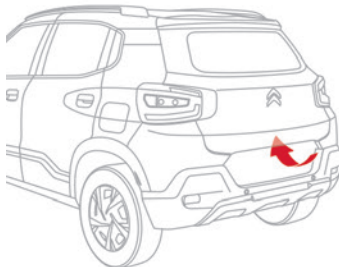

► Lift the tailgate.  
or

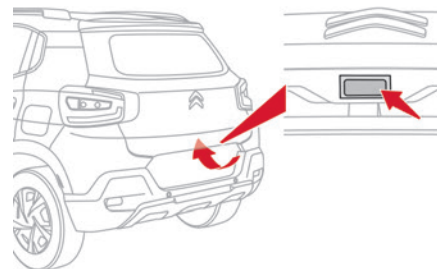

► Press the switch located on the tailgate bottom to open the tailgate.  
► Lift the tailgate.

### Closing

► Lower the tailgate using the interior grab handle.

 If the tailgate is not properly closed, this warning lamp comes on accompanied by an audible signal, if the vehicle is travelling at more than 5 km/h.

### Back-up release

To manually unlock the boot in the event of a battery or central locking failure.

## Boot

### Opening

Depending on version:

### To unlock the boot

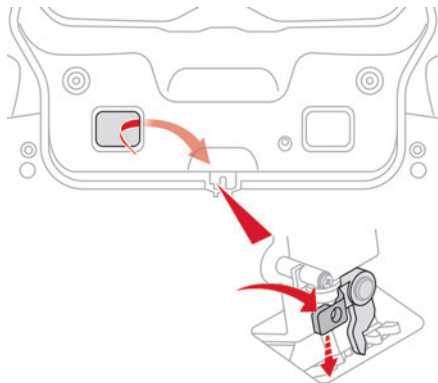

- ▶ Fold the rear seats to gain access to the lock from inside the boot.
- ▶ Insert the hand inside the tailgate right cutout area.
- ▶ Press the lever downwards to release the lock.

**Next option to unlock the boot:**

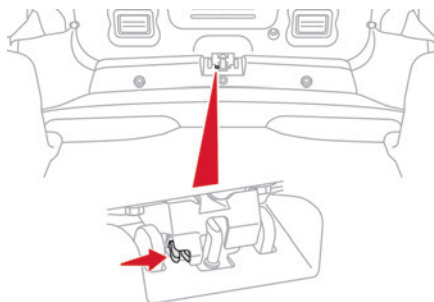

- ▶ Fold the rear seats to gain access to the lock from inside the boot.
- ▶ Press the lever by following the arrow direction to release the lock.

### To re-lock the boot

If the problem persists, the boot will remain locked after opening and closing.

## Windows

### Electric windows

#### Control switch at driver door



1. Left-hand front
2. Right-hand front

#### Control switch at console (depending on version)



3. Left-hand rear
4. Right-hand rear

### Operation

#### Opening

- ▶ Press the switch; the window stops as soon as the switch is released.
- ▶ One touch-down: press the switch past its resistance point; the window opens completely when the switch is released.

#### Closing

- ▶ Pull the switch; the window stops as soon as the switch is released.

## Rear manual windows

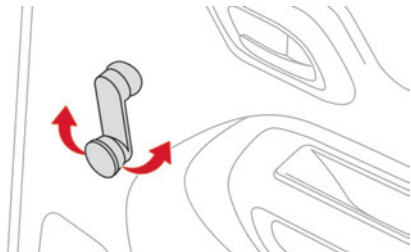

- ▶ Turn the window handle located on the door panel.

## Correct driving position

**!** For safety reasons, adjustments must only be made when the vehicle is stationary.

Before taking to the road and to make the most of the ergonomic layout of the instruments and controls, carry out these adjustments in the following order:

- seat backrest angle.
- seat cushion height.
- longitudinal seat position.
- steering wheel height.
- rear view mirror and door mirrors.
- seat belt fastened.

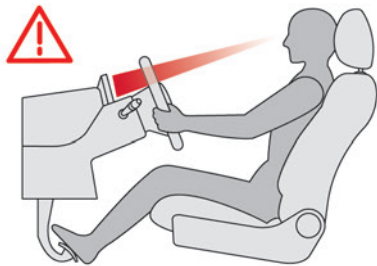

**!** Once these adjustments have been made, check that the instrument panel can be viewed correctly from your driving position.

## Front seats

**!** Before moving the seat backwards, ensure that there is nothing that might prevent the full travel of the seat. There is a risk of trapping or pinching passengers if present in the rear seats or jamming the seat if large objects are placed on the floor behind the seat.

### Longitudinal adjustment

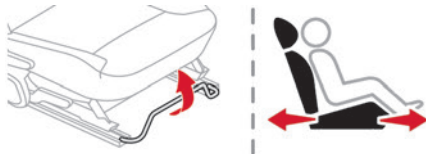

- ▶ Raise the control bar and slide the seat forwards or backwards.
- ▶ Release the bar to lock the seat in position on one of the runners.

### Backrest angle adjustment



- ▶ Raise the control lever to the maximum height in order to avoid noise and mechanism failure.

### Height adjustment

(Driver only, depending on version)

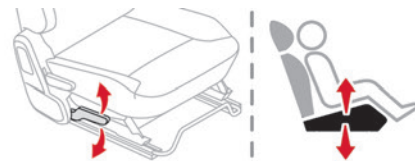

- ▶ Raise or lower the control as many times as needed.

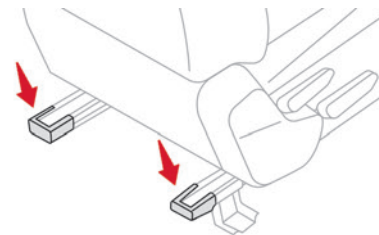

**!** Avoid stepping on these plastic parts  
- Risk of injury or damaging the components!



## Steering wheel adjustment

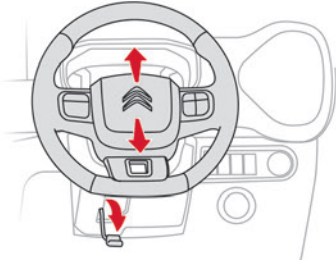

- ▶ When stationary, hold the steering wheel on one hand and pull the control lever to release the steering wheel.
- ▶ Adjust the height to suit your driving position.
- ▶ Push the control lever to lock the steering wheel.

**!** As a safety measure, these adjustments must only be carried out with the vehicle stationary.

## Door mirrors

**!** Objects viewed in the door mirror on the passenger side are closer than they appear. Be careful when moving to the right. Using only this mirror could cause an accident. Use the inside mirror or glance over

your shoulder to properly judge distances to other objects.

**!** Do not adjust the mirrors while driving. You could lose control of your vehicle and cause an accident.

## Manual adjustment

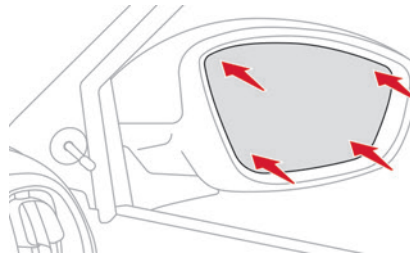

- ▶ Move directly the mirror in any direction to adjust it.

## Manual adjustment with the control

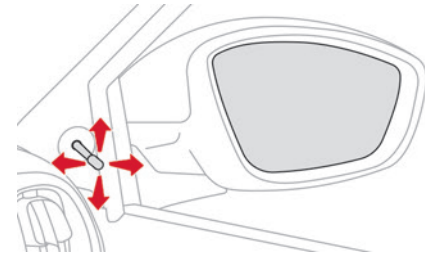

- ▶ Move the lever in any direction to adjust it. If the mirror unit has come out of its initial position, with the vehicle stationary, push it back into place manually or use the control. There is no risk of breakage, even in frosty weather.

## Manual folding

The mirrors can be folded manually (parking obstruction, narrow garage, etc.).

- ▶ Turn the mirror towards the vehicle.

## Rear seats

### Folding the backrest

**!** Manoeuvring the seat backrest should only be done when the vehicle is stationary.

- ▶ If necessary, move the front seats forward.
- ▶ Check that no person or object will interfere with folding down the backrest (clothing, luggage, etc.).
- ▶ Check that the outer seat belts are lying flat on the backrest.

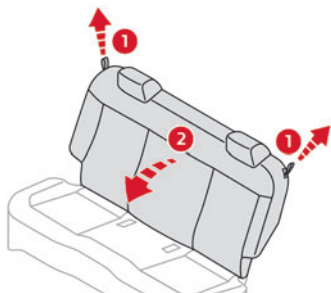

- ▶ Pull the rope **1** up and fold the backrest **2** inwards to increase boot space.

## Repositioning the backrest

**!** First check that the outer seat belts are lying vertically flat alongside the backrest latching rings.

- ▶ Put the backrest **2** in the upright position and push it firmly to latch it home.
- ▶ Ensure that the outer seat belts were not trapped during the operation.

**!** Please note: an incorrectly latched backrest compromises the safety of

passengers in the event of sudden braking or an accident.

The contents of the boot may be thrown forward - risk of serious injury!

4. Central outlets
5. Floor outlets

## Advice

### **i** Using the ventilation and air conditioning system

- ▶ To ensure that air is distributed evenly, keep the external air intake grilles at the base of the windscreen, the nozzles, the vents, the air outlets and the air extractor in the boot free from obstructions.
- ▶ Operate the air conditioning system for at least 5 to 10 minutes once or twice a month to keep it in perfect working order.
- ▶ If the system does not produce cold air, switch it off and contact a CITROËN dealer.

**!** Avoid driving for too long with the ventilation off or with prolonged operation of interior air recirculation. Risk of misting and deterioration of the air quality!

**☘** If the interior temperature is very high after the vehicle has stood for a long time in the sunshine, drive with the windows open for a few moments to air the passenger compartment. Put the air flow control at a setting high enough to quickly change the air in the passenger compartment.

## Heating and Ventilation

### Air intake

The air circulating in the passenger compartment is filtered and originates either from the exterior, via the grille located at the base of the windshield, or from the inside in air recirculation mode.

### Controls

The controls are grouped together in the control panel on the centre console.

### Air distribution

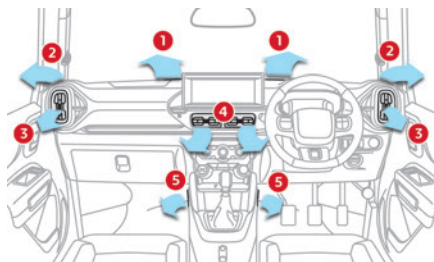

1. Windshield defroster outlets
2. Side defroster outlets
3. Side outlets

**i** Condensation created by the air conditioning results in a discharge of water underneath the vehicle. This is perfectly normal.

### **i** Servicing the ventilation and air conditioning system

- ▶ Ensure that the passenger compartment filter is in good condition and have the filter elements replaced regularly.
- ▶ To ensure correct operation of the air conditioning system, have it checked according to the recommendations in the Maintenance and Warranty Guide.

## Manual air conditioning

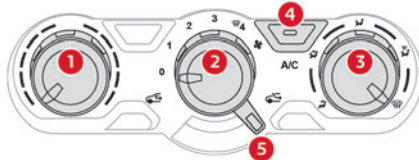

1. Temperature adjustment
2. Air flow adjustment
3. Air distribution adjustment
4. Air conditioning on/off
5. Interior air recirculation

## Temperature adjustment

- ▶ Turn the thumbwheel **1** to adjust the temperature to your requirements.

## Air flow adjustment

- ▶ Turn the thumbwheel **2** to choose the speed of the ventilation fan (from 0 to 4). When the air flow is reduced to a minimum, ventilation stops.

## Air distribution adjustment

You can vary the air distribution turning the thumbwheel **3** to the desired position:



Ventilation

Temperature-controlled air comes out of the center and side outlets.



Bi-level ventilation

Temperature-controlled air comes out of the floor outlets and cooler air comes out of the center and side outlets. When the temperature selector **1** is in the fully cold or fully hot position, the air from the floor outlets and the air from the center and side outlets will be the same temperature.



Heat

Temperature-controlled air comes out of the floor outlets and the side outlets. a small amount of air comes out of the windshield defroster outlets and also comes slightly out of the side defroster outlets.



Heat and defrost

Temperature-controlled air comes out of the floor outlets, the windshield defroster outlets, the side defroster outlets and the side outlets.



Defrost

Temperature-controlled air comes out of the windshield defroster outlets, the side defroster outlets and the side outlets.

## Air conditioning on / off

The air conditioning system is designed to operate effectively in all seasons, with the windows closed.

It is used to:

- lower the temperature in summer,
- increase the effectiveness of the demisting in winter, above 3°C.

- ▶ Press button **4** to activate/deactivate the air conditioning system.

**i** Air conditioning does not operate when the air flow is disabled.

To obtain cool air more quickly, enable interior air recirculation for a brief period. Then return to the intake of exterior air.

Switching off the air conditioning may result in some discomfort (humidity or misting).

## Interior air recirculation



► Place the thumbwheel **5** in this position to activate interior air recirculation.

When this position is selected, outside air is shut off and inside air is recirculated. This mode is suitable when driving through an area with polluted air such as a tunnel or when attempting to quickly cool down the vehicle.

► To restore exterior air intake, place the thumbwheel in any other position.

Outside air is introduced.

## Front demist - defrost



Place the air flow adjustment and the air distribution thumbwheels **2** and **3** to the defrost position.

## Interior fittings

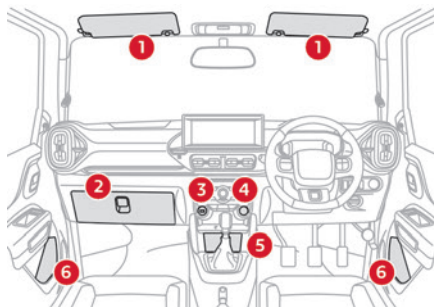

1. Sun visor
2. Closed storage or glove box
3. USB socket
4. 12 V socket
5. Storage compartment  
Cupholders
6. Door pockets

## Glove box

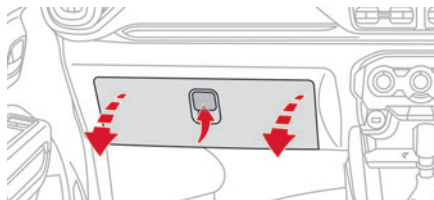

► To open the glove box, raise the handle.

**!** Never drive with the glove box open when a passenger is at the front. It may cause injury during sharp deceleration!

## USB sockets

(Depending on version.)

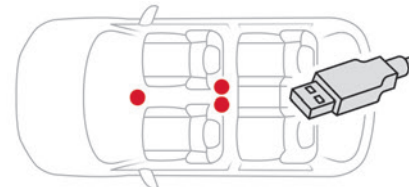

They allow the connection of a portable device to charge the device.

USB port located at the front allows iPod and USB drive to be connected for audio/video. Two rear USB ports are for charging purpose only, with quick charge facility on supported smartphones.



The USB port located **at the front** allows USB media playback and smartphone connection for Android Auto® or CarPlay®, so that certain smartphone applications can be used on the touch screen. To achieve the best results, it is necessary to use a cable made or approved by the device manufacturer.

These applications can be managed using the steering mounted controls or those of the audio system.

## 12 V socket



► To connect a 12 V accessory (maximum power: 120 W), lift the cover and plug in the correct adapter.

**!** Do not exceed the maximum power rating of the socket (you may otherwise damage your portable device).

## Front courtesy lamps

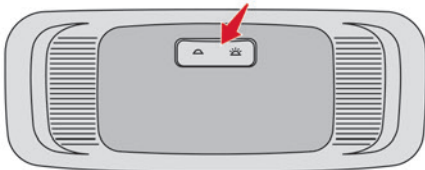

### Model 1 (without microphone)

The switch has 2 positions:



Permanently off.



Permanent lighting (with key in "ACC", "Ignition" or "Start" position)

### Model 2 (with microphone)

The switch has 3 positions:



Permanently off.



Permanent lighting, irrespective of the doors status.

When the switch is in the middle position, it is in **AUTO** mode:

- The lamp switches ON when any of the doors is open.
- The lamp dims and goes OFF upon closing of all doors.
- The lamp goes OFF with ignition ON and all doors closed properly.

## Boot fittings

### Hooks

They are used to hang shopping bags.





Take care to only hang lightweight bags (max. 3 kg).

## Exterior lighting control stalk

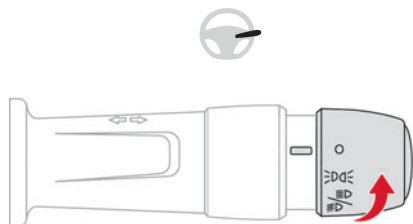
### Main lighting



-  Lighting off (ignition off)
-  Sidelamps only
-  Dipped or main beam headlamps

### Headlamp dipping

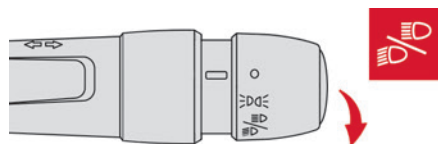

- ▶ Turn and align the selection ring to switch between dipped and main beam headlamps. In the lighting off and sidelamps modes, the driver can switch on the main beam headlamps

temporarily ("headlamp flash") by pulling up the stalk.

#### **i** Switching on the lamps after switching off the ignition

To reactivate the lighting control, rotate the ring to the "0" position - lamps off, then to the desired position.

If the driver's door is opened, a temporary audible signal warns the driver that the lamps are on.

**i** In some weather conditions (e.g. low temperature or humidity), the presence of misting on the internal surface of the glass of the headlamps and rear lamps is normal; it disappears after the lamps have been on for a few minutes.

### Direction indicators

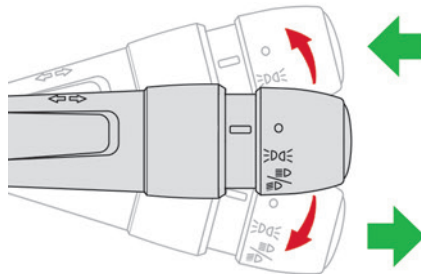

- ▶ Left or right: lower or raise the lighting control stalk, beyond the point of resistance.

### Three flashes

- ▶ Press briefly upwards or downwards, without going beyond the point of resistance; the direction indicators will flash 3 times.

### Headlamp beam height adjustment

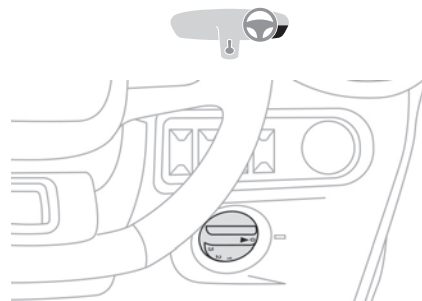

To avoid disturbing other road users, the height of the headlamp beams should be adjusted according to the load in the vehicle.

Knob switch position	Static loading condition
0	Driver only

Termination of the screenwash is followed by a final wiping cycle.

**!** To avoid damaging the wiper blades, do not operate the screenwash if the screenwash reservoir is empty. Only operate the screenwash if there is no risk of the fluid freezing on the windscreen and hindering visibility. During the winter period, use "very cold climate" rated products. Never top up with water.

## Changing a wiper blade

### Before removing a front wiper

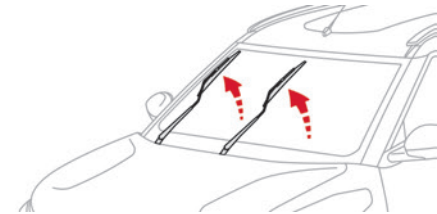

► Within one minute after switching off the ignition, operate the wiper stalk to position the wiper blades vertically on the windscreen.

or

► A minute after switching off the ignition, straighten the arms manually.

### Removing

► Lift the corresponding wiper arm.

## Windscreen wipers

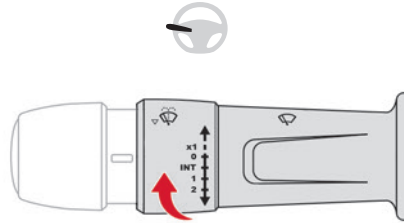

► To select the wiping speed: raise or lower the stalk to the desired position.

x1	Single wiping / Mist
0	Off
Int	Intermittent wiping
1	Slow wiping
2	Fast wiping

### Single wipe

► Pull the stalk briefly towards you.

### Front screenwash

► Pull the wiper control stalk towards you and hold.

The screenwash and windscreen wipers operate for as long as the control stalk is pulled.

Knob switch position	Static loading condition
0	Driver + 1 passenger
1	All the seats occupied
2	All the seats occupied + load evenly distributed in the boot
3	Driver + load evenly distributed in the boot

## Wiper control stalk

**i** In wintry conditions, remove snow, ice or frost present on the windscreen, around the wiper arms and blades and on the windscreen seal, before operating the wipers.

**!** Do not operate the wipers on a dry windscreen. Under extremely hot or cold conditions, ensure that the wiper blades are not stuck to the windscreen before operating the wipers.

- ▶ Unclip the wiper blade and remove it.

### **Refitting**

- ▶ Position and clip the new wiper blade to the arm.
- ▶ Fold down the wiper arm carefully.

### **After refitting a front wiper**

- ▶ Switch on the ignition.
- ▶ Operate the wiper lever again to park the wiper blades.



## General safety recommendations

**!** Do not remove the labels attached in different places on your vehicle. They include safety warnings as well as identification information for the vehicle.

**!** For all work on your vehicle, use a qualified workshop that has the technical information, skills and equipment required, all of which a CITROËN dealer is able to provide.

**!** **Installing electrical accessories:**

- The fitting of electrical equipment or accessories not approved by CITROËN may cause excessive current consumption and failure of the vehicle's electrical system. Contact a CITROËN dealer for information on the range of approved accessories.
- As a safety measure, access to the diagnostic socket, used for the vehicle's electronic systems, is reserved strictly for CITROËN dealers, equipped with the special tools required (risk of malfunctions of the vehicle's electronic systems that could cause breakdowns or serious accidents). The Manufacturer cannot be held responsible if this advice is not followed.
- Any modification or adaptation not intended or authorised by CITROËN or carried out

without meeting the technical requirements defined by the Manufacturer will result in the suspension of the commercial warranty.

## Hazard warning lamps



► Pressing the red button causes all the direction indicators to flash. They can operate with the ignition off.

## Horn



► Press the central part of the steering wheel.

## Anti-lock Braking System (ABS) and Electronic Brake Force Distribution (EBFD)

These systems enhance the vehicle's stability and handling during braking, and enable greater control while cornering, particularly on poor or slippery road surfaces.

ABS prevents wheel locking in the event of emergency braking.

EBFD manages the braking pressure wheel by wheel.

 This warning lamp is continuously on in the event of an ABS malfunction.

The vehicle retains conventional braking. Drive carefully at a moderate speed.

Contact a CITROËN dealer as soon as possible.

 This warning lamp, accompanied by an audible signal, indicates an EBFD malfunction.

**You must stop as soon as it is safe to do so.** Contact a CITROËN dealer.

 The normal operation of the ABS may result in slight vibrations in the brake pedal.

**!** **When braking in an emergency, press the brake pedal very firmly and maintain this pressure.**

**!** When changing wheels (tyres and rims), ensure that these are approved by the manufacturer for your vehicle.

**!** After an impact, have these systems checked by a CITROËN dealer.

## Seat belts

### Inertia reel

The seat belts are equipped with an inertia reel which allows the strap length to automatically adjust to your shape. The seat belt returns to its storage position automatically when it is not used.

The inertia reels are fitted with a device which automatically locks the strap in the event of a collision, emergency braking or if the vehicle rolls over. It can be released by pulling the strap firmly and then releasing it so that it reels in slightly.

### Force limiter

This system reduces the pressure of the seat belt on the chest of the occupant, thus improving their protection.

## Front seat belts

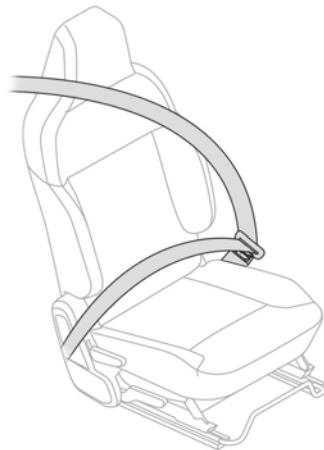

The front driver seat belt is fitted with inertia reel and a force limiting system.

The front passenger seat belt is equipped with inertia reel.

## Rear seat belts

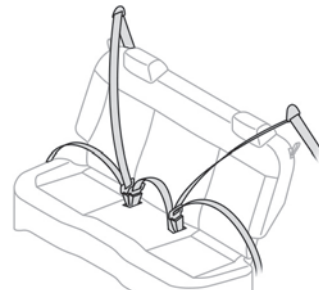

The outer seats have a belt with inertia reel.

- !** Before performing any operations on the rear seats, to avoid damage to the seat belts, check that:
- the outer seat belts are correctly in the storage position, lying vertically along the pillar,
  - the central seat belt is stowed.

## Fastening

- ▶ To fasten the seat belt, pull the webbing and insert the tongue into the buckle.
  - ▶ Check whether the seat belt is fastened correctly by pulling the webbing.
- If the driver or co-driver seat belt is not fastened while the ignition is ON, the seat belt warning lamp chimes and illuminates until the seat belt is fastened.

## Unlocking

- ▶ To unfasten the seat belt, press the red button written "PRESS" on the buckle.
  - ▶ Allow the belt to retract and make sure the webbing is not twisted.
- Twisted webbing would not allow smooth retraction of the belt.

## Seat belt not fastened/ unfastened alerts



It comes on in red in the instrument panel once the system detects that a seat belt is not fastened or is unfastened.

## Advice

- ! The driver must ensure that passengers use the seat belts correctly and that they are all fastened before setting off.
- Wherever seated in the vehicle, you must always fasten the seat belt, even for short journeys.
- Do not interchange the seat belt buckles, as they will not fulfil their role fully.
- Before and after use, ensure that the seat belt is reeled in correctly.
- After folding or moving a seat or rear bench seat, ensure that the seat belt is positioned and reeled in correctly.
- While fastening the seat belt ensure that strap must pass over your chest and top of your

shoulder and not touch your face, neck, side of your shoulder or pass under your arm. An accident or sudden stop could damage the seat belt, please have your seat belts inspected by authorized dealers after an accident or sudden stop. Do not use a damaged seat belt which would result in serious injury.

### ! Installation

The lower part of the strap must be positioned as low as possible on the pelvis. The upper part must be positioned on the shoulder.

In order to be effective, a seat belt:

- must be tightened as close to the body as possible;
- must be pulled in front of you with a smooth movement, ensuring that it is not twisted;
- must only be used to secure one person;
- must not show signs of tearing or fraying;
- must not be changed or modified, in order to avoid affecting its performance.

Do not wear your seat belt over hard or breakable objects in your pockets or on your clothing. If an accident occurs, objects such as glasses, pens, etc. under the seat belt can cause injury.

### ! Recommendations for children

Use a suitable child seat if the passenger is less than 12 years old or shorter than one and a half metres.

Never use the same seat belt to secure more than one child.

Never carry a child on your lap.

For more information on **Child seats**, refer to the corresponding section.

### ! Recommendations for pregnant women

Pregnant women should use seat belts, although specific recommendations about driving should be made by the woman's medical advisor. Remember that the lap portion of the belt should be worn as low as possible across the hips.

A pregnant woman should not wear the seat belt across the stomach which would result in serious injury to the fetus and/or the pregnant mother.

### ! Maintenance

In accordance with current safety regulations, for all repairs on your vehicle's seat belts, go to a qualified workshop with the skills and equipment needed, which a CITROËN dealer is able to provide.

Have the seat belts checked regularly by a CITROËN dealer, particularly if the straps show signs of damage.

Clean the seat belt straps with soapy water or a textile cleaning product, sold by CITROËN dealers.

## Airbags

### General information

The airbags have been designed to optimise the safety of the occupants in the event of a violent collision.

The airbags are supplementary restraint systems (SRS) that help cushion the impact force to the head and chest during severe frontal collisions.

The SRS includes Airbags, Seatbelts, Airbag ECU, Collision sensors and SRS warning lamp. Electronic detectors record and analyse the front impacts sustained in the impact detection zones:

- In the event of violent impact, the airbags deploy instantly and help better protect the occupants of the vehicle; immediately after the impact, the airbags deflate rapidly in order not to hinder the visibility or the possible exit of the occupants.

- In the event of a slight impact, a rear impact and under certain rollover conditions, the airbags may not deploy; only the seat belt helps to protect you in these situations.

During a frontal crash, children could be fatally injured if they are sitting on driver's lap/standing very close to the dashboard, as the airbags exert severe force levels during deployment.

The seriousness of the impact depends on the nature of the obstacle and the speed of the vehicle at the moment of collision.

**!** The airbags do not operate when the ignition is switched off.

This equipment will only deploy once. If a second impact occurs (during the same or a subsequent accident), the airbag will not be deployed again.

**i** When one or more airbags are deployed, the detonation of the pyrotechnic charge incorporated in the system makes a noise and releases a small quantity of smoke.

This smoke is not harmful, but sensitive individuals may experience slight irritation.

The detonation noise associated with the deployment of one or more airbags may result in a slight loss of hearing for a short time.

**!** The airbags will deploy irrespective of whether the seat belt is buckled or not. In order to reduce the risk of SERIOUS INJURY or DEATH, we recommend occupants to always be buckled.

### Front airbags



This system protects the driver and front passenger in the event of a serious front impact, in order to limit the risk of head and chest injuries.

The driver's airbag is fitted in the centre of the steering wheel; the front passenger airbag is fitted in the dashboard above the glove box.

### Deployment

#### 1. Frontal collision

Airbags may deploy during severe front collision when the crash intensity is above the threshold and the angle of impact is less than or equal to 30 degrees with respect to longitudinal axis of vehicle.

#### 2. Collision with utility poles or trees

Airbags may deploy when the vehicle hits pole or tree with sufficient intensity to trigger the airbag. The crash intensity should be above the threshold to inflate the airbag.

#### 3. Underride collision

Airbags may deploy when the vehicle rides under the trucks or vehicles with higher ground clearance. The crash intensity should be above the threshold to inflate the airbag.

## Non-inflation conditions

### 1. Low speed front collisions

The airbags may not deploy if the collision is not severe and below the design threshold intensity. The force of impact is less in this case and much of the protection during low speed crash is provided by seat belts, if properly worn.

### 2. Rear collisions

Frontal airbags are not designed to deploy when there is a rear crash, since the occupants tend to move backwards. In this case, the airbags will not provide any benefit to cushion the force of impact.

### 3. Side collisions

Frontal airbags may not deploy during side crash, since the occupant moves sideways.

### 4. Angled collisions

Airbags may not deploy if the angle of collision is beyond 30 degrees with the head-on vehicle or the rigid wall or curb or pole.

### 5. Roll over collisions

Frontal airbags may not deploy in roll over conditions, as the occupant moves sideways or rolls. Important to wear seat belts in this case, to avoid floating inside the vehicle and risk serious injuries.

### 6. Speed breakers & pot holes

Airbags may not deploy when crossing speed breakers even at high speed or when vehicle drops into pot hole or ditch drop.

### 7. Curb hits

The airbag may not deploy when the vehicle hits the curbs.

### 8. Pedestrian impact

Airbags will not inflate when the vehicle hits the pedestrian.

## Malfunction



If this warning lamp comes on in the instrument panel, you must contact a CITROËN dealer to have the system checked. The airbags may not be deployed in the event of a serious impact.

## Advice

### ! For the airbags to be fully effective, observe the safety recommendations below.

Adopt a normal upright sitting position.

Fasten the seat belt ensuring it is correctly positioned and adjusted.

Do not leave anything between the occupants and the airbags (a child, pet, object, etc.), nor fix or attach anything close to or in the way of the airbag release trajectory; this could cause injuries during their deployment.

Never modify the original definition of your vehicle, particularly in the area directly around the airbags.

After an accident or if the vehicle has been stolen, have the airbag systems checked.

All work on the airbag systems must only be performed by a CITROËN dealer.

Even if all of the precautions mentioned are observed, a risk of injury or of minor burns to the head, chest or arms cannot be ruled out when an airbag is deployed. The airbag inflates almost instantly (within a few milliseconds) then deflates within the same time discharging the hot gas via openings provided for this purpose.

! Do not drive holding the steering wheel by its spokes or resting your hands on the centre part of the wheel.

Passengers must not place their feet on the dashboard.

Do not smoke as deployment of the airbags can cause burns or the risk of injury from a cigarette or pipe.

Never remove or pierce the steering wheel or hit it violently.

Do not fix or attach anything to the steering wheel or dashboard, as this could cause injuries when the airbags are deployed.

## Child seats



**Warning label on the sun visor - Front passenger airbag**

NEVER use a rearward facing child restraint on a seat protected by an ACTIVE AIRBAG in front of it, SERIOUS INJURY to the CHILD may occur.



Do not install a rear-facing child restraint on the front passenger's seat.



A child in a rear-facing child restraint could be seriously harmed if the passenger's front airbag inflates. The inflated airbag would be too close to the back of a rear-facing child restraint.



An incorrectly installed child seat compromises the child's safety in the event of an accident.

Ensure that there is no seat belt or seat belt buckle under the child seat, as this could destabilise it.

Remember to fasten the seat belts or the harness of child seats, keeping the slack

relative to the child's body to a minimum, even for short journeys.

When installing a child seat using the seat belt, ensure that the seat belt is tightened correctly on the child seat and that it secures the child seat firmly on the seat of the vehicle. Ensure that the head restraint is stored or attached securely to prevent it from being thrown around the vehicle in the event of sharp braking. Refit the head restraint once the child seat has been removed.

### **! Additional protections**

To prevent accidental opening of the doors and rear windows, use the "Child lock". Take care not to open the rear windows by more than one third.

To protect young children from the rays of the sun, fit side blinds on the rear windows.

As a safety precaution, do not leave:

- a child alone and unattended in a vehicle,
- a child or an animal in a vehicle which is exposed to the sun, with the windows closed,
- the keys within reach of children inside the vehicle.

## Child restraint system

The suitability of each passenger's seat position for carriage of children and fitting of child restraint system is shown below. Whenever you carry children up to 12 years of age, properly use the child restraints which conform to AIS 072, the standard for child restraints, referring to the table.

MASS GROUP	Seating position (or other site)					
	Front passenger	Rear outboard LH*	Rear centre	Rear outboard RH*	Intermediate outboard*	Intermediate centre
Group 0 Up to 10 kg	X	U	X	X	N.A	N.A
Group 0+ Up to 13 kg	X	U	X	X	N.A	N.A
Group 1 9 to 18 kg	X	U	X	X	N.A	N.A
Group 2 15 to 25 kg	X	U	X	X	N.A	N.A
Group 3 22 to 36 kg	X	U	X	X	N.A	N.A

**U** Suitable for "universal" category restraints approved for use in this mass group.

Universal is the category in the AIS 072.

**X** Seat position not suitable for children in this mass group.

**N.A** Seat position not available for children in this mass group.

## ELR type belt

Install your child restraint system according to the instructions provided by the child restraint system manufacturer.

Make sure the seat belt is securely latched.

Try to move the child restraint system in all directions to make sure it is securely installed.

\* Outboard indicates window side seat.

## Manual child lock

This system prevents opening of a rear door using its interior handle.

The control is located on the edge of each rear door (marked by a label).

### Locking / Unlocking



- ▶ To lock, pull the lever down.
- ▶ To unlock, pull the lever up.

**!** Refer to the legislation in force in your country before using this system.



## Driving recommendations

- ▶ Observe the driving regulations and remain vigilant whatever the traffic conditions.
- ▶ Monitor your environment and keep your hands on the wheel to be able to react to anything that may happen any time.
- ▶ Drive smoothly, anticipate the need for braking and maintain a longer safety distance, especially in bad weather.
- ▶ Stop the vehicle to carry out operations that require close attention (such as adjustments).
- ▶ During long trips, take a break every two hours.

### Important!

! **Never leave the engine running in a closed space without sufficient ventilation.** Internal combustion engines emit toxic exhaust gases such as carbon monoxide. Danger of poisoning and death!

! In severe wintry conditions, let the engine run for 4 minutes before moving off, to ensure the correct operation and durability of the mechanical components of your vehicle (engine and gearbox).

! **Never drive with the parking brake applied.** Risk of overheating and damage to the braking system!

! **Do not park the vehicle or leave the engine running on a flammable surface (dry grass, dead leaves, etc.).** The exhaust system of your vehicle is very hot, even several minutes after the engine stops. Risk of fire!

! **Never leave a vehicle unattended with the engine running.** If you have to leave your vehicle with the engine running, apply the parking brake and put the gearbox into neutral.

! **Never leave children inside the vehicle unsupervised.**

## On flooded roads

We strongly advise against driving on flooded roads, as this could cause serious damage to the engine or gearbox, as well as to the electrical systems of your vehicle.



If you have to drive on a flooded road:  
▶ drive as slowly as possible without stalling. In all cases, do not exceed 10 km/h,

- ▶ do not stop and do not switch off the engine. On leaving the flooded road, as soon as safety conditions allow, make several light brake applications to dry the brake discs and pads. If in doubt about the state of your vehicle, contact a CITROËN dealer.

## Starting / Switching off the engine

### Key ignition switch

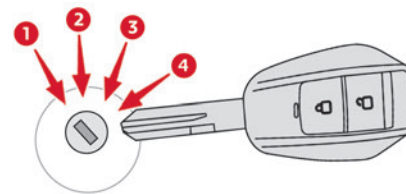

It has 4 positions:

- 1. Stop**  
Inserting and removing the key, steering column locked.
- 2. ACC**  
Steering column unlocked, use of the vehicle's electric equipment.
- 3. ON (Ignition)**  
Steering column unlocked, ignition on, engine running.
- 4. Starting**

**i** Avoid attaching heavy objects to the key or the remote control. It would weigh down on its shaft in the ignition switch and could cause a malfunction.

### Ignition on position

It allows the use of the vehicle's electric equipment or portable devices to be charged.

### Starting the engine

With the parking brake applied:

- ▶ Place the gear lever in neutral then fully depress the clutch pedal.
- ▶ Insert the key into the ignition switch; the system recognises the code.
- ▶ Unlock the steering column by simultaneously turning the steering wheel and the key.

**i** In certain cases, you may have to apply significant force to move the steering wheel (wheels on full lock, for example).

- ▶ Operate the starter motor by turning the key to position **3** without pressing the accelerator pedal, until the engine starts. Once the engine starts, release the key.

**i** After a cold start, preheating the catalytic converter can cause noticeable engine vibrations for anything up to 2 minutes while stationary with the engine running (accelerated idle speed).

**!** If the engine does not start straight away, switch off the ignition. Wait a few seconds before operating the starter motor again. If the engine does not start after a few attempts, do not keep trying - risk of damaging the starter motor, the battery and the engine.  
Contact a CITROËN dealer.

**i** In mild conditions, do not leave the engine at idle to warm up but move off straight away and drive at moderate speed.

## 5-speed manual gearbox

### Engaging reverse gear



- ▶ Fully depress the clutch pedal.
- ▶ Push the gear lever fully to the right, then backwards.

**!** Only engage reverse gear when the vehicle is stationary with the engine at idle.

**i** As a safety precaution and to facilitate starting the engine:

- Always select neutral.
- Depress the clutch pedal.

## 6-speed manual gearbox

### Engaging 5<sup>th</sup> or 6<sup>th</sup> gear

- ▶ Move the gear selector fully to the right to engage 5<sup>th</sup> or 6<sup>th</sup> gear.

**!** Failure to follow this instruction could cause permanent damage to the gearbox (inadvertent engagement of 3<sup>rd</sup> or 4<sup>th</sup> gear).

### Engaging reverse gear

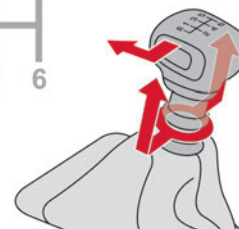

- ▶ Raise the ring under the knob and move the gear selector to the left, then forwards.

**!** Only engage reverse gear when the vehicle is stationary with the engine at idle.

**i** As a safety precaution and to facilitate starting the engine:

- Always select neutral.
- Press the clutch pedal.

## Gear efficiency indicator

This system helps reduce fuel consumption by recommending the most appropriate gear.

### Operation

The system advises to change gear.

**4** The information appears in the instrument panel in the form of an ascending or descending arrow.

The number displayed is the current gear.

Gear shift recommendations should not be considered compulsory. In fact, the road layout, the traffic density and safety remain the deciding factors when choosing the best gear. The driver therefore remains responsible for deciding whether or not to follow the indications issued by the system.

This function cannot be deactivated.

**i** The system adapts its gear shift recommendation according to the driving conditions (slope, load, etc.) and the driver's

requirements (power, acceleration, braking, etc.).

The system never suggests:

- engaging first gear;
- engaging reverse.

## Overspeed alert

An audible overspeed alert is triggered when the vehicle exceeds predefined speed thresholds.

When the vehicle speed is greater than 80 km/h, the alert is emitted every 2 minutes.

When the vehicle speed is greater than 120 km/h, the alert is emitted every 2 seconds.

**i** This system cannot be modified nor deactivated.

## Parking sensors

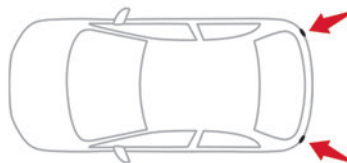

Using sensors located in the bumper, this system signals the proximity of obstacles (e.g. pedestrian, vehicle, tree, barrier) present in their field of detection.

## Rear parking sensors

The system is switched on by engaging reverse gear.

The system is switched off when disengaging reverse gear.

### Audible assistance

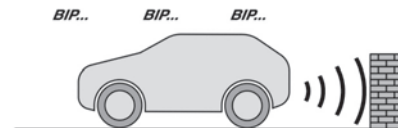

The system signals the presence of obstacles within the sensors' detection zone.

The proximity information is given by an intermittent audible signal, the frequency of which increases as the vehicle approaches the obstacle.

When the distance between the vehicle and the obstacle becomes less than about 60 centimetres, the audible signal becomes continuous.

### Operating limits

If the boot is heavily loaded, the vehicle may tilt, affecting distance measurements.

**i** Manoeuvring aids cannot, in any circumstances, replace the need for vigilance on the part of the driver. The driver must always check the surroundings of the vehicle before and during the whole manoeuvre, in particular using the mirrors.

## Refuelling

**Fuel tank capacity: 30 litres.**

**Reserve level: approximately 5 litres.**

### Low fuel level



When the low fuel level is reached, this warning lamp comes on on the instrument panel, accompanied by an audible signal. When it first comes on, **about 5 litres** of fuel remain. Until sufficient fuel is added, this warning lamp appears every time the ignition is switched on, accompanied by an audible signal. When driving, the audible signal are repeated with increasing frequency as the fuel level drops towards **0**. You must refuel as soon as possible to avoid running out of fuel.

### Refuelling

Additions of fuel must be of at least 5 litres, in order to be registered by the fuel gauge. Opening the filler cap may create a noise caused by an inrush of air. This vacuum is entirely normal, resulting from the sealing of the fuel system.

To refuel in complete safety:

- ▶ **You must switch off the engine.**

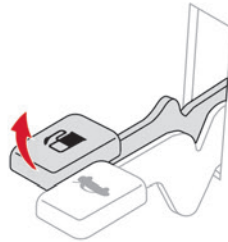

- ▶ Lift the fuel filler flap lever, located on the floor beside the driver's seat, to open the flap.
- ▶ Take care to select the pump that delivers the correct fuel type for the vehicle's engine (see a reminder label on the inside of the filler flap).

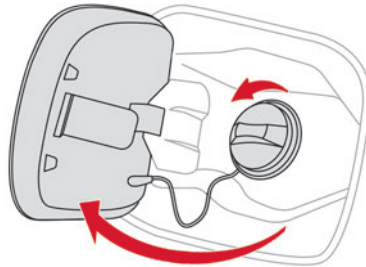

- ▶ Turn the filler cap to the left and remove it.
- ▶ Introduce the filler nozzle and push it in as far as possible before starting to refuel (risk of blowback).
- ▶ Fill the tank.

**Do not continue past the first cut-off of the nozzle, as this may cause malfunctions.**

- ▶ Refit the filler cap.
- ▶ Turn it to the right.
- ▶ Push the filler flap to close it.

**!** If you have put in wrong/dirty/contaminated fuel or H<sub>2</sub>O mixed fuel in the vehicle, you must have the fuel tank drained and filled with the correct fuel before starting the engine. Contact a CITROËN dealer for the fuel system cleaning.

The vehicle is fitted with a catalytic converter, a device which helps to reduce the level of harmful emissions in the exhaust gases.

**You must use unleaded fuel.**

The filler neck is narrower, admitting unleaded petrol nozzles only.

### Fuel cut-off

Your vehicle is equipped with a safety device which cuts off the fuel supply in the event of a collision.

### Bonnet

**!** When the engine is hot, handle the exterior safety catch and the bonnet stay with care (risk of burns), using the protected area.

When the bonnet is open, take care not to damage the safety catch.

Do not open the bonnet under very windy conditions.

**!** **Cooling of the engine when stopped**  
The engine cooling fan may start after the engine has been switched off.  
Take care with objects or clothing that could be caught in the blades of the fan!



KEEP HANDS, HAIR, CLOTHING, ETC. AWAY FROM FAN AND ANY OTHER MOVING PARTS. FAN STARTS AUTOMATICALLY AND MAY CAUSE INJURY.

**!** Water washing in the engine compartment including high pressure water washing may cause the failure of electrical circuits located in the engine compartment.  
Never allow water or other liquids to come in contact with electrical/electronic components inside the vehicle as this may damage them.



## Caution



**DO NOT USE HIGH PRESSURE WATER JET TO WASH ENGINE BAY**

## Opening

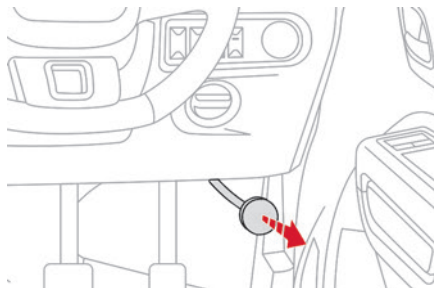

► Pull the release lever towards you.

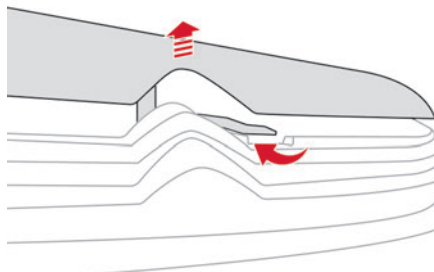

► Lift the safety catch and raise the bonnet.

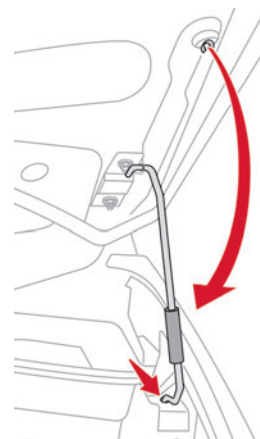

► Unclip the stay from its housing and place it in the support slot to hold the bonnet open.

## Closing

- Take the stay out of the support slot.
- Clip the stay in its housing.
- Lower the bonnet and release it near the end of its travel.
- Pull on the bonnet to check that it is locked correctly.

## Engine compartment

The engines represented are examples given for illustration purposes only.

The locations of the following elements may vary:

- Air filter.
- Engine oil dipstick.
- Engine oil filler cap.

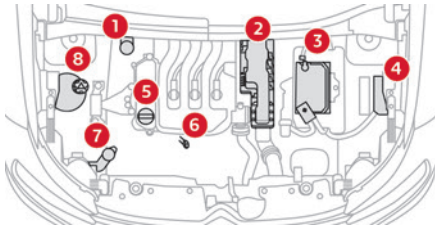

#### NA engine

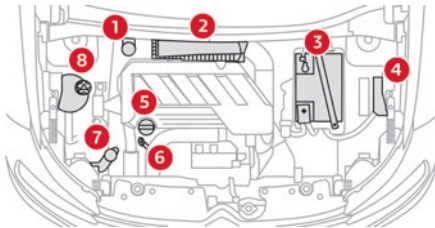

#### Turbo engine

1. Brake fluid reservoir
2. Air filter
3. Battery
4. Fusebox
5. Engine oil filler cap
6. Engine oil dipstick
7. Screenwash fluid reservoir
8. Engine coolant reservoir

## Checking levels

Check all of the following levels regularly in accordance with the manufacturer's service schedule. Top them up if required, unless otherwise indicated.

If a level drops significantly, have the corresponding system checked by a CITROËN dealer.

**!** The fluids must comply with the manufacturer's requirements and with the vehicle's engine.

**!** Take care when working under the bonnet, as certain areas of the engine may be extremely hot (risk of burns) and the cooling fan could start at any time (even with the ignition off).

### Used products

**!** Avoid prolonged contact of used oil or fluids with the skin.

Most of these fluids are harmful to health and very corrosive.

**♻️** Do not discard used oil or fluids into sewers or onto the ground.

Empty used oil into the containers reserved for this purpose at a CITROËN dealer.

## Engine oil



The level is checked, with the engine having been switched off for at least 30 minutes and on level ground, using the dipstick. To know how often the engine oil should be replaced, refer to the manufacturer's servicing schedule.

**!** In order to maintain the reliability of the engine and emissions control system, never use additives in the engine oil.

### Checking using the dipstick

For the location of the dipstick, please refer to the illustration of the corresponding engine compartment.

- ▶ Grasp the dipstick by its coloured grip and pull it out completely.
- ▶ Wipe the end of the dipstick using a clean, lint-free cloth.

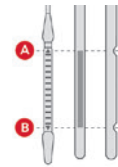

- ▶ Reinsert the dipstick and push fully down, then pull it out again to visually check the oil level: the correct level is between marks **A** (max) and **B** (min).

**Do not start the engine** if the level is:

- above mark **A**: contact a CITROËN dealer.

– below mark **B**: top up the engine oil immediately.

### Oil grade

Before topping up or changing the engine oil, check that the oil is suitable for the engine and complies with the recommendations in the service schedule supplied with the vehicle (or available from your CITROËN dealer). Use of non-recommended oil may invalidate the contractual warranty in the event of engine failure.

## Topping up the engine oil level

For the location of the engine oil filler cap, please refer to the corresponding under-bonnet engine compartment illustration.

- ▶ Add oil in small quantities, avoiding any spills on engine components (risk of fire).
- ▶ Wait a few minutes before checking the level again using the dipstick.
- ▶ Top up the level if necessary.
- ▶ After checking the level, carefully screw the oil filler cap back on and replace the dipstick in its tube.

 Within 30 minutes of adding oil, the oil level indication in the instrument panel when the ignition is switched on is not valid.

## Brake fluid



The level of this fluid should be close to the "**MAX**" mark. If not, check the leakage in the circuit and the brake pad wear.

To know how often the brake fluid should be replaced, refer to the manufacturer's servicing schedule.

-  Clean the cap before removing it to refill.
- Use only DOT3 or DOT4 brake fluid from a sealed container.

## Engine coolant



It is normal to top up this fluid between two services.

The check and top-up must only be done with the engine cold.

A low level presents a risk of serious damage to the engine.

The level of engine coolant should be close to the "**MAX**" mark but should never exceed it. If the level is close to or below the "**MIN**" mark, it is essential to top up.

When the engine is hot, the temperature of engine coolant is regulated by the fan.

As the cooling system is pressurised, wait at least one hour after switching off the engine before carrying out any work.

In order to avoid the risk of burning, if you need to top up in an emergency, wrap a cloth around the cap and unscrew the cap by two turns to allow the pressure to drop.

Once the pressure has dropped, remove the cap and top up to the required level.

## Screenwash fluid



Top up to the required level when necessary.

## Fluid specification

The fluid must be topped up with a ready-to-use mixture.

In winter (temperatures below zero), a liquid containing an agent to prevent freezing must be used which is appropriate for the prevailing conditions, in order to protect the elements of the system (pump, tank, ducts, jets, etc.).

-  Filling with pure water is prohibited under all circumstances (risk of freezing, limestone deposits, etc.).



## Consumables

	Designation	Grade/Specs	Quantity
Engine options	EB2 - NA	5W40 B712296 Synthetic	2.55 Lts
	EB2 G2 Turbo	5W30 B712297 Synthetic	3.1 Lts
Transmission options	Transmission fluid - MA	75W - 80 B13/0067 API GL-4	2.1 ± 0.2 Lts
	Transmission fluid - MB6	75W - 80 B13/0067 API GL-4	1.8 ± 0.2 Lts
HVAC	Compressor Oil	PS R1	120 ml
	AC Refrigerant for EB2 - NA	R134A	425 grams
	AC Refrigerant for EB2 G2 Turbo	R134A	550 grams
Cooling	Coolant (Premixed) for EB2 NA (Antifreeze Coolant 40% + DM / DI Water 60%)	GOLDEN CRUISER LONG LIFE ANTIFREEZE-COOLANT, GC LLC 2200 NP	4.65 ± 0.1 Lts
	Coolant (Premixed) for EB2 G2 Turbo (Antifreeze Coolant 40% + DM / DI Water 60%)	GOLDEN CRUISER LONG LIFE ANTIFREEZE-COOLANT, GC LLC 2200 NP	5.7 ± 0.1 Lts
Brake/Clutch	Brake fluid	DOT3/DOT4	450 ± 50 ml
	Clutch fluid	Clutch fluid line connected with brake reservoir	
Axle	Axle oil	NA	

## Checks

Unless otherwise indicated, check these components in accordance with the manufacturer's service schedule.

Otherwise, have them checked by a CITROËN dealer.

**!** Only use products recommended by CITROËN.

In order to optimise the operation of components as important as those in the braking system, CITROËN selects and offers very specific products.

## 12 V battery



Check regularly during service that the terminals and coin plug caps are clean and tightened.

The battery electrolyte must be filled. If the level is found to be below the "MIN" level line, add distilled water to the "MAX" level line.

**i** For more information on the precautions to take before any work on the **12 V battery**, refer to the corresponding section.

## Passenger compartment filter

 Depending on the environment and the use of the vehicle (e.g. dusty atmosphere, city driving), **change it twice as often, if necessary**.

**i** A clogged passenger compartment filter can adversely affect air conditioning system performance and generate undesirable odours.

## Air filter

 Depending on the environment and the use of the vehicle (e.g. dusty atmosphere, city driving), **change it twice as often, if necessary**.

## Oil filter

 Change the oil filter each time the engine oil is changed.

## Manual gearbox

 The gearbox does not require any maintenance (no oil change).

## Brake pads

 Brake wear depends on the style of driving, particularly in the case of vehicles used in town, over short distances. It may be necessary to have the condition of the brakes checked, even between vehicle services. Unless there is a leak in the circuit, a drop in the brake fluid level indicates that the brake pads are worn.

**i** After washing the vehicle, moisture, or in wintry conditions, ice can form on the brake discs and pads: braking efficiency may be reduced. Gently dab the brakes to dry and defrost them.

## Brake disc and drum wear

 For information on checking brake disc and drum wear, contact a CITROËN dealer.

## Wheels and tyres

 The inflation pressure of all tyres, including the spare wheel, must be checked on "cold" tyres. The pressures indicated on the tyre pressure label are valid for "cold" tyres. If you have driven for more than 10 minutes or more than 10

kilometres at over 50 km/h, add 0.3 bar (30 kPa) to the values indicated on the label.

**!** Under-inflation increases fuel consumption. Non-compliant tyre pressure causes premature wear on tyres and has an adverse effect on the vehicle's road holding - risk of an accident!

Driving with worn or damaged tyres reduces the braking and road holding performance of the vehicle. It is recommended to regularly check the condition of the tyres (tread and sidewalls) and wheel rims as well as the presence of the valves. When the wear indicators no longer appear set back from the tread, the depth of the grooves is less than 1.6 mm; it is imperative to replace the tyres.

Using different size wheels and tyres from those specified can affect the lifetime of tyres, wheel rotation, ground clearance, the speedometer reading and have an adverse effect on road holding.

Fitting different tyres on the front and rear axles can cause ABS and EBD systems to mistime.

## Shock absorbers

 It is not easy for drivers to detect when shock absorbers are worn. Nevertheless, the shock absorbers have a major impact on road-holding and braking performance. For your safety and driving comfort, it is important to have them regularly checked by a CITROËN dealer.

## Timing and accessory kits



Timing and accessory kits are used from the time the engine is started until it is switched off. It is normal for them to wear over time.

A faulty timing or accessory kit can damage the engine, rendering it unusable. Observe the recommended replacement frequency, stated in distance travelled or time elapsed, whichever is reached first.

## Advice on care and maintenance

### General recommendations

Observe the following recommendations to avoid damaging the vehicle.

#### Exterior

**!** Never use a high-pressure jet wash in the engine compartment - risk of damaging the electrical components!  
Do not wash the vehicle in bright sunshine or extremely cold conditions.

**i** When washing the vehicle in an automatic roller-brush car wash, be sure to lock the doors.  
When using a pressure washer, hold the lance at least 30 cm from the vehicle

(particularly when cleaning areas containing chipped paint, sensors or seals).

Promptly clean up any stains containing chemicals liable to damage the vehicle's paint (including tree resin, bird droppings, insect secretions, pollen and tar).

If justified by the environment, clean the vehicle more frequently to remove salty deposits (in coastal areas), soot (in industrial areas) and mud (in wet or cold areas). These substances can be highly corrosive.

Contact a CITROËN dealer for advice on removing stubborn stains requiring special products (such as tar or insect removers). Preferably, have paint touch-ups performed by a CITROËN dealer.

**!** The versions provided with roof rails are not designed for fitting roof racks. It is only for aesthetic factor.  
Do not apply loads on the roof rails.

#### Interior

**!** When washing the vehicle, never use a water hose or high-pressure jet to clean the interior.  
Liquids carried in cups or other open containers can spill, presenting a risk of damage if they come into contact with the controls in the dashboard and centre console. Be vigilant!

## Bodywork

### High-gloss paint

**!** Do not use abrasive products, solvents, petrol or oil to clean the bodywork.

Never use an abrasive sponge to clean stubborn stains - risk of scratching the paintwork!

Do not apply polish in strong sunshine, or to plastic or rubber parts.

**i** Use a soft cloth and soapy water or a pH neutral product.

Gently wipe the bodywork with a clean microfibre cloth.

Apply polish with the vehicle clean and dry.

Comply with the instructions for use stated on the product.

## Tool kit

Set of tools supplied with the vehicle.

### Accessing the tools

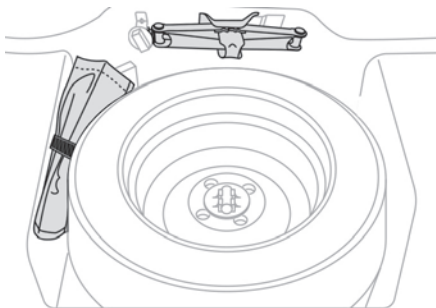

The tools are located under the boot floor carpet, with the spare wheel.

### List of tools

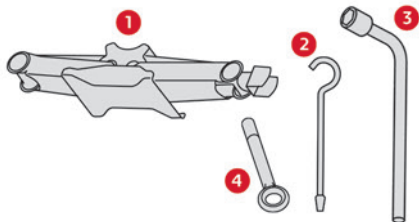

1. Jack  
To raise the vehicle.

2. Jack handle
3. Wheel wrench  
To remove the wheel bolts.
4. Removable towing eye

For more information on **Towing the vehicle** and using the removable towing eye, refer to the corresponding section.

! These tools are specific to the vehicle and may vary according to the level of equipment.  
Do not use them for any other purpose.

! The jack must only be used to change a wheel with a damaged or punctured tyre.  
Do not use any jack other than the one supplied with the vehicle.  
If the vehicle does not have its original jack, contact a CITROËN dealer.  
The jack does not require any maintenance.

## Spare wheel

### Access to the spare wheel

The spare wheel is installed in the boot, under the floor carpet.

## Removing the spare wheel

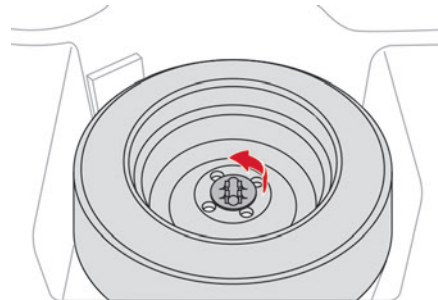

- ▶ Rotate the fixing screw to unlock the spare wheel.
- ▶ Lift the spare wheel towards you from the rear.
- ▶ Take the wheel out of the boot.

## Removing the jack

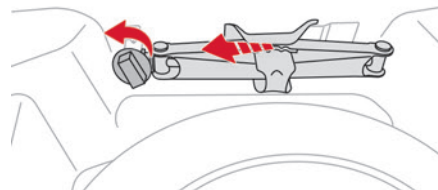

- ▶ Rotate the fixing screw to unlock the jack on one end.
- ▶ Tilt the jack towards the right and lift it from the rear.

## Removing a wheel

### ! Parking the vehicle

Immobilise the vehicle where it does not obstruct traffic: the ground must be level, stable and non-slippery.

With a manual gearbox, engage first gear to lock the wheels, apply the parking brake and switch off the ignition.

Check for the fixed illumination of the parking brake indicator lamps in the instrument panel.

The occupants must get out of the vehicle and wait where they are safe.

If necessary, place a chock under the wheel diagonally opposite the wheel to be changed. Never go underneath a vehicle raised using a jack; use an axle stand.

### i Wheel with wheel trim

**When removing the wheel**, first remove the wheel trim by pulling at the valve aperture.

**When refitting the wheel**, refit the wheel trim, starting by placing its aperture in line with the valve and then pushing it into place all round its edge with the palm of your hand.

### Wheel nuts removing pattern

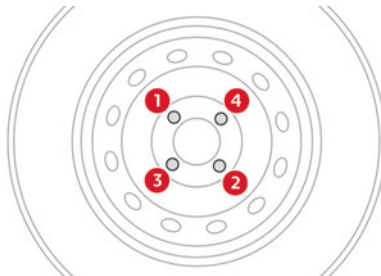

► Loosen the nuts on the wheel in diagonal sequence. Do not remove wheel nuts.

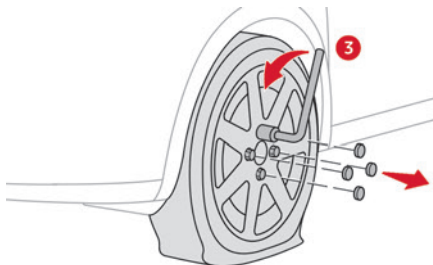

► Slacken the bolts using the wheel wrench 3 only.

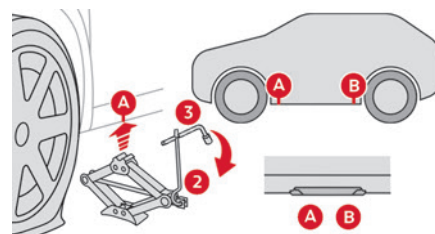

► Place the foot of jack 1 on the ground and ensure that it is directly below the front A or rear B jacking point on the underbody, whichever is closest to the wheel to be changed.

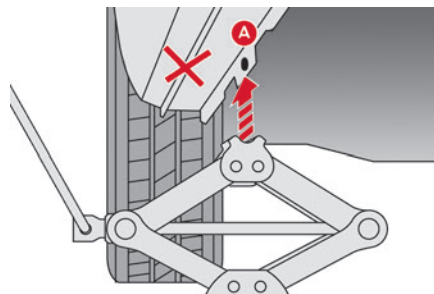

► Extend jack 1 with the jack handle 2 and wheel wrench 3 until its head comes into contact with jacking point A or B; contact area A or B on the vehicle must be properly inserted into the central part of the head of the jack.

► Raise the vehicle until there is sufficient space between the wheel and the ground to admit the spare (not punctured) wheel easily.

**!** Ensure that the jack is stable. If the ground is slippery or loose, the jack may slip or collapse - risk of injury!  
Take care to position the jack strictly at one of the jacking points **A** or **B** under the vehicle, ensuring that the head of the jack is centred under the contact area of the vehicle. Otherwise, there is a risk of damage to the vehicle and/or of the jack collapsing - risk of injury!

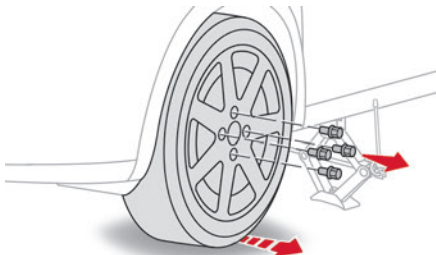

- ▶ Remove the bolts and store them in a clean place.
- ▶ Remove the wheel.

## Fitting a wheel

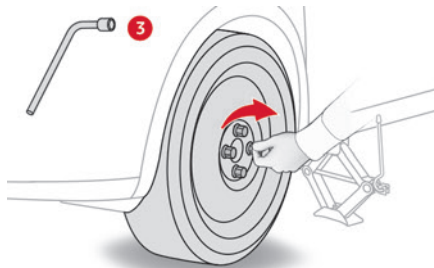

- ▶ Fit the wheel on the hub.
- ▶ Screw in the bolts by hand as far as possible.
- ▶ Pre-tighten the bolts using the wheel wrench 3 only.

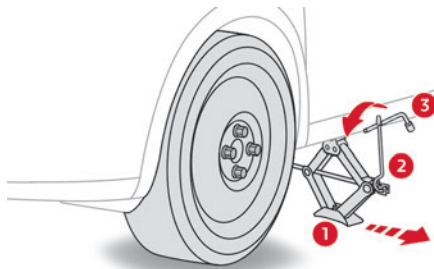

- ▶ Lower the vehicle again fully.
- ▶ Fold jack 1 and remove it.

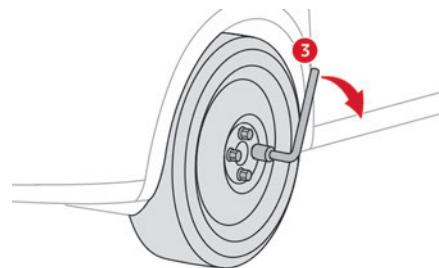

- ▶ Tighten the bolts using the wheel wrench 3 only.
- ▶ Refit the bolt cover (depending on equipment).
- ▶ Store the tools.

## Putting the spare wheel back in place

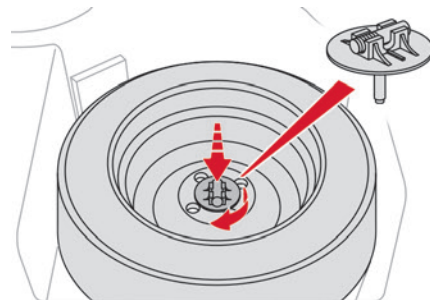

- ▶ Put the spare wheel back in its housing.

- ▶ Tighten the spare wheel fixing screw by a few turns.

## After changing a wheel

**!** The temporary spare wheel is only intended for temporary emergency use, until the conventional wheel can be repaired or replaced.

Continuous use of this spare can result in tire failure and loss of control. Always observe these precautions when using this spare:

- Your vehicle will respond differently with this temporary spare.
- Do not exceed 80 km/h speed.
- Replace this spare with a standard tire and wheel as soon as possible.
- Use of this spare will reduce ground clearance.
- Set the specified tire pressure indicated on the tire information label located on the driver's door lock pillar.
- Do not use tire chains on the temporary spare. If you must use tire chains, rearrange the wheels so standard tires and wheels are fitted to the front axle.
- The temporary spare wheel has a much shorter tread life than the conventional wheels on your vehicle. Replace the tire as soon as possible as the tread wear indicator appears. The inflation pressure of the temporary spare wheel should be checked at least monthly. At

the same time, check that the tire is stored securely. If it is not, tighten it.

Note that two or more temporary spare wheels should not be used on one vehicle simultaneously.

## Changing a bulb

**i** In some weather conditions (e.g. low temperature or humidity), misting on the internal surface of the glass of the headlamps and rear lamps is normal, and will disappear after the lamps have been on for a few minutes.

**!** The headlamps have polycarbonate lenses with a protective coating:

- **Do not clean them with a dry or abrasive cloth, nor with detergent or solvent products.**

- Use a sponge and soapy water or a pH neutral product.
- When using a high-pressure washer on persistent marks, do not keep the lance directed towards the headlamps, lamps or their edges for too long, so as not to damage their protective coating and seals.

**!** Changing a bulb must only be done with the ignition off and after the headlamp /

lamp has been switched off for several minutes - risk of serious burns!

Do not touch the bulb directly with your fingers; use a lint-free cloth.

It is essential only to use anti-ultraviolet (UV) type bulbs, so as not to damage the headlamp.

Always replace a failed bulb with a new bulb of the same type and specification. To avoid lighting imbalance, replace the bulbs in pairs.

### **i** Refitting the lamp units

Perform the operations in the reverse order to dismantling.

### **!** Opening the bonnet / Accessing the bulbs

With the engine warm, proceed with caution - risk of burns!

Take care with objects or clothing that could be caught in the blades of the cooling fan - risk of strangulation!



KEEP HANDS, HAIR, CLOTHING, ETC. AWAY FROM FAN AND ANY OTHER MOVING PARTS. FAN STARTS AUTOMATICALLY AND MAY CAUSE INJURY.

### **i** Halogen bulbs (Hx)

To ensure good quality lighting, check that the bulb is correctly positioned in its housing.

## Light-emitting diode (LED) headlamps and lamps

Depending on version, the affected types of headlamps / lamps are:

- Daytime running lamps / sidelamps.
- Direction indicator side repeaters.
- Third brake lamp.
- Number plate lamps.

### ! Light emitting diodes (LED)

For the replacement of this type of bulb, you must contact a CITROËN dealer.

Do not touch the LED technology lamps - risk of electrocution!

## Front lamps

### Model 1

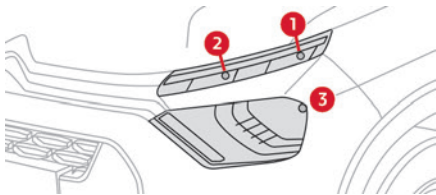

1. Daytime running lamps/sidelamps (W5W bulb)
2. Direction indicators (PY21W - 12V - 21W)
3. Beam headlamps (H4 - 12V - 60/55W)

### Model 2

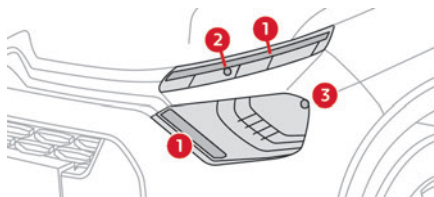

1. Daytime running lamps/sidelamps (LED)
2. Direction indicators (PY21W - 12V - 21W)
3. Beam headlamps (H4 - 12V - 60/55W)

### Daytime running lamps/sidelamps

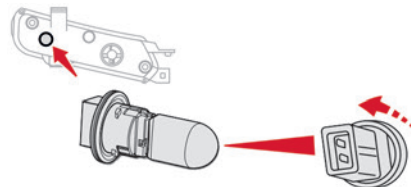

- ▶ Turn the bulb holder a quarter of a turn and pull it out.
- ▶ Pull the bulb out and change it.

### Direction indicators

**i** Rapid flashing of a direction indicator lamp (left or right) indicates that one of the bulbs on the corresponding side has failed.

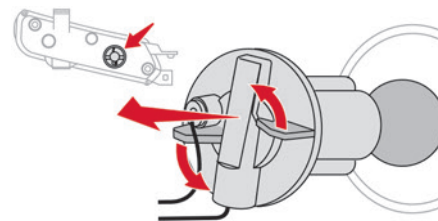

- ▶ Turn the bulb holder a eighth of a turn anti-clockwise and remove it.
- ▶ Remove the bulb and replace it.

**i** Amber coloured bulbs, such as the direction indicators, must be replaced by bulbs with identical colour and specifications.

### Beam headlamps

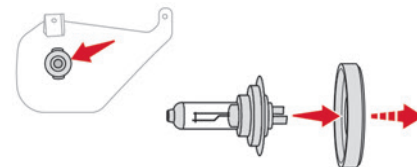

- ▶ Remove the protective cover by pulling on the tab.
- ▶ Disconnect the bulb connector.
- ▶ Release the retaining tab.
- ▶ Change the bulb taking care to align the metal part with the grooves on the lamp.
- ▶ Reposition the retaining tab.
- ▶ Reconnect the bulb connector.



- ▶ Ensure that the cover is refitted correctly all around to ensure correct sealing.

## Rear lamps

### Model 1



1. Sidelamps / Brake lamps (P21/5W - 12V - 21W/5W)
2. Direction indicators (PY21W - 12V - 21W)
3. Reversing lamp (P21W - 12V - 21W)

### Model 2

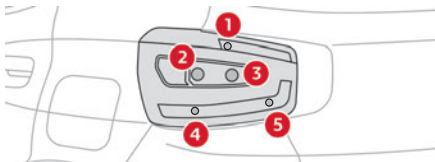

1. Sidelamps / Brake lamps (P21/5W - 12V - 21W/5W)
2. Direction indicators (PY21W - 12V - 21W)
3. Reversing lamp (P21W - 12V - 21W)
4. Additional sidelamps (W3W - 12V - 3W)
5. Connecting tail lamps (W3W - 12V - 3W)

## Changing bulbs

These bulbs are changed after removing the tail lamp assembly.

- ▶ Open the boot.
- ▶ Unscrew the nut and remove it. Be careful not to drop it inside the wing.
- ▶ Unclip the lamp unit and carefully extract it pulling straight towards the outside. A standard pair of pliers or the wheel wrench (depending on equipment) may be necessary to remove the nut.

### Sidelamps/Brake lamps / Reversing lamp / Direction indicators

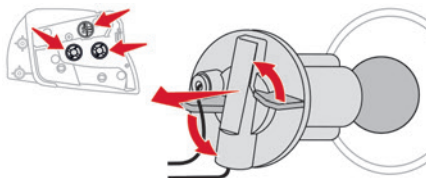

- ▶ Turn the bulb holder a eighth of a turn anti-clockwise and remove it.
- ▶ Remove the bulb and replace it.

## Additional sidelamps / Connecting tail lamps (if equipped)

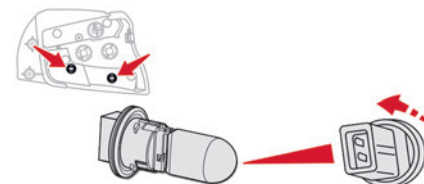

- ▶ Turn the bulb holder a quarter of a turn and pull it out.
- ▶ Pull the bulb out and change it.

## Interior lighting

### Courtesy lamp (10W - 12V - 10W)

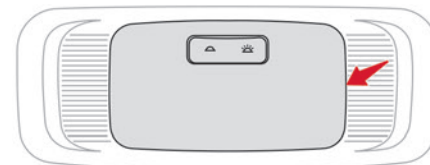

- ▶ Using a thin, flap tip screwdriver, unclip the entire console surrounding the courtesy lamp.
- ▶ Remove the defective bulb and replace it.
- ▶ Fit the console back into place around the courtesy lamp and clip it correctly.

## Changing a fuse

### Access to the tools

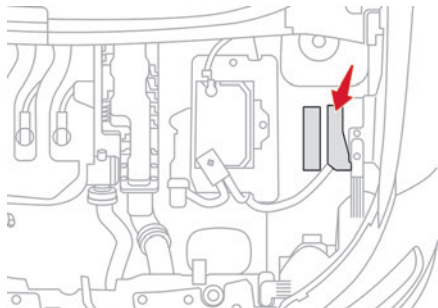

The puller is located inside the engine fuse box.

- ▶ Open the bonnet.
- ▶ Disengage the cover completely.
- ▶ Take the puller from its housing.

### Changing a fuse

Before changing a fuse:

- ▶ Identify the cause of the fault and fix it.
- ▶ Switch off all power consumption.
- ▶ Identify the defective fuse using the current allocation tables and diagrams.

To replace a fuse, it is essential to:

- ▶ Use the special puller to extract the fuse from its housing and check the condition of its filament.

▶ Always replace the failed fuse with a fuse of the same rating (same colour); use of a different rating may cause malfunctions - risk of fire! If the fault recurs soon after replacing a fuse, have the electrical system checked by a CITROËN dealer.

**i** The fuse allocation tables and the corresponding diagrams are available from a CITROËN dealer.

**!** The replacement of a fuse not shown in the allocation tables may cause a serious malfunction of the vehicle. Contact a CITROËN dealer.

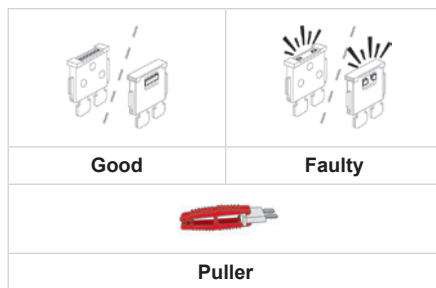

**i** **Installing electrical accessories**  
The vehicle's electrical system is designed to operate with standard or optional equipment.

Before installing other electrical equipment or accessories to your vehicle, contact a CITROËN dealer.

**!** CITROËN accepts no responsibility for the cost incurred in repairing the vehicle or for rectifying malfunctions resulting from the installation of accessories not supplied or not recommended by CITROËN and not installed in accordance with its recommendations, in particular when the combined power consumption of all of the additional equipment connected exceeds 10 milliamperes.

## Dashboard fuses

The fusebox is placed in the lower dashboard (right-hand side).

### Access to the fuses

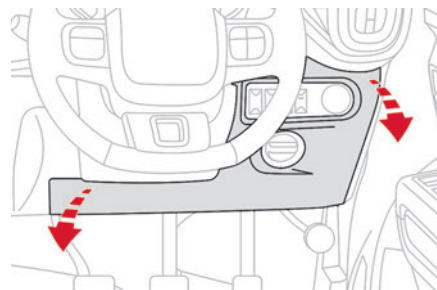

► Unclip the cover by pulling at the top left, then right.

### Version 1

Fuse No.	Colour	Rating (A)	Functions
FF01	Red	10	On-board diagnosis (OBD-II) / Spare connector
FF02	Yellow	20	Body control and cluster module 1 (BCCM-1)
FF03	Green	30	Body control and cluster module 2 (BCCM-2)
FF04	Yellow	20	Body control and cluster module 3 (BCCM-3)
FF07	Blue	15	12 V Socket
FF08	Tan	5	Cabin lamp / Spare connector
FF09	Blue	15	Front wiper and washer
FF10	Tan	5	ECU's ignition
FF12	Tan	5	Airbag ECU
FF10	Tan	5	Switches ignition
FF	Tan	5	Service
FF	Red	10	Service
FF	Blue	15	Service
FS01	Pink	30	Body Control & Cluster Module 5 (BCCM-5)

### Relays

Relay	Colour	Rating (A)	Functions
MICRO	Brown	20	Ignition Loads

**Version 2****Fuses**

Fuse No.	Colour	Rating (A)	Functions
<b>FF01</b>	<b>Red</b>	<b>10</b>	On-board diagnosis (OBD-II)
<b>FF02</b>	<b>Yellow</b>	<b>20</b>	Body control and cluster module 1 (BCCM-1)
<b>FF03</b>	<b>Green</b>	<b>30</b>	Body control and cluster module 2 (BCCM-2)
<b>FF04</b>	<b>Yellow</b>	<b>20</b>	Body control and cluster module 3 (BCCM-3)
<b>FF05</b>	<b>Green</b>	<b>30</b>	Body control and cluster module 4 (BCCM-4)
<b>FF06</b>	<b>Blue</b>	<b>15</b>	Audio system
<b>FF07</b>	<b>Blue</b>	<b>15</b>	12V Socket
<b>FF08</b>	<b>Tan</b>	<b>5</b>	Spare connector / USB
<b>FF09</b>	<b>Red</b>	<b>10</b>	Front washer
<b>FF10</b>	<b>Tan</b>	<b>5</b>	ECU's ignition
<b>FF11</b>	<b>Tan</b>	<b>5</b>	Airbag ECU
<b>FF12</b>	<b>Tan</b>	<b>5</b>	Switches ignition
<b>FF</b>	<b>Tan</b>	<b>5</b>	Service
<b>FF</b>	<b>Red</b>	<b>10</b>	Service
<b>FF</b>	<b>Blue</b>	<b>15</b>	Service
<b>FS01</b>	<b>Pink</b>	<b>30</b>	Body control and cluster module 5 (BCCM-5)
<b>FS02</b>	<b>Pink</b>	<b>30</b>	Body control and cluster module 6 (BCCM-6)

## Relays

Relay	Colour	Rating (A)	Functions
MICRO	Brown	20	Ignition Loads

## Engine compartment fuses

The fusebox is placed in the engine compartment near the battery.

### Access to the fuses

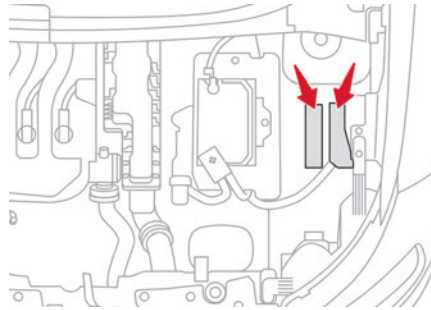

- ▶ Remove the cover.
- ▶ Change the fuse.
- ▶ When you have finished, close the cover carefully then engage the two latches, to ensure correct sealing of the fusebox.

## Version 1

### Engine fuse cum relay box

Fuse No.	Colour	Rating (A)	Functions
FF01	Green	30	ABS ECU
FF02	Red	10	HVAC Compressor
FF03	Red	10	Horn
FF04	Green	30	ECM Loads (Ignition Coil / Injectors / Fuel Pump)
FF05	Blue	15	ECM Loads (Canister Valve / O2 Sensors)
FF06	Tan	5	ECM Loads (VVT Valve)

Fuse No.	Colour	Rating (A)	Functions
FF07	Yellow	20	ECM Power Supply
FF08	Tan	5	Radiator Fan Relay Coil Supply
FS01	Yellow	60	Cabin Fuse Bow Loads (CFB-1)
FS02	Yellow	60	Electric Power Steering (EPS) Motor
FS03	Green	40	ABS Motor
FS04	Green	40	Radiator fan
FS05	Green	40	Accessory load (HVAC Blower/Wiper/Washer)
FF	Green	30	Service
FF	Blue	15	Service
FF	Red	10	Service

Relay	Colour	Rating (A)	Functions
MICRO	Brown	20	HVAC Compressor
MICRO	Brown	20	Horn
MICRO	Brown	20	Starter Solenoid
MICRO	Grey	35	ECM Main

## Version 2

### Engine fuse cum relay box

Fuse No.	Colour	Rating (A)	Functions
FF01	Green	30	ABS ECU
FF02	Red	10	HVAC Compressor

Fuse No.	Colour	Rating (A)	Functions
FF03	Red	10	Horn
FF04	Green	30	ECM Loads (Ignition Coil / Injectors / Fuel Pump)
FF05	Blue	15	ECM Loads (Canister Valve / O2 Sensors)
FF06	Tan	5	ECM Loads (VVT Valve)
FF07	Yellow	20	ECM Power Supply
FF08	Tan	5	Radiator Fan Relay Coil Supply
FS01	Black	80	Cabin Fuse Box Loads (CFB-1)
FS02	Yellow	60	Electric Power Steering (EPS) Motor
FS03	Green	40	ABS Motor
FS04	Green	40	Radiator Fan
FS05	Green	40	Accessory Load (HVAC Blower/Washer)
FF	Green	30	Service
FF	Blue	15	Service
FF	Red	10	Service

Relay	Colour	Rating (A)	Functions
MICRO	Brown	20	HVAC Compressor
MICRO	Brown	20	Horn
MICRO	Brown	20	Starter Solenoid
MICRO	Grey	35	ECM Main

### Engine fuse cum relay box turbo

Fuse No.	Colour	Rating (A)	Functions
FF01	Green	30	ABS ECU
FF02	Red	10	HVAC Compressor
FF03	Red	10	Horn
FF04	Green	30	ECM Loads (Ignition Coil / Fuel Pump)
FF05	Blue	15	ECM Loads (Canister Valve / O2 Sensors)
FF06	Blue	15	ECM Loads (VVT / Thermostat / Oil Pump Valve)
FF07	Yellow	20	ECM Power Supply & Injectors
FF08	Tan	5	Radiator Fan Relay Coil Supply
FS01	Black	80	Cabin Fuse Box Loads (CFB-1)
FS02	Yellow	60	Electric Power Steering (EPS) Motor
FS03	Green	40	ABS Motor
FS04	Yellow	60	Radiator Fan
FS05	Green	40	Accessory Load (HVAC Blower/Washer)
FF	Green	30	Service
FF	Blue	15	Service
FF	Red	10	Service

Relay	Colour	Rating (A)	Functions
MICRO	Brown	20	HVAC Compressor
MICRO	Brown	20	Horn
MICRO	Brown	20	Starter Solenoid
MICRO	Grey	35	ECM Main



**Engine relay box****Version 1**

Fuse No.	Colour	Rating (A)	Functions
FS06	Green	40	Cabin Fuse Box Loads (CFB-2)

Relay	Colour	Rating (A)	Functions
MINI	Grey	40	Radiator Fan
MINI	Grey	40	Accessory load (HVAC Blower/Wiper/Washer)
MAXI	Grey	70	ECM Power

**Version 2**

Fuse No.	Colour	Rating (A)	Functions
FS06	Green	40	Cabin Fuse Box Loads (CFB-2)

Relay	Colour	Rating (A)	Functions
MINI	Grey	40	Radiator Fan
MINI	Grey	40	Accessory load (HVAC Blower/Washer)
MAXI	Grey	70	ECM Power

**Engine relay box turbo**

Fuse No.	Colour	Rating (A)	Functions
FS06	Green	40	Cabin Fuse Box Loads (CFB-2)
FF09	Blue	15	ECM Loads (Electric Dump Valve / Blow-by Heater)
FF10	Tan	5	Battery Sensor (BECB)
FF11	Black	1	ECM Main Relay Coil Control (Diode)

Relay	Colour	Rating (A)	Functions
MINI	Grey	40	Accessory load (HVAC Blower/Washer)
MAXI	Grey	70	ECM Power

## 12 V battery

### Lead-acid starter batteries



These batteries contain harmful substances (sulphuric acid and lead). They must be disposed at authorized dealer/battery shop in accordance with regulations and must never under any circumstances be discarded with household waste. Take used remote control batteries and vehicle batteries to a special collection point.



Protect your eyes and face before handling the battery.

Use goggles and gloves while working with the battery. Diluted sulphuric acid spilled from battery can cause blindness or severe burns. Flush eyes or body with ample water and get medical care immediately if suffered. Keep batteries out of the reach of children. All operations on the battery must be carried out in a well ventilated area and away from naked flames and sources of sparks, so as to avoid any risk of explosion or fire. Wash your hands afterwards.



If the battery fails (after warranty coverage), replace it with a battery of the same specification as the one used in the vehicle.

### Access to the battery

The battery is located under the bonnet.

#### Naturally Aspirated engine version

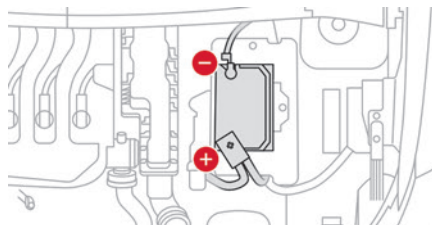

(+) Positive terminal.

(-) Negative terminal.

#### Turbo engine version

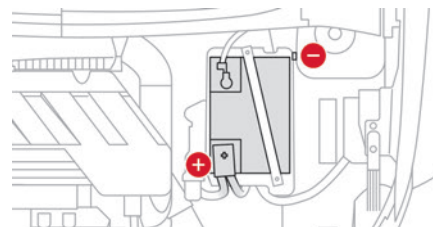

(+) Positive terminal.

(-) Negative terminal.

A remote earth point is located near the battery.

### Starting using another battery

If the vehicle's battery is flat/drain/discharged, the engine can be started using a backup battery (either external or from another vehicle) and jump leads or using a battery booster.



Never start the engine by connecting a battery charger.

Never use a 24 V or higher battery booster. Check beforehand that the backup battery has a nominal voltage of 12 V and a capacity

at least equal to that of the discharged battery.

The two vehicles must not be in contact with each other.

Switch off all electricity-consuming equipment on both vehicles (audio system, wipers, lighting, etc.).

Make sure that the jump leads are well away from the engine's moving parts (fan, belt, etc.).

Do not disconnect the (+) terminal while the engine is running.

During jump start, extra care should be taken to ensure right terminals are connected. If terminal connections are reversed, it will lead to failure of alternator & other electrical, electronic components.

Never power electrical or electronic components directly from battery terminals as it will lead to poor battery charging, poor performance of components and battery sensor malfunction, which will impact fuel economy.

### For Naturally Aspirated engine version

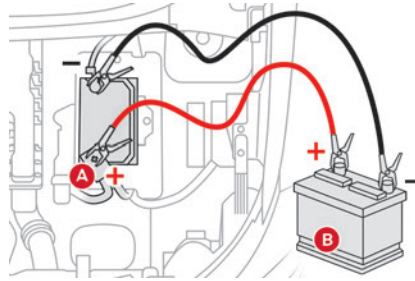

- ▶ Lift the cover on the (+) terminal, if the vehicle has one.
- ▶ Connect the red cable to the (+) terminal of flat battery **A**, then to the (+) terminal of the backup battery **B** or of the booster.
- ▶ Connect one end of the green or black cable to the (-) terminal of the backup battery **B** or of the booster (or to an earth point on the assisting vehicle).
- ▶ Connect the other end of the green or black cable to the (-) terminal of flat battery **A**.
- ▶ Start the engine on the assisting vehicle and leave it running for a few minutes.
- ▶ Operate the starter on the broken down vehicle and let the engine run.

If the engine does not start immediately, switch off the ignition and wait a few moments before trying again.

- ▶ Wait for it to return to idle.
- ▶ Disconnect the jump leads **in reverse order**: first remove (-) terminal then (+) terminal.

- ▶ Refit the cover to the (+) terminal, if the vehicle has one.
- ▶ Allow the engine to run for at least 30 minutes, with the vehicle stationary, so that the battery reaches an adequate state of charge.

### For Turbo engine version

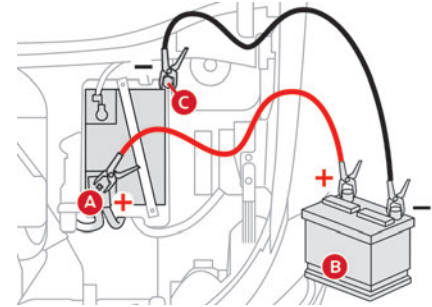

**i** The negative cable must be connected to the car ground (not to the battery negative terminal) so that the battery sensor can detect all charging and discharging currents.

- ▶ Lift the cover on the (+) terminal, if the vehicle has one.
- ▶ Connect the red cable to the (+) terminal of flat battery **A** (at the metal elbow), then to the (+) terminal of the backup battery **B** or of the booster.
- ▶ Connect one end of the green or black cable to the (-) terminal of the backup battery **B** or of

the booster (or to an earth point on the assisting vehicle).

- ▶ Connect the other end of the green or black cable to the earth point **C** on the broken down vehicle.

- ▶ Start the engine on the assisting vehicle and leave it running for a few minutes.

- ▶ Operate the starter on the broken down vehicle and let the engine run.

If the engine does not start immediately, switch off the ignition and wait a few moments before trying again.

- ▶ Wait for it to return to idle.

- ▶ Disconnect the jump leads **in reverse order**: first remove (-) terminal then (+) terminal..

- ▶ Refit the cover to the (+) terminal, if the vehicle has one.

- ▶ Allow the engine to run for at least 30 minutes, with the vehicle stationary, so that the battery reaches an adequate state of charge.

**!** Driving immediately without having reached a sufficient level of charge may affect some of the vehicle's functionalities.

## Disconnecting/removing the battery

In order to maintain an adequate state of charge for starting the engine, it is recommended that the battery be disconnected if the vehicle is taken out of service for a long period.

Before disconnecting the battery:

- ▶ Close all openings (doors, boot, windows).
- ▶ Switch off all electrical consumers (audio system, wipers, lighting, etc.).
- ▶ Switch off the ignition and wait for 4 minutes.

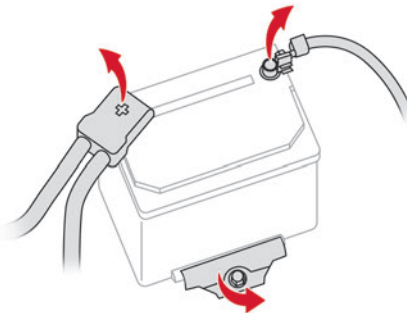

**Naturally Aspirated engine version**

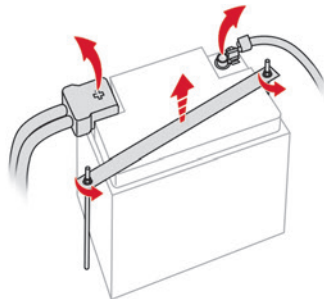

**Turbo engine version**

- ▶ Disconnect the negative cable.
- ▶ Disconnect the positive cable.

- ▶ Remove the mounting bracket if you need to remove the battery.

**!** Be careful not to cause accidental short circuits between the positive and negative battery terminals. Do not allow smoking, sparks or flames around fuel or the battery.

## After reconnection

After reconnecting the battery, turn on the ignition and wait 1 minute before starting the engine, to enable the electronic systems to initialise.

If minor problems nevertheless persist following this operation, contact a CITROËN dealer.

Referring to the relevant section, initialise or reset certain equipment:

- Date and time.
- Preset radio stations.

## Towing the vehicle

### **i** General recommendations

Observe the legislation in force in the country where you are driving.

Ensure that the weight of the towing vehicle is higher than that of the towed vehicle.

The driver must remain at the wheel of the towed vehicle and must have a valid driving licence.

When towing a vehicle with all four wheels on the ground, always use an approved towing arm; rope and straps are prohibited. The towing vehicle must move off gently. When the vehicle is towed with its engine off, there is no longer braking and steering assistance.

**! A professional towing service must be called if:**

- Broken down on a motorway or main road.
- Not possible to put the gearbox into neutral, unlock the steering, or release the parking brake.
- Towing with only two wheels on the ground.
- No approved towbar available.

## Access to the tools

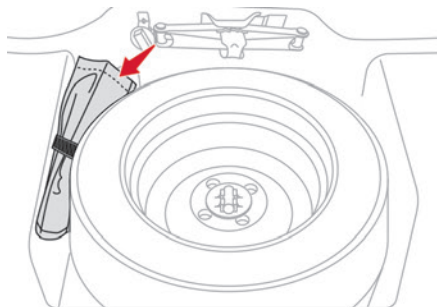

The towing eye is stored under the boot floor carpet.

## Towing your vehicle

To access the front screw thread:

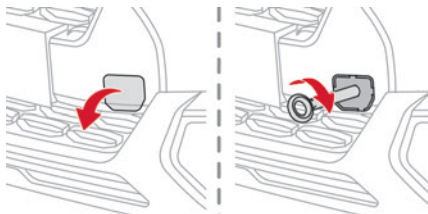

- ▶ Remove the cover.

To be towed:

- ▶ Screw the towing eye in fully.
- ▶ Install the towbar.
- ▶ Put the gearbox into neutral.

**!** Failure to observe this instruction could result in damage to certain components (braking, transmission, etc.) and to the absence of braking assistance the next time the engine is started.

- ▶ Unlock the steering and release the parking brake.
- ▶ Switch on the hazard warning lamps on both vehicles.
- ▶ Move off gently, drive slowly and only for a short distance.

## Engines technical data

The engine characteristics are given in the vehicle's registration document, as well as in sales brochures.

**i** The maximum power corresponds to the value type-approved on a test bed, under conditions defined as per AIS 137 (Part 5).

For more information, contact a CITROËN dealer.

Engine	EB2NA engine	EB2ADTM engine
Gearbox	MA5 (Manual 5-speed)	MB6 (Manual 6-speed)
Cubic capacity	1 199 cc	1 199 cc
Max. power	60 kW at 5750 rpm	81 kW at 5500 rpm
Fuel	BSVI Commercial Gasoline Fuel	BSVI Commercial Gasoline Fuel
Curb weight	L1-939 kg L2-964 kg	L2-1035 Kg

## Dimensions (mm)

These dimensions have been measured on an unladen vehicle.

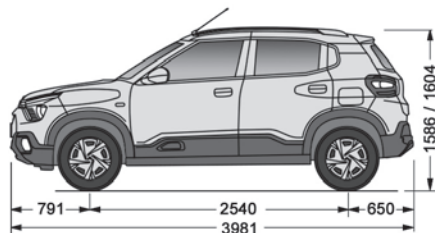
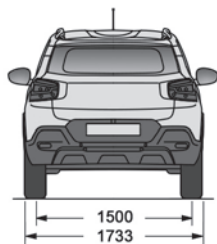
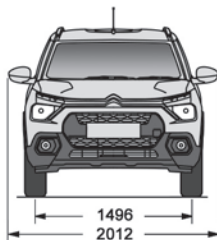

## Identification markings

Various visible markings for the identification and research of your vehicle.

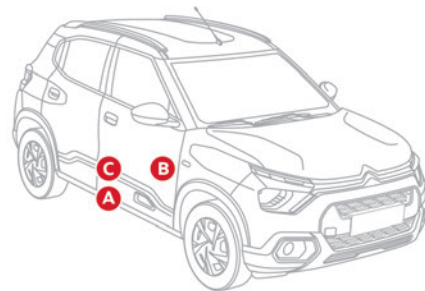

**A. Vehicle identification number (VIN), BSO (Body Side Outer) Front Panel RH**

Stamped on BIW.

Bears the following information:

- Manufacturer's name.
- VIN number.
- Model.
- Engine number.

**B. Chassis number, Seat Cross Member Panel RH**

Below driver seat.

## C. Tyres label

Tyre Size	Tyre Position	Tyre Pressure	
		Normal Load	Full Load (GVW)
		1 to 3 persons	4 to 5 persons
195/65 R15	Front	32 psi	36 psi
	Rear	32 psi	36 psi
185/65 R15	Spare tyre 1 (Turbo)	36 psi	36 psi
165/80 R14	Spare tyre 2 (NA)	36 psi	36 psi

Fixed at the driver-side door.

Bears the following information about the tyres:

- Tyre pressures, unladen and laden.
- Tyre specification, made up of the dimensions and type as well as the load and speed indices.
- Spare tyre inflation pressure.

**i** The vehicle may be originally equipped with tyres with higher load and speed indices than those indicated on the label, without affecting tyre pressure (on cold tyres).

# 10" Touch Screen

## Multimedia audio system

**i** The functions and settings described may vary according to the vehicle version and configuration.

**!** Driving while distracted can result in loss of vehicle control, crash and injury. We strongly recommend that you use extreme caution when using any device that may take your focus off the road.

Your primary responsibility is the safe operation of your vehicle.

We recommend against the use of any hand-held device while driving and encourage the use of voice-operated systems when possible.

Make sure you are aware of all applicable local laws that may affect the use of electronic devices while driving.

**!** For safety reasons and because they require sustained attention by the driver, the following operations must be carried out with the vehicle stationary and the ignition on:

- Pairing the smartphone with the system in Bluetooth® mode.
- Connection to the Apple CarPlay® or Android Auto applications.
- Using the smartphone.

– Changing the system settings and configuration.  
Some functions are not accessible when driving.

### **!** Overheating

In very hot conditions, operation may be limited to protect the system (e.g. volume may be reduced). A warning message is displayed on the screen.

The system will resume normal operation when the temperature in the passenger compartment has dropped.

**i** The system is protected in such a way that it will only operate in the vehicle.

**i** For more information about smartphones and OS compatibility, refer to the following website:  
<https://citroen.in/citroen-connectivity>

## General information

### Getting to know your system

The system allows you to interact with a variety of features using the touch screen and voice commands.

By integrating with your Bluetooth®-enabled phone, the touch screen provides easy interaction with audio, multimedia, navigation, and your phone's compatible applications. Your system is equipped with a feature that allows you to access and control audio features for 60 minutes after you switch the ignition off (until the doors are locked using the remote control).

### Layout of the touch screen

To operate the touch screen, simply touch the item or option that you want to choose. The button changes colour when you select it.



1. Display off (short press)  
Power off (long press)
2. Connected device status with battery and signal strength (when mobile phone is connected)
3. Status bar  
This bar displays icons and messages pertaining to current system activities.
4. Date and time
5. Global volume control
6. Menu



## 7. Global shortcuts

The touch screen allows quick access to all of your comfort, navigation, communication and entertainment options. Using the status and feature bar, you can quickly select the feature you want to use.

## Cleaning the touch screen

Remove dirt and fingerprints with a dry, clean, soft cloth.

If dirt or fingerprints are still on the screen, apply a small amount of cleaning alcohol to the cloth and try to clean it again.

- !** Do not use detergent or any type of solvent to clean the touch screen.
- Do not pour or spray alcohol onto the touch screen.
- Do not use sharp objects on the screen.
- Do not touch the screen with wet hands.

## Steering mounted controls

Depending on your vehicle and option package, you can use different controls on your steering wheel to interact with the touch screen system in different ways.



SRC

Change multimedia source



**Voice command**  
Activates voice recognition while connected to a smartphone via Bluetooth® (with Internet on), Android Auto or Apple CarPlay® and the system provides feedback through audible tones, prompts, questions and spoken confirmations depending on the situation and the chosen level of interaction (voice settings of the phone).



**Seek up or next song**  
While in radio mode, press to seek between memory presets. Press and hold to increment quickly, until you find a station you want to listen.

While in USB or Bluetooth® audio, press to seek between songs or press and hold to fast seek. During an incoming call: accept call



**Seek down or previous song**  
While in radio mode, press to seek between memory presets. Press and hold to decrement quickly, until you find a station you want to listen.

While in USB or Bluetooth® audio press to seek between songs or press and hold to fast seek. During an incoming call: reject call  
During an ongoing call : end call



**Increase volume**



**Decrease volume (short press)**  
**Mute sound (long press)**

## Menus

### Radio



Select a radio station.

### Phone



Access the phone contacts, dialpad and call log.

### Android Auto



Run certain applications on a smartphone connected via Android Auto.

### Apple CarPlay®



Run certain applications on a smartphone connected via Apple CarPlay®.

### Media



Access and navigate media files of a USB device or an iPod.

### BT Audio



Access and control the audio files of a device connected via Bluetooth.

### Device List



Access and manage the devices connected to the system.

## Settings



Access the settings (system, phone, audio etc.).

## Radio



### Choosing the band

Press **FM** or **AM** on the bottom of the screen to select the band.

### Selecting a station



Make a short press to perform a manual search for previous/next radio frequency.

Make a long press to perform an automatic search for previous/next radio frequency.

### Presetting a station

12 stations can be preset on the FM band and 6 on the AM band.

#### Manual

Make a long press on one of the preset number to preset the current playing station.

### Automatic

Press **AST** to search all frequencies within the current band and automatically store valid stations.

## Phone

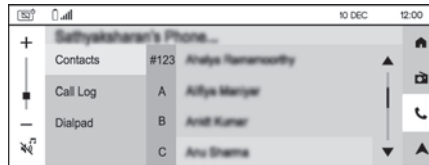

A phone must be paired to the system to be able to use the following functionalities.

### Pairing a phone

The services available depend on the network, the SIM card and the compatibility of the Bluetooth® devices used. Consult the phone user guide, the service provider and the OEM portal to check which services are available.  
<https://citroen.in/citroen-connectivity>

The Bluetooth® function must be activated and the phone in "Visible to all" mode. To complete the pairing, whichever procedure is used (from the phone or from the system),

ensure that the code is the same in the system and in the phone.

If the pairing procedure fails, we recommend deactivating and then reactivating the Bluetooth® function on the phone and deleting any CITROËN name present in the pairing list.

### Procedure from the phone

The system discoverable mode will operate 90 seconds once the BT visibility option is selected under **Settings**.

Select the name of the system in the list of detected devices on the phone. In the system, accept the connection request from the phone and follow the instructions on the phone and system screen.

### Procedure from the system



Select **Settings** menu.

Select **Phone**.

Press **Add device**.

Press **Scan for Devices**.

The list of detected devices is displayed.

Select the name of the required phone in the list.

Depending on the type of phone, you may be prompted to accept the transfer of contacts.

## Automatic reconnection

On returning to the vehicle, if the last phone connected is present again (Bluetooth® activated), it is automatically reconnected after key on.

## Managing paired phones

To connect or disconnect a paired phone and switch to Android Auto or Apple CarPlay®:



Press **Settings** menu, select **Phone** then **Device List** to display the list of paired devices.

or



Press directly **Device List** menu to display the list of paired devices.



Press the Bluetooth icon to connect/disconnect a device.

## Delete a phone



Press **Settings** menu, select **Phone** then **Device List** to display the list of paired devices.

or



Press directly **Device List** menu to display the list of paired devices.



Press **Delete** to delete a device.

## Receiving a call

An incoming call is announced by a ring and a superimposed display in the screen.

To accept the call:



Press this steering mounted button or use the touch screen button.

To reject the call:



Press this steering mounted button or use the touch screen button.

## Making a call



Using the telephone is not recommended while driving.

Park/stop the vehicle before using the mobile device.

### Calling a new number



Press **Phone** menu.

Press **Dialpad**.

Enter the phone number using the digital keypad.

Press the **Call** button.

### Calling a contact



Press **Phone** menu.

Press **Contacts**.

Select your contact.

### Calling a recently used number



Press **Phone** menu.

Press **Call Log**.

Select the number in the list of recently used numbers.

## Call options

During an active call, the following options are available:

**Mute:** mute the microphone.

**Hold:** put the active call on hold.

**Add:** add a second call from the dial pad, call log or contact list.

**Use Phone:** switch to handset mode.

**Keypad:** use the keypad.

**End call:** hang up the phone.

### Managing multiple calls

If there is a second incoming call, you can press

**Accept Call** to accept it. The first call is on hold.

You can choose to swap between calls or merge both calls. If you merge calls, a conference call is created.

## Connectivity



Synchronising a smartphone enables users to display applications that support the smartphone's Android Auto or Apple CarPlay® technology on the vehicle's screen. For Apple CarPlay® technology, the Apple CarPlay® function must first be activated on the smartphone. In all cases, the smartphone must be unlocked, to enable the communication process between the smartphone and the system to function (at first connection only). As principles and standards are constantly changing, we

recommend keeping the smartphone's operating system up-to-date, together with the date and time on the smartphone and the system.

Refer to your smartphone for Android Auto or Apple CarPlay® settings.

**i** For the list of suitable smartphones, visit the Android Auto and Apple CarPlay® websites:

<https://www.android.com/auto/>

<https://www.apple.com/in/ios/carplay/>

**!** Stop the car before connecting Android Auto or Apple CarPlay® and follow the instructions on your phone.

**i** On connecting the USB cable, the Android Auto or Apple CarPlay® function deactivates the system's Bluetooth® mode.

## Android Auto

**i** Ensure the latest Android Auto application is available on your smartphone. If not, install it via "Play Store". The Android Auto function requires the use of a compatible smartphone and compatible applications.

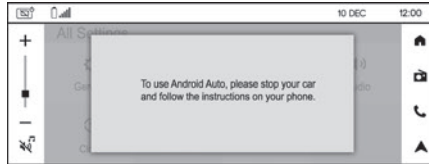

Connecting Android Auto smartphone can be carried out either by USB cable or using a wireless connection.

### USB connection

Connect the USB cable.

Android Auto is automatically launched a few seconds after the USB connection has been established. A validation procedure on the smartphone has to be followed for the first connection, with the vehicle stationary. The smartphone charges when connected by the USB cable.

### Wireless connection

The wireless connection of an Android Auto device can be initiated from the **Device List** menu or home screen Android Auto icon. First activate the smartphone's Bluetooth® function.

Select **Device List** menu to display the device to be connected to Android Auto.

If the device has already been connected to the system via Bluetooth®, select the Android Auto of the desired device from the list of connected Android phones.

For wireless Android Auto, subsequent automatic connection of the smartphone requires activation of Bluetooth® and Wi-Fi on your device.



As soon as the connection is established, select this menu to display the Android Auto interface.

**i** There may be a pause before applications become available, depending on the quality of the network and performances of the phone.

## Apple CarPlay®

**i** The Apple CarPlay® function requires the use of a compatible smartphone and compatible applications.

Connecting Apple CarPlay® smartphone can be carried out either by USB cable or using a wireless connection.

### USB connection

Connect the USB cable.

The smartphone charges when connected by the USB cable.



From the system, press **Apple CarPlay®** menu to display the Apple CarPlay® interface or press **Device List** menu to display the list of connected devices and then select **Apple CarPlay®**.

**i** When the USB cable is disconnected and the ignition is switched off then back

on, the system will not automatically switch to other mode; the source must be changed manually.

### Wireless connection

The wireless connection of an Apple CarPlay® device can only be initiated from the **Device List** menu.

First activate the smartphone's Bluetooth® function.

Select **Device List** menu to display the devices to be connected to Apple CarPlay®.

If the device has already been connected to the system via Bluetooth®, select Apple CarPlay on the desired device from the list of connected Apple phones.

For wireless Apple CarPlay®, subsequent automatic connection of the smartphone requires activation of Bluetooth® and Wi-Fi on your device.

Visit the Apple CarPlay® website at:  
<https://www.apple.com/ios/carplay/>

## Media



Insert the USB memory stick into the USB port or connect the USB device/iPod to the USB port using a suitable cable (not supplied).  
 USB device format supported: FAT16 or FAT32.

**!** To protect the system, do not use a USB hub.

### Music

The system supports MP3 and WAV audio file types.

The system builds music playlists (in temporary memory); this operation can take from a few seconds to several minutes at the first connection.

Reduce the number of non-music files and the number of folders to reduce the waiting time.

Playlists are updated whenever the ignition is switched off or a USB memory stick is connected. The audio system memorises these lists, which will subsequently load faster if they have not been changed.

### Videos

The system can play video files in the AVI, WMV, MP4, MOV, M4V, DAT and VOB formats.

Video control commands are accessible only through the touch screen.

When the vehicle is in motion, video playback will cut off and only audio playback will be available.

USB video is not available if Android Auto or Apple CarPlay® is active/connected.

**!** For safety reasons, park the vehicle before playing a video.

## BT Audio



When a smartphone is paired to the system, streaming allows you to listen to the audio feed from your smartphone.

The Bluetooth® profile must be activated.

First adjust the volume on the portable device (to a high level). Then adjust the volume of the audio system.

If play does not start automatically, it may be necessary to start the audio playback from the smartphone.

Browse button is available if supported by the smartphone application.

Control is from the portable device or by using the system's touch buttons.

**i** Once connected in streaming mode, the smartphone is considered to be a media source.

# Settings

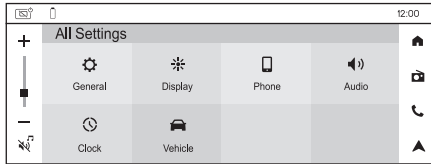



## General settings

 Press **Settings** to display the main page.

Press **General**.

- Select **Language** to choose a language in the list displayed.
- Select **Factory Reset** to return to factory default system.
- Select **About** to see information about the current software version.
- Select **Wi-Fi** to generate a new password for the Wi-Fi network. Only the password can be changed and not the network name (Wi-Fi SSID).

 The Wi-Fi connection including credential sharing with the user's smartphone happens automatically after successful Bluetooth® connection with a wireless supported smartphone.

 It cannot be used for Internet sharing in the vehicle nor software update nor any other purpose.

 The Wi-Fi network uses the 5 GHz frequency. Some smartphones may not support this feature.

 To protect your system, only networks with a sufficient level of security are allowed to connect. WPA2 encryption level, equivalent to a domestic level, is required.

## Display settings

 Press **Settings** to display the main page.

Press **Display**.

- Select **User off Mode** to enable/disable date and time display when the system is powered off.
- Select **Brightness** to adjust the brightness of the touch screen by using the + or - buttons.

## Phone settings

 Press **Settings** to display the main page.

Press **Phone**.

- Select **BT visibility** to turn on/off the Bluetooth® visibility of the system.
- Select **Add device** to select a mobile device to be connected.
- Select **Device list** to view the previously paired mobile devices and connect or delete a device.

## Audio settings

 Press **Settings** to display the main page.

Press **Audio**.

In this screen, you can modify the **Balance & Fade** settings, the **Equalizer** settings, the **Volume** settings and activate the **SDVC** (Speed Dependent Volume Control) option.

## Clock settings

 Press **Settings** to display the main page.

Press **Clock**.

### Automatic date & time setting

Select **Sync to GPS** to enable date and time synchronisation to GPS.  
Select **Time Zone** to choose the appropriate time zone.

### Manual date setting

Select **Date**.  
Choose the date format and then set the day, month and year using up and down arrows.  
Press **Set**.

### Manual time setting

Select **Time**.  
Choose the time format (12 hrs or 24 hrs) and then set the hours and minutes using up and down arrows.  
Press **Set**.

## Vehicle settings



Press **Settings** to display the main page.

Press **Vehicle**.

Select **Vehicle Alerts** to view alerts of the vehicle. When an active alert is present, it is displayed in the status bar. An icon is also displayed on the **Settings** menu button.

---

**A**

ABS ..... 23

Adjusting headlamps ..... 20

Adjusting seat ..... 14

Adjusting the air distribution ..... 17

Adjusting the air flow ..... 17

Adjusting the headlamp beam height ..... 20

Adjusting the height and reach of the steering wheel ..... 15

Adjusting the temperature ..... 17

Advice on care and maintenance ..... 41

Advice on driving ..... 4, 31

Airbags ..... 26–27

Airbags, front ..... 26–27

Air conditioning ..... 16–17

Air conditioning, manual ..... 17

Air intake ..... 18

Air vents ..... 16

Anti-lock braking system (ABS) ..... 23

Antitheft / Immobiliser ..... 10

---

**B**

Battery, 12 V ..... 39, 56, 58

Battery, remote control ..... 10

Bodywork ..... 41

Bonnet ..... 35–36

Boot ..... 11

Brake discs ..... 40

Brake lamps ..... 47

Brakes ..... 40

Bulbs ..... 45

Bulbs (changing) ..... 45–47

---

**C**

Capacity, fuel tank ..... 35

Cap, fuel filler ..... 35

Care of the bodywork ..... 41

Central locking ..... 9–10

Changing a bulb ..... 45–47

Changing a fuse ..... 48, 51

Changing a wheel ..... 42

Changing the remote control battery ..... 10

Checking the levels ..... 37–38

Checks ..... 37, 39–41

Checks, routine ..... 39–40

Child lock ..... 30

Children ..... 25

Children (safety) ..... 30

Child seats ..... 25, 28–29

Child seats, conventional ..... 29

Cleaning (advice) ..... 41

Closing the boot ..... 11

Control, emergency boot release ..... 11

Control, emergency door ..... 10

Control stalk, lighting ..... 20

Control stalk, wipers ..... 21

Courtesy lamp ..... 47

Courtesy lamps ..... 19

---

**D**

Dimensions ..... 60

Dipstick ..... 37

Direction indicators (turn signals) ..... 20, 46–47

Doors ..... 11

Driving ..... 31

Driving economically ..... 4

---

**E**

EBFD ..... 23

Eco-driving (advice) ..... 4

Electric windows ..... 12

Electronic brake force distribution (EBFD) ..... 23

Emergency warning lamps ..... 23

Engine ..... 35–36, 41

Engine compartment ..... 37

Engine, petrol ..... 60

Engines ..... 60

Environment ..... 10

---

**F**

Filling the fuel tank ..... 35

Filter, air ..... 40

Filter, oil ..... 40

Filter, passenger compartment ..... 16, 40

Fitting a wheel ..... 43–44

Fittings, boot ..... 19



Fittings, interior ..... 18  
 Flap, fuel filler ..... 35  
 Flashing indicators ..... 20, 46  
 Fluid, brake ..... 38  
 Fluid, engine coolant ..... 38  
 Folding the rear seats ..... 15–16  
 Fuel ..... 4  
 Fuel consumption ..... 4  
 Fuel level, low ..... 35  
 Fuel (tank) ..... 35  
 Fusebox, dashboard ..... 48  
 Fusebox, engine compartment ..... 48, 51  
 Fuses ..... 48, 51

**G**

Gauge, fuel ..... 35  
 Gearbox, manual ..... 32, 40  
 Gear lever, manual gearbox ..... 32  
 Gear shift indicator ..... 33  
 Glove box ..... 18

**H**

Hazard warning lamps ..... 23  
 Headlamps (adjustment) ..... 20  
 Headlamps, dipped beam ..... 46  
 Headlamps, halogen ..... 20, 45  
 Headlamps, main beam ..... 46  
 Heating ..... 16

Hooks ..... 19  
 Horn ..... 23

**I**

Indicator, coolant temperature ..... 7  
 Indicators, direction ..... 20, 46  
 Indicator, service ..... 7  
 Inflating tyres ..... 40, 61  
 Instrument panels ..... 5

**J**

Jack ..... 42  
 Jump starting ..... 56

**K**

Key ..... 9–10  
 Key with remote control ..... 9, 31

**L**

Labels, identification ..... 60  
 Lamps, rear ..... 47  
 LEDs - Light-emitting diodes ..... 46–47  
 Level, brake fluid ..... 38  
 Level, engine coolant ..... 7, 38

Level, engine oil ..... 37  
 Levels and checks ..... 37–38  
 Level, screenwash fluid ..... 21, 38  
 Light-emitting diodes - LEDs ..... 46–47  
 Lighting, exterior ..... 20  
 Lighting, interior ..... 19  
 Locating your vehicle ..... 9  
 Locking ..... 9  
 Locking from the inside ..... 10  
 Locking the doors ..... 10

**M**

Maintenance (advice) ..... 41  
 Maintenance, routine ..... 39  
 Map reading lamps ..... 19  
 Markings, identification ..... 60  
 Mirrors, door ..... 15

**O**

Obstacle detection ..... 33  
 Oil change ..... 37  
 Oil consumption ..... 37  
 Oil, engine ..... 37  
 On-board tools ..... 42  
 Opening the bonnet ..... 35–36  
 Opening the boot ..... 11  
 Opening the doors ..... 11

---

**P**

Pads, brake ..... 40

Paint ..... 41

Parking sensors, audible and visual ..... 33

Parking sensors, rear ..... 33

Plates, identification ..... 60

Port, USB ..... 18

Pressures, tyres ..... 40, 61

Pre-tensioning (seat belts) ..... 25

Protecting children ..... 26–28

Puncture ..... 42

---

**R**

Recirculation, air ..... 18

Reminder, lighting on ..... 20

Remote control ..... 9–10

Removing a wheel ..... 43–44

Replacing bulbs ..... 45–47

Replacing fuses ..... 48

Replacing the air filter ..... 40

Replacing the oil filter ..... 40

Replacing the passenger compartment filter ..... 40

Reservoir, screenwash ..... 38

Reversing lamps ..... 47

Roof rack ..... 41

---

**S**

Safety, children ..... 26–28

Screenwash ..... 21

Screenwash, front ..... 21

Seat belts ..... 24–25

Seats, front ..... 14

Seats, rear ..... 15–16

Serial number, vehicle ..... 60

Servicing ..... 7, 39, 40–41

Sidelamps ..... 47

Starting the engine ..... 31

Starting the vehicle ..... 31–32

Starting using another battery ..... 56

Stay, engine bonnet ..... 36

Steering wheel (adjustment) ..... 15

Stopping the vehicle ..... 31–32

Storage ..... 18

Suspension ..... 40

Switch, ignition ..... 31

Switching off the engine ..... 31

---

**T**

Tables of engines ..... 60

Tables of fuses ..... 48, 51

Tank, fuel ..... 35

Technical data ..... 60

Temperature, coolant ..... 7

Tools ..... 42

Towing ..... 58–59

Trip computer ..... 7–8

Tyres ..... 40, 61

---

**U**

Unlocking ..... 9

Unlocking from the inside ..... 10

Unlocking the doors ..... 10

---

**V**

Ventilation ..... 16

---

**W**

Warning and indicator lamps ..... 5

Warning lamp, driver's seat belt not fastened ..... 25

Warning lamps ..... 5

Warning lamp, seat belts ..... 25

Warnings and indicators ..... 5

Washing (advice) ..... 41

Wheel, spare ..... 40, 42–44

Wipers ..... 21

Wipers, windscreen ..... 21

# TABLE OF CONTENTS

What is this chapter and How to use it? .....

## **WARRANTY SECTION**

CITROËN Contractual Warranty Certificate .....

Standard Warranty .....

Battery Warranty.....

Replacement Part Warranty .....

Coupons .....

## **MAINTENANCE SECTION**

Maintenance .....

Scheduled Maintenance .....

Maintenance Schedule .....

Service Record .....

## **CITROËN ASSISTANCE**

## WHAT IS THIS CHAPTER AND HOW TO USE IT?

This maintenance and warranty chapter explains the warranty terms of your new CITROËN vehicle as well as the maintenance required to keep your new CITROËN vehicle at its optimum performance level.

The Warranty Section explains the general terms and conditions related to new CITROËN vehicle warranty.

The Maintenance Section explains the maintenance information which includes the necessity, types of maintenance, and the scheduled maintenance table which should be used to record your CITROËN vehicle's maintenance history.

Every time a CITROËN authorised dealer ("Authorised Dealer") services your CITROËN vehicle, they will check your vehicle's maintenance record and the warranty conditions so that we can provide you with proper warranty and maintenance services. Kindly remember that warranty support is provided under the condition that the proper maintenance of your CITROËN vehicle is carried out according to the prescribed maintenance schedule, as it is mentioned in the Warranty Section.

We encourage you to always keep the Owner's Manual in your CITROËN vehicle and to hand it over to the next vehicle owner in the event that you sell your CITROËN vehicle.

# WARRANTY

WARRANTY SECTION

# SECTION

# CITROËN CONTRACTUAL WARRANTIES CERTIFICATE

## CITROËN Contractual warranty

This certificate must be completed and stamped by the Citroën Authorised Dealer in order to validate the CITROËN contractual warranty ("Contractual Warranty"). Application of the said warranties is dependent on the carrying out of routine services, as detailed in your service schedule, evidence of this being provided by the completed counterfoils in this chapter.

The benefits of Citroën contractual warranty are not available to you in case of repairs carried out apart from the scheduled services mentioned in this chapter; even if such repairs are carried out by a repairer authorised by PAIPL ("Authorised Repairer").

The CITROËN contractual warranties take effect from the effective day of delivery of your vehicle (warranty start date entered on this page).

Details of the CITROËN contractual warranties which your vehicle benefits from, as well as their conditions of application, are given on the order form for your new vehicle.

## SELLING DEALER:

Vehicle prepared and delivered according to the procedure defined by CITROËN  
Customer Name & Address:

Customer Sign:

Stamp of the Selling Dealer

The routine service schedule specific to your vehicle was given to you at handover. **This document can be found in your vehicle's handbook pack.** If this is missing, your dealer or any CITROËN Authorised Repairer will be able to supply a replacement or you can view it from your MyCITROËN App. You are advised to retain any invoices or documents relating to work carried out on your Citroën vehicle. In the event of resale of the vehicle, it is necessary to give them to the new owner, along with all documents relating to the vehicle.



## STANDARD WARRANTY

### CITROËN New Vehicle Warranty

PCA Automobiles India Private Limited (hereinafter called "PAIPL"), warrants that each new CITROËN vehicle sold shall be free from any defects in material and workmanship, under normal use and maintenance, subject to the following terms and conditions.

### New Vehicle Warranty Period

This warranty ("New Vehicle Warranty") shall exist for a period of **24 months or 40,000 kilometres**, from the date of delivery whichever is earlier ("New Vehicle Warranty Period"). This warranty is transferable to subsequent owner for the remaining New Vehicle Warranty Period. This warranty is applicable only in India and not transferable to any other country.

### What is covered?

Except as provided in "What is not covered?" hereof, our Authorised Dealers shall either repair or replace, any CITROËN genuine part that is acknowledged by PAIPL to be defective in material or workmanship within the New Vehicle Warranty Period stipulated above, at no cost to the owner of the CITROËN vehicle for parts or labour. Such defective parts which have been replaced will become the property of PAIPL.

### What is not covered?

This warranty shall not apply to:

- Normal maintenance services, including without limitation, cleaning and polishing, minor adjustments, engine tuning, oil/ fluid changes, filters replenishment, fastener retightening, wheel balancing, wheel alignment and tyre rotation etc.
- Replacement of parts as a result of normal wear and tear such as spark plugs, belts, brake pads and linings, clutch disc/facing, filters, wiper blades, bulbs, fuses, etc.

- Any vehicle on which the odometer reading has been altered so that mileage cannot be accurately determined.

### What is not covered?

#### Damage or failure resulting from:

- Negligence of proper maintenance as required in the chapter.
- Misuse, abuse, accident, theft, flooding or fire.
- Use of improper or insufficient fuel, fluids or lubricants.
- Use of parts other than CITROËN Genuine Parts.
- Any device and/or accessories not supplied by PAIPL.
- Modifications, alterations, tampering or improper repair.
- Parts used in applications of which they were not designed or not approved by PAIPL.
- Slight irregularities not recognised as affecting quality or function of the vehicle or parts, such as slight noise or vibrations, or items considered characteristic of the vehicle.
- Airborne, fallout, industrial fallout, acid rain, hail and wind storms, or other Acts of God.
- Paint scratches, dents or similar paint or body damage.
- Action of road elements (sand, gravel, dust or road debris) which results in stone chipping of paint or glass.
- Incidental or consequential damages, including without limitation, loss of time, inconvenience, loss of use of vehicle or commercial loss.
- This warranty is the entire warranty given by PAIPL for CITROËN vehicles and no dealer or its or his agent or employee is authorised to extend or enlarge this warranty and no dealer or its or his agent or employee is authorised to make any oral warranty on PAIPL behalf.
- PAIPL reserves the right to make any change in design or make any improvement on the vehicle at any time without any obligation to make the same change on vehicles previously sold.
- PAIPL reserves the right for the final decision in all warranty matters.



## STANDARD WARRANTY

### Owner's Responsibilities

- Proper use, maintenance and care of vehicle in accordance with the instructions contained in owner's manual ("Owner's Manual"). If the vehicle is subject to severe usage conditions, such as operation in extremely dusty, rough, more repeated short distance driving or heavy city traffic during hot weather, maintenance of vehicle should be done more frequently as mentioned in Owner's Manual.
- Retention of maintenance service records. It may be necessary for the customer to show that the required maintenance has been performed, as specified in Owner's Manual.
- Delivery of the vehicle during regular service business hours to any CITROËN Authorised Dealer to obtain warranty service.
- In order to maintain the validity of this standard warranty, the vehicle must be serviced by CITROËN authorised workshop in accordance to the Owner's Manual.

### What we will do?

- Warranty repairs will be made at no charge for parts and/or labour. Any needed parts replacement will be rendered with new or authorised remanufactured parts by CITROËN Authorised Dealer. A reasonable time to complete the repairs must be allowed after the CITROËN vehicle is handed over to CITROËN Authorised Dealer.
- Labour free service will be performed one-time each at 2,000 Kms (2 Months) & 10,000 km (12 Months) & 20,000 km (24 Months).
- Warranty on any part replaced under New Vehicle Warranty will end on the expiry of New Vehicle Warranty.

### Tire information

- Tires originally installed on a new CITROËN vehicle are warranted by the tire manufacturer.

### Fitting after-market accessories

- If you wish to install accessories on the vehicle, please contact authorized Citroën dealer.
- Citroën India do not recommend to fit any non-genuine accessories.
- Please note that Citroën India will not be responsible for any issues pertaining to Non-Genuine Accessories fitted either by dealership or aftermarket.

#### NOTICE:

**Video Navigation & Telematics System, Batteries, Tyres and Audio Systems, originally equipped on CITROËN vehicles are warranted directly by the respective manufacturers and not by PAIPL.**

## BATTERY WARRANTY

### Terms & Conditions for Battery Warranty

- **Battery originally installed on a new CITROËN vehicle is warranted by the battery manufacturer.**
- Batteries are warranted against all defects in material and workmanship. Liability under this Battery Warranty is limited to making good of defects arising solely from the use of faulty material or workmanship during manufacture and developing under proper use.
- The Battery Warranty is VALID only if the battery is properly used and checked regularly as per the maintenance schedule at the service stations of the CITROËN Authorised Dealers during the New Vehicle Warranty Period.
- This Battery warranty does not cover damage to the battery caused by faulty electrical systems, irregular servicing, negligent maintenance, wilful abuse or destruction by fire, collision or theft.
- This Battery Warranty is NOT VALID if the battery under complaint has been opened or tampered with in any manner whatsoever. It should be returned to the nearest CITROËN Authorised Dealer complete with the electrolyte. The CITROËN Authorised Dealer has the option either to rectify the defect in the battery or replace the battery.
- Breakage of container and cover does not come under the purview of this Battery Warranty.
- To and fro transportation charges of the battery under complaint will be borne by the customer.
- The liability under this Battery Warranty will cease on the transfer of the battery to any person other than the original purchaser of the new Citroën vehicle or to any vehicle other than that on which the battery was originally fitted.

### Battery Installation and General Maintenance

Although the battery is made as robust and durable as possible, the following must be observed to get maximum performance from the battery.

- The battery must be fitted firmly in the battery cradle, so that no undue vibration or straining occurs.
- Connecting cables should have adequate current carrying capacity and be long enough to prevent straining of the battery terminals. It must be ensured that correct polarities (plus to plus and minus to minus) are connected.
- Terminals should be brushed clean before connecting and coated immediately afterwards with pure petroleum jelly and NOT grease.
- Battery top should be clean and dry.

## REPLACEMENT PART WARRANTY

PAIPL warrants that each new CITROËN genuine replacement part purchased from and installed by CITROËN Authorised Dealer shall be free from any defects in material or workmanship, under normal use and maintenance, subject to the following terms and conditions.

### Replacement Parts Warranty Period

This warranty ("Parts Warranty") shall exist for a period of **1 Year or until the vehicle has been driven for a distance of 10,000 Kilometres** from the date of installation of replacement part by CITROËN Authorised Dealer, whichever occurs first ("Parts Warranty Period").

### What is covered?

Our Authorised Dealers shall either repair or replace, any CITROËN genuine part (except the cases listed in "What is not covered?" below), that is acknowledged by PAIPL to be defective in material or workmanship within the Parts Warranty Period stipulated above, after examinations carried out to confirm that none of the original settings have been tampered with, at no cost to the owner of the CITROËN vehicle for parts or labour. Such defective parts which have been replaced will become the property of PAIPL.

### What is not covered?

This Parts Warranty shall not apply to:

- Normal maintenance services of parts such as brake cleaning, adjustment or replacement (i.e. spark plugs that are oil fouled, lead fouled, or which fail due to the use of low grade fuel).
- Parts that fail due to abuse, misuse, neglect, alteration or accident or which have been improperly lubricated or repaired.
- Parts used in applications for which they were not designed or approved by PAIPL.
- Failure due to normal wear of parts.

- Direct or indirect failures caused by misuse and improper maintenance of vehicle.
- Any vehicle on which the odometer reading has been altered so that mileage cannot be accurately determined.
- Incidental or consequential damages, including without limitation, loss of time, inconvenience, loss of use of vehicle or commercial loss.

This Parts Warranty is the entire warranty given by PAIPL for CITROËN replacement parts and no dealer or its or his agent or employee is authorised to extend or enlarge this warranty and no dealer or its or his agent or employee is authorised to make any oral warranty on PAIPL behalf. PAIPL reserves the right for the final decision in all warranty matters.

### Owner's Responsibility:

- Proper use, maintenance and care of the vehicle in accordance with the instructions contained in the Owner's Manual.
- Retention of maintenance service records. It may be necessary for the customer to show that the required maintenance has been performed, as specified in the Owner's Manual.
- Retention of the customer's copy of the original repair order and its invoice/bill against which the part was replaced.
- Delivery of the vehicle during regular service business hours to the same CITROËN Authorised Dealer who had sold and installed the replacement part.
- In order to maintain the validity of this Parts Warranty, the vehicle must be serviced by CITROËN authorised workshop in accordance to the Owner's Manual.



**CITROËN Authorised Dealer**  
**Pre Delivery Inspection Coupon**

Owner's Name:

Address:

VIN:

Engine No:

Date of Service:

Mileage at Service:

Selling Dealer name:

Owner's Signature:

**NOTE**  
**This is not valid after 100kms**

**Notice of name/address ownership change**

In case your name and/or address changes or you become a subsequent owner, please be sure to complete and mail this slip to the address of the CITROËN Authorised Dealer shown on the vehicle identification page of this section.

This slip will enable us to update our ownership file for future contact with you as required.



**Pre Delivery Inspection (PDI) Coupon**

Please see the MAINTENANCE SECTION in this chapter.



**Notice of name/address  
ownership change**

**NAME/ADDRESS CHANGE**

**SUBSEQUENT OWNER**

Please check one of the above boxes

Owner's Name: \_\_\_\_\_

Address: \_\_\_\_\_

\_\_\_\_\_

\_\_\_\_\_

VIN: \_\_\_\_\_

Engine No: \_\_\_\_\_

Registration No: \_\_\_\_\_

Date of Purchase: \_\_\_\_\_

Mileage at Present: \_\_\_\_\_

Owner's Signature: \_\_\_\_\_

**THANK YOU FOR YOUR CO-OPERATION**  
**Please give complete information**

**Notice of name/address ownership change**

In case your name and/or address changes or you become a subsequent owner, please be sure to complete and mail this slip to the address of the CITROËN Authorised Dealer shown on the vehicle identification page of this section.

This slip will enable us to update our ownership file for future contact with you as required.



**CITROËN Authorised Dealer**  
**Labour free service coupon**  
**2 Months / 2000 kms**

Owner's Name: \_\_\_\_\_

Address: \_\_\_\_\_  
 \_\_\_\_\_  
 \_\_\_\_\_

VIN: \_\_\_\_\_

Engine No: \_\_\_\_\_

Date of Service: \_\_\_\_\_

Mileage at Service: \_\_\_\_\_

Servicing Dealer name: \_\_\_\_\_

Selling Dealer name: \_\_\_\_\_

Owner's Signature: \_\_\_\_\_

**NOTE**  
**This is not valid after 3 Months or 3000 kms**



**LABOUR FREE SERVICE at  
2 months / 2,000 kms**

Please see the MAINTENANCE SECTION in this chapter.



**Notice of name/address  
ownership change**

**NAME/ADDRESS CHANGE**

**SUBSEQUENT OWNER**

Please check one of the above boxes

Owner's Name:

Address:

VIN:

Engine No:

Registration No:

Date of Purchase:

Mileage at Present:

Owner's Signature:

**THANK YOU FOR YOUR CO-OPERATION**  
**Please give complete information**





### Notice of name/address ownership change

In case your name and/or address changes or you become a subsequent owner, please be sure to complete and mail this slip to the address of the CITROËN Authorised Dealer shown on the vehicle identification page of this section.

This slip will enable us to update our ownership file for future contact with you as required.



### CITROËN Authorised Dealer Labour free service coupon 12 Months / 10000 kms

Owner's Name:

Address:

VIN:

Engine No:

Date of Service:

Mileage at Service:

Servicing Dealer name:

Selling Dealer name:

Owner's Signature:

**NOTE**  
**This is not valid after 13 Months or 13000 kms**



**LABOUR FREE SERVICE at  
12 months / 10,000 kms**

Please see the MAINTENANCE SECTION in this chapter.  
Note: Parts cost to be borne by customer.



**Notice of name/address**

**Ownership change**

**NAME/ADDRESS CHANGE**

**SUBSEQUENT OWNER**

Please check one of the above boxes

Owner's Name:

Address:

VIN:

Engine No:

Registration No:

Date of Purchase:

Mileage at Present:

Owner's Signature:

**THANK YOU FOR YOUR CO-OPERATION**  
**Please give complete information**





### Notice of name/address ownership change

In case your name and/or address changes or you become a subsequent owner, please be sure to complete and mail this slip to the address of the CITROËN Authorised Dealer shown on the vehicle identification page of this section.

This slip will enable us to update our ownership file for future contact with you as required.



### CITROËN Authorised Dealer Labour free service coupon 24 Months / 20000 kms

Owner's Name:

---

Address:

---



---



---



---

VIN:

---

Engine No:

---

Date of Service:

---

Mileage at Service:

---

Servicing Dealer name:

---

Selling Dealer name:

---

Owner's Signature:

---

**NOTE**  
**This is not valid after 25 Months or 23000 kms**



**LABOUR FREE SERVICE at  
24 months / 20,000 kms**

Please see the MAINTENANCE SECTION in this chapter.

Note: Parts cost to be borne by customer



**Notice of name/address**

**Ownership change**

**NAME/ADDRESS CHANGE**

**SUBSEQUENT OWNER**

Please check one of the above boxes

Owner's Name:

Address:

VIN:

Engine No:

Registration No:

Date of Purchase:

Mileage at Present:

Owner's Signature:

**THANK YOU FOR YOUR CO-OPERATION**  
**Please give complete information**



---

# MAINTENANCE

MAINTENANCE SECTION

# SECTION

## MAINTENANCE

### **Necessity of maintenance**

Your CITROËN vehicle has been manufactured using the latest technology and under the strictest quality control standards. It is also designed to minimize maintenance requirements with longer service intervals to save you both time and money.

However, scheduled maintenance is necessary to ensure your CITROËN vehicle operates properly and efficiently for the reasons listed below:

#### **Lubricants:**

Your CITROËN vehicle uses various kinds of oils and fluids, including engine oil, transmission fluid, differential fluid, battery fluid, and engine coolant. These oils and fluids play very important roles, such as lubricating and cooling the vehicle and preventing rust. Periodically they need to be properly refilled or replaced.

#### **Rubber parts:**

Hoses, belts and boots use rubber parts, which are bound to crack when worn out. They need to be replaced with new ones if they should wear out.

#### **Normal deterioration**

Vehicles are equipped with many parts for which it is impossible to avoid normal wear and tear. These parts include: tires, brake pads, clutch disc, etc. They are indispensable for basic vehicle functions and must be replaced regularly.

### **Maintenance services at CITROËN Authorised Dealers**

A CITROËN Authorised Dealer has factory-trained technicians and genuine CITROËN parts to service your vehicle properly. For expert advice and quality service, visit a CITROËN Authorised Dealer.

Inadequate, incomplete or insufficient servicing may result in operational problems with your vehicle that could lead to vehicle damage, an accident, or personal injury.

We appreciate your understanding of the importance of these instructions, and we look forward to servicing your vehicle at CITROËN Authorised Dealers.



**WARNING!**

**Failure to perform scheduled maintenance may result in reduced vehicle performance or possible breakdowns, as well as exclusion from warranty coverage**

## SCHEDULED MAINTENANCE

There are two types of maintenance schedules, namely, normal usage condition & severe usage conditions

A sales person or service advisor at our CITROËN Authorised Dealer will explain to you which type of maintenance schedule you should follow depending on your driving pattern, climatic conditions in your area, etc. The two schedules and their conditions are described below:

Follow the Maintenance under severe usage conditions if any of the following conditions apply.

- Repeated driving short distance of less than 8 km in normal temperature or less than 16 km in freezing temperature.
- Extensive engine idling or low speed driving for long distances.
- Driving on rough, muddy, unpaved, gravelled or salt-spread roads.
- Driving in areas using salt or other corrosive materials or in very cold weather.
- Driving in heavy dust condition.
- Driving in heavy traffic area.
- Driving on uphill, downhill, or mountain road repeatedly.
- Vehicle towing, driving for patrol car, taxi, or other commercial use.
- Driving over 170 km/h.
- Frequently driving in stop-and-go condition.

If your vehicle is operated in any of the above listed conditions, you should inspect, replace or refill more frequently, using the severe usage maintenance schedule instead of the normal usage maintenance schedule.

## MAINTENANCE SCHEDULE

The following maintenance services must be performed to ensure good emission control and performance. Keep receipts for all vehicle emission services to protect your warranty. Where both mileage and time are shown, the frequency of service is determined by whichever occurs first.

	Service	1	2	3	4	5	6	7	8	9	10	11	
<b>C3 Naturally Aspirated</b>	<b>Months</b>	2	12	24	36	48	60	72	84	96	108	120	
	<b>Km (K)</b>	2	10	20	30	40	50	60	70	80	90	100	
1.2L (1199cc) (3 Cyl) 60KW @ 5750 rpm 115Nm @ 3750 rpm	Air cleaner filter element		C	R	C	R	C	R	C	R	C	R	
	Engine oil	I	R	R	R	R	R	R	R	R	R	R	
	Oil Filter		R	R	R	R	R	R	R	R	R	R	
	Drain Plug Gasket		R	R	R	R	R	R	R	R	R	R	
	Change Spark plugs					R				R			
	Check accessory belt (waterpump & Stretch belt)		I	I	I	I	I	I	I	R	I	I	
	Change coolant	I	I	I	I	I	R	I	I	I	I	R	
	Pollen Filter		R	R	R	R	R	R	R	R	R	R	
	Fuel Filter (intank)												R
	Brake Fluid/Clutch Fluid	I	I	R	I	R	I	R	I	R	I	R	
	Check timing belt visual condition, replace if found damage									R			
Rear Twist Beam Bush – Check wear and tear or noise, replace if found.		I	I	I	I	I	I	I	I	I	I		

A: Adjust    C: Clean    I: Inspect    R: Replace



		Service	1	2	3	4	5	6	7	8	9	10	11
C3 Turbo	Months		2	12	24	36	48	60	72	84	96	108	120
	Km (K)		2	10	20	30	40	50	60	70	80	90	100
1.2L (1199 cc) (3 Cyl) 81KW @ 5500 rpm 190Nm @ 1750 rpm	Air cleaner filter element			C	R	C	R	C	R	C	R	C	R
	Change engine oil			R	R	R	R	R	R	R	R	R	R
	Oil Filter			R	R	R	R	R	R	R	R	R	R
	Drain Plug Gasket			R	R	R	R	R	R	R	R	R	R
	Change Spark plugs						R				R		
	Check accessory belt condition visually, replace if found damage			I	I	I	I	I	I	I	R	I	I
	Change coolant			I	I	I	I	R	I	I	I	I	R
	Pollen Filter			R	R	R	R	R	R	R	R	R	R
	Fuel Filter (intank)												R
	Brake/Clutch Fluid			I	R	I	R	I	R	I	R	I	R
	Check timing belt visual condition, replace if found damage										R		
Rear Twist Beam Bush – Check wear and tear or noise, replace if found.			I	I	I	I	I	I	I	I	I	I	

A: Adjust C: Clean I: Inspect R: Replace

## SERVICE RECORD

The following tables are to be signed and stamped by the CITROËN Authorised Dealer who services your CITROËN vehicle. Have the boxes below (date, mileage, next service, etc.) completed, according to your conditions of use, by Authorised Repairer that you have chosen. You are advised to retain any invoices or documents relating to work carried out on your vehicle. In the event of resale of the vehicle, it is necessary to give them to the new owner, along with all documents relating to the vehicle. Having the routine services carried out is a compulsory requirement to meet the conditions of the CITROËN contractual warranties.

Date	Odometer reading (Kms)	Next Service date	Next Service Kms	Dealer Seal & Sign	Remarks

## SERVICE RECORD

Date	Odometer reading (Kms)	Next Service date	Next Service Kms	Dealer Seal & Sign	Remarks

## CITROËN ASSISTANCE

### CITROËN ASSISTANCE

With the CITROËN ASSISTANCE service, you can contact our breakdown and towing services anywhere in India, 24 hours a day, 7 days a week.

### CITROËN ASSISTANCE services

CITROËN ASSISTANCE will provide assistance, free of charge, if your vehicle is immobilised as a result of a breakdown covered by the CITROËN contractual warranty or CITROËN service contract that you purchased (extended warranty, maintenance plan, etc.) which is valid.

For vehicles or incidents that are not covered by the contractual warranty such as punctures, lost keys, lock-outs, incorrect fuel type, or any other non-vehicle fault incident, CITROËN ASSISTANCE can arrange assistance with a roadside assistance agent if requested.

### Contact CITROËN ASSISTANCE

- By pressing on CITROËN CONNECT ASSISTANCE if your vehicle is fitted with it (press the CITROËN button) or,
- By calling the CITROËN ASSISTANCE number found on the back cover, or
- Using the MyCITROËN app (Contact & Assistance)



A customer care agent will answer your call and handle your problem in full: they will perform a preliminary diagnosis and attempt to solve your incident over the phone. If required, a roadside assistance agent will be dispatched to the breakdown location within a timeframe provided during the call. They will repair your vehicle at the roadside to enable you to set off again immediately. If this is not possible, the roadside assistance agent will tow your vehicle to the nearest CITROËN Authorised Repairer.

In any case the kms for towing are restricted to 100 kms for free towing, all kms above 100 kms would be on chargeable basis at Rs 65 per km.

### CITROËN ASSISTANCE ensures your mobility

The CITROËN Authorised Repairer based on your request shall provide referral for an alternative means of travel if your vehicle is immobilised as a result of a breakdown covered by the CITROËN contractual warranty or valid CITROËN service contract, or alternatively at your expense, for your onward travel or your return home.

If you are stranded more than 100 kms from your home, you can ask for the referral for the following at your expense:

- Hotel accommodation
- Referral for forward travel from breakdown location to the destination (OR)
- Referral for return travel from breakdown location to the customer residence

Note: Various rules governing eligibility, luggage allowance and seating capacity shall be applicable as enforced by hotel, or transportation party.

## CITROËN ASSISTANCE 24 hours a day - 7 days a week



If your vehicle has the localised assistance call service, use it by pressing the button.

The location and identification of your vehicle will automatically be sent to CITROËN ASSISTANCE.

**Be ready to provide the following information to the CITROËN ASSISTANCE call centre:**

- the precise location of your vehicle: town/city, street name and number, road number and visual marker, etc.
- the identification of your vehicle: registration number or vehicle identification number (VIN) visible on the registration certificate or at the bottom left-hand side of the windscreen (from outside the vehicle)
- your mobile telephone number so that the roadside assistance agent can contact you
- the number of passengers in the vehicle

TOLL FREE NUMBER FOR <b>CITROËN</b> ASSISTANCE	<b>18004192000</b>
TOLL FREE NUMBER OF <b>CITROËN</b> CUSTOMER CARE CALL CENTRE	<b>18002671000</b>
EMAIL ID OF <b>CITROËN</b> CUSTOMER CARE CALL CENTRE	contact@citroen-crm.in



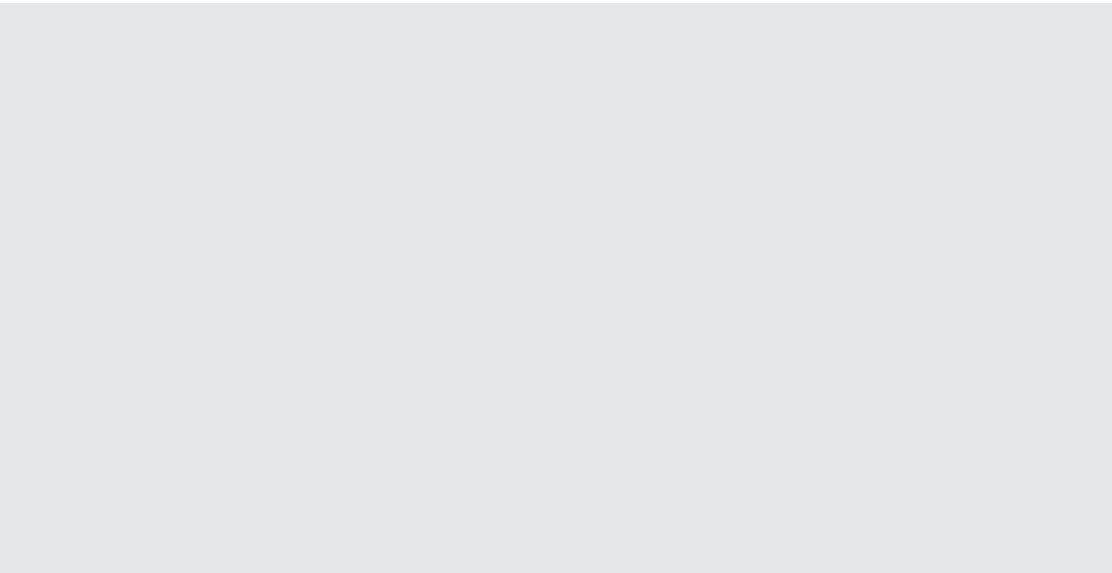

**4DCONCEPT**

05-22

Automobiles CITROËN

Siège social : 2-10, boulevard de l'Europe - 78300 POISSY

[www.citroen.com](http://www.citroen.com)

Société anonyme au capital de 159 000 000 € - R.C.S. VERSAILLES : 642 050 199

