

# Owner's Manual

2021 TLX

## **⚠️ WARNING**

### **California Proposition 65 Warning**

Operating, servicing and maintaining a passenger vehicle or off-highway motor vehicle can expose you to chemicals including engine exhaust, carbon monoxide, phthalates, and lead, which are known to the State of California to cause cancer and birth defects or other reproductive harm. To minimize exposure, avoid breathing exhaust, do not idle the engine except as necessary, service your vehicle in a well-ventilated area and wear gloves or wash your hands frequently when servicing your vehicle. For more information go to [www.P65Warnings.ca.gov/passenger-vehicle](http://www.P65Warnings.ca.gov/passenger-vehicle).

### **Event Data Recorders**

**This vehicle is equipped with an event data recorder (EDR).** The main purpose of an EDR is to record, in certain crash or near crash-like situations, such as an air bag deployment or hitting a road obstacle, data that will assist in understanding how a vehicle's systems performed. **The EDR is designed to record data related to vehicle dynamics and safety systems for a short period of time, typically 30 seconds or less. The EDR in this vehicle is designed to record such data as:**

- **How various systems in your vehicle were operating;**
- **Whether or not the driver and passenger safety belts were buckled/fastened;**
- **How far (if at all) the driver was depressing the accelerator and/or brake pedal; and,**
- **How fast the vehicle was traveling.**

These data can help provide a better understanding of the circumstances in which crashes and injuries occur. NOTE: EDR data are recorded by your vehicle only if a non-trivial crash situation occurs; no data are recorded by the EDR under normal driving conditions and no personal data (e.g., name, gender, age, and crash location) are recorded. However, other parties, such as law enforcement, could combine the EDR data with the type of personally identifying data routinely acquired during a crash investigation.

To read data recorded by an EDR, special equipment is required, and access to the vehicle or the EDR is needed. In addition to the vehicle manufacturer, other parties, such as law enforcement, that have the special equipment, can read the information if they have access to the vehicle or the EDR.

The data belongs to the vehicle owner and may not be accessed by anyone else except as legally required or with the permission of the vehicle owner.

## **Service Diagnostic Recorders**

This vehicle is equipped with service-related devices that record information about powertrain performance. The data can be used to verify emissions law requirements and/or help technicians diagnose and solve service problems. It may also be combined with data from other sources for research purposes, but it remains confidential. Some diagnostic and maintenance information is uploaded to Acura upon vehicle start up.

## **California Perchlorate Contamination Prevention Act**

The airbags, seat belt tensioners, and CR type batteries in this vehicle may contain perchlorate materials - special handling may apply. See [www.dtsc.ca.gov/hazardouswaste/perchlorate/](http://www.dtsc.ca.gov/hazardouswaste/perchlorate/)

As you read this manual, you will find information that is preceded by a **NOTICE** symbol. This information is intended to help you avoid damage to your vehicle, other property, or the environment.

## **Software End User License Agreement**

Your vehicle comes equipped with software, which is governed by the End User License Agreement in Owner's Manual, and which contains a binding arbitration clause. Please refer to the End User License Agreement for the terms and conditions governing your use of the installed software, as well as the applications, services, functions, and content provided through the software. Your use of the installed software will serve as your consent to the terms and conditions of the End User License Agreement.

You may opt out within 30 days of your initial use of the Software by sending a signed, written notice to ACURA at American Honda Motor Co., Inc. Acura Client Relations Mail Stop 100-5E-8F, 1919 Torrance Blvd. Torrance, CA 90501-2746.

## **Privacy Notice**

This vehicle may share location and usage information. To manage this setting, visit [www.acuralink.com/vehicle-data-choices](http://www.acuralink.com/vehicle-data-choices).

**To learn more about how we collect and use Personal Information, please read our Privacy Policy, accessible at [www.acura.com](http://www.acura.com).**

## A Few Words About Safety

---

Your safety, and the safety of others, is very important. And operating this vehicle safely is an important responsibility.

To help you make informed decisions about safety, we have provided operating procedures and other information on labels and in this manual. This information alerts you to potential hazards that could hurt you or others.

Of course, it is not practical or possible to warn you about all the hazards associated with operating or maintaining your vehicle. You must use your own good judgment.

You will find this important safety information in a variety of forms, including:

- **Safety Labels** - on the vehicle.
- **Safety Messages** - preceded by a safety alert symbol  and one of three signal words: **DANGER**, **WARNING**, or **CAUTION**. These signal words mean:

 **DANGER**

You **WILL** be **KILLED** or **SERIOUSLY HURT** if you don't follow instructions.

 **WARNING**

You **CAN** be **KILLED** or **SERIOUSLY HURT** if you don't follow instructions.

 **CAUTION**

You **CAN** be **HURT** if you don't follow instructions.

- **Safety Headings** - such as Important Safety Precautions.
- **Safety Section** - such as Safe Driving.
- **Instructions** - how to use this vehicle correctly and safely.

This entire book is filled with important safety information - please read it carefully.

This owner's manual should be considered a permanent part of the vehicle and should remain with the vehicle when it is sold.

This owner's manual covers all models of your vehicle. You may find descriptions of equipment and features that are not on your particular model.

Images throughout this owner's manual (including the front cover) represent features and equipment that are available on some, but not all, models. Your particular model may not have some of these features.

This owner's manual is for vehicles sold in the United States and Canada.

The information and specifications included in this publication were in effect at the time of approval for printing. Honda Motor Co., Ltd. reserves the right, however, to discontinue or change specifications or design at any time without notice and without incurring any obligation.

## ➤ Safe Driving P. 31

For Safe Driving P. 32

Seat Belts P. 36

Airbags P. 43

## ➤ Instrument Panel P. 77

Indicators P. 78

Gauges and Multi-Information Display P. 97

## ➤ Controls P. 115

Clock P. 116

Windows P. 140

Seats P. 166

Locking and Unlocking the Doors P. 118

Moonroof P. 143

Interior Convenience Items P. 178

## ➤ Features P. 201

Audio System P. 202

Customized Features P. 300

Audio System Basic Operation P. 208

HomeLink® Universal Transceiver P. 324

## ➤ Driving P. 365

Before Driving P. 366

Parking Your Vehicle P. 492

Towing a Trailer P. 371

Multi-View Rear Camera\* P. 503

## ➤ Maintenance P. 517

Before Performing Maintenance P. 518

Checking and Maintaining Wiper Blades P. 541

Climate Control System Maintenance P. 559

Maintenance Minder™ P. 521

## ➤ Handling the Unexpected P. 567

Tools P. 568

Indicator, Coming On/Blinking P. 597

If You Cannot Open the Trunk P. 614

If a Tire Goes Flat P. 569

Fuses P. 605

## ➤ Information P. 617

Specifications P. 618

Emissions Testing P. 623

Identification Numbers P. 620

Warranty Coverages P. 625

# Contents

Child Safety P. 61

Exhaust Gas Hazard P. 75

Safety Labels P. 76

Opening and Closing the Trunk P. 134

Operating the Switches Around the Steering Wheel P. 144

Climate Control System P. 195

Security System P. 137

Mirrors P. 163

Audio Error Messages P. 274

*Bluetooth*® HandsFreeLink® P. 327

General Information on the Audio System P. 277

AcuraLink® P. 356

When Driving P. 372

Surround View Camera System\* P. 505

AcuraWatch™ P. 413

Refueling P. 513

Braking P. 483

Fuel Economy and CO<sub>2</sub> Emissions P. 516

Maintenance Under the Hood P. 527

Checking and Maintaining Tires P. 544

Cleaning P. 560

Replacing Light Bulbs P. 539

Battery P. 553

Accessories and Modifications P. 565

Remote Transmitter Care P. 557

Engine Does Not Start P. 590

Emergency Towing P. 612

Refueling P. 615

If the Battery Is Dead P. 593

If You Cannot Unlock the Fuel Fill Door P. 613

Overheating P. 595

Devices that Emit Radio Waves P. 621

Authorized Manuals P. 628

Reporting Safety Defects P. 622

Client Service Information P. 629

Quick Reference Guide P. 6

Safe Driving P. 31

Instrument Panel P. 77

Controls P. 115

Features P. 201

Driving P. 365

Maintenance P. 517

Handling the Unexpected P. 567

Information P. 617

Index P. 630

# Visual Index

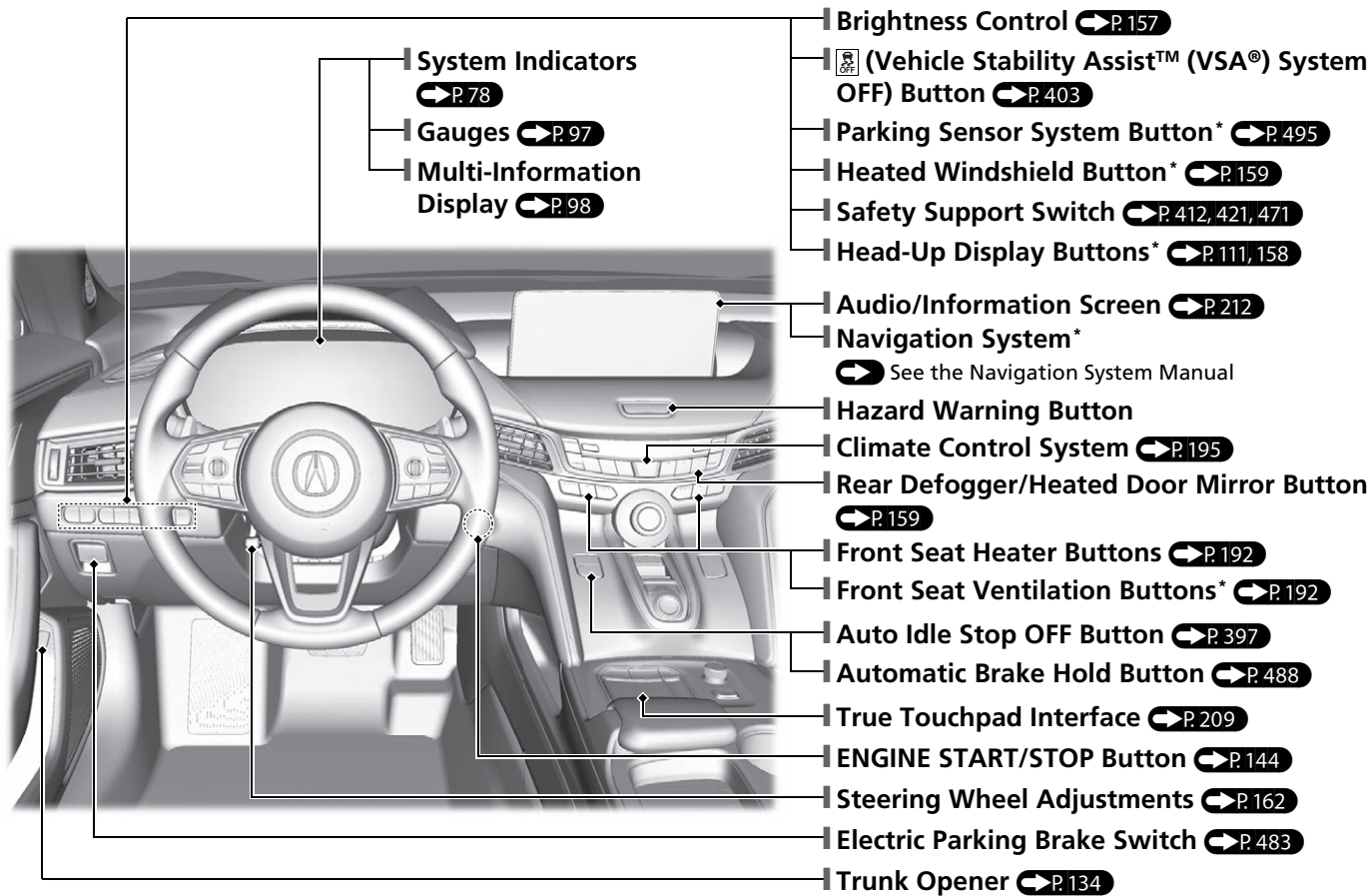



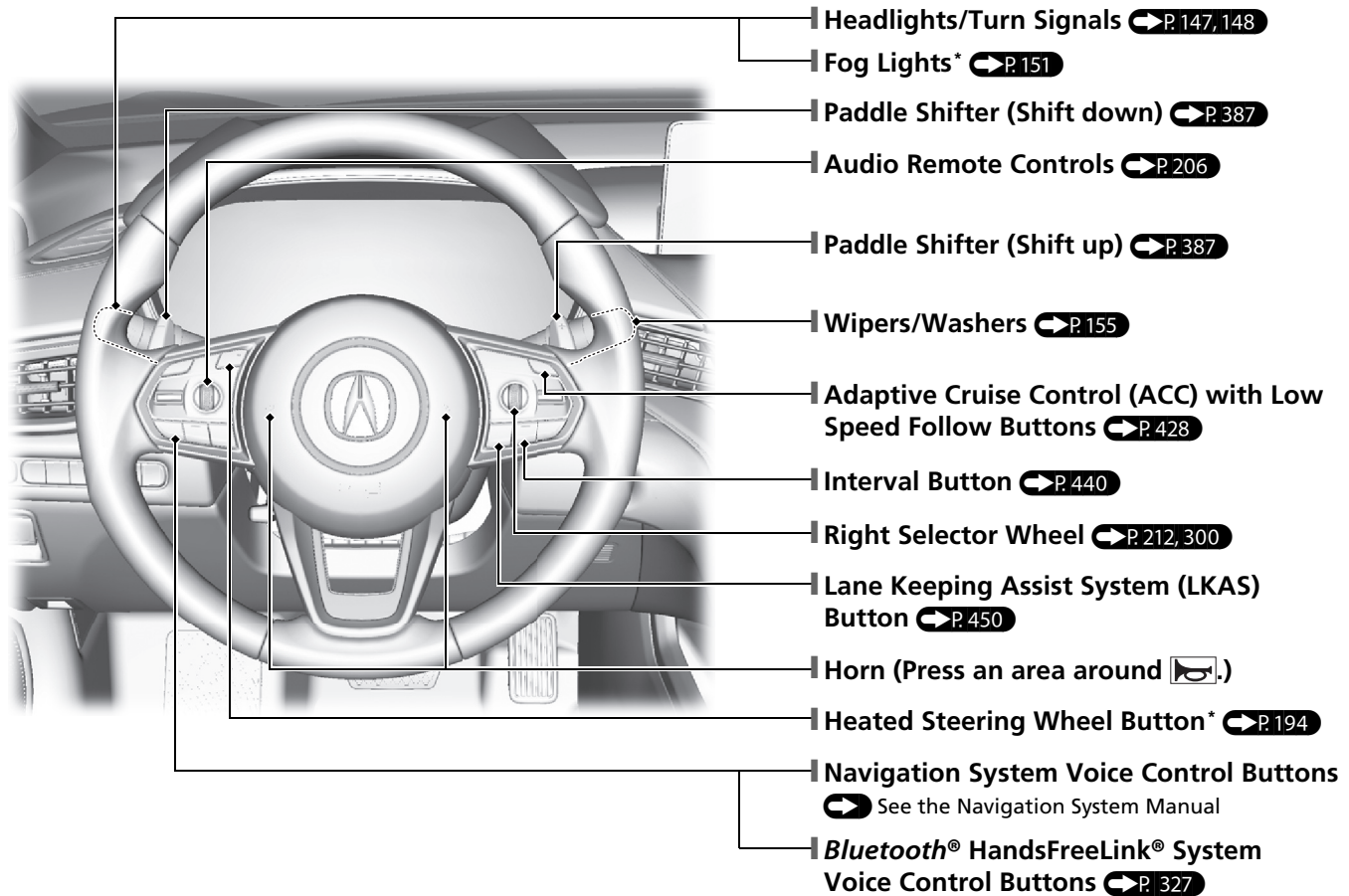

# Visual Index

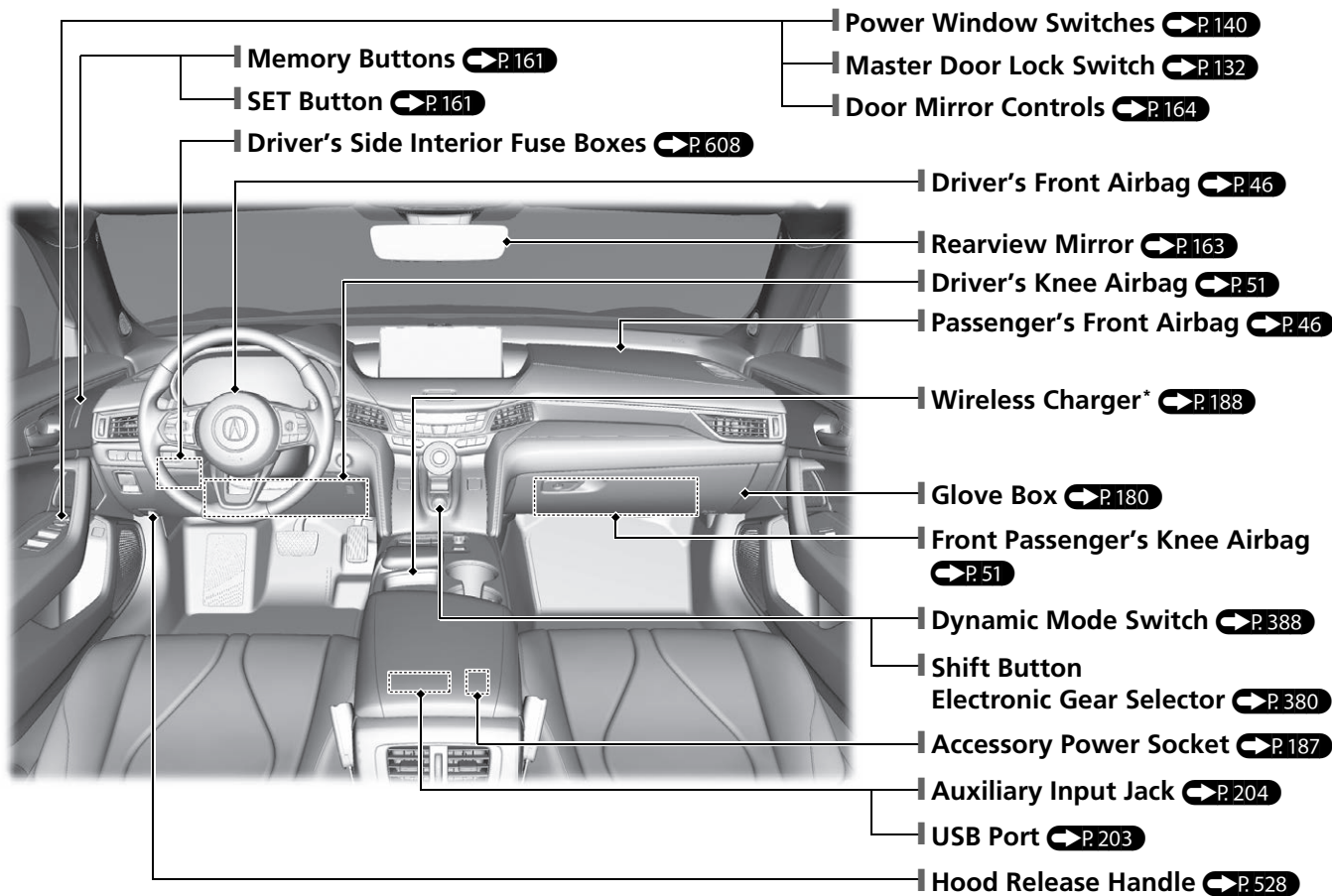

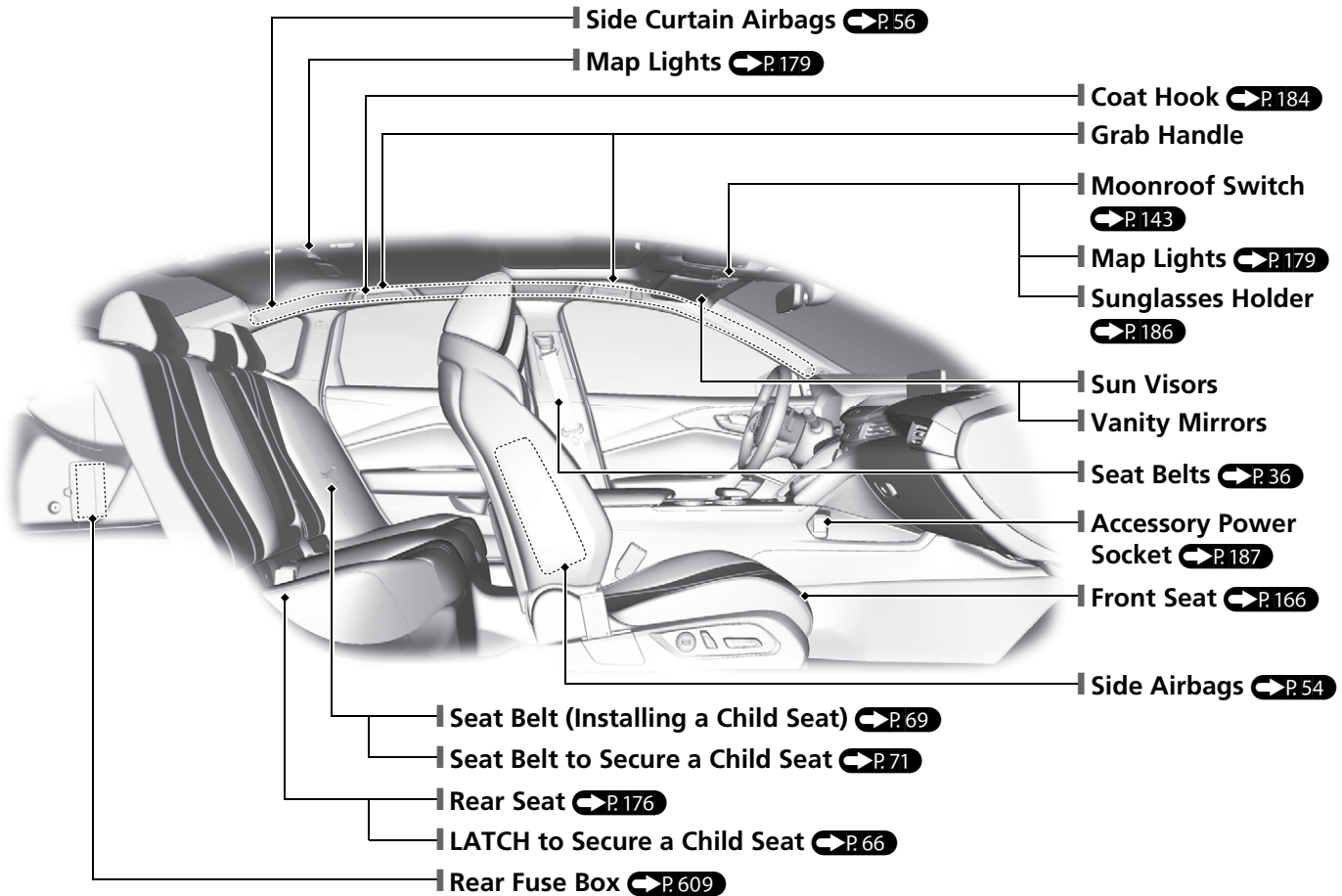



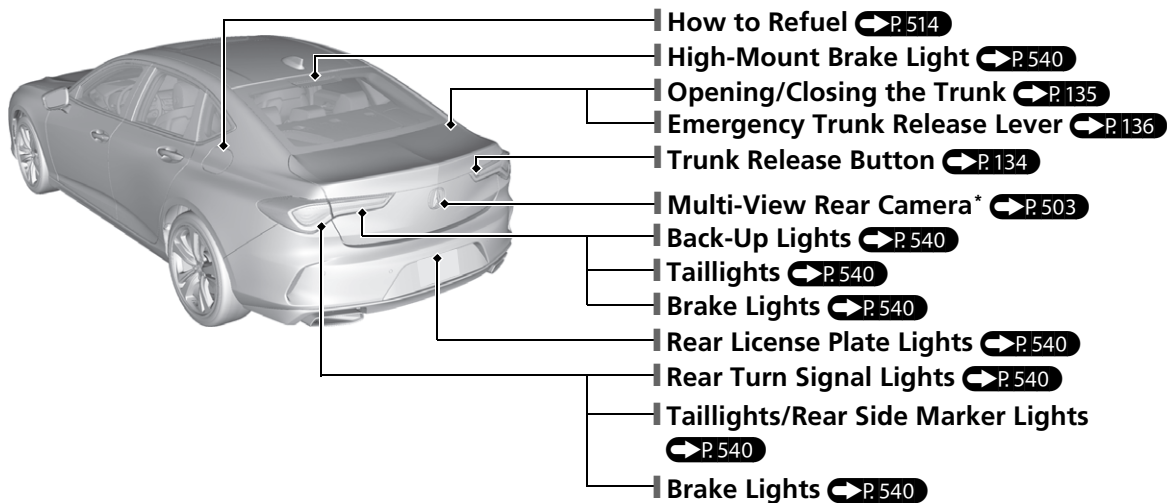
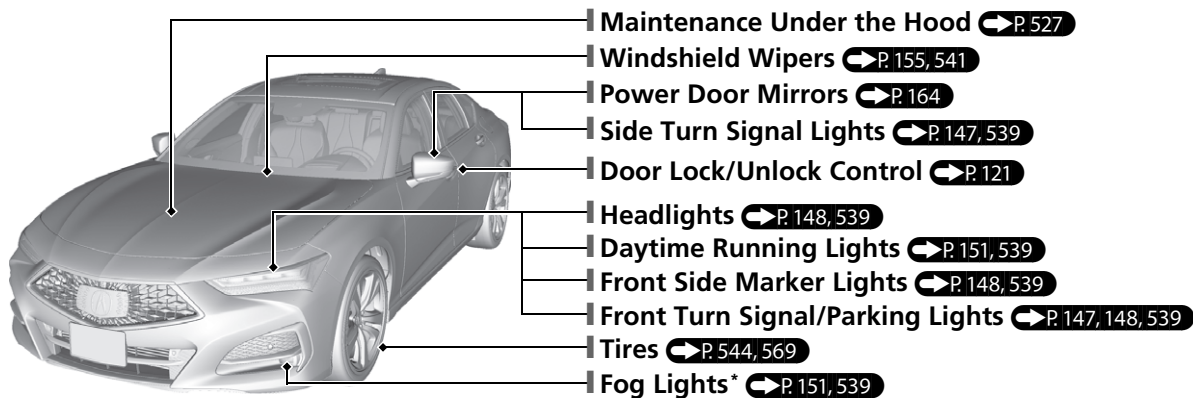



# Visual Index

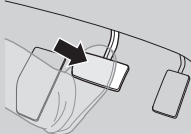

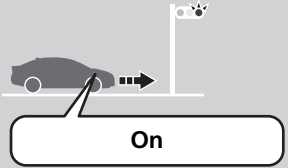
# Auto Idle Stop Function

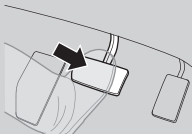
To improve fuel economy, the engine stops and then restarts as detailed below. When Auto Idle Stop is on, the Auto Idle Stop indicator (green) comes on. [➔ P. 395](#)

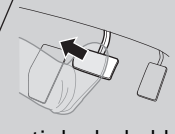
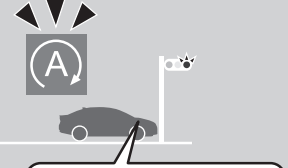
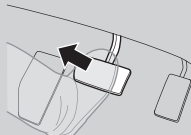
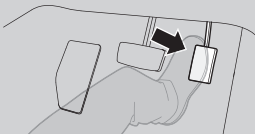
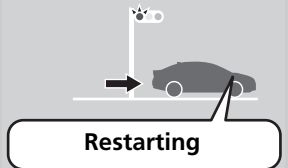
At	Automatic transmission	Engine status
<p>Deceleration</p> 	<div style="display: flex; justify-content: space-around;"> <div style="text-align: center;"> <p><b>Automatic Brake Hold Off</b></p>  </div> <div style="text-align: center;"> <p><b>Automatic Brake Hold On</b></p>  </div> </div> <p>Stop the vehicle and depress the brake pedal.</p>	 <p style="text-align: center;"><b>On</b></p>
<p>Stop</p> 	<div style="display: flex; justify-content: space-around;"> <div style="text-align: center;">  <p>Keep the brake pedal depressed.</p> </div> <div style="text-align: center;"> <p>U.S. Canada</p>  <p>With the automatic brake hold system activated, you can release the brake pedal when the (A) indicator comes on.</p> </div> <div style="text-align: center;">  </div> </div>	 <p style="text-align: center;"><b>Off</b></p>
<p>Start-up</p>	<div style="display: flex; justify-content: space-around;"> <div style="text-align: center;">  <p>Release the brake pedal.</p> </div> <div style="text-align: center;">  <p>With the automatic brake hold system activated, depress the accelerator pedal.</p> </div> </div>	 <p style="text-align: center;"><b>Restarting</b></p>

# Safe Driving P. 31

## Airbags P. 43

- Your vehicle is fitted with airbags to help protect you and your passengers during a moderate-to-severe collision.

## Child Safety P. 61

- All children 12 and younger should be seated in the rear seat.
- Smaller children should be properly restrained in a forward-facing child seat.
- Infants must be properly restrained in a rear-facing child seat.

## Exhaust Gas Hazard P. 75

- Your vehicle emits dangerous exhaust gases that contain carbon monoxide. Do not run the engine in confined spaces where carbon monoxide gas can accumulate.

## Seat Belts P. 36

- Fasten your seat belt and sit upright well back in the seat.
- Check that your passengers are wearing their seat belts correctly.

## Before Driving Checklist P. 35

- Before driving, check that the front seats, head restraints, steering wheel, and mirrors have been properly adjusted.

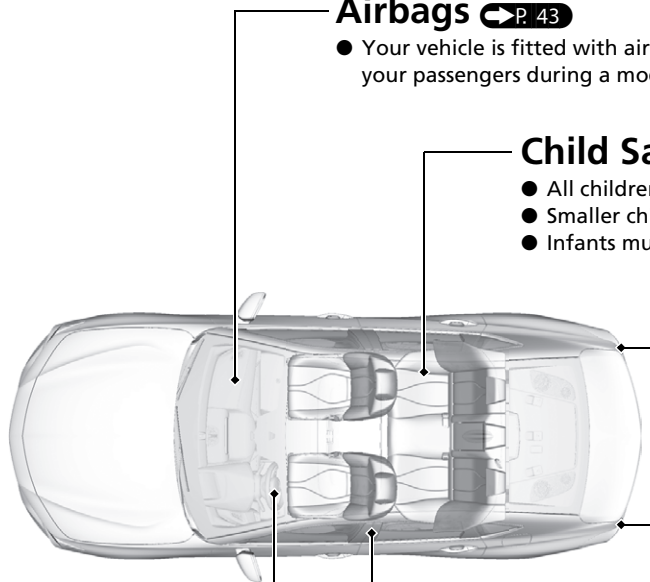

Fasten your lap belt as low as possible.

# Instrument Panel P. 77

Indicators  P. 78 / Multi-Information Display  P. 98 / Gauges  P. 97 /  
Head-Up Display\*  P. 111

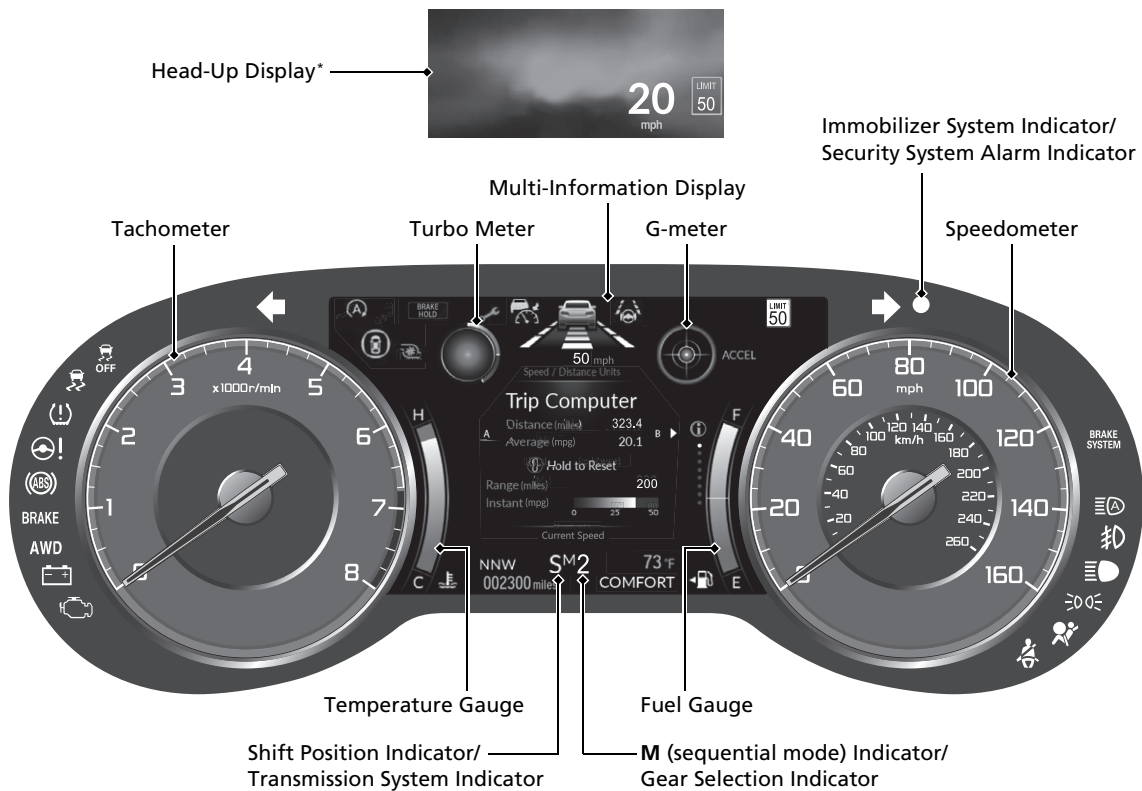

\* Not available on all models

# Controls P. 115

## Clock P. 116

The clock is automatically updated through the audio system.



## ENGINE START/STOP Button P. 144

Press the button to change the vehicle's power mode.

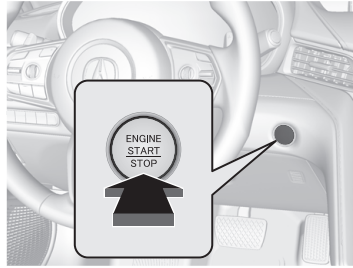

## Turn Signals P. 147

Turn Signal Control Lever

Right

Left

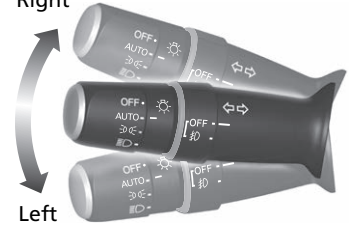

## Lights P. 148

Light Control Switches

High Beam

Low Beam

Flashing

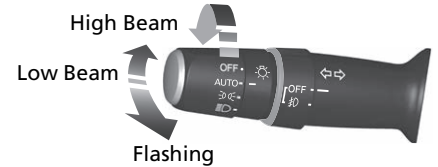



## Wipers and Washers

➔ P. 155

Wiper/Washer Control Lever

**MIST**

**OFF**

**AUTO**\*1: Wiper speed varies automatically

**INT**\*2: Low speed with intermittent

**LO**: Low speed wipe

**HI**: High speed wipe

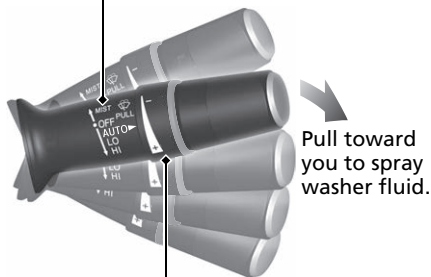

Pull toward you to spray washer fluid.

Adjustment Ring

☐: Low Sensitivity\*1

: Lower speed, fewer sweeps\*2

⊕: High Sensitivity\*1

: Higher speed, more sweeps\*2

\*1: Models with automatic intermittent wipers

\*2: Models without automatic intermittent wipers

Models with automatic intermittent wipers

**AUTO** should always be turned **OFF** before the following situations in order to prevent severe damage to the wiper system:

- Cleaning the windshield
- Driving through a car wash
- No rain present

## Steering Wheel ➔ P. 162

- To adjust, push the adjustment lever down, adjust to the desired position, then lock the lever back in place.

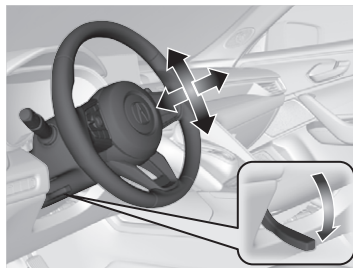

## Unlocking the Front Doors from the Inside

➔ P. 131

- Pull either front door inner handle to unlock and open it at the same time.

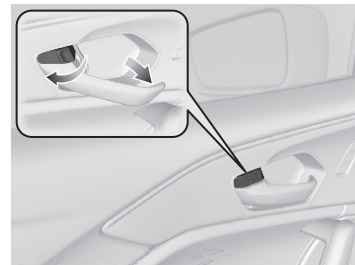

## Trunk P.134

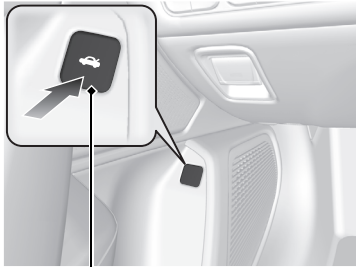

Trunk Opener

- Press and hold the trunk opener on the driver's door to unlock and open the trunk.
- Press the trunk release button on the right side trunk lid light to unlock and open the trunk.
- Press and hold the trunk release button on the remote to unlock and open the trunk.

## Power Door Mirrors

 P.164

- With the power mode in ON, move the selector switch to L or R.
- Push the appropriate edge of the adjustment switch to adjust the mirror.
- Press the folding button\* to fold the door mirrors in or out.

Folding Button\*      Selector Switch

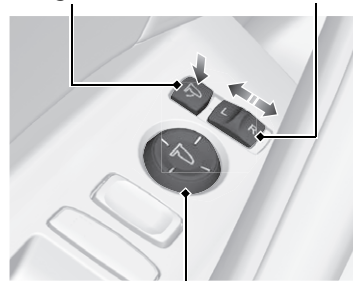

Adjustment Switch

## Power Windows P.140

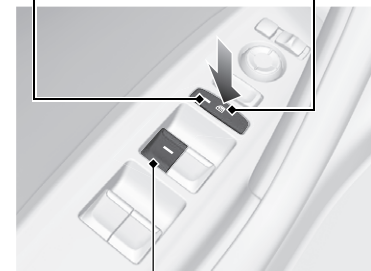

- With the power mode in ON, open and close the power windows.
- If the power window lock button is in the off position, each passenger's window can be opened and closed with its own switch.
- If the power window lock button is in the on position (indicator on), each passenger's window switch is disabled.

Indicator      Power Window Lock Button





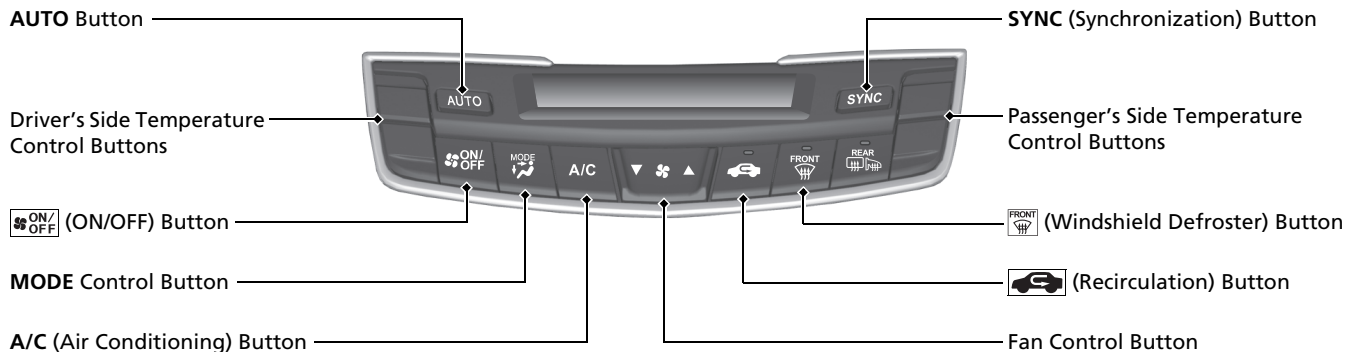

Window Switch

# Climate Control System P. 195

- Press the **AUTO** button to activate the climate control system.
- Press the  button to turn the system on or off.
- Press the  button to defrost the windshield.



-  Air flows from dashboard vents and back of the center console.
-  Air flows from floor and dashboard vents, and back of the center console.
-  Air flows from floor vents.
-  Air flows from floor and windshield defroster vents.

# Features P. 201

## Audio Remote Controls

 P. 206

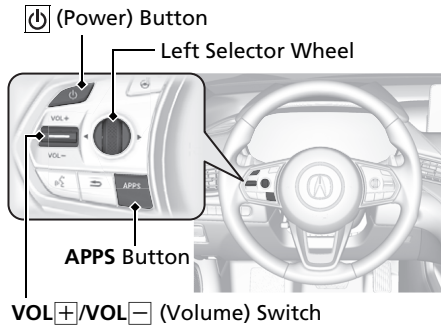

- **VOL+**/**VOL-** (Volume) Switch  
Press up or down to adjust the volume.
- **(Power) Button**  
Press to turn the audio system on and off.
- **Left Selector Wheel**  
When selecting the audio mode  
Press the **APPS** button, then roll up or down to select an item on the multi-information display or the head-up display\*, and then press the left selector wheel.

**Roll up or down:** To cycle through the following items, roll up or down and then press the left selector wheel:

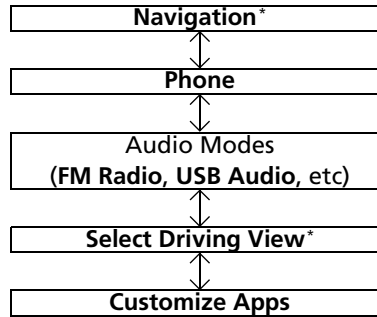

You can add or remove the items and change their order on multi-information display or the head-up display\*.

- **When listening to the radio**  
Move to a side to change the favorite radio station or channel.
- **When listening to an iPod, USB flash drive, Bluetooth® Audio, or Smartphone Connection**  
Move to a side to skip to the beginning of the next song or return to the beginning of the current or previous song.

# Audio System P. 208

For navigation system operation  See the Navigation System Manual



Audio/Information Screen

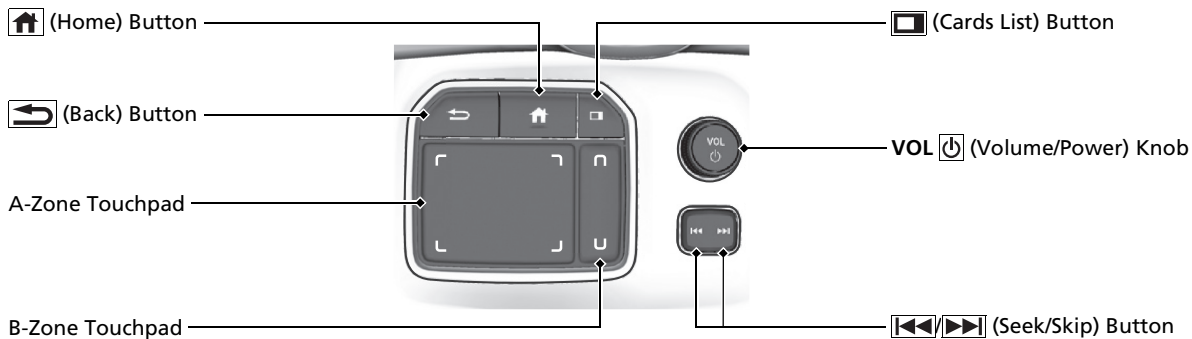

\* Not available on all models

# Driving P. 365

## Automatic Transmission P. 380

- Select **P** and depress the brake pedal when starting the engine.

### Shifting

#### Gear Position Indicator

The gear position indicator and the shift button indicator indicate the current gear selection.



Gear Position Indicator

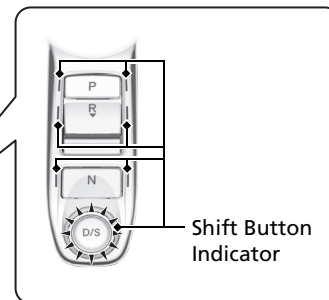
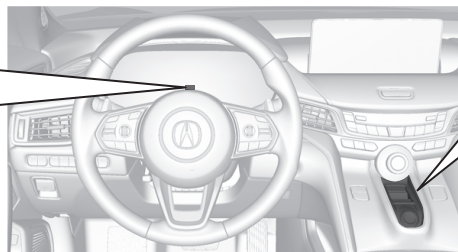

**P**

#### Park

Press the **P** button.  
Used when parking, before turning off or starting the engine.  
Transmission is locked.

**R**

#### Reverse

Pull back the **R** button.  
Used when reversing.

**N**

#### Neutral

Press the **N** button.  
Transmission is not locked.

**D/S**

#### Drive/S Position

Each time you press the **D/S** button, the mode switches between Drive and S Position mode.

##### Drive

- Normal driving (gears change between 1st and 10th automatically)
- Temporarily driving in the sequential mode

##### S Position

- Automatically changing gears between 1st and 8th (8th gear is used only at high speed)
- Driving in the sequential mode

## Sequential Mode P. 387

Paddle shifters allow you to shift gears much like a manual transmission (1st through 10th). This is useful for engine braking.

Gear Position Indicator

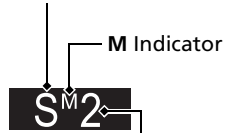

Selected Gear Number

### When the transmission is in **[D]**

- The transmission will shift back to automatic mode once the system detects that the vehicle is cruising.

### When the transmission is in **[S]**

- Holds the selected gear, and the M (sequential mode) indicator comes on.
- The sequential mode gear selection is shown in the instrument panel.

Shift Down   
Paddle Shifter



Shift Up   
Paddle Shifter

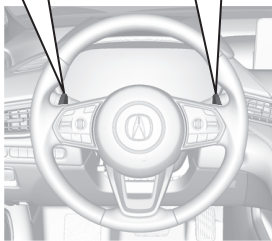

## CMBS™ On and Off

➔ P.421

- When a possible frontal collision is likely unavoidable, the CMBS™ can help you to reduce the vehicle speed and the severity of the collision.
- The CMBS™ is turned on every time you start the engine.
- To turn the CMBS™ on or off, use the safety support switch.

## VSA® On and Off ➔ P.403

- The Vehicle Stability Assist™ (VSA®) system helps stabilize the vehicle during cornering, and helps maintain traction while accelerating on loose or slippery road surfaces.
- VSA® comes on automatically every time you start the engine.
- To partially disable or fully restore VSA® function, press and hold the button until you hear a beep.

## Tire Pressure Monitoring System (TPMS) with Tire Fill Assist ➔ P.406, 603

- The TPMS monitors tire pressure.
- TPMS is turned on automatically every time you start the engine.
- TPMS fill assist provides audible and visual guidance during tire pressure adjustment.

## Refueling ➔ P.513

**Fuel recommendation: Unleaded premium gasoline, pump octane number 91 or higher**

**Fuel tank capacity: 15.9 US gal (60 L)**

- 1 Unlock the driver's door.  
 ➔ Locking/Unlocking the Doors from the Inside ➔ P.130
- 2 Press on the edge of the fuel fill door to make it pop up slightly.
- 3 After refueling, wait for about five seconds before removing the filler nozzle.

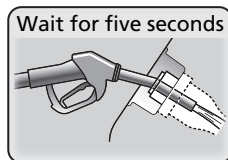



# AcuraWatch™

➔ P. 413

AcuraWatch™ is a driver support system which employs the use of two distinctly different kinds of sensors, a radar sensor located behind the emblem and a front sensor camera mounted to the interior side of the windshield, behind the rearview mirror.

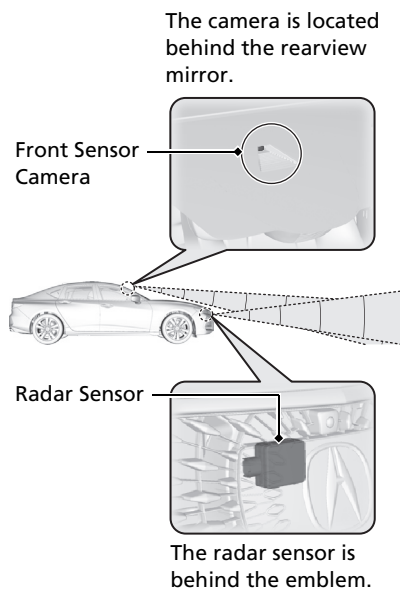

## Collision Mitigation Braking System™ (CMBS™)

➔ P. 417

Can assist you when there is a possibility of your vehicle colliding with a vehicle or a pedestrian detected in front of yours. The CMBS™ is designed to alert you when the potential for a collision is determined, as well as to reduce your vehicle speed to help minimize collision severity when a collision is deemed unavoidable.

## Adaptive Cruise Control (ACC) with Low Speed Follow

➔ P. 428

Helps maintain a constant vehicle speed and a set following-interval behind a vehicle detected ahead of yours and, if the detected vehicle comes to a stop, can decelerate and stop your vehicle, without you having to keep your foot on the brake or the accelerator.

## Lane Keeping Assist System (LKAS)

➔ P. 448

Provides steering input to help keep the vehicle in the middle of a detected lane and provides tactile and visual alerts if the vehicle is detected drifting out of its lane.

## Traffic Jam Assist

➔ P. 457

The traffic jam assist system uses a radar sensor mounted inside the front grille and a camera mounted to the upper portion of the windshield to detect and monitor left and right white (yellow) traffic lane lines as well as any vehicle ahead. Based on inputs from the radar sensor and camera, the system adjusts the speed of your vehicle to maintain a set interval between your vehicle and the one detected ahead. It also applies steering torque to keep your vehicle in the center of the detected lane when you are driving in heavy traffic.

## Road Departure Mitigation (RDM) System

➔ P. 469

Alerts and helps to assist you when the system detects a possibility of your vehicle unintentionally crossing over detected lane markings and/or leaving the roadway altogether.

## Traffic Sign Recognition System ➔ P. 474

Reminds you of road sign information, such as the current speed limit, your vehicle has just passed through, showing it on the multi-information display and the head-up display\*.

# Maintenance [↔ P.517](#)

## Under the Hood [↔ P.527](#)

- Check engine oil, engine coolant, and windshield washer fluid. Add when necessary.
- Check brake fluid.

- 1** Pull the hood release handle under the corner of the dashboard.



- 2** Locate the hood latch lever, push it to the side, and then raise the hood. Once you have raised the hood slightly, you can release the lever.



- 3** When finished, close the hood and make sure it is firmly locked in place.

## Wiper Blades [↔ P.541](#)

- Replace blades if they leave streaks across the windshield or become noisy.

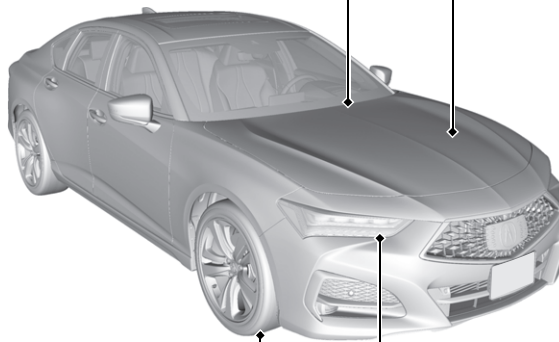

## Tires [↔ P.544](#)

- Inspect tires and wheels regularly.
- Check tire pressures regularly.
- Install snow tires for winter driving.

## Lights [↔ P.539](#)

- Inspect all lights regularly.

# Handling the Unexpected P.567

## Flat Tire P.569

- **Models with tire repair kit**

Park in a safe location and repair the flat tire using the temporary tire repair kit.

- **Models with optional spare tire**

Park in a safe location and replace the flat tire with the compact spare tire in the trunk.



## Indicators Come On

-  P.597

- Identify the indicator and consult the owner's manual.

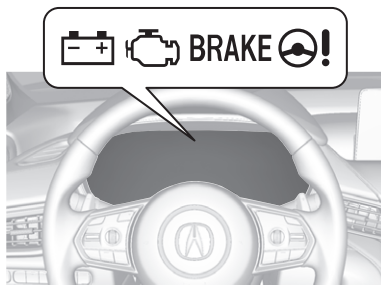

## Engine Won't Start P.590

- If the battery is dead, jump start using a booster battery.

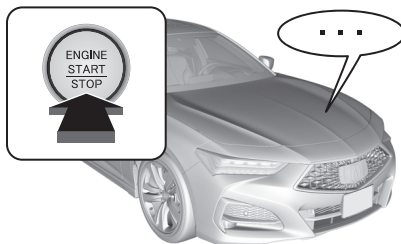

## Blown Fuse P.605

- Check for a blown fuse if an electrical device does not operate.

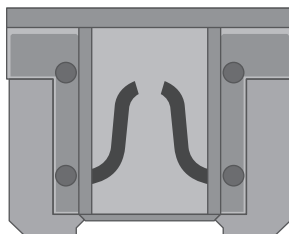

## Overheating P.595

- Park in a safe location. If you do not see steam under the hood, open the hood, and let the engine cool down.



## Emergency Towing P.612

- Call a professional towing service if you need to tow your vehicle.

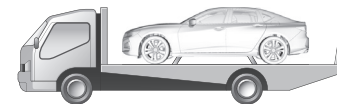

# What to Do If

**Q** Why does the brake pedal pulsate slightly when applying the brakes?

**A** This can occur when the ABS activates and does not indicate a problem. Apply firm, steady pressure on the brake pedal. Never pump the brake pedal.

➤ Anti-lock Brake System (ABS) ➔ P. 490

**Q** The rear door cannot be opened from inside the vehicle. Why?

**A** Check if the childproof lock is in the lock position. If so, open the rear door with the outside door handle.

To cancel this function, slide the lever up to the unlock position.

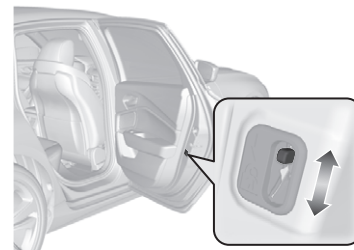

**Q** Why do the doors lock after I unlocked the doors?

**A** If you do not open the doors within 30 seconds, the doors are relocked automatically for security.

**Q** Why does the beeper sound when I open the driver's door?

**A** The beeper sounds when:

- The power mode is in ACCESSORY.
- The exterior lights are left on.
- The Auto Idle Stop is in operation.

**Q** Why does a beeper sound when I walk away from the vehicle after I close the door?

**A** The beeper sounds if you move outside the walk away auto lock operating range before the door completely closes.  
➤ Locking the doors and trunk (Walk away auto lock®) ➔ P.124

**Q** Why does the beeper sound when I start driving?

**A** The beeper sounds when the driver and/or front passenger are not wearing their seat belts.

**Q** Pulling the electric parking brake switch does not release the parking brake. Why?

**A** Pull the electric parking brake switch with the brake pedal depressed.

**Q** I'm seeing an amber indicator of a tire with an exclamation point. What is that?

**A** The Tire Pressure Monitoring System (TPMS) needs attention. Check tire pressure.  
➤ If the Low Tire Pressure/TPMS Indicator Comes On or Blinks ➔ P.603

**Q** Depressing the accelerator pedal does not release the parking brake automatically. Why?

**A**

- Fasten the driver's seat belt.
- Check if the transmission is in **P** or **N**. If so, select any other position.

---

**Q** Why does the gear position automatically change to **P** when I open the driver's door to check for parking space lines when reversing?

- A**
- Fasten the driver's seat belt.
  - Close the driver's door and manually change the gear position.
- ▶ When opening the driver's door **➔ P. 383**

---

**Q** Why do I hear a screeching sound when I apply the brake pedal?

- A** The brake pads may need to be replaced. Have your vehicle inspected by a dealer.

---

**Q** Unleaded gasoline with a Pump Octane Number (PON) of 91 or higher is recommended. Is it possible to use unleaded gasoline with a Pump Octane Number (PON) of 87 or lower on this vehicle?

- A** Use of a lower octane gasoline can cause occasional metallic knocking noise in the engine and will result in decreased engine performance. Use of a gasoline with a pump octane less than 87 can lead to engine damage.
-





# Safe Driving

You can find many safety recommendations throughout this chapter, and throughout this manual.

## **For Safe Driving**

Important Safety Precautions.....	32
Your Vehicle's Safety Features.....	34
Safety Checklist .....	35

## **Seat Belts**

About Your Seat Belts.....	36
Fastening a Seat Belt.....	39
Seat Belt Inspection.....	42

## **Airbags**

Airbag System Components.....	43
Types of Airbags.....	46
Front Airbags (SRS) .....	46

Knee Airbags.....	51
Side Airbags.....	54
Side Curtain Airbags.....	56
Airbag System Indicators.....	57
Airbag Care .....	60

## **Child Safety**

Protecting Child Passengers .....	61
Safety of Infants and Small Children...	63
Safety of Larger Children .....	73

## **Exhaust Gas Hazard**

Carbon Monoxide Gas.....	75
--------------------------	----

## **Safety Labels**

Label Locations .....	76
-----------------------	----

The following pages explain your vehicle's safety features and how to use them properly. The safety precautions below are ones that we consider to be among the most important.

## Important Safety Precautions

### ■ Always wear your seat belt

A seat belt is your best protection in all types of collisions. Airbags are designed to supplement seat belts, not replace them. So even though your vehicle is equipped with airbags, make sure you and your passengers always wear your seat belts, and wear them properly.

### ■ Restrain all children

Children ages 12 and under should ride properly restrained in a back seat, not the front seat. Infants and small children should be restrained in a child seat. Larger children should use a booster seat and a lap/shoulder seat belt until they can use the belt properly without a booster seat.

### ■ Be aware of airbag hazards

While airbags can save lives, they can cause serious or fatal injuries to occupants who sit too close to them, or are not properly restrained. Infants, young children, and short adults are at the greatest risk. Be sure to follow all instructions and warnings in this manual.

### ■ Don't drink and drive

Alcohol and driving don't mix. Even one drink can reduce your ability to respond to changing conditions, and your reaction time gets worse with every additional drink. So don't drink and drive, and don't let your friends drink and drive, either.

### ▣ Important Safety Precautions

Some states, provinces and territories prohibit the use of cell phones other than hands-free devices by the driver while driving.

**■ Pay appropriate attention to the task of driving safely**

Engaging in cell phone conversation or other activities that keep you from paying close attention to the road, other vehicles, and pedestrians could lead to a crash. Remember, situations can change quickly, and only you can decide when it is safe to divert some attention away from driving.

**■ Control your speed**

Excessive speed is a major factor in crash injuries and deaths. Generally, the higher the speed, the greater the risk, but serious injuries can also occur at lower speeds. Never drive faster than is safe for current conditions, regardless of the maximum speed posted.

**■ Keep your vehicle in safe condition**

Having a tire blowout or a mechanical failure can be extremely hazardous. To reduce the possibility of such problems, check your tire pressures and condition frequently, and perform all regularly scheduled maintenance.

**■ Do not leave children unattended in the vehicle**

Children, pets and people needing assistance left unattended in the vehicle may be injured if they activate one or more of the vehicle controls. They may also cause the vehicle to move, resulting in a crash in which they and/or another person(s) can be injured or killed. Also, depending on the ambient temperature, the temperature of the interior may reach extreme levels, which can result in harm or death. Even if the climate control system is on, never leave them in the vehicle unattended as the climate control system can shut off at any time.

## Your Vehicle's Safety Features

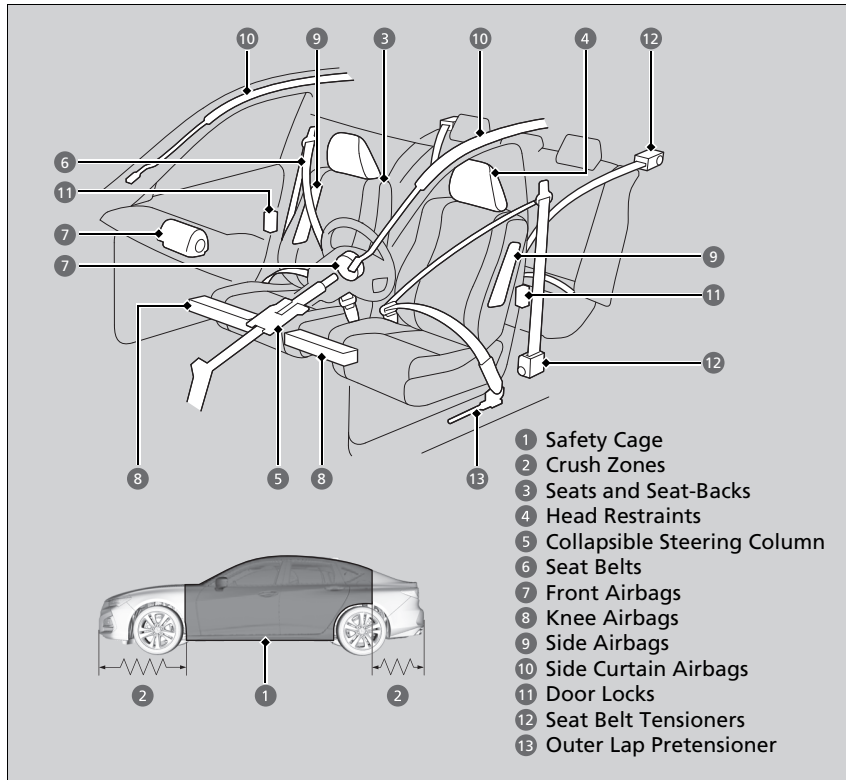

The following checklist will help you take an active role in protecting yourself and your passengers.

### ►► Your Vehicle's Safety Features

Your vehicle is equipped with many features that work together to help protect you and your passengers during a crash.

Some features do not require any action on your part. These include a strong steel framework that forms a safety cage around the passenger compartment, front and rear crush zones, a collapsible steering column, and tensioners that tighten the front and outer rear seat belts in a sufficient crash.

However, you and your passengers cannot take full advantage of these features unless you remain seated in the correct position and always wear your seat belts. In fact, some safety features can contribute to injuries if they are not used properly.

## Safety Checklist

For the safety of you and your passengers, make a habit of checking these items each time before you drive.

- After everyone has entered the vehicle, be sure all doors are closed and locked. Locking the doors helps prevent an occupant from being ejected and an outsider from unexpectedly opening a door.
  - **Locking/Unlocking the Doors from the Inside** P. 130
- Adjust your seat to a position suitable for driving. Be sure the front seats are adjusted as far to the rear as possible while allowing the driver to control the vehicle. Sitting too close to a front airbag can result in serious or fatal injury in a crash.
  - **Seats** P. 166
- Adjust head restraints to the proper position. Head restraints are most effective when the center of the head restraint aligns with the center of your head. Taller persons should adjust their head restraint to the highest position.
  - **Adjusting the Head Restraint Positions** P. 172
- Always wear your seat belt, and make sure you wear it properly. Confirm that any passengers are properly belted as well.
  - **Fastening a Seat Belt** P. 39
- Protect children by using seat belts or child seats according to a child's age, height and weight.
  - **Child Safety** P. 61

### ☒ Safety Checklist

If the door and/or trunk open message appears on the multi-information display (MID), a door and/or the trunk is not completely closed. Close all doors and the trunk tightly until the message disappears.

➤ **Warning** P. 103

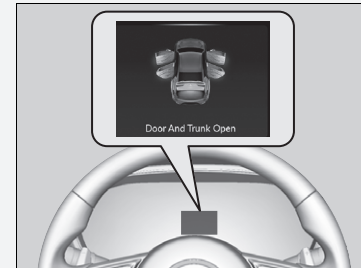

## About Your Seat Belts

Seat belts are the single most effective safety device because they keep you connected to the vehicle so that you can take advantage of many built-in safety features. They also help keep you from being thrown against the inside of the vehicle, against any passengers, or out of the vehicle. When worn properly, seat belts also keep your body properly positioned in a crash so that you can take full advantage of the additional protection provided by the airbags.

In addition, seat belts help protect you in almost every type of crash, including:

- frontal impacts
- side impacts
- rear impacts
- rollovers

### ■ Lap/shoulder seat belts

All five seating positions are equipped with lap/shoulder seat belts with emergency locking retractors. In normal driving the retractor lets you move freely while keeping some tension on the belt. During a collision or sudden stop the retractor locks to restrain your body.

The front passenger's and rear seat belts also have a lockable retractor for use with child seats.

➤ **Installing a Child Seat with a Lap/Shoulder Seat Belt** P. 69

### ➤ About Your Seat Belts

## **WARNING**

**Not wearing a seat belt properly increases the chance of serious injury or death in a crash, even though your vehicle has airbags.**

**Be sure you and your passengers always wear seat belts and wear them properly.**

If you extend the seat belt too quickly, it will lock in place. If this happens, slightly retract the seat belt, then extend it slowly.

Seat belts cannot completely protect you in every crash. But in most cases, seat belts can reduce your risk of serious injury.

Most states and all Canadian provinces and territories require you to wear seat belts.

## ■ Proper use of seat belts

Follow these guidelines for proper use:

- All occupants should sit upright, well back in the seat, and remain in that position for the duration of the trip. Slouching and leaning reduce the effectiveness of the belt and can increase the chance of serious injury in a crash.
- Never place the shoulder part of a lap/shoulder seat belt under your arm or behind your back. This could cause very serious injuries in a crash.
- Two people should never use the same seat belt. If they do, they could be very seriously injured in a crash.
- Do not put any accessories on the seat belts. Devices intended to improve comfort or reposition the shoulder part of a seat belt can reduce the protective capability and increase the chance of serious injury in a crash.

## ■ Seat Belt Reminder

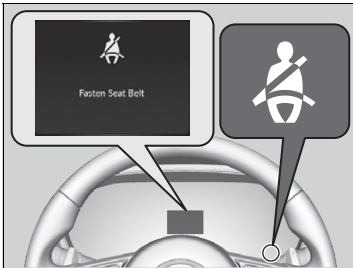

The seat belt system includes an indicator on the instrument panel to remind the driver or a front passenger or both to fasten their seat belts.

If you set the power mode to ON and a seat belt is not fastened, a beeper will sound and the indicator will blink. After a few seconds, the beeper will stop and the indicator will come on and remain illuminated until the seat belt is fastened.

The beeper will periodically sound and the indicator will blink while the vehicle is moving until the seat belt is fastened.

### ⌘ About Your Seat Belts

If a passenger moves around and extends the seat belt, the lockable retractor may activate. If this happens, release the retractor by unfastening the seat belt and allow the belt to retract completely. Then refasten the belt.

### ⌘ Seat Belt Reminder

The indicator will also come on if a front passenger does not fasten their seat belt within six seconds after the power mode is set to ON.

When no one is sitting in the front passenger's seat, the indicator will not come on and the beeper will not sound.

The indicator also may not come on and the beeper may not sound when the occupant is not heavy enough to trigger the weight sensor. Such occupants (e.g., infants and smaller children) should be moved to the rear seat as a deploying front airbag likely will injure or kill them.

➤ **Protecting Child Passengers** P. 61

## Automatic Seat Belt Tensioners

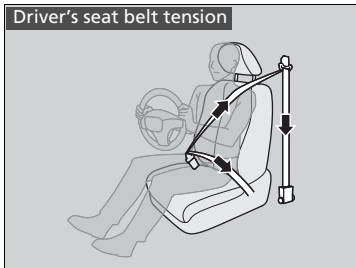

The front seats and the outer rear seats are equipped with automatic seat belt tensioners to enhance safety.

The tensioners automatically tighten the front seat belts and the outer rear seat belts during a moderate-to-severe frontal collision, sometimes even if the collision is not severe enough to inflate the front airbags or the driver's and passenger's knee airbags.

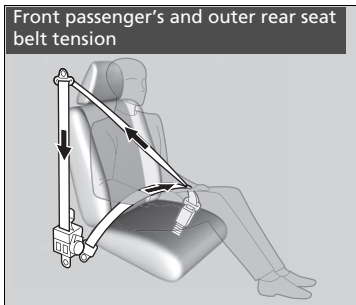

### Automatic Seat Belt Tensioners

The seat belt tensioners can only operate once. If a tensioner is activated, the SRS indicator will come on. Have a dealer replace the tensioner and thoroughly inspect the seat belt system as it may not offer protection in a subsequent crash.

During a moderate-to-severe side impact, the tensioners on both sides of the vehicle activate.



## Fastening a Seat Belt

After adjusting a front seat to the proper position, and while sitting upright and well back in the seat:

➤ **Seats** P. 166

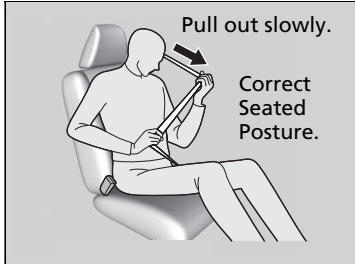

1. Pull the seat belt out slowly.

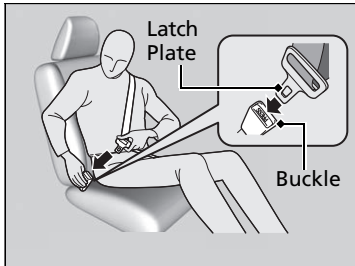

2. Insert the latch plate into the buckle, then tug on the belt to make sure the buckle is secure.

▶ Make sure that the belt is not twisted or caught on anything.

### Fastening a Seat Belt

No one should sit in a seat with an inoperative seat belt or one that does not appear to be working correctly. Using a seat belt that is not working properly may not protect the occupant in a crash. Have a dealer check the belt as soon as possible.

If the seat belt appears to be locked in a fully retracted position, firmly pull out on the shoulder belt once, then push it back in.

Then smoothly pull it out of the retractor and fasten. If you are unable to release the seat belt from a fully retracted position, do not allow anyone to sit in the seat, and take your vehicle to a dealer for repair.

➤ **About Your Seat Belts** P. 36

➤ **Seat Belt Inspection** P. 42

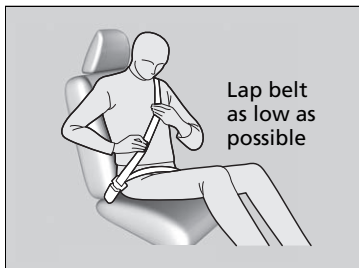

3. Position the lap part of the belt as low as possible across your hips, then pull up on the shoulder part of the belt so the lap part fits snugly. This lets your strong pelvic bones take the force of a crash and reduces the chance of internal injuries.
4. If necessary, pull up on the belt again to remove any slack, then check that the belt rests across the center of your chest and over your shoulder. This spreads the forces of a crash over the strongest bones in your upper body.

▶▶ Fastening a Seat Belt

**⚠ WARNING**

Improperly positioning the seat belts can cause serious injury or death in a crash.

**Make sure all seat belts are properly positioned before driving.**

To release the belt, push the red **PRESS** button and then guide the belt by hand until it has retracted completely.

When exiting the vehicle, be sure the belt is properly stowed so that it will not get caught in the closing door.

Never insert any foreign objects into the buckle or retractor mechanism.

▶▶ Adjusting the Shoulder Anchor

The shoulder anchor height can be adjusted to four levels. If the belt contacts your neck, lower the height one level at a time.

After an adjustment, make sure that the shoulder anchor position is secure.

**■ Adjusting the Shoulder Anchor**

The front seats have adjustable shoulder anchors to accommodate taller and shorter occupants.

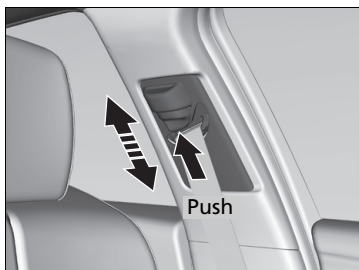

1. Move the anchor up and down while holding the release button.
2. Position the anchor so that the belt rests across the center of your chest and over your shoulder.

## Advice for Pregnant Women

If you are pregnant, the best way to protect yourself and your unborn child when driving or riding in a vehicle is to always wear a seat belt and keep the lap part of the belt as low as possible across the hips.

Wear the shoulder belt across the chest avoiding the abdomen.



Wear the lap part of the belt as low as possible across the hips.

## Advice for Pregnant Women

Each time you have a checkup, ask your doctor if it is okay for you to drive.

To reduce the risk of injuries to both you and your unborn child that can be caused by an inflating front airbag:

- When driving, sit upright and adjust the seat as far back as possible while allowing full control of the vehicle.
- When sitting in the front passenger's seat, adjust the seat as far back as possible.

## Seat Belt Inspection

Regularly check the condition of your seat belts as follows:

- Pull each belt out fully, and look for frays, cuts, burns, and wear.
- Check that the latch plates and buckles work smoothly and the belts retract easily.
  - ▶ If a belt does not retract easily, cleaning the belt may correct the problem. Only use a mild soap and warm water. Do not use bleach or cleaning solvents. Make sure the belt is completely dry before allowing it to retract.

Any belt that is not in good condition or working properly will not provide proper protection and should be replaced as soon as possible.

A belt that has been worn during a crash may not provide the same level of protection in a subsequent crash. Have your seat belts inspected by a dealer after any collision.

### ▶▶ Seat Belt Inspection

#### **WARNING**

Not checking or maintaining seat belts can result in serious injury or death if the seat belts do not work properly when needed.

Check your seat belts regularly and have any problem corrected as soon as possible.

## Airbag System Components

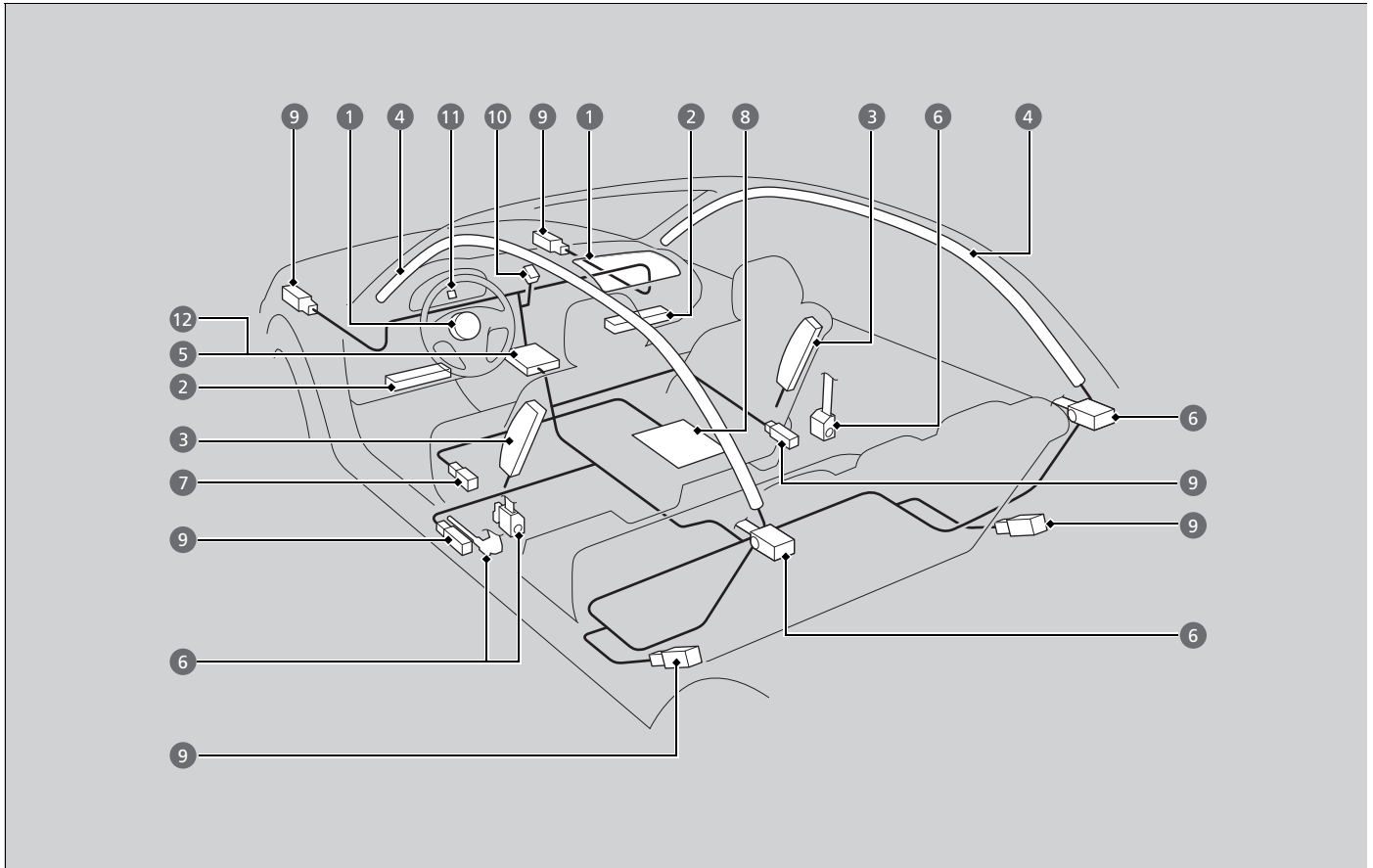

The front, driver's knee, front passenger's knee, front side, and side curtain airbags are deployed according to the direction and severity of impact. Both side curtain airbags are deployed in a rollover. The airbag system includes:

- 1 Two SRS (Supplemental Restraint System) front airbags. The driver's airbag is stored in the center of the steering wheel; the front passenger's airbag is stored in the dashboard. Both are marked **SRS AIRBAG**.
- 2 Two knee airbags. The driver's knee airbag is stored under the steering column; the front passenger's knee airbag is stored under the glove box. Both are marked **SRS AIRBAG**.
- 3 Two side airbags, one for the driver and one for a front passenger. The airbags are stored in the outer edges of the seat-backs. Both are marked **SIDE AIRBAG**.
- 4 Two side curtain airbags, one for each side of the vehicle. The airbags are stored in the ceiling, above the side windows. The front and rear pillars are marked **SIDE CURTAIN AIRBAG**.
- 5 An electronic control unit that, when the power mode is in ON, continually monitors information about the various impact sensors, seat and buckle sensors, rollover sensor, airbag activators, seat belt tensioners, and other vehicle information. During a crash event the unit can record such information.
- 6 Seat belt tensioners for the front seats and outer rear seats. In addition, the driver's and front passenger's seat belt buckles incorporate sensors that detect whether or not the belts are fastened.
- 7 Driver's seat position sensor. This sensor detects the driver's seat slide position to help determine the optimal deployment of the driver's airbag.
- 8 Weight sensors in the front passenger's seat. The sensors are used for occupant classification to activate or deactivate the front passenger's airbag.
- 9 Impact sensors that can detect a moderate-to-severe front or side impact.
- 10 An indicator on the dashboard that alerts you that the front passenger's front airbag has been turned off.
- 11 An indicator on the instrument panel that alerts you to a possible problem with your airbag system or seat belt tensioners.
- 12 A rollover sensor that can detect if your vehicle is about to roll over and signal the control unit to deploy both side curtain airbags.

## ■ Important Facts About Your Airbags

Airbags can pose serious hazards. To do their job, airbags must inflate with tremendous force. So, while airbags help save lives, they can cause burns, bruises, and other minor injuries, sometimes even fatal ones if occupants are not wearing their seat belts properly and sitting correctly.

**What you should do:** Always wear your seat belt properly, and sit upright and as far back from the steering wheel as possible while allowing full control of the vehicle. A front passenger should move their seat as far back from the dashboard as possible.

Remember, however, that no safety system can prevent all injuries or deaths that can occur in a severe crash, even when seat belts are properly worn and the airbags deploy.

**Do not place hard or sharp objects between yourself and a front airbag.**

Carrying hard or sharp objects on your lap, or driving with a pipe or other sharp object in your mouth, can result in injuries if your front airbag inflates.

**Do not attach or place objects on the front, driver's knee and front passenger's knee airbag covers.** Objects on the covers marked **SRS AIRBAG** could interfere with the proper operation of the airbags or be propelled inside the vehicle and hurt someone if the airbags inflate.

## ▣ Important Facts About Your Airbags

Do not attempt to deactivate your airbags. Together, airbags and seat belts provide the best protection.

When driving, keep hands and arms out of the deployment path of the front airbag by holding each side of the steering wheel. Do not cross an arm over the airbag cover.

## Types of Airbags

Your vehicle is equipped with four types of airbags:

- **Front airbags:** Airbags in front of the driver's and front passenger's seats.
- **Knee airbags:** Airbags under the steering column and under the glove box.
- **Side airbags:** Airbags in the driver's and front passenger's seat-backs.
- **Side curtain airbags:** Airbags above the side windows.

Each is discussed in the following pages.

## Front Airbags (SRS)

The front SRS airbags inflate in a moderate-to-severe frontal collision to help protect the head and chest of the driver and/or front passenger.

**SRS** (Supplemental Restraint System) indicates that the airbags are designed to supplement seat belts, not replace them. Seat belts are the occupant's primary restraint system.

### Housing Locations

The front airbags are housed in the center of the steering wheel for the driver, and in the dashboard for the front passenger. Both airbags are marked **SRS AIRBAG**.

### Types of Airbags

The airbags can inflate whenever the power mode is in ON.

After an airbag inflates in a crash, you may see a small amount of smoke. This is from the combustion process of the inflator material and is not harmful. People with respiratory problems may experience some temporary discomfort. If this occurs, get out of the vehicle as soon as it is safe to do so.

### Front Airbags (SRS)

During a frontal crash severe enough to cause one or both front airbags to deploy, the airbags can inflate at different rates, depending on the severity of the crash, whether or not the seat belts are latched, and/or other factors. Frontal airbags are designed to supplement the seat belts to help reduce the likelihood of head and chest injuries in frontal crashes.



## ■ Operation

Front airbags are designed to inflate during moderate-to-severe frontal collisions. When the vehicle decelerates suddenly, the sensors send information to the control unit which signals one or both front airbags to inflate.

A frontal collision can be either head-on or angled between two vehicles, or when a vehicle crashes into a stationary object, such as a concrete wall.

## ■ How the Front Airbags Work

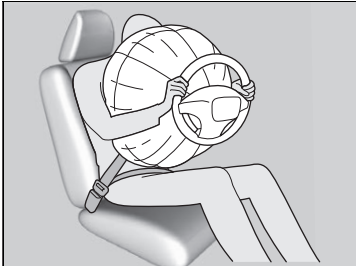

While your seat belt restrains your torso, the front airbag provides supplemental protection for your head and chest.

The front airbags deflate immediately so that they won't interfere with the driver's visibility or the ability to steer or operate other controls.

The total time for inflation and deflation is so fast that most occupants are not aware that the airbags deployed until they see them lying in front of them.

### ⊠ How the Front Airbags Work

Although the driver's and front passenger's airbags normally inflate within a split second of each other, it is possible for only one airbag to deploy. This can happen if the severity of a collision is at the margin, or threshold that determines whether or not the airbags will deploy. In such cases, the seat belt will provide sufficient protection, and the supplemental protection offered by the airbag would be minimal.

### ■ When front airbags should not deploy

**Minor frontal crashes:** Front airbags were designed to supplement seat belts and help save lives, not to prevent minor scrapes, or even broken bones that might occur during a less than moderate-to-severe frontal crash.

**Side impacts:** Front airbags can provide protection when a sudden deceleration causes a driver or front passenger to move toward the front of the vehicle. Side airbags and side curtain airbags have been specifically designed to help reduce the severity of injuries that can occur during a moderate-to-severe side impact which can cause the driver or passenger to move toward the side of the vehicle.

**Rear impacts:** Head restraints and seat belts are your best protection during a rear impact. Front airbags cannot provide any significant protection and are not designed to deploy in such collisions.

**Rollovers:** In a rollover, your best form of protection is a seat belt or, if your vehicle is equipped with a rollover sensor, both a seat belt and a side curtain airbag. Front airbags, however, are not designed to deploy in a rollover as they would provide little if any protection.

### ■ When front airbags deploy with little or no visible damage

Because the airbag system senses sudden deceleration, a strong impact to the vehicle framework or suspension might cause one or more of the airbags to deploy. Examples include running into a curb, the edge of a hole, or other low fixed object that causes a sudden deceleration in the vehicle chassis. Since the impact is underneath the vehicle, damage may not be readily apparent.

### ■ When front airbags may not deploy, even though exterior damage appears severe

Since crushable body parts absorb crash energy during an impact, the amount of visible damage does not always indicate proper airbag operation. In fact, some collisions can result in severe damage but no airbag deployment because the airbags would not have been needed or would not have provided protection even if they had deployed.

## Advanced Airbags

The airbags have advanced features to help reduce the likelihood of airbag related injuries to smaller occupants.

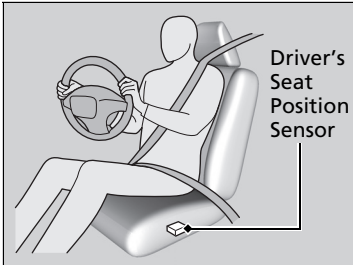

The driver's advanced airbag system includes a seat position sensor.

Based on information from this sensor and the severity of the impact, the advanced airbag system determines the optimal deployment of the driver's airbag.

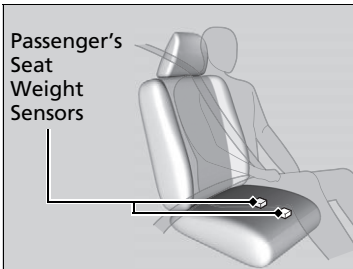

The front passenger's advanced airbag system has weight sensors. The sensors are used for occupant classification to activate or deactivate the front passenger's airbag. For adult size occupants, the system will automatically activate the front passenger's airbag. If a small adult sits in the front passenger seat and the system does not recognize him/her as an adult, see

▶ **Passenger Front Airbag Off Indicator** P. 58

## Advanced Airbags

If there is a problem with the driver's seat position sensor or the passenger's seat weight sensors, the SRS indicator will come on, and in the event of a crash, the airbag will deploy (regardless of the driver's seating position or passenger's occupant classification) with a force corresponding to the severity of the impact.

### ▶ Supplemental Restraint System (SRS) Indicator P. 57

For the advanced front airbags to work properly, confirm that:

- The occupant is sitting in an upright position, wearing the seat belt properly and the seat back is not excessively reclined.
- The occupant is not leaning against the door or center console.
- The occupant's feet are placed on the floor in front of them.
- There are no objects hanging from the front passenger's seat.
- Only small, lightweight objects are in the seat back pocket.
- The steering wheel and passenger's side dashboard are not obstructed by any object.
- No liquid has been spilled on or under the seat.

We advise against allowing a child age 12 or under to ride in the front passenger's seat. However, if you do allow a small child or infant to ride in the front passenger's seat, the system is designed to automatically deactivate the front passenger's airbag. Do not let a small child or infant ride in the front passenger's seat if the airbag does not automatically deactivate.

#### Advanced Airbags

- There is no child seat or other object pressing against the rear of the seat or seat back.
- There is no rear passenger pushing or pulling on the back of the front passenger's seat.
- There are no objects placed under or beside the front passenger's seat. Improperly positioned objects can interfere with the advanced airbag sensors.
- The head restraint is not contacting the roof.
  - **Passenger Front Airbag Off Indicator**  
P. 58
- The floor mat behind the front passenger's seat is set in the correct position evenly on the floor. An improperly placed mat can interfere with the advanced airbag sensors.
  - **Floor Mats** P. 561

## Knee Airbags

The knee SRS airbags inflate in a moderate-to-severe frontal collision to help keep the driver and/or front passenger in the proper position and to help maximize the benefit provided by the vehicle's other safety features.

**SRS** (Supplemental Restraint System) indicates that the airbag is designed to supplement seat belts, not replace them. Seat belts are the occupant's primary restraint system.

### Housing Locations

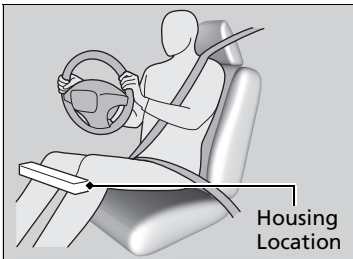

The knee airbag for the driver and the one for the front passenger are housed under the steering column and the glove box respectively.

Both are marked **SRS AIRBAG**.

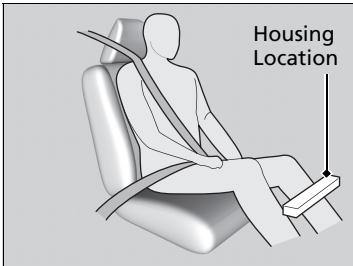

### ⊗ Knee Airbags

Do not attach accessories on or near a knee airbag as they can interfere with the proper operation of the airbag, or even hurt someone if the airbag inflates.

The driver and front passenger should not store any items under the seat or behind their feet. The items can interfere with proper airbag deployment in the event of a moderate to severe frontal collision and may result in inadequate protection.

## ■ Operation

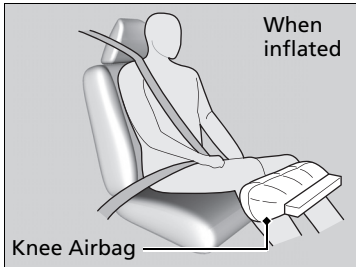
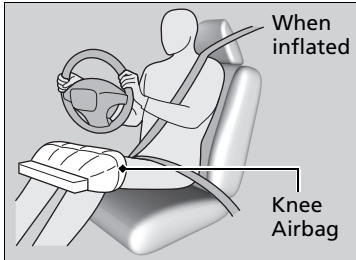

The driver's and front passenger's knee airbag deploy at the same time as the driver's and front passenger's airbag respectively.

Even if the collision is not severe enough to deploy the front airbag, the knee airbag may inflate alone.

**■ When knee airbag deploys with little or no visible damage**

Because the airbag system senses sudden deceleration, a strong impact to the vehicle framework or suspension might cause one or more of the airbags to deploy. Examples include running into a curb, the edge of a hole, or other low fixed object that causes a sudden deceleration in the vehicle chassis. Since the impact is underneath the vehicle, damage may not be readily apparent.

**■ When knee airbag may not deploy, even though exterior damage appears severe**

Since crushable body parts absorb crash energy during an impact, the amount of visible damage does not always indicate proper airbag operation. In fact, some collisions can result in severe damage but no airbag deployment because the airbags would not have been needed or would not have provided protection even if they had deployed.

## Side Airbags

The side airbags help protect the torso and pelvis of the driver or a front passenger during a moderate-to-severe side impact.

### Housing Locations

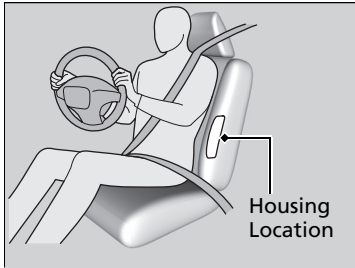

The side airbags are housed in the outside edge of the driver's and passenger's seat-backs.

Both are marked **SIDE AIRBAG**.

### Operation

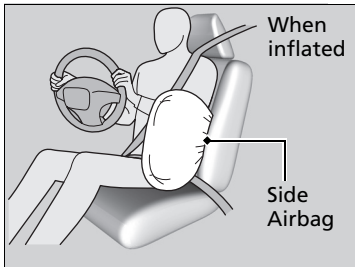

When the sensors detect a moderate-to-severe side impact, the control unit signals the side airbag on the impact side to immediately inflate.

### Side Airbags

Make sure you and your front seat passenger always sit upright. Leaning into the path of a side airbag can prevent the airbag from deploying properly and increases your risk of serious injury.

Do not attach accessories on or near the side airbags. They can interfere with the proper operation of the airbags, or hurt someone if an airbag inflates.

Do not cover or replace the front seat-back covers without consulting a dealer. Improperly replacing or covering front seat-back covers can prevent your side airbags from properly deploying during a side impact.



**■ When a side airbag deploys with little or no visible damage**

Because the airbag system senses sudden acceleration, a strong impact to the side of the vehicle's framework can cause a side airbag to deploy. In such cases, there may be little or no damage, but the side impact sensors detected a severe enough impact to deploy the airbag.

**■ When a side airbag may not deploy, even though visible damage appears severe**

It is possible for a side airbag not to deploy during an impact that results in apparently severe damage. This can occur when the point of impact was toward the far front or rear of the vehicle, or when the vehicle's crushable body parts absorbed most of the crash energy. In either case, the side airbag would not have been needed nor provided protection even if it had deployed.

## Side Curtain Airbags

The side curtain airbags help protect the heads of the driver and passengers in the outer seating positions during a moderate-to-severe side impact. The side curtain airbags equipped in this vehicle are also designed to help reduce the likelihood of partial and complete ejection of vehicle occupants through side windows in crashes, particularly rollover crashes.

### Housing Locations

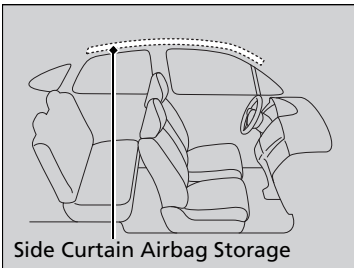

The side curtain airbags are located in the ceiling above the side windows on both sides of the vehicle.

### Operation

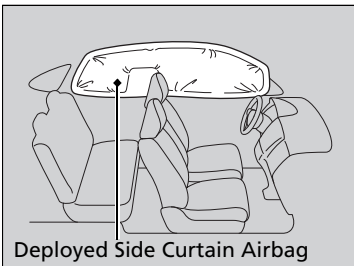

The side curtain airbag is designed to deploy in a rollover or a moderate-to-severe side impact.

### Side Curtain Airbags

To get the best protection from the side curtain airbags, occupants should wear their seat belts properly and sit upright and well back in their seats.

Do not attach any objects to the side windows or roof pillars as they can interfere with the proper operation of the side curtain airbags.

If the impact is on the passenger's side, the passenger's side curtain airbag deploys even if there are no occupants on that side of the vehicle.

If the SRS control unit senses that your vehicle is about to rollover, it immediately deploys both side curtain airbags and activates the seat belt tensioners for the front seats and outer rear seats.

### ■ When side curtain airbags deploy in a frontal collision

One or both side curtain airbags may also inflate in a moderate-to-severe angled frontal collision.

## Airbag System Indicators

If a problem occurs in the airbag system, the SRS indicator will come on and a message appears on the multi-information display.

### ■ Supplemental Restraint System (SRS) Indicator

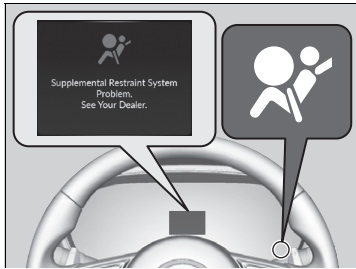

### ■ When the power mode is set to ON

The indicator comes on for a few seconds, then goes off. This tells you the system is working properly.

If the indicator comes on at any other time, or does not come on at all, have the system checked by a dealer as soon as possible. If you don't, your airbags and seat belt tensioners may not work properly when they are needed.

### ⊠ Supplemental Restraint System (SRS) Indicator

## ⚠ WARNING

Ignoring the SRS indicator can result in serious injury or death if the airbag systems or tensioners do not work properly.

Have your vehicle checked by a dealer as soon as possible if the SRS indicator alerts you to a possible problem.

*Continued*

## ■ Passenger Front Airbag Off Indicator

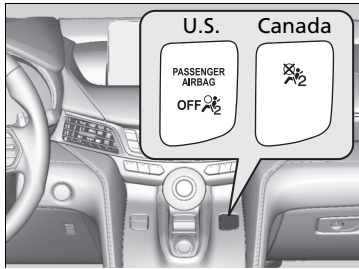

### ■ When the passenger front airbag off indicator comes on

The indicator comes on to alert you that the front passenger's airbag has been turned off. This occurs if the seat is empty or when the weight sensors determine that a small child or infant is on the passenger seat.

Children age 12 or under should always ride properly restrained in a back seat.

➤ **Child Safety** P. 61

If the indicator is on in the event of a crash, the front passenger's airbag will not deploy. The front passenger's knee airbag will not deploy, either.

## ☒ Passenger Front Airbag Off Indicator

To ensure the passenger is detected properly, confirm that:

- The occupant is sitting in an upright position, wearing the seat belt properly and the seat back is not excessively reclined.
- The occupant is not leaning against the door or center console.
- The occupant's feet are placed on the floor in front of them.
- There are no objects hanging from the front passenger's seat.
- Only small, lightweight objects are in the seat back pocket.
- No liquid has been spilled on or under the seat.
- There is no child seat or other object pressing against the rear of the seat or seat back.
- There is no rear passenger pushing or pulling on the back of the front passenger's seat.
- There are no objects placed under or beside the front passenger's seat. Improperly positioned objects can interfere with the advanced airbag sensors.
- The floor mat behind the front passenger's seat is set in the correct position evenly on the floor. An improperly placed mat can interfere with the advanced airbag sensors.
- The head restraint is not contacting the roof.

**▶▶ Passenger Front Airbag Off Indicator**

The passenger airbag off indicator may come on and go off periodically if the total weight on the seat is near the airbag cutoff threshold. For a small adult, depending on physique and posture, the system may not recognize him/her as an adult and thus deactivate the front passenger's airbag.

If this occurs, please confirm that the conditions set forth in the above bullet points on the previous page are met.

If the above conditions are met and the indicator is still on, then with the transmission in park, turn the ignition off and back on.

Have your vehicle checked by a dealer as soon as possible if:

- All of the above conditions are met, and the indicator comes on with an adult seated in the front passenger seat.
- The seat is empty and the indicator is off.

Do not allow an adult passenger to ride in the front seat when the indicator is on.

## Airbag Care

You do not need to, and should not, perform any maintenance on or replace any airbag system components yourself. However, you should have your vehicle inspected by a dealer in the following situations:

### ■ When the airbags have deployed

If an airbag has inflated, the control unit and other related parts must be replaced. Similarly, once an automatic seat belt tensioner has been activated, it must be replaced.

### ■ When the vehicle has been in a moderate-to-severe collision

Even if the airbags did not inflate, have your dealer inspect the following: the driver's seat position sensor, weight sensors in the passenger's seat, the seat belt tensioners for the front seats and outer rear seats, and each seat belt that was worn during the crash.

### ■ Do not remove or modify a front seat without consulting a dealer

This would likely disable or affect the proper operation of the driver's seat position sensor or the weight sensors in the passenger's seat. If it is necessary to remove or modify a front seat to accommodate a person with disabilities, contact an Acura dealer, or for U.S. vehicles, Acura Client Relations at 1-800-382-2238 and for Canadian vehicles, Acura Client Services at 1-888-9-ACURA-9.

### ⌘ Passenger Front Airbag Off Indicator

Have your vehicle checked by a dealer as soon as possible if:

- All of the above conditions are met, and the indicator comes on with an adult seated in the front passenger seat.
- The seat is empty and the indicator is off.

Do not allow an adult passenger to ride in the front seat when the indicator is on.

### ⌘ Airbag Care

We recommend against the use of salvaged airbag system components, including the airbag, tensioners, sensors, and control unit.

## Protecting Child Passengers

Each year, many children are injured or killed in vehicle crashes because they are either unrestrained or not properly restrained. In fact, vehicle crashes are the number one cause of death of children ages 12 and under.

To reduce the number of child deaths and injuries, every state, Canadian province and territory requires that infants and children be properly restrained when they ride in a vehicle.

**Children should sit properly restrained in a rear seat.** This is because:

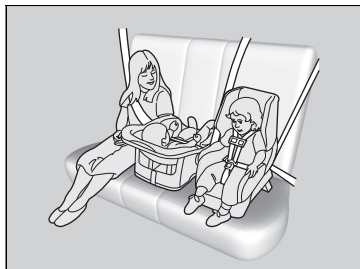

- An inflating front or side airbag can injure or kill a child sitting in the front seat.
- A child in the front seat is more likely to interfere with the driver's ability to safely control the vehicle.
- Statistics show that children of all sizes and ages are safer when they are properly restrained in a rear seat.

### Protecting Child Passengers

#### **⚠ WARNING**

**Children who are unrestrained or improperly restrained can be seriously injured or killed in a crash.**

**Any child too small for a seat belt should be properly restrained in a child seat. A larger child should be properly restrained with a seat belt, using a booster seat if necessary.**

The National Highway Traffic Safety Administration and Transport Canada recommend that all children ages 12 and under be properly restrained in a rear seat. Some states or provinces/territories have laws restricting where children may ride.

- Never hold a child on your lap because it is impossible to protect them in the event of a collision.
- Never put a seat belt over yourself and a child. During a crash, the belt would likely press deep into the child and cause serious or fatal injuries.
- Never let two children use the same seat belt. Both children could be very seriously injured in a crash.
- Any child who is too small to wear a seat belt correctly must be restrained in an approved child seat that is properly secured to the vehicle using either the seat belt or the lower anchors of the LATCH system.
- Do not allow children to operate the doors, windows or seat adjustments.
- Do not leave children in the vehicle unattended, especially in hot weather when the inside of the vehicle can get hot enough to kill them. They could also activate vehicle controls causing it to move unexpectedly.

► Protecting Child Passengers

**⚠ WARNING**

**Allowing a child to play with a seat belt or wrap one around their neck can result in serious injury or death.**

**Instruct children not to play with any seat belt and make sure any unused seat belt a child can reach is buckled, fully retracted, and locked.**

To deactivate a lockable retractor, release the buckle and allow the seat belt to wind up all the way.

To remind you of the passenger's front airbag hazards and child safety, your vehicle has warning labels on the dashboard (U.S. models) and on the front visors. Please read and follow the instructions on these labels.

► **Safety Labels** P. 76



## Safety of Infants and Small Children

### ■ Protecting Infants

An infant must be properly restrained in a rear-facing child seat until the infant reaches the seat manufacturer's weight or height limit for the seat.



#### ■ Positioning a rear-facing child seat

Child seats must be placed and secured in a rear seating position.

When properly installed, a rear-facing child seat may prevent the driver or a front passenger from moving their seat all the way back, or from locking their seat-back in the desired position. Make sure that there is no contact between the child seat and the seat in front of it.

It can also interfere with proper operation of the passenger's advanced front airbag system.

➤ **Airbags** P. 43

If this occurs, we recommend that you install the child seat directly behind the front passenger's seat, move the seat as far forward as needed, and leave it unoccupied. Or, you may wish to get a smaller rear-facing child seat.

### ☒ Protecting Infants

## ⚠ WARNING

Placing a rear-facing child seat in the front seat can result in serious injury or death during a crash.

Always place a rear-facing child seat in the rear seat, not the front.

Experts recommend use of a rear-facing seat for a child for so long as the child's height and weight are appropriate for a rear facing seat;

Always refer to the child seat manufacturer's instructions before installation. Infants never should be seated in a forward facing position.

Do not allow a front seat to rest against a child seat installed in a rear seating position: The weight sensor in the front seat may not correctly detect the actual weight of the occupant.

## ■ Protecting Smaller Children

If a child has exceeded the weight and height limitations of a rearward-facing child seat, the child should be properly restrained in a firmly secured forward-facing child seat until they exceed the weight and height limitations for the forward-facing child seat.

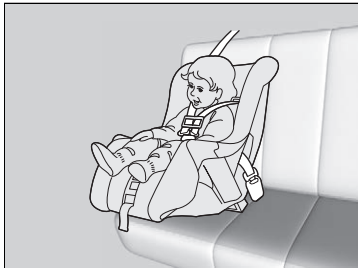

### ■ Forward-facing child seat placement

We strongly recommend placing a forward-facing child seat in a rear seating position.

Placing a forward-facing child seat in the front seat can be hazardous, even with advanced front airbags that automatically turn the passenger's front airbag off. A rear seat is the safest place for a child.

## ▶▶ Protecting Smaller Children

### ⚠ WARNING

Placing a forward-facing child seat in the front seat can result in serious injury or death if the front airbag inflates.

If you must place a forward-facing child seat in front, move the vehicle seat as far back as possible, and properly restrain the child.

Educate yourself about the laws and regulations regarding child seat use where you are driving, and follow the child seat manufacturer's instructions.

## ■ Selecting a Child Seat

Most child seats are LATCH-compatible (Lower Anchors and Tethers for Children). Some have a rigid-type connector while others have a flexible-type connector. Both are equally easy to use. Some existing and previously owned child seats can only be installed using the seat belt. Whichever type you choose, follow the child seat manufacturer's use and care instructions including recommended expiration dates as well as the instructions in this manual. Proper installation is key to maximizing your child's safety.

In seating positions and vehicles not equipped with LATCH, a LATCH-compatible child seat can be installed using the seat belt and a top tether for added security. This is because all child seats are required to be designed so that they can be secured with a lap belt or the lap part of a lap/shoulder belt. In addition, the child seat manufacturer may advise that a seat belt be used to attach a LATCH-compatible seat once a child reaches a specified weight. Please read the child seat owner's manual for proper installation instructions.

### ■ Important consideration when selecting a child seat

Make sure the child seat meets the following three requirements:

- The child seat is the correct type and size for the child.
- The child seat is the correct type for the seating position.
- The child seat is compliant with Federal Motor Vehicle Safety Standard 213 or Canadian Motor Vehicle Safety Standard 213.

### ☒ Selecting a Child Seat

Installation of a LATCH-compatible child seat is simple.

LATCH-compatible child seats have been developed to simplify the installation process and reduce the likelihood of injuries caused by incorrect installation.

## ■ Installing a LATCH-Compatible Child Seat

A LATCH-compatible child seat can be installed in either of the two outer rear seats. A child seat is attached to the lower anchors with either the rigid or flexible type of connectors.

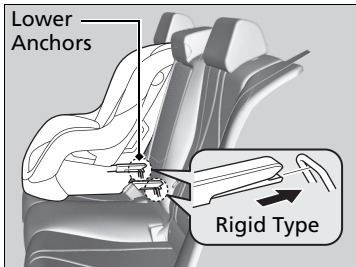
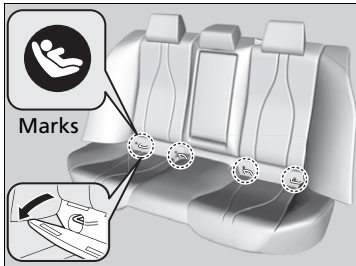

1. Locate the anchor marks affixed to the base of the seat cushion.
2. Pull out the anchor covers with the marks to expose the lower anchors.
3. Place the child seat on the vehicle seat, then attach the child seat to the lower anchors according to the instructions that came with the child seat.
  - When installing the child seat, make sure that the lower anchors are not obstructed by the seat belt or any other object.

## ►► Installing a LATCH-Compatible Child Seat

### **⚠ WARNING**

**Never attach two child seats to the same anchor. In a collision, one anchor may not be strong enough to hold two child seat attachments and may break, causing serious injury or death.**

For your child's safety, when using a child seat installed using the LATCH system, make sure that the child seat is properly secured to the vehicle. A child seat that is not properly secured will not adequately protect a child in a crash and may cause injury to the child or other vehicle occupants.

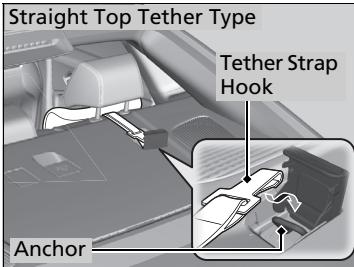
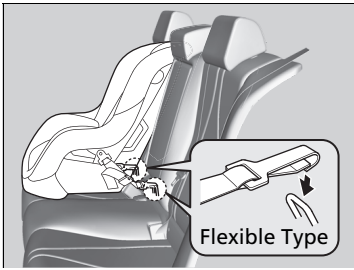

4. Open the tether anchor cover behind the head restraint.

**Straight Top Tether Type**

5. Adjust the head restraint to its upper-most position, then route the tether strap between the head restraint legs, and secure the tether strap hook to the anchor.

▶▶ Installing a LATCH-Compatible Child Seat

**⚠ WARNING**

Do not use the lower inner anchors of the outer rear seats to secure a LATCH-compatible child seat to the rear center seat, unless the manufacturer's instructions for that system permit the use of inner anchors with the stated spacing.

**Installing a LATCH-compatible child seat in the rear center seat**

Each outer rear seat is equipped with a pair of lower anchors which are used to secure a LATCH-compatible child seat. The rear center seat, however, is not equipped with anchors of any kind.

The inner and outer anchors are spaced apart at a standard distance of 11 inches (280 mm). The distance between the two inner anchors is 15.7 inches (400 mm).

LATCH-compatible restraint systems that are fitted with rigid-type attachments cannot be installed in the rear center seat. However, a system fitted with flexible-type attachments can be installed in the center seat, provided that the manufacturer's instructions for that system permit the use of the inner anchors with the stated spacing.

Before seating a child, make sure that the system is properly attached to both the lower anchors and tether anchors.

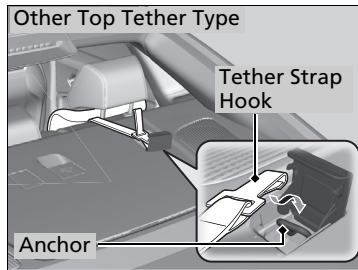

**Other Top Tether Type**

5. Adjust the head restraint to its upper-most position, then route the tether strap around the head restraint legs, and secure the tether strap hook to the anchor.

**All Types**

6. Tighten the tether strap as instructed by the child seat manufacturer.
7. Make sure the child seat is firmly secured by rocking it forward and back and side to side; little movement should be felt.
8. Make sure any unused seat belt that a child can reach is buckled, the lockable retractor is activated, and the belt is fully retracted and locked.

## ■ Installing a Child Seat with a Lap/Shoulder Seat Belt

A child seat can be installed with a lap/shoulder belt in any rear seat or, if absolutely necessary, the front passenger seat.

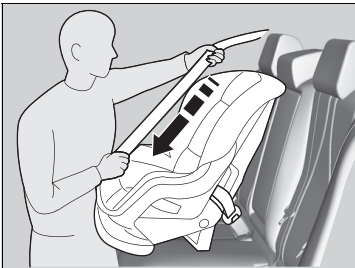

1. Place the child seat on the vehicle seat.
2. Route the seat belt through the child seat according to the seat manufacturer's instructions, and insert the latch plate into the buckle.
  - ▶ Insert the latch plate fully until it clicks.
3. Slowly pull the shoulder part of the belt all the way out until it stops. This activates the lockable retractor.
4. Let the seat belt retract a few inches and check that the retractor has switched modes by pulling on the webbing. It should not pull out again until it is reset by removing the latch plate from the buckle.
  - ▶ If you are able to pull the shoulder belt out, the lockable retractor is not activated. Slowly pull the seat belt all the way out, and repeat steps 3 – 4.

### ⊠ Installing a Child Seat with a Lap/Shoulder Seat Belt

A child seat that is not properly secured will not adequately protect a child in a crash and may cause injury to the child or other vehicle occupants.

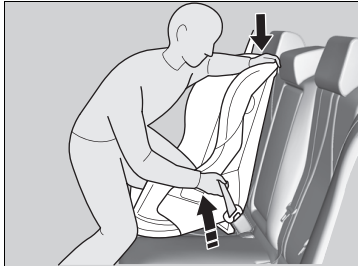

**5.** Grab the shoulder part of the seat belt near the buckle, and pull up to remove any slack from the lap part of the belt.

▶ When doing this, place your weight on the child seat and push it into the vehicle seat.

**6.** Make sure the child seat is firmly secured by rocking it forward and back and side to side; less than one inch of movement should occur near the seat belt.

**7.** Make sure any unused seat belt that a child can reach is buckled, the lockable retractor is activated, and the belt is fully retracted and locked.

▶▶ Installing a Child Seat with a Lap/Shoulder Seat Belt

To deactivate a lockable retractor, release the buckle and allow the seat belt to wind up all the way.



## ■ Adding Security with a Tether

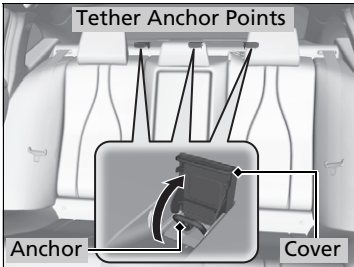

A tether anchor point is provided behind each rear seating position.

If you have a child seat that comes with a tether but can be installed with a seat belt, the tether may be used for additional security.

1. Locate the appropriate tether anchor point and lift the cover.

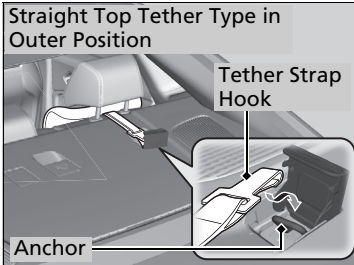

### ■ Straight Top Tether Type

2. Adjust the head restraint to its upper-most position, then route the tether strap through the head restraint legs. Make sure the strap is not twisted.

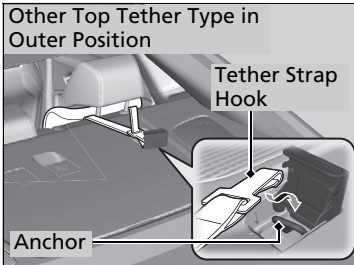

### ■ Other Top Tether Type

2. Adjust the head restraint to its upper-most position, then route the tether strap around the head restraint legs.

### ■ All Types

3. Secure the tether strap hook to the anchor.
4. Tighten the tether strap as instructed by the child seat manufacturer.

## ▶▶ Adding Security with a Tether

Always use a tether for forward-facing child seats whether using the seat belt or lower anchors.

Continued

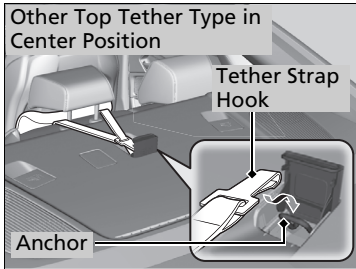
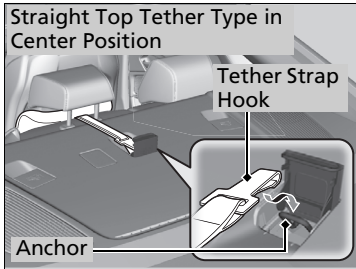

## Safety of Larger Children

### ■ Protecting Larger Children

The following pages give instructions on how to check proper seat belt fit, what kind of booster seat to use if one is needed, and important precautions for a child who must sit in front.

### ■ Checking Seat Belt Fit

When a child is too big for a child seat, secure the child in a rear seat using the lap/shoulder seat belt. Have the child sit upright and all the way back, then answer the following questions.



#### ■ Checklist

- Do the child's knees bend comfortably over the edge of the seat?
- Does the shoulder belt cross between the child's neck and arm?
- Is the lap part of the seat belt as low as possible, touching the child's thighs?
- Will the child be able to stay seated like this for the whole trip?

If you answer yes to all these questions, the child is ready to wear the lap/shoulder seat belt correctly. If you answer no to any question, the child needs to ride on a booster seat until the seat belt fits properly without a booster seat.

### ▶▶ Safety of Larger Children

## ⚠ WARNING

Allowing a child age 12 or under to sit in front can result in injury or death if the passenger's front airbag inflates.

If a larger child must ride in front, move the vehicle seat as far to the rear as possible, have the child sit up properly and wear the seat belt properly, using a booster seat if needed.

## ■ Booster Seats



If a lap/shoulder seat belt cannot be used properly, position the child in a booster seat in the rear seat. For the child's safety, check that the child meets the booster seat manufacturer's recommendations.

## ■ Protecting Larger Children - Final Checks

Your vehicle has a rear seat where children can be properly restrained. If you ever have to carry a group of children, and a child must ride in front:

- Make sure you read and fully understand the instructions and safety information in this manual.
- Move the front passenger seat as far back as possible.
- Have the child sit upright and well back in the seat.
- Check that the seat belt is properly positioned so that the child is secure in the seat.

## ■ Monitoring child passengers

We strongly recommend that you keep an eye on child passengers. Even older, more mature children sometimes need to be reminded to fasten their seat belts and sit up properly.

## ▣ Booster Seats

When installing a booster seat, make sure to read the instructions that came with it, and install the seat accordingly.

There are high- and low-type booster seats. Choose a booster seat that allows the child to wear the seat belt correctly.

Some U.S. states, and Canadian provinces and territories require children to use a booster seat until they reach a given age or weight (e.g. 6 years or 60 lbs). Be sure to check current laws in the state or province, or territory where you intend to drive.

## Carbon Monoxide Gas

The engine exhaust from this vehicle contains carbon monoxide, a colorless, odorless, and highly toxic gas. As long as you properly maintain your vehicle, carbon monoxide gas will not get into the interior.

### ■ Have the exhaust system inspected for leaks whenever

- The exhaust system is making an unusual noise.
- The exhaust system may have been damaged.
- The vehicle is raised for an oil change.

When you operate a vehicle with the trunk open, airflow can pull exhaust gas into the interior and create a hazardous condition. If you must drive with the trunk open, open all the windows and set the climate control system as shown below.

1. Select the fresh air mode.
2. Select the  mode.
3. Set the fan speed to high.
4. Set the temperature control to a comfortable setting.

Adjust the climate control system in the same manner if you sit in your parked vehicle with the engine running.

### Carbon Monoxide Gas

## ⚠ WARNING

Carbon monoxide gas is toxic.

Breathing it can cause unconsciousness and even kill you.

Avoid any enclosed areas or activities that expose you to carbon monoxide.

An enclosed area such as a garage can quickly fill up with carbon monoxide gas. Do not run the engine with the garage door closed. Even when the garage door is open, drive out of the garage immediately after starting the engine.

## Label Locations

These labels are in the locations shown. They warn you of potential hazards that can cause serious injury or death. Read these labels carefully.

If a label comes off or becomes hard to read (except for the U.S. dashboard label which may be removed by the owner), contact a dealer for a replacement.

### Sun Visors

#### U.S. models

**⚠ WARNING**  
**EVEN WITH ADVANCED AIR BAGS**

- Children can be killed or seriously injured by the air bag.
- The back seat is the safest place for children.
- Never put a rear-facing child seat in the front.
- Always use seat belts and child restraints.
- See owner's manual for more information about air bags.



#### Canadian models

<b>⚠ WARNING</b>	<b>⚠ ATTENTION</b>
<p><b>To avoid serious injury</b></p> <ul style="list-style-type: none"> <li>For maximum safety protection in all types of crashes, you must always wear your safety belt.</li> <li>Do not install rearward-facing child seats in any front passenger seat position.</li> <li>Do not sit or lean unnecessarily close to the air bag.</li> <li>Do not place any objects over the air bag or between the air bag and yourself.</li> <li>See the owner's manual for further information and explanations.</li> </ul>	<p><b>Pour éviter des blessures graves</b></p> <ul style="list-style-type: none"> <li>Pour profiter d'une protection maximale lors d'une collision bouclez toujours votre ceinture de sécurité.</li> <li>N'installez jamais un siège pour enfants faisant face à l'arrière sur le siège du passager avant.</li> <li>Nie vous appuyez pas et ne vous assoyez pas près du coussin gonflable.</li> <li>Ne déposez aucun objet sur le coussin gonflable ou entre le coussin gonflable et vous.</li> <li>Lisez le guide utilisateur pour de plus amples renseignements.</li> </ul>

### Dashboard U.S. models only

**This Vehicle is Equipped with Advanced Air Bags**

Even with Advanced Air Bags  
 Children can be killed or seriously injured by the air bag.  
 The back seat is the safest place for children.  
 Never put a rear-facing child seat in the front.  
 Always use seat belts and child restraints.  
 See owner's manual for more information about air bags.

to be removed by owner only.

### Radiator Cap

**⚠ DANGER**  
**WARNING**  
 危険  
 警告

**NEVER OPEN WHEN HOT.**  
 Hot coolant will scald you.  
**N'OUVREZ PAS QUAND CHAUD.**  
 Le liquide de refroidissement peut vous brûler.  
 高温時、絶対に開かない。  
 100kPa

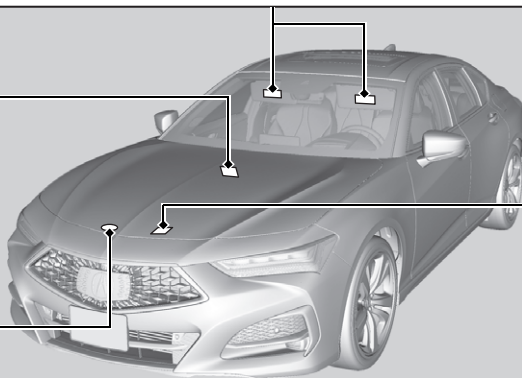

### Air Conditioner System

#### U.S. models

**⚠ WARNING**

Flammable Refrigerant  
 CAUTION SYSTEM CONTAINS REFRIGERANT  
 R-1234yf UNDER HIGH PRESSURE.  
 TO BE SERVICED ONLY BY QUALIFIED PERSONNEL.  
 Follow Instructions in the service manual.

**AIR CONDITIONER SYSTEM**  
 REFRIGERANT: R-1234yf (SAE J681, J682, J683)  
 REC. CHARGE: MAX 0.559kg MIN 0.509kg  
 OIL TYPE: ND-OIL 14 (POE)

TJB Honda Motor Co., Ltd.

#### Canadian models

**⚠** **🔥** **🧑**

**☀ R-1234yf**

# Instrument Panel

This chapter describes the buttons, indicators, and gauges that are used while driving.

























<b>Indicators</b> .....	78
<b>Gauges and Multi-Information Display</b>	
Gauges .....	97
Multi-Information Display .....	98
Head-Up Display* .....	111













\* Not available on all models

Indicators come on/blink depending on the condition of the vehicle. Messages may display on the Multi-Information Display at the same time. Please take the appropriate action outlined in the message, such as contacting a dealer.



<b>BRAKE</b> U.S.  *1 Canada	Parking Brake and Brake System Indicator (Red)	→ P. 80
<b>BRAKE SYSTEM</b> U.S.  *1 Canada	Parking Brake and Brake System Indicator (Amber)	→ P. 82
	Automatic Brake Hold System Indicator	→ P. 82
 *1 U.S.	Automatic Brake Hold Indicator	→ P. 82
 *1 Canada	Malfunction Indicator Lamp	→ P. 83
 *1	Charging System Indicator	→ P. 83
<b>D</b>	Shift Position Indicator	→ P. 83
<b>M2</b>	M (sequential mode) Indicator/Gear Selection Indicator	→ P. 83
	Transmission System Indicator	→ P. 84
	Seat Belt Reminder Indicator	→ P. 87
	Low Fuel Indicator	→ P. 87

 *1	Anti-lock Brake System (ABS) Indicator	→ P. 88
 *1	Supplemental Restraint System Indicator	→ P. 88
 *1	Electric Power Steering (EPS) System Indicator	→ P. 88
 *1	Vehicle Stability Assist™ (VSA®) System Indicator	→ P. 89
 *1	Vehicle Stability Assist™ (VSA®) OFF Indicator	→ P. 89
 *1	Low Tire Pressure/TPMS Indicator	→ P. 89
	Turn Signal and Hazard Warning Indicators	→ P. 90
	High Beam Indicator	→ P. 90
	Lights On Indicator	→ P. 90
 *	Fog Light Indicator*	→ P. 90
 *1	Auto High-Beam Indicator	→ P. 90
	System Message Indicator	→ P. 92
 *1	Maintenance Minder Indicator	→ P. 92
	Cruise Mode Indicator (White/Green)	→ P. 94







<b>AWD</b> *1	Super Handling-All Wheel Drive™ (SH-AWD®) System Indicator*	→ P. 92
	Auto Idle Stop OFF Indicator	→ P. 85
	Auto Idle Stop Suspend Indicator	→ P. 86
 *1	Auto Idle Stop System Indicator (Amber)	→ P. 85
	Auto Idle Stop Indicator (Green)	→ P. 85
	Immobilizer System Indicator	→ P. 91
	Security System Alarm Indicator	→ P. 91
 *1	Adaptive Cruise Control (ACC) with Low Speed Follow Indicator (Amber)	→ P. 93
	Adaptive Cruise Control (ACC) with Low Speed Follow Indicator (White/Green)	→ P. 93
 *1	Lane Keeping Assist System (LKAS) Indicator (Amber)	→ P. 93
	Lane Keeping Assist System (LKAS) Indicator (White/Green)	→ P. 93
 *1	Safety Support Indicator (Amber)	→ P. 95
	Safety Support Indicator (Green/Gray)	→ P. 96





\*1: When you set the power mode to ON, these indicators come on to indicate that system checks are being performed. They go off a few seconds later or after the engine has started. If an indicator does not come on or turn off, there may be a malfunction in the corresponding system. To resolve the issue, follow the instructions in the owner's manual.

\* Not available on all models



Indicator	Name	On/Blinking	Explanation
 <p>U.S. <b>BRAKE</b> Canada (Red)</p>	<p>Parking Brake and Brake System Indicator (Red)</p>	<ul style="list-style-type: none"> <li>• Comes on when the parking brake is applied, and goes off when it is released.</li> <li>• Comes on when the brake fluid level is low.</li> </ul>	<ul style="list-style-type: none"> <li>• The beeper sounds and the indicator comes on if you drive with the parking brake not fully released.</li> <li>• Comes on for about 30 seconds when you apply the electric parking brake while the power mode is in ACCESSORY or VEHICLE OFF, then goes off.</li> <li>• Stays on for about 30 seconds when you set the power mode to VEHICLE OFF while the electric parking brake is applied, then goes off.</li> <li>• <b>Comes on while driving</b> - Make sure the parking brake is released. Stop in a safe place and check the brake fluid level.             <ul style="list-style-type: none"> <li>➤ <b>What to do when the indicator comes on while driving</b> P. 600</li> </ul> </li> </ul>

Indicator	Name	On/Blinking	Explanation
<div style="text-align: center;"> <div style="border: 1px solid black; padding: 2px; display: inline-block;">U.S.</div>  <b>BRAKE</b>   <div style="border: 1px solid black; padding: 2px; display: inline-block;">Canada</div>                        (Red)                 </div>	Parking Brake and Brake System Indicator (Red)	<ul style="list-style-type: none"> <li>• Comes on if there is a problem with the brake system.</li> </ul>	<ul style="list-style-type: none"> <li>• <b>Comes on along with the ABS indicator</b> - Have your vehicle checked by a dealer.                             <ul style="list-style-type: none"> <li>➤ <b>If the Brake System Indicator (Red) Comes On or Blinks</b> P. 600</li> </ul> </li> <li>• <b>Comes on along with the Parking Brake and Brake System Indicator (amber)</b> - Immediately stop in a safe place. Contact a dealer for repair. The brake pedal becomes harder to operate. Depress the pedal further than you normally do.                             <ul style="list-style-type: none"> <li>➤ <b>If the Brake System Indicator (Red) Comes On or Blinks at the Same Time When the Brake System Indicator (Amber) Comes On</b> P. 602</li> </ul> </li> <li>• <b>Blinks and the Parking Brake and Brake System Indicator (amber) comes on at the same time</b> - There is a problem with the electric parking brake system. The parking brake may not be set. Avoid using the parking brake and have your vehicle checked by a dealer immediately.                             <ul style="list-style-type: none"> <li>➤ <b>If the Brake System Indicator (Red) Comes On or Blinks at the Same Time When the Brake System Indicator (Amber) Comes On</b> P. 602</li> </ul> </li> </ul>

Indicator	Name	On/Blinking	Explanation
	Parking Brake and Brake System Indicator (Amber)	<ul style="list-style-type: none"> <li>• Comes on if there is a problem with a system related to braking other than the conventional brake system.</li> <li>• Comes on if there is a problem with the electric parking brake system and/or the automatic brake hold system.</li> <li>• Comes on if there is a problem with the radar sensor.</li> <li>• Indicator may come on temporarily when the Maximum Load Limit is exceeded.</li> </ul>	<ul style="list-style-type: none"> <li>• <b>Comes on while driving</b> - Avoid high speeds and sudden braking. Take the vehicle to a dealer immediately.</li> <li>• <b>Stays on constantly</b> - Avoid using the parking brake and have your vehicle checked by a dealer immediately.</li> <li>• Make sure the total load is within the Maximum Load Limit.   <b>Maximum Load Limit</b> P. 369</li> <li>• <b>Stays on constantly</b> - Have your vehicle checked by a dealer.</li> </ul>
	Automatic Brake Hold System Indicator	<ul style="list-style-type: none"> <li>• Comes on when the automatic brake hold system is on.</li> </ul>	 <b>Automatic Brake Hold</b> P. 488
	Automatic Brake Hold Indicator	<ul style="list-style-type: none"> <li>• Comes on when the automatic brake hold is activated.</li> </ul>	 <b>Automatic Brake Hold</b> P. 488



Indicator	Name	On/Blinking	Explanation
	Malfunction Indicator Lamp	<ul style="list-style-type: none"> <li>• After you have set the power mode to ON, the vehicle performs system checks. However, if the readiness codes have not been set by that time, this indicator will blink five times and then go off.</li> </ul>	<ul style="list-style-type: none"> <li>• Readiness codes are part of the on board diagnostics for the emissions control systems.                             <ul style="list-style-type: none"> <li>➤ <b>Testing of Readiness Codes</b> P. 623</li> </ul> </li> </ul>
		<ul style="list-style-type: none"> <li>• Comes on if there is a problem with the emissions control systems.</li> <li>• Blinks when a misfire in the engine's cylinders is detected.</li> </ul>	<ul style="list-style-type: none"> <li>➤ <b>If the Malfunction Indicator Lamp Comes On or Blinks</b> P. 599</li> </ul>
	Charging System Indicator	<ul style="list-style-type: none"> <li>• Comes on when there is a problem with the charging system.</li> </ul>	<ul style="list-style-type: none"> <li>• Stop in a safe place and have your vehicle checked by a dealer immediately.                             <ul style="list-style-type: none"> <li>➤ <b>Checking the Battery</b> P. 553</li> <li>➤ <b>If the Charging System Indicator Comes On</b> P. 598</li> </ul> </li> </ul>
	Shift Position Indicator	<ul style="list-style-type: none"> <li>• Indicates the current gear selection.</li> </ul>	<ul style="list-style-type: none"> <li>➤ <b>Shifting</b> P. 380</li> </ul>
	M (sequential mode) Indicator/ Gear Selection Indicator	<ul style="list-style-type: none"> <li>• Comes on when the sequential mode is applied.</li> </ul>	<ul style="list-style-type: none"> <li>➤ <b>Sequential Mode</b> P. 386</li> </ul>



Indicator	Name	On/Blinking	Explanation
	Transmission System Indicator	<ul style="list-style-type: none"> <li>The current gear selection blinks if the transmission system has a problem.</li> </ul>	<ul style="list-style-type: none"> <li><b>Blinks while driving</b> - Performance may be reduced. Avoid sudden starts and acceleration and have your vehicle checked by a dealer immediately.</li> </ul>
		<ul style="list-style-type: none"> <li>The indicated current gear selection blinks if you cannot put the transmission into <b>R</b> due to a transmission system failure.</li> <li>The indicated current gear selection blinks if the transmission system is problem and the performance of the vehicle is reduced.</li> </ul>	<ul style="list-style-type: none"> <li>Avoid sudden starts, sudden acceleration and high speed, and have your vehicle checked by a dealer immediately.</li> </ul>
		<ul style="list-style-type: none"> <li>The indicated current gear selection blinks if the transmission system has a problem and the paddle shifters cannot be used.</li> </ul>	<ul style="list-style-type: none"> <li>Have your vehicle checked by a dealer immediately.</li> </ul>
		<ul style="list-style-type: none"> <li>The current gear position or all the gear positions blink if there is a problem with the transmission and the vehicle is no longer able to run.</li> </ul>	<ul style="list-style-type: none"> <li>Immediately park your car in a safe place.                             <ul style="list-style-type: none"> <li>📄 <b>Emergency Towing</b> P. 612</li> </ul> </li> <li>Have your vehicle checked by a dealer.</li> </ul>
		<ul style="list-style-type: none"> <li>The current gear position or all the gear positions blink if there is a problem with the transmission and it is not possible to select <b>P</b>.</li> </ul>	<ul style="list-style-type: none"> <li>Depending on the circumstances, you can set the power mode to ON as an emergency measure.                             <ul style="list-style-type: none"> <li>📄 <b>If the Transmission System Indicator Blinks along with the Warning Message</b> P. 604</li> </ul> </li> <li>While the vehicle is stopped, apply the parking brake.</li> <li>Have your vehicle checked by a dealer immediately.</li> </ul>



Indicator	Name	On/Blinking	Explanation
	Auto Idle Stop Indicator (Green)	<ul style="list-style-type: none"> <li>Comes on when Auto Idle Stop is in operation. The engine automatically shuts off.</li> </ul>	<ul style="list-style-type: none"> <li>➤ <b>Auto Idle Stop</b> P. 395</li> </ul>
	Auto Idle Stop <b>OFF</b> Indicator	<ul style="list-style-type: none"> <li>Comes on when the Auto Idle Stop system has been turned off by the Auto Idle Stop system <b>OFF</b> button.</li> </ul>	<ul style="list-style-type: none"> <li>➤ <b>Auto Idle Stop System ON/OFF</b> P. 397</li> </ul>
	Auto Idle Stop System Indicator (Amber)	<ul style="list-style-type: none"> <li>Blinks if there is a problem with the Auto Idle Stop system.</li> </ul>	<ul style="list-style-type: none"> <li>• <b>Blinks</b> - Have your vehicle checked by a dealer.</li> </ul>





Indicator	Name	On/Blinking	Explanation
	Auto Idle Stop Suspend Indicator	<ul style="list-style-type: none"> <li>• Comes on while Auto Idle Stop is temporarily suspended in the following situations.</li> </ul>	—
		- Brake pedal is not fully pressed	<ul style="list-style-type: none"> <li>• Depress the brake pedal firmly.</li> </ul>
		- The transmission is in a position other than <b>D</b>	<p>➤ <b>Auto Idle Stop</b> P. 395</p>
		- System charging is prioritized	
		- Climate control system is prioritized	
		- Engine coolant temperature is not in operating range	
		- The Integrated Dynamics System mode is in <b>SPORT</b> or <b>INDIVIDUAL</b> mode (when the Auto Idle Stop setting is set to <b>Disable</b> ).	<p>➤ <b>Auto Idle Stop</b> P. 395</p> <p>➤ <b>Customizing the INDIVIDUAL Settings</b> P. 393</p>
		- Auto Idle Stop does not activate for some reason.	
—	<ul style="list-style-type: none"> <li>• If you press and hold the Auto Idle Stop <b>OFF</b> button, you can select whether to display the status messages or not.</li> </ul>		





Indicator	Name	On/Blinking	Explanation
	Seat Belt Reminder Indicator	<ul style="list-style-type: none"> <li>• Blinks and the beeper sounds for a few seconds if you are not wearing a seat belt when you set the power mode to ON, then the indicator comes on.</li> <li>• If the front passenger is not wearing a seat belt, the indicator comes on a few seconds later.</li> <li>• Blinks while driving if you and/or the front passenger has not fastened a seat belt. The beeper sounds and the indicator blinks at regular intervals.</li> </ul>	<ul style="list-style-type: none"> <li>• The beeper stops and the indicator goes off when you and the front passenger fasten their seat belts.</li> <li>• <b>Stays on after you and/or the front passenger has fastened the seat belt(s)</b> - A detection error may have occurred in the sensor. Have your vehicle checked by a dealer.                             <ul style="list-style-type: none"> <li>▣ <b>Seat Belt Reminder</b> P. 37</li> </ul> </li> </ul>
	Low Fuel Indicator	<ul style="list-style-type: none"> <li>• Comes on when the fuel reserve is running low (approximately 2.38 U.S. gal./9.0 Liter left).</li> <li>• Blinks if there is a problem with the fuel gauge.</li> </ul>	<ul style="list-style-type: none"> <li>• <b>Comes on</b> - Refuel your vehicle as soon as possible.</li> <li>• <b>Blinks</b> - Have your vehicle checked by a dealer.</li> </ul>



Indicator	Name	On/Blinking	Explanation
	Anti-lock Brake System (ABS) Indicator	<ul style="list-style-type: none"> <li>Comes on if there is a problem with the ABS.</li> </ul>	<ul style="list-style-type: none"> <li><b>Stays on constantly</b> - Have your vehicle checked by a dealer. With this indicator on, your vehicle still has normal braking ability but no anti-lock function.                             <ul style="list-style-type: none"> <li>➤ <b>Anti-lock Brake System (ABS)</b> P. 490</li> </ul> </li> </ul>
	Supplemental Restraint System Indicator	<ul style="list-style-type: none"> <li>Comes on if a problem with any of the following is detected:                             <ul style="list-style-type: none"> <li>- Supplemental restraint system</li> <li>- Side airbag system</li> <li>- Side curtain airbag system</li> <li>- Seat belt tensioner</li> </ul> </li> </ul>	<ul style="list-style-type: none"> <li><b>Stays on constantly</b> - Have your vehicle checked by a dealer.</li> </ul>
	Electric Power Steering (EPS) System Indicator	<ul style="list-style-type: none"> <li>Comes on if there is a problem with the EPS system.</li> </ul>	<ul style="list-style-type: none"> <li><b>Stays on constantly</b> - Have your vehicle checked by a dealer.                             <ul style="list-style-type: none"> <li>➤ <b>If the Electric Power Steering (EPS) System Indicator Comes On</b> P. 601</li> </ul> </li> </ul>





Indicator	Name	On/Blinking	Explanation
	Vehicle Stability Assist™ (VSA®) System Indicator	<ul style="list-style-type: none"> <li>• Blinks when VSA® is active.</li> </ul>	—
		<ul style="list-style-type: none"> <li>• Comes on if there is a problem with the brake assist system, VSA® system or hill start assist system.</li> </ul>	<ul style="list-style-type: none"> <li>• <b>Stays on constantly</b> - Have your vehicle checked by a dealer.                             <ul style="list-style-type: none"> <li>▶ <b>Vehicle Stability Assist™ (VSA®), aka Electronic Stability Control (ESC), System</b> P. 402</li> </ul> </li> </ul>
		<ul style="list-style-type: none"> <li>• Comes on if the VSA® system is deactivated temporarily after the battery has been disconnected, then re-connected.</li> </ul>	<ul style="list-style-type: none"> <li>• Drive a short distance at more than 12 mph (20 km/h). The indicator should go off. If it does not, have your vehicle checked by a dealer.</li> </ul>
	Vehicle Stability Assist™ (VSA®) OFF Indicator	<ul style="list-style-type: none"> <li>• Comes on when you partially disable VSA®.</li> </ul>	<ul style="list-style-type: none"> <li>▶ <b>VSA® On and Off</b> P. 403</li> </ul>
		<ul style="list-style-type: none"> <li>• Comes on if the VSA® system is deactivated temporarily after the battery has been disconnected, then re-connected.</li> </ul>	<ul style="list-style-type: none"> <li>• Drive a short distance at more than 12 mph (20 km/h). The indicator should go off. If it does not, have your vehicle checked by a dealer.</li> </ul>
	Low Tire Pressure/TPMS Indicator	<ul style="list-style-type: none"> <li>• Comes on if the tire pressure of any of the tires becomes low.</li> </ul>	<ul style="list-style-type: none"> <li>• <b>Comes on while driving</b> - Stop in a safe place, check tire pressures, and inflate the tire(s) if necessary.</li> </ul>
		<ul style="list-style-type: none"> <li>• Blinks for about one minute, and then stays on if there is a problem with the TPMS with Tire Fill Assist, or when a compact spare tire is temporarily installed.</li> </ul>	<ul style="list-style-type: none"> <li>• <b>Blinks and remains on</b> - Have your vehicle checked by a dealer. If the vehicle is fitted with a compact spare tire, get your regular tire repaired or replaced and put back on your vehicle as soon as you can.</li> </ul>



Indicator	Name	On/Blinking	Explanation
	Turn Signal and Hazard Warning Indicators	<ul style="list-style-type: none"> <li>• Blinks when you operate the turn signal lever.</li> <li>• Blink along with all turn signals when you press the hazard warning button.</li> </ul>	<ul style="list-style-type: none"> <li>• <b>Does not blink or blinks rapidly</b> - Have your vehicle checked by a dealer.</li> </ul>
	High Beam Indicator	<ul style="list-style-type: none"> <li>• Comes on when the high beam headlights are on.</li> </ul>	—
	Lights On Indicator	<ul style="list-style-type: none"> <li>• Comes on when the parking, tail, and other external lights are on.</li> </ul>	➤ <b>Light Switches</b> P. 148
	Fog Light Indicator*	<ul style="list-style-type: none"> <li>• Comes on when the fog lights are on.</li> </ul>	➤ <b>Fog Lights*</b> P. 151
	Auto High-Beam Indicator	<ul style="list-style-type: none"> <li>• Comes on when all the operating conditions of the auto high-beam are met.</li> </ul>	➤ <b>Auto High-Beam</b> P. 152

Indicator	Name	On/Blinking	Explanation
	Immobilizer System Indicator	<ul style="list-style-type: none"> <li>Blinks if the immobilizer system cannot recognize the key information.</li> </ul>	<ul style="list-style-type: none"> <li><b>Blinks</b> - You cannot start the engine. Set the power mode to VEHICLE OFF*1, then select the ON mode again.</li> <li><b>Repeatedly blinks</b> - The system may be malfunctioning. Have your vehicle checked by a dealer.</li> <li>Do not attempt to alter this system or add other devices to it. Electrical problems can occur.</li> </ul>
	Security System Alarm Indicator	<ul style="list-style-type: none"> <li>Blinks when the security system alarm has been set.</li> </ul>	<p> <b>Security System Alarm</b> P. 137</p>

\*1:Canadian models only: Apply and hold the brake pedal before selecting the ON mode.



Indicator	Name	On/Blinking	Explanation
	System Message Indicator	<ul style="list-style-type: none"> <li>Comes on along with a beep when a problem is detected. A system message on the multi-information display appears at the same time.</li> </ul>	<ul style="list-style-type: none"> <li>While the indicator is on, roll the right selector wheel to see the message again.                             <ul style="list-style-type: none"> <li>➤ <b>Switching the Display</b> P. 100</li> </ul> </li> <li>Refer to the Indicators information in this chapter when a system message appears on the multi-information display. Take the appropriate action for the message.</li> <li>The multi-information display does not return to the normal screen unless the warning is canceled, or the right selector wheel is pressed.</li> </ul>
	Super Handling-All Wheel Drive™ (SH-AWD®) Indicator*	<ul style="list-style-type: none"> <li>Comes on if there is a problem with the SH-AWD® system.</li> <li>Blinks when the differential temperature is too high.</li> </ul>	<ul style="list-style-type: none"> <li><b>Stays on constantly</b> - The engine drives the front wheels only in this state. Have your vehicle checked by a dealer.</li> <li><b>Blinks while driving</b> - Stop in a safe place, put the transmission into <b>[P]</b>, and idle the engine until the indicator goes off. If the indicator does not stop blinking, take your vehicle to a dealer.                             <ul style="list-style-type: none"> <li>➤ <b>Super Handling-All Wheel Drive™ (SH-AWD®)</b>* P. 405</li> </ul> </li> </ul>
	Maintenance Minder Indicator	<ul style="list-style-type: none"> <li>Comes on when the scheduled maintenance is due soon.</li> <li>Consequently, <b>Maintenance Due Now</b> and <b>Maintenance Past Due</b> follow.</li> </ul>	<ul style="list-style-type: none"> <li>➤ <b>Maintenance Minder™</b> P. 521</li> </ul>

Indicator	Name	On/Blinking	Explanation
	Adaptive Cruise Control (ACC) with Low Speed Follow Indicator (Amber)	<ul style="list-style-type: none"> <li>• Comes on if there is a problem with ACC with Low Speed Follow.</li> <li>• Indicator may come on temporarily when the Maximum Load Limit is exceeded.</li> <li>• ACC with Low Speed Follow has been automatically canceled.</li> <li>• Comes on if the ACC is deactivated temporarily after the battery has been disconnected, then re-connected.</li> </ul>	<ul style="list-style-type: none"> <li>• <b>Comes on while driving</b> - Have your vehicle checked by a dealer.</li> <li>• Make sure the total load is within the Maximum Load Limit.                             <ul style="list-style-type: none"> <li>▶ <b>Maximum Load Limit</b> P. 369</li> </ul> </li> <li>• <b>Stays on constantly</b> - Have your vehicle checked by a dealer.</li> <li>• Drive a short distance at more than 12 mph (20 km/h). The indicator should go off. If it does not, have your vehicle checked by a dealer.</li> </ul>
	Adaptive Cruise Control (ACC) with Low Speed Follow Indicator (White/Green)	<ul style="list-style-type: none"> <li>• Lights up in white when you press the  button.</li> <li>• Lights up in green when you press the <b>RES/+</b> button or <b>SET/-</b> button.</li> </ul>	<ul style="list-style-type: none"> <li>▶ <b>Adaptive Cruise Control (ACC) with Low Speed Follow</b> P. 428</li> </ul>
	Lane Keeping Assist System (LKAS) Indicator (Amber)	<ul style="list-style-type: none"> <li>• Comes on if there is a problem with the LKAS.</li> </ul>	<ul style="list-style-type: none"> <li>• <b>Stays on constantly</b> - Have your vehicle checked by a dealer.</li> </ul>
	Lane Keeping Assist System (LKAS) Indicator (White/Green)	<ul style="list-style-type: none"> <li>• Lights up in white when you press the LKAS button.</li> <li>• Lights up in green when the LKAS is in operation.</li> </ul>	<ul style="list-style-type: none"> <li>▶ <b>Lane Keeping Assist System (LKAS)</b> P. 448</li> </ul>

Indicator	Name	On/Blinking	Explanation
	Cruise Mode Indicator (White/Green)	<ul style="list-style-type: none"> <li>• Lights up in white when you change to cruise mode.</li> <li>• Lights up in green when you have set a speed for cruise control.</li> </ul>	<ul style="list-style-type: none"> <li>• <b>➤ To Switch ACC with Low Speed Follow to Cruise Control</b> P. 444</li> </ul>
	Safety Support Indicator (Amber)	<ul style="list-style-type: none"> <li>• Comes on if there is a problem with RDM, CMBS™, or blind spot information system*.</li> <li>• Indicator may come on temporarily when the Maximum Load Limit is exceeded.</li> <li>• Comes on if the RDM and CMBS™ are deactivated temporarily after the battery has been disconnected and then re-connected.</li> </ul>	<ul style="list-style-type: none"> <li>• <b>Stays on constantly</b> - Have your vehicle checked by a dealer.</li> <li>• Make sure the total load is within the Maximum Load Limit.                             <ul style="list-style-type: none"> <li>• <b>➤ Maximum Load Limit</b> P. 369</li> </ul> </li> <li>• <b>Stays on constantly</b> - Have your vehicle checked by a dealer.</li> <li>• Drive a short distance at more than 12 mph (20 km/h). The indicator should go off. If it does not, have your vehicle checked by a dealer.</li> </ul>



Indicator	Name	On/Blinking	Explanation
	<p>Safety Support Indicator (Amber)</p>	<ul style="list-style-type: none"> <li>• Comes on when RDM and/or CMBS™ shuts itself off.</li> </ul>	<ul style="list-style-type: none"> <li>• Indicator may come on temporarily when passing through an enclosed space, such as a tunnel.</li> <li>• The area around the radar sensor is blocked by dirt, mud, etc. Stop your vehicle in a safe place and wipe the debris off with a soft cloth. Indicator may take some time to go off after the radar sensor is cleaned.</li> <li>• Have your vehicle checked by a dealer if the indicator does not go off even after you have cleaned the radar sensor.                             <ul style="list-style-type: none"> <li>➤ <b>Radar Sensor</b> P. 482</li> </ul> </li> <li>• <b>Stays on</b> - The temperature inside the camera is too high. Use the climate control system to cool down the camera. The system activates when the temperature inside the camera cools down.                             <ul style="list-style-type: none"> <li>➤ <b>Front Sensor Camera</b> P. 480</li> </ul> </li> <li>• <b>Stays on</b> - The area around the camera is blocked by dirt, mud, etc. Stop your vehicle in a safe place and wipe the debris off with a soft cloth.</li> <li>• Have your vehicle checked by a dealer if the indicator and message are still displayed even after you have cleaned the area around the camera.                             <ul style="list-style-type: none"> <li>➤ <b>Front Sensor Camera</b> P. 480</li> </ul> </li> </ul>

Indicator	Name	On/Blinking	Explanation
	Safety Support Indicator (Amber)	<p><b>Models with blind spot information system</b></p> <ul style="list-style-type: none"> <li>• Comes on when mud, snow, or ice has accumulated in the vicinity of the blind spot information system sensor.</li> </ul>	<ul style="list-style-type: none"> <li>• <b>Comes on while driving</b> - Remove the obstacle in the vicinity of the blind spot information system sensor.                             <ul style="list-style-type: none"> <li>➤ <b>Blind spot information System*</b> P. 410</li> </ul> </li> </ul>
	Safety Support Indicator (Green/Gray)	<ul style="list-style-type: none"> <li>• Lights up in green when RDM, CMBS™, and blind spot information system* are on.</li> <li>• Lights up in green and gray when RDM, CMBS™, or blind spot information system*, or any two of these systems are off.</li> <li>• Lights up in gray when RDM, CMBS™, and blind spot information system* are off.</li> </ul>	<ul style="list-style-type: none"> <li>➤ <b>RDM On and Off</b> P. 471</li> <li>➤ <b>CMBS™ On and Off</b> P. 421</li> <li>➤ <b>Blind spot information System On and Off</b> P. 412</li> </ul>

## Gauges

Gauges include the speedometer, tachometer, fuel gauge, and related indicators. They are displayed when the power mode is in ON.

### ■ Speedometer

Displays your driving speed in mph (U.S.) or km/h (Canada).

### ■ Tachometer

Shows the number of engine revolutions per minute.

### ■ Fuel Gauge

Displays the amount of fuel left in the fuel tank.

### ■ Temperature Gauge

Displays the temperature of the engine coolant.

### ■ Current Mode for ACC with Low Speed Follow and, the LKAS, and Traffic Jam Assist

Shows the current mode for ACC with Low Speed Follow, LKAS, and traffic jam assist.

- **Adaptive Cruise Control (ACC) with Low Speed Follow** P. 428
- **Lane Keeping Assist System (LKAS)** P. 448
- **Traffic Jam Assist** P. 457

#### ☞ Fuel Gauge

##### NOTICE

You should refuel when the reading approaches **E**. Running out of fuel can cause the engine to misfire, damaging the catalytic converter.

The actual amount of remaining fuel may differ from the fuel gauge reading.

#### ☞ Temperature Gauge

##### NOTICE

Driving with the temperature gauge pointer in the upper zone can cause serious engine damage. Pull safely to the side of the road and allow engine temperature to return to normal.

- **Overheating** P. 595

## Multi-Information Display

The multi-information display shows information such as the estimated travelable distance and fuel economy of the vehicle. It also displays messages such as warnings and other helpful information.

When a warning message displays, please check the message and contact a dealer and have the vehicle inspected if necessary. Please refer to the pages below if the **“Engine Oil Pressure Low”**, **“Engine Temperature Too Hot”** or **“Slow Down! Reduced Stopping Power”** message is displayed.

➤ **If the Low Oil Pressure Warning Appears** P. 597

➤ **Overheating** P. 595

➤ **If the Slow Down! Reduced Stopping Power Warning Appears** P. 598

### Sub Display

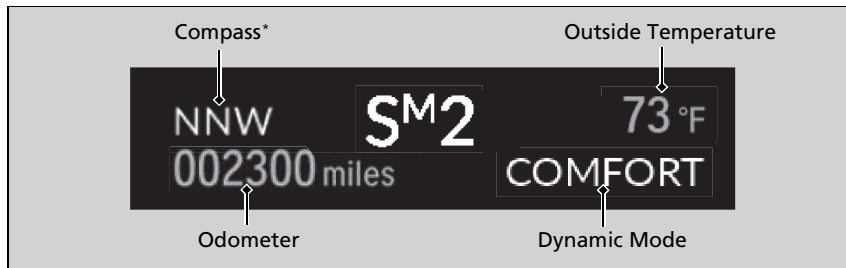

### Odometer

Shows the total number of miles or kilometers that your vehicle has accumulated.

## ■ Outside Temperature

Shows the outside temperature in Fahrenheit (U.S.) or Celsius (Canada).

### ■ Adjusting the outside temperature display

Adjust the temperature reading by up to  $\pm 5^{\circ}\text{F}$  or  $\pm 3^{\circ}\text{C}$  if the temperature reading seems incorrect.

## ■ Compass\*

Shows the current traveling direction of the vehicle.

## ■ Dynamic Mode

Shows the current dynamic mode.

➤ **Integrated Dynamics System** P. 388

## ■ Speed Limit Information

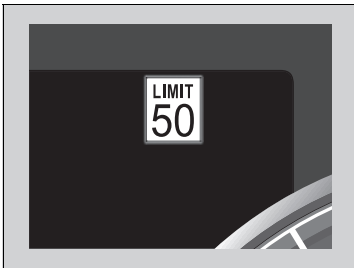

Shows the current speed limit based on either information compiled through the navigation system\* or speed limit signs captured by the front sensor camera.

\* Not available on all models

### ⌘ Outside Temperature

The temperature sensor is in the front bumper. Road heat and exhaust from another vehicle can affect the temperature reading when your vehicle speed is less than 19 mph (30 km/h).

It may take several minutes for the display to be updated after the temperature reading has stabilized.

You can adjust the temperature reading.

➤ **Customized Features** P. 300

### ⌘ Speed Limit Information

The speed limit displayed on the screen may differ to the actual speed limit. The speed limit for some roads is not displayed.

#### Models with navigation system

You can select whether the source of the speed limit information is the front sensor camera or the navigation system.

You can also turn off speed limit information.

➤ **Customized Features** P. 300

#### Models without navigation system

You can turn on or off the speed limit information.

➤ **Customized Features** P. 300

## ■ Switching the Display

Roll the right selector wheel to view different types of content.

## ▣ Switching the Display

If a warning initially appears, you can - after reading it - press the right selector wheel to proceed immediately to the content or to any other warning(s).

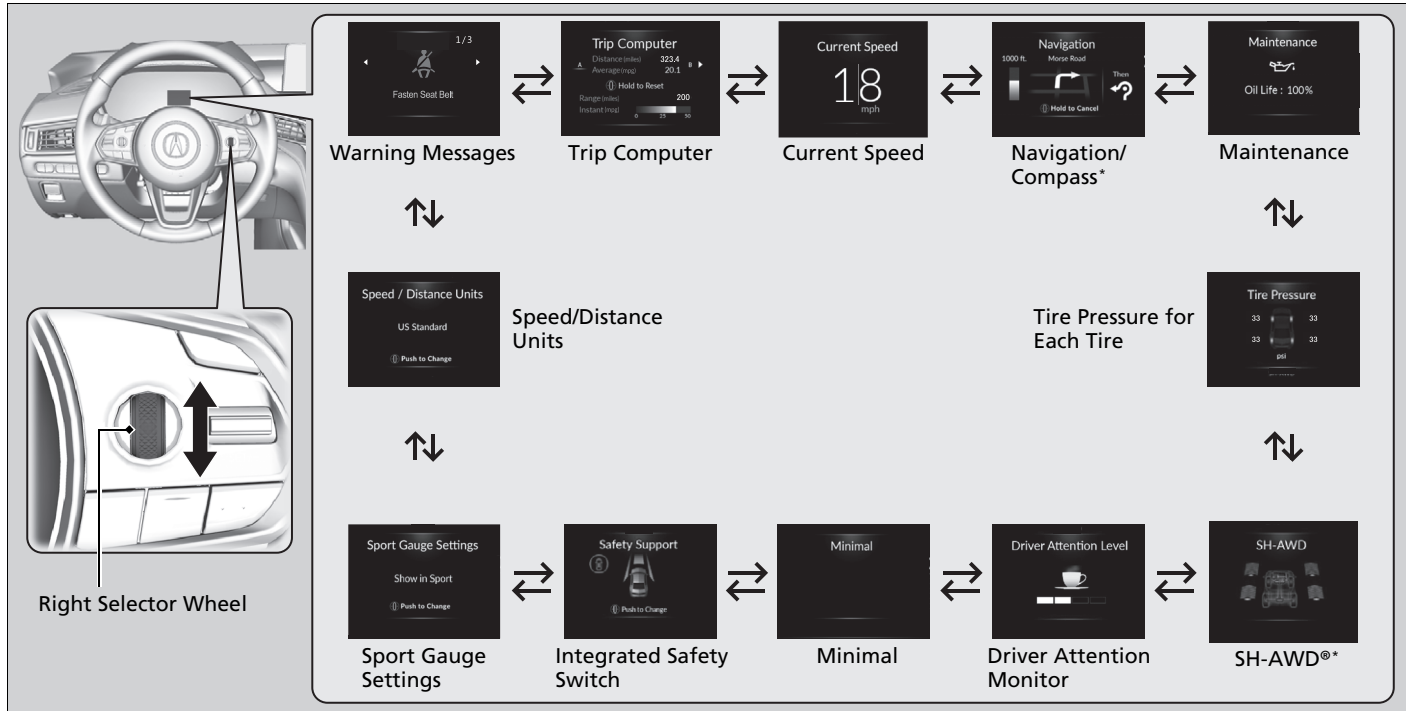

## ■ Trip Computer

Move the right selector wheel to the right or left to switch between trip computer A and trip computer B.

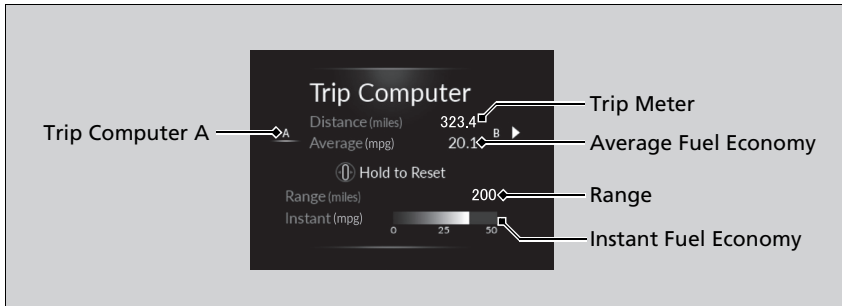

## ■ Trip meter

Shows the total number of miles or kilometers driven since the last reset. Meters A and B can be used to measure two separate trips.

## Resetting a trip meter

To reset the trip meter, display it, press and hold the right selector wheel.

- ▶ The trip meter is reset to **0.0**.

### ■ Average fuel economy

Shows the estimated average fuel economy of each trip meter in mpg or l/100 km. The display is updated at set intervals. When a trip meter is reset, the average fuel economy is also reset.

### ■ Instant fuel economy

Shows the instant fuel economy as a bar graph in mpg or l/100 km.

### ■ Range

Shows the estimated distance you can travel on the remaining fuel. This estimated distance is based on the vehicle's current fuel economy.

## ■ Navigation

### ■ Compass\*

Shows the compass screen.

### ■ Turn-by-Turn Directions

When driving guidance is provided by the navigation system\* or Android Auto, turn-by-turn directions to your destination appear.

➤ **Refer to the Navigation System Manual**

➤ **Android Auto** P. 270

### ☒ Average fuel economy

You can change when to reset the average fuel economy.

➤ **Customized Features** P. 300

### ☒ Navigation

You can cancel the driving guidance by pressing and holding the right selector wheel.

A confirmation screen appears when Apple CarPlay navigation route is active.

You can select whether to have the turn-by-turn display come on or not during the route guidance.

➤ **Customized Features** P. 300

➤ **To Change Head-Up Display Content** P. 113



## ■ Warning

You can check if there are any active warning messages.

## ■ Maintenance

Shows the remaining oil life and Maintenance Minder™.

➤ **Maintenance Minder™** P. 521

## ■ Tire Pressure Monitor

Shows each tire's pressure.

➤ **Tire Pressure Monitoring System (TPMS) with Tire Fill Assist** P. 406

## ■ Speed/Distance Units

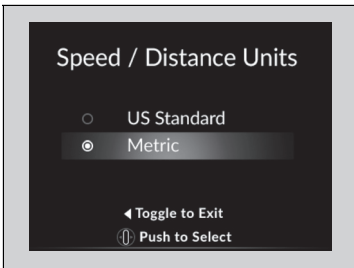

Enables you to show another unit on the multi-information display, head-up display\* and audio/information screen and set the displayed measurements to read in either miles and km, mph and km/h.

Press the right selector wheel when you select the **Speed/Distance Units** on the multi-information display. Roll the right selector wheel to select the unit and press it. After this, a confirmation screen will appear for a few seconds.

## ⌘ Warning

If there are multiple warnings, you can move the right selector wheel to the right or left to see other warnings.

## ⌘ Tire Pressure Monitor

The following colors indicate the state of tire pressure:

- Green: Within tire pressure regulation.
- Amber: Above or Below tire pressure regulation.
- White: There is a problem with the system.

\* Not available on all models

## ■ Sport Gauge Settings

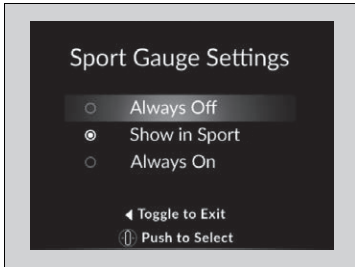

Press the right selector wheel when you select the **Sport Gauge Settings** on the multi-information display.

Roll the right selector wheel to select the setting and press it.

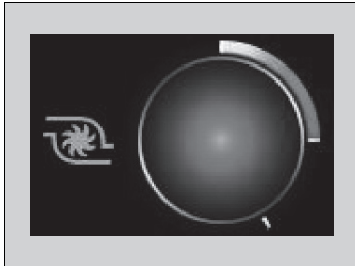

### ■ Turbo Meter

When the turbo is producing boost, this meter indicates boost pressure is building.

■ **G-meter**

A red circle moves around to indicate where your vehicle is currently receiving a lateral force while driving.

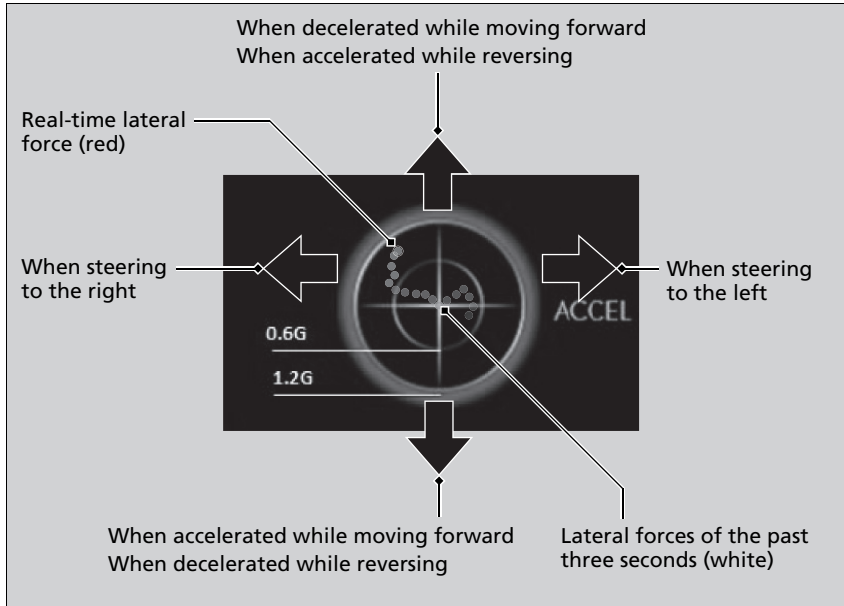

⊠ G-meter

The meter does not display a lateral force larger than 1.2 G.

If there is a problem with the VSA® system, the G-meter will not track the lateral force acting on the vehicle.

## ■ SH-AWD® Torque Distribution Monitor \*

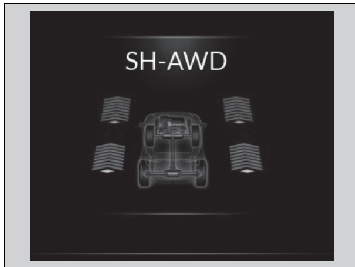

The indicators on the display show the amount of torque being transferred to the right front, left front, right rear, and left rear wheels.

▶ **Super Handling-All Wheel Drive™ (SH-AWD®)\*** P. 405

## ■ Driver Attention Monitor

The Driver Attention Monitor analyzes steering inputs to determine if the vehicle is being driven in a manner consistent with drowsy or inattentive driving. If it determines that the vehicle is being driven in such a manner, it will display the degree of the driver's attention on the multi-information display.

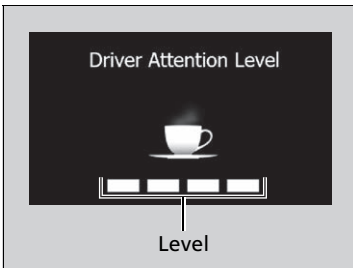
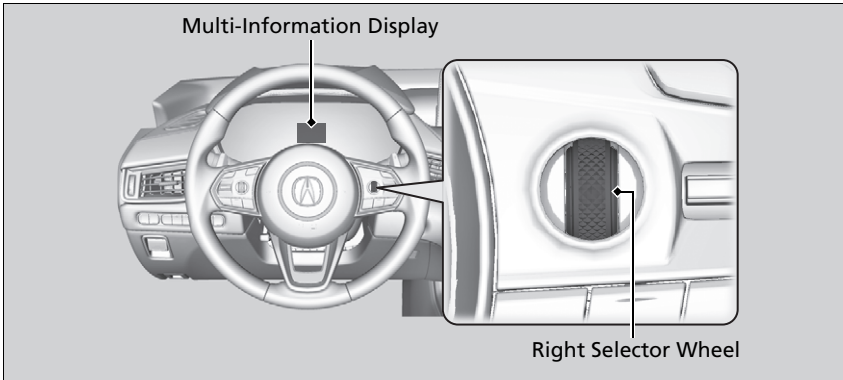

When you select Driver Attention Monitor on the multi-information display, bars on it light up in white to indicate the degree of the driver's attention.

☒ **Switching the Display** P. 100

## ☒ Driver Attention Monitor

The Driver Attention Monitor cannot always detect if the driver is tired or inattentive.

Regardless of the system's feedback, if you are feeling tired, stop in a safe location and rest for as long as needed.

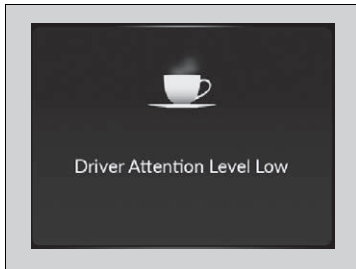

If two bars light up, the **Driver Attention Level Low** message will appear.

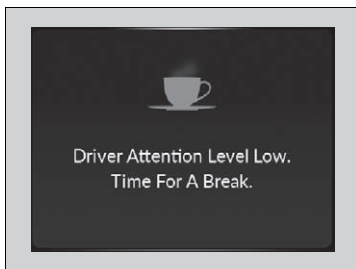

If one bar lights up, the **Driver Attention Level Low. Time For A Break** message will appear, a beep will sound, and the steering wheel will vibrate.

If this message appears, stop in a safe location and rest for as long as needed.

The message will disappear when the right selector wheel is pressed or when the system has determined that the driver is driving normally.

If the driver does not take a break and the monitor continues to detect that the driver is very tired, the message will appear again after approximately 15 minutes, accompanied by a beep and steering wheel vibrations.

The message does not appear when the traveling time is 30 minutes or less.

■ **The Driver Attention Monitor resets when:**

- The power mode is set to VEHICLE OFF.
- The driver unfastens the seat belt and opens the door while the vehicle is stopped.

■ **For the Driver Attention Monitor to function:**

- The vehicle must be traveling above 25 mph (40 km/h).
- The electric power steering (EPS) system indicator must be off.

■ **Depending on driving conditions or other factors, the Driver Attention Monitor may not function in the following circumstances:**

- The steering assist function of the Lane Keeping Assist System (LKAS) is active.
  - ▶ **Lane Keeping Assist System (LKAS)** P. 448
- The condition of the road is poor, e.g. the surface is unpaved or bumpy.
- It is windy.
- The driver is frequently operating the vehicle in an assertive manner such as changing lanes or accelerating.

■ **Customizing**

You can change the Driver Attention Monitor settings. Select **Tactile/Audible Alert, Tactile Alert, or OFF.**

- ▶ **Customized Features** P. 300

⊗ For the Driver Attention Monitor to function:

---

The bars on the multi-information display remain grayed out unless the Driver Attention Monitor is functioning.

## ■ Safety Support

Indicates the state of RDM, CMBS™ and blind spot information system\*, such as On, Off, or Failure, by color and letters.

The following colors indicate the state of any of the above mentioned systems:

- Green: The system is on.
- Gray: The system is off.
- Amber: There is a problem with the system.

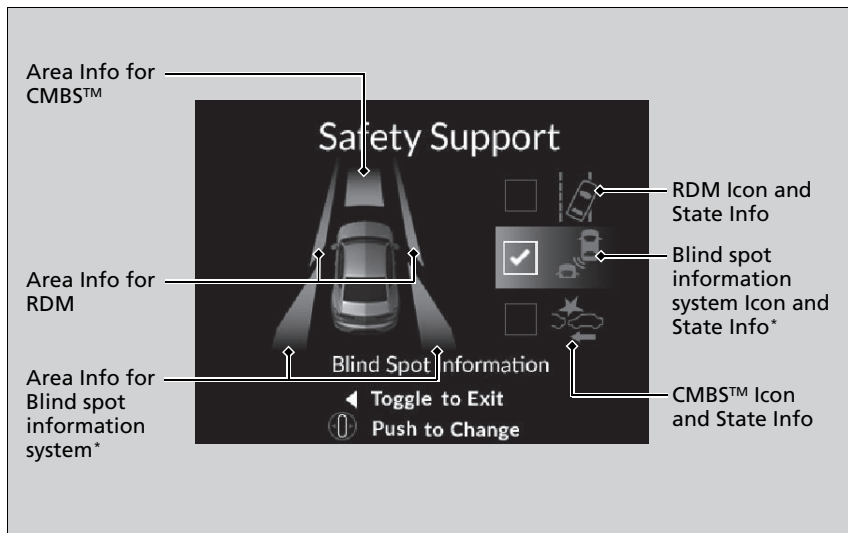

## ► Safety Support

If a system is indicated by the color amber, have your vehicle checked by a dealer immediately.

To turn on or off each system, first press and roll the right selector wheel to select the desired item, and then press the right selector wheel.

► **RDM On and Off** P. 471

► **CMBS™ On and Off** P. 421

► **Blind spot information System On and Off** P. 412

You can also confirm the state of the each function by the color of the safety support indicator.

► **Safety Support Indicator (Amber)** P. 94

► **Safety Support Indicator (Green/Gray)** P. 96



## Head-Up Display\*

Shows the currently selected Driving View information. You can choose which items are displayed using the left selector wheel on the steering wheel. They are displayed when the power mode is in ON.

🔧 **To Change Head-Up Display Content** P. 113

The display can be moved up and down to become level with your eyes.

**To raise or lower the head-up display:** Press and hold the ▲ or ▼ button until the desired position is reached.

### 🔧 Head-Up Display\*

When you unlock and open the driver's door with a remote transmitter, or keyless access system, the head-up display adjusts automatically to one of the two preset positions.

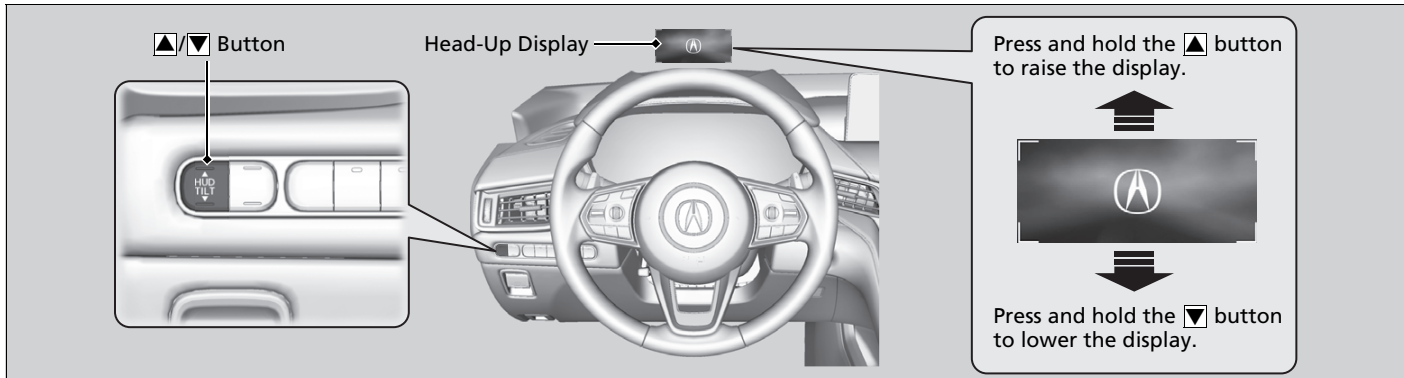

\* Not available on all models

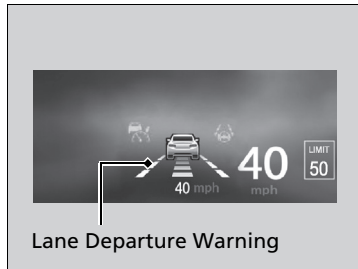

The display also shows the following warnings.

- **Lane Departure Warning:** When your vehicle is too close to the traffic lane lines, the lane departure warning appears.
  - ▶ **Lane Keeping Assist System (LKAS)**  
P. 448
- **Head-Up Warning Lights:**  
Flash when the **BRAKE** message appears on the multi-information display.
  - ▶ **Collision Mitigation Braking System™ (CMBS™)** P. 417
  - ▶ **Adaptive Cruise Control (ACC) with Low Speed Follow** P. 428

## ■ To Change Head-Up Display Content

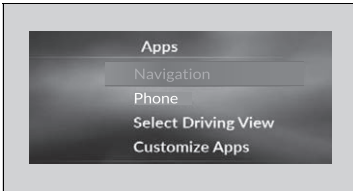

Press the **APPS** button and roll the left selector wheel to select **Select Driving View** and press the left selector wheel. Each time you move the left selector wheel to the right or left, the head-up display content will change.

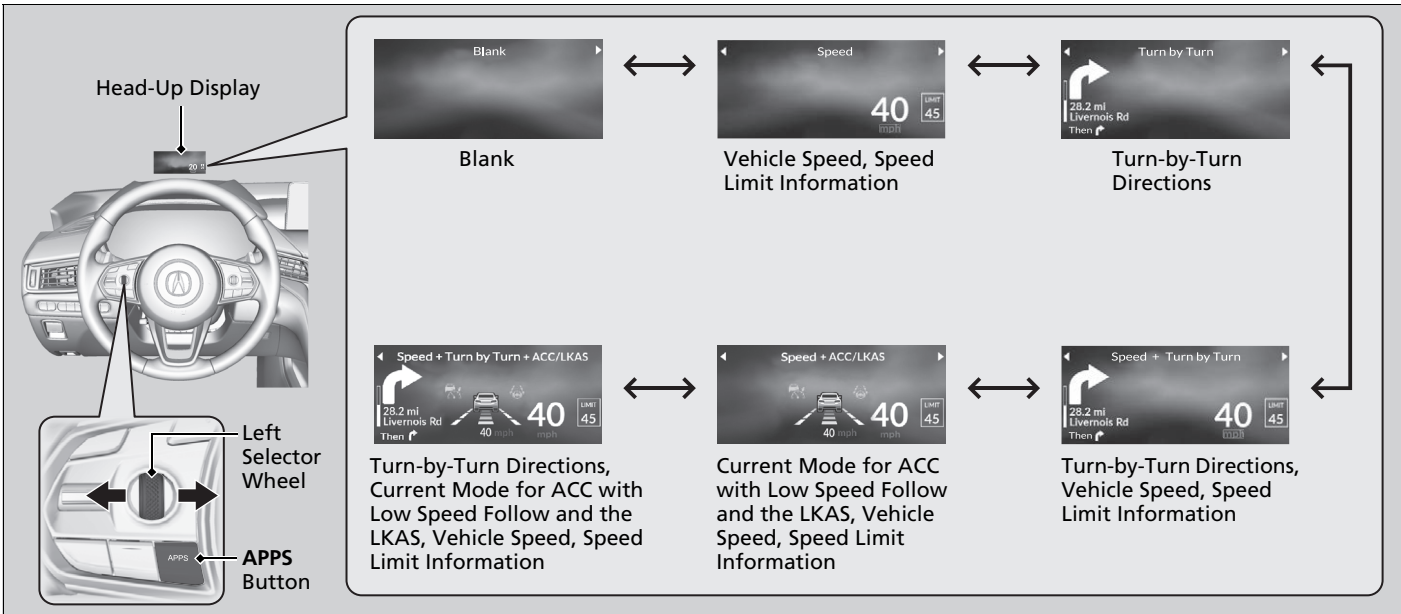

## ■ Vehicle Speed

Shows your driving speed in mph or km/h.

## ■ Current Mode for ACC with Low Speed Follow and, the LKAS, and Traffic Jam Assist

Shows the current mode for ACC with Low Speed Follow, LKAS, and traffic jam assist.

- **Adaptive Cruise Control (ACC) with Low Speed Follow** P. 428
- **Lane Keeping Assist System (LKAS)** P. 448
- **Traffic Jam Assist** P. 457

## ■ Turn-by-Turn Directions

Shows you turn-by-turn driving directions to your destination linked with the navigation system or Android Auto.

- **Refer to the Navigation System Manual**
- **Android Auto** P. 270

## ■ Speed Limit Information

Shows the current speed limit based on either information compiled through the navigation system or speed limit signs captured by the front sensor camera.

## ⌘ Vehicle Speed

Switch between mph and km/h by using the multi-information display or customized features on the audio/information screen.

- **Speed/Distance Units** P. 103
- **Customized Features** P. 300

## ⌘ Speed Limit Information

The speed limit displayed on the screen may differ to the actual speed limit.  
The speed limit for some roads is not displayed.

You can select whether the source of the speed limit information is the front sensor camera or the navigation system.

You can also turn off speed limit information.

- **Customized Features** P. 300

# Controls

This chapter explains how to operate the various controls necessary for driving.

<b>Clock</b> .....	116	Security System Alarm.....	137	Driving Position Memory System .....	160
<b>Locking and Unlocking the Doors</b>		<b>Windows</b> .....	140	Adjusting the Steering Wheel .....	162
Key .....	118	<b>Moonroof</b> .....	143	<b>Mirrors</b> .....	163
Low Keyless Access Remote Signal		<b>Operating the Switches Around the</b>		Interior Rearview Mirror .....	163
Strength .....	120	<b>Steering Wheel</b>		Power Door Mirrors .....	164
Locking/Unlocking the Doors from the		ENGINE START/STOP Button.....	144	<b>Seats</b> .....	166
Outside .....	121	Turn Signals .....	147	Front Seats .....	166
Locking/Unlocking the Doors from the		Light Switches.....	148	<b>Interior Convenience Items</b> .....	178
Inside .....	130	Fog Lights* .....	151	Interior Lights .....	178
Childproof Door Locks .....	132	Daytime Running Lights .....	151	Storage Items .....	180
Auto Door Locking/Unlocking .....	133	Auto High-Beam .....	152	<b>Climate Control System</b>	
<b>Opening and Closing the Trunk</b> .....	134	Wipers and Washers .....	155	Using Automatic Climate Control ....	195
<b>Security System</b> .....	137	Brightness Control .....	157	Automatic Climate Control Sensors...	199
Immobilizer System .....	137	Rear Defogger/Heated Door Mirror Button ..	159		

\* Not available on all models

## Adjusting the Clock

You can adjust the time manually in the audio/information screen with the power mode in ON.

### Adjusting the Time



You can adjust the time using the A-zone touchpad.

➤ **True Touchpad Interface** P. 209

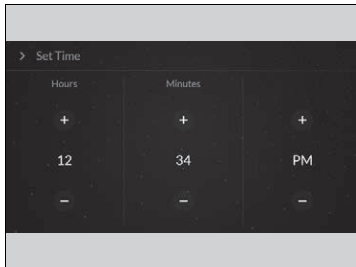
1. Press the  (home) button.
2. Select **Settings**.
3. Select **System**.
4. Select **Date & Time**.
5. Select **Set Date & Time**.
6. Select **Automatic Date & Time**.
7. Select **Off**.



**To adjust time:**



8. Select **Set Time**.
9. Select .
  - ▶ When you customize the clock display to 24 hour clock, AM/PM icon is not displayed.
- **Customized Features** P. 300
10. Press the  (back) button to set the time.

#### ⌘ Clock

The clock is automatically updated through the audio system.

#### ⌘ Adjusting the Time

You can also adjust the clock by selecting the clock displayed on the right side of the display.

1. Press the  (cards list) button.
2. Select **Clock** using the B-zone touchpad.
3. Press the B-zone touchpad.
4. Select **Set Date & Time** using the A-zone touchpad.
5. Select **Automatic Date & Time**.
6. Select **Off**.
7. Select **Set Date** or **Set Time**.
8. Select  to adjust the dates, hours and minutes.
9. Press the  (back) button to set the date or time.

You can customize the clock display to show the 12 hour clock or 24 hour clock.

➤ **Customized Features** P. 300

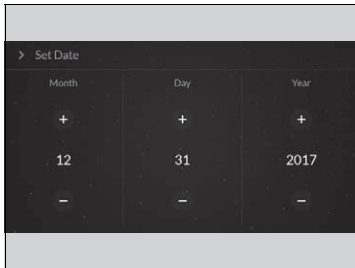
**To adjust date:**

8. Select **Set Date**.
9. Select **+**/**-**.
10. Press the **⏪** (back) button to set the date.

## Key

This vehicle comes with the following keys:

Models without two-way keyless access remote



Models with two-way keyless access remote



Use the keys to start and stop the engine, and to lock and unlock all the doors, fuel fill door and to open the trunk.

### Key

All the keys have an immobilizer system. The immobilizer system helps to protect against vehicle theft.

➔ **Immobilizer System** P. 137

Follow the advice below to prevent damage to the keys:

- Do not leave the keys in direct sunlight, or in locations with high temperature or high humidity.
- Do not drop the keys or set heavy objects on them.
- Keep the keys away from liquids, dust and sand.
- Do not take the keys apart except for replacing the battery.

If the circuits in the keys are damaged, the engine may not start, and the remote transmitter may not work.

If the keys do not work properly, have them inspected by a dealer.

Models with two-way keyless access remote

You can remotely start the engine using the two-way keyless access remote.

➔ **Remote Engine Start\*** P. 374



## Built-in Key

Models without two-way keyless access remote

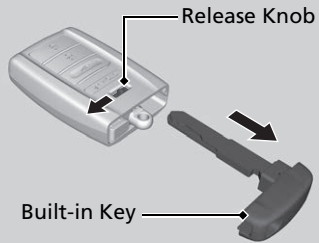

Models with two-way keyless access remote

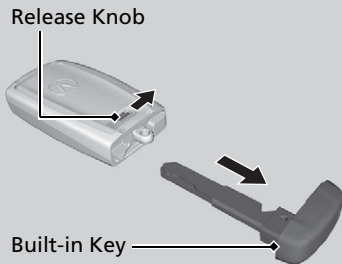

The built-in key can be used to lock/unlock the doors when the keyless access remote battery becomes weak and the power door lock/unlock operation is disabled.

To remove the built-in key, slide the release knob and then pull out the key. To reinstall the built-in key, push the built-in key into the keyless access remote until it clicks.

## ■ Key Number Tag

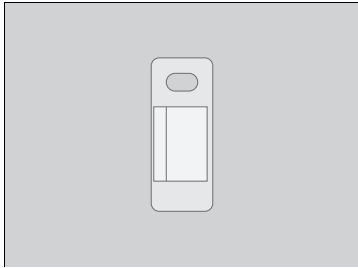

Contains a number that you will need if you purchase a replacement key.

## Low Keyless Access Remote Signal Strength

The vehicle transmits radio waves to locate the keyless access remote when locking/unlocking the doors, fuel fill door, opening the trunk, or to start the engine.

In the following cases, locking/unlocking the doors, opening the trunk, or starting the engine may be inhibited or operation may be unstable:

- Strong radio waves are being transmitted by nearby equipment.
- You are carrying the keyless access remote together with telecommunications equipment, laptop computers, cell phones, or wireless devices.
- A metallic object is touching or covering the keyless access remote.

## ☒ Key Number Tag

Keep the key number tag separate from the key in a safe place outside of your vehicle. If you wish to purchase an additional key, contact a dealer.

If you lose your key and you cannot start the engine, contact a dealer.

## ☒ Low Keyless Access Remote Signal Strength

Communication between the keyless access remote and the vehicle consumes the keyless access remote's battery.

Battery life is about two years, but this varies depending on regularity of use.

The battery is consumed whenever the keyless access remote is receiving strong radio waves. Avoid placing it near electrical appliances such as televisions and personal computers.

## Locking/Unlocking the Doors from the Outside

### ■ Using the Keyless Access System

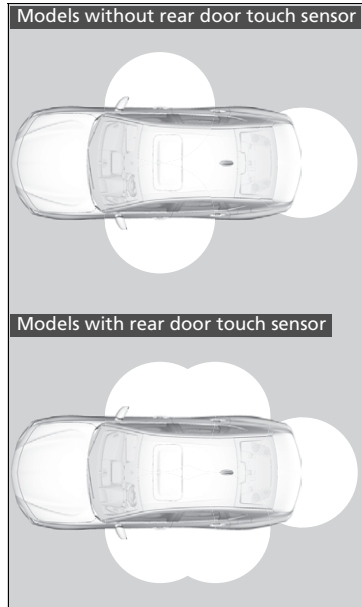

When you carry the keyless access remote, you can lock/unlock the doors, fuel fill door and open the trunk. You can lock/unlock the doors, fuel fill door and trunk within a radius of about 32 inches (80 cm) of the outside door handle or trunk release button.

### ☒ Locking/Unlocking the Doors from the Outside

If the interior light switch is in the door activated position, the interior light comes on when you unlock the doors.

No doors opened: The light fades out after 30 seconds.

Doors relocked: The light goes off immediately.

➤ **Interior Lights** P. 178

### ☒ Using the Keyless Access System

If you do not open a door within 30 seconds of unlocking the vehicle with the keyless access system, the doors, fuel fill door and trunk will automatically relock.

➤ **Customized Features** P. 300

You can lock or unlock doors, fuel fill door and trunk using the keyless access system only when the power mode is in VEHICLE OFF.

## ■ Locking the doors and trunk

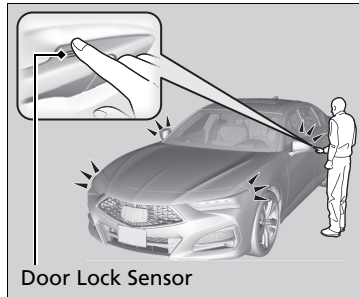

Touch the door lock sensor on the front or rear\* door.

- ▶ Some exterior lights flash; the beeper sounds; all the doors, fuel fill door and trunk lock; and the security system sets.

## ☒ Using the Keyless Access System

- Do not leave the keyless access remote in the vehicle when you get out. Carry it with you.
- Even if you are not carrying the keyless access remote, you can lock/unlock the doors while someone else with the remote is within range.
- The door may be unlocked if the door handle is covered with water in heavy rain or in a car wash if the keyless access remote is within range.
- If you grip a front or rear\* door handle or touch a door lock sensor wearing gloves, the door sensor may be slow to respond or may not respond by unlocking the doors.
- After locking the door, you have up to 2 seconds during which you can pull the door handle to confirm whether the door is locked. If you need to unlock the door immediately after locking it, wait at least 2 seconds before gripping the handle, otherwise the door will not unlock.
- The door may not open if you pull it immediately after gripping the door handle. Grip the handle again and confirm that the door is unlocked before pulling the handle.
- Even within the 32 inches (80 cm) radius, you may not be able to lock/unlock the doors with the keyless access remote if it is above or below the outside handle.
- The keyless access remote may not operate if it is too close to the door and door glass.

## ■ Unlocking the doors and trunk

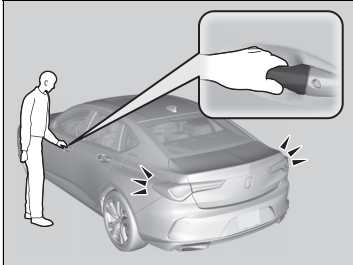

Grab the driver's door handle:

- ▶ The driver's door and fuel fill door unlocks.
- ▶ Some exterior lights flash twice and the beeper sounds twice.

Grab the front passenger's or rear\* door handle:

- ▶ All doors and fuel fill door unlock.
- ▶ Some exterior lights flash twice and the beeper sounds twice.

Press the trunk release button:

- ▶ The trunk unlocks and opens.
- ▶ Some exterior lights flash twice and the beeper sounds.

➤ **Using the Trunk Release Button** P. 135

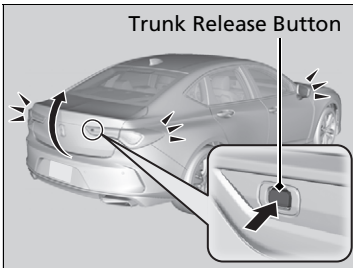

## ➤ Using the Keyless Access System

The light flash, beep and door unlock mode settings can be customized using the audio/information screen.

➤ **Customized Features** P. 300

### Models with puddle lights

When you go into the keyless access system working range with all the doors locked, the puddle lights come on for 30 seconds.

The lights do not come on if you have previously stayed within the range for more than two minutes, or the doors have been locked for a few days.

The feature activates again after you open and close any door, then lock the doors.

\* Not available on all models

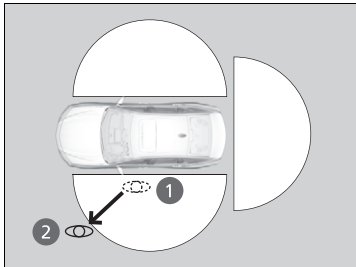
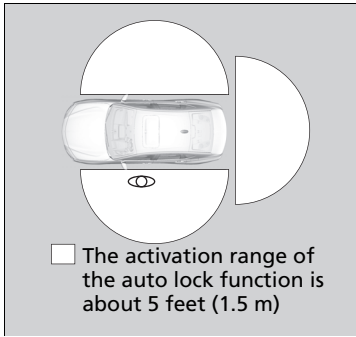

### ■ Locking the doors and trunk (Walk away auto lock®)

When you walk away from the vehicle while carrying the keyless access remote, the doors, fuel fill door and trunk will automatically lock. The auto lock function activates when all doors are closed, and the keyless access remote is within about 5 feet (1.5 m) radius of the outside door handle.

Exit vehicle while carrying keyless access remote and close door(s).

1. While within about 5 feet (1.5 m) radius of the vehicle.
  - ▶ The beeper sounds; the auto lock function will be activated.
2. Carry the keyless access remote beyond about 5 feet (1.5 m) from the vehicle and remain outside this range for 2 or more seconds.
  - ▶ Some exterior lights flash; the beeper sounds; all doors, fuel fill door and trunk will then lock.

### ▶ Locking the doors and trunk (Walk away auto lock®)

The auto lock function is set to OFF as the factory default setting. The auto lock function can be set to ON using the audio/information screen.

If you set the auto lock function to ON using the audio/information screen, the setting change will only apply to the remote transmitter that was used to unlock the driver's door prior to the setting change.

▶ **Customized Features P. 300**

After the auto lock function has been activated, when you stay within the locking/unlocking operation range, the indicator on the keyless access remote will continue to flash until the doors are locked.

When you stay beside the vehicle within the operation range, the doors will automatically lock approximately 30 seconds after the auto lock function activating beeper sounds.

When you open a door after the auto lock function activating beeper sounds, the auto lock function will be canceled.

Under the following circumstances, the auto lock function will not activate:

- The keyless access remote is inside the vehicle.
  - ▶ The beeper will not sound.
- The keyless access remote is taken out of its operational range before all the doors are closed.
  - ▶ The beeper will sound.

To temporarily deactivate the function:

1. Set the power mode to OFF.
2. Open the driver's door.
3. Using the master door lock switch, operate the lock as follows:  
Lock → Unlock → Lock → Unlock.  
▶ The beeper sounds and the function is deactivated.

To restore the function:

- Set the power mode to ON.
- Lock the vehicle without using the auto lock function.
- With the keyless access remote on you, move out of the auto lock function operation range.
- Open any door.

#### ⌘ Locking the doors and trunk (Walk away auto lock®)

The auto lock function does not operate when any of the following conditions are met.

- The keyless access remote is inside the vehicle.
- A door or the hood is not closed.
- The power mode is set to any mode other than OFF.
- The keyless access remote is not located within a radius of about 5 feet (1.5 m) from the vehicle when you get out of the vehicle and close the doors.

#### **Auto lock function operation stop beeper**

After the auto lock function has been activated, the auto lock operation stop beeper sounds for approximately two seconds in the following cases.

- The keyless access remote is put inside the vehicle through a window.
  - You are located too close to the vehicle.
  - The keyless access remote is put inside the trunk.
- If the warning beeper sounds, check that you are carrying the keyless access remote. Then, open/close a door and confirm the auto lock activation beeper sounds once.

## ■ Using the Remote Transmitter

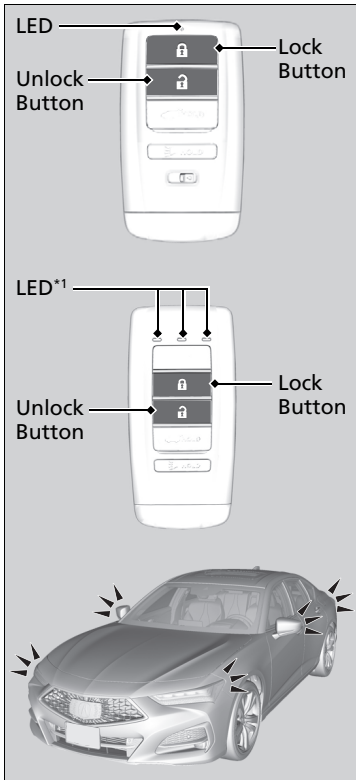

### ■ Locking the doors

Press the lock button.

#### Once:

- ▶ Some exterior lights flash, all the doors, fuel fill door and trunk lock, and the security system sets.

#### Twice (within five seconds after the first push):

- ▶ Some exterior lights flash and the beeper sounds and verifies the security system is set.

### ■ Unlocking the doors

Press the unlock button.

#### Once:

- ▶ Some exterior lights flash twice, and the driver's door and fuel fill door unlocks.

#### Twice:

- ▶ Some exterior lights flash twice, and the remaining doors and trunk unlock.

\*1: Checking Door Lock Status\* P. 129

## ▣ Using the Remote Transmitter

If you do not open a door within 30 seconds of unlocking the vehicle with the remote transmitter, the doors, fuel fill door and trunk will automatically relock.

You can change the relock timer setting.

➤ **Customized Features** P. 300

You can lock or unlock doors, fuel fill door and trunk using the remote transmitter only when the power mode is in VEHICLE OFF.

The remote transmitter uses low-power signals, so the operating range may vary depending on the surroundings.

The remote will not lock the vehicle when a door is open.

If the distance at which the remote transmitter works varies, the battery is probably low.

If the LED does not come on when you press a button, the battery is dead.

➤ **Replacing the Button Battery** P. 557

You can customize the door unlock mode setting.

➤ **Customized Features** P. 300



## ■ Locking/Unlocking the Doors Using a Key

If the lock or unlock button of the keyless access remote does not work, use the key instead.

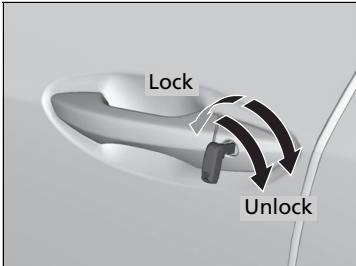

Fully insert the key and turn it.

## ▣ Locking/Unlocking the Doors Using a Key

When you lock the driver's door with a key, all the other doors, fuel fill door and trunk lock at the same time. When unlocking, the driver's door and fuel fill door unlock first. Turn the key a second time within a few seconds to unlock the remaining doors and trunk.

You can customize the door unlock mode setting.

▣ **Customized Features** P. 300

## ■ Locking a Door Without Using a Key

If you do not have the key on you, or if for some reason you cannot lock a door using the key, you can lock the door without it.

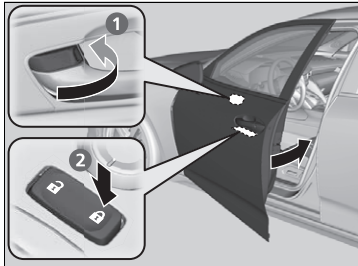

### ■ Locking the front doors

Push the lock tab forward ① or push the master door lock switch in the lock direction ②, and close the door.

### ■ Locking the rear doors

Push the lock tab forward and close the door.

### ■ Lockout prevention system

The doors cannot be locked when the keyless access remote is inside the vehicle.

### ▶ Locking a Door Without Using a Key

When you lock the driver's door, all the other doors, fuel fill door and trunk lock at the same time.

Before locking a door, make sure that the key is not inside the vehicle.

## ■ Checking Door Lock Status\*

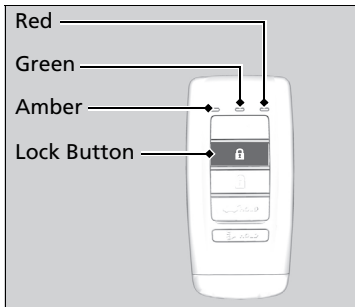

You can remotely check if your vehicle's doors are all locked or any are unlocked using the keyless access remote from extended distances.

Press the lock button, the Amber (LEFT) LED blinks once. Then after three seconds one of the following feedback will come:

- Green (center) comes on: Acknowledges that the doors are locked.
- Red (right) comes on: Acknowledges that doors are not locked, or any door is not completely closed.
- Red (right) blinks three times: The remote does not receive the door lock status from the vehicle.

\* Not available on all models

## ☒ Checking Door Lock Status\*

Operate the remote in an open space. If there are buildings or other obstacles between your vehicle and the remote, the remote may not work even within the operable range. However, the range required for unlocking the trunk and all the doors as well as activating the panic function is the same as that required for operating the standard keyless access remote.

When checking the door lock status, you can also start or stop the engine.

☒ **Remote Engine Start\*** P. 374

## Locking/Unlocking the Doors from the Inside

### ■ Using the Lock Tab

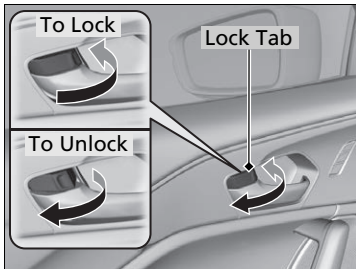

■ **Locking a door**  
Push the lock tab forward.

■ **Unlocking a door**  
Pull the lock tab rearward.

### ☒ Using the Lock Tab

When you lock the door using the lock tab on the driver's door, all of the other doors, fuel fill door and trunk lock at the same time.

When you unlock the door using the lock tab on the driver's door, only the driver's door and fuel fill door will unlock.

## ■ Unlocking Using the Front Door Inner Handle

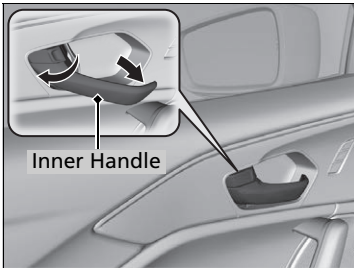

Pull the front door inner handle.

- ▶ The door unlocks and opens in one motion.

Unlocking and opening the driver's door from the inner handle unlocks all the other doors, fuel fill door and trunk.

To avoid all the doors to be unlocked, use the lock tab on the driver's door to unlock, then lock again before opening the door.

- ▶ This setting works for one time only. If you do not want all the doors to be unlocked all the time, customize the **Auto Door Unlock** setting to **Off** using the audio/information screen.

## ☒ Unlocking Using the Front Door Inner Handle

The front door inner handles are designed to allow front seat occupants to open the door in one motion. However, this feature requires that front seat occupants never pull a front door inner handle while the vehicle is in motion.

Children should always ride in a rear seat where childproof door locks are provided.

➤ **Childproof Door Locks** P. 132

### ■ Using the Master Door Lock Switch

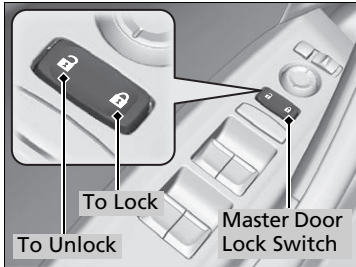

Press the master door lock switch in as shown to lock or unlock all the doors, fuel fill door and trunk.

## Childproof Door Locks

The childproof door locks prevent the rear doors from being opened from the inside regardless of the position of the lock tab.

### ■ Setting the Childproof Door Locks

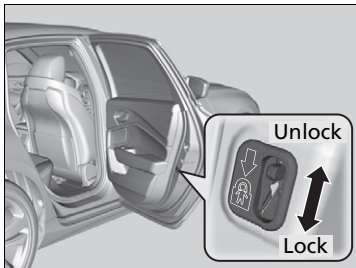

Slide the lever in the rear door to the lock position, and close the door.

#### ■ When opening the door

Open the door using the outside door handle.

### ☒ Using the Master Door Lock Switch

When you lock/unlock either front door using the master door lock switch, all the other doors, fuel fill door and trunk lock/unlock at the same time.

### ☒ Childproof Door Locks

To open the door from the inside when the childproof door lock is on, put the lock tab in the unlock position, lower the rear window, put your hand out of the window, and pull the outside door handle.

## Auto Door Locking/Unlocking

Your vehicle locks or unlocks all doors, fuel fill door and trunk automatically when a certain condition is met.

### ■ Auto Door Locking

#### ■ Drive lock mode

All doors, fuel fill door and trunk lock when the vehicle's speed reaches about 10 mph (15 km/h).

### ■ Auto Door Unlocking

#### ■ Driver's door open mode

All doors, fuel fill door and trunk unlock when the driver's door is opened.

#### ☒ Auto Door Locking/Unlocking

You can turn off or change to another auto door locking/unlocking setting using the audio/information screen.

☒ **Customized Features** P. 300

## Precautions for Closing the Trunk

### ■ Closing the trunk

Keep the trunk lid closed while driving to:

- ▶ Avoid possible damage.
  - ▶ Prevent exhaust gas from leaking into the vehicle.
- ☒ **Exhaust Gas Hazard** P. 75

## Using the Trunk Opener

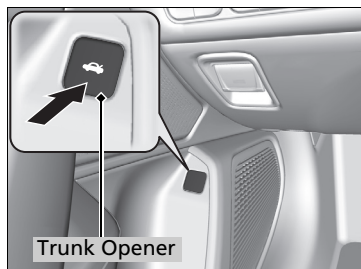

Pressing and holding the trunk opener on the driver's door unlocks and opens the trunk.

☒ **If You Cannot Open the Trunk** P. 614



## Using the Trunk Release Button

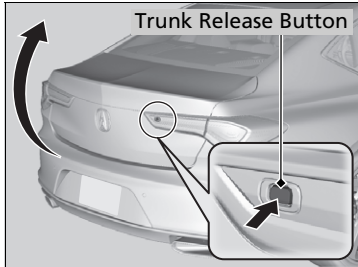

Press the release button on the right side trunk lid light after the doors are unlocked.

❗ **If You Cannot Open the Trunk** P. 614

Even if the trunk is locked, you can open the trunk if you carry the keyless access remote.

▶ Some exterior lights flash twice and the beeper sounds.

## Using the Remote Transmitter

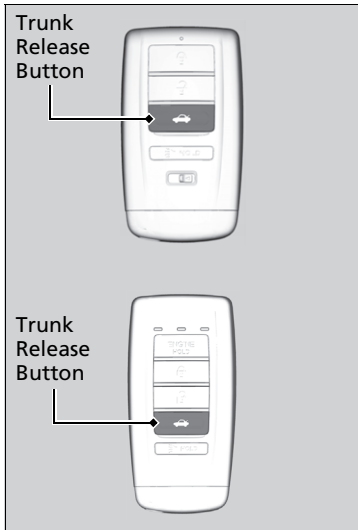

Press and hold the trunk release button for approximately one second to unlock and open the trunk.

### ⌘ Using the Trunk Release Button

- If you forget the remote inside the trunk, the beeper will sound and the trunk will not close.
- A person who is not carrying the keyless access remote can unlock the trunk if a person who is carrying it is within range or if all doors are unlocked.
- If the beeper sounds after you close the trunk, move the keyless access remote away from the trunk and close again.
- The keyless access remote may not operate if it is too close to the trunk.

When the vehicle is used in cold weather, the trunk release button could freeze up and using it may not be possible.

In this case, the trunk may be opened using the interior trunk opener or trunk release button on the remote transmitter.

### ⌘ Using the Remote Transmitter

If the driver's door is locked, the trunk will automatically lock when you close it. Otherwise, you will have to lock it manually.

- You can lock or unlock the trunk using the remote transmitter only when the power mode is in VEHICLE OFF.

## Trunk Main Switch

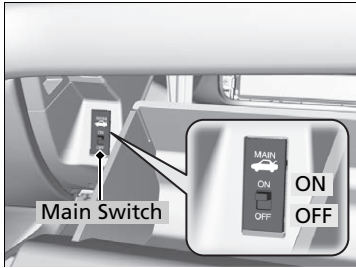

The trunk main switch disables the trunk release button on the remote transmitter, the trunk release button on the right side trunk lid light and trunk opener on the driver's door to protect cargo in the trunk.

1. Make sure the rear seat-back is not folded down.
2. Turn off the trunk main switch in the glove box.
3. Lock the glove box.

### Trunk Main Switch

If you need to give the key to someone else, remove the built-in key from the keyless access remote by sliding the release knob, and give the remote as a valet key.

## Emergency Trunk Opener

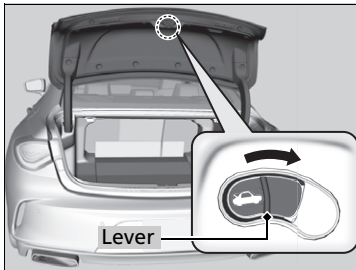

The trunk release lever allows you to open the trunk from inside for your safety.

Slide the release lever in the direction of the arrow.

### Emergency Trunk Opener

Parents should decide if their children should be shown how to use this feature.

## Immobilizer System

This system prevents a key that has not been preregistered from starting the engine.

Pay attention to the following when pressing the **ENGINE START/STOP** button:

- Do not allow objects that emit strong radio waves near the **ENGINE START/STOP** button.
- Make sure the key is not covered by or touching a metal object.
- Do not bring a key from another vehicle's immobilizer system near the **ENGINE START/STOP** button.
- Do not put the key near magnetic items. Electronic devices, such as televisions and audio systems emit strong magnetic fields. Note that even a key chain can become magnetic.

## Security System Alarm

The security system alarm activates when the trunk, hood or doors are forcibly opened. The alarm does not activate if the trunk or doors are opened with the key, remote transmitter or keyless access system.

However, the alarm activates if a door is opened with the key and then the hood is opened before the power mode is set to ON.

### ■ When the security system alarm activates

The horn sounds intermittently and some exterior lights flash.

### Immobilizer System

#### NOTICE

Leaving the key in the vehicle can result in theft or accidental movement of the vehicle. Always take the key with you whenever you leave the vehicle unattended.

Do not alter the system or add other devices to it. Doing so may damage the system and make your vehicle inoperable.

#### Canadian models

Apply and hold the brake pedal before turning the vehicle on the first time after the battery has been disconnected.

### Security System Alarm

Do not alter the system or add other devices to it. Doing so may damage the system and make your vehicle inoperable.

The security system alarm continues for a maximum of two minutes until the security system alarm deactivates.

### ■ To deactivate the security system alarm

Unlock the vehicle using the key, remote transmitter or keyless access system, or set the power mode to ON. The system, along with the horn and flashing lights, is deactivated.

### ■ Setting the security system alarm

The security system alarm automatically sets when the following conditions have been met:

- The power mode is set to VEHICLE OFF (LOCK).
- The hood is closed.
- All doors and the trunk are locked from outside with the key, remote transmitter or keyless access system.

### ■ When the security system alarm sets

The security system alarm indicator in the instrument panel blinks and the blinking interval changes after about 15 seconds.

### ■ To cancel the security system alarm

The security system alarm is canceled when the vehicle is unlocked using the remote transmitter or keyless access system, or when the power mode is set to ON. The security system alarm indicator goes off at the same time.

#### ⌘ Security System Alarm

Do not set the security system alarm when someone is in the vehicle or a window is open. The system can accidentally activate when:

- Unlocking the door with the lock tab.
- Opening the trunk with the trunk opener or the emergency trunk opener.
- Opening the hood with the hood release.

If the battery goes dead after you have set the security system alarm, the security alarm may go off once the battery is recharged or replaced. If this occurs, deactivate the security system alarm by unlocking a door using the key, remote transmitter or keyless access system.

## ■ Panic Mode

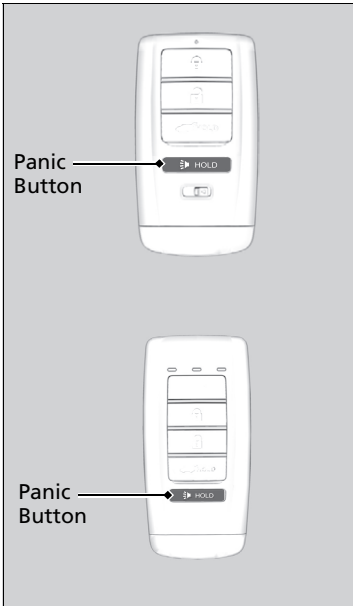

### ■ The panic button on the remote transmitter

If you press the panic button for approximately one second, the following will occur for about 30 seconds:

- The horn sounds.
- Some exterior lights flash.

### ■ Canceling panic mode

- Press any button on the remote transmitter.
- Set the power mode to ON.

## Opening/Closing the Power Windows

The power windows can be opened and closed when the power mode is in ON, using the switches on the doors.

The driver's side switches can be used to open and close all the windows. The power window lock button on the driver's side must be switched off (indicator off) to open and close the windows from anywhere other than the driver's seat.

When the power window lock button is pressed, the indicator comes on and you can only operate the driver's window. Turn the power window lock button on if a child is in the vehicle.

### Opening/Closing the Power Windows

#### **WARNING**

**Closing a power window on someone's hands or fingers can cause serious injury.**

**Make sure your passengers are away from the windows before closing them.**

The power windows can be operated for up to 10 minutes after you set the power mode to VEHICLE OFF (LOCK).  
Opening either front door cancels this function.

#### **Auto Reverse**

If a power window senses resistance when closing automatically, it will stop closing and reverse direction.

The driver's window auto reverse function is disabled when you continuously pull up the switch.

The auto reverse function stops sensing when the window is almost closed to ensure that it fully closes.

## ■ Opening/Closing the Windows with Auto-Open/Close Function

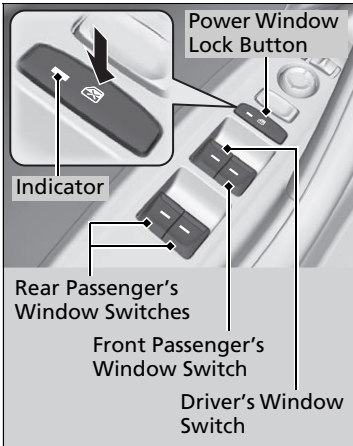

### ■ Manual operation

**To open:** Push the switch down lightly, and hold it until the desired position is reached.

**To close:** Pull the switch up lightly, and hold it until the desired position is reached.

### ■ Automatic operation

**To open:** Push the switch down firmly.

**To close:** Pull the switch up firmly.

The window opens or closes completely. To stop the window at any time, push or pull the switch briefly.

### ☒ Opening/Closing the Power Windows

While driving with any of the windows open, you may hear a booming, throbbing, or helicopter-type noise or pressure. This is called wind buffeting. This is a normal occurrence that can be minimized.

If you hear a wind buffeting noise with any of the windows open, lower all of the other windows slightly or open the moonroof.

### ■ Opening the Windows with the Remote

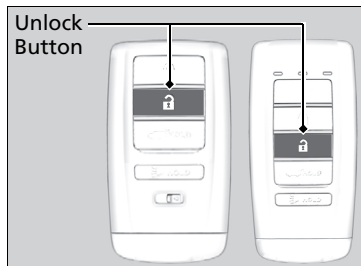

**To open:** Press the unlock button, and then within 10 seconds, press it again and hold it.

If the windows stop midway, repeat the procedure.

### ■ Opening/Closing the Windows with the Key

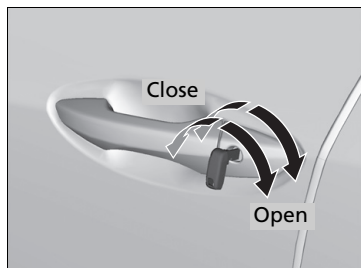

**To open:** Unlock the driver's door with the key. Within 10 seconds of returning the key to the central position, turn the key in the unlock direction and hold it there.

**To close:** Lock the driver's door with the key. Within 10 seconds of returning the key to the central position, turn the key in the lock direction and hold it there.

Release the key to stop the windows at the desired position. If you want further adjustment, repeat the same operation.

### ☒ Opening the Windows with the Remote

If you open the windows with the remote, the moonroof will open automatically along with them.

### ☒ Opening/Closing the Windows with the Key

If you open/close the windows with the key, the moonroof will open/close automatically along with them.



## Opening/Closing the Moonroof

You can only operate the moonroof when the power mode is in ON. Use the switch in the front of the ceiling to open and close the moonroof.

### Using the Moonroof Switch

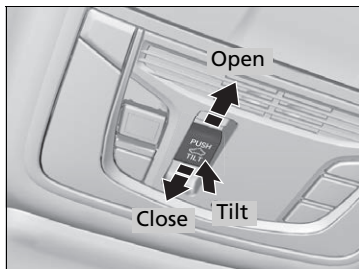

#### Automatic operation

**To open:** Pull the switch back firmly.

**To close:** Push the switch forward firmly.

The moonroof automatically opens or closes all the way. To stop the moonroof midway, pull or push the switch briefly.

#### Manual operation

**To open:** Pull the switch back lightly, and hold it until the desired position is reached.

**To close:** Push the switch forward lightly, and hold it until the desired position is reached.

#### Tilting the moonroof up

**To tilt:** Push on the center of the moonroof switch.

**To close:** Push the switch forward firmly, then release.

### Using the Moonroof Switch

## WARNING

Opening or closing the moonroof on someone's hands or fingers can cause serious injury.

Make sure all hands and fingers are clear of the moonroof before opening or closing it.

### NOTICE

Opening the moonroof in below freezing temperature or when it is covered with snow or ice can damage the moonroof panel or motor.

The moonroof can be operated for up to 10 minutes after you set the power mode to VEHICLE OFF (LOCK). Opening either front door cancels this function.

When resistance is detected, the auto reverse function causes the moonroof to change directions, then stop. Auto reverse stops sensing when the moonroof is almost closed to ensure that it fully closes. Make sure that all objects, including fingers, are clear of the moonroof.

You can use the remote transmitter or the key to operate the moonroof.

➤ **Opening the Windows with the Remote**  
P. 142

➤ **Opening/Closing the Windows with the Key** P. 142

## ENGINE START/STOP Button

### ■ Changing the Power Mode

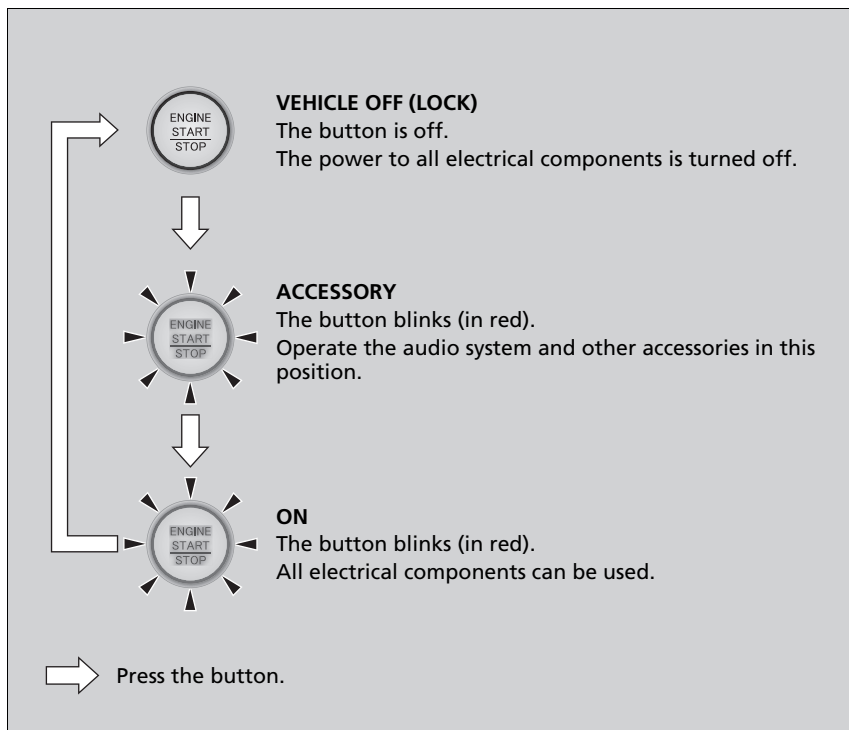

### ▣ ENGINE START/STOP Button

#### ENGINE START/STOP Button Operating Range

You can start the engine when the keyless access remote is inside the vehicle.

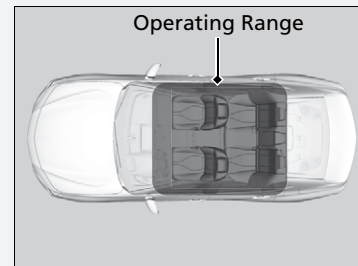

The engine may also run if the keyless access remote is close to the door or window, even if it is outside the vehicle.

ON mode:

The **ENGINE START/STOP** button is on (in red), if the engine is running.

If the battery of the keyless access remote is getting low, the engine may not start when you press the **ENGINE START/STOP** button. If the engine does not start, refer to the following link.

▣ **If the Keyless Access Remote Battery is Weak** P. 591

Do not leave the power mode in ACCESSORY or ON when you get out.

### ■ Automatic Power Off

If you leave the vehicle for 30 to 60 minutes with the transmission in **P** and the power mode in ACCESSORY, the vehicle automatically goes into the mode similar to VEHICLE OFF (LOCK) to avoid draining the battery.

### ■ Power Mode Reminder

If you open the driver's door when the power mode is set to ACCESSORY, a warning beep sounds.

## ■ Keyless Access Remote Reminder

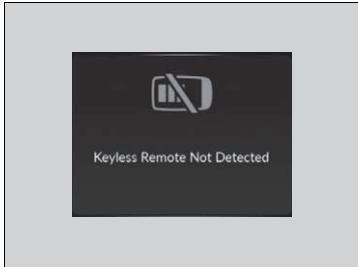

When the power mode is set to any mode other than OFF and you remove the keyless access remote from the vehicle and shut the door, an alarm will sound. If the alarm continues to sound, place the keyless access remote in another location.

### ■ When the power mode is in ACCESSORY

The alarm will sound from outside the vehicle.

### ■ When the power mode is in ON

An alarm will sound both inside and outside the vehicle. In addition, a warning indicator will appear on the instrument panel.

## ⊠ Keyless Access Remote Reminder

When the keyless access remote is within the system's operational range, and the driver's door is closed, the warning function cancels.

If the keyless access remote is taken out of the vehicle after the engine has been started, you can no longer change the **ENGINE START/STOP** button mode or restart the engine. Always make sure if the remote is in your vehicle when you operate the **ENGINE START/STOP** button.

Removing the keyless access remote from the vehicle through a window does not activate the warning buzzer.

Do not put the keyless access remote on the dashboard or in the glove box. It may cause the warning buzzer to go off. Under some other conditions that can prevent the vehicle from locating the remote, the warning buzzer may also go off even if the remote is within the system's operational range.

## Turn Signals

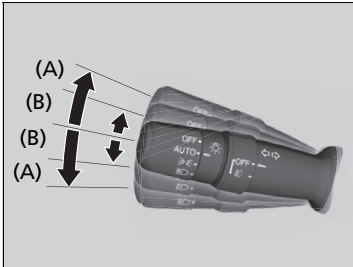

The turn signals can be used when the power mode is in ON.

### ■ (A): Turn signal

Push the lever up or down based on the direction you want to turn, and the turn signal will blink.

### ■ (B): One-touch turn signal

When you lightly push the lever up or down and release it, the turn signal will blink 3 times.

### ⊗(A): Turn signal

The turn signal indicator on the instrument panel will blink when the external turn signal blinks.

➤ **Indicators** P. 78

## Light Switches

### Manual Operation

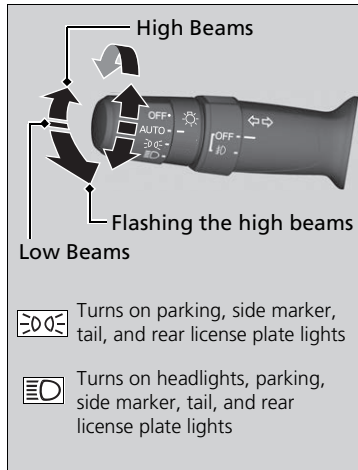

Rotating the light switch turns the lights on and off, regardless of the power mode setting.

#### High beams

Push the lever forward until you hear a click.

#### Low beams

When in high beams, pull the lever back to return to low beams.

#### Flashing the high beams

Pull the lever back, and release it.

#### Lights off

Turn the lever to **OFF** either when:

- The transmission is in **P**.
- The parking brake is applied.

To turn the lights on again, turn the lever to **OFF** to cancel the lights off mode. Even if you do not cancel the lights off mode, the lights come on automatically when:

- The transmission is taken out of **P** and the parking brake is released.
- The vehicle starts to move.

### Light Switches

If you leave the power mode in VEHICLE OFF (LOCK) while the lights are on, a chime sounds when the driver's door is opened.

When the lights are on, the lights on indicator in the instrument panel will be on.

#### Lights On Indicator P. 90

Do not leave the lights on when the engine is off because it will cause the battery to discharge.

If you sense that the level of the headlights is abnormal, have the vehicle inspected by a dealer.

## Automatic Operation (automatic lighting control)

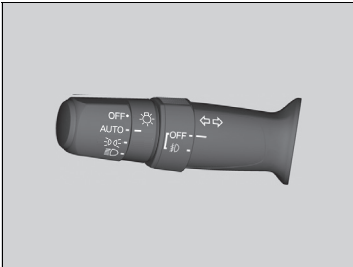

Automatic lighting control can be used when the power mode is in ON.

When the light switch is in **AUTO**, the headlights and other exterior lights will switch on and off automatically depending on the ambient brightness.

The headlights come on when you unlock a door in dark areas with the headlight switch in **AUTO**.

- ▶ Once you lock the door, the headlights will go off.

## Automatic Operation (automatic lighting control)

We recommend that you turn on the lights manually when driving at night, in a dense fog, or in dark areas such as long tunnels or parking facilities.

The light sensor is in the location shown below. Do not cover this light sensor with anything; otherwise, the automatic lighting system may not work properly.

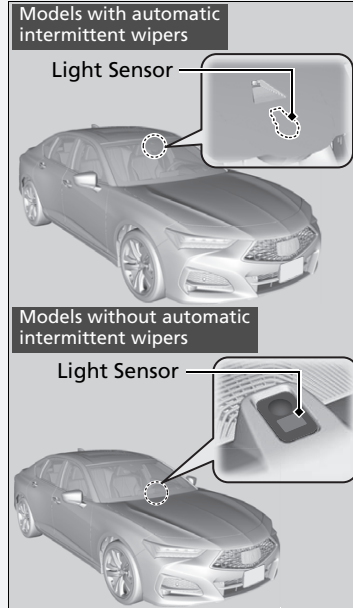

### ■ Headlight Integration with Wipers

The headlights automatically come on when the wipers are used several times within a certain number of intervals with the headlight switch in **AUTO**.

The headlights automatically go off a few minutes later if the wipers are stopped.

### ■ Automatic Lighting Off Feature

The headlights, all other exterior lights, and the instrument panel lights turn off 15 seconds after you set the power mode to VEHICLE OFF (LOCK), take the remote with you, and close the driver's door.

If you set the power mode to VEHICLE OFF (LOCK) with the headlight switch on, but do not open the door, the lights turn off after 10 minutes (3 minutes, if the switch is in the **AUTO** position).

The lights turn on again when you unlock or open the driver's door. If you unlock the door, but do not open it within 15 seconds, the lights go off. If you open the driver's door, you will hear a reminder chime alerting you that the lights are on.

#### ⌘ Automatic Operation (automatic lighting control)

##### U.S. models

You can adjust the auto light sensitivity as follows:

Setting	The exterior lights come on when the ambient light is at
Max	 Bright
High	
Mid	
Low	
Min	

➤ **Customized Features** P. 300

#### ⌘ Headlight Integration with Wipers

This feature activates while the headlights are off in **AUTO**.

The instrument panel brightness does not change when the headlights come on.

At dark ambient light levels, the automatic lighting control feature turns on the headlights, regardless of the number of wiper sweeps.

#### ⌘ Automatic Lighting Off Feature

You can change the headlight auto off timer setting.

➤ **Customized Features** P. 300



## Fog Lights\*

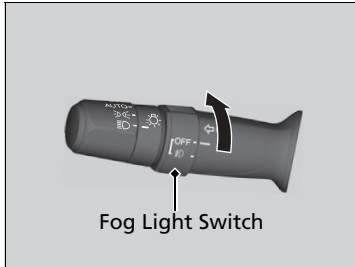

When the low beam headlights are on, turn the fog light switch on to use the fog lights.

## Daytime Running Lights

The parking/daytime running lights come on when the following conditions have been met:

- The power mode is in ON.
- The headlight switch is in **AUTO**.
- The parking brake is released.

The lights remain on even if you set the parking brake.

Setting the power mode to VEHICLE OFF (LOCK) will turn off the daytime running lights.

The daytime running lights are off once the headlight switch is turned on, or when the headlight switch is in **AUTO** and it is getting darker outside.

\* Not available on all models

## Auto High-Beam

The front sensor camera detects the light sources ahead of the vehicle such as the lights of a preceding or oncoming vehicle, or street lights. When you are driving at night, the system automatically switches the headlights between low beam and high beam depending on the situation.

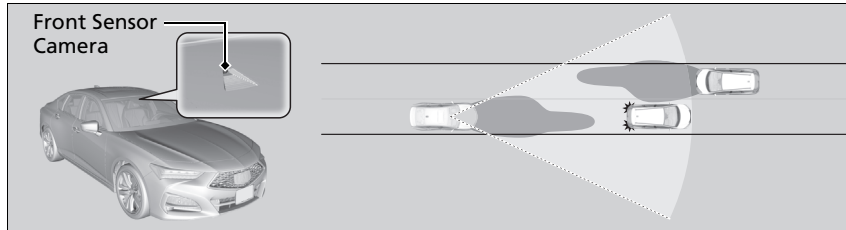

### How to Use the Auto High-Beam

When all of the following conditions have been met, the auto high-beam indicator comes on and the auto high-beam is activated.

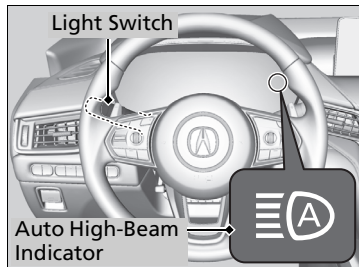

- The power mode is in ON.
- The light switch is in **AUTO**.
- The lever is in the low beam position.
- The headlights have been automatically activated.
- It is dark outside the vehicle.

If the auto high-beam indicator does not come on even when all the conditions have been met, carry out the following procedure and the indicator will come on.

- Pull the lever toward you for flashing the high beams then release it while driving.

### Auto High-Beam

The auto high-beam system does not always operate in every situation. This system is just for assisting the driver. Always observe your surroundings and switch the headlights between high beam and low beam manually if necessary.

If you find the timing of beam changes inconvenient for driving, change the headlight beams manually.

The range and the distance at which the camera can recognize varies depending on conditions surrounding your vehicle.

Regarding the handling of the camera mounted to the inside of the windshield, refer to the following.

#### Front Sensor Camera P. 480

For the auto high-beam to work properly:

- Do not place an object that reflects light on the dashboard.
- Keep the windshield around the camera clean.
- When cleaning the windshield, be careful not to apply windshield cleanser to the camera lens.
- Do not attach an object, sticker or film to the area around the camera.
- Do not touch the camera lens.

If the camera receives a strong impact, or repairing of the area near the camera is required, consult a dealer.

### ■ Automatic switching between high-beam and low-beam

When auto-high beam is active, the headlights switch between high beam and low beam based on the following conditions.

#### Switching to high beam:

All of the following conditions must be met before the high beams turn on.

- Your vehicle speed is 25 mph (40 km/h) or more.
- There are no preceding or oncoming vehicle with headlights or taillights turned on.
- There are few street lights on the road ahead.



#### Switching to low beam:

One of the following conditions must be met before the low beams turn on.

- Your vehicle speed is 15 mph (24 km/h) or less.
- There is a preceding or oncoming vehicle with headlights or taillights turned on.
- There are many street lights on the road ahead.

### ■ Manual switching between high-beam and low-beam

If you want to manually switch the headlights between high beam and low beam, follow either of the procedures below. Note that when you do this, the auto high-beam indicator will turn off and the auto high-beam will be deactivated.

#### Using the lever:

Pull the lever toward you for flashing the high beams then release it within about one second while driving.

- ▶ To reactivate the auto high-beam, pull the lever toward you for flashing the high beams then release it while driving. The auto high-beam indicator will come on.

#### Using the light switch:

Turn the light switch to .

- ▶ To reactivate the auto high-beam, turn the light switch to **AUTO** when the lever is in the low beam position, the auto high-beam indicator will come on.

#### ⊠ How to Use the Auto High-Beam

In the following cases, the auto high-beam system may not switch the headlights properly or the switching timing may be changed. In case of the automatic switching operation does not fit for your driving habits, please switch the headlights manually.

- The brightness of the lights from the preceding or oncoming vehicle is intense or poor.
- Visibility is poor due to the weather (rain, snow, fog, windshield frost, etc.).
- Surrounding light sources, such as street lights, electric billboards and traffic lights are illuminating the road ahead.
- The brightness level of the road ahead constantly changes.
- The road is bumpy or has many curves.
- A vehicle suddenly appears in front of you, or a vehicle in front of you is not in the preceding or oncoming direction.
- Your vehicle is tilted with a heavy load in the rear.
- A traffic sign, mirror, or other reflective object ahead is reflecting strong light toward the vehicle.
- The oncoming vehicle frequently disappears under roadside trees or behind median barriers.
- The preceding or oncoming vehicle is a motorcycle, bicycle, mobility scooter, or other small vehicle.

The auto high-beam system keeps the headlight low beam when:

- Windshield wipers are operating at a high speed.
- The camera has detected a dense fog.

## ■ How to Turn Off the Auto High-Beam

You can turn the auto high-beam system off. If you want to turn the system off or on, set the power mode to ON, then carry out the following procedures while the vehicle is stationary.

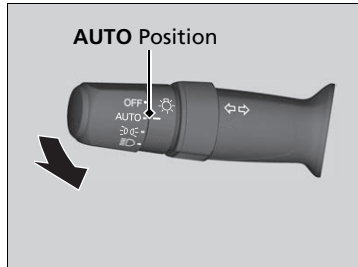

### To turn the system off:

With the light switch is in **AUTO**, pull the lever toward you and hold it for at least 40 seconds. After the auto high-beam indicator light blinks twice, release the lever.

### To turn the system on:

With the light switch is in **AUTO**, pull the lever toward you and hold it for at least 30 seconds. After the auto high-beam indicator light blinks once, release the lever.

## ☒ How to Use the Auto High-Beam

If the **Some Driver Assist Systems Cannot Operate: Camera Temperature Too High** message appears:

- Use the climate control system to cool down the interior and, if necessary, also use defroster mode with the airflow directed toward the camera.
- Start driving the vehicle to lower the windshield temperature, which cools down the area around the camera.

If the **Some Driver Assist Systems Cannot Operate: Clean Front Windshield** message appears:

- Park your vehicle in a safe place, and clean the windshield. If the message does not disappear after you have cleaned the windshield and driven for a while, have your vehicle checked by a dealer.

## ☒ How to Turn Off the Auto High-Beam

If you turn the auto high-beam system off, the system does not operate until you turn the system on.

Park in a safe place before turning the system off or on.

## Wipers and Washers

### Windshield Wipers/Washers

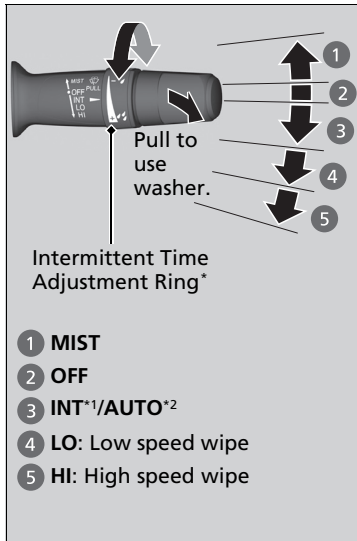

The windshield wipers and washers can be used when the power mode is in ON.

#### ■ MIST

The wipers run at high speed until you release the lever.

#### ■ Wiper switch (OFF, INT\*<sup>1</sup>/AUTO\*<sup>2</sup>, LO, HI)

Move the lever up or down to change the wiper settings.

#### ■ Adjusting wiper operation\*

Turn the adjustment ring to adjust the wiper operation.



Lower speed, fewer sweeps

Higher speed, more sweeps

#### ■ Washer

Sprays while you pull the lever toward you. When you release the lever for more than one second, the spray stops, the wipers sweep two or three more times to clear the windshield, then stop.

\*1: Models with manual intermittent operation

\*2: Models with automatic intermittent operation

\* Not available on all models

### Wipers and Washers

#### NOTICE

Do not use the wipers when the windshield is dry. The windshield will get scratched, or the rubber blades will get damaged.

#### NOTICE

Turn the washers off if no washer fluid comes out. The pump may get damaged.

The wiper motor may stop motor operation temporarily to prevent an overload. Wiper operation will return to normal within a few minutes, once the circuit has returned to normal.

#### Models with intermittent time adjustment ring

If the vehicle speeds up while the wipers are operating intermittently, the length of the wipe interval shortens.

When the vehicle speeds up, the wiper operation's shortest delay setting  and the LO setting become the same.

#### NOTICE

In cold weather, the blades may freeze to the windshield. Operating the wipers in this condition may damage the wipers. Use the defroster or heated windshield\* to warm the windshield, then turn the wipers on.

## ■ Automatic Intermittent Wipers\*

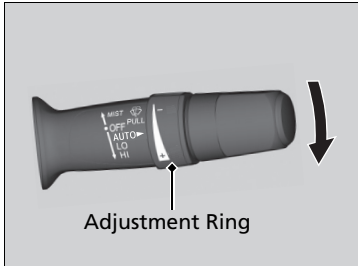

When you push the lever down to **AUTO**, the windshield wipers sweep once, and go into the automatic mode.

The wipers operate intermittently, at low speed, or at high speed and stops in accordance with the amount of rainfall the rainfall sensor detects.

### ■ AUTO sensitivity adjustment

When the wiper function is set to **AUTO**, you can adjust the sensitivity of the rainfall sensor (using the adjustment ring) so that wipers will operate in accordance with your preference.

#### Sensor sensitivity

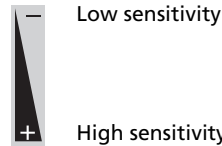

## ⌘ Wipers and Washers

If the wipers stop operating due to an obstacle such as the build-up of snow, park the vehicle in a safe place.

Rotate the wiper switch to **OFF**, and set the power mode to **ACCESSORY** or **VEHICLE OFF (LOCK)**, then remove the obstacle.

## ⌘ Automatic Intermittent Wipers\*

The rainfall sensor is in the location shown below.

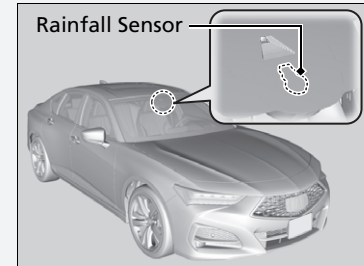

### NOTICE

**AUTO** should always be turned **OFF** before the following situations in order to prevent severe damage to the wiper system:

- Cleaning the windshield
- Driving through a car wash
- No rain present

## Brightness Control

### ■ Adjusting the Instrument Panel Brightness

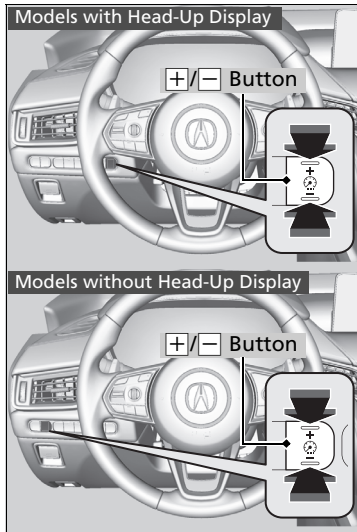

When the power mode is in ON, you can use the  $\oplus$  or  $\ominus$  button to adjust instrument panel brightness.

**Brighten:** Press the  $\oplus$  button.

**Dim:** Press the  $\ominus$  button.

You will hear a beep when the brightness reaches minimum or maximum. Several seconds after adjusting the brightness, you will be returned to the previous display.

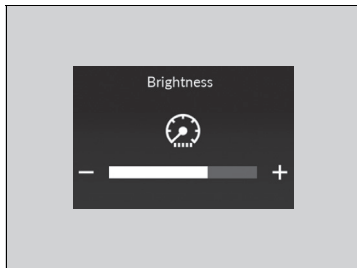

### ■ Brightness level indicator

The brightness level is shown on the display while you are adjusting it.

### ▶▶ Brightness Control

The brightness of the instrument panel will be reduced when the following conditions:

- The power mode is in ON.
- The light switch is in any position other than off and it is dark outside.

The brightness can be set differently for when the exterior lights are on, and when they are off.

## ■ Adjusting the Head-Up Display Brightness\*

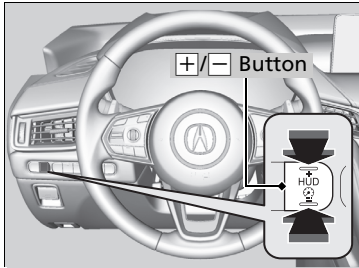

When the power mode is in ON, you can use the  button to adjust head-up display brightness.

**Brighten:** Press the  button.

**Dim:** Press the  button.

The head-up display will return to its original state several seconds after adjusting the brightness.

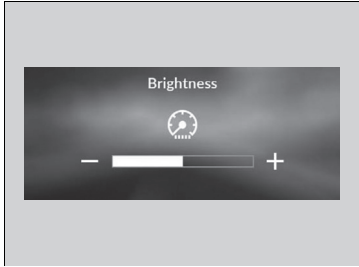

### ■ Brightness level indicator

The brightness level is shown on the display while you are adjusting it.



## Rear Defogger/Heated Door Mirror Button

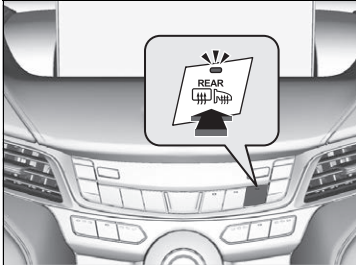

Press the rear defogger and heated door mirror button to defog the rear window and mirrors when the power mode is in ON.

The rear defogger and heated door mirrors automatically switch off after 10-30 minutes depending on the outside temperature.

## Heated Windshield Button \*

Press the heated windshield button to deice the windshield at the wiper park area and along the driver side edge of the windshield when the power mode is in ON.

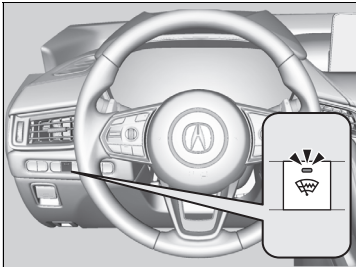

The heated windshield will automatically switch off after 15 minutes.

### ⌘ Rear Defogger/Heated Door Mirror Button

This system consumes a lot of power, so turn it off when the window has been defogged. Also, do not use the system for a long time while the engine is idling. This may weaken the battery, making it difficult to start the engine.

When the power mode is set to ON and the outside temperature is below 41°F (5°C), the heated door mirror may automatically activate for 10 minutes.

### ⌘ Heated Windshield Button \*

This system consumes a lot of power, so turn it off when the window has been deiced. Also, do not use the system for a long period when the engine is idling. This may weaken the battery, making it difficult to start the engine.

When the power mode is set to ON and the outside temperature is below 39°F (4°C), the heated windshield may automatically activate for up to 15 minutes.

\* Not available on all models

## Driving Position Memory System

You can store two driver's seat and outside mirrors position with the driving position memory system.

When you unlock and open the driver's door with a remote transmitter, or keyless access system, door mirrors adjust to one of the two preset positions and the seat adjusts to retracted positions of one of the two preset positions automatically.

The seat will move to the stored position when you set the power mode to ACCESSORY.

- **DRIVER 1** transmitter is linked to memory button 1.
- **DRIVER 2** transmitter is linked to memory button 2.

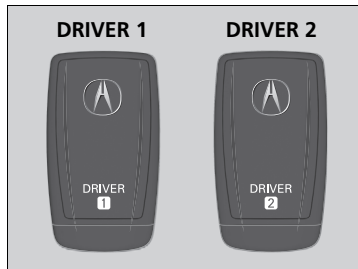

The driver's seat moves rearward depending on the set seating position once you

- Stop the vehicle.
- Put the transmission in **P**.
- Turn the engine off.
- Then open the driver's door.

Once the power mode is in the ACCESSORY position, the driver's seat moves forward to the **DRIVER 1** or **2** preset position.

### ▶▶ Driving Position Memory System

Using the audio/information screen, you can disable the automatic seat adjustment function.

▶ **Customized Features** P. 300

The driver's seat easy exit feature can be turned ON/OFF.

▶ **Customized Features** P. 300

### System Operation

The system will not operate if:

- The vehicle is moving.
- Either memory position button is pressed while the seat is in motion.
- The seat position is adjusted while in operation.
- The memory 1 or 2 position is set fully to the rear.

### Models with mode selector

- The mode selector is pressed up or down while in operation.

## ■ Storing a Position in Memory

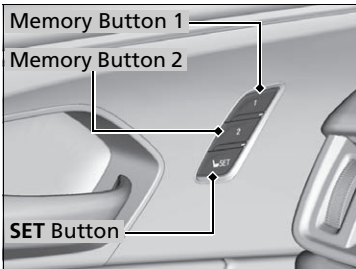

1. Set the power mode to ON. Adjust the driver's seat and door mirrors to the desired position.
2. Press the **SET** button.
  - ▶ The memory button indicator lights will blink.
3. Press and hold memory button **1** or **2** within five seconds of pressing the **SET** button.
  - ▶ Once the seat and the door mirror positions have been memorized, the indicator light on the button you pressed stays on and you will hear the double-beep.

## ■ Recalling the Stored Position

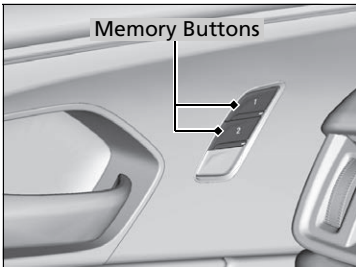

1. Put the transmission into **P**.
2. Press a memory button (**1** or **2**).
  - ▶ The indicator light will blink.

The seat and the door mirrors will automatically move to the memorized positions. When they have finished moving, the indicator light stays on.

## ⌘ Storing a Position in Memory

After you press the **SET** button, the storing operation will be canceled when:

- You do not press the memory button within five seconds.
- You readjust the seat or the door mirror position before the double-beep.
- You set the power mode to any position except ON.

### Models with mode selector

- You press the mode selector up or down.

## ⌘ Recalling the Stored Position

The seat and the door mirrors will stop moving if you:

- Press the **SET** button or memory button **1** or **2**.
- Adjust the seat position or door mirrors.
- Put the transmission into a position other than **P**.

### Models with mode selector

- You press the mode selector up or down.

## Adjusting the Steering Wheel

The steering wheel height and distance from your body can be adjusted so that you can comfortably grip the steering wheel in an appropriate driving posture.

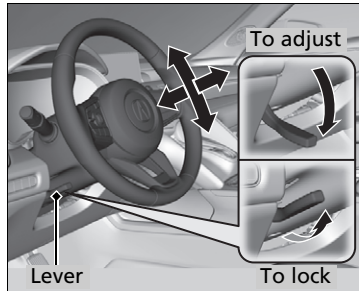

1. Push the steering wheel adjustment lever down.
  - ▶ The steering wheel adjustment lever is under the steering column.
2. Move the steering wheel up or down, and in or out.
  - ▶ Make sure you can see the instrument panel gauges and indicators.
3. Pull the steering wheel adjustment lever up to lock the steering wheel in position.
  - ▶ After adjusting the position, make sure you have securely locked the steering wheel in place by trying to move it up, down, in, and out.

### Adjusting the Steering Wheel

#### **⚠ WARNING**

Adjusting the steering wheel position while driving may cause you to lose control of the vehicle and be seriously injured in a crash.



Adjust the steering wheel only when the vehicle is stopped.

## Interior Rearview Mirror

Adjust the angle of the rearview mirror when you are sitting in the correct driving position.

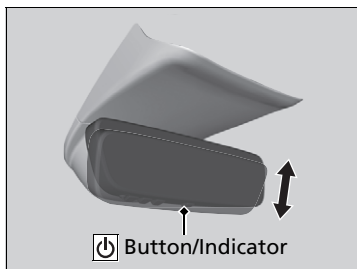
### Automatic Dimming Power Door Mirrors\* and Rearview Mirror



When you are driving after dark, the automatic dimming rearview mirror and power door mirrors reduce the glare from headlights behind you. Press the  button to turn this function on and off. When activated, the  indicator comes on.

\* Not available on all models

#### Mirrors

Keep the inside and outside mirrors clean and adjusted for best visibility.

Adjust the mirrors before you start driving.

➤ **Front Seats** P. 166

#### Automatic Dimming Power Door Mirrors\* and Rearview Mirror

The auto dimming function cancels when the transmission is in **R**.

## Power Door Mirrors

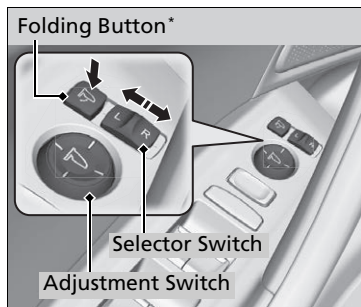

You can adjust the door mirrors when the power mode is in ON.

### ■ Mirror position adjustment

**L/R selector switch:** Select the left or right mirror. After adjusting the mirror, return the switch to the center position.

**Mirror position adjustment switch:** Press the switch left, right, up, or down to move the mirror.

### ■ Folding door mirrors\*

Press the folding button to fold the door mirrors in or out.

## ■ Reverse Tilt Door Mirror

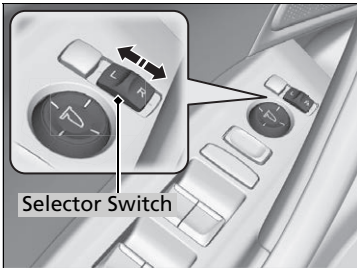

If activated, either side door mirror automatically tilts downward when you put the vehicle into **R**; this improves close-in visibility on the selected side of the vehicle when backing up. The mirror automatically returns to its original position when you take the vehicle out of **R**.

To activate this feature, set the power mode to ON and slide the selector switch to the left or right side.

To deactivate this feature, move selector switch to middle position.

## ■ Automatic Folding Door Mirror Function\*

### ■ Folding in the door mirrors

Lock all doors from outside the vehicle.

- ▶ The mirrors start folding in automatically.
- **Locking and Unlocking the Doors** P. 118

### ■ Folding out the door mirrors

Unlock the driver's or all doors from outside the vehicle.

- ▶ The mirrors start folding out automatically.
- **Locking and Unlocking the Doors** P. 118

### ⊞ Automatic Folding Door Mirror Function\*

Door mirrors will not unfold automatically if fold button is pressed.

- **Folding door mirrors\*** P. 164

You can turn the automatic folding door mirror function on and off.

- **Customized Features** P. 300

Door mirrors will not fold automatically when locking from inside the vehicle using lock tab or master door lock switch.

\* Not available on all models

## Front Seats

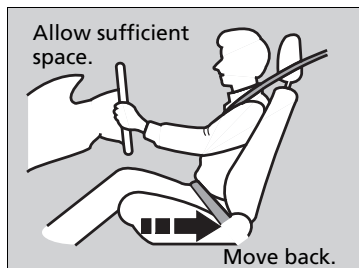

Adjust the driver's seat as far back as possible while allowing you to maintain full control of the vehicle. You should be able to sit upright, well back in the seat and be able to adequately press the pedals without leaning forward, and grip the steering wheel comfortably. The passenger's seat should be adjusted in a similar manner, so that it is as far back from the front airbag in the dashboard as possible.

### Seats

Always make seat adjustments before driving.

### Front Seats

## WARNING

Sitting too close to a front airbag can result in serious injury or death if the front airbags inflate.

Always sit as far back from the front airbags as possible while maintaining control of the vehicle.

The National Highway Traffic Safety Administration and Transport Canada recommend that drivers allow at least 10 inches (25 cm) between the center of the steering wheel and the chest.

## Adjusting the Seat Positions

### Adjusting the front power seats

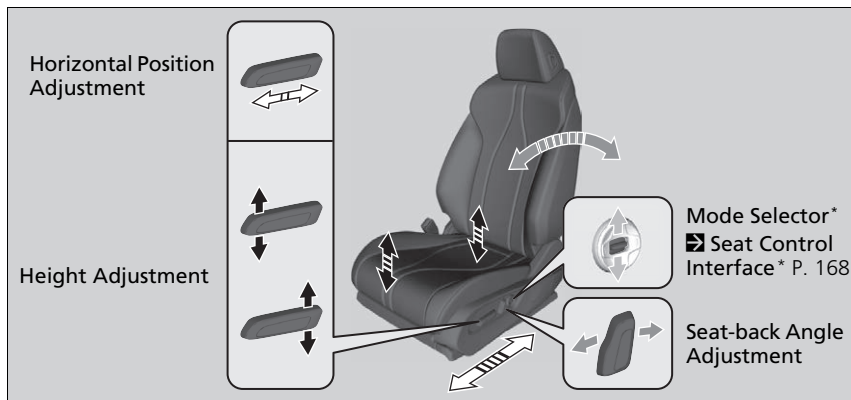



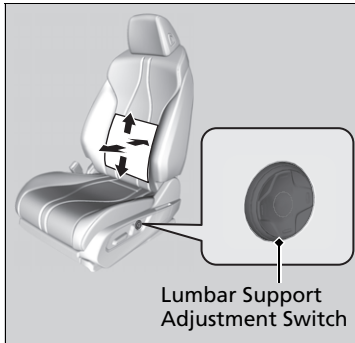

**Models without mode selector**

■ **Lumbar Support Adjustment Switch**

**Press the top:** To move the lumbar support up.

**Press the bottom:** To move the lumbar support down.

**Press the front:** To increase the entire lumbar support.

**Press the rear:** To decrease the entire lumbar support.

## ■ Seat Control Interface\*

Press the mode selector up or down to display seat adjustment information on the audio/information screen, and then use the adjustment switch to adjust the lumbar support, bolster support or thigh support.

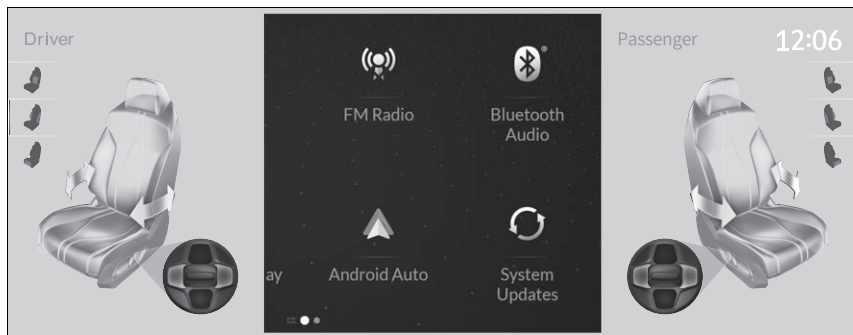

## ▶▶ Seat Control Interface\*

The image of each adjustment mode displayed on the audio/information screen:

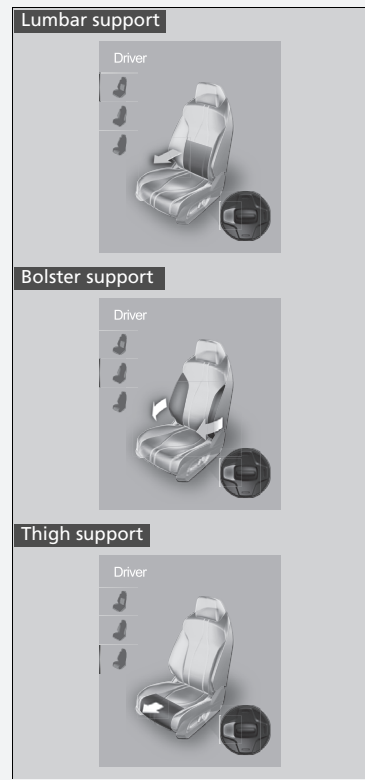

1. Press the mode selector up or down to select the lumbar support adjustment mode, bolster support adjustment mode or thigh support adjustment mode.
2. Press the adjustment switch as follow.

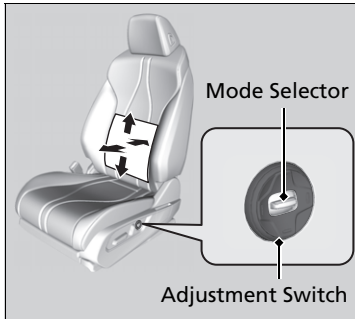

**To adjust the lumbar support:**

**Press the top:** To move the lumbar support up.

**Press the bottom:** To move the lumbar support down.

**Press the front:** To increase the entire lumbar support.

**Press the rear:** To decrease the entire lumbar support.

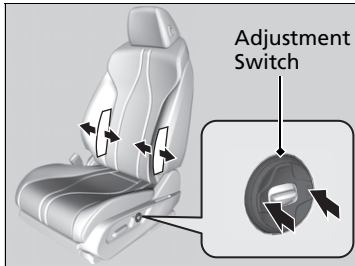

**To adjust the bolster support:**

**Press the front:** To increase the bolster support.

**Press the rear:** To decrease the bolster support.

►► Seat Control Interface\*

The lumbar support, bolster support and thigh support can be adjusted even when the power mode is in VEHICLE OFF. However, the adjusting mode display does not come on with the power mode in VEHICLE OFF.

\* Not available on all models

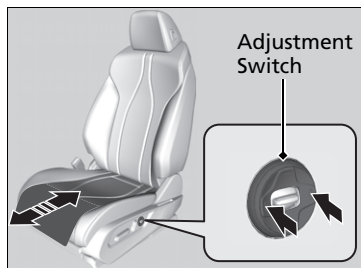

**To adjust the thigh support:**

**Press the front:** The tucked-down seat cushion end rolls out to support your thighs.

**Press the rear:** The tucked-down seat cushion end rolls in to support your thighs.

3. To close the adjusting mode display, hover over the A and/or B-zone touchpad, then press the True Touchpad Interface.
  - When you want to close the driver's side adjusting mode display, hover over and press the A-zone touchpad.
  - When you want to close the passenger's side adjusting mode display, hover over and press the B-zone touchpad.

## ■ Adjusting the Seat-Backs

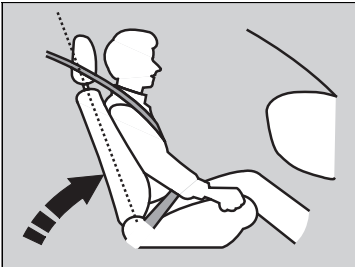

Adjust the driver's seat-back to a comfortable, upright position, leaving ample space between your chest and the airbag cover in the center of the steering wheel.

The front seat passenger should also adjust their seat-back to a comfortable, upright position.

Reclining a seat-back so that the shoulder part of the belt no longer rests against the occupant's chest reduces the protective capability of the belt. It also increases the chance of sliding under the belt in a crash and being seriously injured. The farther a seat-back is reclined, the greater the risk of injury.

## ⓘ Adjusting the Seat-Backs

### ⚠ WARNING

Reclining the seat-back too far can result in serious injury or death in a crash.

Adjust the seat-back to an upright position, and sit well back in the seat.

Do not put a cushion, or other object, between the seat-back and your back. Doing so may interfere with proper seat belt or airbag operation.

If you cannot get far enough away from the steering wheel and still reach the controls, we recommend that you investigate whether some type of adaptive equipment may help.

## Head Restraints

Your vehicle is equipped with head restraints in all seating positions.

### ■ Adjusting the Head Restraint Positions

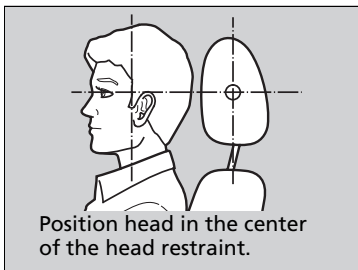

Head restraints are most effective for protection against whiplash and other rear-impact crash injuries when the center of the back of the occupant's head rests against the center of the restraint. The tops of the occupant's ears should be level with the center height of the restraint.

### ⌘ Head Restraints

#### **⚠ WARNING**

Improperly positioning head restraints reduces their effectiveness and increases the likelihood of serious injury in a crash.

**Make sure head restraints are in place and positioned properly before driving.**

In order for the head restraint system to work properly:

- Do not hang any items on the head restraints, or from the restraint legs.
- Do not place any objects between an occupant and the seat-back.
- Install each restraint in its proper location.

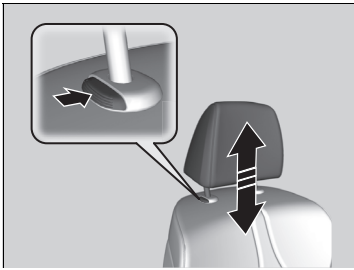

**To raise the head restraint:** Pull it upward.

**To lower the head restraint:** Push it down while pressing the release button.

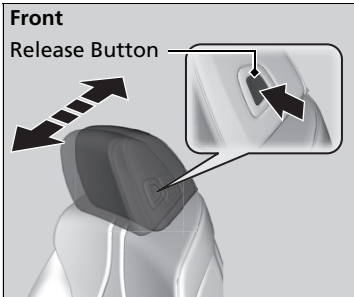

**Front**

**Release Button**

**To adjust the front head restraint forward:**

Push the back of it forward.

**To return the front head restraint to the original position:**

Press the release button.

## ■ Removing and Reinstalling the Head Restraints

Head restraints can be removed for cleaning or repair.

### To remove a head restraint:

Pull the restraint up as far as it will go. Then push the release button, and pull the restraint up and out.

### To reinstall a head restraint:

Insert the legs back in place, then adjust the head restraint to an appropriate height while pressing the release button. Pull up on the restraint to make sure it is locked in position.

## ✎ Removing and Reinstalling the Head Restraints

### **WARNING**

Failure to reinstall, or correctly reinstall, the head restraints can result in severe injury during a crash.

Always replace the head restraints before driving.



## Maintain a Proper Sitting Position

After all occupants have adjusted their seats and head restraints, and put on their seat belts, it is very important that they continue to sit upright, well back in their seats, with their feet on the floor, until the vehicle is safely parked and the engine is off.

Sitting improperly can increase the chance of injury during a crash. For example, if an occupant slouches, lies down, turns sideways, sits forward, leans forward or sideways, or puts one or both feet up, the chance of injury during a crash is greatly increased.

In addition, an occupant who is out of position in the front seat can be seriously or fatally injured in a crash by striking interior parts of the vehicle or being struck by an inflating front airbag.

### ⓘ Maintain a Proper Sitting Position

#### **WARNING**

**Sitting improperly or out of position can result in serious injury or death in a crash.**

**Always sit upright, well back in the seat, with your feet on the floor.**

## Rear Seats

### ■ Folding Down the Rear Seats

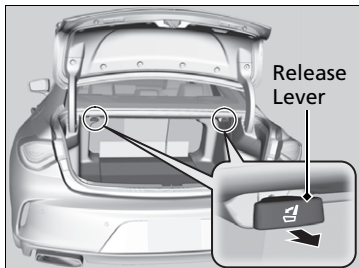

1. Pull the release lever in the trunk to release the lock.

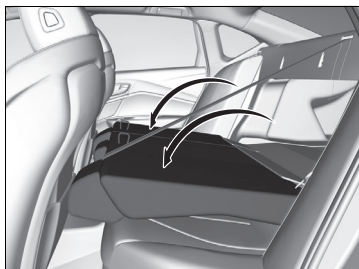

2. Fold the seat-back down.

If the rear head restraints get caught on the front seat-backs, remove the head restraints.

➤ **Removing and Reinstalling the Head Restraints** P. 174

### ☒ Folding Down the Rear Seats

The rear seat-backs can be folded down to accommodate bulkier items in the trunk.

Never drive with a seat-back folded down and the trunk lid open.

➤ **Exhaust Gas Hazard** P. 75

To lock the seat-back upright, push it backwards until it locks.

When returning the seat-back to its original position, push it firmly back. Also, make sure all rear shoulder belts are positioned in front of the seat-back, and the center shoulder belt is positioned in the guide.

Make sure that the folded seat-back does not press against the front passenger seat, as this can cause the weight sensors in the front passenger seat to work improperly.

➤ **Passenger Front Airbag Off Indicator** P. 58

**Make sure all items in the trunk or items extending through the opening into the rear seats are properly secured. Loose items can fly forward if you have to brake hard.**

The front seat(s) must be far enough forward so they do not interfere with the rear seats as they fold down.

## Armrest

### ■ Using the Rear Seat Armrest

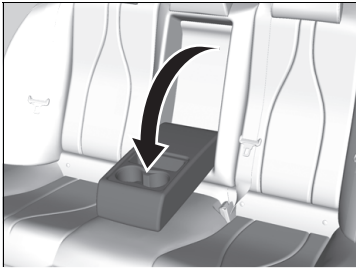

Pull down the armrest in the center backrest.

## Interior Lights

### Interior Light Switches

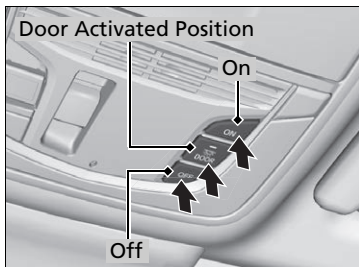

#### ■ ON

The interior lights come on regardless of whether the doors are open or closed.

#### ■ Door activated

The interior lights come on in the following situations:

- When any doors are opened.
- You unlock the driver's door.
- When the power mode is set to VEHICLE OFF (LOCK).

#### ■ OFF

The interior lights remain off regardless of whether the doors are open or closed.

### Interior Light Switches

In the door activated position, the interior lights fade out and go off about 30 seconds after the doors are closed.

The lights go off after about 30 seconds in the following situations:

- When you unlock the driver's door but do not open it.
- When you set the power mode to VEHICLE OFF (LOCK) but do not open a door.

You can change the interior lights dimming time.

➤ **Customized Features** P. 300

The interior lights go off immediately in the following situations:

- When you lock the driver's door.
- When you close the driver's door in ACCESSORY mode.
- When you set the power mode to ON.

To avoid draining the battery, do not leave the interior light on for an extended length of time when the engine is off.

If you leave any of the doors open in VEHICLE OFF (LOCK) mode, the interior lights go off after about 15 minutes.

## ■ Map Light Switches

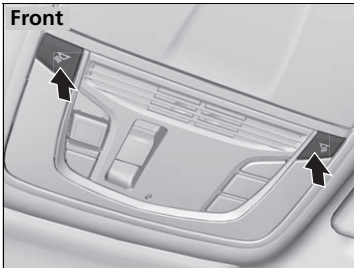

### ■ Front

The map lights can be turned on and off by pressing the  (map light) button.

### ■ Rear

The map lights can be turned on and off by pressing the  (map light) button when the front interior light switch is in the door activated position.

## » Map Light Switches

When the interior light switch is in the door activated position and any door is open, the map light will not go off when you press the  (map light) button.

## Storage Items

### ■ Glove Box

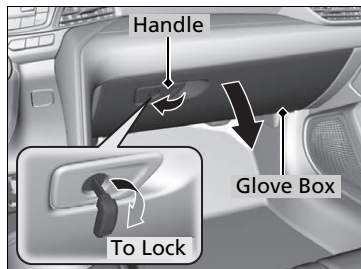

Pull the handle to open the glove box. You can lock the glove box with the built-in key.

### » Glove Box

#### **⚠ WARNING**

An open glove box can cause serious injury to your passenger in a crash, even if the passenger is wearing the seat belt.

Always keep the glove box closed while driving.

The glove box light comes on when the parking lights are on.

## ■ Console Compartment



Press the button to open the console compartment.

### ☒ Console Compartment

The console compartment light comes on when the parking lights are on.

*Continued*

## ■ Beverage Holders



### ■ Front seat beverage holders

Are located in the console between the front seats.



### ■ Rear seat beverage holders

Fold the armrest down to use the rear seat beverage holders.

## ☒ Beverage Holders

### NOTICE

Spilled liquids can damage the upholstery, carpeting, and electrical components in the interior.

Be careful when you are using the beverage holders. Hot liquid can scald you.



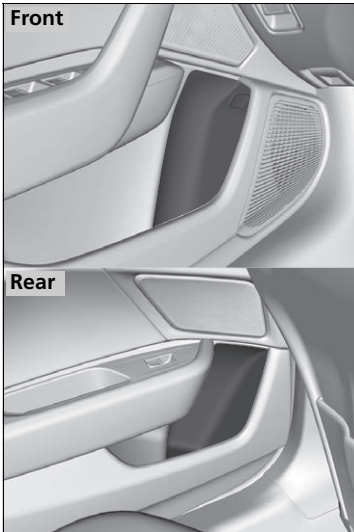

■ **Door side beverage holders**

Are located on the both of the front and rear door side pockets.

## ■ Coat Hooks



There are coat hooks on the rear grab handle of both sides. Pull it down to use it.

## ☒ Coat Hooks

The coat hooks are not designed for large or heavy items.

## ■ Under-Floor Storage Area\*

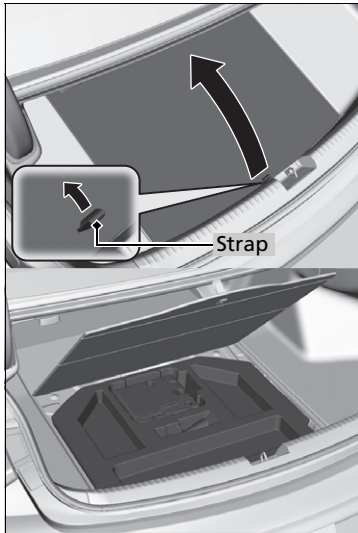

Pull the strap and open the lid.

\* Not available on all models

## ■ Sunglasses Holder

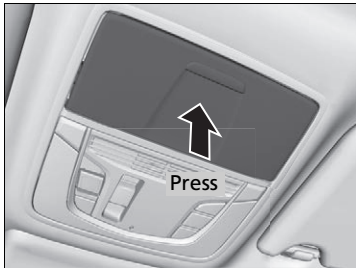

To open the sunglasses holder, press and release the indent. To close, press it again until it latches.

You can store eyeglasses and other small items in this holder.

## ☞ Sunglasses Holder

Keep the holder closed while driving except when accessing stored items.

## Other Interior Convenience Items

### ■ Accessory Power Sockets

The accessory power sockets can be used when the power mode is in ACCESSORY or ON.

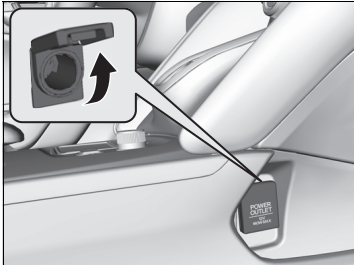

#### ■ Accessory power socket (passenger lower pocket)

Open the cover to use it.

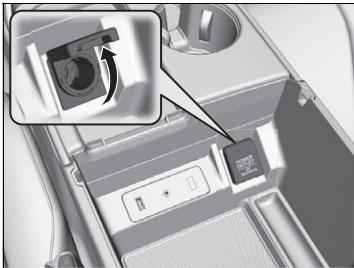

#### ■ Accessory power socket (console compartment)

Open the console lid and the cover to use it.

### » Accessory Power Sockets

#### NOTICE

Do not insert an automotive type cigarette lighter element. This can overheat the power socket.

The accessory power sockets are designed to supply power for 12-volt DC accessories that are rated 180 watts (15 amps) or less.

To prevent battery drain, only use the power socket with the engine running.

When the accessory power socket is not in use, close the cover to prevent any small foreign objects from getting into the power socket.

## ■ Wireless Charger\*

To use the wireless charger, the power mode must be in ACCESSORY or ON. Charge any devices compatible with Qi wireless charging on the area indicated by the  mark as follows:

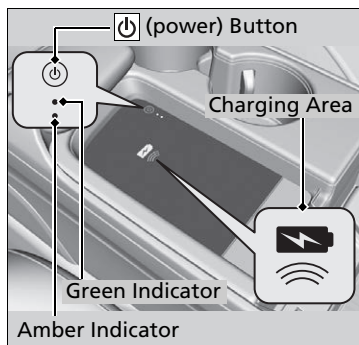

1. To turn the system on and off, press and hold the  (power) button.
  - When the system is activated, the green indicator light comes on.
2. Place the device you want to charge on the charging area.
  - The system will automatically start charging the device, and the amber indicator light will come on.
  - Make sure that the device is compatible with the system, and placed with the chargeable side in the center of the charging area.
3. When charging is completed, the green indicator light will come on.
  - Depending on the device, the amber indicator light will stay on.

## ▣ Wireless Charger\*

### FCC statement

This product complies with the appropriate requirements or the required standards of FCC (Federal Communication Commission), described below:

This device complies with Part 18 of the FCC rules. This equipment generates, uses, and can radiate radio frequency energy and, if not installed and used per the instructions, may cause harmful interference to radio communications.

In order to use safely:

- Remove any metal objects from the charge pad before charging a device.
- Do not open the charger case.
- Do not use the charger if it malfunctions. Contact your dealer.

If the charger interferes with radio communications, attempt to correct the interference:

- Press and hold the switch on the charger for a few seconds to turn off the charger.

**■ When charging does not start**

Perform one of the solutions in the following table.

Indicator		Cause	Solution
Green & Amber	Blinking simultaneously	There is an obstacle(s) between the charging area and the device.	Remove the obstacle(s).
		The device is not within the charging area.	Move the device to the center of the charging area where  is located.
Amber	Blinking	The wireless charger is faulty.	Contact a dealer for repairs.

Wireless Charger\*

**⚠ CAUTION**

Metal objects between the charge pad and the device to be charged will get hot and can burn you.

- Always remove foreign objects from the charge pad before charging the device.
- Be sure the surface is clear of dust and other debris before charging.
- Do not spill liquids (i. e. water, drinks, etc.) on the charger and the device.
- Do not use oil, grease, alcohol, benzene or thinner for cleaning the charge pad.
- Do not cover the system with towels, clothing, or other objects while charging etc.
- Avoid spraying aerosols which may come in contact with the charge pad surface.

This system consumes a lot of power. Do not use the system for a long time when the engine is not running. This may weaken the battery, making it difficult to start the engine.

\* Not available on all models

Continued

#### Wireless Charger\*

When using the wireless charger, check the user's manual that came with the compatible device you want to charge.

"Qi" and  marks are the registered trademarks owned by Wireless Power Consortium (WPC).

#### NOTICE

Do not place any magnetic recording media or precision machines within the charging area while charging.

The data on your cards such as credit cards can be lost because of the magnetic effect. Also precision machines such as watches can go wrong.

In the following cases, charging may stop or not start:

- The device is already fully charged.
- The temperature of the device is extremely high while charging.
- You are at a place that emits strong electromagnetic waves or noises, such as TV station, electric power plant, or gas station.

A device may not charge if the size or shape of its chargeable side is not appropriate for use with the charging area.

Not all devices are compatible with the system.

During the charging phase, it is normal for the charging area and device to heat up.



▶▶ Wireless Charger\*

Charging may be briefly interrupted when:

- All the doors or the trunk are closed  
- to avoid interference with the proper functioning of the keyless access system.
- The position of the device is altered.

Do not charge more than one device at a time on a charging area.

\* Not available on all models

*Continued*

## ■ Front Seat Heaters and Ventilation \*



The power mode must be in ON to use the seat heaters and ventilators\*.

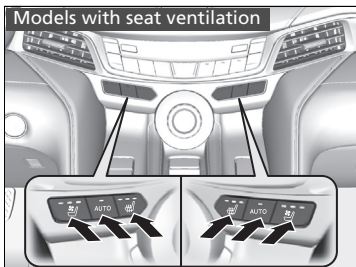

Press the seat heater or the seat ventilation\* button:

- Once - The HI setting (three indicators on)
- Twice - The MID setting (two indicators on)
- Three times - The LO setting (one indicator on)
- Four times - The OFF setting (no indicators on)

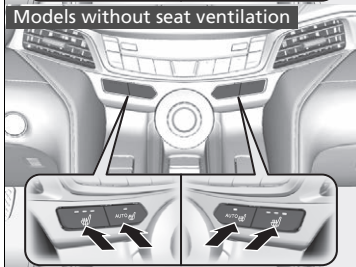

Press the **AUTO** button:

The system automatically selects the setting most suitable to the ambient environment.

When the power mode is turned on after it is turned off, the previous setting of front seat heaters and ventilators\* are maintained.

## ▣ Front Seat Heaters and Ventilation\*

### ⚠ WARNING

Heat induced burns are possible when using seat heaters.

Persons with a diminished ability to sense temperature (e.g., persons with diabetes, lower-limb nerve damage, or paralysis) or with sensitive skin should not use seat heaters.

Do not use the seat heaters and the seat ventilation even in LO when the engine is off. Under such conditions, the battery may be weakened, making the engine difficult to start.

After a certain period of time, the strength setting for the seat heaters will automatically be reduced by one level at a time until the seat heater shuts off. The elapsed time varies according to the interior environment.

## ■ Rear Seat Heaters\*



The power mode must be in ON to use the seat heaters.

There is no heater in the rear center seating position.

Press the seat heater button:

Once - The HI setting (three indicators on)

Twice - The MID setting (two indicators on)

Three times - The LO setting (one indicator on)

Four times - The OFF setting (no indicators on)

## ▣ Rear Seat Heaters\*

### ⚠ WARNING

Heat induced burns are possible when using seat heaters.

Persons with a diminished ability to sense temperature (e.g., persons with diabetes, lower-limb nerve damage, or paralysis) or with sensitive skin should not use seat heaters.

Do not use the seat heaters even in LO when the engine is off. Under such conditions, the battery may be weakened, making the engine difficult to start.

After a certain period of time, the strength setting for the seat heater will automatically be reduced by one level at a time until the seat heater shuts off. The elapsed time varies according to the interior environment.

\* Not available on all models

## ■ Heated Steering Wheel\*

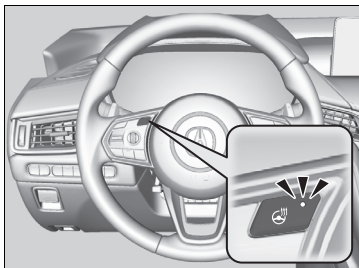

The power mode must be in ON to use the heated steering wheel.

Press the button on the left side of the steering wheel.

When a comfortable temperature is reached, press the button again to turn it off.

The heated steering wheel is turned off every time you start the engine, even if you turned it on the last time you drove the vehicle.

## ▣ Heated Steering Wheel\*

Do not use the heated steering wheel continuously when the engine is off. Under such conditions, the battery may be weakened, making the engine difficult to start.

## Using Automatic Climate Control

The automatic climate control system maintains the interior temperature you select. The system also selects the proper mix of heated or cooled air that raises or lowers the interior temperature to your preference as quickly as possible.

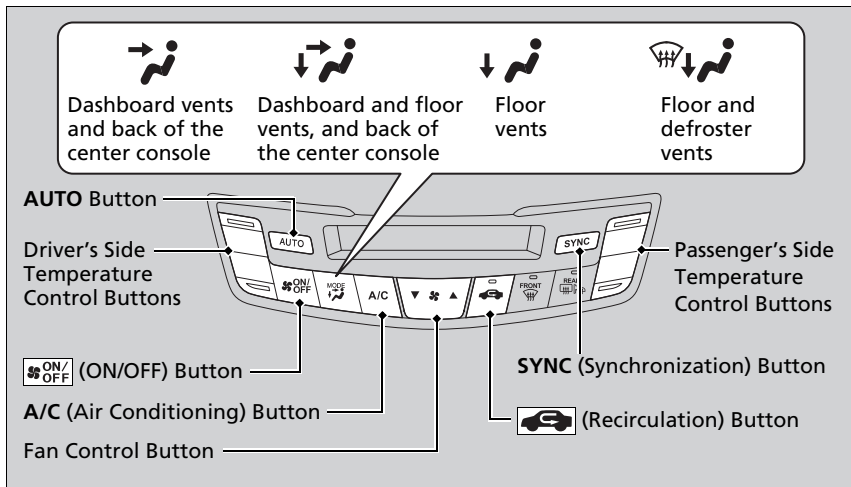

Use the system when the engine is running.

1. Press the **AUTO** button.
2. Adjust the interior temperature using the driver's side or passenger's side temperature control buttons.
3. Press the **ON/OFF** (ON/OFF) button to cancel.

### Using Automatic Climate Control

If any buttons are pressed while using the climate control system in auto, the function of the button that was pressed will take priority. The **AUTO** indicator will go off, but functions unrelated to the button that was pressed will be controlled automatically.

During idle-stops, air-conditioning is suspended, and only the blower remains active. If you do not want air-conditioning suspended, press the Auto Idle Stop **OFF** button to cancel idle-stop.

To prevent cold air from blowing in from outside, the fan may not start immediately when the **AUTO** button is pressed.

If the interior is very warm, you can cool it down more rapidly by partially opening the windows, turning the system on auto, and setting the temperature to low. Change the fresh air mode to recirculation mode until the temperature cools down.

When you set the temperature to the lower or upper limit, **Lo** or **Hi** is displayed.

Pressing the **ON/OFF** button switches the climate control system between on and off. When turned on, the system returns to your last selection.

### ■ Switching between the recirculation and fresh air modes

Press the  (recirculation) button and switch the mode depending on environmental conditions.

Recirculation mode (indicator on): Recirculates air from the vehicle's interior through the system.

Fresh air mode (indicator off): Maintains outside ventilation. Keep the system in fresh air mode in normal situations.

### ☒ Using Automatic Climate Control

When you unlock the doors with your remote, the driver's ID (**DRIVER 1** or **DRIVER 2**) is detected, and the climate control settings are turned to the respective mode automatically when you set the power mode to ON.

## ■ Defrosting the Windshield and Windows

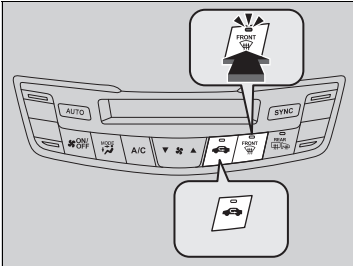

Pressing the  button turns the air conditioning system on and automatically switches the system to fresh air mode.

Press the  button again to turn off, the system returns to the previous settings.

## ■ To rapidly defrost the windows

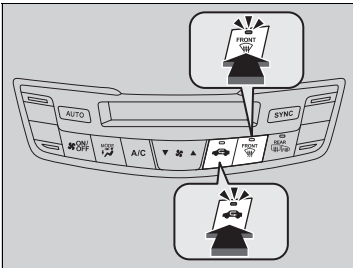

1. Press the  button.
2. Press the  button.

## ▣ Defrosting the Windshield and Windows

**For your safety, make sure you have a clear view through all the windows before driving.**

Do not set the temperature near the upper or lower limit.

When cold air hits the windshield, the outside of the windshield may fog up.

If you press the  button during Auto Idle Stop, the engine restarts automatically.

## ▣ To rapidly defrost the windows

After defrosting the windows, switch over to fresh air mode.

If you keep the system in recirculation mode, the windows may fog up from humidity. This impedes visibility.

## ■ Synchronization Mode

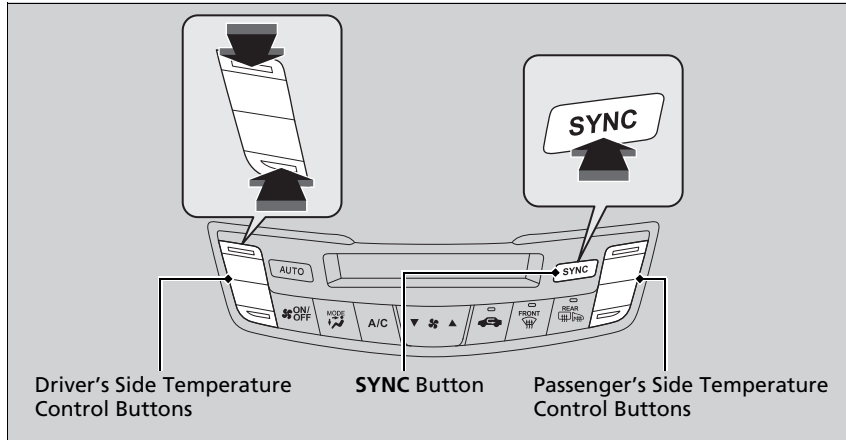

You can set the temperature synchronously for the driver's side and the passenger's side in synchronization mode.

1. Press the **SYNC** button.
  - The **SYNC** indicator will come on.
  - The system switches to synchronization mode.
2. Adjust the temperature using the driver's side temperature control buttons.

Press the **SYNC** button or adjust the interior temperature using the passenger's side temperature control buttons to return to dual mode.

## ☒ Synchronization Mode

When the system is in dual mode, the driver's side temperature and the passenger's side temperature can be set separately.



## Automatic Climate Control Sensors



The automatic climate control system is equipped with sensors. Do not cover or spill any liquid on them.



# Features

This chapter describes how to operate technology features.

## Audio System

About Your Audio System .....	202
USB Ports .....	203
Auxiliary Input Jack .....	204
Audio System Theft Protection .....	205
Audio Remote Controls .....	206
<b>Audio System Basic Operation</b> .....	208
True Touchpad Interface .....	209
Audio/Information Screen .....	212
System Updates .....	225
Adjusting the Sound .....	231
Display Setup .....	232

Voice Control Operation .....	233
Playing AM/FM Radio .....	236
Playing SiriusXM® Radio .....	240
Playing an iPod .....	253
Playing a USB Flash Drive .....	256
Playing <i>Bluetooth</i> ® Audio .....	259
Wi-Fi Connection .....	262
AT&T Hotspot .....	264
Siri Eyes Free .....	265
Apple CarPlay .....	266
Android Auto .....	270
<b>Audio Error Messages</b> .....	274

## General Information on the Audio

<b>System</b> .....	277
<b>Customized Features</b> .....	300
<b>HomeLink® Universal Transceiver</b> ...	324
<b>Bluetooth® HandsFreeLink®</b> .....	327
<b>AcuraLink®</b> .....	356

## About Your Audio System

The audio system features AM/FM radio and SiriusXM® Radio service. It can also play USB flash drives, and iPod, iPhone, iPad and *Bluetooth*® devices.

You can operate the audio system from the True Touchpad Interface, buttons and knobs on the panel, or the remote controls on the steering wheel.

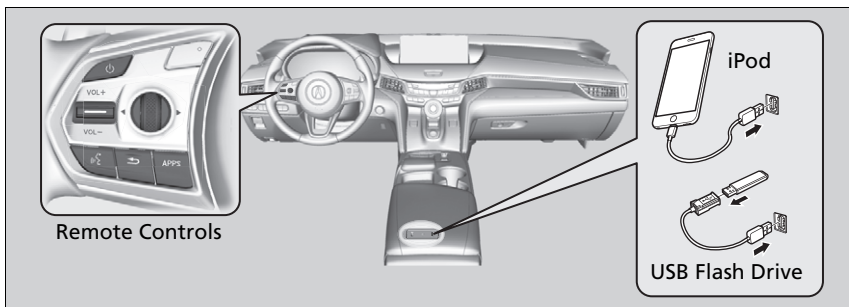

### About Your Audio System

iPod®, iPad®, iPhone® and iTunes are trademarks of Apple Inc.

State or local laws may prohibit the operation of handheld electronic devices while operating a vehicle.

SiriusXM® Radio is available on a subscription basis only. For more information on SiriusXM® Radio, contact a dealer.

#### **General Information on the Audio System** P. 277

SiriusXM® Radio is available in the United States and Canada, except Hawaii, Alaska, and Puerto Rico.

SiriusXM® is a registered trademark of SiriusXM Radio, Inc.

After you turn the power mode to VEHICLE OFF (LOCK) with the driver's door closed, you can use the audio system for up to 30 minutes per driving cycle. However, whether you can continue using the audio system depends on the battery condition. Repeatedly using this feature may drain the battery. The audio system turns off when you open the driver's door.

## USB Ports

Install the device USB connector or the USB flash drive to the USB port.

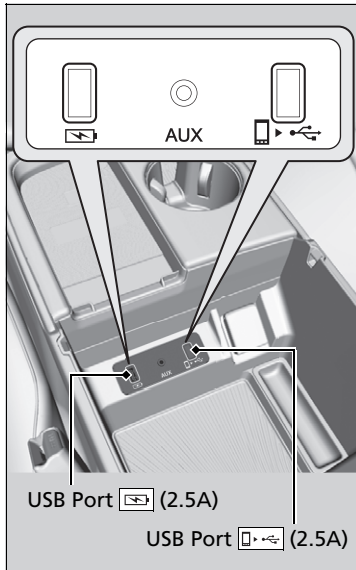

### ■ In the console compartment

The USB port [USB symbol] (2.5A) is for charging devices, playing audio files and connecting compatible phones with Apple CarPlay or Android Auto.

- ▶ To prevent any potential issues, be sure to use an Apple MFi Certified Lightning Connector for Apple CarPlay, and for Android Auto, the USB cables should be certified by USB-IF to be compliant with USB 2.0 Standard.

The USB port [USB symbol with lightning bolt] (2.5A) is only for charging devices.

### ▣ USB Ports

- Do not leave the iPod or USB flash drive in the vehicle. Direct sunlight and high temperatures may damage it.
- We recommend that you use a USB cable if you are attaching a USB flash drive to the USB port.
- Do not connect the iPod or USB flash drive using a hub.
- Do not use a device such as a card reader or hard disk drive, as the device or your files may be damaged.
- We recommend backing up your data before using the device in your vehicle.
- Displayed messages may vary depending on the device model and software version.

#### USB charge

The USB port can supply up to 2.5A of power. It does not output 2.5A unless the device requests. For amperage details, read the operating manual of the device that needs to be charged.

Under certain conditions, a device connected to the port may generate noise in the radio you are listening to.

#### USB Port [USB symbol with lightning bolt] (2.5A)

This port is for battery charge only. You cannot play music even if you have connected music players to them.

## Auxiliary Input Jack

Use the jack to connect a standard audio device.

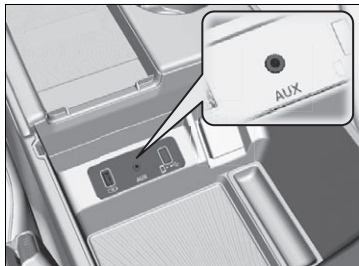

Connect a standard audio device to the input jack using a 1/8 inch (3.5 mm) stereo miniplug.

### ▶▶ Auxiliary Input Jack

You can return to the AUX mode by selecting **AUX Input** on the home screen.

## Audio System Theft Protection

---

The audio system is disabled when it is disconnected from the power source, such as when the battery is disconnected or goes dead. In certain conditions, the system may display a code entry screen. If this occurs, reactivate the audio system.

### ■ Reactivating the audio system

1. Set the power mode to ON.
2. Turn on the audio system.
3. Press and hold the audio system power knob for more than two seconds.
  - ▶ The audio system is reactivated when the audio control unit establishes a connection with the vehicle control unit. If the control unit fails to recognize the audio unit, you must go to a dealer and have the audio unit checked.

## Audio Remote Controls

Allow you to operate the audio system while driving. The information is shown on the multi-information display or head-up display\*.

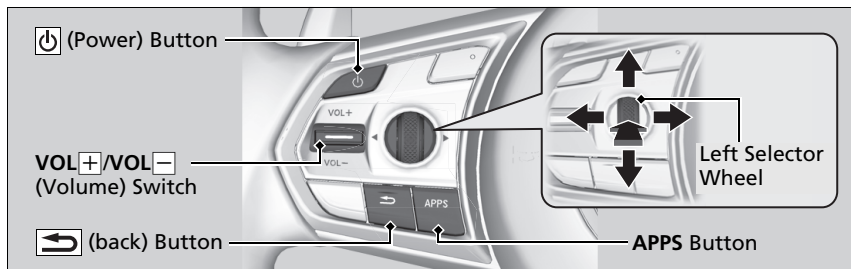

### VOL+ /VOL- (Volume) Switch

**Press Up:** To increase the volume.

**Press Down:** To decrease the volume.

### (Power) Button

Press to turn the audio system on and off.

### Left Selector Wheel

- When selecting the audio mode  
Press the **APPS** button, then roll up or down to select an item on the multi-information display or head-up display\*, and then press the left selector wheel.

#### Models with head-up display

Move the left selector wheel to the right to display the **Recents** list, then scroll to an item selected in the past and press the wheel.

#### ▶▶ Audio Remote Controls

Some modes appear only when an appropriate device or medium is used.

Depending on the *Bluetooth*® device you connect, some functions may not be available.

Press the (back) button for the multi-information display or head-up display\* to go back to the previous screen or cancel a command.

Press the **APPS** button to go back to the menu screen of the multi-information display or head-up display\*.

#### Models with head-up display

**Recents** list is available when the following audio mode is selected.

- **FM Radio**
- **AM Radio**
- **SiriusXM**
- **USB Audio**



**Roll up or down:**

To cycle through each modes, roll up or down and then press the left selector wheel:

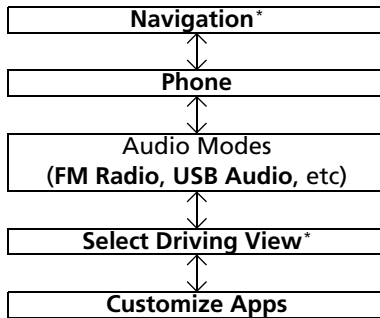

After an audio mode is selected, the left selector wheel can be operated for the following functions.

- When listening to the radio
  - Move to the right:** To select the next favorite radio station or channel.
  - Move to the left:** To select the previous favorite radio station or channel.
- When listening to an iPod, USB flash drive, *Bluetooth*® Audio, or Smartphone Connection
  - Move to the right:** To skip to the next song.
  - Move to the left:** To go back to the beginning of the current or previous song.

\* Not available on all models

### ▶▶ Audio Remote Controls

You can customize the items on multi-information display or the head-up display\*.

#### ▶ Customizing the Meter or Head-Up Display\* P. 223

You cannot operate the audio functions while the following functions are being operated on the multi-information display or head-up display\*.

- Mode selection by pressing **APPS** button
- **Navigation\***
- **Phone**
- **Select Driving View\***
- **Customize Apps**

# Audio System Basic Operation

You can use the audio system for 30 minutes when the power mode to VEHICLE OFF (LOCK) with the driver's door closed, the system will then turn off automatically. If you want to keep using it, we recommend that you turn the power mode to ACCESSORY or ON.

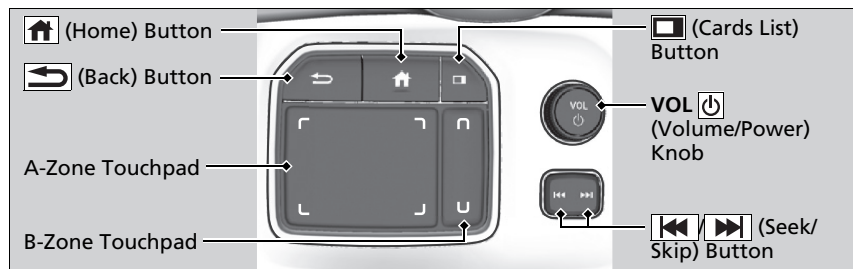

**VOL** **(Volume/Power) Knob:** Push to turn the audio system on and off. Turn to adjust the volume when audio system is on.

**(Seek/Skip) Button:** Press to change station, channel, song or file.

**(Back) Button:** Press to go back to the previous display when it is displayed.

**(Home) Button:** Press to go to the home screen.

**(Cards List) Button:** Press to display the cards list of the B-zone on the audio/information screen.

**B-Zone** P. 214

**A-Zone Touchpad:** Click or swipe the pad with your finger, or move your finger along the pad to operate the A-zone on the audio/information screen.

**B-Zone Touchpad:** Click or swipe the pad with your finger to operate the B-zone on the audio/information screen.

## Audio System Basic Operation

### **True Touchpad Interface**

**True Touchpad Interface** P. 209

### **A-Zone**

**A-Zone** P. 212

### **B-Zone**

**B-Zone** P. 214

## True Touchpad Interface

You can operate the system using True Touchpad Interface.

### ■ A-Zone Touchpad Operation

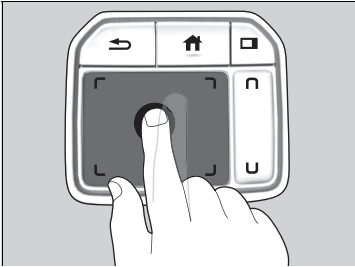

#### ■ Click

Lightly press A-zone touchpad to select an item.

#### ■ Press and hold

Press and hold to initiate edit mode throughout the system.

#### ■ Swipe

Swipe or drag your finger in various directions to operate each screen.

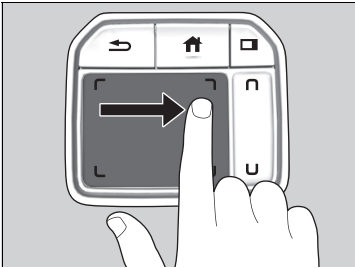

### ☒ True Touchpad Interface

#### True Touchpad Interface

- Some items may be grayed out during driving to reduce the potential for distraction.
- You can select them when the vehicle is stopped or use voice commands.
- Wearing gloves may limit or prevent True Touchpad Interface response.
- Some electronics like inverters may cause slow response while using the True Touchpad Interface.

You can operate the True Touchpad Interface using gloves when you set the **Touchpad Sensitivity** setting to **High**. However, the True Touchpad Interface cannot be operated with insulated gloves.

☒ **Customized Features** P. 300

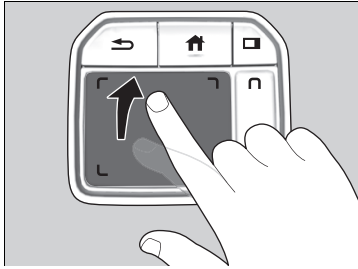

■ **Flick**

Flick (or drag) your finger up/down or left/right to scroll in lists or change pages throughout the system.

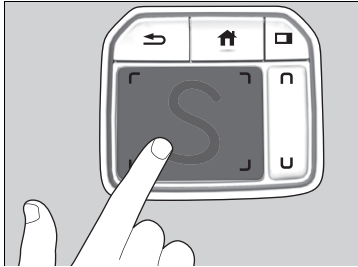

■ **Hand-writing a character**

Move your finger quickly to trace a character on the A-zone touchpad.

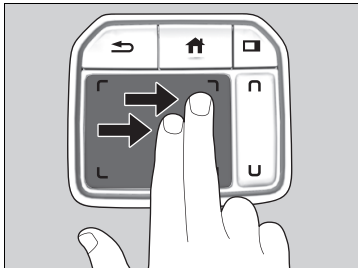

Models with navigation system

■ **Swipe with two fingers**

Swipe (or drag) two fingers across the screen to move the map.

## ■ B-Zone Touchpad Operation

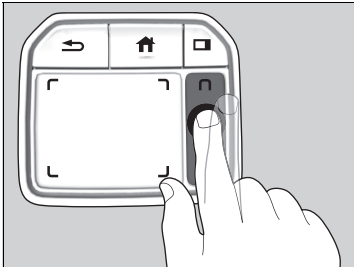

### ■ Click

Lightly press (click) the B-zone touchpad to select a card.

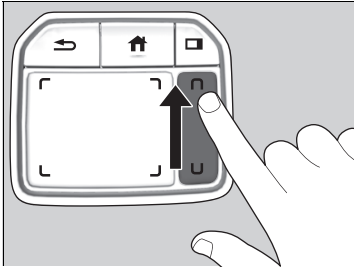

### ■ Swipe

Swipe or drag your finger up or down to select an item.

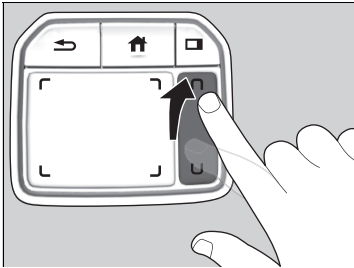

### ■ Flick

Flick up or down to cycle through card displayed in the B-zone.

## Audio/Information Screen

Displays each mode status. From this display, you can go to various setup options.

### ■ A-Zone

#### ■ Switching the display

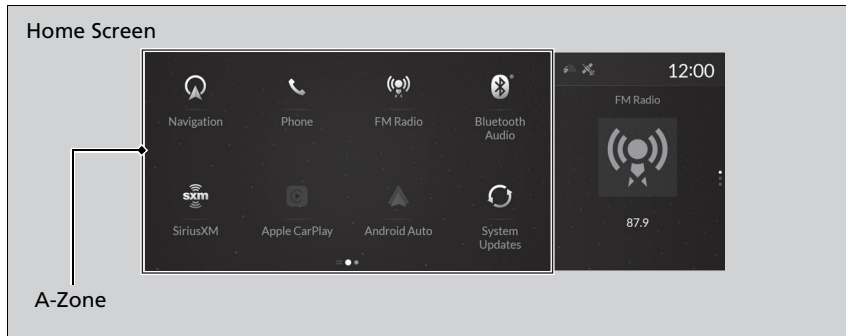

Press the  (home) button to go to the home screen.  
Select the following icons on the home screen or **All Apps** list.

#### ■ Navigation\*

Displays the navigation screen.

➤ **Refer to the Navigation System Manual**

#### ■ Phone

Displays the HFL information.

➤ **Bluetooth® HandsFreeLink®** P. 327

#### ■ FM Radio/AM Radio/SiriusXM/USB Audio/Bluetooth Audio/AUX Input

Displays the audio information for each.

\* Not available on all models

### ▶▶ Audio/Information Screen

#### **All Apps** list

You can select any of the apps from the **All Apps** list. To display the **All Apps** list, place your finger on the True Touchpad Interface and swipe right.

➤ **Home Screen** P. 216

You can add or remove any of the apps in the home screen through the **All Apps** list.

➤ **To add app icons to the home screen and the head-up display\*** P. 217

## ■ Settings

Enters the customizing menu screen.

➤ **Customized Features** P. 300

## ■ Apple CarPlay

Displays the **Apple CarPlay** screen.

➤ **Apple CarPlay** P. 266

## ■ Android Auto

Displays the **Android Auto** screen.

➤ **Android Auto** P. 270

## ■ System Updates

Updates the software version of the audio system.

➤ **System Updates** P. 225

## ■ Messages

Displays the text message screen.

➤ **Text Message** P. 345

## ■ AT&T HotSpot

Displays the AT&T Hotspot screen.

➤ **AT&T Hotspot** P. 264

## ■ AcuraLink

Displays the AcuraLink screen.

➤ **AcuraLink®** P. 356

## ■ B-Zone

You can see the audio, HFL information, navigation mini map\*, and clock information on the B-zone using the B-zone touchpad.

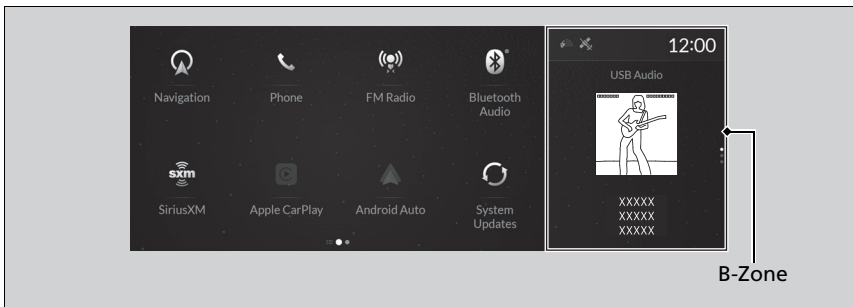

### ■ Switching the card

Swipe up or down the B-zone touchpad to cycle through the following screen.

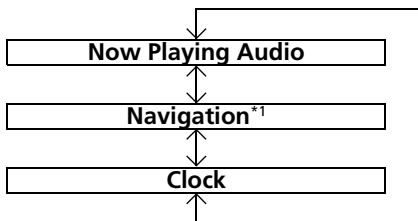

## ▶▶ B-Zone

SiriusXM® radio service notifications are displayed in the B-zone.

### ▶▶ Switching the card

The card in the B-zone will change depending on the screen displayed in the A-zone.

#### Models without navigation system

\* 1: Appears only when you set a destination on the Apple CarPlay or Android Auto navigation function.

▶ **Apple CarPlay** P. 266

▶ **Android Auto** P. 270



You can also switching the screen by following procedure.

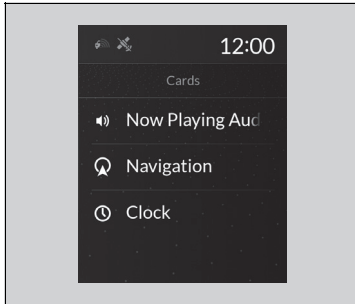

1. Press the  (cards list) button.
2. Select an item then press the B-zone touchpad.

## ■ Home Screen

### ■ To change to a next screen

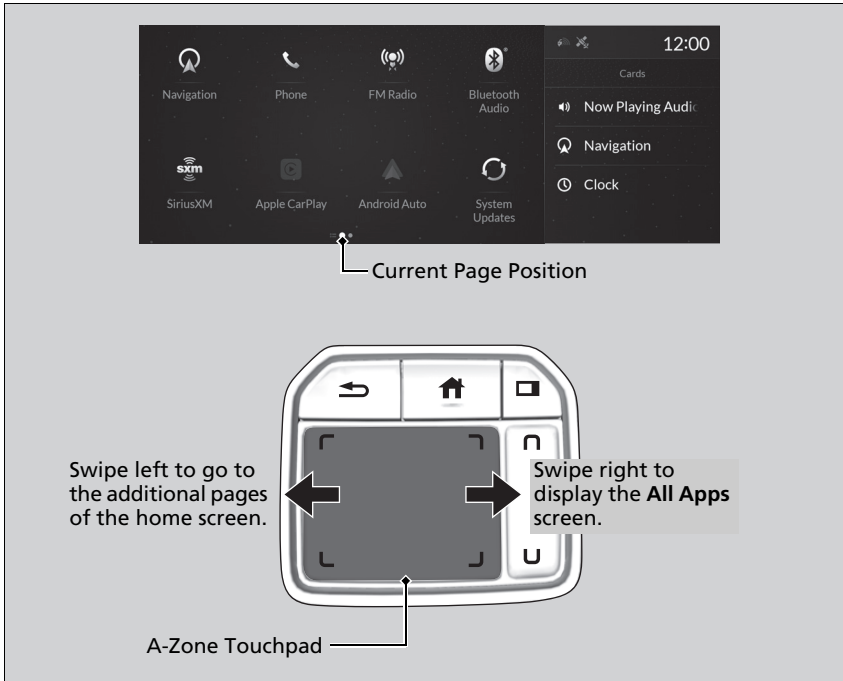

Swiping A-zone touchpad left or right takes you to the next screen.

## ▶▶ Home Screen



The home screen has 2 pages. You can add up to 8 pages.

Press the  (home) button to go directly back to the first page of the home screen from any page.

## ■ To add app icons to the home screen and the head-up display\*

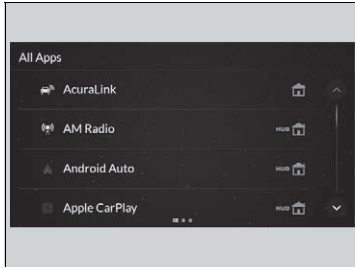
You can add app icons to the home screen and the head-up display.



1. Press the  (home) button.
2. Swipe right to display the **All Apps** screen.
3. Go to an app on the list, then press and hold A-zone touchpad.
4. From the pop-up menu, select **Add to Home Page** or **Add to Heads-Up Display**.
  - ▶ The  icon or **HUD\*** appears next to the app on the list when the corresponding icon has been added to the home screen or head-up display.

## ☒ To add app icons to the home screen and the head-up display\*

Pre-installed apps may not start up normally. If this occurs, you need to reset the system.

➤ **Defaulting All the Settings** P. 323

If you perform **Factory Data Reset**, it may reset all the settings to their factory default.

➤ **Defaulting All the Settings** P. 323

In case those apps still do not startup normally, even after **Factory Data Reset**, contact your dealer.

### Models with head-up display

Each item with **HUD** is listed on the head-up display menu.

If you want to hide the item from the head-up display menu, select **Remove from Heads-Up Display**.

\* Not available on all models

## ■ To add shortcut icons to the home screen and the head-up display\*

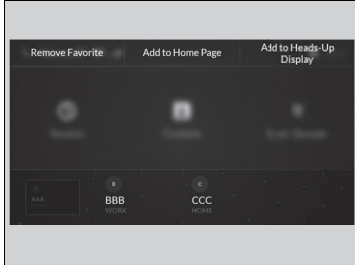

Shortcut icons for items stored in Favorite can be added to the home screen and the head-up display.



1. Select a favorite item, then press and hold A-zone touchpad.
  - ▶ A pop-up menu will appear on the screen.
2. Select **Add to Home Page** or **Add to Heads-Up Display**\*.
  - ▶ A short cut icon will be added to the home screen or the head-up display.

▶▶ To add shortcut icons to the home screen and the head-up display\*

### Models with head-up display



You can add an icon to the head-up display directly from the home screen. Select an icon on the home screen, then press and hold the A-zone touchpad. After that, select **Add to Heads-Up Display**, and then press the  (back) button or the  (home) button to confirm the change.

Note that icons for **Messages**, **Settings**, and **System Update** cannot be added to the head-up display.

## ■ To move icons on the home screen

You can change the location of the icons on the home screen.



1. Select the icon you want to move, then press and hold A-zone touchpad.
  - ▶ The screen will change to the customization screen.
2. Drag the icon to where you want it to be and then press and hold the A-zone touchpad.
  - ▶ The icon will be repositioned and the screen will remain in the customization mode.
  - ▶ After you drag the icon, keep your finger on the A-zone touchpad and then press down. If you release your finger before pressing the A-zone touchpad, the icon will remain in its original place.
  - ▶ If you want to reposition the icon on another page of the home screen, swipe the A-zone touchpad.
3. Press the  (back) button or the  (home) button to confirm the change.



## ▶▶ To move icons on the home screen

Press and hold  (home) button to switch to the customization screen.



## ■ To remove icons from the home screen and the head-up display\*

You can remove icons from the home screen and the head-up display.



1. From the home screen, select the icon that you want to remove, then press and hold A-zone touchpad.
  - ▶ The screen will switch to the customization screen.
2. Go to **Remove from Home Page** or **Remove from Heads-Up Display\*** and press the A-zone touchpad.
  - ▶ The icon will be removed from the home screen or the head-up display, and the screen will remain in the customization mode.
3. Press the  (back) button or the  (home) button to confirm the change.

You can also remove an icon from the home screen or head-up display directly from the **All Apps** list.

1. Go to an item you want to remove, then press and hold the A-zone touchpad.
2. Go to **Remove from Home Page** or **Remove from Heads-Up Display\*** and press the A-zone touchpad.
  - ▶ The icon will be removed from the home screen or the head-up display.
3. Press the  (back) button or the  (home) button to confirm the change.

## ▶▶ To remove icons from the home screen and the head-up display\*

Removing an icon from the home screen does not result in the deletion of the corresponding app.

Press and hold  (home) button to switch to the customization screen.

### Models with head-up display

If you remove a shortcut icon from the home screen, the function of selected icon also remove from the head-up display.

## Status Area

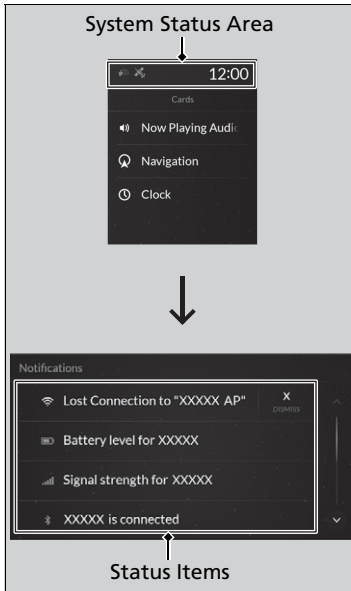

1. Select the system status area, then press B-zone touchpad.
  - ▶ The status items will appear in the A-zone.
2. Select an item to see the details.
  - ▶ Select **Dismiss** to delete the detail.
  - ▶ Press the  (back) button or select status area again to close the status list.

## ■ Searching Screen

You can use the hand-writing input feature by using the A-zone touchpad when searching for various items of the audio system (e.g., music, route of the navigation, phonebook contact).

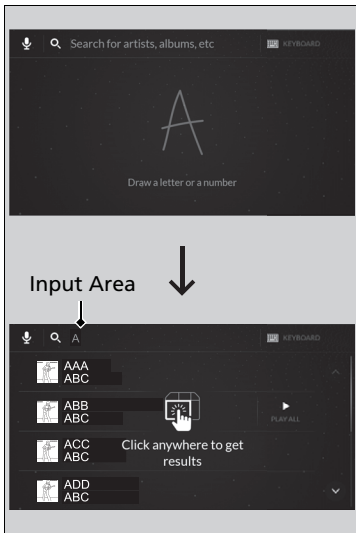

1. Write letters or numbers using the A-zone touchpad.

▶ Search results appear on the screen.

2. Press the A-zone touchpad.

▶ If you re-enter letters or numbers, select the input area on the upper side of the screen.

3. Select a desired item, and then press the A-zone touchpad.

## ▶▶ Searching Screen

### Delete a letter or number

Swipe left the A-zone touchpad to delete a letter or a number.

### Input a space

Swipe right the A-zone touchpad to input a space.

You can inputting letters or numbers by using on screen keyboard. Select **KEYBOARD** on the upper right of the screen.

When you return to hand-writing input screen, select **HANDWRITING**.

You can inputting letters or numbers by using voice control operation. Select  icon on the upper left of the screen.



## ■ Customizing the Meter or Head-Up Display\*

You can edit, show, or hide the audio, phone, navigation\* contents on the multi-information display or the head-up display\*.

### ■ To add or remove an items

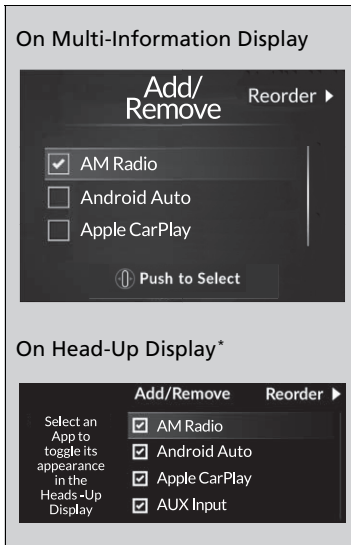

1. Press the **APPS** button on the steering wheel.
2. Roll down the left selector wheel to select **Customize Apps**.
3. Move the left selector wheel left to select **Add/Remove**.
4. Select an item then press the left selector wheel.
  - ▶ The checked items are displayed on the multi-information display or the head-up display\*.

## ■ Editing order

### On Multi-Information Display

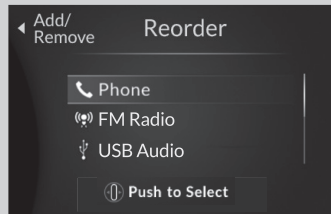

### On Head-Up Display\*

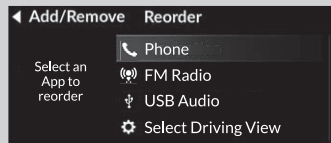

1. Press the **A P P S** button on the steering wheel.
2. Using the left selector wheel, scroll to **Customize Apps** and then press the selector wheel.
3. Move the selector wheel to the right to go to the **Reorder** screen.
4. Scroll to an item you want to move, then press the left selector wheel.
5. Scroll to where you want to move the contents, then press the left selector wheel.

## System Updates

The audio system's firmware can be updated with the telematics control unit (TCU) through the subscription-based service.

### How to Update Wirelessly

#### Wireless connection mode setup

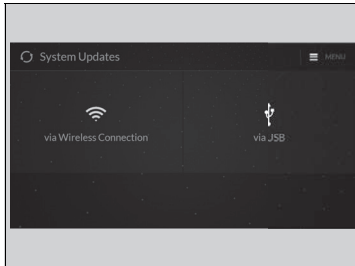

1. Press the  (home) button.
2. Select **System Updates**.
3. Select **MENU**.
4. Select **Connection Setup**.



5. Select **Change Mode**.
6. Select **Network**.
  - ▶ The display will return to the network list.
7. Select an access point from the network list, then select **OK**.
  - ▶ If the audio system requires a password, enter a password.

## ■ How to update

When the audio system update is available, the notification is shown on the audio/information screen. Use the following procedure to update the system.

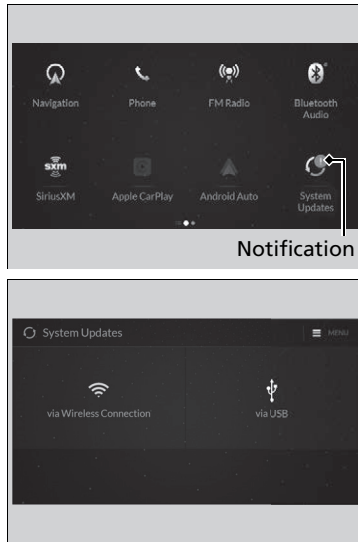

1. Press the  (home) button.

2. Select **System Updates**.

3. Select **via Wireless Connection**.

▶ When the download is complete, the screen for step 5 will be displayed.

4. Select **Download Now**.

▶ A notification will appear on the screen.

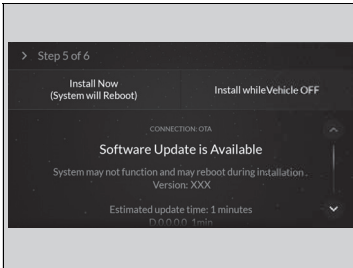

**5. Select **Install Now** or **Install while Vehicle OFF**.**

- ▶ A notification appears on the screen if the update is successful when **Install Now** is selected.
- ▶ If you select **Install while Vehicle OFF**, proceed to steps 6 and 7.

**6. Set the power mode to VEHICLE OFF (LOCK).**

- ▶ A notification will appear on the screen. If you select **Postpone Update**, the update will be postponed.

**7. Exit from your vehicle.**

- ▶ The system will start the firmware update.
- ▶ If the update is successful, a notification informing you of this fact will appear on the screen the next time you set the power mode to ON.

☒ How to update

The system may cancel the firmware update if the battery is low on power, even if you have selected **Install while Vehicle OFF**. If you want to install the updated data, recharge the battery or select **Install Now**.

If you select **Install Now**, the system may reboot.

### ■ Automatic download settings

Use the following procedure to change to the automatic download setting.

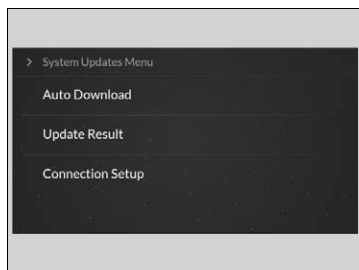

1. Press the  (home) button.
2. Select **System Updates**.
3. Select **MENU**.
4. Select **Auto Download**.
5. Select the access point, then **Allow**.

### ■ View a update status



Use the following procedure to confirm the update status.

1. Press the  (home) button.
2. Select **System Updates**.
3. Select **MENU**.
4. Select **Update Result**.

## How to Update with a USB Device

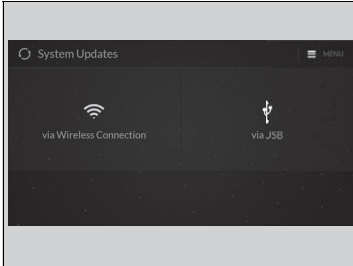
### Download the update files from the server



1. Press the  (home) button.
2. Select **System Updates**.
3. Select **via USB**.
  - ▶ A notification appears on the screen.
4. Connect a USB device into the USB port  (2.5A).
  - ▶ The inventory data is copied into the USB device.
    - ▶ **USB Ports** P. 203
5. Remove the USB device from the USB port.
6. Connect the USB device into your computer, and then download the update files.
  - ▶ Follow the link to download the required software update files. Refer to <https://usb.acura.com> for instructions.



### How to Update with a USB Device



A USB device with a minimum of 8 GB of free space or more is recommended.

Be sure to delete any previous inventory or update files from the USB device before starting the USB update process.

Continued

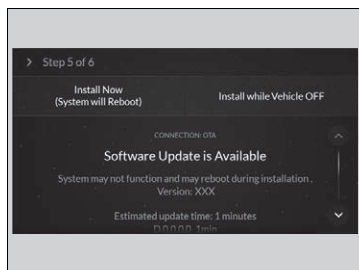
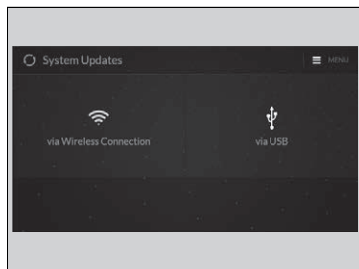
## ■ Update the audio system



1. Press the  (home) button.
2. Select **System Updates**.
3. Select **via USB**.
  - ▶ A notification appears on the screen.
4. Connect the USB device with the update files into the USB port.
  - ▶ A notification appears on the screen.
    - ▶  **USB Ports** P. 203
5. Select **Install Now** or **Install while Vehicle OFF**.
  - ▶ A notification appears on the screen if the update is successful when **Install Now** is selected.
  - ▶ When you select **Install while Vehicle OFF** go to step 6.
6. Set the power mode to VEHICLE OFF (LOCK).
  - ▶ A notification appears on the screen. If you select **Postpone Update**, the update is postponed.
7. Exit from your vehicle.
  - ▶ The system will start the firmware update.
  - ▶ A notification appears on the screen if the update is successful at the next time you set the power mode to ON.

### ▶▶ Update the audio system

The system may stop the firmware update when battery is low on power, even when you selected **Install while Vehicle OFF**. If you want to install the updated data, recharge the battery or select **Install Now**.



## Adjusting the Sound

1. Press the  (home) button.
2. Select an audio source icon.

### USB Audio, AUX Input mode

3. Select **SOUND**.
4. Select the setting you want.

### FM Radio, AM Radio, SiriusXM, Bluetooth Audio mode

3. Select **MENU**.
4. Select **Sound Settings**.
5. Select the setting you want.

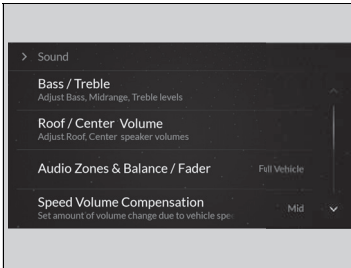

Select an item from the following choices:

- **Bass / Treble:** Treble, Midrange, Bass
- **Roof / Center Volume\*:** Roof speaker, center speaker
- **Audio Zones & Balance / Fader\*:** Driver Only, Front Only, Rear Only, Full Vehicle, Balance, Fader
- **Balance / Fader\*:** Balance, Fader
- **Speed Volume Compensation:** Speed Volume Compensation (SVC)
- **DTS Neural Surround\*:** DTS Neural Surround™
- **Compressed Audio Enhancement\*:** Enhancement for compressed audio quality

### ▶▶ Adjusting the Sound

The SVC adjusts the volume level based on the vehicle speed. As you go faster, audio volume increases. As you slow down, audio volume decreases.

You can also adjust the sound the following procedure.

1. Press the  (home) button.
2. Select **Settings**.
3. Select **Sound**.

### Audio Zones & Balance / Fader

You can change where the sound comes from by selecting one of the speaker options below:

- **Full Vehicle:** All the speakers emit sound.
- **Driver Only:** Allows driver to listen to the audio system while maintaining a quieter environment for the other occupants.
- **Front Only:** Allows front seat occupants to listen to the audio system while maintaining a quieter environment for occupants in the rear.
- **Rear Only:** Allows rear seat occupants to listen to the audio system while maintaining a quieter environment for occupants in the front.

### Reset to Default

Select to reset the following settings from the pop-up menu to their factory default.

- **Bass / Treble**
- **Roof / Center Volume\***
- **Audio Zones & Balance / Fader\***
- **Balance / Fader\***

\* Not available on all models

## Display Setup

You can change the brightness of the audio/information screen.

### ■ Changing the Screen Brightness

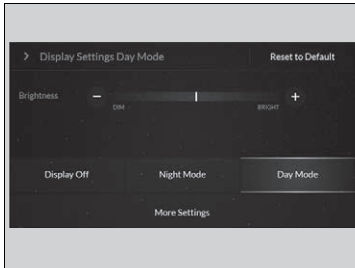

1. Press the  (home) button.
2. Select **Settings**.
3. Select **Display**.
4. Select **Day Mode** or **Night Mode**.
5. Select the setting you want.
  - ▶ When you adjust the **Contrast** and **Black Level**, select **More Settings**.

### ■ Limitations for Manual Operation \*

Certain manual functions are disabled or inoperable while the vehicle is in motion. You cannot select a grayed-out option until the vehicle is stopped.



### ☒ Changing the Screen Brightness

You can change the **Contrast** and **Black Level** settings in the same manner.

To reset the settings, select **Reset to Default**. **Reset to Default** is only applicable to the settings in the current mode.

## Voice Control Operation

Your vehicle has a voice control system that allows hands-free operation.

The voice control system uses the  (talk) and  (back) buttons on the steering wheel and a microphone near the map lights on the ceiling.

### ■ Voice Recognition

To achieve optimum voice recognition when using the voice control system:

- The system recognize a natural language and accept your free form voice command.



An example of voice commands:

▶ **Voice Recognition Screen** P. 234

- Close the windows and moonroof.
- Adjust the dashboard and side vents so air does not blow onto the microphone on the ceiling.
- Speak clearly in a clear, natural speaking voice without pausing between words.
- Reduce any background noise if possible. The system may misinterpret your command if more than one person is speaking at the same time.

#### ▶▶ Voice Control Operation

When you press the  button, the system beeps and the display changes to the voice recognition screen.

Press the  (home) button,  (back) button on the True Touchpad Interface or **APPS** button on the steering wheel to cancel a voice recognition function.

Continued

## ■ Voice Recognition Screen

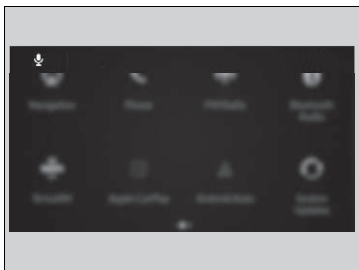

When the  (talk) button is pressed, the voice control screen appears. For a complete list of commands, say “Help” after the beep.

The system accepts free form voice commands. See the following examples for recommended voice commands.

## ■ Phone Commands

This can be only used when the phone is connected.

### ■ Phone Commands

#### Dial by number

- Call <Phone Number>
- Dial <Phone Number> please
- Phone <Phone Number>

#### Redial

- Redial
- Redial last number
- Call last number

#### Voicemail

- Call voicemail
- Dial voicemail
- Check voicemail
- Check mailbox

#### Contact by voice

- Call <your contact name>
- Call <your contact name> on his/her <category name> please
- Make a call to <your contact name>
- Make a call to <your contact name> on her/his <category name>

The system recognizes an only contact name in the stored phonebook of your phone.

Phone commands are not available if using Apple CarPlay.

## ■ Audio Commands

### ■ FM Commands

- Play FM radio
- Tune to <87.7-107.9> FM
- I want to listen to FM <87.7-107.9>
- Play FM <87.7-107.9>

### ■ AM Commands

- Play AM radio
- Tune to <530-1710> AM
- I want to listen to AM <530-1710>
- Play AM <530-1710>

**■ Sirius XM Commands**

- *Play XM radio*
- *Play XM <channel number>*
- *Listen to <channel name> on XM*
- *Play XM Channel <channel number>*
- *Tune to <channel name>*
- *Listen to <channel number> on the satellite radio*

**■ USB Commands**

- *Play USB*
- *Play iPod*
- *Play genre <genre name>*
- *Play <artist name>*
- *Play <album name>*
- *Play <song name>*
- *Play <playlist name>*

**■ Bluetooth® Audio Commands**

- *Play Bluetooth*

**■ AUX Commands**

- *Play AUX*

**■ Navigation Commands\*1**

📖 Refer to the Navigation System Manual

**■ Standard Commands**

- *Help*
- *Cancel*
- *Repeat*

Voice Help are readout voice guidance for Help on current screen.

**■ Letter Input Commands**

You can search for the desired item on each search screen with your voice.

**■ List Commands**

- *Next Page*
- *Previous Page*
- *Back*
- *Go to <number>*
- *Select <number>*

\*1: Models with navigation system

## Playing AM/FM Radio

### Tune

Select to display the manual input screen of radio frequency.

### Scan

Select to scan each station with a strong signal.

### Favorite Station Icons, Add Favorite

Tune the radio frequency for favorite station. Select **Add Favorite** to store the station. Swipe left or right the A-zone touchpad to display the next or previous favorite station list.

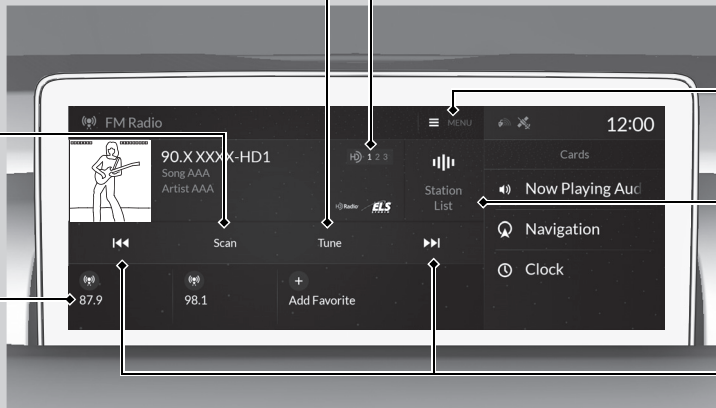

### Icon

Select to display the subchannel list screen.

### MENU

Select to display the menu screen.

### Station List

Select to display the station list screen.

### Tune Up/Down Icons

Select or to search up and down the selected band for a station with a strong signal.

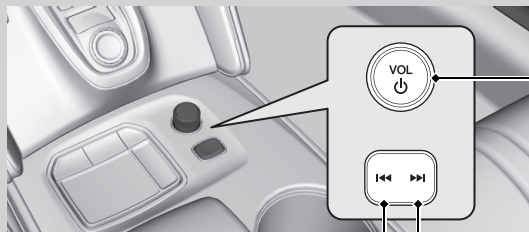

### VOL (Volume/Power) Knob

Push to turn the audio system on and off. Turn to adjust the volume.

### (Seek/Skip) Button

Press or to search up and down the selected band for a station with a strong signal.

## Favorite Station

To add a favorite station:

1. Tune to the selected station.
2. Select **Add Favorite**, then select **Current Station**.
  - ▶ When you select **From Station List**, you can store a station from the station list.

### Editing a favorite station

Select and hold to desired favorite station icon.

The following items are available:

- **Remove Favorite:** Delete the favorite station icon from the favorite station list.
- **Replace with** (number): Replace the stored favorite station icon.
- **Add to Home Page:** Add the shortcut icon of the stored favorite station to the home screen.
- **Add to Heads-Up Display\*:** Add the shortcut item of the stored favorite station to the head-up display menu.

\* Not available on all models

Continued

### Favorite Station

The **ST** indicator appears on the display indicating stereo FM broadcasts. Stereo reproduction in AM is not available.

#### Switching the Audio Mode

Press the **APPS** button on the steering wheel, then select an item or select the audio source icon on the home screen.

▶ **Audio Remote Controls** P. 206

You can store 12 AM/FM stations into favorite station.

HD Radio Technology manufactured under license from iBiquity Digital Corporation. U.S. and Foreign Patents. For patents see <http://dts.com/patents>. HD Radio, Artist Experience, and the HD, HD Radio, and "ARC" logos are registered trademarks or trademarks of iBiquity Digital Corporation in the United States and/or other countries.



## ■ Station List

Lists the strongest stations on the selected band.

1. Select **Station List** to display a list.
2. Select the station.



## ■ Manual update

Updates your available station list at any time.

1. Select **Station List** to display a list.
2. Select **Refresh**.

## ■ Radio Frequency Manual Tune Screen



1. Select **Tune**.
2. Select  or  to tune the radio frequency.

## ■ Scan

Samples each of the strongest stations on the selected band for 10 seconds. To turn off scan, select **Stop** or press the  (back) button.

## ⌘ Station List

Provides text data information related to your selected RDS-capable FM station.

When you select an RDS-capable FM station, the RDS automatically turns on, and the frequency display changes to the station name. However, when the signals of that station become weak, the display changes from the station name to the frequency.

## ⌘ Radio Frequency Manual Tune Screen

You can tune the range of FM frequency between 87.7 to 107.9MHz and range of AM frequency between 530 to 1710kHz.

Select , then trace the numbers of the radio frequency on the A-zone touchpad. When **KEYPAD** is selected, the on-screen keyboard appears.



## ■ HD Subchannel

Displays the subchannel list when an HD Radio™ station is selected while listening to an FM station.

1. Select  icon.
2. Select the channel number.



## ■ AM/FM Settings

Change the AM/FM settings.

1. Select **MENU**.
2. Select **HD Radio Setting**.
3. Select **Automatic** or **Analog Only**.

## Playing SiriusXM® Radio

### Channel Up/Down Icons

Select  or  to the previous or next channel.  
Select and hold to rapidly skip 10 channels at a time.

### Album Art

### Favorite Channel Icons, Add Favorite

Tune the channel for favorite channel. Select **Add Favorite** to store the channel.

Swipe left or right the A-zone touchpad to display the next or previous favorite channel list.

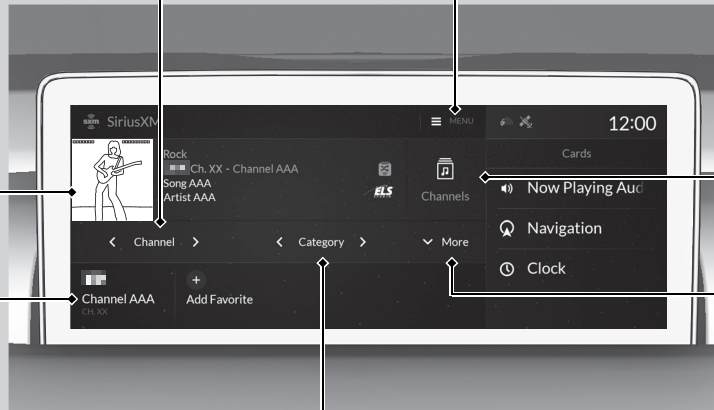

### MENU

Select to display the menu screen.



### Channels

Select to display the channel list screen.

### More

Select to display the additional function items.  
Select **Less** to close the additional function items.

### Category Icons

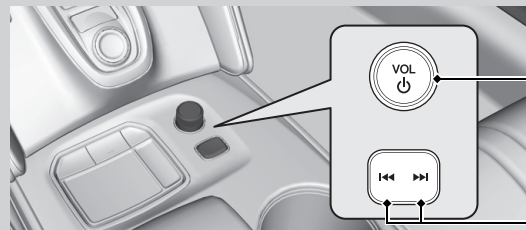

Select  or  to change the category.



### VOL (Volume/Power) Knob

Push to turn the audio system on and off. Turn to adjust the volume.

### (Seek/Skip) Button

Press  or  to the previous or next channel.  
Press and hold to rapidly skip 10 channels at a time.

## ■ To Change the Tune Mode

1. Select **MENU**.
2. Select **SiriusXM Settings**.
3. Select **Tune Mode**.
4. Select **All Channels** or **Within Category**.

## ▶▶ Playing SiriusXM® Radio

In the channel mode, all available channels are selectable. In the category mode, you can select a channel within a category (Jazz, Rock, Classical, etc.).

There may be instances when SiriusXM® Radio does not broadcast all the data fields (artist name, title). This does not indicate a problem with your audio system.

SiriusXM® Radio stations load in ascending order, which can take about a minute. Once they have loaded you will be able to scroll up or down to make your selections.

### Switching the Audio Mode

Press the **APPS** button on the steering wheel, then select an item or select the audio source icon on the home screen.

▶▶ **Audio Remote Controls** P. 206

### Tune Start:

When you change to a favorite channel, a song being played on that channel restarts from the beginning with this function. This can be turned on or off by the following procedure.

1. Select **MENU**.
2. Select **SiriusXM Settings**.
3. Select **Tune Start**.
4. Select **On** or **Off**.

To change a category, select **Category** icons, or select **Channels** and then select category item.

*Continued*

## Favorite Channel

To add a favorite channel:

1. Tune to the selected channel.
2. Select **Add Favorite**, then select **CURRENT CHANNEL**.
  - ▶ When you select **From Channels**, you can store a channel from the channel list.

### Editing a favorite channel

Select and hold to desired favorite channel.

The following items are available:

- **Remove Favorite:** Delete the favorite channel from the favorite channel list.
- **Replace with Ch** (number): Replace the stored favorite channel.
- **Create TuneMix:** Create a favorite multi-channel.
- **Add to Home Page:** Add the shortcut icon of the stored favorite channel to the home screen.
- **Add to Heads-Up Display\***: Add the shortcut item of the stored favorite channel to the head-up display menu.

## Favorite Channel

You can store 12 SiriusXM® channels in the favorite channel list.

## ■ Favorite multi-channel (for music channels only)

You can store up to 20 of your preferred music channels per favorite channel.

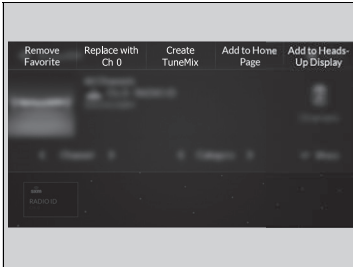

To create a favorite multi-channel:

1. Tune a channel.
2. Select and hold a number that you want to use as a favorite multi-channel.
3. Select **Create TuneMix**.
  - ▶ The number you have selected will be registered as a favorite multi-channel number, and the channel that you have tuned will be registered with this number.

To add a channel to a favorite multi-channel:

1. Tune a channel.
2. Select and hold a favorite multi-channel number.
3. Select **Edit TuneMix**.
4. Select **Add Channel**.
  - ▶ Current channel is added to the TuneMix.
  - ▶ A message appears if the current channel cannot be added to the TuneMix.

## ☒ Favorite multi-channel (for music channels only)

When you want to replace the channel, select

**Replace with Ch** (number).

If you want to delete a channel, select **Edit TuneMix**, and then select the channel you want to delete.

## ■ Listening to Featured Channels

Suggested channel listing received from SiriusXM® can be displayed and selected.

1. Select **Channels**.
2. Select featured channel category.
3. Select featured channel.



### ▶▶ Listening to Featured Channels

Up to eight featured channels by SiriusXM® can be displayed.

Select **SEARCH LIST**, then trace the letters and/or numbers of the channel on the A-zone touchpad. When **KEYBOARD** is selected, the on-screen keyboard appears.

## ■ Replay Function

The system can record up to the last 60 minutes broadcast of your currently tuned channel as well as the last 30 minutes broadcast of favorite channels, starting from the moment you turn the vehicle on. If you tuned to favorite channel, the system records up to 60 minutes of a broadcast instead of up to 30 minutes. You can rewind and replay the last 30 or 60 minutes of a broadcast.

1. Select **More**.
2. Move the position you want to replay by selecting  or .

To play or pause on playback mode, select the play/pause icon.

## ■ Returning to real-time broadcast

Select and hold  or select **Live**.

## ▶▶ Replay Function

The system starts storing broadcast in memory when the power mode is turned ON. You can go back to the program from that point.

You can no longer replay any program once the power mode is turned off as it erases memory. You can check how long the program has been stored in memory from the audio/information screen.

After 30 or 60 minutes of recording the system will automatically start deleting the oldest data.

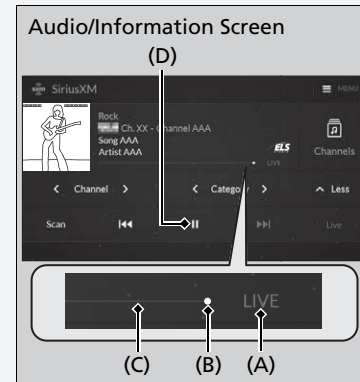

- (A): Shows how much time the replayed segment is behind the real-time broadcast  
 (B): Replayed segment  
 (C): Length stored in memory  
 (D): Play/Pause icon

Continued

## ■ Live Sports Alert

While listening to other channel, you can receive sports alerts such as scores from your favorite teams.

### ■ To set up a favorite team

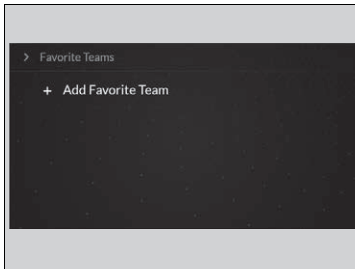

1. Select **MENU**.
2. Select **SiriusXM Settings**.
3. Select **Sports Notification Setup**.
4. Select **Edit Favorite Teams**.
5. Select **Add Favorite Team**.
6. Select a team.

### ■ To set up an alert message

1. Select **MENU**.
2. Select **SiriusXM Settings**.
3. Select **Sports Notification Setup**.
4. Select **SportsFlash Game Play Notifications**.
5. Select **Notifications**.
6. Select **On**.
7. Select **Select SportsFlash Teams**.
8. Select a registered team.
  - ▶ Press the  (back) button, the screen returns to the previous screen.

## ▶▶ Live Sports Alert

The Pop-up appears and notifies you of a sports alert function.



## ■ Game Start Notification

You can receive a sports channel notification when registered sports team start playing.

### ■ To set up a game start notification

1. Select **MENU**.
2. Select **SiriusXM Settings**.
3. Select **Sports Notification Setup**.
4. Select **Game Notifications**.
5. Select **On**.

### ■ Receiving a game start notification

1. A pop-up appears on the B-zone and notifies you of a game start notification.
2. Select the system status area then press the B-zone touchpad.
  - ▶ The status items appear on the A-zone.
3. Select a SiriusXM® notification item using A-zone touchpad to see the details.

## ⌘ Game Start Notification

Before receiving a game start notification, register a favorite sports team.

- ▶ **To set up a favorite team** P. 246

## ■ Traffic and Weather Information

You can receive traffic and weather information.

1. Select **MENU**.
2. Select **SiriusXM Settings**.
3. Select **Traffic & Weather Setup**.
4. Select **Selected City**.
5. Select the region.

### ■ Receiving a traffic and weather information

1. A pop-up will appear in the B-zone to notify you that new traffic and weather information is available.
2. Select the system status area, then press B-zone touchpad.
  - ▶ The status area will appear in the A-zone.
3. To see the details, select an item using A-zone touchpad.
  - ▶ The traffic and weather information will appear in the B-zone.
  - ▶ Select **Keep Listening** to continue receiving traffic and weather information.
  - ▶ Select **Return to Ch** (channel number) to stop viewing traffic and weather information.

## ☒ Traffic and Weather Information

When traffic and weather information is received, a notification is displayed in the B-zone.

☒ **B-Zone** P. 214

## ■ Channel Schedule

You can view a channel schedule or receive a alert when your favorite program is about to start.

### ■ To view a channel schedule

1. Select **MENU**.
2. Select **Channel Schedule**.

### ■ To set up an alert message

1. Select **MENU**.
2. Select **Channel Schedule**.
3. Select a program.
4. Select **Set Program Alert**.
5. Select **One Time** or **Every Time**.

### ☒ Channel Schedule

Select **SEARCH LIST**, then trace the letters and/or numbers of the channel on the A-zone touchpad. When **KEYBOARD** is selected, the on-screen keyboard appears.

### ☒ To set up an alert message

The Pop-up appears and notifies you of an alert function.

Selecting **One Time** disables the alert feature next time you turn the power mode to ON.

If you want to delete the alert, select **Remove Alert**.

To enable an alert message, change settings for the alert function.

☒ **To enable the alert function** P. 250

## ■ Manage Program Alert

You can change settings for the alert function.

### ■ To enable the alert function

1. Select **MENU**.
2. Select **SiriusXM Settings**.
3. Select **Manage Program Alerts**.
4. Select **Notifications**.
5. Select **On** or **Off**.

### ■ To remove an alert

1. Select **MENU**.
2. Select **SiriusXM Settings**.
3. Select **Manage Program Alerts**.
4. Select **Alerts Set**.
5. Select an item you want to delete.
  - ▶ A confirmation message appears on the screen. Select **Delete**.

## ■ Scan

Sample each channel on the selected mode for 10 seconds.

1. Select **More**.
2. Select **Scan**.

You can change a scan mode by the following procedure.

1. Select **MENU**.
2. Select **SiriusXM Settings**.
3. Select **Scan Mode**.
4. Select **Channels** or **Favorites**.

To turn off scan, select **Stop**.

## ☒ Scan

The favorites scan function is based on TuneScan™ technology of SiriusXM®.

The "Featured Channels" function is based on Featured Favorites™ technology of SiriusXM®.

TuneScan™ and Featured Favorites™ are registered trademarks of SiriusXM® Radio, Inc.

## ■ SiriusXM Settings

Change the SiriusXM® settings.

1. Select **MENU**.
2. Select **SiriusXM Settings**.
3. Select an option.
  - **Tune Mode:** Choose whether to group by category or channel number when changing channels.
  - **Scan Mode:** Select the scan mode from all channels or favorites.
  - **Tune Start:** Start the currently playing song at the beginning when you switch to a music channel favorite.
  - **Sports Notification Setup:** Set to receive sports alerts such as scores from your favorite teams.
    - ▶ **Live Sports Alert** P. 246
  - **Traffic & Weather Setup:** Set to receive traffic and weather information.
    - ▶ **Traffic and Weather Information** P. 248
  - **Manage Program Alerts:** Change settings for the alert function.
    - ▶ **Manage Program Alert** P. 250

## Playing an iPod

Using your USB connector, connect the iPod to the USB port  (2.5A), then select the USB mode.

 **USB Ports** P. 203

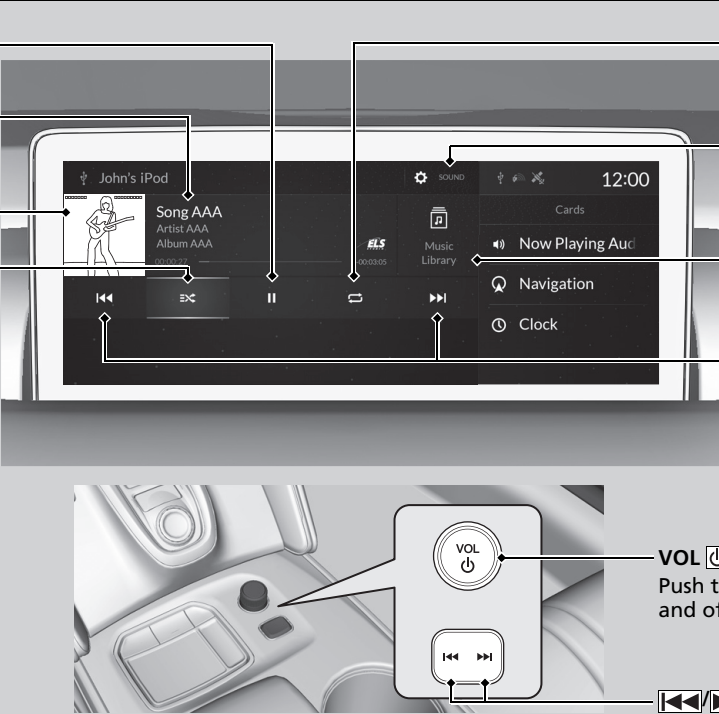

**Play/Pause Icon** — Select to play or pause the current song.

**Current Song Information** — Select to display the play list screen.



**Album Art** — Select to display the album art.

**Shuffle Icon** — Select to change a play mode in album shuffle or shuffle all songs.





**Repeat Icon** — Select to repeat the current song.

**SOUND** — Select to display the sound settings.

**Music Library** — Select to display the music search screen.

**Skip/Seek Icons** — Select  or  to change songs. Select and hold to move rapidly within a song.

**VOL  (Volume/Power) Knob** — Push to turn the audio system on and off. Turn to adjust the volume.

** /  (Seek/Skip) Button** — Press  or  to change songs. Press and hold to move rapidly within a song.

## How to Select a Song from the Music Search List

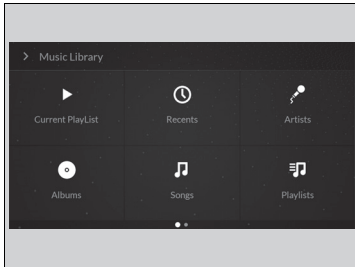

1. Select **Music Library**.
2. Select a search category (e.g., Artists, Albums, etc.).
3. Continue making selections until you find the song of your choice.

## ▶▶ Playing an iPod

Available operating functions vary on models or versions. Some functions may not be available on the vehicle's audio system.

If there is a problem, you may see an error message on the audio/information screen.

▶ **iPod/USB Flash Drive** P. 274

If you operate the music app on your iPhone/iPod while the phone is connected to the audio system, you may no longer be able to operate the same app on the audio/information screen. Reconnect the device if necessary.

Select **SEARCH LIST**, then trace the letters and/or numbers of the song on the A-zone touchpad. When **KEYBOARD** is selected, the on-screen keyboard appears.



## How to Select a Play Mode

You can change the playback mode for a song.

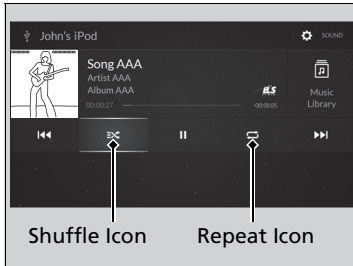

### ■ Shuffle/Repeat

Repeatedly select the shuffle or repeat icon until you find a play mode option of your preference.

## ▶▶ How to Select a Play Mode

Play Mode Menu Items

### Shuffle



(shuffle off): Shuffle mode to off.



<sup>\*1</sup> (shuffle all songs): Plays all available songs in a selected list (playlists, artists, albums, songs, genres, or composers) in random order.

### Repeat



(repeat off): Repeat mode to off.



<sup>\*1</sup> (repeat song): Repeats the current song.



<sup>\*1</sup> (repeat all): Repeats the all songs in current playlist.

<sup>\*1</sup>: A play mode icon glows when selected.

## Playing a USB Flash Drive

Your audio system reads and plays audio files on a USB flash drive in either format of MP3, WMA, AAC\*, etc.

▶ **Playable audio file** P. 279

Connect your USB flash drive to the USB port  (2.5A), then select the USB mode.

▶ **USB Ports** P. 203

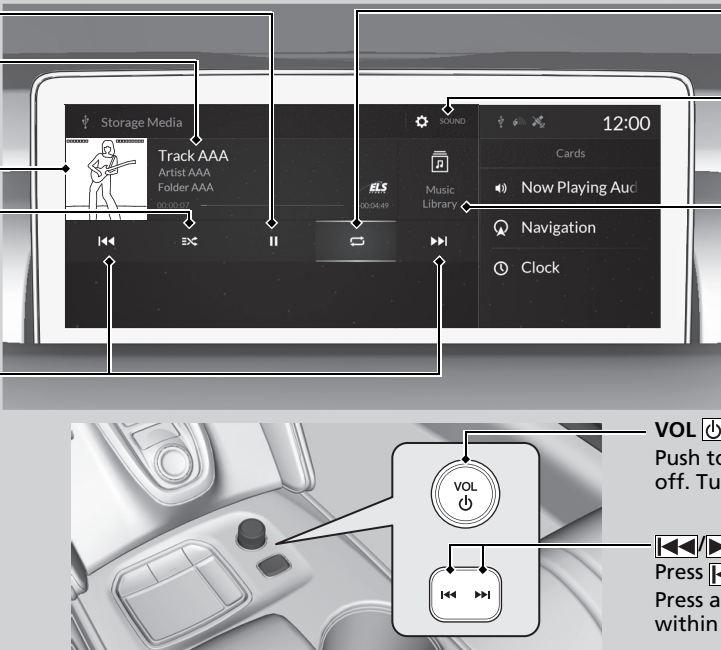



**Play/Pause Icon** — Select to play or pause the current file.

**Current File Information** — Select to display the play list screen.

**Album Art** — Select to display the album art.

**Random Icon** — Select to play all files in the current category in random order.



**Skip/Seek Icons** — Select  or  to change files. Select and hold to move rapidly within a file.

**Repeat Icon** — Select to repeat the current file.

**SOUND** — Select to display the sound settings.

**Music Library** — Select to display the music search screen.

**VOL  (Volume/Power) Knob** — Push to turn the audio system on and off. Turn to adjust the volume.

** (Seek/Skip) Button** — Press  or  to change files. Press and hold to move rapidly within a file.

\*1: Only AAC format files recorded with iTunes are playable on this unit.

## How to Select a File from the Music Search List

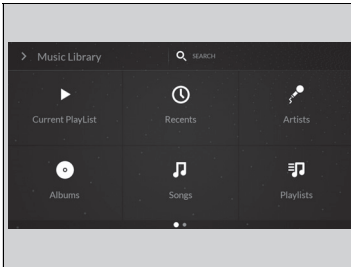

1. Select **Music Library**.
2. Select a search category (e.g., Artists, Albums, etc.).
3. Continue making selections until you find the file of your choice.

## ▶▶ Playing a USB Flash Drive

Use the recommended USB flash drives.

▶ **General Information on the Audio System**  
P. 277

WMA files protected by digital rights management (DRM) cannot be played.  
The audio system skips to the next file.

If there is a problem, you may see an error message on the audio/information screen.

▶ **iPod/USB Flash Drive** P. 274

Select **SEARCH** or **SEARCH LIST**, then trace the letters and/or numbers of the song on the A-zone touchpad. When **KEYBOARD** is selected, the on-screen keyboard appears.

## ■ How to Select a Play Mode

You can select repeat and random modes when playing a file.

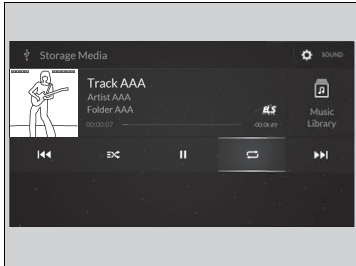

### ■ Random/Repeat

Repeatedly select the shuffle or repeat icon until you find a play mode option of your preference.

## ▶▶ How to Select a Play Mode

Play Mode Menu Items

### Random



(random off): Random mode to off.



\*1 (random in folder): Plays all files in current playlist.

### Repeat



\*1 (repeat file): Repeats the current file.



\*1 (repeat folder): Repeats all files in the current folder.

\* 1: A play mode icon glows when selected.

## Playing *Bluetooth*® Audio

Your audio system allows you to listen to music from your *Bluetooth*-compatible phone.

This function is available when the phone is paired and connected to the vehicle's *Bluetooth*® HandsFreeLink® (HFL) system.

📞 **Phone Setup** P. 333

### ▶▶ Playing *Bluetooth*® Audio

Not all *Bluetooth*-enabled phones with streaming audio capabilities are compatible with the system. For a list of compatible phones:

- U.S.: Visit [www.handsfreelink.com/Acura](http://www.handsfreelink.com/Acura) or call 1-888-528-7876.
- Canada: For more information on smartphone compatibility, call 1-855-490-7351.

It may be illegal to perform some data device functions while driving.

**Play/Pause Icon** — Select to play or pause the current track.

**Current Track Information** — Select to display the play list screen.

**Random Icon** — Select to play all files in the current folder in random order.

**Track Icons** — Select **⏮** or **⏭** to change tracks. Select and hold to move rapidly within a track.

**Repeat Icon** — Select to repeat the current file.

**MENU** — Select to display the menu items.

**Bluetooth® Indicator** — Appears when your phone is connected to HFL.

**Music Library** — Select to display the music search screen.

**VOL (Volume/Power) Knob** — Push to turn the audio system on and off. Turn to adjust the volume.

**⏮/⏭ (Seek/Skip) Button** — Press **⏮** or **⏭** to change tracks. Press and hold to move rapidly within a track.

Continued

## ■ To Play *Bluetooth*® Audio Files

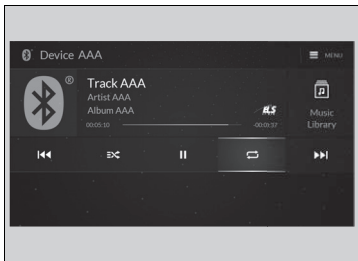

### ■ To pause or resume a file

Select the play/pause icon.

1. Make sure that your phone is paired and connected to the system.

▶ **Phone Setup** P. 333

2. Select the *Bluetooth*® Audio mode.

If the phone is not recognized, another HFL-compatible phone, which is not compatible for *Bluetooth*® Audio, may already be connected.

## ▶▶ To Play *Bluetooth*® Audio Files

Only one phone can be used with HFL at a time. When there are more than two paired phones in the vehicle, the first paired phone the system finds is automatically connected.

Different devices can be connected respectively to *Bluetooth*® hands-free phone and *Bluetooth*® Audio functions.

If more than one phone is paired to the HFL system, there may be a delay before the system begins to play.

In some cases, the name of the artist, album, or track may not appear correctly. Some functions may not be available on some devices.

If a phone is currently connected via Apple CarPlay or Android Auto, *Bluetooth*® Audio from that phone will be unavailable. However, you can have a second previously paired phone stream *Bluetooth*® Audio by selecting  from the *Bluetooth*® device list.

▶ **Phone Setup** P. 333

To play the audio files, you may need to operate your phone. If so, follow the phone maker's operating instructions.

Switching to another mode pauses the music playing from your phone.

You can change the connected phone by selecting **MENU** and **Change Device**.

▶ **Phone Setup** P. 333

## ■ Searching for Music

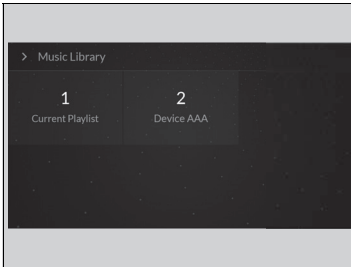

1. Select **Music Library**.
2. Select a search category (e.g., Albums).
3. Select an item.
  - ▶ The selection begins playing.

### ☒ Searching for Music

Depending on the *Bluetooth*® device you connect, some or all of the lists may not be displayed.

## Wi-Fi Connection

You can connect the audio system to the Internet using Wi-Fi on the audio/information screen. If your phone has wireless hotspot capabilities, the system can be tethered to the phone. Use the following steps to setup.

### Connecting to a Wi-Fi Hotspot

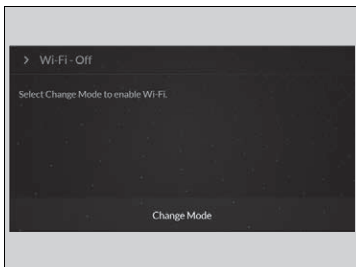

1. Press the  (home) button.

2. Select **Settings**.

3. Select **Connections**.

4. Select **Wi-Fi**.

5. Select **Change Mode**.

6. Select **Network**.

▶ Select the access point you want to connect to the system.

▶ When you change the mode from **Hotspot** to **Network**, a pop-up appears, then select **Confirm**.

7. Select **Connect**.

▶ Enter a password for the access point.

▶ When the connection is successful, **Connected** is displayed on the list.

8. Press the  (home) button to go back to the home screen.

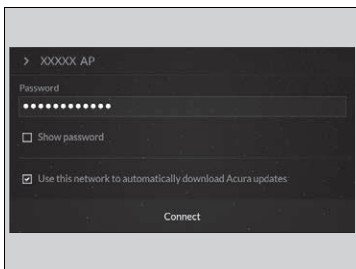

### Wi-Fi Connection

Wi-Fi and Wi-Fi Direct a registered trademark of Wi-Fi Alliance®.



### Connecting to a Wi-Fi Hotspot

You cannot go through the setting procedure while a vehicle is moving. Park in a safe place to set the audio system in Wi-Fi mode.

Some cell phone carriers charge for tethering and smartphone data use. Check your phone's data subscription package.

Check your phone manual to find out if the phone has Wi-Fi connectivity.

You can confirm whether Wi-Fi connection is on or off with the  icon on the system status area. Transmission speed and others will not be displayed on this screen.

 **Status Area** P. 221

In case of Wi-Fi connection with your phone, make sure your phone's Wi-Fi setting is in access point (tethering) mode.





## ■ Wi-Fi mode (after the initial setting has been made)

Make sure your phone's Wi-Fi setting is in access point (tethering) mode.

## ■ Setting the Audio System as a Wi-Fi Hotspot

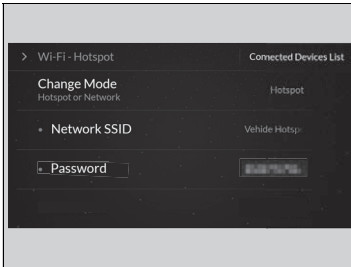
You can set the network as a Wi-Fi Hotspot of this audio system.  
Use the following steps to setup.



1. Press the  (home) button.
2. Select **Settings**.
3. Select **Connections**.
4. Select **Wi-Fi**.
5. Select **Change Mode**.
6. Select **Hotspot**.
  - ▶ When you change the mode from **Network** to **Hotspot**, a pop-up appears, then select **Confirm**.

The following options are available for the setup.

- **Network SSID:** Set this network name.
- **Password:** Set password for require entering password when connecting Wi-Fi device to this network.
- **Connected Devices List:** Display the connected device list. Up to seven devices can be connected to this network.

## ▶▶ Wi-Fi mode (after the initial setting has been made)

### iPhone users

You may need to go through an initial setup for Wi-Fi connection again after you boot your phone.

## AT&T Hotspot

If you have subscribed to AT&T hotspot services, your vehicle will provide data to connect your mobile devices to the Internet. You can use the AT&T Hotspot app to turn on/off vehicle data and monitor data usage left on your subscription.

### ▶ AT&T Hotspot

To use AT&T Hotspot services, your vehicle must be subscribed to a data plan. If your vehicle is not subscribed to a data plan, you can visit [www.att.com/acura](http://www.att.com/acura) to add vehicle data services.

Hotspot username and password can be changed in the **Settings** of the AT&T Hotspot app. **Settings** can not be accessed while driving. Park in a safe place to adjust Hotspot settings.

Alternatively, you can use your mobile hotspot to connect the vehicle and other mobile devices to the Internet.

▶ **Wi-Fi Connection** P. 262

### ■ AT&T Hotspot Menu

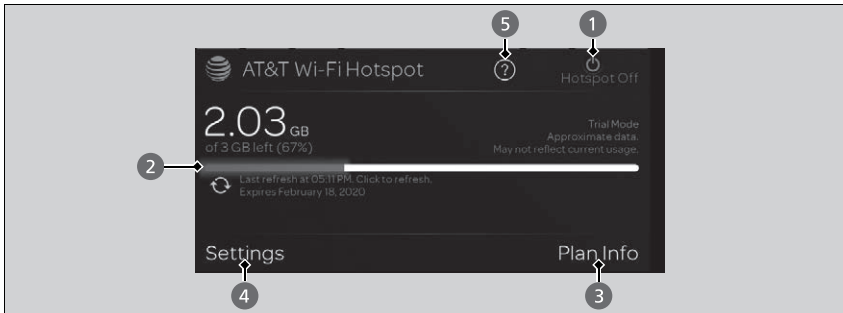

#### 1 Hotspot Enable

Turn on/off AT&T Hotspot.

#### 2 Data Usage Bar

Check the current status of your data plan. This Usage Bar will show your current plan and how much data remains on your plan. Subscription plans for AT&T Hotspot can be added/modified at [www.att.com/acura](http://www.att.com/acura).

#### 3 Plan Info

Shows your current AT&T subscription plan for the vehicle.

#### 4 Settings

Shows the current username and password for vehicle Hotspot. **Settings** can be changed while the vehicle is not in motion.

#### 5 Help

## Siri Eyes Free

You can talk to Siri using to press and hold the  (Talk) button on the steering wheel when your iPhone is paired to the *Bluetooth*® HandsFreeLink® (HFL) system.

 **Phone Setup** P. 333

### Using Siri Eyes Free

While in Siri Eyes Free:  
The display remains the same.  
No feedback or commands appear.

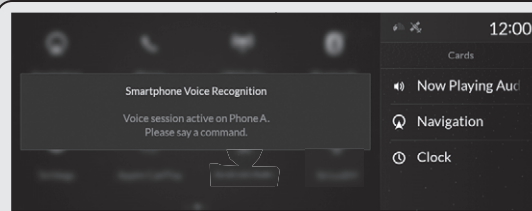

Appears when Siri is activated in Siri Eyes Free

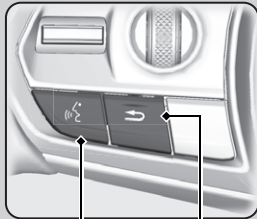

 **(Back) Button**  
Press to deactivate Siri.

 **(Talk) Button**  
Press and hold until the display changes as shown.  
Press again to deactivate Siri.

#### ▶▶ Siri Eyes Free

Siri is a trademark of Apple Inc.

Check Apple Inc. website for features available for Siri.

While driving we recommend only using Siri through the  button on the steering wheel (Siri Eyes Free).

#### ▶▶ Using Siri Eyes Free

Some commands work only on specific phone features or apps.

Press the  (back) button on the True Touchpad Interface to deactivate Siri.

## Apple CarPlay

If you connect an Apple CarPlay-compatible iPhone to the system via the USB port (2.5A), you can use the audio/information screen, instead of the iPhone display, to make a phone call, listen to music, view maps (navigation), and access messages.

➤ **USB Ports** P. 203

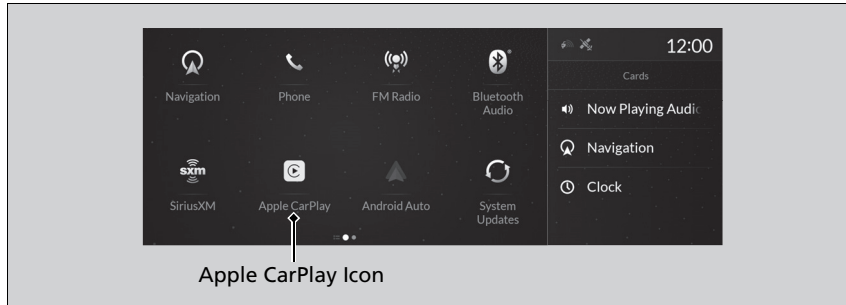

### ➤ Apple CarPlay

Only iPhone 5 or newer versions with iOS 8.4 or later are compatible with Apple CarPlay.

Park in a safe place before connecting your iPhone to Apple CarPlay and when launching any compatible apps.

While connected to Apple CarPlay, calls are only made through Apple CarPlay. If you want to make a call with *Bluetooth®* HandsFreeLink®, turn Apple CarPlay off.

➤ **Setting Up Apple CarPlay** P. 268

When your iPhone is connected to Apple CarPlay, it is not possible to use the *Bluetooth®* Audio or *Bluetooth®* HandsFreeLink®. However, other previously paired phones can stream audio via *Bluetooth®* while Apple CarPlay is connected.

➤ **Phone Setup** P. 333

For details on countries and regions where Apple CarPlay is available, as well as information pertaining to function, refer to the Apple homepage.

## Apple CarPlay Menu

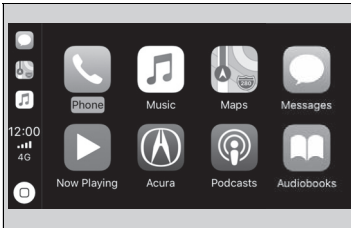

- **Phone**  
Access the contact list, make phone calls, or listen to voice mail.
- **Music**  
Play music stored on your iPhone.
- **Maps**  
Display Apple Maps and use the navigation function just as you would on your iPhone.

### Models with navigation system

Only one navigation system (pre-installed navigation or Apple CarPlay) can give directions at a time. When you are using one system, directions to any prior destination set on the other system will be canceled, and the system you are currently using will direct you to your destination.

- **Messages**  
Check and reply to text messages, or have messages read to you.
- **Acura**  
Select the Acura icon to go back to the home screen.
-   
Go back to the Apple CarPlay menu screen.

## Apple CarPlay

### Apple CarPlay Operating Requirements & Limitations

Apple CarPlay requires a compatible iPhone with an active cellular connection and data plan. Your carrier's rate plans will apply.

Changes in operating systems, hardware, software, and other technology integral to providing Apple CarPlay functionality, as well as new or revised governmental regulations, may result in a decrease or cessation of Apple CarPlay functionality and services. Acura cannot and does not provide any warranty or guarantee of future Apple CarPlay performance or functionality.

It is possible to use 3rd party apps if they are compatible with Apple CarPlay. Refer to the Apple homepage for information on compatible apps.

## ■ Setting Up Apple CarPlay

After you have connected your iPhone to the system via the USB port  (2.5A), use the following procedure to set up Apple CarPlay. Use of Apple CarPlay will result in the transmission of certain user and vehicle information (such as vehicle location, speed, and status) to your iPhone to enhance the Apple CarPlay experience. You will need to consent to the sharing of this information on the audio/information screen.

## ■ Enabling Apple CarPlay

1. Connect the iPhone to the USB port using the USB cable.
  - 📖 **USB Ports** P. 203
  - ▶ The confirmation screen will be displayed.
2. Select **Enable Apple CarPlay**.
  - ▶ If you do not want to connect Apple CarPlay, select **Do Not Enable Apple CarPlay**.

You may change the consent settings under the **Connections** settings menu.

## 🔗 Setting Up Apple CarPlay

You can also use the method below to set up Apple CarPlay:

Press the  (home) button → Select Settings → Connections → Apple CarPlay → Select device → Allow Apple CarPlay

### **Use of user and vehicle information**

The use and handling of user and vehicle information transmitted to/from your iPhone by Apple CarPlay is governed by the Apple iOS terms and conditions and Apple's Privacy Policy.

## ■ Operating Apple CarPlay with Siri

Press and hold the  (Talk) button to activate Siri.

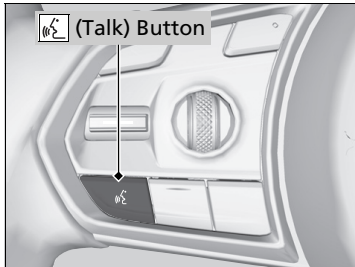

### (Talk) Button:

Press and hold to activate Siri.

Press again to deactivate Siri.

Press and release to activate standard voice recognition system.

## ▣ Operating Apple CarPlay with Siri

Below are examples of questions and commands for Siri:

- What movies are playing today?
- Call dad at work.
- What song is this?
- How's the weather tomorrow?
- Read my latest email.
- Find a table for four tonight in Chicago.

For more information, please visit  
[www.apple.com/ios/siri](http://www.apple.com/ios/siri).

## Android Auto

When you connect an Android phone to the audio system via the USB port  (2.5A), Android Auto is automatically initiated. When connected via Android Auto, you can use the audio/information screen to access the Phone, Google Maps (Navigation), Google Play Music, and Google Now functions. When you first use Android Auto, a tutorial will appear on the screen.

We recommend that you complete this tutorial while safely parked before using Android Auto.

 **USB Ports** P. 203

 **Auto Pairing Connection** P. 272

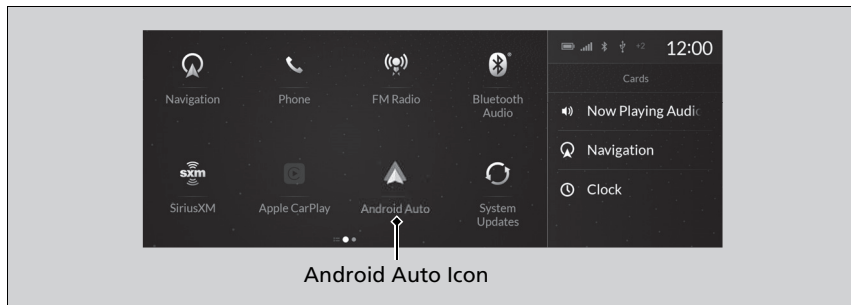



Android Auto Icon

### Android Auto

Only Android 5.0 (Lollipop) or later versions are compatible with Android Auto. Bluetooth A2DP cannot be used with Android Auto phone.

To use Android Auto on a smartphone with Android 9.0 (Pie) or earlier, you need to download the Android Auto app from Google Play to your smartphone.

Park in a safe place before connecting your Android phone to Android Auto and when launching any compatible apps.

To use Android Auto, connect the USB cable to the USB port  (2.5A). The USB port  (2.5A) is used only for charging.

 **USB Ports** P. 203

When your Android phone is connected to Android Auto, it is not possible to use the *Bluetooth*® Audio. However, other previously paired phones can stream audio via *Bluetooth*® while Android Auto is connected.

 **Phone Setup** P. 333



## Android Auto Menu

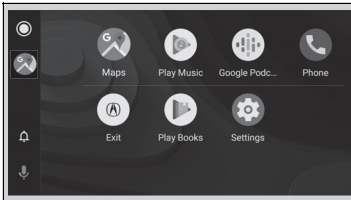

- **Maps**

Display Google Maps and use the navigation function just as you would with your Android phone. When the vehicle is in motion, it is not possible to make keyboard entries. Stop the vehicle in a safe location to undertake a search or provide other inputs.

### Models with navigation system

Only one navigation system (pre-installed navigation or Android Auto) can give directions at a time. When you are using one system, directions to any prior destination set on the other system will be canceled, and the system you are currently using will direct you to your destination.

The audio/information screen shows you turn-by-turn driving directions to your destination.

- **Play Music**

Play Google Play Music and music apps that are compatible with Android Auto. To switch between music apps, select this icon.

- **Phone**

Make and receive phone calls as well as listen to voicemail.

- **Exit**

Select the **Exit** icon to go back to the home screen.

### Android Auto



For details on countries and regions where Android Auto is available, as well as information pertaining to function, refer to the Android Auto homepage.

### Android Auto Operating Requirements & Limitations

Android Auto requires a compatible Android phone with an active cellular connection and data plan. Your carrier's rate plans will apply.

Changes in operating systems, hardware, software, and other technology integral to providing Android Auto functionality, as well as new or revised governmental regulations, may result in a decrease or cessation of Android Auto functionality and services. Acura cannot and does not provide any warranty or guarantee of future Android Auto performance or functionality.

It is possible to use 3rd party apps if they are compatible with Android Auto. Refer to the Android Auto homepage for information on compatible apps.

-  Operate Android Auto with your voice.
-  You can check Android notifications.
-  (Android Auto Home)  
Display useful information organized by Android Auto into simple cards that appear just when they're needed.

## ■ Auto Pairing Connection

When you connect an Android phone to the unit via the USB port  (2.5A), Android Auto is automatically initiated.

### ■ Enabling Android Auto

To enable Android Auto after connecting an Android phone to the system, select **Enable Android Auto** on the screen.

You may change the consent settings under the **Connections** settings menu.

### ☒ Enabling Android Auto

Only initialize Android Auto when you safely parked. When Android Auto first detects your phone, you will need to set up your phone so that auto pairing is possible. Refer to the instruction manual that came with your phone.

You can use the method below to change Android Auto settings after you have completed the initial setup:

Press the  (home) button → Select Settings → Connections → Android Auto → Select device

### Use of user and vehicle information

The use and handling of user and vehicle information transmitted to/from your phone by Android Auto is governed by the Google's Privacy Policy.

## ■ Operating Android Auto with Voice Recognition

Press and hold the  (Talk) button to operate Android Auto with your voice.

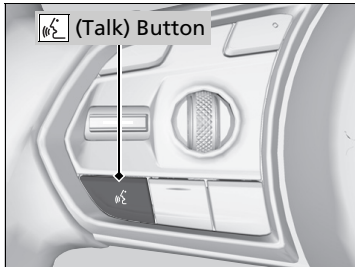

### (Talk) Button:

Press and hold to operate Android Auto with your voice.

Press and release to activate standard voice recognition system.

## ☒ Operating Android Auto with Voice Recognition

Below are examples of commands you can give with voice recognition:

- Reply to text.
- Call my wife.
- Navigate to Acura.
- Play my music.
- Send a text message to my wife.
- Call flower shop.

For more information, please refer to the Android Auto homepage.

You can also activate the voice recognition function by selecting the  icon in the lower-left corner of the screen.

## iPod/USB Flash Drive

If an error occurs while playing an iPod or USB flash drive, you may see the following error messages. If you cannot clear the error message, contact a dealer.

Error Message	Solution
<b>USB Error</b>	<p>Appears when an incompatible device is connected. Disconnect the device. Then turn the audio system off, and turn it on again. Do not reconnect the device that caused the error.</p> <p><b>iPod</b> Appears when an unsupported iPod is connected. If it appears when a supported iPod is connected, update the iPod software to the newer version.</p> <p><b>USB flash drive</b> Appears when an unsupported device is connected. If it appears when a supported device is connected, reconnect the device.</p> <p>Appears when unsupported formats are in the device. Check that compatible files are stored on the device.</p>
<b>The selected file cannot be played on this system</b>	<p>Appears when the files in the USB flash drive are copyright protected or an unsupported format.</p>
<b>No Data</b>	<p><b>iPod</b> Appears when the iPod is empty.</p> <p><b>USB flash drive</b> Appears when the USB flash drive is empty.</p> <p><b>iPod and USB flash drive</b> Check that compatible files are stored on the device.</p>
<b>USB Hub Error</b>	<p>Appears when the USB hub with plural USB devices is connected. Disconnect the USB hubs and directly connect the device to the USB port using the extension cable.</p>

## Android/Apps

If an error occurs while using the audio system or apps, you may see the following error messages. If you cannot clear the error message, contact a dealer.

Error Message	Solution
Unfortunately, **** has stopped.* <sup>1</sup>	Error has occurred within app, select <b>OK</b> on the screen to close the app.
**** isn't responding. Do you want to close it?*	<p>App is not responding.            Select <b>Wait</b> if you can wait for a response from app a little longer. If it does not respond even if you keep waiting, select <b>OK</b> to close the app and start it up. If the error message continues, perform <b>Factory Data Reset</b>.</p> <p>➤ <b>Defaulting All the Settings</b> P. 323</p>

\*1:\*\*\*\*part is variable characters, and will change depending upon where an error occurs.

## Apple CarPlay/Android Auto

If an error occurs while using the Apple CarPlay or Android Auto, you may see the following error messages. If you cannot clear the error message, contact a dealer.

Error Message	Solution
<b>Error</b>	Appears when Apple CarPlay or Android Auto fails to recognize your device. Check if your device is compatible with Apple CarPlay or Android Auto, or the latest version of the app is installed on your device.
<b>Maximum Number of Apple Carplay Devices Exceeded</b>	Appears when the number of stored Apple CarPlay devices or Android Auto devices exceeds the limitation. Select <b>Replace and Continue</b> and delete a registered device to connect a new device for the Apple CarPlay connection or Android Auto connection.
<b>Maximum Number of Android Auto Devices Exceeded</b>	
(connected device name) <b>Connected</b>	Appears when the paired device is disconnected from the HFL function. Reconnect device and try again.
<b>Bluetooth Off</b>	Appears when the <b>Bluetooth</b> setting is off. Select <b>Turn Bluetooth On</b> to turn on the <i>Bluetooth</i> ® feature.
<b>Maximum Number of Bluetooth Devices Exceeded</b>	Appears when the number of stored <i>Bluetooth</i> ® devices exceeds the limitation. Select <b>Replace and Continue</b> and delete a registered device to connect a new device for the <i>Bluetooth</i> ® connection.
<b>Bluetooth Connection Error</b>	Appears when <i>Bluetooth</i> ® connection is failed. Check the <i>Bluetooth</i> ® connection of this audio system and your connected device.
<b>Other Devices Connected to Bluetooth</b>	Appears when another registered phone is paired with the audio system. Select <b>OK</b> to select the Android Auto device.

## SiriusXM® Radio Service

### ■ Subscribing to SiriusXM® Radio

1. You need your radio ID ready before registering for subscription. To see the ID in the screen, select channel up/down icons to Ch.0.
2. Have your radio ID ready, and either call or visit the SiriusXM® website to subscribe.

### ■ Receiving SiriusXM® Radio

Switch to the SiriusXM® mode by using the audio remote controls on the steering wheel, or through the audio/information screen, and stay in this mode for about 30 minutes until the service is activated. Make sure your vehicle is in an open area with good reception.

### ■ SiriusXM® Radio Display Messages

**Channel \*\*\*\* not subscribed. Call SiriusXM to subscribe.\*1**

You are not subscribed to the channel selected.

**Subscription updated:**

SiriusXM® radio is receiving information update from the network.

**Channel Not Available:**

No such channel exists, or the artist or title information is unavailable.

**No Signal:**

The signal is too weak in the current location.

**Check Tuner:**

There is a problem with the SiriusXM® tuner. Contact a dealer.

**Check Antenna:**

There is a problem with the SiriusXM® antenna. Contact a dealer.

\*1: \*\*\*\*part is variable characters, and will change depending upon where an subscribe.

### ☒ Subscribing to SiriusXM® Radio

Contact Information for SiriusXM® Radio:

- US: SiriusXM® Radio at [www.siriusxm.com/subscribe-now](http://www.siriusxm.com/subscribe-now), or 1-866-635-2349
- Canada: SiriusXM® Canada at [www.siriusxm.ca/subscribe-now](http://www.siriusxm.ca/subscribe-now), or 1-877-209-0079

### ☒ Receiving SiriusXM® Radio

The SiriusXM® satellites are in orbit over the equator; therefore, objects south of the vehicle may cause satellite reception interruptions. Satellite signals are more likely to be blocked by tall buildings and mountains the farther north you travel from the equator.

You may experience reception problems under the following circumstances:

- In a location with an obstruction to the south of your vehicle.
- In tunnels
- On the lower level of a multi-tiered road
- Large items carried on the roof rack

## Compatible iPod, iPad, iPhone, and USB Flash Drives

### ■ iPod, iPad, and iPhone Model Compatibility

Model
Made for iPod touch (6th generation)
Made for iPhone XS Max/iPhone XS/iPhone XR/iPhone X/iPhone 8 Plus/iPhone 8/iPhone 7 Plus/iPhone 7/iPhone SE (1st generation)/iPhone 6s Plus/iPhone 6s/iPhone 6 Plus/iPhone 6/iPhone 5s
Made for iPad (6th generation)/iPad (5th generation)
Made for iPad Pro (10.5-inch)/iPad Pro 12.9-inch (2nd generation)/iPad Pro (12.9-inch)/iPad Pro (9.7-inch)
Made for iPad Air 2/iPad Air
Made for iPad mini 4/iPad mini 3/iPad mini 2

### ▣ iPod, iPad, and iPhone Model Compatibility

This system may not work with all software versions of these devices.

The Lightning connector works with iPhone XS Max, iPhone XS, iPhone XR, iPhone X, iPhone 8 Plus, iPhone 8, iPhone 7 Plus, iPhone 7, iPhone SE (1st generation), iPhone 6s Plus, iPhone 6s, iPhone 6 Plus, iPhone 6, iPhone 5s, iPad Pro (10.5-inch), iPad Pro 12.9-inch (2nd generation), iPad Pro (12.9-inch), iPad Pro (9.7-inch), iPad Air 2, iPad Air, iPad (6th generation), iPad (5th generation), iPad mini 4, iPad mini 3, iPad mini 2, iPod touch (6th generation).

USB works with iPhone XS Max, iPhone XS, iPhone XR, iPhone X, iPhone 8 Plus, iPhone 8, iPhone 7 Plus, iPhone 7, iPhone SE (1st generation), iPhone 6s Plus, iPhone 6s, iPhone 6 Plus, iPhone 6, iPhone 5s, iPad Pro (10.5-inch), iPad Pro 12.9-inch (2nd generation), iPad Pro (12.9-inch), iPad Pro (9.7-inch), iPad Air 2, iPad Air, iPad (6th generation), iPad (5th generation), iPad mini 4, iPad mini 3, iPad mini 2, iPod touch (6th generation).



## ■ USB Flash Drives

- A USB flash drive of 256 MB or higher is recommended.
- Some digital audio players may not be compatible.
- Some USB flash drives (e.g., a device with security lockout) may not work.
- Some software files may not allow for audio play or text data display.
- Some versions of playable file formats may be unsupported.

### ■ Playable audio file

Format/Codec	File Type(s)
AAC LC	3GPP (.3gp), MPEG-4 (.mp4, .m4a),
HE-AACv1 (AAC+)	ADTS raw AAC (.aac, decode in Android
HE-AACv2 (enhanced AAC+)	3.1+, encode in Android 4.0+, ADIF not supported), MPEG-TS (.ts, not seekable, Android 3.0+)
AAC ELD (enhanced low delay AAC)	
AMR-NB	
AMR-WB	3GPP (.3gp)
FLAC	FLAC (.flac) only
MIDI	Type 0 and 1 (.mid, .xmf, .mxmf), RTTTL/RTX (.rtttl, .rtx), OTA (.ota), iMelody (.imy)
MP3	MP3 (.mp3)
Opus	Matroska (.mkv)
PCM/WAVE	WAVE (.wav)
Vorbis	Ogg (.ogg), Matroska (.mkv, Android 4.0+)

### ☒ USB Flash Drives

Files on the USB flash drive are played in their stored order. This order may be different from the order displayed on your PC or device.

## Honda App License Agreement

### ■ END USER LICENSE AGREEMENT

PLEASE CAREFULLY READ THIS END USER LICENSE AGREEMENT (THIS “AGREEMENT”) WHICH GOVERNS YOUR USE OF THE SOFTWARE INSTALLED ON YOUR HONDA OR ACURA VEHICLE (YOUR “VEHICLE”) AS WELL AS THE APPLICATIONS, SERVICES, FUNCTIONS, AND CONTENT PROVIDED THROUGH THE SOFTWARE (COLLECTIVELY, THE “SERVICES”). YOUR USE OF THE SOFTWARE OR SERVICES WILL SERVE AS YOUR CONSENT TO THE TERMS OF THIS AGREEMENT. THE SOFTWARE IS OWNED (OR LICENSED), PROVIDED, AND/OR OPERATED BY AMERICAN HONDA MOTOR CO. INC., (“HONDA,” “US,” “WE,” OR “OUR”), WITH ITS BUSINESS ADDRESS AT 1919 TORRANCE BLVD., TORRANCE, CA 90501. REFERENCE TO “HONDA” IN THIS AGREEMENT INCLUDES HONDA’S PARENT COMPANY AND ITS AFFILIATES AND DESIGNATED AGENTS. THE SERVICES ARE OWNED (OR LICENSED), PROVIDED, AND/OR OPERATED BY HONDA OR A THIRD-PARTY SERVICE PROVIDER (A “PROVIDER”). REFERENCE TO A “PROVIDER” IN THIS AGREEMENT INCLUDES SUCH PROVIDER’S PARENT COMPANY, AFFILIATES, AND DESIGNATED AGENTS.

**A. Description of the Software.** The SOFTWARE includes the software, firmware and the like, installed and executing on your VEHICLE during manufacture, and thereafter updated from time to time by HONDA, you or an authorized HONDA dealer (a “DEALER”). The SOFTWARE allows you to access and use a variety of SERVICES, including but not limited to: (a) HONDA applications, services, and content provided through the SOFTWARE (together, “HONDA SERVICES”); and (b) PROVIDER applications, services, and content provided through the SOFTWARE (together, “PROVIDER SERVICES”), each of which may provide access to various information, media, content, and services.

#### **B. SOFTWARE Licensing and Intellectual Property.**

**1. SOFTWARE.** This AGREEMENT grants you a non-exclusive, limited, and revocable license to use the SOFTWARE and SERVICES solely (a) as installed on your VEHICLE by HONDA, (b) as updated on your Vehicle by HONDA, you (but only as and when directed by HONDA), or a DEALER and (c) as permitted under the terms of this AGREEMENT.

**2. HONDA Services.** The SOFTWARE may provide you with access to various HONDA SERVICES. Installation, activation, or use of HONDA SERVICES may require your consent to additional terms, conditions, and privacy policies applicable to those HONDA SERVICES (the “HONDA TERMS”). You acknowledge and agree that any collection, use, sharing of data generated by your VEHICLE or your use of your VEHICLE, and your use of the HONDA SERVICES shall be subject to this AGREEMENT and any additional HONDA TERMS that may be specifically applicable to such HONDA SERVICES or data generation. The HONDA SERVICES may collect, use, and share such data while you are using the SOFTWARE.

**3. Open-Source Software.** The SOFTWARE and SERVICES may incorporate software licensed to HONDA under free or open-source licenses which govern HONDA's distribution and your use of such software. HONDA and the third-party authors, licensors, and distributors of such software disclaim all warranties and all liability arising from any and all use or distribution of the software. To the extent such software is provided under terms that differ from the applicable free or open-source licenses, those terms are offered by HONDA alone. Additional information regarding free and open-source software incorporated in the SOFTWARE and SERVICES is available in this manual or within the SOFTWARE.

**4. Provider Services.** The SOFTWARE may provide you with access to various PROVIDER SERVICES. Installation or use of such PROVIDER SERVICES may require your consent to additional terms, conditions, and privacy policies of the applicable PROVIDER (the "PROVIDER TERMS"). This AGREEMENT restricts the manner in which you can install and use PROVIDER SERVICES but does not grant you a license or permission to use such PROVIDER SERVICES. Your permission to use PROVIDER SERVICES is limited and subject to any license grants, conditions, and limitations included in the PROVIDER TERMS. You acknowledge that any collection, use, sharing of your information, targeted advertising practices by PROVIDERS, and your use of the PROVIDER SERVICES shall be subject to both this AGREEMENT and any applicable PROVIDER TERMS. The PROVIDER SERVICES may collect, use, and share such information while you are using the SOFTWARE.

**5. License Limitations and Restrictions on Use.**

(a) Limited License. You understand and agree that the SOFTWARE and SERVICES are licensed, not sold, to you solely for use in accordance with this AGREEMENT and any applicable PROVIDER TERMS, and any documentation for the VEHICLE made available to you by HONDA (any "DOCUMENTATION"). HONDA and its licensors reserve all rights in the SOFTWARE and HONDA SERVICES not expressly granted to you under this AGREEMENT. PROVIDERS and their licensors reserve all rights in the PROVIDER SERVICES not expressly granted to you under the applicable PROVIDER TERMS.

(b) Restrictions on Use. The licenses granted under this AGREEMENT do not permit you to use the SOFTWARE or SERVICES on a device other than your VEHICLE. As a condition of using the SOFTWARE and SERVICES, you agree that you may not and will not:

- (1) copy, download, distribute, modify, publish, sell, rent, lease, lend, license, sublicense, reuse, or create derivative works of the SOFTWARE or SERVICES or any of the content or other material within the SOFTWARE or SERVICES, including without limitation, HONDA or PROVIDER names, logos, or any other trademarks of HONDA or PROVIDERS or used in association with the SOFTWARE or any SERVICES, except as required to use the SOFTWARE or SERVICES in accordance with this AGREEMENT, any applicable PROVIDER TERMS, and the DOCUMENTATION;
- (2) access or use the SOFTWARE or SERVICES in any manner intended to damage or impair the operation of the SOFTWARE or SERVICES or interfere with anyone else's use and enjoyment of the SOFTWARE or SERVICES;
- (3) access or attempt to access any system or server on which the SOFTWARE or SERVICES is hosted or modify or alter the SOFTWARE or SERVICES in any way;
- (4) use the SOFTWARE or SERVICES for any unlawful purpose, or in violation of any third party rights;
- (5) use the SOFTWARE or SERVICES in violation of any applicable traffic regulations, rules or laws, including but not limited to any driver distraction laws, rules or regulations;
- (6) violate the terms of this AGREEMENT, any HONDA TERMS, any PROVIDER TERMS or other applicable third-party terms, conditions, and privacy policies; or
- (7) reverse engineer, decompile, disassemble, attempt to derive the source code of, nor permit others to reverse engineer, decompile, or disassemble, or attempt to derive the source code of the SOFTWARE or SERVICES, except and only to the extent that such activity is expressly permitted (a) by applicable law notwithstanding this limitation or (b) the terms of applicable free or opensource software licenses.

**6. Intellectual Property Rights.** All title and intellectual property rights in and to the SOFTWARE and SERVICES, the accompanying DOCUMENTATION, and all copies of the SOFTWARE or SERVICES are owned by HONDA, PROVIDERS, or their suppliers or licensors. This AGREEMENT does not grant you any rights in connection with any trademarks or service marks of HONDA, PROVIDERS, or their licensors, affiliates, or suppliers.

**7. Export Restrictions:** You acknowledge that the SOFTWARE and SERVICES are subject to U.S., European Union, and other export jurisdictions. You agree to comply with all applicable international and national laws that apply to the SOFTWARE and SERVICES, including the U.S. Export Administration Regulations, as well as end-user, end-use, and destination restrictions issued by the U.S. and other governments.

### C. SOFTWARE Operation

- 1.** HONDA reserves the right to suspend or terminate your access to and use of the SOFTWARE or SERVICES if you are found to be in violation of this AGREEMENT or as reasonably deemed necessary by HONDA.
- 2. Eligibility/Registration/Activation.** The SOFTWARE is intended for and available to individuals who (a) are of legal age of majority in their jurisdiction of residence (and at least 18 years of age), or are younger than 18 years of age and possess a valid driver's license issued by their jurisdiction of residence, and (b) own or have permissive access to a compatible VEHICLE. We do not knowingly collect any information, including personal information, from children under 13. If we learn or are notified that we have collected personal information of a child under 13, we will immediately take steps to delete such information.
- 3. Use of PROVIDER SERVICES through the SOFTWARE.** Certain PROVIDER SERVICES made available through the SOFTWARE may require that you register or otherwise have an account with the PROVIDER and agree to PROVIDER TERMS. Any use of any of such PROVIDER SERVICES within the SOFTWARE is subject to this AGREEMENT and the applicable PROVIDER TERMS. HONDA does not exercise control over such PROVIDER SERVICES and is not responsible or liable for the availability, security, or content of such PROVIDER SERVICES, and the inclusion of any PROVIDER SERVICES does not imply a referral from, the approval of, or the endorsement by HONDA of such PROVIDER SERVICES. HONDA is not responsible or liable, directly or indirectly, for any damage relating to or resulting from your use of the PROVIDER SERVICES.
- 4. Links to Third Party Sites:** The SOFTWARE may provide you with the ability to access third-party sites and content through the use of the SOFTWARE or SERVICES. The third-party sites and content are not under the control of HONDA. HONDA is not responsible or liable, directly or indirectly, for such third-party websites and their content or for any damage relating to or resulting from your access or use of such websites and content.

**5. Unauthorized Use and Abuse.** You are responsible for ensuring your (and any authorized third parties') use of the SOFTWARE and SERVICES remains in compliance with this AGREEMENT and all other applicable HONDA TERMS and PROVIDER TERMS. You acknowledge and agree that any use of the SOFTWARE or SERVICES occurring through your VEHICLE will be deemed your actions and that HONDA and PROVIDERS may rely upon such actions. You agree to immediately notify us if you suspect fraudulent or abusive activity involving the SOFTWARE or SERVICES. If you so notify us or if we otherwise suspect fraudulent or abusive activity, you agree to cooperate with us in any fraud investigation and to use any fraud prevention measures we prescribe. Your failure to immediately notify us or cooperate to use such measures will result in your liability for all fraudulent usage or abusive activity associated with your VEHICLE.

**6. SOFTWARE Updates.** The SOFTWARE and SERVICES may be updated when your VEHICLE is serviced by a DEALER or remotely, over-the-air, by HONDA from time to time; such updates may occur with or without further notice or your future consent. The SOFTWARE may be updated at HONDA's discretion and for any purpose including, without limitation, to patch or otherwise improve the SOFTWARE or SERVICES functionality, security, or stability. All updates to the SOFTWARE and SERVICES are subject to this AGREEMENT and any other applicable HONDA TERMS and PROVIDER TERMS.

**7. Uninstalling, Removing, and Replacing the SOFTWARE.** Replacing SOFTWARE or HONDA SERVICES with software or firmware not provided and installed by HONDA or a DEALER will render all representations and warranties for the SOFTWARE, HONDA SERVICES, and VEHICLE functionality reliant upon the SOFTWARE or HONDA SERVICES null and void.

#### **D. SOFTWARE Operational Notices and Warnings**

**1. Vehicle Geolocation Information.** You acknowledge that your VEHICLE may be equipped with certain traffic and map features. The traffic feature will automatically collect and transmit, through GPS technology, your Vehicle's current location (longitude and latitude), travel direction and speed ("VEHICLE GEOLOCATION INFORMATION") to HONDA and PROVIDERS. The VEHICLE GEOLOCATION INFORMATION is used by HONDA and PROVIDERS to provide traffic and navigation-related information to you, but may also be used to provide other SERVICES or offers to you. HONDA will not use such VEHICLE GEOLOCATION INFORMATION for its own marketing efforts, or provide such information to unaffiliated third parties for their own purposes, without your express consent.

**2. Potential Map Inaccuracy and Route Safety.** Maps used by this system may be inaccurate because of changes in roads, traffic controls, routing, or driving conditions. Always use good judgment and common sense when following suggested routes. Do not follow the route suggestions if doing so would result in an unsafe or illegal driving maneuver, if you would be placed in an unsafe situation, or if you would be directed into an area that you consider unsafe. Do not rely on any navigation features included in the system to route you to emergency services. Not all emergency services such as police, fire stations, hospitals, or clinics are likely to be contained in the map database for such navigation features. Ask local authorities or an emergency services operator for such locations and routes. The driver is ultimately responsible for the safe operation of the vehicle and therefore, must evaluate whether it is safe to follow the suggested directions. Any navigation features are provided only as an aid. Make your driving decisions based on your observations of local conditions and existing traffic regulations. Navigation features are not a substitute for your personal judgment. Any route suggestions made by the SOFTWARE or SERVICES should never replace any local traffic regulations or your personal judgment or knowledge of safe driving practices.

**3. Speech Recognition:** You acknowledge and understand that HONDA and PROVIDERS may record, retain, and use voices commands when you use the speech recognition components of the SOFTWARE or SERVICES. You and all VEHICLE operators and passengers (a) consent to the recording and retention of voice commands in support of providing speech recognition components and (b) release HONDA and PROVIDERS from all claims, liabilities, and losses that may result from any use of such recorded voice commands. Recognition errors are inherent in speech recognition. It is your responsibility to monitor any speech recognition functions included in the system and address any errors. Neither HONDA nor PROVIDERS will be liable for any damages arising out of errors in the speech recognition process.

**4. Distraction Hazards.** Navigation features may require manual (non-verbal) input or setup. Attempting to perform such set-up or insert data while driving can seriously distract your attention and could cause a crash or other serious consequences; the ability to undertake such interactions may also be limited by state or local law, which laws you are responsible to know and follow. Even occasional short scans of the screen may be hazardous if your attention has been diverted away from your driving at a critical time. Pull over and stop the vehicle in a safe and legal manner before attempting to access a function of the system requiring prolonged attention. Do not raise the volume excessively. Keep the volume at a level where you can still hear outside traffic and emergency signals while driving. Driving while unable to hear these sounds could result in a crash.

## E. Information Collection and Storage

**1. Information Collection, Use, Transmission and Storage of Data. Consent to Use of Data:** You agree that HONDA and PROVIDERS may collect and use your information gathered in any manner as part of product support services related to the SOFTWARE or related services. HONDA may share such information with third parties, including, without limitation, PROVIDERS, third party software and services suppliers, their affiliates and/or their designated agents, solely to improve their products or to provide services or technologies to you. HONDA, third party software and systems suppliers, their affiliates and/or their designated agent may disclose this information to others, but not in a form that personally identifies you.

**2. Information Storage.** Depending on the type of multimedia system you have in your VEHICLE, certain information may be stored for ease of use of the SOFTWARE including, without limitation, search history, location history in certain applications, previous and saved destinations, map locations within certain applications, and device numbers and contact information.

(a) Vehicle Health Information. Your VEHICLE may remotely transmit information regarding the status and health of your VEHICLE (“VEHICLE INFORMATION”) to HONDA without notification to you. VEHICLE INFORMATION may contain VEHICLE maintenance and malfunction status that is derived from VEHICLE diagnostic data and includes, but is not limited to, status of powered doors and windows, battery life data, battery charging data, VEHICLE speed, coolant temperature, air compressor revolution, output power, warning codes, diagnostic trouble codes, fuel injection volume, and engine rotations per minute. VEHICLE HEALTH INFORMATION may be used by HONDA for research and development, to deliver HONDA SERVICES and information to you, and to contact you, and is retained only for a period of time necessary to fulfill these goals.

(b) VEHICLE Geolocation Data (non-navigation/map based). If you opt-in to geolocation-based SERVICES, your vehicle’s geolocation data (latitude and longitude) will be automatically sent from your VEHICLE to HONDA and PROVIDERS.

(c) You understand that the inputting or uploading of information to your VEHICLE’s multimedia system or the SOFTWARE or SERVICES is at your own risk and that HONDA is not responsible for unauthorized access to or use of any personal or other information. All information uploaded to the SOFTWARE and SERVICES may be stored on your VEHICLES’s multimedia system and you understand that the security and safety of your VEHICLE’s multimedia system is your sole responsibility.



**F. NO WARRANTY.** You understand and agree that your use of the SOFTWARE and SERVICES are solely at your own risk and that you will be solely responsible for any damage to your VEHICLE's multimedia system or any other equipment or any loss of data that may result from your use of the SOFTWARE or SERVICES. THE SOFTWARE AND SERVICES ARE PROVIDED ON AN "AS IS" AND "AS AVAILABLE" BASIS WITHOUT ANY WARRANTY OF ANY KIND, EXPRESSED, IMPLIED OR STATUTORY. WE SPECIFICALLY DISCLAIM ANY IMPLIED WARRANTIES OF MERCHANTABILITY, FITNESS FOR A PARTICULAR PURPOSE, AND NON-INFRINGEMENT. HONDA makes no warranties that the SOFTWARE or SERVICES will meet your requirements, or that the SOFTWARE or SERVICES will be uninterrupted, timely, secure, non-infringing or error free. You understand and agree that you are responsible for any and all charges, costs or expenses associated with your use of the SOFTWARE or SERVICES. Advice or information, whether oral or written, obtained by you from us or through the SOFTWARE or SERVICES are provided for informational purposes only and will not create any warranty not expressly made herein. You should not rely on any such information or advice. We assume no liability or responsibility for any errors or omissions in the SOFTWARE or SERVICES. We do not make any warranty or representation that your use of the material displayed on, or obtained through, the SOFTWARE or SERVICES is non-infringing of any rights of any third party. Any decision or action taken by you on the basis of information or content provided via the application is at your sole discretion and risk. HONDA and PROVIDERS are not responsible or liable for any such decision, or for the accuracy, completeness, usefulness, or availability of any content or information displayed, transmitted, or otherwise made available via the SOFTWARE or SERVICES. To the extent jurisdictions do not allow the exclusion of certain warranties, some of the above exclusions may not apply to you.

**G. LIMITATIONS ON LIABILITY.** You and HONDA are each waiving important rights.

**1. Limitations on YOUR liability.** HONDA cannot recover from you any consequential, indirect, incidental, or special damages, or attorney's fees in connection with your use of the SOFTWARE or HONDA SERVICES. HONDA WAIVES TO THE FULLEST EXTENT ALLOWED BY LAW ANY CLAIM FOR DAMAGES OTHER THAN DIRECT, COMPENSATORY DAMAGES AS LIMITED IN THIS AGREEMENT.

**2. Limitation on HONDA and PROVIDER liability.** Neither HONDA nor PROVIDERS will be liable to you or any other party for consequential, indirect, incidental, special, or punitive damages (including without limitation lost profits) in connection with your use of the SOFTWARE or SERVICES, even if HONDA or PROVIDERS are aware of the possibility of such damages. These limitations apply to all claims, including, without limitation, claims in contract and tort (such as negligence, product liability and strict liability). To the extent that a jurisdiction does not permit the exclusion or limitation of liability as set forth herein our liability is limited to the maximum extent permitted by law in such states. If HONDA or PROVIDERS are found liable to you for any reason, you agree that the aggregate liability of all these parties to you for any claim is limited to ten U.S. dollars (US \$10.00). Neither HONDA nor any PROVIDER would have agreed to provide the SOFTWARE or SERVICES to you if you did not agree to this limitation. This amount is the sole and exclusive liability of HONDA and PROVIDERS to you, and is payable as liquidated damages and not as a penalty. Except where prohibited by law, you may not bring any claim against HONDA or any third-party beneficiary more than two (2) years after the claim arises. We do not have any liability for SOFTWARE or SERVICES interruptions of any length.

(a) **Release of HONDA and PROVIDERS** For yourself and anyone else claiming under you, you agree to release and discharge HONDA, PROVIDERS, their respective officers, directors, and employees, and each third-party beneficiary from all claims, liabilities and losses in connection with the SOFTWARE or SERVICES, including, but not limited to claims for personal injury or property damage arising from the total or partial failure of performance of the SOFTWARE or SERVICES, even if caused by or based upon the negligence, gross negligence, strict products liability, Deceptive Trade Practices Act violations, bad faith, or breach of warranty of us or the malfunction of the SOFTWARE or SOFTWARE SERVICES. YOU AGREE TO WAIVE TO THE FULLEST EXTENT ALLOWED BY LAW, ANY CLAIM FOR DAMAGES OTHER THAN DIRECT, COMPENSATORY DAMAGES AS LIMITED IN THIS AGREEMENT. YOU HEREBY RELEASE AND DISCHARGE HONDA AND ITS LICENSORS AND CONTRACTORS (INCLUDING ANY THIRD PARTIES PROVIDING ALL OR PART OF THE SOFTWARE OR SERVICES) FROM AND AGAINST ANY CLAIMS, DAMAGES, EXPENSES AND LIABILITY ARISING FROM OR RELATED TO ANY INJURIES, DAMAGES, OR LOSSES TO ANY PERSON (INCLUDING DEATH) OR PROPERTY OF ANY KIND RESULTING IN WHOLE OR PART, DIRECTLY OR INDIRECTLY, FROM YOUR USE OF THE SOFTWARE OR SERVICES.

**H. Survival.** You agree that the limitations of liability and indemnities in this AGREEMENT will survive even after the AGREEMENT has ended. These limitations of liability apply not only to you, but to anyone using the SOFTWARE or SERVICES via your VEHICLE, to anyone making a claim on your behalf, and to any claims made by your family, employees, customers, or others arising out of or relating to your VEHICLE, the SOFTWARE, or SERVICES.

**I. Availability/Interruption.** The SOFTWARE and certain SERVICES are made available through your VEHICLE's compatible multimedia system when the VEHICLE is turned on. Certain SERVICES may be available only through your compatible mobile device when it is within the operating range of the VEHICLE and a wireless carrier. The availability of the SOFTWARE and SERVICES may be subject to transmission limitation or interruption, including but not limited to technical obsolescence or sunset of the hardware, software or firmware, inside of or external to the Vehicle, required for data transmission or receipt. HONDA does not guarantee that the SOFTWARE, SERVICES, or any portion thereof will be available at all times or in all areas. You acknowledge and agree that HONDA is not responsible for performance degradation, interruption or delays. You acknowledge that HONDA shall not be liable to you if the SOFTWARE or SERVICES in a given location are not available. If the SOFTWARE or SERVICES are not available within your intended location, you agree that your sole remedy shall be to cease using the SOFTWARE and SERVICES.

**J. PRODUCT SUPPORT:** Product support for the SOFTWARE is provided by HONDA. For product support, please refer to HONDA instructions provided in the DOCUMENTATION. Should you have any questions concerning this AGREEMENT, or if you desire to contact HONDA for any other reason, please refer to the HONDA contact information provided in the DOCUMENTATION.

**K. Termination and Transfer.**

**1. Termination.** This AGREEMENT is effective until terminated by you or US. WE may terminate this AGREEMENT for any or no reason, and with or without notice to you. Your rights under this AGREEMENT will terminate automatically without notice from US if you fail to comply with any term of this AGREEMENT. Upon termination of this AGREEMENT, you shall cease all use of the SOFTWARE and SERVICES.

**2. Transfer:** You may permanently transfer your rights under this AGREEMENT only as part of a sale or transfer of the VEHICLE, provided you retain no copies, you transfer all of the SOFTWARE and HONDA SERVICES (including all component parts, the media and printed materials, and any upgrades), and the recipient agrees to the terms of this AGREEMENT. You agree to notify HONDA upon the sale or transfer of the VEHICLE. To contact HONDA, please refer to the HONDA contact information provided in the DOCUMENTATION.

**L. Changes to the SOFTWARE or SERVICES.** WE may change, modify, or update the SOFTWARE or SERVICES from time to time. Unless explicitly stated otherwise, any new features or services that augment or enhance the SOFTWARE or SERVICES in the future shall respectively be considered part of the SOFTWARE or SERVICES and subject to this AGREEMENT. WE reserve the right at any time and from time to time to interrupt, restrict, modify, suspend, discontinue, temporarily or permanently, the SOFTWARE or SERVICES (or any portion thereof), with or without notice to you, and you agree that HONDA shall not be liable to you or to any third party for any modification, suspension or discontinuance of the SOFTWARE or SERVICES.

**M. ARBITRATION:**

PLEASE READ THIS ARBITRATION PROVISION CAREFULLY TO UNDERSTAND YOUR RIGHTS. YOU AGREE THAT ANY CLAIM THAT YOU MAY HAVE IN THE FUTURE MUST BE RESOLVED THROUGH BINDING ARBITRATION. YOU WAIVE THE RIGHT TO HAVE YOUR DISPUTE HEARD IN COURT AND WAIVE THE RIGHT TO BRING CLASS CLAIMS. YOU UNDERSTAND THAT DISCOVERY AND APPEAL RIGHTS ARE MORE LIMITED IN ARBITRATION.

Arbitration is a method of resolving a claim, dispute or controversy without filing a lawsuit. By agreeing to arbitrate, the right to go to court is waived and instead claims, disputes or controversies are submitted to binding arbitration. This provision sets forth the terms and conditions of our agreement. YOU and HONDA agree and acknowledge that this Agreement affects interstate commerce and the Federal Arbitration Act ("FAA") applies. By using the Software, Vehicle, or Services, YOU elect to have disputes resolved by arbitration. YOU, HONDA or any involved third party may pursue a Claim. "Claim" means any dispute between YOU, HONDA, or any involved third party relating to your use of the Software, the Vehicle, or the Services, this Agreement, or our relationship, including any representations, omissions or warranties. "Claim" does not include personal injury or wrongful death claims. YOU or HONDA may seek remedies in small claims court or provisional judicial remedies without arbitrating. In addition, notwithstanding anything herein to the contrary, YOU or HONDA may seek equitable relief in a court of competent jurisdiction.

YOU or HONDA may select arbitration with American Arbitration Association, JAMS or National Arbitration and Mediation. Contact these sponsors for their rules. The hearing will be in the federal district where YOU reside. If agreed, it may be by telephone or written submissions. Filing and arbitrator fees to be paid per the sponsor rules. You may contact the sponsor for a fee waiver. If no fee waivers, HONDA will pay filing and arbitrator fees up to \$5,000, unless law requires more. Each party is responsible for other fees. Arbitrator may award costs or fees to prevailing party, if permitted by law. HONDA will not seek fees, unless the claims are frivolous.

Arbitrator shall be an attorney or current or retired judge familiar with automotive or consumer software. The arbitrator shall follow substantive law, statute of limitations and decide all issues relating to the interpretation, construction, enforceability and applicability of this provision. The arbitrator may order relief permitted by law. This provision is governed and enforceable by the FAA. An award shall include a written opinion and be final, subject to appeal by the FAA.

This provision survives termination of this Agreement or relationship, bankruptcy, assignment or transfer. If part of this provision is unenforceable, the remainder remains in effect. If unenforceability allows arbitration as a class action, then this provision is entirely unenforceable. YOU may opt out within 30 days of your initial use of the Software by sending a signed, written notice to HONDA at Honda Financial Services, P.O. Box 165007, Irving, TX 75016. HONDA reserves the right to make changes to this provision after providing written notice and an opportunity to opt out.

**N. Miscellaneous:** You may not assign this AGREEMENT without HONDA's prior written consent. This AGREEMENT and any additional HONDA TERMS and PROVIDER TERMS represents the entire agreement between you and US. HONDA may amend the terms of this AGREEMENT by providing you with notices of such updated terms. If you do not consent to be bound by the updated terms, your sole remedy will be to cease using the SOFTWARE and SERVICES. If any part of this AGREEMENT is found invalid, void, or unenforceable, the balance of the AGREEMENT will remain valid and enforceable according to its terms. To the fullest extent permitted by law, and except as explicitly provided otherwise, this AGREEMENT and any disputes arising out of or relating to it will be governed by the laws of the State of California, except that California laws concerning choice of law or conflicts shall not apply if they would cause the substantive law of another jurisdiction to apply. Notwithstanding the foregoing, Section M shall be governed by the Federal Arbitration Act and the laws of the State of California, as applicable, as set forth therein. The failure to enforce any term of this AGREEMENT on one occasion shall not prevent enforcement on any other occasion or the enforcement of any other term. Headings and captions shall not be considered included for purposes of interpretation or application hereof, but are for convenience only.

## Legal Information on Apple CarPlay/Android Auto

---

### ■ OWNER'S MANUAL LICENSE/LIABILITY STATEMENTS

USE OF APPLE CARPLAY IS SUBJECT TO YOUR AGREEMENT TO THE CARPLAY TERMS OF USE, WHICH ARE INCLUDED AS PART OF THE APPLE iOS TERMS OF USE. IN SUMMARY, THE CARPLAY TERMS OF USE DISCLAIM APPLE AND ITS SERVICE PROVIDERS' LIABILITY IF THE SERVICES FAIL TO PERFORM CORRECTLY OR ARE DISCONTINUED, STRICTLY LIMIT APPLE AND ITS SERVICE PROVIDERS' OTHER LIABILITIES, DESCRIBE THE KINDS OF USER INFORMATION (INCLUDING, FOR EXAMPLE, VEHICLE LOCATION, VEHICLE SPEED, AND VEHICLE STATUS) BEING GATHERED AND STORED BY APPLE AND ITS SERVICE PROVIDERS, AND DISCLOSE CERTAIN POSSIBLE RISKS ASSOCIATED WITH THE USE OF CARPLAY, INCLUDING THE POTENTIAL FOR DRIVER DISTRACTION. SEE APPLE'S PRIVACY POLICY FOR DETAILS REGARDING APPLE'S USE AND HANDLING OF DATA UPLOADED BY CARPLAY.

USE OF ANDROID AUTO IS SUBJECT TO YOUR AGREEMENT TO THE ANDROID AUTO TERMS OF USE WHICH MUST BE AGREED TO WHEN THE ANDROID AUTO APPLICATION IS DOWNLOADED TO YOUR ANDROID PHONE. IN SUMMARY, THE ANDROID AUTO TERMS OF USE DISCLAIM GOOGLE AND ITS SERVICE PROVIDERS' LIABILITY IF THE SERVICES FAIL TO PERFORM CORRECTLY OR ARE DISCONTINUED, STRICTLY LIMIT GOOGLE AND ITS SERVICE PROVIDERS' OTHER LIABILITIES, DESCRIBE THE KINDS OF USER INFORMATION (INCLUDING, FOR EXAMPLE, VEHICLE LOCATION, VEHICLE SPEED, AND VEHICLE STATUS) BEING GATHERED AND STORED BY GOOGLE AND ITS SERVICE PROVIDERS, AND DISCLOSE CERTAIN POSSIBLE RISKS ASSOCIATED WITH THE USE OF ANDROID AUTO, INCLUDING THE POTENTIAL FOR DRIVER DISTRACTION. SEE GOOGLE'S PRIVACY POLICY FOR DETAILS REGARDING GOOGLE'S USE AND HANDLING OF DATA UPLOADED BY ANDROID AUTO.

## DISCLAIMER OF WARRANTIES; LIMITATION ON LIABILITY

YOU EXPRESSLY ACKNOWLEDGE AND AGREE THAT USE OF APPLE CARPLAY OR ANDROID AUTO (“THE APPLICATIONS”) IS AT YOUR SOLE RISK AND THAT THE ENTIRE RISK AS TO SATISFACTORY QUALITY, PERFORMANCE, ACCURACY AND EFFORT IS WITH YOU TO THE MAXIMUM EXTENT PERMITTED BY APPLICABLE LAW, AND THAT THE APPLICATIONS AND INFORMATION ON THE APPLICATIONS IS PROVIDED “AS IS” AND “AS AVAILABLE,” WITH ALL FAULTS AND WITHOUT WARRANTY OF ANY KIND, AND HONDA HEREBY DISCLAIMS ALL WARRANTIES AND CONDITIONS WITH RESPECT TO THE APPLICATIONS AND INFORMATION ON THE APPLICATIONS, EITHER EXPRESS, IMPLIED OR STATUTORY, INCLUDING, BUT NOT LIMITED TO, THE IMPLIED WARRANTIES AND/OR CONDITIONS OF MERCHANTABILITY, SATISFACTORY QUALITY, FITNESS FOR A PARTICULAR PURPOSE, ACCURACY, QUIET ENJOYMENT, AND NON-INFRINGEMENT OF THIRD PARTY RIGHTS. NO ORAL OR WRITTEN INFORMATION OR ADVICE GIVEN BY HONDA OR AN AUTHORIZED REPRESENTATIVE SHALL CREATE A WARRANTY. AS EXAMPLES, AND WITHOUT LIMITATION, HONDA DISCLAIMS ANY WARRANTY REGARDING THE ACCURACY OF DATA PROVIDED BY THE APPLICATIONS, SUCH AS THE ACCURACY OF DIRECTIONS, ESTIMATED TRAVEL TIME, SPEED LIMITS, ROAD CONDITIONS, NEWS, WEATHER, TRAFFIC, OR OTHER CONTENT PROVIDED BY APPLE, GOOGLE, THEIR AFFILIATES, OR THIRD PARTY PROVIDERS; HONDA DOES NOT GUARANTEE AGAINST LOSS OF APPLICATION DATA, WHICH MAY BE LOST AT ANY TIME; HONDA DOES NOT GUARANTEE THAT THE APPLICATIONS OR ANY SERVICES PROVIDED THROUGH THEM WILL BE PROVIDED AT ALL TIMES OR THAT ANY OR ALL SERVICES WILL BE AVAILABLE AT ANY PARTICULAR TIME OR LOCATION. FOR EXAMPLE, SERVICES MAY BE SUSPENDED OR INTERRUPTED WITHOUT NOTICE FOR REPAIR, MAINTENANCE, SECURITY FIXES, UPDATES, ETC., SERVICES MAY BE UNAVAILABLE IN YOUR AREA OR LOCATION, ETC. IN ADDITION, YOU UNDERSTAND THAT CHANGES IN THIRD PARTY TECHNOLOGY OR GOVERNMENT REGULATION MAY RENDER THE SERVICES AND/OR APPLICATIONS OBSOLETE AND/OR UNUSABLE.

TO THE EXTENT NOT PROHIBITED BY LAW, IN NO EVENT SHALL HONDA OR ITS AFFILIATES BE LIABLE FOR PERSONAL INJURY, OR ANY INCIDENTAL, SPECIAL, INDIRECT OR CONSEQUENTIAL DAMAGES WHATSOEVER, INCLUDING, WITHOUT LIMITATION, DAMAGES FOR LOSS OF PROFITS, CORRUPTION OR LOSS OF DATA, FAILURE TO TRANSMIT OR RECEIVE ANY DATA, BUSINESS INTERRUPTION OR ANY OTHER COMMERCIAL DAMAGES OR LOSSES, ARISING OUT OF OR RELATED TO THE APPLICATIONS OR YOUR USE OF OR INABILITY TO USE THE APPLICATIONS OR INFORMATION ON THE APPLICATIONS, HOWEVER CAUSED, REGARDLESS OF THE THEORY OF LIABILITY (CONTRACT, TORT OR OTHERWISE) AND EVEN IF HONDA WERE ADVISED OF THE POSSIBILITY OF SUCH DAMAGES. SOME STATES AND JURISDICTIONS DISALLOW THE EXCLUSION OR LIMITATION OF LIABILITY FOR DAMAGES, SO THESE LIMITATIONS AND EXCLUSIONS MAY NOT APPLY TO YOU. IN NO EVENT SHALL HONDA’S TOTAL LIABILITY TO YOU FOR ALL DAMAGES (OTHER THAN AS MAY BE REQUIRED BY APPLICABLE LAW IN CASES INVOLVING PERSONAL INJURY) EXCEED THE AMOUNT OF FIVE DOLLARS (\$5.00). THE FOREGOING LIMITATIONS WILL APPLY EVEN IF THE ABOVE STATED REMEDY FAILS OF ITS ESSENTIAL PURPOSE.

## About Open Source Licenses

To see the open source license information, follow these steps.

1. Press the  (home) button.
2. Select **Settings**.
3. Select **System**.
4. Select **About**.
5. Select **Legal Information**.

### ▶▶ About Open Source Licenses

#### **For Amplifier Equipment**

For open source information, please visit:

[http://www.hondaopensource2.com/18.5MY\\_AMP](http://www.hondaopensource2.com/18.5MY_AMP)

#### **For Telematics Control Unit**

Free/Open Source Software Information.

This product contains Free/Open Source Software(FOSS).

The license information and/or the source code of such FOSS can be found at the following URL.

<https://www.denso.com/global/en/opensource/tcu/honda/>



## License Information\*

### ■ DTS Neural Surround

For DTS patents, see <http://patents.dts.com>. Manufactured under license from DTS Licensing Limited. DTS, the Symbol, & DTS and the Symbol together are registered trademarks, and DTS Neural Surround is a trademark of DTS, Inc. © DTS, Inc. All Rights Reserved.



### ■ DTS Enhance

\*\*For DTS patents, see <http://patents.dts.com>. Manufactured under license from DTS, Inc. DTS, the Symbol, DTS and the Symbol together and DTS Enhance are registered trademarks or trademarks of DTS, Inc. in the United States and/or other countries © DTS, Inc. All Rights Reserved.



## ■ Apple

“Made for iPod,” “Made for iPhone,” and “Made for iPad” mean that an electronic accessory has been designed to connect specifically to iPod, iPhone, or iPad, respectively, and has been certified by the developer to meet Apple performance standards. Apple is not responsible for the operation of this device or its compliance with safety and regulatory standards. Please note that the use of this accessory with iPod, iPhone, or iPad may affect wireless performance.

Apple, the Apple Logo, iPad, iPhone, iPod touch are trademarks of Apple Inc., registered in the U.S. and other countries. iPad Air, iPad mini, iPad Pro, Apple CarPlay, and Lightning are trademarks of Apple Inc. App Store is a service mark of Apple Inc.



## Bluetooth

"The *Bluetooth*® word mark and logos are registered trademarks owned by Bluetooth SIG, Inc. and any use of such marks by DENSO CORPORATION is under license. Other trademarks and trade names are those of their respective owners."



## Windows Media

This product is protected by certain intellectual property rights of Microsoft. Use or distribution of such technology outside of this product is prohibited without a license from Microsoft.

## ■ MPEG

### Mpeg4 Visual

THIS PRODUCT IS LICENSED UNDER THE MPEG-4 VISUAL PATENT PORTFOLIO LICENSE FOR THE PERSONAL AND NON-COMMERCIAL USE OF A CONSUMER FOR (j) ENCODING VIDEO IN COMPLIANCE WITH THE MPEG-4 VISUAL STANDARD (“MPEG-4 VIDEO”) AND/OR (ii) DECODING MPEG-4 VIDEO THAT WAS ENCODED BY A CONSUMER ENGAGED IN A PERSONAL AND NONCOMMERCIAL ACTIVITY AND/OR WAS OBTAINED FROM A VIDEO PROVIDER LICENSED BY MPEG LA TO PROVIDE MPEG-4 VIDEO. NO LICENSE IS GRANTED OR SHALL BE IMPLIED FOR ANY OTHER USE. ADDITIONAL INFORMATION INCLUDING THAT RELATING TO PROMOTIONAL, INTERNAL AND COMMERCIAL USES AND LICENSING MAY BE OBTAINED FROM MPEG LA, LLC. SEE [HTTP://WWW.MPEGLA.COM](http://www.mpegla.com).

### VC-1

THIS PRODUCT IS LICENSED UNDER THE VC-1 PATENT PORTFOLIO LICENSE FOR THE PERSONAL AND NON-COMMERCIAL USE OF A CONSUMER TO (i) ENCODE VIDEO IN COMPLIANCE WITH THE VC-1 STANDARD (“VC-1 VIDEO”) AND/OR (ii) DECODE VC-1 VIDEO THAT WAS ENCODED BY A CONSUMER ENGAGED IN A PERSONAL AND NON-COMMERCIAL ACTIVITY AND/OR WAS OBTAINED FROM A VIDEO PROVIDER LICENSED TO PROVIDE VC-1 VIDEO. NO LICENSE IS GRANTED OR SHALL BE IMPLIED FOR ANY OTHER USE. ADDITIONAL INFORMATION MAY BE OBTAINED FROM MPEG LA, L.L.C. SEE [HTTP://WWW.MPEGLA.COM](http://www.mpegla.com).

## AVC/H.264

THIS PRODUCT IS LICENSED UNDER THE AVC PATENT PORTFOLIO LICENSE FOR THE PERSONAL AND NONCOMMERCIAL USE OF A CONSUMER TO (i) ENCODE VIDEO IN COMPLIANCE WITH THE AVC STANDARD ("AVC VIDEO") AND/OR (ii) DECODE AVC VIDEO THAT WAS ENCODED BY A CONSUMER ENGAGED IN A PERSONAL AND NON-COMMERCIAL ACTIVITY AND/OR WAS OBTAINED FROM A VIDEO PROVIDER LICENSED TO PROVIDE AVC VIDEO. NO LICENSE IS GRANTED OR SHALL BE IMPLIED FOR ANY OTHER USE. ADDITIONAL INFORMATION MAY BE OBTAINED FROM MPEG LA, L.L.C. SEE [HTTP://WWW.MPEGLA.COM](http://www.mpegla.com).

Use the audio/information screen to customize certain features.

## ■ How to customize

With the power mode in ON, select **Settings**, then select a setting item.



## ▶ Customized Features

When you customize settings:

- Make sure that the vehicle is at a complete stop.
- Put the transmission into **P**.

To customize features detail, refer to the following.

▶ **Customization flow** P. 301

▶ **List of customizable options** P. 307

## ■ Customization flow

Press the  (Home) button.

Select **Settings**.

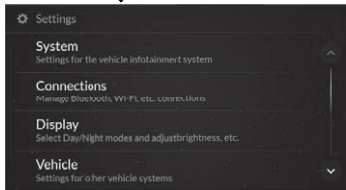

→ **System**

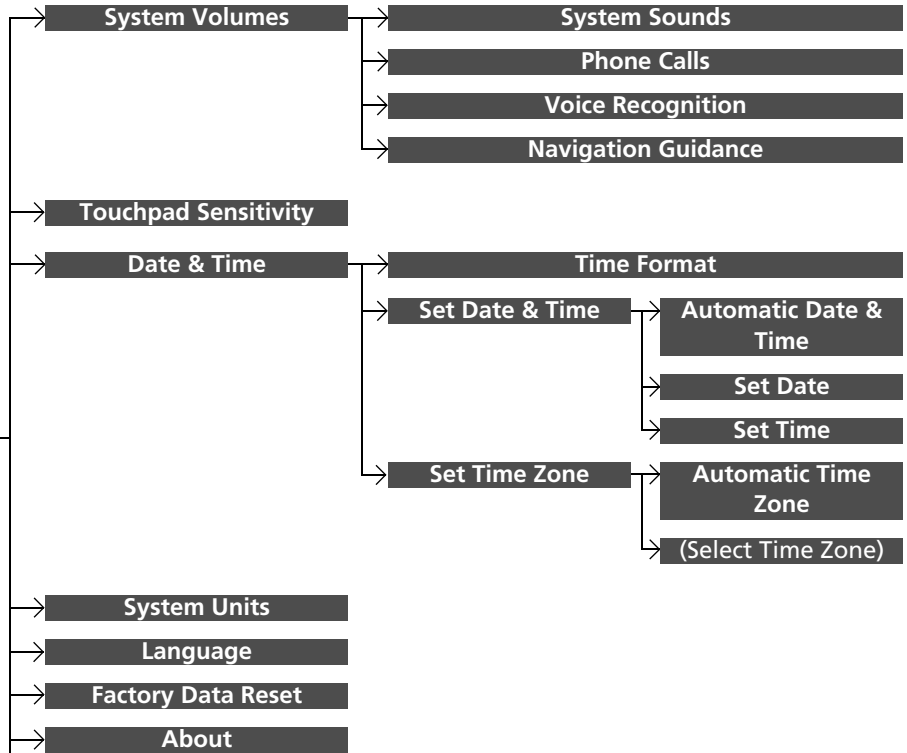

Features

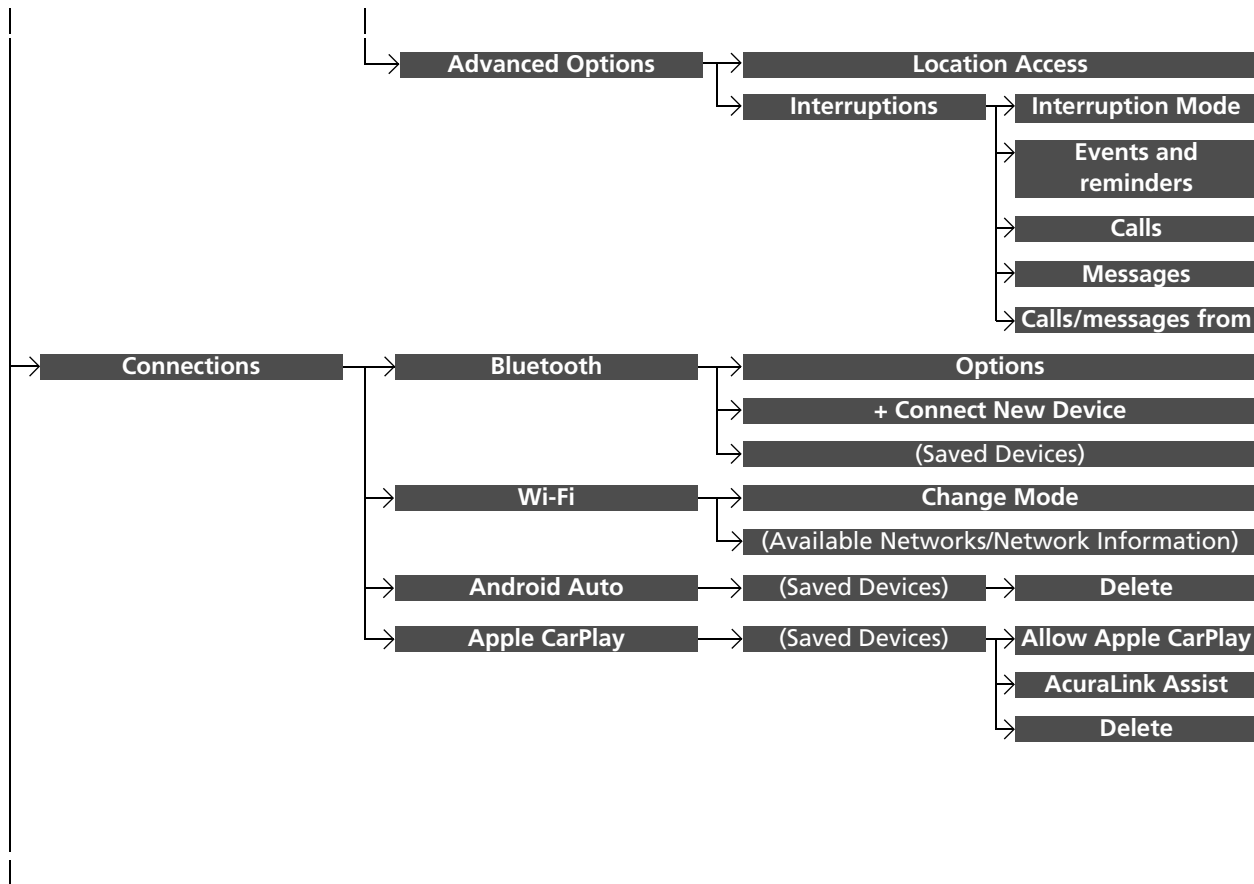



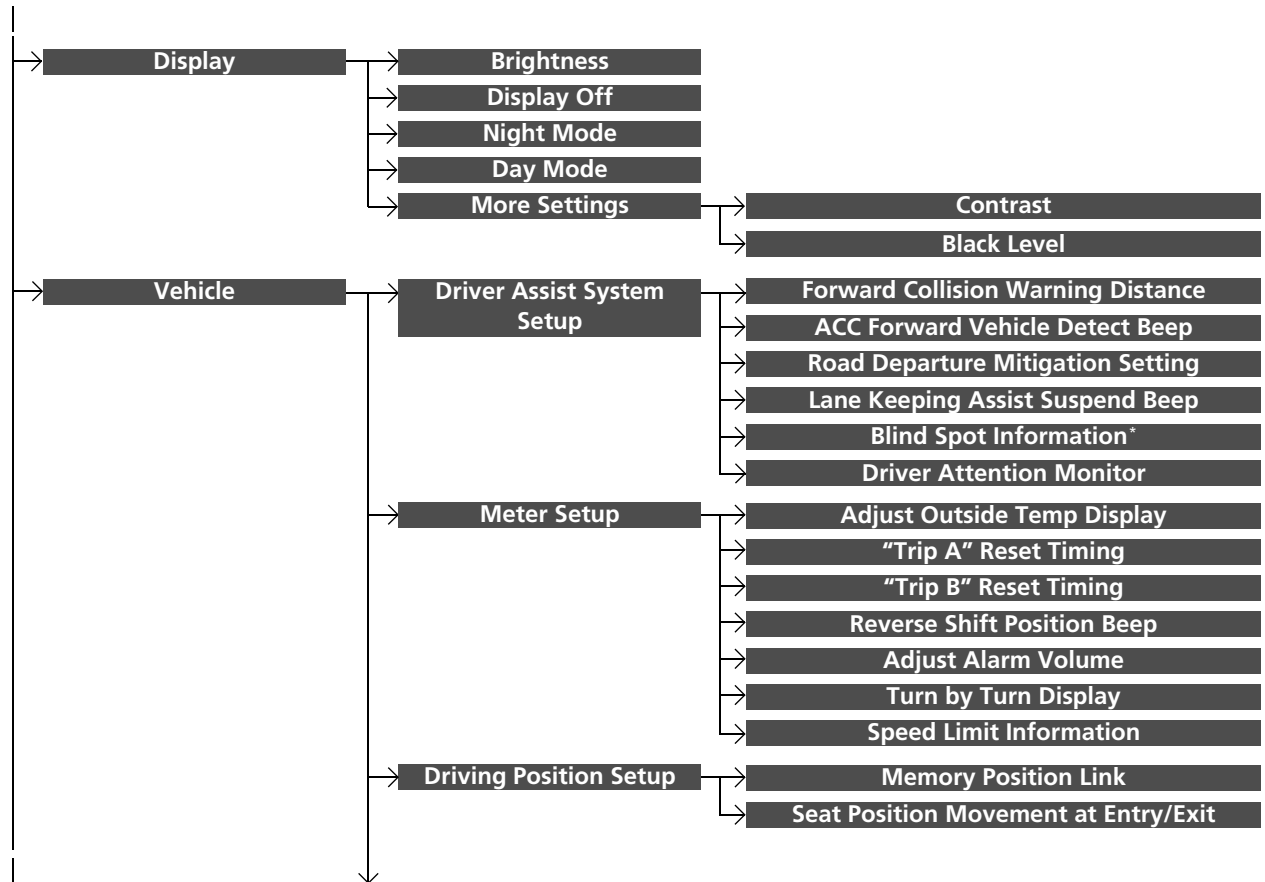

Features

\* Not available on all models

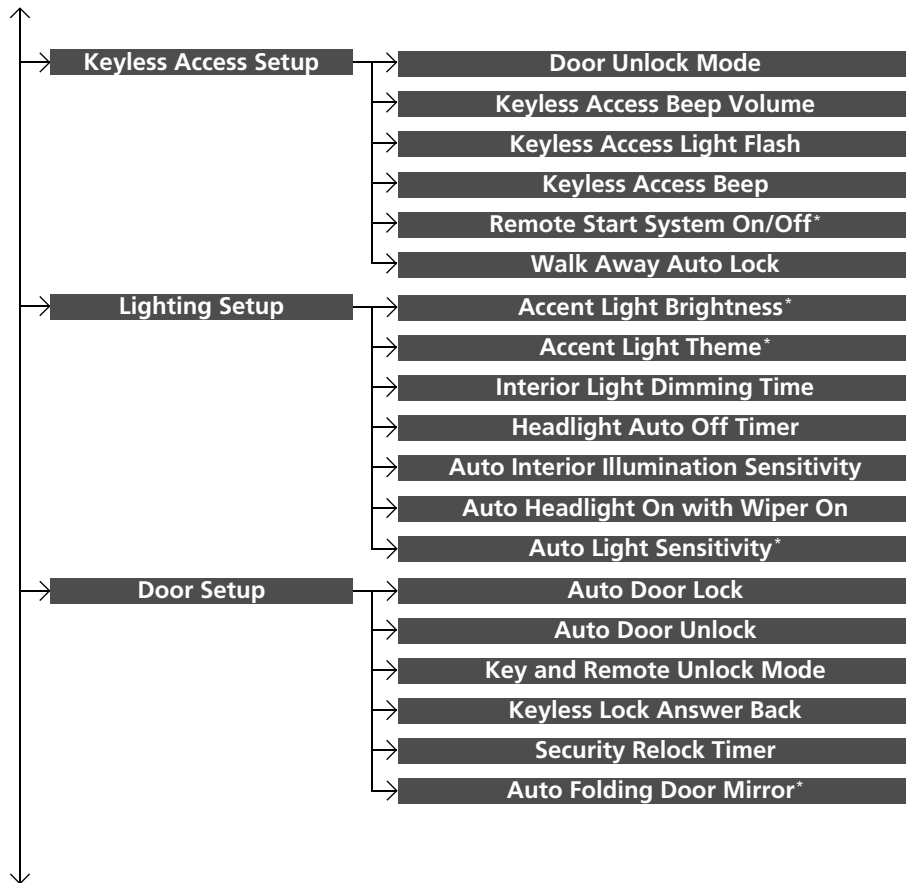

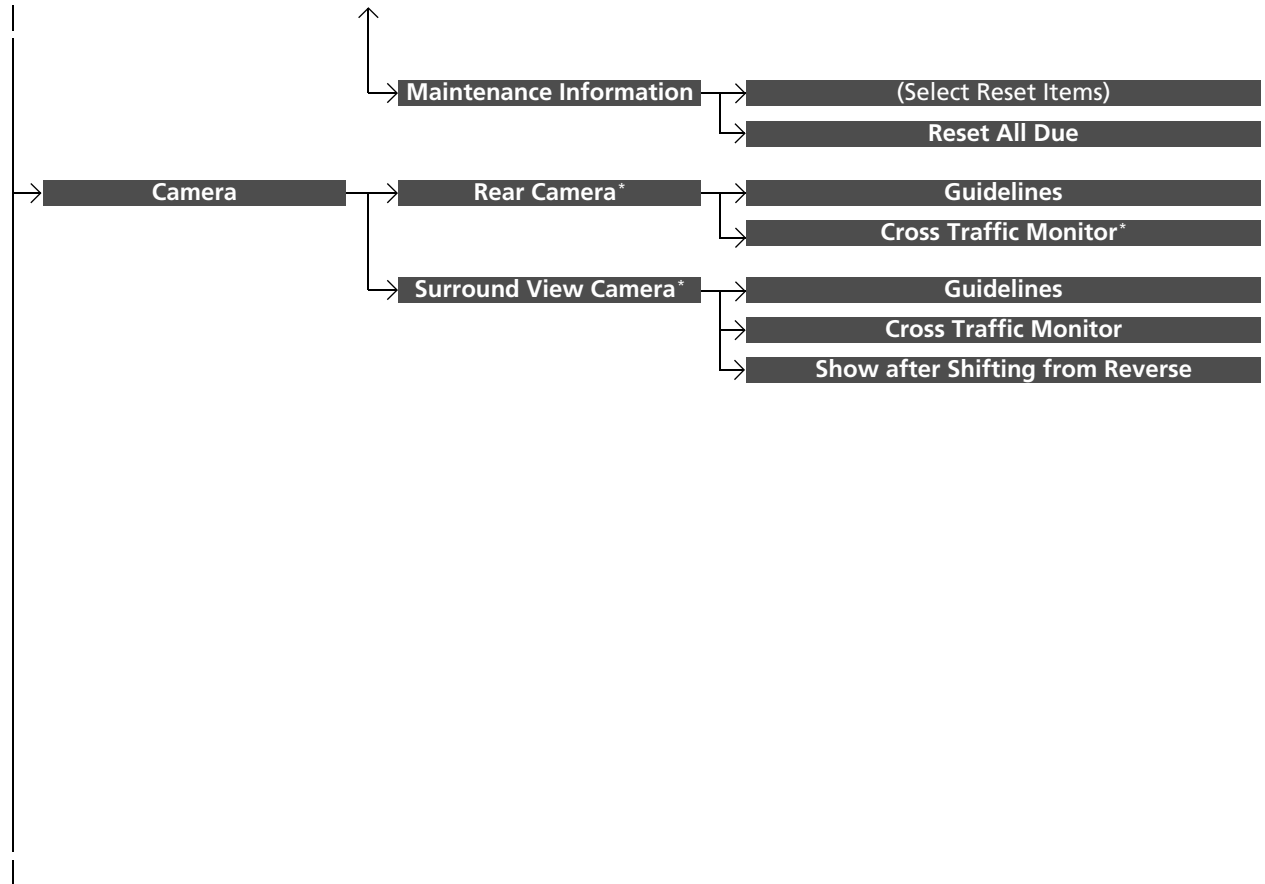

\* Not available on all models

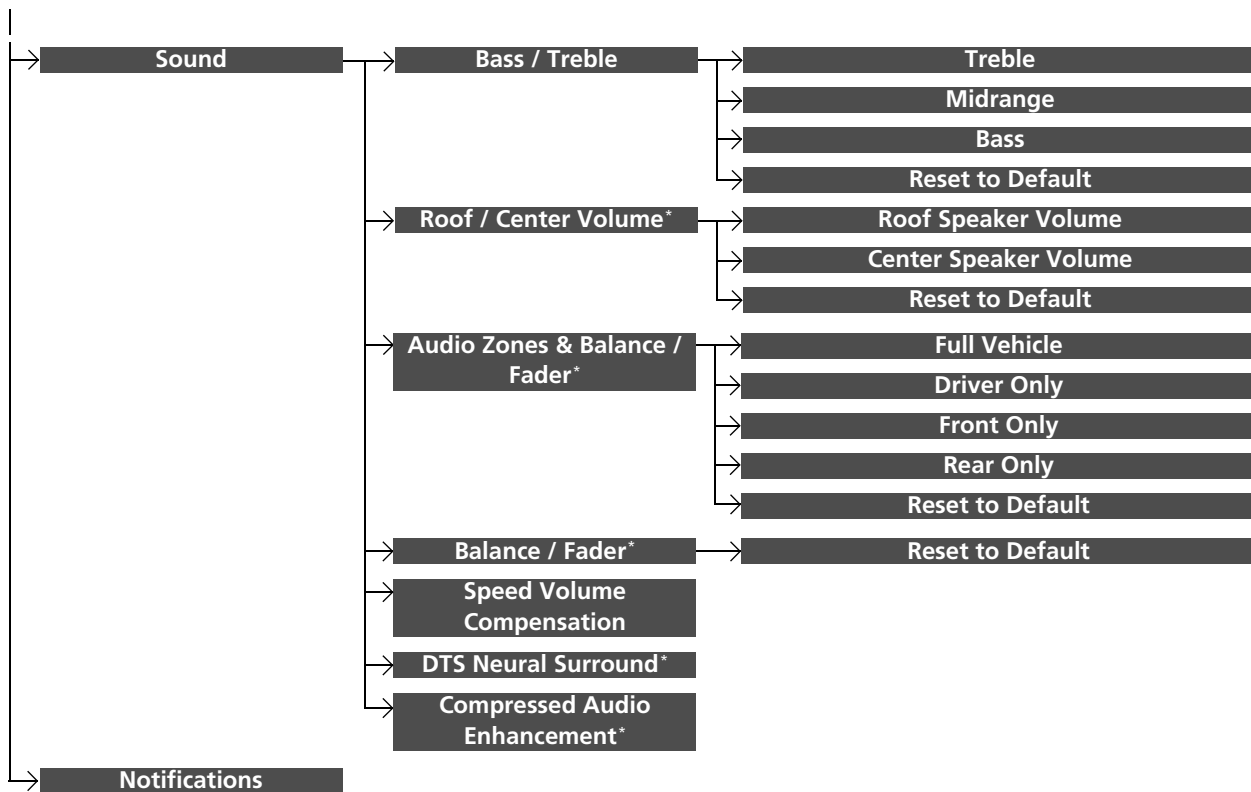

## ■ List of customizable options

Setup Group	Customizable Features	Description	Selectable Settings		
System	System Volumes	<b>System Sounds</b>	Changes the system sounds volume.	—	
		<b>Phone Calls</b>	Changes the phone call volume.	—	
		<b>Voice Recognition</b>	Changes the voice recognition volume.	—	
		<b>Navigation Guidance</b>	Changes the navigation guidance volume.	—	
	<b>Touchpad Sensitivity</b>	Sets the sensitivity of the True Touchpad Interface.	<b>High/Low</b> * <sup>1</sup>		
	<b>Time Format</b>	Selects the digital clock display from 12H to 24H.	<b>12 Hour</b> * <sup>1</sup> / <b>24 Hour</b>		
	Date & Time	<b>Automatic Date &amp; Time</b>	Selects <b>On</b> to have the GPS automatically adjust the clock. Select <b>Off</b> to cancel this function.	<b>On</b> * <sup>1</sup> / <b>Off</b>	
		<b>Set Date &amp; Time</b>	<b>Set Date</b>	Adjusts date. <input checked="" type="checkbox"/> <b>Adjusting the Clock</b> P. 116	—
			<b>Set Time</b>	Adjusts clock. <input checked="" type="checkbox"/> <b>Adjusting the Clock</b> P. 116	—

\*1:Default Setting

Setup Group	Customizable Features		Description	Selectable Settings
<b>System</b>	<b>Date &amp; Time</b>	<b>Set Time Zone</b>	Sets the audio system to automatically adjust the clock when driving through different time zones.	<b>On*1/Off</b>
		<b>Automatic Time Zone</b> (Select time zone)	Changes the time zone manually.	—
	<b>System Units</b>		Changes the speed/distance unit on the multi-information display, head-up display* and audio/information screen.	<b>Miles*1/KM</b> (U.S.) <b>Miles/KM*1</b> (Canada)
	<b>Language</b>		Changes the display language.	<b>English*1/Français/ Español</b>
	<b>Factory Data Reset</b>		Resets all the settings to their factory default. ➤ <b>Defaulting All the Settings</b> P. 323	<b>Continue/Cancel</b>
	<b>About</b>		Displays the Android setting items.	—
	<b>Advanced Options</b>	<b>Location Access</b>		Selects <b>Off</b> not to allow apps including the navigation system* to access the vehicle's location.

\*1:Default Setting

Setup Group	Customizable Features	Description	Selectable Settings
System	Advanced Options Interruptions	<b>Interruption Mode</b>	Sets the interruption mode for allowing to notify when calls and notifications arrive. <b>Always interrupt*<sup>1</sup>/ Don't interrupt/ Allow only priority interruptions</b>
		<b>Events and reminders</b>	Sets priority interruptions of events and reminders. <b>On*<sup>1</sup>/Off</b>
		<b>Calls</b>	Sets priority interruptions of calls. <b>On/Off</b>
		<b>Messages</b>	Sets priority interruptions of messages. <b>On/Off</b>
		<b>Calls/ messages from</b>	Sets priority interruptions of from who. <b>Anyone*<sup>1</sup>/Contacts only/Starred contacts only</b>

\*1:Default Setting

Setup Group	Customizable Features	Description	Selectable Settings
Connections	<b>Bluetooth</b>		
	<b>Options</b>	Turns the <i>Bluetooth</i> ® on and off.	<b>On<sup>*1</sup>/Off</b>
	<b>+ Connect New Device</b>	Pairs a new phone to HFL. ➤ <b>Phone Setup</b> P. 333	—
	(Saved Devices)	Connects, disconnects, or deletes a paired phone. ➤ <b>Phone Setup</b> P. 333	—

\*1: Default Setting



Setup Group	Customizable Features	Description	Selectable Settings	
Connections	Wi-Fi	<b>Change Mode</b> <sup>*2</sup>	Changes the Wi-Fi mode.	<b>Off</b> <sup>*1</sup> / <b>Hotspot/Network</b>
		<b>Change Mode</b> <sup>*3</sup>	Changes the Wi-Fi mode.	<b>Off/Hotspot/Network</b>
		<b>Network SSID</b> <sup>*3</sup>	Sets this network name.	—
		<b>Password</b> <sup>*3</sup>	Sets password for require entering password when connecting Wi-Fi device to this network.	—
		<b>Connected Devices List</b> <sup>*3</sup>	Displays the connected device list.	—
		<b>Change Mode</b> <sup>*4</sup>	Changes the Wi-Fi mode.	<b>Off/Hotspot/Network</b>
		(Available Networks) <sup>*4</sup>	Displays the available network(s).	—
		<b>Network Options</b> <sup>*4</sup>	<b>Add Network</b>	Searches a new available network(s).
	<b>Remembered Networks</b>	Displays the previously entered network(s).	—	

\*1:Default Setting

\*2:Appears when Wi-Fi mode is **Off**.

\*3:Appears when Wi-Fi mode is **Hotspot**.

\*4:Appears when Wi-Fi mode is **Network**.

Setup Group	Customizable Features		Description	Selectable Settings	
Connections	<b>Android Auto</b>	(Saved Devices)	Sets up the Android Auto connection.	<b>Disable/Enable</b>	
			<b>Delete</b>	Delete an Android Auto device.	<b>Cancel/Delete</b>
	<b>Apple CarPlay</b>	(Saved Devices)	<b>Allow Apple CarPlay</b>	Sets up the Apple CarPlay connection.	<b>Disable/Enable</b>
			<b>AcuraLink Assist</b>	Turn AcuraLink Assist on and off.	<b>On*<sup>1</sup>/Off</b>
		<b>Delete</b>	Delete an Apple CarPlay device.	<b>Cancel/Delete</b>	
Display	<b>Brightness</b>		Changes the brightness of the audio/information screen.	—	
	<b>Display Off</b>		Turns the audio/information screen brightness off.	—	
	<b>Night Mode</b>		Changes between the daytime mode and nighttime mode.	—	
	<b>Day Mode</b>		 <b>Display Setup</b> P. 232	—	
	<b>More Settings</b>	<b>Contrast</b>	Changes the contrast of the audio/information screen.	—	
		<b>Black Level</b>	Changes the black level of the audio/information screen.	—	

\*1:Default Setting

Setup Group	Customizable Features	Description	Selectable Settings
<b>Vehicle</b>  <b>Driver Assist System Setup</b>	<b>Forward Collision Warning Distance</b>	Changes Collision Mitigation Braking System (CMBS™) alert distance.	<b>Long/Normal*<sup>1</sup>/Short</b>
	<b>ACC Forward Vehicle Detect Beep</b>	Causes the system to beep when the system detects a vehicle, or when the vehicle goes out of the ACC with Low Speed Follow range.	<b>On/Off*<sup>1</sup></b>
	<b>Road Departure Mitigation Setting</b>	Changes the setting for the road departure mitigation system.	<b>Normal*<sup>1</sup>/Wide/Warning Only/Narrow</b>
	<b>Lane Keeping Assist Suspend Beep</b>	Causes the system to beep when Lane Keeping Assist System (LKAS) is suspended.	<b>On/Off*<sup>1</sup></b>
	<b>Blind Spot Information*</b>	Changes the setting for the blind spot information.	<b>Audible and Visual Alert*<sup>1</sup>/Visual Alert</b>
	<b>Driver Attention Monitor</b>	Changes the setting for the driver attention monitor.	<b>Off, Tactile Alert, Tactile/Audible Alert*<sup>1</sup></b>

\*1:Default Setting

\* Not available on all models

Setup Group	Customizable Features	Description	Selectable Settings	
Vehicle	Meter Setup	<b>Adjust Outside Temp Display</b>	Adjusts the temperature reading by a few degrees.	-5°F ~ ±0°F* <sup>1</sup> ~ 5°F (U.S.) -3°C ~ ±0°C* <sup>1</sup> ~ 3°C (Canada)
		<b>"Trip A" Reset Timing</b>	Changes the setting of how to reset trip meter A and average fuel economy A.	<b>With Refuel/IGN Off/Manually Reset</b> * <sup>1</sup>
		<b>"Trip B" Reset Timing</b>	Changes the setting of how to reset trip meter B and average fuel economy B.	<b>With Refuel/IGN Off/Manually Reset</b> * <sup>1</sup>
		<b>Reverse Shift Position Beep</b>	Causes the beeper to sound once when the transmission is put into <b>R</b> .	<b>On</b> * <sup>1</sup> / <b>Off</b>
		<b>Adjust Alarm Volume</b>	Changes the alarm volume, such as buzzers, warnings, turn signal sound, and so on.	<b>High/Mid</b> * <sup>1</sup> / <b>Low</b>
		<b>Turn by Turn Display</b>	Selects whether the turn-by-turn display comes on during the route guidance.	<b>On</b> * <sup>1</sup> / <b>Off</b>

\*1: Default Setting

Setup Group	Customizable Features	Description	Selectable Settings
Vehicle	<b>Models with navigation system</b> <b>Speed Limit Information</b>	Select whether the speed limit information source is camera located behind the rearview mirror or the navigation system. You can also speed limit information turn off.	<b>Traffic Sign Recognition<sup>*1</sup>/Navigation/Off</b>
	<b>Models without navigation system</b> <b>Speed Limit Information</b>	Selects whether the speed limit information should be displayed on head-up display*/meter.	<b>On<sup>*1</sup>/Off</b>

\*1:Default Setting

Setup Group	Customizable Features	Description	Selectable Settings	
<b>Vehicle</b>	<b>Driving Position Setup</b>	<b>Memory Position Link</b>	Turns the driving position memory system on and off.	<b>On*<sup>1</sup>/Off</b>
		<b>Seat Position Movement at Entry/Exit</b>	Causes the driver's seat to move back to make it easier to enter or exit the vehicle.	<b>On*<sup>1</sup>/Off</b>
	<b>Keyless Access Setup</b>	<b>Door Unlock Mode</b>	Changes which doors unlock when you grab the driver's door handle.	<b>Driver Door*<sup>1</sup>/All Doors</b>
		<b>Keyless Access Beep Volume</b>	Changes the beep volume.	<b>High*<sup>1</sup>/Low</b>
		<b>Keyless Access Light Flash</b>	Causes some exterior lights to flash when you unlock/lock the doors.	<b>On*<sup>1</sup>/Off</b>
		<b>Keyless Access Beep</b>	Causes the beeper to sound when you unlock/lock the doors.	<b>On*<sup>1</sup>/Off</b>
		<b>Remote Start System On/Off*</b>	Turns the remote engine start feature on and off.	<b>On*<sup>1</sup>/Off</b>
<b>Walk Away Auto Lock</b>	Changes the settings for the auto lock function when you walk away from the vehicle.	<b>Enable/Disable*<sup>1</sup></b>		

\*1:Default Setting

Setup Group	Customizable Features	Description	Selectable Settings	
Vehicle	Lighting Setup	<b>Accent Light Brightness*</b>	Changes the brightness level of the interior accent lighting.	<b>Link to Illumination*<sup>1</sup>/Max/High/Mid/Low/Off</b>
		<b>Accent Light Theme*</b>	Changes the theme of the interior accent lighting. <input checked="" type="checkbox"/> <b>Lighting area of the accent light</b> P. 392	<b>Dynamic Mode*<sup>1</sup></b> See other selectable settings on the screen.
		<b>Interior Light Dimming Time</b>	Changes the length of time the interior lights stay on after you close the doors.	<b>15 sec/30 sec*<sup>1</sup>/60 sec</b>
		<b>Headlight Auto Off Timer</b>	Changes the length of time the exterior lights stay on after you close the driver's door.	<b>0 sec/15 sec*<sup>1</sup>/30 sec/60 sec</b>
		<b>Auto Interior Illumination Sensitivity</b>	Changes the sensitivity of the brightness of the instrument panel when the headlight switch is in <b>AUTO</b> position.	<b>Min/Low/Mid*<sup>1</sup>/High/Max</b>
		<b>Auto Headlight On with Wiper On</b>	Causes the headlights to come on when the headlight switch is in the <b>AUTO</b> position and the wipers are used several times within a certain number of intervals.	<b>On*<sup>1</sup>/Off</b>
		<b>Auto Light Sensitivity*</b>	Changes the timing for the headlights to come on.	<b>Min/Low/Mid*<sup>1</sup>/High/Max</b>

\*1:Default Setting

\* Not available on all models

Setup Group	Customizable Features	Description	Selectable Settings	
Vehicle	Door Setup	<b>Auto Door Lock</b>	Changes the setting for the automatic locking feature.	<b>Off/With Vehicle Speed*<sup>1</sup>/Shift from P</b>
		<b>Auto Door Unlock</b>	Changes the setting for when the doors unlock automatically.	<b>All Doors with Driver's Door Opens*<sup>1</sup>/All Doors with Shift to P/All Doors with IGN Off/Off</b>
		<b>Key and Remote Unlock Mode</b>	Sets up either the driver's door or all doors to unlock on the first push of the remote or built-in key.	<b>Driver Door*<sup>1</sup>/All Doors</b>
		<b>Keyless Lock Answer Back</b>	LOCK/UNLOCK- The exterior lights flash. LOCK (2nd push)- The beeper sounds.	<b>On*<sup>1</sup>/Off</b>
		<b>Security Relock Timer</b>	Changes the time it takes for the doors to relock and the security system to set after you unlock the vehicle without opening any door.	<b>30 sec*<sup>1</sup>/60 sec/90 sec</b>
		<b>Auto Folding Door Mirror*</b>	Changes the setting so that the mirrors fold at the time the doors are locked with the remote transmitter or keyless access system.	<b>Auto Fold with Keyless*<sup>1</sup>/Manual Only</b>

\*1:Default Setting



Setup Group	Customizable Features	Description	Selectable Settings
<b>Vehicle</b>	(Select Reset Items)	Resets the Maintenance Minder™ display when you have performed the maintenance service.	—
	<b>Maintenance Information</b> <b>Reset All Due</b>		

\*1:Default Setting

Setup Group	Customizable Features	Description	Selectable Settings
Camera	Rear Camera*	<b>Guidelines</b> Selects whether the guidelines come on the rear camera monitor. ➤ <b>Multi-View Rear Camera*</b> P. 503	<b>Dynamic/Fixed/Both*<sup>1</sup>/Off</b>
		<b>Cross Traffic Monitor*</b> Turns the cross traffic monitor feature on and off.	<b>On*<sup>1</sup>/Off</b>
	Surround View Camera*	<b>Guidelines</b> Selects whether the guidelines come on the rear camera monitor. ➤ <b>Surround View Camera System*</b> P. 505	<b>Dynamic/Fixed/Both*<sup>1</sup>/Off</b>
		<b>Cross Traffic Monitor</b> Turns the cross traffic monitor feature on and off.	<b>On*<sup>1</sup>/Off</b>
		<b>Show after Shifting from Reverse</b> Sets the rear view to be automatically switched to the front view when the transmission is out of <b>R</b> .	<b>On/Off*<sup>1</sup></b>

\*1: Default Setting

Setup Group	Customizable Features	Description	Selectable Settings	
Sound	Bass / Treble	Treble	Adjusts the settings of the audio speakers' sound. ▶ <b>Adjusting the Sound</b> P. 231	—
		Midrange		
		Bass		
		Reset to Default		
	Roof / Center Volume*	Roof Speaker Volume		
		Center Speaker Volume		
		Reset to Default		
	Audio Zones & Balance / Fader*	Full Vehicle		
		Driver Only		
		Front Only		
		Rear Only		
		Reset to Default		
Balance / Fader*	Reset to Default			

\*1:Default Setting

\* Not available on all models

Setup Group	Customizable Features	Description	Selectable Settings
Sound	<b>Speed Volume Compensation</b>	Adjusts the settings of the audio speakers' sound. ▶ <b>Adjusting the Sound</b> P. 231	<b>Off/Low/Mid*<sup>1</sup>/High</b>
	<b>DTS Neural Surround*</b>		<b>On/Off*<sup>1</sup></b>
	<b>Compressed Audio Enhancement*</b>		<b>On/Off*<sup>1</sup></b>
<b>Notifications</b>		Changes the notification settings for apps.	—

\*1: Default Setting

## Defaulting All the Settings

Reset all the menu and customized settings as the factory defaults.

### Defaulting System Settings

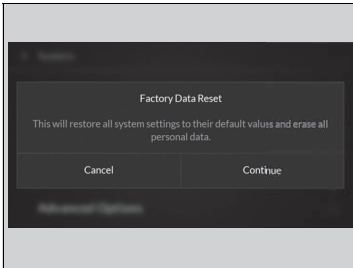

1. Press the  (home) button.
2. Select **Settings**.
3. Select **System**.
4. Select **Factory Data Reset**.
  - A confirmation message appears on the screen.
5. Select **Continue** to reset the settings.
6. Select **Reset** to reset the settings.
  - The system will reboot.

### Defaulting Vehicle Settings

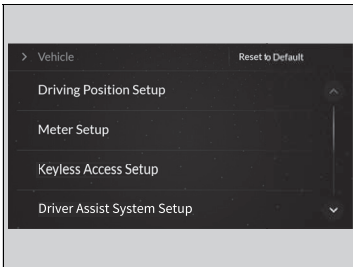

1. Press the  (home) button.
2. Select **Settings**.
3. Select **Vehicle**.
4. Select **Reset to Default**.
5. Select **Reset**.

### Defaulting All the Settings

When you transfer the vehicle to a third party, reset all settings to default and delete all personal data.

If you perform **Factory Data Reset**, it will reset the preinstalled apps to their factory default.

The HomeLink® Universal Transceiver can be programmed to operate up to three remote controlled devices around your home, such as garage doors, lighting, or home security systems.

## ■ Important Safety Precautions

Refer to the safety information that came with your garage door opener to test that the safety features are functioning properly. If you do not have the safety information, contact the manufacturer.

Before programming HomeLink, make sure that people and objects are out of the way of the garage or gate to prevent potential injury or damage.

When programming a garage door opener, park just outside the garage door's path.

### ⌘ HomeLink® Universal Transceiver

Before programming HomeLink to operate a garage door opener, confirm that the opener has an external entrapment protection system, such as an "electronic eye," or other safety and reverse stop features. If it does not, HomeLink may not be able to operate it.

## Training HomeLink

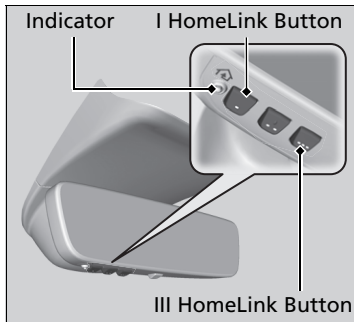

If it is necessary to erase a previously entered learned code:

- Press and hold the I and III HomeLink buttons for about 10 seconds, until the green indicator blinks. Release the buttons, and proceed to step 1.
- If you are training the second or third button, go directly to step 1.

The instructions on the next page should work for most gate or garage openers, but may not work for all. For detailed instructions about your specific remote opener, visit <http://www.homelink.com> or call (800) 355-3515.

## ■ Programming a Button

**1.** Position the remote transmitter you wish to link 1 to 3 inches (3 - 8 cm) from the HomeLink® button you want to program.

**2.** Press and hold the desired HomeLink button. Is the HomeLink indicator (LED) *slowly flashing orange*?

**YES**

**3a.** Hold the button on the remote transmitter. Does HomeLink indicator (LED) change from *slowly flashing orange to rapidly flashing green or continuously on green*? The process should take less than 60 seconds.

**4.** Press and hold the programmed HomeLink button for about a second. Does the device (garage door opener) work?

**YES**

**Training Complete**

**NO**

**5.** Press and hold the HomeLink button again.

HomeLink LED is *continuously on green*.

**6.** Press and hold the HomeLink button again. The remote-controlled device should operate.

**Training Complete**

**NO**

### **3b. Canadian Garage Door Opener**

A. Press and release the HomeLink button. Press, hold and release the button on the remote every 2 secs. Does the HomeLink indicator (LED) change from *slowly flashing orange to rapidly flashing or continuously on green*? The process should take less than 60 seconds.

HomeLink indicator *rapidly flashes green*.

**5a.** The remote has a rolling code. Press the "learn" button on the remote-controlled device (e.g. garage door opener).

**5b.** Within 30 secs, press and hold the programmed HomeLink button for 2 secs.

## ▶▶ Training HomeLink

**Reprogramming a Button**  
If you want to retrain a programmed button for a new device, you do not have to erase all button memory. You can replace the existing memory code using this procedure:

1. Press and hold the desired HomeLink button until the HomeLink indicator begins to *slowly flash orange*. This should take about 20 seconds.
2. Release the HomeLink button and position the remote transmitter you wish to link 1 - 3 inches (3 - 8 cm) from the HomeLink button you want to program, then follow steps 3 - 6 under "programming a button."

**Erasing Button Memory**  
To erase programming from the buttons, press and hold the two outside HomeLink buttons until the HomeLink indicator changes from *orange to rapidly flashing green*. This should take about 10 seconds. You should erase all programming before selling the vehicle.

**Operating**  
To operate, simply press and release the programmed HomeLink button. Activation will now occur for the trained device.

**Questions**  
For questions or comments, visit [www.HomeLink.com](http://www.HomeLink.com), [www.youtube.com/HomeLinkGentex](http://www.youtube.com/HomeLinkGentex), or by calling the HomeLink Hotline (North America only) at (800) 355-3515.

HomeLink® is a registered trademark of Gentex Corporation.



Bluetooth® HandsFreeLink® (HFL) allows you to place and receive phone calls using your vehicle's audio system, without handling your cell phone.

## Using HFL

### HFL Buttons

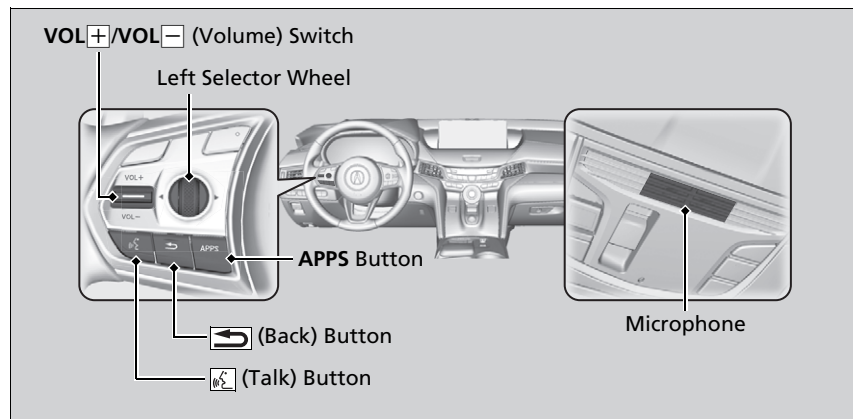

### Bluetooth® HandsFreeLink®

Place your phone where you can get good reception.

To use HFL, you need a *Bluetooth*-compatible cell phone. For a list of compatible phones, pairing procedures, and special feature capabilities:

- U.S.: Visit [www.handsfreelink.com/Acura](http://www.handsfreelink.com/Acura), or call 1-888-528-7876.
- Canada: For more information on smartphone compatibility, call 1-855-490-7351.



To use the system, the *Bluetooth*® setting must be **On**.

➤ **Phone Setup** P. 333

Voice control tips

- Aim the vents away from the ceiling and close the windows, as noise coming from them may interfere with the microphones.
- Press the  button when you want to call a number using a phonebook name or a number. Speak clearly and naturally after a beep.
- If the microphone picks up voices other than yours, the command may be misinterpreted.
- To change the volume level, use the audio system's volume or use the audio remote controls on the steering wheel.

### Left Selector Wheel:

- **Incoming call:** Move the selector wheel to the right to answer the call. Move it to the left to decline the call.
- **During a call:** Move the selector wheel to the right to display the call options menu. Move it to the left to end the call.
-  **(back) button:** Press the button to go back to the previous screen or to cancel a command.
-  **(talk) button:** Press the button to start voice recognition.

To go to the phone screen of the multi-information display or the head-up display\*:

1. Press the **APPS** button on the steering wheel.
2. Using the selector wheel, scroll to **Phone** on the multi-information display or the head-up display\*, and then press the left selector wheel.
  - ▶ You can select **Favorites** or **Recents** by moving the selector wheel to the left or the right.

### Bluetooth® HandsFreeLink®

#### *Bluetooth®* Wireless Technology

The *Bluetooth®* word mark and logos are registered trademarks owned by *Bluetooth* SIG, Inc., and any use of such marks by Honda Motor Co., Ltd., is under license. Other trademarks and trade names are those of their respective owners.

#### HFL Limitations

An incoming call on HFL will interrupt the audio system when it is playing. It will resume when the call is ended.

## ■ HFL Status Display

The audio/information screen notifies you when there is an incoming call.



Bluetooth® connection status is displayed in the B-zone.

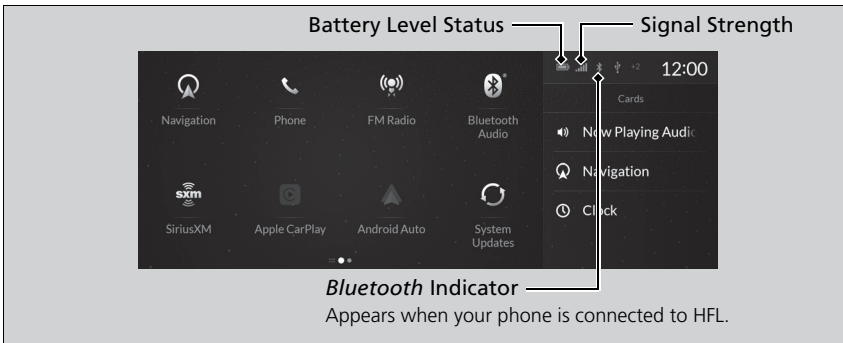

## ▣ HFL Status Display

The information that appears on the audio/information screen varies between phone models.

### ■ Limitations for Manual Operation \*

Certain manual functions are disabled or inoperable while the vehicle is in motion. You cannot select a grayed-out option until the vehicle is stopped.

# HFL Menu

The power mode must be in ACCESSORY or ON to use the system.

## ■ Phone screen

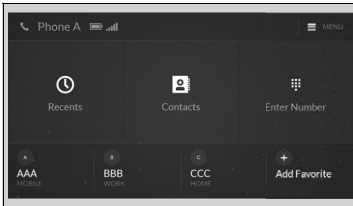

1. Press the  (home) button.
2. Select **Phone**.

**HFL Menu**

To use HFL, you must first pair your *Bluetooth*-compatible cell phone to the system while the vehicle is parked.

Some functions are limited while driving.

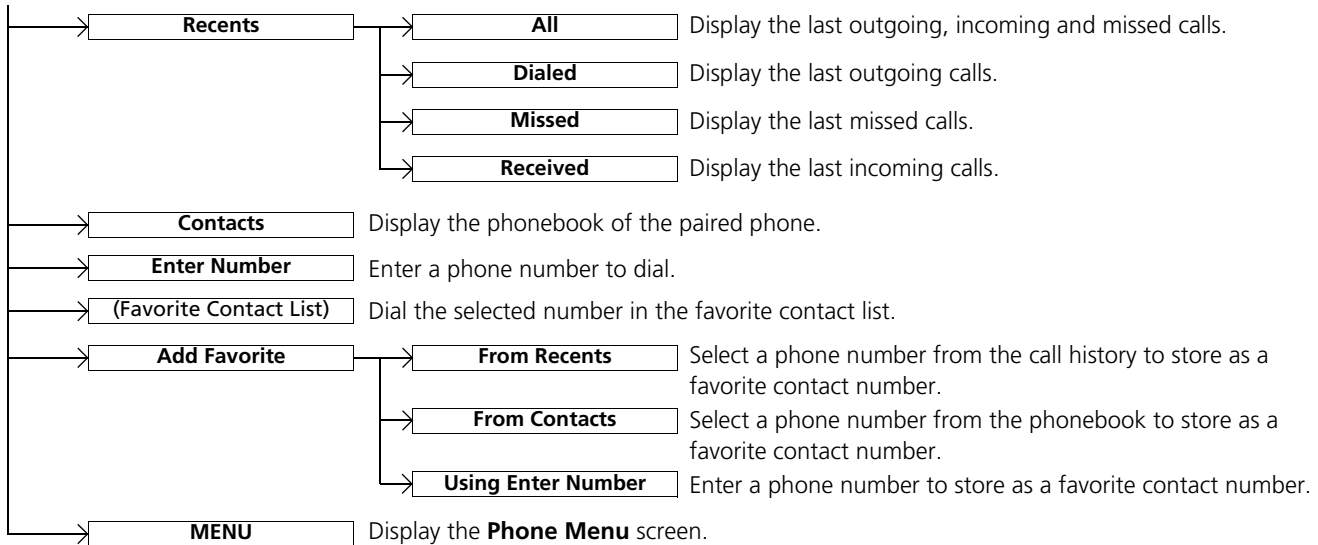

## ■ Phone Menu screen

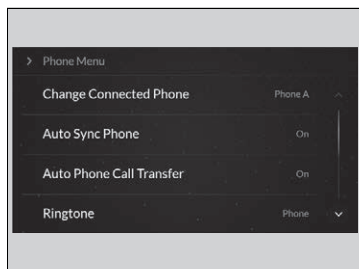

1. Press the  (home) button.
2. Select **Phone**.
3. Select **MENU**.

Change Connected Phone

+ Connect New Device

Pair a new phone to the system.

(Existing entry list)

Connect or disconnect a paired device.

Options

Delete Device

Delete a paired device.

Automatically Download Updates

Turn automatic download function of the software on and off.

Options

Turns the *Bluetooth*® on and off.

Auto Sync Phone

Set phonebook and call history data to be automatically imported when a phone is paired to HFL.

Auto Phone Call Transfer

Set calls to automatically transfer from your phone to HFL when you enter the vehicle.

Ringtone

Select a fixed ring tone or the one from the connected cell phone.

AcuraLink Assist

Turn AcuraLink Assist on and off.

## Phone Setup

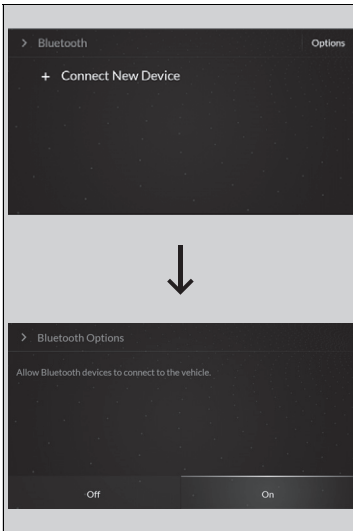

### ■ Bluetooth® setup

You can turn *Bluetooth*® function on and off.

1. Press the  (home) button.
2. Select **Settings**.
3. Select **Connections**.
4. Select **Bluetooth**.
5. Select **Options**.
6. Select **On**.

### ▶▶ Bluetooth® setup

If there is an active connection to Android Auto, this setting is unavailable.



■ **To pair a cell phone (when there is no phone paired to the system)**

1. Press the  (home) button.
2. Select **Phone**.
3. Select **Connect Phone**.
4. Make sure your phone is in search or discoverable mode, then select **+ Connect New Device**.
  - ▶ HFL automatically searches for a *Bluetooth*® device.
5. Select your phone when it appears on the list.
  - ▶ If your phone still does not appear, search for *Bluetooth*® devices using your phone. From your phone, search for **HandsFreeLink**.
6. The system gives you a pairing code on the audio/information screen.
  - ▶ Confirm if the pairing code on the screen and your phone match. This may vary by phone.
7. Select desired functions and then select **Connect**.
  - ▶ The pop-up menu appears on the screen, if the internet wireless hotspot function is selected.

☒ Phone Setup



Your *Bluetooth*-compatible phone must be paired to the system before you can make and receive hands-free calls.

Phone Pairing Tips:

- You cannot pair your phone while the vehicle is moving.
- Up to six phones can be paired.
- Your phone's battery may drain faster when it is paired to the system.

Once you have paired a phone, you can see it displayed on the screen with one or more icons on the right side.

These icons indicate the following:

- : The phone is compatible with *Bluetooth*® Audio.
- : The phone can be used with HFL.
- : The phone can be used with internet wireless hotspot.

If there is an active connection to Apple CarPlay or Android Auto, pairing of additional *Bluetooth*® compatible devices is unavailable.

**Enable Smart Sharing pop-up**

Smart Sharing to share phone data with Acura, you can change the setting later by deleting the device in **Phone Menu**.

For detail information of all data shared visit <https://acuralink.acura.com/#/acuralinkLegalTerms>



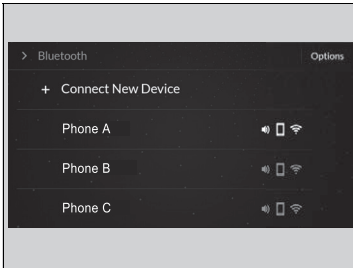

■ **To change the currently paired phone**

1. Go to the **Phone Menu** screen.
- ▶ **Phone Menu screen** P. 332
2. Select **Change Connected Phone**.

When connecting to other phone:

3. Select a phone to connect.
4. Select ,  or .
5. Select **Connect**.

When changing the currently paired phone setting:

3. Select a currently paired phone.
4. Select ,  or .
5. Select **Apply Changes**.

☒ **To change the currently paired phone**

If there is an active connection to Android Auto, this setting is unavailable.

If no other phones are found or paired when trying to switch to another phone, HFL will continue to connect a original phone.

To pair other phones, select **+ Connect New Device** from the **Bluetooth** screen.

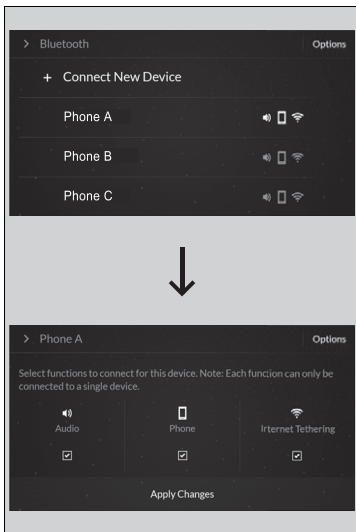

■ **To delete a paired phone**

1. Go to the **Phone Menu** screen.
  - ▶ **Phone Menu screen** P. 332
2. Select **Change Connected Phone**.
3. Select a phone you want to delete.
  
4. Select **Options**.
5. Select **Delete Device**.
6. A confirmation message appears on the screen. Select **Delete**.

▶▶ To delete a paired phone

You can also delete a paired phone by the following procedure.

1. Press the  (home) button.
2. Select **Settings**.
3. Select **Connections**.
4. Select **Bluetooth**.
5. Select a phone you want to delete.
6. Select **Options**.
7. Select **Delete Device**.
8. A confirmation message appears on the screen. Select **Delete**.

If there is an active connection to Android Auto, you cannot delete a paired phone.

## Ring Tone

You can change the ring tone setting.

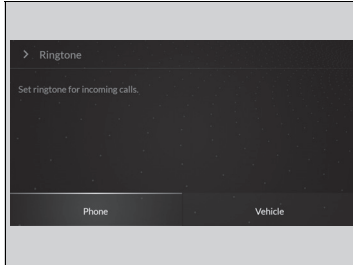

1. Go to the **Phone Menu** screen.  
     ▶ **Phone Menu screen** P. 332
2. Select **Ringtone**.
3. Select **Vehicle** or **Phone**.

## Automatic Transferring

If you get into the vehicle while you are on the phone, the call can be automatically transferred to HFL.

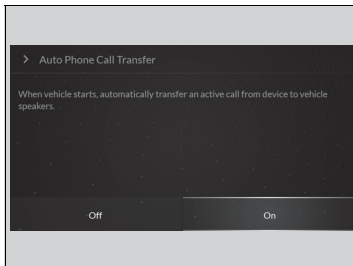

1. Go to the **Phone Menu** screen.  
     ▶ **Phone Menu screen** P. 332
2. Select **Auto Phone Call Transfer**.
3. Select **On** or **Off**.

## Ring Tone

**Vehicle:** The fixed ring tone sounds from the speakers.

**Phone:** Depending on the make and model of the cell phone, the ring tone stored in the phone will sound if the phone is connected.

## ■ Automatic Import of Cellular Phonebook and Call History

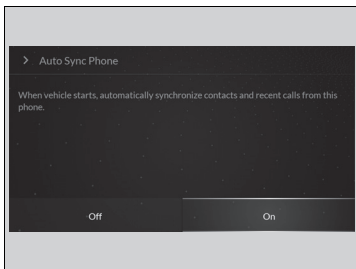
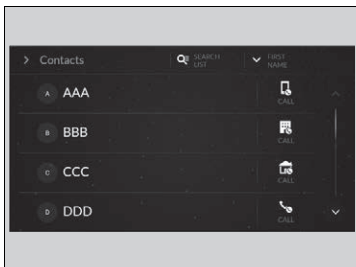

### ■ When Auto Sync Phone is set to On:

When your phone is paired, the contents of its phonebook and call history are automatically imported to the system.

### ■ Changing the Auto Sync Phone setting

1. Go to the **Phone Menu** screen.  
 ▶ **Phone Menu screen** P. 332
2. Select **Auto Sync Phone**.
3. Select **On** or **Off**.

## ▶▶ Automatic Import of Cellular Phonebook and Call History

On some phones, it is necessary to set up it enabled to be imported the cellular phonebook.

When you select a name from the list in the cellular phonebook, you can see a category icon. The icons indicate what types of numbers are stored for that name.

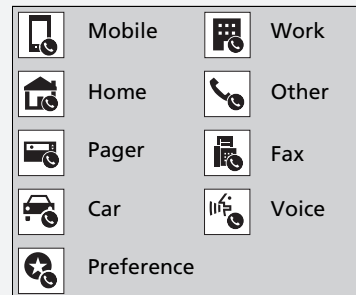

On some phones, it may not be possible to import the category icons to the system.

The phonebook is updated after every connection. Call history is updated after every connection or call.

## Favorite Contacts

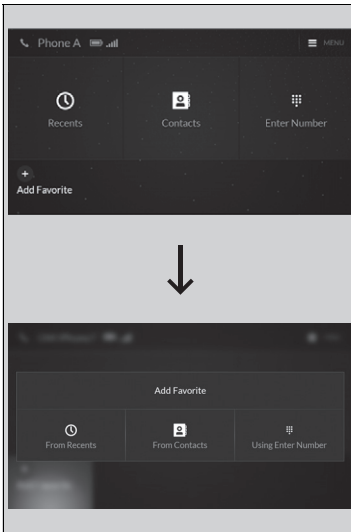

To store a favorite contact number:

1. Go to the phone screen.  
▶ **Phone screen** P. 331
2. Select **Add Favorite**.

3. Select a place from where to choose a number.

### **From Recents:**

- ▶ Select a number from the call history.

### **From Contacts:**

- ▶ Select a number from the phonebook of a cellular phone connected to the system.

### **Using Enter Number:**

- ▶ Trace the number on A-zone touchpad, then press it.

If the **KEYPAD** icon located to the upper right of the screen is selected, the keyboard will appear.

4. Select a number.

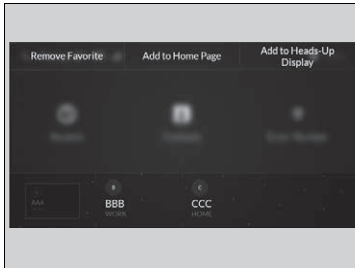

### ■ To edit a Favorite Contact

1. Go to the phone screen.  
 ▶ **Phone screen** P. 331
2. Select and hold a desired favorite contact.
3. Select the following options:
  - **Remove Favorite:** Delete the favorite contact.
  - **Add to Home Page:** Add a favorite contact shortcut icon to the home screen.
  - **Add to Heads-Up Display\*:** Add a favorite contact shortcut icon to the head-up display menu.
4. Press the  (back) button on the True Touchpad Interface.  
 ▶ The screen will return to the previous screen.

### ■ Making a Call

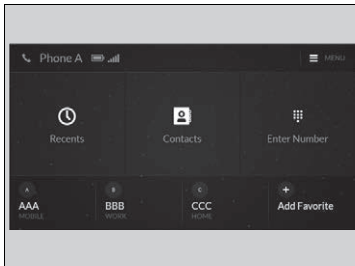

You can make calls by inputting any phone number, or by using the imported phonebook, call history, or Favorite Contact entries.

### ☒ Making a Call

Once a call is connected, you can hear the voice of the person you are calling through the audio speakers.

While there is an active connection with Apple CarPlay, phone calls cannot be made with HandsFreeLink® and are only made from Apple CarPlay.

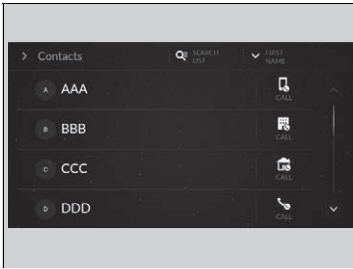

### ■ To make a call using the imported phonebook

1. Go to the phone screen.  
 ▶ **Phone screen** P. 331
2. Select **Contacts**.
3. Select a name.  
 ▶ You can sort by **First Name** or **Last Name**. Select the icon on the upper right of the screen.
4. Select a number.  
 ▶ Dialing starts automatically.

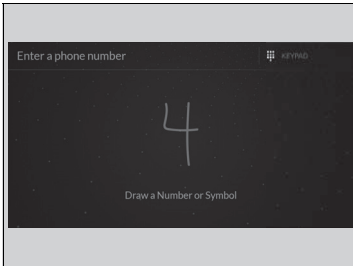

### ■ To make a call using a phone number

1. Go to the phone screen.  
 ▶ **Phone screen** P. 331
2. Select **Enter Number**.
3. Trace the number on A-zone touchpad, then press it.  
 ▶ You can enter the number using the on-screen keyboard. Select **KEYPAD** located to the upper right of the screen.
4. Press the A-zone touchpad.  
 ▶ Dialing starts automatically.  
 ▶ If the on screen keyboard is displayed, select **Call**.

### ☒ To make a call using the imported phonebook

You can send a message or set a navigation\* route to contact address other than making a call on this feature.

- ▶ **Text Message** P. 345
- ▶ **Refer to Navigation System Manual**

\* Not available on all models

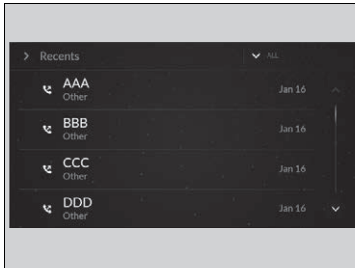

■ **To make a call using the call history**

Call history is stored by **All**, **Dialed**, **Missed**, and **Received**.

1. Go to the phone screen.  
▶ **Phone screen** P. 331
2. Select **Recents**.  
▶ You can sort by **All**, **Dialed**, **Missed**, or **Received**. Select the icon on the upper right of the screen.
3. Select a number.  
▶ Dialing starts automatically.

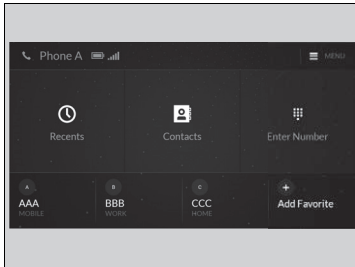

■ **To make a call using a Favorite Contact entry**

1. Go to the phone screen.  
▶ **Phone screen** P. 331
2. Select desired favorite contact.  
▶ Dialing starts automatically.



## Receiving a Call

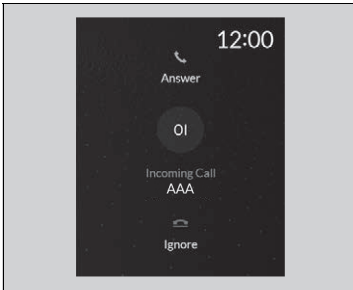

When there is an incoming call, an audible notification sounds (if activated) and the **Incoming Call...** screen appears.

Move the left selector wheel to the right to answer the call. Move it to the left to decline or end the call.

- ▶ You can also select **Answer** or **Ignore** on the audio/information screen to use hands-free calling.

### Receiving a Call

#### Call Waiting

To put a call on hold so that you can answer an incoming call, move the left selector wheel to the right.

Move the left selector wheel to the right to resume the call.

Select **Ignore** to ignore the incoming call if you do not want to answer it.

Move the left selector wheel to the left to end a call.

Instead of using the selector wheel, you can use the icons on the audio/information screen to perform the above mentioned functions.

When a screen other than the phone screen is displayed in the A-zone, the incoming call screen is displayed in the B-zone.

*Continued*

## ■ Options During a Call

The following options are available during a call.

**MUTE:** Mute your voice.

**TRANSFER TO MOBILE:** Transfer a call from the system to your phone.

**ENTER NUMBER:** Send numbers during a call. This is useful when you call a menu-driven phone system.

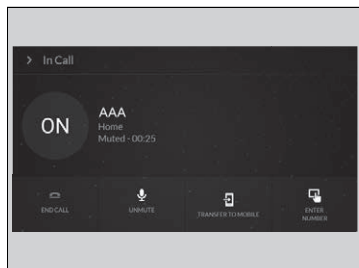

The available options are shown on the lower half of the screen.

Select the option.

- ▶ **UNMUTE** is displayed when the mute function is on. Select **UNMUTE** to turn it off.
- ▶ **TRANSFER TO VEHICLE** is displayed when the hands-free mode is off. Select **TRANSFER TO VEHICLE** to turn the hands-free mode is on.

## ▣ Options During a Call

You can select the icons on the audio/information screen.

## Text Message

You can operate the various options of the text message function from the message box.

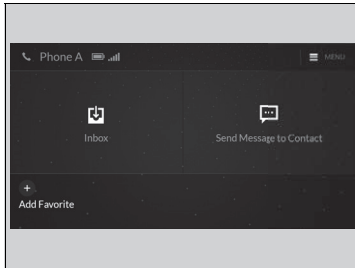

1. Press the  (home) button.
2. Select **Messages**.

The following options are available:

**Inbox:** Shows received messages.

**Send Message to Contact:** Sends a message to your contact on the list.

 **Send Message to Contact** P. 355

**Add Favorite:** Adds the favorite contact to the message box.

- ▶ You can add a shortcut to the home screen that will take you directly to your favorite contact. Select and hold the contact, then select **Add to Home Page**.



**MENU:** Sets the message option for changing the connected device, turning on or off message notifications, or editing replies.

### Text Message

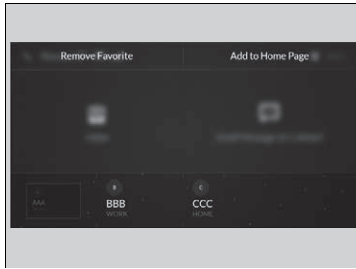
The text message features may not be available depending on a cellular phone.



### ■ To edit a Favorite Contact

1. Press the  (home) button.
2. Select **Messages**.
3. Select and hold a desired favorite contact.
4. Select following options.
  - **Remove Favorite:** Delete a favorite contact.
  - **Add to Home Page:** Add the shortcut icon of a favorite contact to the home screen.
5. Press the  (back) button on the True Touchpad Interface.
  - ▶ The screen will return to the previous screen.

## ■ To Set Up Text Message Options

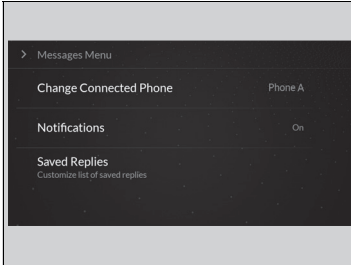

### ■ To turn on or off the text message notice

1. Press the  (home) button.
2. Select **Messages**.
3. Select **MENU**.
4. Select **Notifications**.
5. Select **On** or **Off**.

### ☒ To Set Up Text Message Options

To use the text message function, it may be necessary to set up on your phone.

### ☒ To turn on or off the text message notice

**On:** A pop-up notification comes on every time you receive a new message.

**Off:** The message you receive is stored in the system without notification.



When a screen other than the **Messages** function screen is displayed in the A-zone, a text message notification is displayed in the B-zone.

*Continued*

## ■ Receiving a Text Message

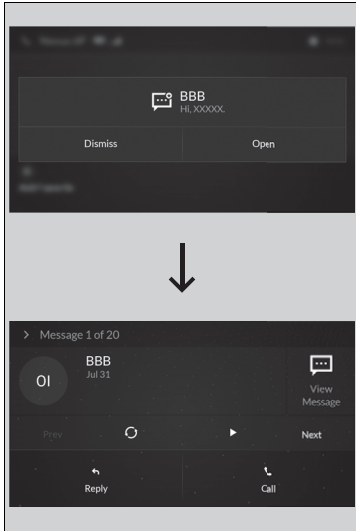
HFL can display newly received text messages as well as the last 20 messages received on a linked cell phone. Each received message can be read aloud and replied to using a fixed common phrase.



1. A pop-up appears and notifies you of a new text message.
2. Select **Open**.
3. Select  to listen to the message. To stop listening to the message, select .  
▶ Select  to hear the message from the beginning.

## ▶ Receiving a Text Message

Some cell phones might not be able to read the transmission log of data sent and data received.

The system does not display any received messages while you are driving. You can only hear them read aloud.

The system can only receive messages that are sent a text (SMS) messages. The message sent using the data services will not be displayed in the list.

With some phones, you may be able to display up to 20 of the last text messages received.

State or local laws may limit your use of the HFL text message feature. Only use the text message feature when conditions allow you to do so safely.

Depending on the status of A-zone, the received message screen may be displayed on the B-zone.

## Selecting a Phone

You can select one from the *Bluetooth*® device list to be active and receive notifications.

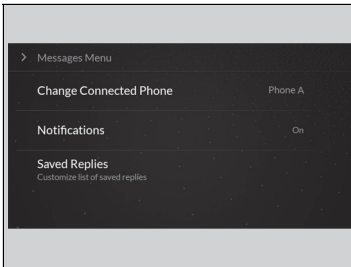

1. Press the  (home) button.
2. Select **Messages**.
3. Select **MENU**.
4. Select **Change Connected Phone**.
5. Change a desired phone.
  - ▶ **To change the currently paired phone**

P. 335

## Selecting a Phone

You can only receive notifications from one phone at a time.

You can only connect one device to use both text message function and *Bluetooth*® hands-free phone function.

If there is an active connection to Android Auto, this setting is unavailable.

## ■ Displaying Messages

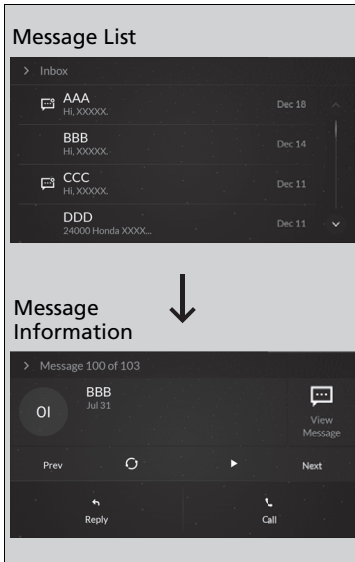

1. Press the  (home) button.
2. Select **Messages**.
3. Select **Inbox**.
4. Select a message.
  - ▶ The message information is displayed.
5. Select **View Message**.
  - ▶ The text message is displayed.

## » Displaying Messages

The  icon appears next to an unread message.



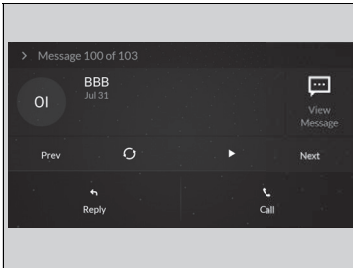

If you delete a message on the phone, the message will also be deleted from the system. If you send a message from the system, the message goes to your phone's outbox.

To see the previous or next message, select **Prev** or **Next** on the message screen.





### ■ Read or Stop reading a message

1. Display the message information.
2. Select .
  - ▶ The system starts reading the message aloud.
3. Select  to stop reading.
  - Select  again to start reading the message.
  - ▶ While listen to the message, select  to start reading the message from the beginning.

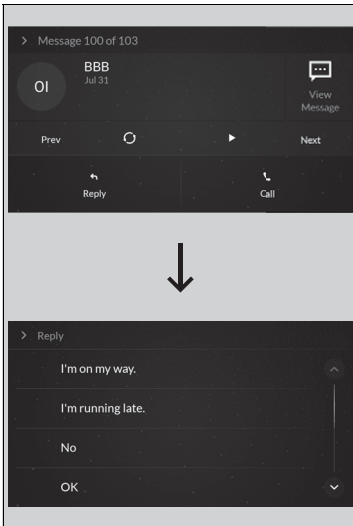

### ■ Reply to a message

1. Display the message information.
2. Select **Reply**.
3. Select the reply message.
  - ▶ The pop-up menu appears on the screen.
4. Select **Send** to send the message.
  - ▶ **Message sent** appears on the screen when the reply message was successfully sent.

### ✉ Reply to a message

The available reply messages are as follows:

- **I'm on my way.**
- **I'm running late.**
- **No**
- **OK**
- **Talk to you later, I'm driving.**
- **Yes**

The display language of the default reply message depends on the connected phone.

✉ **To edit a reply message** P. 352

You can add or delete a reply message by selecting **Saved Replies**.

✉ **To edit a reply message** P. 352

✉ **To delete a reply message** P. 352

Only certain phones receive and send messages when paired and connected. For a list of compatible phones:

- U.S.: Visit [www.handsfreelink.com/Acura](http://www.handsfreelink.com/Acura), or call 1-888-528-7876.
- Canada: For more information on smartphone compatibility, call 1-855-490-7351.

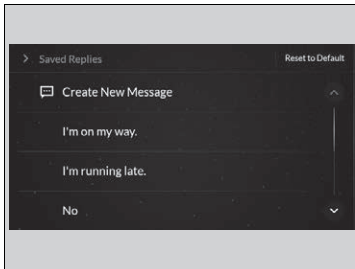
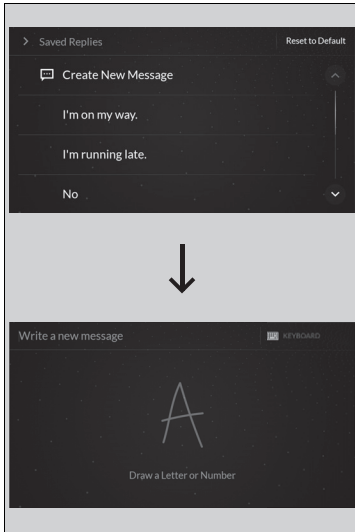

Continued



■ **To edit a reply message**

1. Press the  (home) button.
  2. Select **Messages**.
  3. Select **MENU**.
  4. Select **Saved Replies**.
  5. Select **Create New Message**.
  6. Use A-zone touchpad to write a reply.  
When you finish writing you message, press the A-zone touchpad.
- ▶ You can enter the number using the on-screen keyboard. Select **KEYBOARD** located to the upper right of the screen.

■ **To delete a reply message**

1. Press the  (home) button.
2. Select **Messages**.
3. Select **MENU**.
4. Select **Saved Replies**.
5. Select a reply message you want to delete.
  - ▶ A confirmation screen appears on the screen. Select **Delete**.
  - ▶ To cancel the delete, press the  (back) button.

▶▶ **To delete a reply message**

**Reset to Default**

Select to reset all reply messages to their factory default.

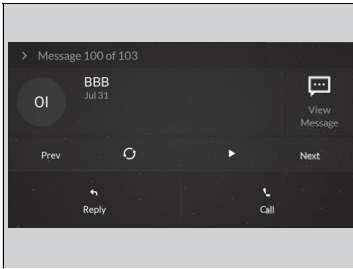

■ **Making a call to a sender**

1. Display the message information.
2. Select **Call**.

Models with head-up display

■ **Displaying message on the head-up display**

You can read a text message on the head-up display only when text message is received.

1. Move right the left selector wheel to select **Open**.
2. Roll up or down the left selector wheel to select **Reply**, and then press the left selector wheel.
  - ▶ Select **Call** to dial a call.
  - ▶ Select **Repeat** to start reading the message from the beginning.
3. Roll up or down the left selector wheel to select a message, and then press the left selector wheel.
4. Roll up or down the left selector wheel to select **Send**, and then press the left selector wheel.
  - ▶ **Message sent** appears on the head-up display when the reply message was successfully sent.

## Send Message to Contact

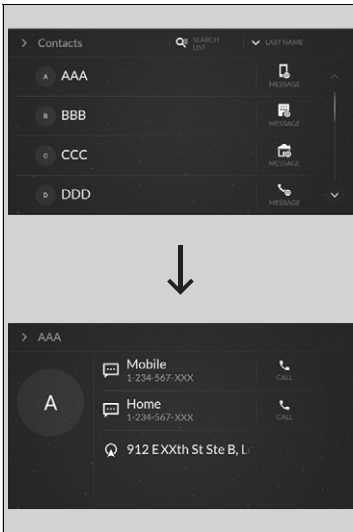

1. Press the  (home) button.
2. Select **Messages**.
3. Select **Send Message to Contact**.
4. Select a contact name.
  - ▶ You can sort by **First Name** or **Last Name**. Select the icon on the upper right of the screen.
5. Select a number.
6. Select the reply message.
  - ▶ The pop-up menu appears on the screen.
7. Select **Send** to send the message.
  - ▶ **Message sent** appears on the screen when the reply message was successfully sent.

## Send Message to Contact

You can make a call or set a navigation route\* to contact address other than sending a message on this feature.

▶ **Making a Call** P. 340

▶ **Refer to Navigation System Manual**

\* Not available on all models

Is a subscription-based service that provides convenient features such as voice communication in case of emergency, online security, one-on-one operator assistance, and the transmission of important messages regarding your vehicle's status.

## To Connect to AcuraLink

Use the following procedure to connect to AcuraLink.

### To enable the AcuraLink

You need to allow the consent of the location service to enable the AcuraLink.

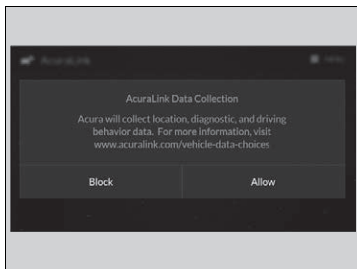

1. Press the  (home) button.
2. Select **AcuraLink**.

▶ The confirmation message appears on the screen for the first time, then select **Allow**.

### AcuraLink®

AcuraLink also provides services you can operate from the Internet or your smartphone.

To subscribe to AcuraLink, or to get more information about all of its features, contact an Acura dealer, or visit *owners.acura.com* (U.S.) or *www.acura.ca/owners/acuralink* (Canada).

### To enable the AcuraLink

You can also set up a **Vehicle Data Collection** by the following procedure.

1. Press the  (home) button.
2. Select **AcuraLink**.
3. Select **MENU**.
4. Select **Vehicle Data Collection**.
5. Select **Allow** or **Block**.
  - **Allow**: Sends the vehicle location data, diagnostic information, driving behavior data and phone data when you have previously allowed it when you connect a phone with *Bluetooth*®.
  - **Block**: Does not send the vehicle location data, diagnostic information, driving behavior data.

For detail information of all data shared visit <https://acuralink.acura.com/#/acuralinkLegalTerms>

## ■ To link with AcuraLink

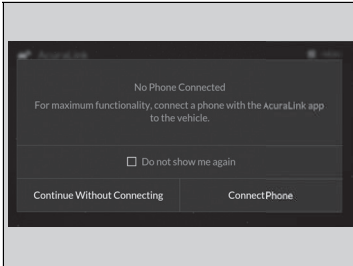

You may see the connection guide screen after launching AcuraLink when there is no phone connection available.

**Continue Without Connecting:** Displays the AcuraLink menu screen without phone connection.

**Connect Phone:** Displays the *Bluetooth*® setup screen.

➤ **To change the currently paired phone**  
P. 335

## ■ AcuraLink

1. Press the  (home) button.
2. Select **AcuraLink**.

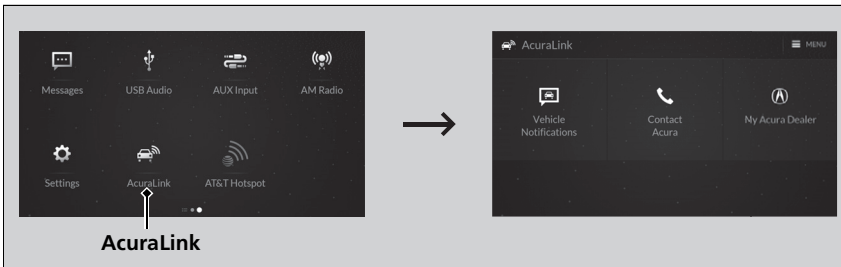

## ▶▶ To link with AcuraLink

We recommend that you install AcuraLink app in your smartphone to make AcuraLink more functional, contact an Acura dealer, or visit [owners.acura.com](http://owners.acura.com) (U.S.) or [www.acura.ca/owners/acuralink](http://www.acura.ca/owners/acuralink) (Canada).

If you do not connect a phone to AcuraLink, Last Mile function of AcuraLink app is disabled.

## ▶▶ AcuraLink

You can also select **AcuraLink** from the **All Apps** screen.

➤ **Audio/Information Screen** P. 212

## ■ Vehicle Notifications

Displays the diagnostic information, recall or important safety information\*<sup>1</sup>, or general information by connecting to the Acura server using HFL.

## ■ Contact Acura

Connect to the AcuraLink operator when trying to find a destination or for roadside assistance.

## ■ My Acura Dealer

Calls your Acura dealer using HFL or sets a destination of the navigation\* to the dealer.

## ■ MENU

Displays the AcuraLink menu screen.

- **Vehicle Data Collection:** Displays the AcuraLink connection setting screen.
  - ☑ **To enable the AcuraLink** P. 356
- **AcuraLink Subscriptions:** Displays your current AcuraLink subscription status.
- **Connect Bluetooth Device:** Displays the *Bluetooth*® setup screen.
  - ☑ **To change the currently paired phone** P. 335

\*1: When you select **Roadside Assistance**, the system connect to the AcuraLink operator through the telematics control unit (TCU).

\* Not available on all models

## ☒ Vehicle Notifications

Some messages can be deleted manually; some others will automatically disappear when the malfunction is fixed, contact a dealer if necessary.



## AcuraLink Message

You can check the messages that are received quickly in the shortcut operation.

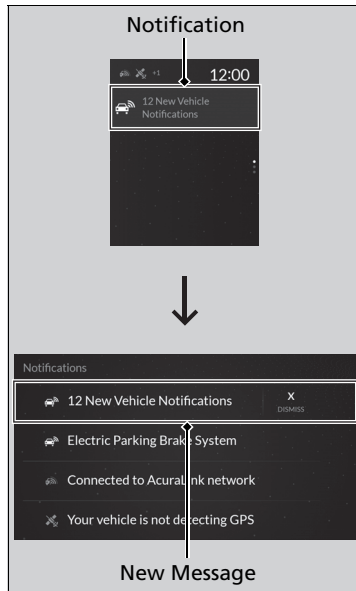

1. A notification appears and notifies you of a new message on the B-zone.
2. Select the system status icon then press the B-zone touchpad.
  - ▶ The status area list appears on the A-zone.
  - ▶ A notification is continuously displayed in the header area until the new message is read.
3. Select a new message to open.
  - ▶ If you have selected the update option for AcuraLink, follow the directions on the screen to complete the process.

## AcuraLink Message

When you update AcuraLink, you must keep the engine running and maintain a constant connection with AcuraLink.

If the update is interrupted, the system will automatically resume the process. If, however, a week has elapsed since the process was first interrupted, you must repeat the process from the beginning.

## ■ In Case of Emergency

### ■ Automatic collision notification

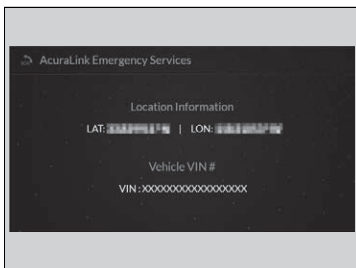

If your vehicle's airbags deploy or if the unit detects that the vehicle is severely impacted, your vehicle automatically will attempt to connect to the AcuraLink operator. If connected, information about your vehicle, its location, and its condition can be sent to the operator\*<sup>1</sup>; you also can speak to the operator when connected.

**IMPORTANT:** In a crash, AcuraLink will attempt to notify emergency services but NEITHER ACURA NOR ITS SERVICE PROVIDERS GUARANTEE THAT SUCH NOTIFICATION WILL OCCUR.

Acura reserves the right to terminate AcuraLink services at any time or for any reason, and in the future may not be able to provide services due to changes in, or obsolescence of, technology integral to the service or changes in governmental regulation.

\*1: Depending on your phone and adequate cellular coverage, your vehicle's location may not be sent to the operator.

### ☒ In Case of Emergency

Your vehicle may not be able to connect to the operator if the battery level is low, the line is disconnected, or you do not have adequate cellular coverage.

You cannot use this emergency services when:

- You travel outside the AcuraLink service coverage areas.
- There is a problem with the connecting devices, such as the microphones, speakers, or the unit itself.

You cannot operate other phone-related functions using the screen while talking to the operator. Only the operator can terminate the connection to your vehicle.

### ☒ Automatic collision notification

If the unit fails to connect to the operator, it repeatedly tries until it succeeds.

## ■ Manual operator connection

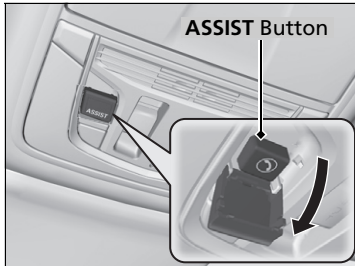

If you need to talk to the AcuraLink operator in a situation where no airbag has deployed, you can manually connect to them by pressing the **ASSIST** button with the power mode in ACCESSORY or ON.

1. Open the cover attached to the ceiling console.
2. Press the **ASSIST** button.
  - ▶ You are connected to the AcuraLink operator.

## ☒ Manual operator connection

Do not press the button while driving. When you need to contact the operator, park the vehicle in a safe place.

If the unit fails to connect to the operator, it automatically cancels the action after three minutes.

If necessary, the cover can be broken to access the **ASSIST** button.

## ■ Operator Assistance

Connect to the AcuraLink operator when trying to find a destination or for roadside assistance.

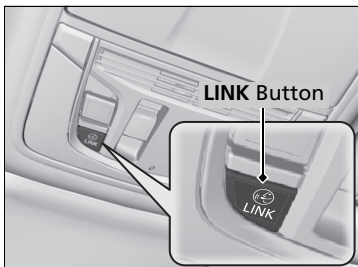

1. Press the **LINK** button.
  - ▶ Connection to the operator begins.
2. Talk to the operator.
  - ▶ To disconnect, select **End Call** on the audio/information screen or move to left the left selector wheel.

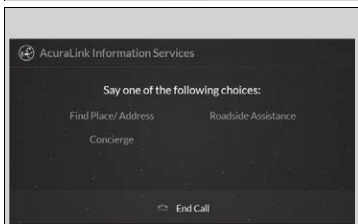



Audio/Information screen when connected to the AcuraLink operator

## ☞ Operator Assistance

Remain attentive to road conditions and driving during operator assistance.

If you want to add or renew a subscription, call the Operator Assistance.

1. Press the  (home) button.
2. Select **AcuraLink**.
3. Select **MENU**.
4. Select **AcuraLink Subscriptions**.
5. Select **Call AcuraLink Support**.

Press the  (back) button to return to the previous screen, and then incall screen displayed on the B-zone.

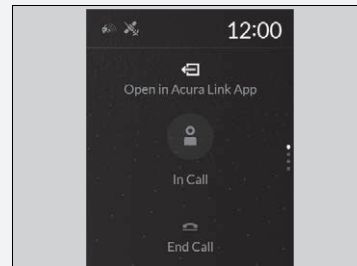

## ■ Connection Features

Your subscribed telematics service provider can check your vehicle's condition. For maximum functionality download AcuraLink app in your smartphone and connect it with the vehicle.

### ■ Automatic Collision Notifications

A live agent will reach out and check on you and request that help be sent in the event of a crash.

### ■ Send Destination

Search for destinations on your phone and instantly beam turn-by-turn directions to your navigation system\*. Requires In-vehicle Navigation System\*.

### ■ Stolen Vehicle Locator

In the event of a stolen vehicle, your vehicle will help local authorities recover it.

### ■ Remote Start & Stop

Arrive at your vehicle with the engine warmed up and the interior set to a comfortable temperature.

### ■ Remote Lock & Unlock

Lock and unlock your vehicle with your smartphone.

### ■ Find My Car

Find your parked vehicle and flash/sound your horns remotely using your smartphone.

\* Not available on all models

## ☒ Connection Features

The contact information of your provider, your user ID and PIN will be given when you subscribe to AcuraLink. If you forget any of the above, contact a Acura dealer, or go to [owners.acura.com](http://owners.acura.com) (U.S.) or [www.acura.ca/owners/acuralink](http://www.acura.ca/owners/acuralink) (Canada).

You can also activate the remote door lock/unlock and vehicle finder features from the Internet or using your smartphone app. Ask a dealer, or visit [owners.acura.com](http://owners.acura.com) (U.S.) or [www.acura.ca/owners/acuralink](http://www.acura.ca/owners/acuralink) (Canada) for details.

## ☒ Find My Car

The lights will stop flashing and horn will stop sounding under the following:

- When conditions 30 seconds have elapsed.
- You unlock the doors using the remote transmitter.
- You unlock the doors using the keyless access system.
- You unlock the doors using the built-in key.
- The power mode is set to ACCESSORY or ON.

Continued

■ **Vehicle Status**

Get door and lock status as well as mileage, fuel, oil life, and tire pressure readings on your phone.

■ **Emergency Call**

A live agent will stay on the call with you and request that help be sent in the event of an emergency.

■ **Security Alarm Alert**

Receive alerts if vehicle security alarm is triggered.

■ **Destination by Voice**

Talk to a live assistant who will search and send turn by turn directions to your vehicle's navigation system\*. Requires In-vehicle Navigation System\*.

■ **Last Mile**

Receive walking directions to your final destination right when you get out of your Acura. Requires In-vehicle Navigation System\*.

■ **Geofence Alert**

Receive a notification anytime your vehicle enters or leaves a region set by you.

■ **Speed Alert**

Receive a notification when your vehicle has exceeded a speed limit set by you.



# Driving

This chapter discusses driving and refueling.

<b>Before Driving</b> .....	366	Super Handling-All Wheel Drive™ (SH-AWD®) * .....	405	Traffic Jam Assist .....	457
<b>Towing a Trailer</b> .....	371	Tire Pressure Monitoring System (TPMS) with Tire Fill Assist.....	406	Road Departure Mitigation (RDM) System.....	469
<b>When Driving</b>		Tire Pressure Monitoring System (TPMS) - Required Federal Explanation.....	408	Traffic Sign Recognition System .....	474
Starting the Engine .....	372	Blind spot information System* .....	410	Front Sensor Camera .....	480
Precautions While Driving.....	378	<b>AcuraWatch™</b> .....	413	Radar Sensor .....	482
Automatic Transmission .....	379	Collision Mitigation Braking System™ (CMBS™) .....	417	<b>Braking</b> .....	483
Shifting.....	380	Adaptive Cruise Control (ACC) with Low Speed Follow .....	428	<b>Parking Your Vehicle</b> .....	492
Integrated Dynamics System.....	388	Lane Keeping Assist System (LKAS) ..	448	<b>Multi-View Rear Camera</b> * .....	503
Auto Idle Stop.....	395			<b>Surround View Camera System</b> * .....	505
Vehicle Stability Assist™ (VSA®), aka Electronic Stability Control (ESC), System .....	402			<b>Refueling</b> .....	513
Agile Handling Assist .....	404			<b>Fuel Economy and CO<sub>2</sub> Emissions</b> ....	516

\* Not available on all models

## Driving Preparation

Check the following items before you start driving.

### Exterior Checks

- Make sure there are no obstructions on the windows, door mirrors, exterior lights, or other parts of the vehicle.
  - ▶ Remove any frost, snow, or ice.
  - ▶ Remove any snow on the roof, as this can slip down and obstruct your field of vision while driving. If frozen solid, remove ice once it has softened.
  - ▶ When removing ice from around the wheels, be sure not to damage the wheel or wheel components.
- Make sure the hood is securely closed.
  - ▶ If the hood opens while driving, your front view will be blocked.
- Make sure the tires are in good condition.
  - ▶ Check air pressures, and check for damage and excessive wear.
    - ✎ **Checking and Maintaining Tires** P. 544
- Make sure there are no people or objects behind or around the vehicle.
  - ▶ There are blind spots from the inside.

### Exterior Checks

#### NOTICE

When doors are frozen shut, use warm water around the door edges to melt any ice. Do not try to force them open, as this can damage the rubber trim around the doors. When done, wipe dry to avoid further freezing.

Do not pour warm water into the key cylinder. You will be unable to insert the key if the water freezes in the hole.

Heat from the engine and exhaust can ignite flammable materials left under the hood, causing a fire. If you've parked your vehicle for an extended period, inspect and remove any debris that may have collected, such as dried grass and leaves that have fallen or have been carried in for use as a nest by a small animal. Also check under the hood for leftover flammable materials after you or someone else has performed maintenance on your vehicle.



## Interior Checks

- Store or secure all items on board properly.
  - ▶ Carrying too much cargo, or improperly storing it, can affect your vehicle's handling, stability, stopping distance, and tires, and make it unsafe.
    - ✦ **Maximum Load Limit** P. 369
- Do not pile items higher than the seat height.
  - ▶ They can block your view and may be thrown forward in the event of sudden braking.
- Do not place anything in the front seat footwells. Make sure to secure the floor mat.
  - ▶ An object or unsecured floor mat can interfere with your brake and accelerator pedal operation while driving.
- If you have any animals on board, do not let them move around in the vehicle.
  - ▶ They may interfere with driving and a crash could occur.
- Securely close and lock all doors and the trunk.
  - ✦ **Locking/Unlocking the Doors from the Inside** P. 130
- Adjust your seating position properly.
  - ▶ Adjust the head restraint, too.
    - ✦ **Seats** P. 166
    - ✦ **Adjusting the Head Restraint Positions** P. 172
- Adjust the mirrors and steering wheel properly.
  - ▶ Adjust them while sitting in the proper driving position.
    - ✦ **Adjusting the Steering Wheel** P. 162
    - ✦ **Mirrors** P. 163

## Interior Checks

The headlight aim is set by the factory, and does not need to be adjusted. However, if you regularly carry heavy items in the trunk have the aiming readjusted at a dealer or by a qualified technician.

- Be sure items placed on the floor behind the front seats cannot roll under the seats.
  - ▶ They can interfere with the driver's ability to operate the pedals, the operation of the seats, or the operation of the sensors under the seats.
- Everyone in the vehicle must fasten their seat belt.
  - 📄 **Fastening a Seat Belt** P. 39
- Make sure that the indicators in the instrument panel come on when you start the vehicle, and go off soon after.
  - ▶ Always have a dealer check the vehicle if a problem is indicated.
    - 📄 **Indicators** P. 78

## Maximum Load Limit

The maximum load for your vehicle is 838 lbs (380 kg). See the Tire and Loading Information label attached to the driver's doorjamb.

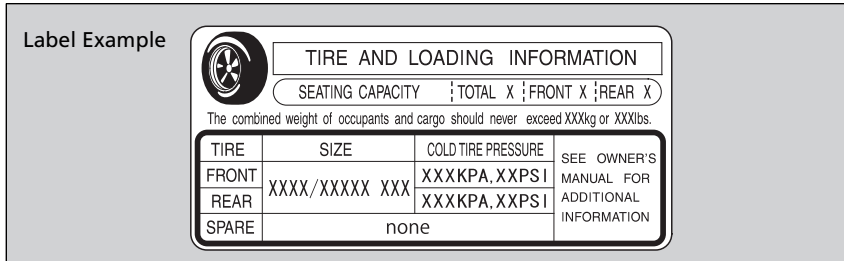

This figure includes the total weight of all occupants, cargo, and accessories, and the tongue load if you are towing a trailer.

Steps for Determining Correct Load Limit -

- (1) Locate the statement "The combined weight of occupants and cargo should never exceed XXX kg or XXX lbs." on your vehicle's placard.
- (2) Determine the combined weight of the driver and passengers that will be riding in your vehicle.
- (3) Subtract the combined weight of the driver and passengers from XXX kg or XXX lbs.
- (4) The resulting figure equals the available amount of cargo and luggage load capacity. For example, if the "XXX" amount equals 1,400 lbs. and there will be five 150 lb. passengers in your vehicle, the amount of available cargo and luggage load capacity is 650 lbs. (1,400 - 750 (5 x 150) = 650 lbs.)

Continued

### Maximum Load Limit

## ⚠ WARNING

Overloading or improper loading can affect handling and stability and cause a crash in which you can be hurt or killed.

Follow all load limits and other loading guidelines in this manual.

Gross Vehicle Weight Rating (GVWR):

The maximum allowable weight of the vehicle, all occupants, all accessories and all cargo.

➤ Specifications P. 618

Gross Axle Weight Rating (GAWR):

The maximum allowable weight of the vehicle axle.

➤ Specifications P. 618

- (5) Determine the combined weight of luggage and cargo being loaded on the vehicle. That weight may not safely exceed the available cargo and luggage load capacity calculated in step 4.
- (6) If your vehicle will be towing a trailer, load from your trailer will be transferred to your vehicle. Consult this manual to determine how this reduces the available cargo and luggage load capacity of your vehicle.

In addition, the total weight of the vehicle, all occupants, accessories, cargo, and trailer tongue load must not exceed the Gross Vehicle Weight Rating (GVWR) or the Gross Axle Weight Rating (GAWR). Both are on a label on the driver's doorjamb.

▶▶ Maximum Load Limit

Towing a Trailer:

See Towing a Trailer to determine whether your vehicle is designed to tow a trailer.

▶▶ **Towing a Trailer** P. 371

Load Limits Example

Example 1



Max Load  
838 lbs  
(380 kg)



Passenger Weight  
150 lbs x 2 = 300 lbs  
(68 kg x 2 = 136 kg)



Cargo Weight  
538 lbs  
(244 kg)

Example 2



Max Load  
838 lbs  
(380 kg)



Passenger Weight  
150 lbs x 5 = 750 lbs  
(68 kg x 5 = 340 kg)



Cargo Weight  
88 lbs  
(40 kg)

Your vehicle is not designed to tow a trailer. Attempting to do so can void your warranties.

### **Towing Behind a Motorhome**

---

Your vehicle is not designed to be towed behind a motor home. If your vehicle needs to be towed in an emergency, refer to the emergency towing information.

📄 **Emergency Towing** P. 612

## Starting the Engine

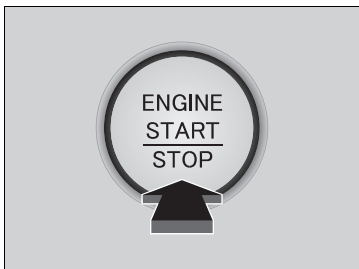
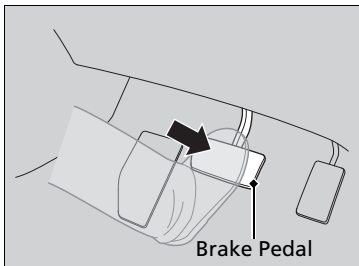
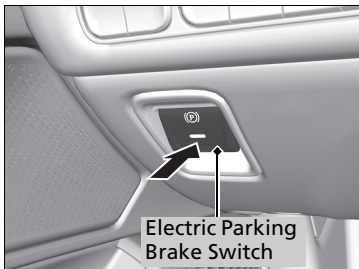

1. Make sure the parking brake is applied.
  - ▶ The parking brake and brake system indicator comes on for 30 seconds when you press the electric parking brake switch.
2. Check that the transmission is in **P**, then depress the brake pedal.
  - ▶ Although it is possible to start the vehicle in **N**, it is safer to start it in **P**.
3. Press the **ENGINE START/STOP** button without depressing the accelerator pedal.

### Starting the Engine

Keep your foot firmly on the brake pedal when starting the engine.

The engine is harder to start in cold weather and in thinner air found at altitudes above 8,000 feet (2,400 meters).

When starting the engine in cold weather, turn off all electrical accessories such as the lights, climate control system, and rear defogger in order to reduce battery drain.

If you live in a region where winter is extremely cold, an engine block heater will improve starting and warming of the engine. Consult a dealer for details.

If the exhaust system sounds abnormal or you can smell exhaust gas inside the vehicle, have your vehicle checked by a dealer. There may be a problem with the engine or exhaust system.

Bring the keyless access remote close to the **ENGINE START/STOP** button if the battery in the keyless access remote is weak.

▶ **If the Keyless Access Remote Battery is Weak** P. 591

The engine may not start if the keyless access remote is subjected to strong radio waves.

▶▶ Starting the Engine

Do not hold the **ENGINE START/STOP** button to start the engine.

If the engine does not start, wait at least 30 seconds before starting the engine again.

The immobilizer system protects your vehicle from theft.

If an improperly coded device is used, the engine's fuel system is disabled.

▶ **Immobilizer System** P. 137

## ■ Remote Engine Start\*

You can remotely start the engine using the two-way keyless access remote from extended distances.

### ■ To start the engine

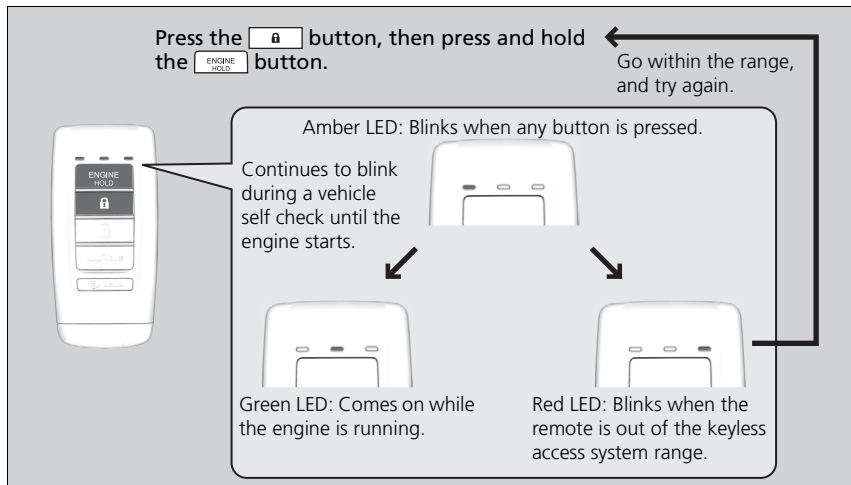

The engine runs for up to 10 minutes without you starting the vehicle.

To extend the run time for another 10 minutes during the first run, press the button, then press and hold the .

▶ The amber LED blinks, then the green LED comes back on if a 10-minute extension request was transmitted successfully.

After pressing the button, wait for the green LED to blink. This indicates that all the doors and the trunk are locked.

\* Not available on all models

## ⊠ Remote Engine Start\*

### ⚠ WARNING

Carbon monoxide gas is toxic and can rapidly accumulate in closed or even partly enclosed areas.

Breathing it can cause unconsciousness and even kill you.

Never use the remote engine starter with the vehicle parked in a garage or other areas with limited ventilation.

The remote engine start may violate local laws. Before using the remote engine start, check your local laws.

If there are buildings and obstacles between your vehicle and the remote, the range will be reduced. This distance may vary by external electrical interference.

The engine may not start by the remote engine start if:

- You have disabled a remote engine start setting using the audio/information screen.

#### ⊠ Customized Features P. 300

- The power mode is not in VEHICLE OFF (LOCK).
- The transmission is in a position other than .
- The hood is open, or any door or the trunk is unlocked.
- You have already used the remote twice to start the engine.



## ■ To stop the engine

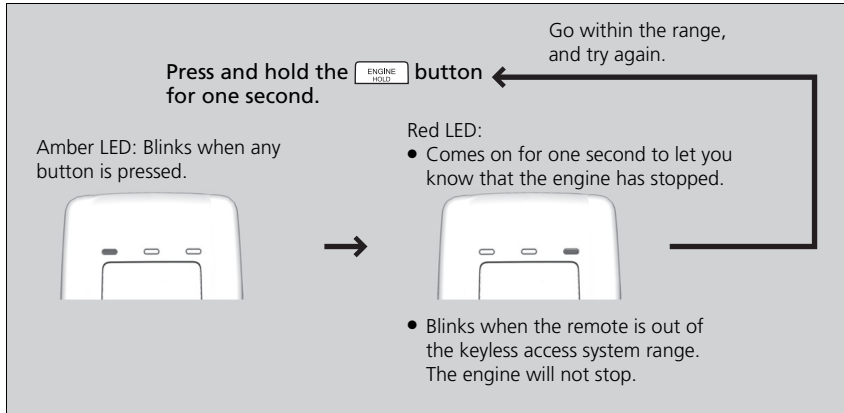

### ⊞ Remote Engine Start\*

- Another registered keyless access remote is in the vehicle.
- There is any antenna failure.
- The door is unlocked with the built-in key.
- The engine oil pressure is low.
- The engine coolant temperature is extremely high.
- The security system alarm is not set.
- The keyless access remote is left in the vehicle when you get out.

Before starting the engine, make sure to check the door lock status using the remote. When you press the  button, wait for the green LED to blink. If the red LED turns on, the doors and trunk did not lock, and the engine does not start.

While the engine is running, the vehicle will automatically precondition inside the vehicle. When it is warm outside:

- The climate control system is activated.
- The seat ventilation is activated\*.

When it is cold outside:

- The defroster is activated at a moderately warm temperature.
- The rear defogger and door mirror heaters are activated.
- The seat heaters and heated steering wheel are activated\*.

➤ **Heated Steering Wheel\*** P. 194

➤ **Front Seat Heaters and Ventilation\***  
P. 192

\* Not available on all models

## Starting to Drive

When the engine was started using the keyless access remote\*

1. Depress and hold the brake pedal, then press the **ENGINE START/STOP** button.

When the engine was started in any case

2. Keeping your right foot on the brake pedal, put the transmission into **[D]**. Select **[R]** when reversing.

3. With the parking brake applied, release the brake pedal and gently depress the accelerator pedal.

▶ Make sure the parking brake and brake system indicator goes off.

☒ **Parking Brake** P. 483

☒ **If the Transmission System Indicator Blinks along with the Warning Message** P. 604

## Starting to Drive

You can also release the parking brake by pulling the electric parking brake switch while depressing the brake pedal.

When facing downhill, you can start your vehicle more smoothly by manually releasing it with the electric parking brake switch than by releasing it with the accelerator pedal.

When the engine was started using the keyless access remote\*

The engine stops when the transmission is taken out of **[P]** before the **ENGINE START/STOP** button is pressed. Follow step 1 when starting to drive.

## ■ Hill Start Assist System

Hill start assist keeps the brake engaged briefly to help prevent the vehicle from rolling on inclines as you move your foot from the brake pedal to the accelerator.

Put the transmission into **D** or **S** when facing uphill, or **R** when facing downhill, then release the brake pedal.

## ■ Stopping the Engine

You can turn the engine off when the vehicle is completely stopped.

1. Put the transmission into **P**.
2. Press the **ENGINE START/STOP** button.

### ⌘ Hill Start Assist System

Hill start assist may not prevent the vehicle from rolling downhill on a very steep or slippery slope, and will not operate on small inclines.

Hill start assist will operate even when VSA® is switched off.

Hill start assist is not a replacement for the parking brake.

## Precautions While Driving

### ■ In Rain

Avoid driving in deep water and on flooded roads. This can damage the engine or driveline, or cause electrical component failure.

### » Precautions While Driving

#### NOTICE

Do not select a shift button while pressing the accelerator pedal. You could damage the transmission.

#### NOTICE

If you repeatedly turn the steering wheel at an extremely low speed, or hold the steering wheel in the full left or right position for a while, the electric power steering (EPS) system heats up. The system goes into a protective mode, and limits its performance. The steering wheel becomes harder and harder to operate. Once the system cools down, the EPS system is restored. Repeated operation under these conditions can eventually damage the system.

If the power mode is set to ACCESSORY while driving, the engine will shut down and all steering and brake power assist functions will stop, making it difficult to control the vehicle.

## ■ Other Precautions

If there is a strong impact with something under the vehicle, stop in a safe location. Check the underside of the vehicle for damage or any fluid leaks.

## Automatic Transmission

### ■ Creeping

When the engine runs at higher idle speeds, the creeping force increases. Keep the brake pedal firmly depressed when stopped.

### ■ Kickdown

Quickly depressing the accelerator pedal while driving uphill may cause the transmission to drop to a lower gear, unexpectedly increasing vehicle speed. Depress the accelerator pedal carefully, especially on slippery roads and curves.

### ⌘ Precautions While Driving

Do not select **N** while driving as you will lose engine braking (and acceleration) performance.

During the first 600 miles (1,000 km) of operation, avoid sudden acceleration or full throttle operation so as not to damage the engine or powertrain.

Avoid hard braking for the first 200 miles (300 km). You should also follow this when the brake pads are replaced.

## Shifting

Change the gear position in accordance with your driving needs.

### ■ Shift button positions



**P** **Park**  
Used when parking, before turning off or starting the engine

**R** **Reverse**  
Used when reversing

**N** **Neutral**  
Transmission is not locked

**D/S** **Drive/S Position**  
Each time you press the **D/S** button, the mode switches between Drive and S Position mode.

Used for:

**Drive**

- Normal driving (gears change between 1st and 10th automatically)
- Temporarily driving in the sequential mode

**S Position**

- Automatically changing gears between 1st and 8th (8th gear is used only at high speed)
- Driving in the sequential mode

### ▶▶ Shifting

## ⚠ WARNING

The vehicle can roll away if left unattended without confirming that Park is engaged.

A vehicle that rolls away could cause a crash resulting in serious injury or death.

Always keep your foot on the brake pedal until you have confirmed that **P** is shown on the gear position indicator.

To prevent malfunction and unintended engagement:

- Do not spill any liquids on or around shift buttons.
- Do not place or drop any objects on or around shift buttons.
- Do not let passengers or children operate the shift buttons.

The beeper sounds and the message appears on the multi-information display when you depress the accelerator pedal with the gear position in **N**. Change the gear position to **D** or **R** with the brake pedal depressed.

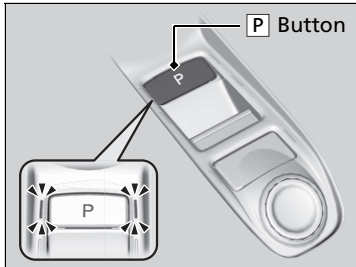
**■ P (parking) button**

Park your vehicle in a safe place with the power mode in ON, then apply the brakes and press the **P** button to put the transmission in Park.

The indicators on the sides of the **P** button come on.

## ■ Shift Operation

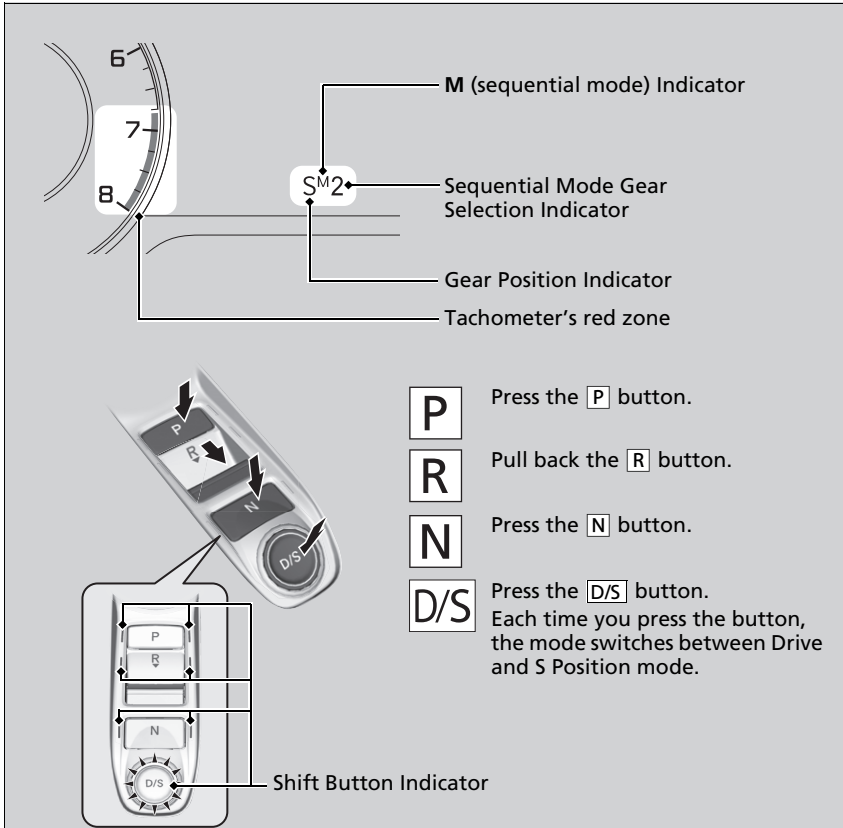

## ▶ Shift Operation

### NOTICE

When you change **D** to **R** and vice versa, come to a complete stop and keep the brake pedal depressed. Operating the shift button before the vehicle has come to a complete standstill can damage the transmission.

Use the gear position indicator and the shift button indicator to check the gear position before selecting a shift button.

If the indicator of the currently selected gear position, or all the gear position indicators are blinking simultaneously, there is a problem with the transmission.

Avoid sudden acceleration and have the transmission checked by a dealer as soon as possible.

The fuel supply may be cut off if you drive at engine speeds in or over the tachometer's red zone (engine speed limit). If this happens, you may experience a slight jolt.

When the engine speed is increased while the transmission is in **N**, **P** or **R**, the fuel supply may be cut off even without the engine speed entering the tachometer's red zone.

When shifting gears in extremely low temperatures (−22°F/−30°C), there may be a short delay before the shift is indicated in the display. Always confirm you are in the correct gear before driving.



### ■ When opening the driver's door

If you open the driver's door under the following conditions, the gear position automatically changes to **P**.

- The vehicle is stationary with the engine running, or moving at 1 mph (2 km/h) or slower.
  - The transmission is in other than **P**.
  - You have unfastened the driver side seat belt.
- ▶ If you manually change the gear position from **P** with the brake pedal depressed, the gear position will automatically return to **P** once you release the brake pedal.

### ■ When turning off the power mode

If you turn the engine off while the vehicle is stationary, and the transmission is in other than **P**, the gear position automatically changes to **P**.

#### ▶ Shift Operation

The beeper sounds once when you change to **R**.

▶ **Customized Features** P. 300

#### ▶ When opening the driver's door

While the system is designed to automatically change the gear position to **P** under the described conditions, in the interest of safety you should always select **P** before opening the driver's door. Make sure to park the vehicle in a safe place.

▶ **When Stopped** P. 492

If you want to drive the vehicle after the gear position has automatically changed to **P** under the described conditions, close the door, fasten the seat belt, depress the brake pedal, then change the gear position.

If you leave the vehicle, turn off the engine and lock the doors.

■ **If you want to keep the transmission in **N** position [car wash mode]**

With the engine running:

1. Press and hold the brake pedal.
2. Select **N**, then release the button to display **N** (Neutral) hold mode on the multi-information display.
3. Press and hold **N** again for two seconds.
  - ▶ This puts the vehicle in car wash mode which must be used when your vehicle is pulled through a conveyor type automatic car wash where you or an attendant do not remain in the vehicle.

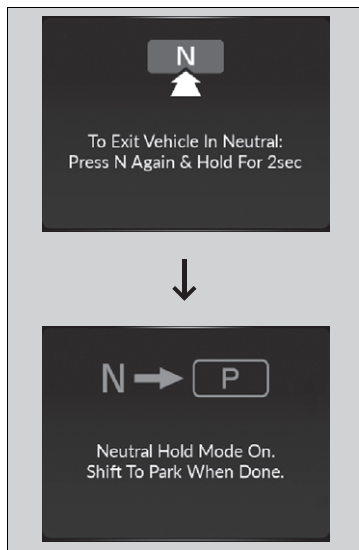

If the **ENGINE START/STOP** button is pressed after car wash mode has been activated, the power mode will change to ACCESSORY and a message will be displayed on the multi-information display.

- ▶ The gear position remains in **N** with the power mode in ACCESSORY for 15 minutes, then, it automatically changes to **P** and the power mode changes to OFF.
- ▶ Manually changing to **P** cancels ACCESSORY mode. The **P** indicator comes on and the power mode changes to OFF. You must always shift to **P** when car wash mode is no longer needed.

⌘ If you want to keep the transmission in **N** position [car wash mode]

The transmission may not stay in **N** position while the following indicators are on or when the message below appears:

- Malfunction indicator lamp
- Transmission system indicator
- Charging system indicator
- The **12 Volt Battery Charging System Problem. Do Not Drive.** message on the multi-information display.

**■ Restrictions on selecting a gear position**

You cannot select a gear position under certain circumstances that may lead to a crash.

When the transmission is in:	1. Under these circumstances:	2. If you try to change to the following:	3. The gear position remains in/changes to:	How to change the gear position
<b>P</b>	The brake pedal is not depressed.	Other gear position	<b>P</b>	Release the accelerator pedal and depress the brake pedal.
	The accelerator pedal is depressed.			
<b>N</b>	The vehicle is moving at low speed without the brake pedal depressed.		<b>N</b>	
	The vehicle is moving at low speed with the accelerator pedal depressed.			
<b>N, D or S</b>	The vehicle is moving forward.		<b>R</b>	
<b>R or N</b>	The vehicle is moving backward.	<b>D, S</b>		
<b>R, N, D or S</b>	The vehicle is moving.	<b>P</b>		

## ■ Sequential Mode

Use the paddle shifters to change between 1st and 10th gears without releasing your hands from the steering wheel. The transmission will switch to the sequential mode.

### ■ When the transmission is in **[D]**:

The vehicle will go into the sequential mode momentarily, and the sequential mode gear selection indicator will come on.

When the vehicle goes into the sequential mode by **[−]** paddle shifter and the lower gear is available, the transmission properly selects single or double gear change.

Once you start traveling at a constant speed, the sequential mode will automatically switch off, and the sequential mode gear selection indicator will go off.

Hold the **[+]** paddle shifter for two seconds or push the **[D/S]** button to return to normal drive.

### ■ When the transmission is in **[S]**:

The vehicle will go into the sequential mode, and the **M** (sequential mode) indicator and sequential mode gear selection indicator will come on.

If the vehicle speed increases and the engine speed reaches near the tachometer's red zone, the transmission automatically shifts up to the next gear.

- You can cancel this mode by holding the **[+]** paddle shifter for two seconds or push the **[D/S]** button.
- You can cancel this mode by turning the **Dynamic Mode** switch to select any other dynamic mode (**COMFORT**, **NORMAL**, **SPORT**) or push the **[D/S]** button to return to Drive mode.

When the sequential mode is canceled, the sequential mode indicator and sequential mode gear selection indicator turn off.

## Sequential Mode Operation

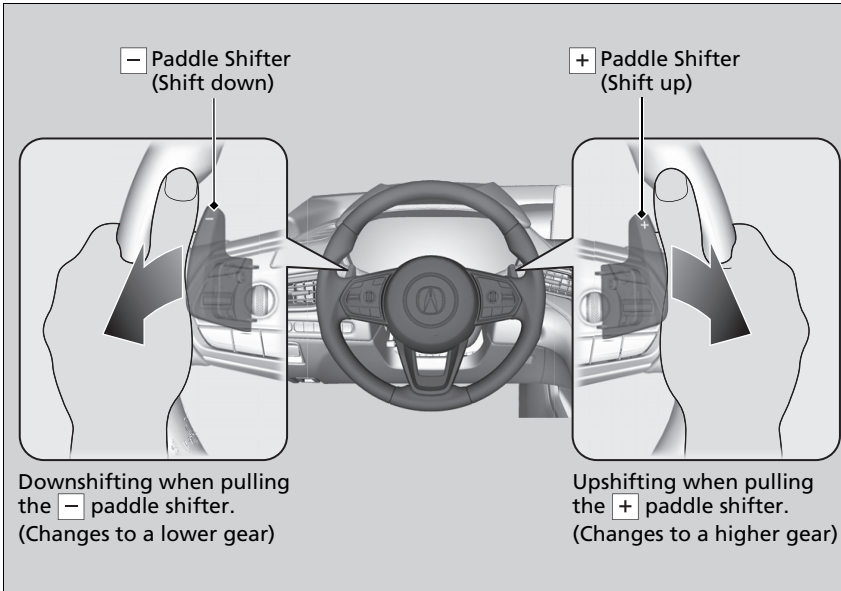

### Sequential Mode Operation

Each paddle shift operation makes a single or double gear change.  
To change gears continuously, release the paddle shifter before pulling it again for the next gear.

If the sequential mode gear selection indicator blinks when you try to shift up or down, this means your vehicle speed is not in its allowable gear range or the protection of transmission system is necessary. Slightly accelerate to shift up and decelerate to shift down while the indicator is blinking.

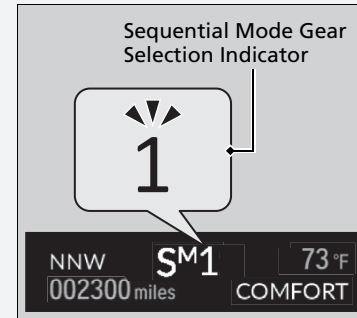

When the transmission is in **S** and **SPORT** or **INDIVIDUAL** mode, to prioritize the engine performance enhancement, the transmission may not allow for shifting up while the engine speed is low.

## Integrated Dynamics System

Modifies the dynamic character of the vehicle. There are four modes to select from:

**COMFORT**, **NORMAL**, **SPORT**, and **INDIVIDUAL**.

Turn the **Dynamic Mode** switch to select **COMFORT**, **NORMAL** or **SPORT**. Press the **(A)** button to select **INDIVIDUAL**. The mode you have selected appears on the audio/information screen.

### Integrated Dynamics System

The mode may not be able to be change when:

- The vehicle is turning
- The VSA® system is activating
- There is a problem with the engine, transmission, the brake system, the VSA®, the EPS, the Active Damper System\*, and the SH-AWD®\*



Dynamic Mode Change  
Unavailable

## Selecting the Dynamic Mode

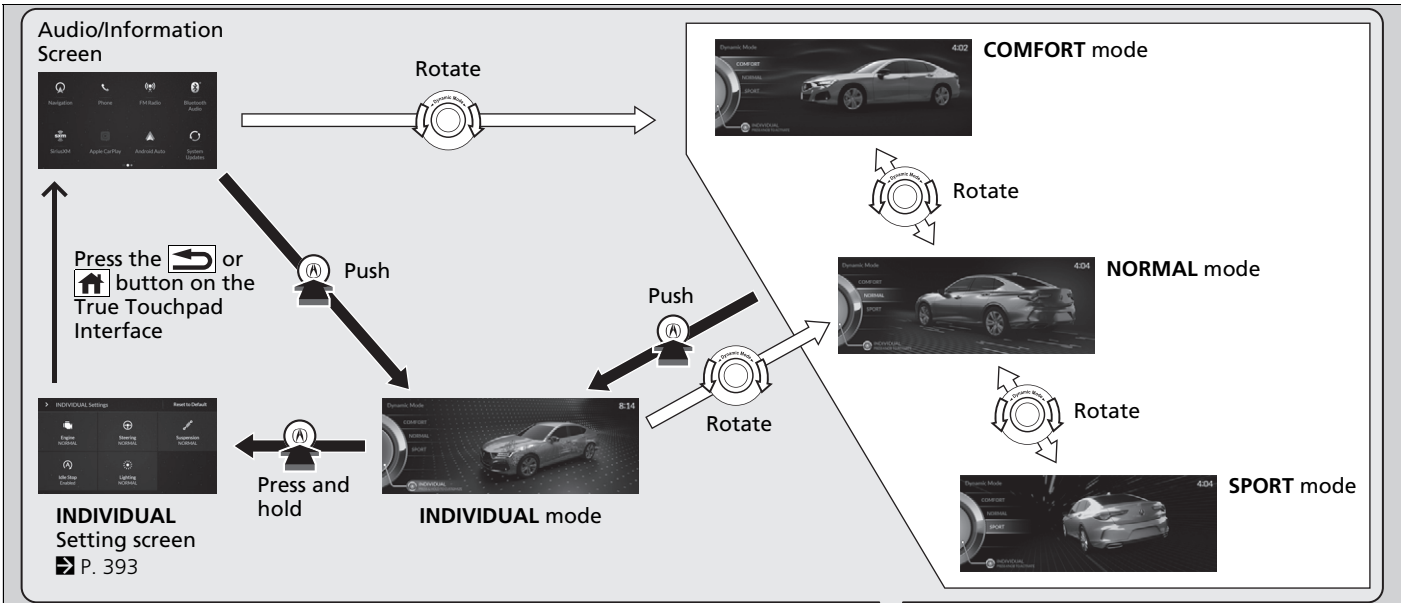

Changing modes alters the screen on the multi-information display. Currently selected mode is displayed in the right bottom.

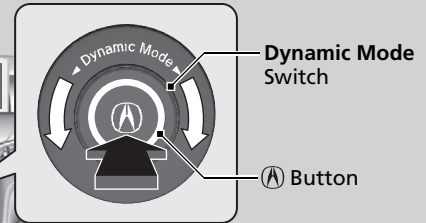
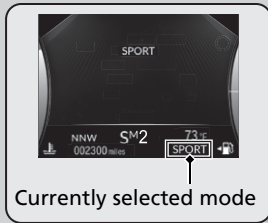

■ **Mode descriptions**

Each mode has been crafted for different driving styles according to the following chart.

Mode	Function	Accent Light Color* <sup>1</sup>
<b>COMFORT</b>	Maximizes driver comfort through decreased steering effort and reduced ride firmness (if Active Damper System is equipped)	Blue
<b>NORMAL</b>	Balanced response for everyday use	White
<b>SPORT</b>	Enhances vehicle response through increased steering effort, heightened throttle response, modified active sound control, and more responsive ride and/or handling (if Active Damper System and/or SH-AWD is equipped) When in <b>SPORT</b> , the Auto Idle Stop System will stay disabled regardless of the Auto Idle Stop <b>OFF</b> button ➤ <b>Auto Idle Stop</b> P. 395	Red
<b>INDIVIDUAL</b>	Each category can be customized separately to suit the driver's preference ➤ <b>Customizing the INDIVIDUAL Settings</b> P. 393	Blue, white, or red ➤ <b>Customizing the INDIVIDUAL Settings</b> P. 393

\*1: Interior accent light only available if equipped. Interior accent light changes with **Dynamic Mode** only when **Accent Light Theme** is set to **Dynamic Mode**.

➤ **Customized Features** P. 300

➤ **Lighting area of the accent light** P. 392



■ **Next start-up mode**

The mode for the next start-up is saved according to the following chart. Each keyless access remote has it's own mode saved.

Last Dynamic Mode	Next Dynamic Mode	Welcome Accent Light Color* <sup>1</sup>
<b>COMFORT</b>	<b>COMFORT</b>	Blue
<b>NORMAL</b> or <b>SPORT</b>	<b>NORMAL</b>	White
<b>INDIVIDUAL</b> (via <b>COMFORT</b> )	<b>COMFORT</b>	Blue
<b>INDIVIDUAL</b> (via <b>NORMAL</b> or <b>SPORT</b> )	<b>NORMAL</b>	White

\*1: Interior accent light only available if equipped. Interior accent light changes with **Dynamic Mode** only when **Accent Light Theme** is set to **Dynamic Mode**.

📄 **Customized Features** P. 300

### ■ Lighting area of the accent light

Interior accent light only available if equipped. Interior accent light changes with **Dynamic Mode** only when **Accent Light Theme** is set to **Dynamic Mode**.

🔗 Customized Features P. 300

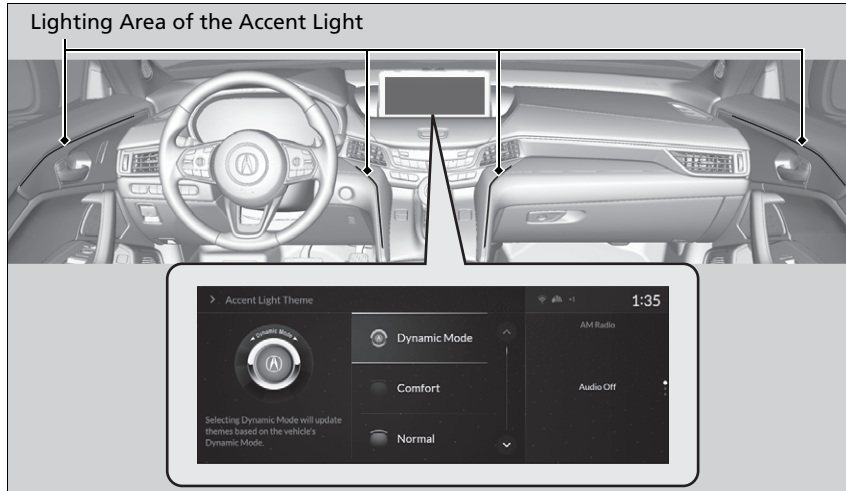

## ■ Customizing the INDIVIDUAL Settings

You can customize the **INDIVIDUAL** settings linked to your current keyless access remote. Each keyless access remote has its own settings.

1. Push and hold the (A) button to enter **INDIVIDUAL** mode and open the **INDIVIDUAL** settings.

➤ **Selecting the Dynamic Mode** P. 389

2. Drag to highlight the setting category icon and click the A-zone touchpad to display the setting screen.

3. Drag to highlight the desired setting and click the A-zone touchpad to change the setting.

▶ Press the (←) button to return to **INDIVIDUAL** settings screen.

▶ Press the (↑) button to return to the audio/information screen.

➤ **True Touchpad Interface** P. 209

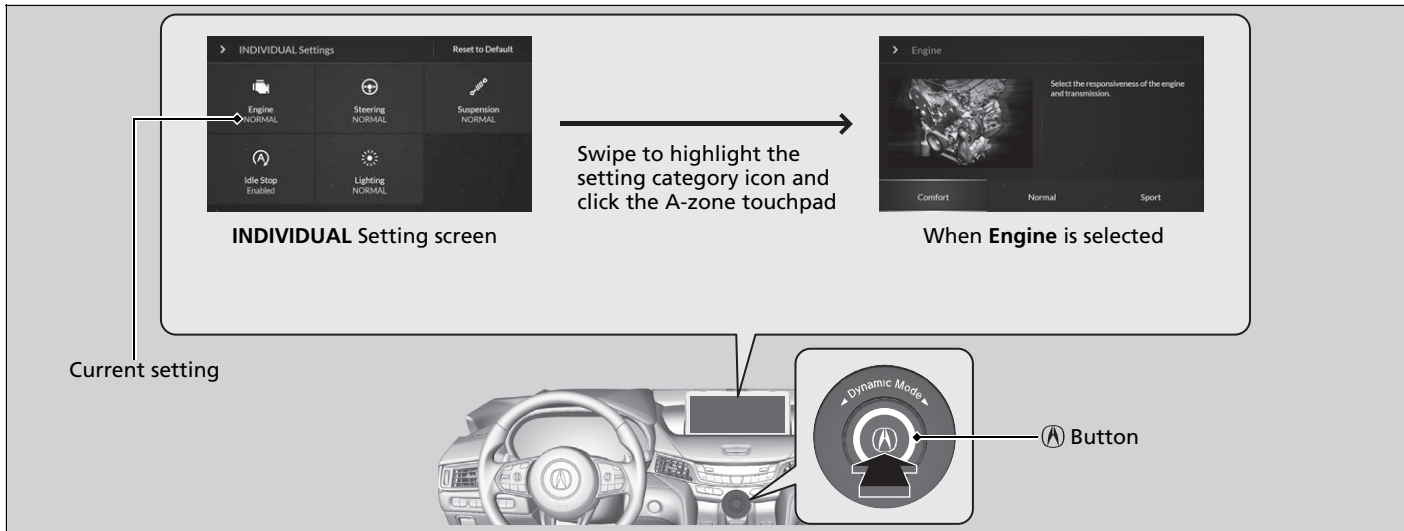

Category	Description
<b>Engine</b>	Select <b>COMFORT</b> , <b>NORMAL</b> , or <b>SPORT</b> for the engine throttle response and transmission shift response
<b>Steering</b>	Select <b>COMFORT</b> , <b>NORMAL</b> , or <b>SPORT</b> for the steering effort
<b>Suspension</b>	Select <b>COMFORT</b> , <b>NORMAL</b> , or <b>SPORT</b> for ride and/or handling: <ul style="list-style-type: none"> <li>• The suspension stiffness with the Active Damper System (if equipped)</li> <li>• The power distribution to the wheels with SH-AWD (if equipped)</li> </ul>
<b>Idle Stop</b>	Set the Auto Idle Stop system to <b>Enabled</b> or <b>Disabled</b> . While <b>Idle Stop</b> is <b>Disabled</b> in <b>INDIVIDUAL</b> mode, the Auto Idle Stop System will stay disabled regardless of the Auto Idle Stop <b>OFF</b> button  <b>Auto Idle Stop</b> P. 395
<b>Lighting</b> <sup>*1</sup>	Set the interior accent lighting. <b>COMFORT</b> for blue, <b>NORMAL</b> for white, and <b>SPORT</b> for red
<b>Reset to Default</b>	<b>Engine</b> , <b>Steering</b> , <b>Suspension</b> and <b>Lighting</b> is set to <b>Normal</b> , and <b>Idle Stop</b> is set to <b>Enabled</b>

\*1:Interior accent light only available if equipped. Interior accent light changes with **Dynamic Mode** only when **Accent Light Theme** is set to **Dynamic Mode**.

 **Customized Features** P. 300

 **Lighting area of the accent light** P. 392

## Auto Idle Stop

To help maximize fuel economy, the engine automatically stops when the vehicle comes to a stop, depending on environmental and vehicle operating conditions. The indicator (green) comes on at this time.

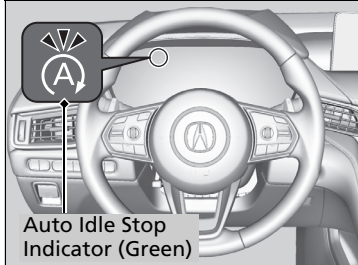

The environmental and vehicle conditions that impact Auto Idle Stop system operation are varied.

➤ **Auto Idle Stop Activates When:** P. 398, 399

The engine then restarts once the vehicle is about to move again, and the indicator (green) goes off.

➤ **The Engine Automatically Restarts When:**  
P. 400

### Auto Idle Stop

The 12-volt battery installed in this vehicle is specifically designed for a model with Auto Idle Stop. Using a 12-volt battery other than this specified type may shorten the 12-volt battery life, and prevent Auto Idle Stop from activating. If you need to replace the 12-volt battery, make sure to select the specified type. Ask a dealer for more details.

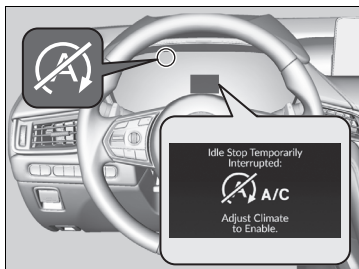

If the Auto Idle Stop function does not activate, the indicator comes on and a message appears on the multi-information display.

➤ **Indicators** P. 78

If the driver's door is opened while the indicator (green) comes on, a buzzer sounds to notify you that the Auto Idle Stop function is in operation.

A message associated with Auto Idle Stop appears on the multi-information display.

➤ **Auto Idle Stop System ON/OFF** P. 397

## Auto Idle Stop System ON/OFF

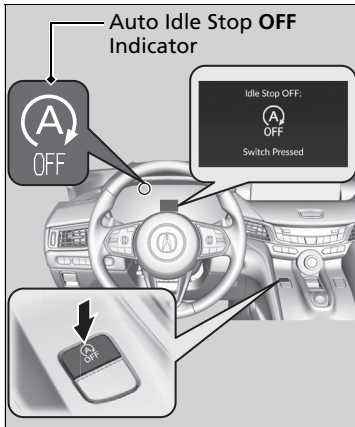

To turn the Auto Idle Stop system off, press this button. The Auto Idle Stop system stops.

- ▶ Auto Idle Stop system will stop, the indicator (white) will come on and a message appears on the multi-information display.

The Auto Idle Stop system is turned on every time you start the engine, even if you turned it off the last time you drove the vehicle.

### Auto Idle Stop System ON/OFF

If you turn off the Auto Idle Stop system while it is activated, the engine will restart.

If you press and hold the Auto Idle Stop **OFF** button, you can disable idle stop messages.

➤ **Auto Idle Stop Activates When:** P. 398

## ■ Auto Idle Stop Activates When:

The vehicle stops with the gear position in **D** and the brake pedal depressed. When you put the transmission into **P**, the Auto Idle Stop continues to operate, even if the brake pedal is released.

▶ If you depress the brake pedal, the engine may automatically restart.

## ■ Auto Idle Stop does not activate when:

- The Auto Idle Stop **OFF** button is pressed.
- The driver's seat belt is not fastened.
- The engine coolant temperature is low or high.
- The transmission fluid temperature is low or high.
- The vehicle comes to a stop again before the vehicle speed reaches 3 mph (5 km/h) after the engine starts.
- Stopped on a steep incline.
- The transmission is in a position other than **D**.
- The engine is started with the hood open.
  - ▶ Turn off the engine. Close the hood before you restart the engine to activate Auto Idle Stop.
- The battery charge is low.
- The internal temperature of the battery is 14°F (–10°C) or less.
- The climate control system is in use, and the outside temperature is below –4°F (–20°C) or over 104°F (40°C).
- The climate control system is in use, and the temperature is set to **Hi** or **Lo**.
-  is ON (indicator on).
- The Integrated Dynamics System mode is changed to **SPORT** mode.
- The Auto Idle Stop is set to off on **INDIVIDUAL** Setting screen.

▶ **Customizing the INDIVIDUAL Settings** P. 393

## ▶ Auto Idle Stop Activates When:

Do not open the hood while the Auto Idle Stop function is activated. If the hood is opened, the engine will not restart automatically.

In this case, restart the engine with the **ENGINE START/STOP** button.

▶ **Starting the Engine** P. 372

Pressing the **ENGINE START/STOP** button causes the engine to no longer restart automatically. Follow the standard procedure to start the engine.

▶ **Starting the Engine** P. 372

When ACC with Low Speed Follow is in operation, the vehicle stops without depressing the brake pedal and Auto Idle Stop may activate.



**■ Auto Idle Stop may not activate when:**

- The vehicle is stopped by braking suddenly.
- The steering wheel is operated.
- Altitude is high.
- The climate control system is in use, and there is a significant difference between the set temperature and the actual interior temperature.
- The climate control system is in use, and humidity in the interior is high.

### ■ The Engine Automatically Restarts When:

- The brake pedal is released (without the automatic brake hold system activated).
- The accelerator pedal is depressed (with the automatic brake hold system activated).

🔘 **Automatic Brake Hold** P. 488

### 🔘 The Engine Automatically Restarts When:

If you are using an electronic device during Auto Idle Stop, the device may temporarily be turned off when the engine restarts.

### ■ The engine restarts even if the brake pedal is depressed\*1 when:

- The Auto Idle Stop **OFF** button is pressed.
- The steering wheel is operated.
- The transmission is put into **R** or **S**, or taken out of **N** and put into **D**.
  - ▶ If you put the transmission into **P** after the Auto Idle Stop activates, the Auto Idle Stop continues to operate. In this case, the engine restarts when you depress the brake pedal.
- The pressure on the brake pedal is reduced and the vehicle starts moving while stopped on an incline.
- The pressure on the brake pedal is repeatedly applied and released slightly during a stop.
- The battery charge becomes low.
- The accelerator pedal is depressed.
- The driver's seat belt is unlatched.
-  is ON (indicator on).
- The climate control system is in use, and the difference between the set temperature and actual interior temperature becomes significant.
- The climate control system is being used to dehumidify the interior.
- The Integrated Dynamics System mode is changed to **SPORT** mode.
- The Auto Idle Stop is set to off on **INDIVIDUAL** Setting screen.
  - ▶ **Customizing the INDIVIDUAL Settings** P. 393
- The vehicle ahead of you starts again when your vehicle stops automatically with ACC with Low Speed Follow.

### ■ Starting Assist Brake Function

Briefly keeps the brake applied after releasing the brake pedal to restart the engine. This can keep your vehicle from unexpectedly moving while on an incline.

▶▶ The engine restarts even if the brake pedal is depressed\*1 when:

\*1: With the automatic brake hold system activated, you can release the brake pedal while Auto Idle Stop is in operation.

If the automatic brake hold system has been turned off, or if there is a problem with the system, the engine will restart automatically when you release the brake pedal.

▶ **Automatic Brake Hold** P. 488

## Vehicle Stability Assist™ (VSA®), aka Electronic Stability Control (ESC), System

VSA® helps to stabilize the vehicle during cornering if the vehicle turns more or less than what was intended. It also assists in maintaining traction on slippery surfaces. It does so by regulating engine output and selectively applying the brakes.

### ■ VSA® Operation

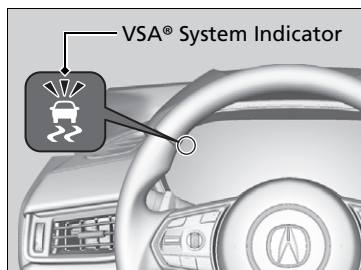

When VSA® activates, you may notice that the engine does not respond to the accelerator. You may also notice some noise from the hydraulic brake system. You will also see the indicator blink.

### ▣ Vehicle Stability Assist™ (VSA®), aka Electronic Stability Control (ESC), System

The VSA® may not function properly if tire type and size are mixed. Make sure to use the same size and type of tire, and the air pressures as specified.

When the VSA® system indicator comes on and stays on while driving, there may be a problem with the system. While this may not interfere with normal driving, have your vehicle checked by a dealer immediately.

VSA® cannot enhance stability in all driving situations and does not control the entire braking system. You still need to drive and corner at speeds appropriate for the conditions and always leave a sufficient margin of safety.

The main function of the VSA® system is generally known as Electronic Stability Control (ESC). The system also includes a traction control function.

The vehicle stability assist™ (VSA®) system, vehicle stability assist™ (VSA®) OFF, adaptive cruise control (ACC) with low speed follow, and safety support indicators may come on in amber along with a message in the multi-information display when you set the power mode to ON after reconnecting a battery.

Drive a short distance at more than 12 mph (20 km/h).

Each indicator should go off. If any do not, have your vehicle checked by a dealer.

## VSA® On and Off

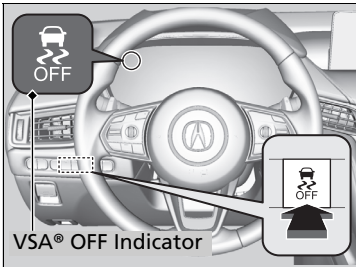

This button is on the driver side control panel. To partially disable VSA® functionality/features, press and hold it until you hear a beep.

Your vehicle will have normal braking and cornering ability, but traction control function will be less effective.

To restore VSA® functionality/features, press the  (VSA® OFF) button until you hear a beep.

VSA® is turned on every time you start the engine, even if you turned it off the last time you drove the vehicle.

## Vehicle Stability Assist™ (VSA®), aka Electronic Stability Control (ESC), System

In certain unusual conditions when your vehicle gets stuck in shallow mud or fresh snow, it may be easier to free it with the VSA® temporarily switched off.

When the  button is pressed, the traction control function becomes less effective. This allows for the wheels to spin more freely at low speed. You should only attempt to free your vehicle with the VSA® off if you are not able to free it when the VSA® is on.

Immediately after freeing your vehicle, be sure to switch VSA® on again. We do not recommend driving your vehicle with the VSA® system switched off.

You may hear a motor sound coming from the engine compartment while system checks are being performed immediately after starting the engine or while driving. This is normal.

## Agile Handling Assist

---

Lightly brakes each of the front and rear wheels, as needed, when you turn the steering wheel, and helps support the vehicle's stability and performance during cornering.

### ⚡ Agile Handling Assist

The agile handling assist cannot enhance stability in all driving situations. You still need to drive and corner at speeds appropriate for the conditions and always leave a sufficient margin of safety.

When the VSA® system indicator comes on and stays on while driving, the agile handling assist does not activate.

You may hear a sound coming from the engine compartment while the agile handling assist is activated. This is normal.

## Super Handling-All Wheel Drive™ (SH-AWD®)\*

The system controls and transfers varying amounts of engine torque to each wheel in accordance with the driving conditions.

SH-AWD® helps to enhance driving stability, and lets you handle situations like slippery surfaces, such as on wet, icy, or snowy roads, better than when driving with two wheel drive. However, the system does not help to enhance braking. Be precautious about the following:

- It is still your responsibility to drive safely when you steer, accelerate, and apply brakes.
- Leave a sufficient margin when braking on slippery surfaces.

### Super Handling-All Wheel Drive™ (SH-AWD®)\*

The SH-AWD® system may not function properly if tire type and size are mixed. Make sure to use the same size and type of tire, and the air pressures as specified.

#### 🔧 Tire and Wheel Replacement P. 550

Do not continuously spin the front tires of your vehicle. Continuously spinning the front tires can cause damage to the transmission and SH-AWD® unit.

If the **SH-AWD** indicator blinks while driving, it indicates the differential temperature is too high. If this happens, pull to the side of the road when it is safe, change the gear position to **[P]**, and idle the engine until the indicator goes out.

\* Not available on all models

## Tire Pressure Monitoring System (TPMS) with Tire Fill Assist

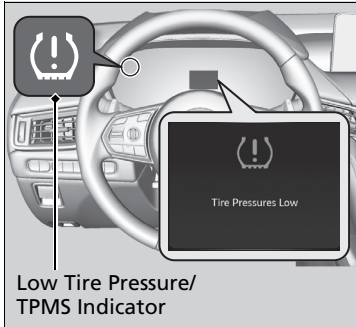

Monitors the tire pressure while you are driving. If your vehicle's tire pressure becomes significantly low, the low tire pressure/TPMS indicator comes on and a message appears on the multi-information display.

### ▶▶ Tire Pressure Monitoring System (TPMS) with Tire Fill Assist

Conditions such as low ambient temperature and altitude change directly affect tire pressure and can trigger the low tire pressure/TPMS indicator to come on.

#### ▶ If the Low Tire Pressure/TPMS Indicator Comes On or Blinks P. 603

Tire pressure checked and inflated in:

- Warm weather can become under-inflated in colder weather.
- Cold weather can become over-inflated in warmer weather.

The low tire pressure/TPMS indicator will not come on as a result of over inflation.

The TPMS audibly and visually informs you of changes in tire pressure of the individual tire that you are adjusting using audible and visual indications.

If a change in tire pressure has been significant, the system beeps and the hazard lights flash continuously for five seconds when the specified tire pressure is reached. Stop filling the tire.



## ■ Tire Pressure Monitor



To select the tire pressure monitor, set the power mode to ON, and roll the right selector wheel until you see the tire pressure screen.

The pressure for each tire is displayed in PSI.

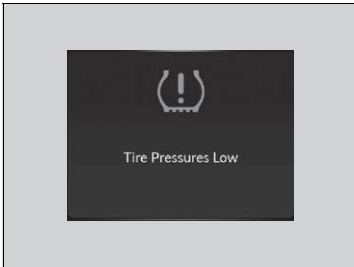

**Tire Pressures Low** is displayed when a tire has significantly low pressure. The specific tire is displayed on the screen.

## ☒ Tire Pressure Monitor

The pressure displayed on the multi-information display can be slightly different from the actual pressure as measured by a gauge. If there is a significant difference between the two values, or if the low tire pressure/TPMS indicator and the message on the multi-information display do not go off after you have inflated the tire to the specified pressure, have the system checked by a dealer.

**Tire Pressure Monitor System Problem. Check Tire Pressure. See Your Dealer.** may appear if you drive with the compact spare tire\*, or there is a problem with the TPMS.

\* Not available on all models

## Tire Pressure Monitoring System (TPMS) - Required Federal Explanation

---

Each tire, including the spare (if provided), should be checked monthly when cold and inflated to the inflation pressure recommended by the vehicle manufacturer on the vehicle placard or tire inflation pressure label.

(If your vehicle has tires of a different size than the size indicated on the vehicle placard or tire inflation pressure label, you should determine the proper tire inflation pressure for those tires.)

As an added safety feature, your vehicle has been equipped with a tire pressure monitoring system (TPMS) that illuminates a low tire pressure telltale



when one or more of your tires is significantly under-inflated.

Accordingly, when the low tire pressure telltale illuminates, you should stop and check your tires as soon as possible, and inflate them to the proper pressure.

Driving on a significantly under-inflated tire causes the tire to overheat and can lead to tire failure. Under-inflation also reduces fuel efficiency and tire tread life, and may affect the vehicle's handling and stopping ability.

Please note that the TPMS is not a substitute for proper tire maintenance, and it is the driver's responsibility to maintain correct tire pressure, even if under-inflation has not reached the level to trigger illumination of the TPMS low tire pressure telltale.

Your vehicle has also been equipped with a TPMS malfunction indicator to indicate when the system is not operating properly. The TPMS malfunction indicator is combined with the low tire pressure telltale. When the system detects a malfunction, the telltale will flash for approximately one minute and then remain continuously illuminated. This sequence will continue upon subsequent vehicle start-ups as long as the malfunction exists.

When the malfunction indicator is illuminated, the system may not be able to detect or signal low tire pressure as intended.

TPMS malfunctions may occur for a variety of reasons, including the installation of replacement or alternate tires or wheels on the vehicle that prevent the TPMS from functioning properly.

Always check the TPMS malfunction telltale after replacing one or more tires or wheels on your vehicle to ensure that the replacement or alternate tires and wheels allow the TPMS to continue to function properly.

## Blind spot information System\*

Is designed to detect vehicles in specified alert zones adjacent to your vehicle, particularly in harder to see areas commonly known as “blind spots.”

When the system detects vehicles approaching from behind in adjacent lanes, the appropriate indicator comes on for a few seconds, providing assistance when you change lanes.

### ■ How the system works

- The transmission is in **D** or **S**.

- Your vehicle speed is between 20 mph (32 km/h) and 100 mph (160 km/h)

#### Alert zone range

- A: Approx. 1.6 ft. (0.5 m)
- B: Approx. 10 ft. (3 m)
- C: Approx. 10 ft. (3 m)

Radar Sensors:  
underneath the  
rear bumper  
corners

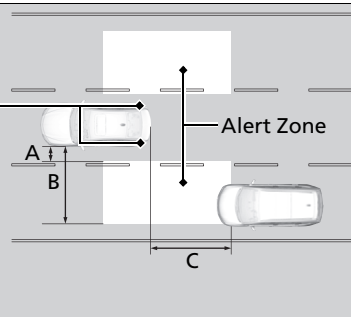

### ▶▶ Blind spot information System\*

## ⚠ WARNING

Failure to visually confirm that it is safe to change lanes before doing so may result in a crash and serious injury or death. Do not rely only on the blind spot information system when changing lanes.

Always look in your mirrors, to either side of your vehicle, and behind you for other vehicles before changing lanes.

### Important Safety Reminder

Like all assistance systems, blind spot information system has limitations. Over reliance on blind spot information system may result in a collision.

The blind spot information system alert indicator may not come on under the following conditions:

- A vehicle does not stay in the alert zone for more than two seconds.
- A vehicle is parked in a side lane.
- The speed difference between your vehicle and the vehicle you are passing is greater than 6 mph (10 km/h).
- An object not detected by the radar sensors approaches or passes your vehicle.
- A vehicle running in the adjacent lane is a motorcycle or other small vehicle.

## ■ When the system detects a vehicle



Blind spot information System Alert Indicator:  
Located near the pillar on both sides.

### Comes on when:

- A vehicle enters the alert zone from behind to overtake you with a speed difference of no more than 31 mph (50 km/h) from your vehicle.
- You pass a vehicle with a speed difference of no more than 12 mph (20 km/h).

### Blinks and a beeper sounds when:

You move the turn signal lever in the direction of the detected vehicle. The beeper sounds three times.

### ▶▶ Blind spot information System\*

The system is for your convenience only. Even if an object is within the alert zone, the following situations may occur.

- The blind spot information system alert indicator may not come on due to obstruction (splashes, etc.) even without the **Blind Spot Information System Not Available** multi-information display appearing.
- The blind spot information system alert indicator may come on even with the message appearing.



You can change the setting for the blind spot information system.

▶ **Customized Features** P. 300

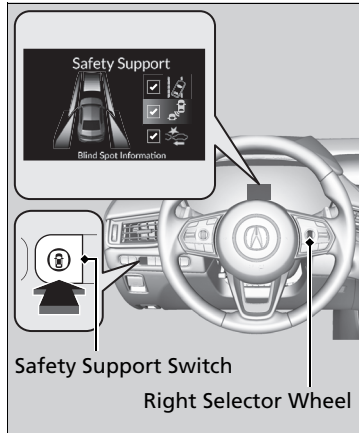
## ■ Blind spot information System On and Off



When you turn the blind spot information system on and off, do the following.

1. Press the safety support switch.
2. Roll the right selector wheel to the  symbol and push it.
  - ▶ The message appears on the multi-information display when the system becomes on or off.
  - ▶ A check mark appears in the box and the color of the  symbol changes green when the system is on. The check mark disappear and the color of the  symbol changes gray when the system is off.

The blind spot information system is in the previously selected on (checked) or off (unchecked) setting each time you start the engine.

## ▶▶ Blind spot information System\*

Blind spot information system may be adversely affected when:

- Objects (guard rails, poles, trees, etc..) are detected.
- An object that does not reflect radio waves well, such as a motorcycle, is in the alert zone.
- Driving on a curved road.
- A vehicle is moving from a far lane to the adjacent lane.
- The system picks up external electrical interference.
- The rear bumper or the sensors have been improperly repaired or the rear bumper has been deformed.
- The orientation of the sensors has been changed.
- In bad weather (Heavy rain, snow, and fog).
- Making a turn at an intersection.
- Driving on a bumpy road.
- Making a short turn that slightly tilts the vehicle.

For a proper blind spot information system operation:

- Always keep the rear bumper corner area clean.
- Do not cover the rear bumper corner area with labels or stickers of any kind.
- Take your vehicle to a dealer if you need the rear bumper corner area or the radar sensors to be repaired, or the rear bumper corner area is strongly impacted.

AcuraWatch™ is a driver support system which employs the use of two distinctly different kinds of sensors, a radar sensor located behind the emblem and a front sensor camera mounted to the interior side of the windshield, behind the rearview mirror.

AcuraWatch™ has following functions.

### ■ The functions which do not require switch operations to activate

- Collision Mitigation Braking System™ (CMBS™) ⓘ P. 417
- Road Departure Mitigation (RDM) System ⓘ P. 469
- Traffic Sign Recognition System ⓘ P. 474

### ■ The functions which require switch operations to activate

- Adaptive Cruise Control (ACC) with Low Speed Follow ⓘ P. 428
- Lane Keeping Assist System (LKAS) ⓘ P. 448
- Traffic Jam Assist ⓘ P. 457

## ■ Operation Switches for the ACC with Low Speed Follow/ LKAS/Traffic Jam Assist

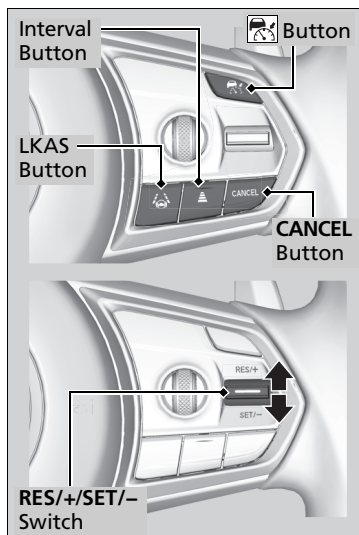

### ■ Button

Press to activate standby mode for ACC with Low Speed Follow and Traffic Jam Assist. Or press to cancel these systems.

### ■ LKAS Button

Press to activate standby mode for LKAS and Traffic Jam Assist. Or press to cancel these systems.

### ■ RES/+ / SET/- Switch

Press **RES/+** switch to resume the ACC with Low Speed Follow or increase the vehicle speed.

Press **SET/-** switch to set the ACC with Low Speed Follow or decrease the vehicle speed.

### ■ Interval Button

Press to change the ACC with Low Speed Follow following-interval.

### ■ CANCEL Button

Press to cancel ACC with Low Speed Follow.



## Multi-Information Display Content

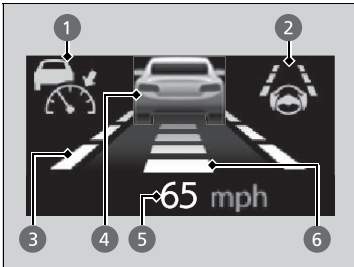

You can see the current state of ACC with Low Speed Follow, LKAS and Traffic Jam Assist.

When both of ❶ and ❷ indicates, Traffic Jam Assist is ready to be activated.

- ❶ Indicates that ACC with Low Speed Follow is ready to be activated.
  - Green: The system is on.
  - White: The system is standby.
  - Amber: There is a problem with the system.
- ❷ Indicates that LKAS is ready to be activated.
  - Green: The system is on.
  - White: The system is standby.
  - Amber: There is a problem with the system.
- ❸ Indicates that LKAS is activated and whether or not traffic lane lines are detected.
  - Solid line: The system is on.
  - Contour line: The system is in standby.
- ❹ Indicates whether or not ACC with Low Speed Follow detected the vehicle ahead.
- ❺ Shows vehicle set speed in ACC with Low Speed Follow.
- ❻ Shows set vehicle interval in ACC with Low Speed Follow.

### Models with Head-up display

You can have the head-up display show you the current state of each function.

📄 **Head-Up Display**\* P. 111

\* Not available on all models

*Continued*

## ■ How to Operate the Buttons on the Steering Wheel

To activate ACC with Low Speed Follow, LKAS, and Traffic Jam Assist, carry out the following steps:

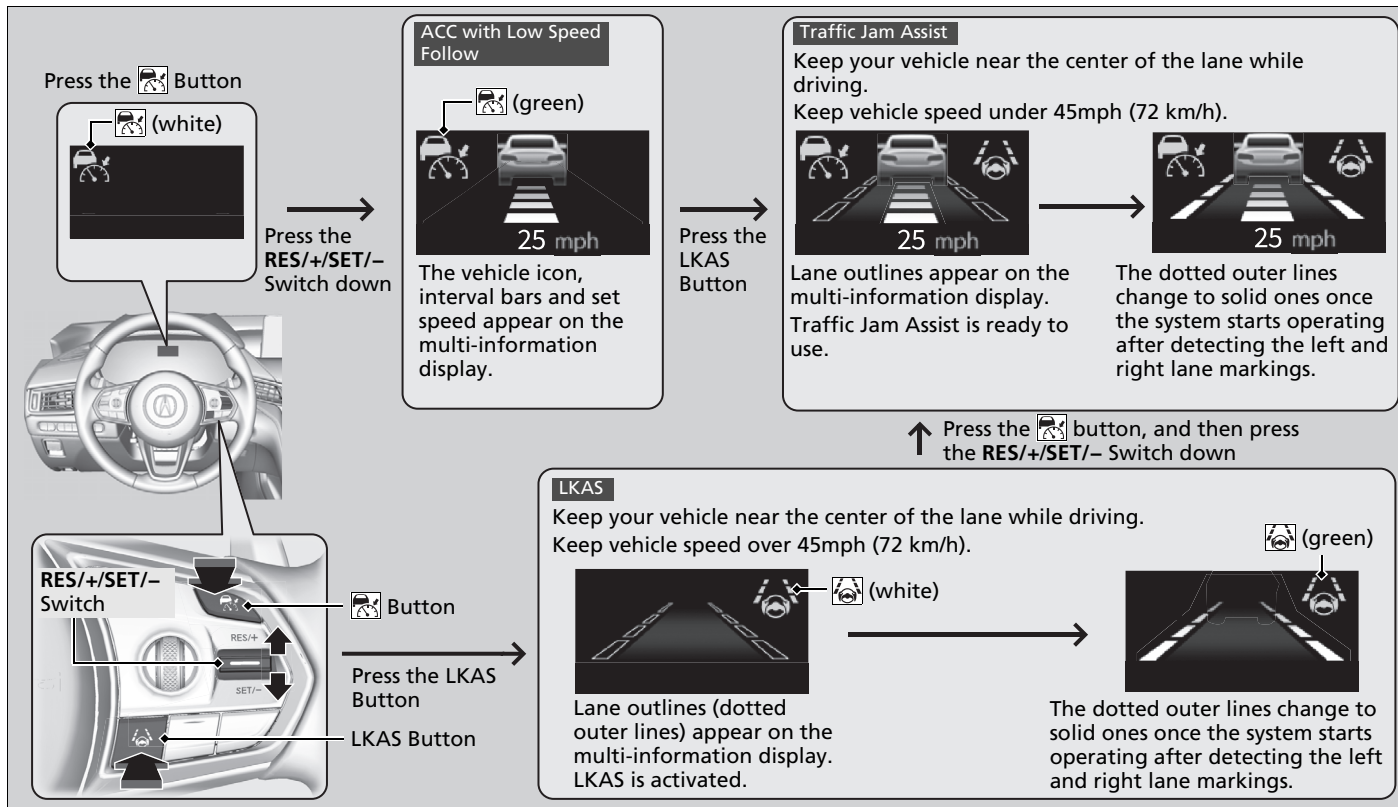

## Collision Mitigation Braking System™ (CMBS™)

Can assist you when there is a possibility of your vehicle colliding with a vehicle or a pedestrian detected in front of yours. The CMBS™ is designed to alert you when the potential for a collision is determined, as well as to reduce your vehicle speed to help minimize collision severity when a collision is deemed unavoidable.

### Collision Mitigation Braking System™ (CMBS™)

#### Important Safety Reminder

The CMBS™ is designed to reduce the severity of an unavoidable collision. It does not prevent collisions nor stop the vehicle automatically. It is still your responsibility to operate the brake pedal and steering wheel appropriately according to the driving conditions.

The CMBS™ may not activate or may not detect a vehicle in front of your vehicle under certain conditions:

➤ **CMBS™ Conditions and Limitations** P. 422

You can read about handling information for the camera equipped with this system.

➤ **Front Sensor Camera** P. 480

For directions on the proper handling of the radar sensor, refer to the following page.

➤ **Radar Sensor** P. 482

## ■ How the system works

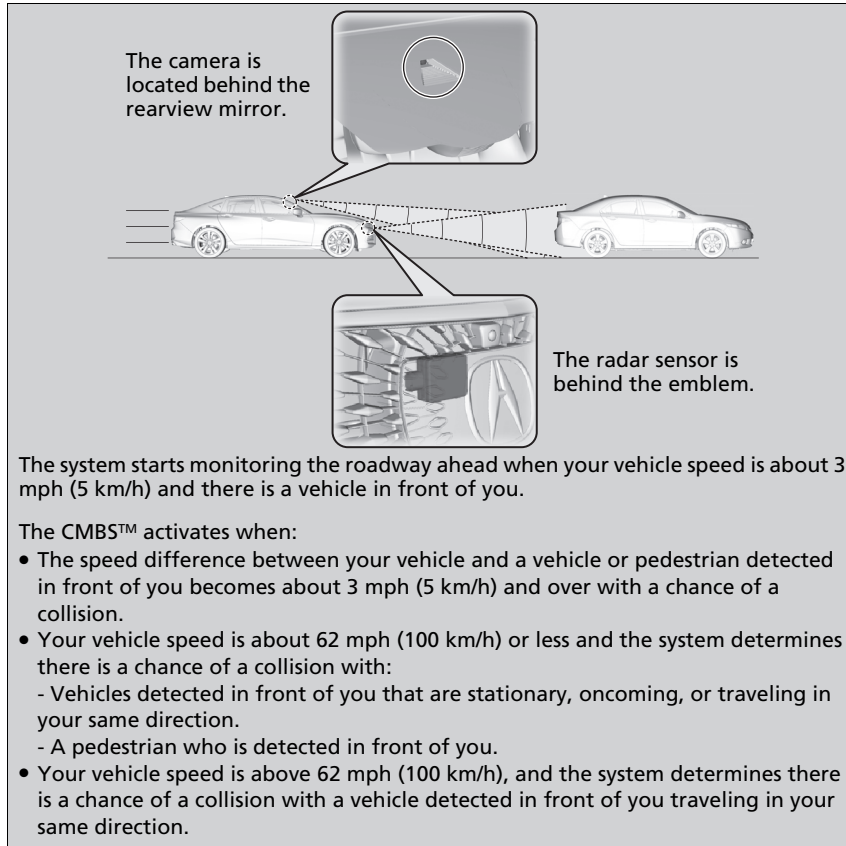

## ▣ How the system works

When the CMBS™ activates, it may automatically apply the brake. It will be canceled when your vehicle stops or a potential collision is not determined.

## ■ When the system activates

The system provides visual and audible alerts of a possible collision, and stops if the collision is avoided.

- ▶ Take appropriate action to prevent a collision (apply the brakes, change lanes, etc.)

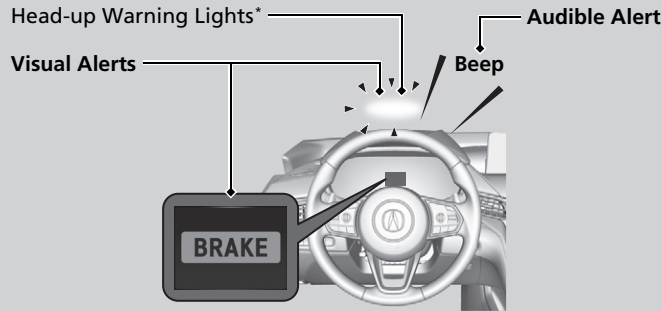

You can change the distance (**Long/Normal/Short**) between vehicles at which the system's earliest collision alert will come on through audio/information screen setting options.

- ▶ **Customized Features** P. 300

\* Not available on all models

Continued

## ▶▶ When the system activates

The camera in the CMBS™ is also designed to detect pedestrians.

However, this pedestrian detection feature may not activate or may not detect a pedestrian in front of your vehicle under certain conditions. Refer to the ones indicating the pedestrian detection limitations from the list.

- ▶ **CMBS™ Conditions and Limitations** P. 422

### Models with Head-up display

The head-up warning uses a lens located at the front end of the dashboard.

Do not cover the lens or spill any liquid on it.

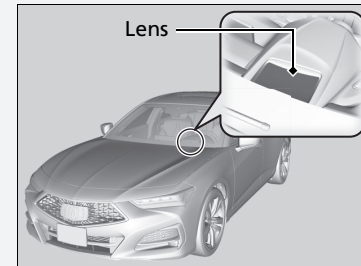

## ■ Collision Alert Stages

The system has three alert stages for a possible collision. However, depending on circumstances, the CMBS™ may not go through all of the stages before initiating the last stage.



Distance between vehicles		CMBS™		
		The radar sensor detects a vehicle	Audible & Visual WARNINGS	Braking
Stage one		There is a risk of a collision with the vehicle ahead of you.	When in <b>Long</b> , visual and audible alerts come on at a longer distance from a vehicle ahead than in <b>Normal</b> setting, and in <b>Short</b> , at a shorter distance than in <b>Normal</b> .	—
Stage two		The risk of a collision has increased, time to respond is reduced.	Visual and audible alerts.	Lightly applied
Stage three		The CMBS™ determines that a collision is unavoidable.		Forcefully applied

Driving

## CMBS™ On and Off



When you turn the CMBS™ on and off, do the following.

1. Press the safety support switch.
2. Roll the right selector wheel to the  symbol and push it.
  - ▶ The message appears on the multi-information display when the system becomes on or off.
  - ▶ A check mark appears in the box and the color of the  symbol changes green when the system is on. The check mark disappears and the color of the  symbol changes gray when the system is off.

The CMBS™ is turned on every time you start the engine, even if you turned it off the last time you drove the vehicle.

## Collision Mitigation Braking System™ (CMBS™)

The CMBS™ may automatically shut off, and the safety support indicator (amber) will come and stay on under certain conditions:

▶ **CMBS™ Conditions and Limitations** P. 422

When the CMBS™ is activated, it will continue to operate even if the accelerator pedal is partially depressed. However, it will be canceled if the accelerator pedal is deeply depressed.

The vehicle stability assist™ (VSA®) system, vehicle stability assist™ (VSA®) OFF, adaptive cruise control (ACC) with low speed follow, and safety support indicators may come on in amber along with a message in the multi-information display when you set the power mode to ON after reconnecting a battery. Drive a short distance at more than 12 mph (20 km/h). Each indicator should go off. If any do not, have your vehicle checked by a dealer.

Continued

## ■ CMBS™ Conditions and Limitations

The system may automatically shut off and the safety support indicator (amber) will come on under certain conditions. Some examples of these conditions are listed below. Other conditions may reduce some of the CMBS™ functions.

➤ **Front Sensor Camera** P. 480

➤ **Radar Sensor** P. 482

### ■ Environmental conditions

- Driving in bad weather (rain, fog, snow, etc.).
- Sudden changes between light and dark, such as an entrance or exit of a tunnel.
- There is little contrast between objects and the background.
- Driving into low sunlight (e.g., at dawn or dusk).
- Strong light is reflected onto the roadway.
- Driving in the shadows of trees, buildings, etc.
- Roadway objects or structures are misinterpreted as vehicles and pedestrians.
- Reflections on the interior of the windshield.
- Driving at night or in a dark condition such as a tunnel.

### ■ Roadway conditions

- Driving on a snowy or wet roadway (obscured lane marking, vehicle tracks, reflected lights, road spray, high contrast).
- Driving on curvy, winding, or undulating roads.
- The road is hilly or the vehicle is approaching the crest of a hill.

## ⊠ CMBS™ Conditions and Limitations

Have your vehicle checked by a dealer if you find any unusual behavior of the system (e.g., the warning message appears too frequently).



**■ Vehicle conditions**

- Headlight lenses are dirty or the headlights are not properly adjusted.
- The outside of the windshield is blocked by dirt, mud, leaves, wet snow, etc.
- The inside of the windshield is fogged.
- An abnormal tire or wheel condition (wrong sized, varied size or construction, improperly inflated, compact spare tire\*, etc.).
- When tire chains are installed.
- The vehicle is tilted due to a heavy load or suspension modifications.
- The camera temperature gets too high.
- Driving with the parking brake applied.
- When the radar sensor behind the emblem gets dirty.

\* Not available on all models

### ■ Detection limitations

- A vehicle or pedestrian suddenly crosses in front of you.
- The distance between your vehicle and the vehicle or pedestrian ahead of you is too short.
- A vehicle cuts in front of you at a slow speed, and it brakes suddenly.
- When you accelerate rapidly and approach the vehicle or pedestrian ahead of you at high speed.
- The vehicle ahead of you is a motorcycle, bicycle, mobility scooter or other small vehicle.
- When there are animals in front of your vehicle.
- When you drive on a curved, winding or undulating road that makes it difficult for the sensor to properly detect a vehicle in front of you.
- The speed difference between your vehicle and a vehicle in front of you is significantly large.
- An oncoming vehicle suddenly comes in front of you.
- Another vehicle suddenly comes in front of you at an intersection, etc.
- Your vehicle abruptly crosses over in front of an oncoming vehicle.
- When driving through a narrow iron bridge.
- When the lead vehicle suddenly slows down.

Limitations applicable to pedestrian detection only

- When there is a group of people in front of your vehicle walking together side by side.
- Surrounding conditions or belongings of the pedestrian alter the pedestrian's shape, preventing the system from recognizing that the person is a pedestrian.
- When the pedestrian is shorter than about 3.3 feet (1 meter) or taller than about 6.6 feet (2 meter) in height.
- When a pedestrian blends in with the background.
- When a pedestrian is bent over or squatting, or when their hands are raised or they are running.
- When several pedestrians are walking ahead in a group.
- When the camera cannot correctly identify that a pedestrian is present due to an unusual shape (holding luggage, body position, size).

### ■ Automatic shutoff

The CMBS™ may automatically shut itself off and the safety support indicator (amber) comes and stays on when:

- The temperature inside the system is high.
- You drive off-road or on a mountain road, or curved and winding road for an extended period.
- An abnormal tire condition is detected (wrong tire size, flat tire, etc.).
- The camera behind the rearview mirror, or the area around the camera, including the windshield, gets dirty.

Once the conditions that caused the CMBS™ to shut off improve or are addressed (e.g., cleaning), the system comes back on.

### ■ With Little Chance of a Collision

The CMBS™ may activate even when you are aware of a vehicle ahead of you, or when there is no vehicle ahead. Some examples of this are:

#### ■ When Passing

Your vehicle approaches another vehicle ahead of you and you change lanes to pass.

#### ■ At an intersection

Your vehicle approaches or passes another vehicle that is making a left or right turn.

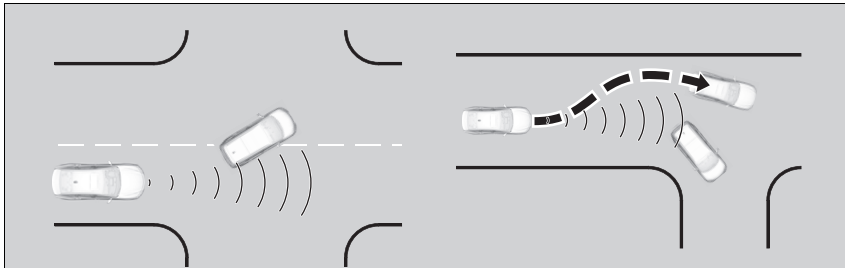

### ⚠ Collision Mitigation Braking System™ (CMBS™)

Do not paint, or apply any coverings or paint to radar sensor area. This can impact CMBS™ operation.

**■ On a curve**

When driving through curves, your vehicle comes to a point where an oncoming vehicle is right in front of you.

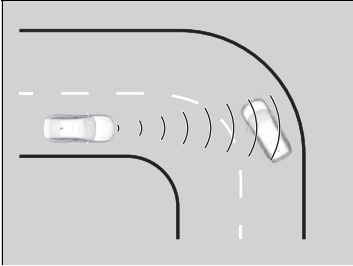
**■ Through a low bridge at high speed**

You drive under a low or narrow bridge at high speed.

**■ Speed bumps, road work sites, train tracks, roadside objects, etc.**

You drive over speed bumps, steel road plates, etc., or your vehicle approaches train tracks or roadside objects [such as a traffic sign and guard rail] on a curve or, when parking, stationary vehicles and walls.

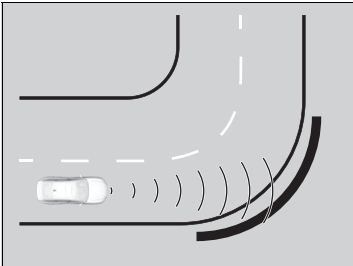

## Adaptive Cruise Control (ACC) with Low Speed Follow

Helps maintain a constant vehicle speed and a set following-interval behind a vehicle detected ahead of yours and, if the detected vehicle comes to a stop, can decelerate and stop your vehicle, without you having to keep your foot on the brake or the accelerator.

When ACC with Low Speed Follow slows your vehicle by applying the brakes, your vehicle's brake lights will illuminate.

### ▶ Adaptive Cruise Control (ACC) with Low Speed Follow

#### **⚠ WARNING**

Improper use of ACC with Low Speed Follow can lead to a crash.

Use ACC with Low Speed Follow only when driving on expressways or freeways and in good weather conditions.

#### **⚠ WARNING**

ACC with Low Speed Follow has limited braking capability and may not stop your vehicle in time to avoid a collision with a vehicle that quickly stops in front of you.

Always be prepared to apply the brake pedal if the conditions require.

#### **Important Reminder**

As with any system, there are limits to ACC with Low Speed Follow. Use the brake pedal whenever necessary, and always keep a safe interval between your vehicle and other vehicles.

#### When to use

The camera is located behind the rearview mirror.

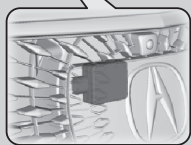
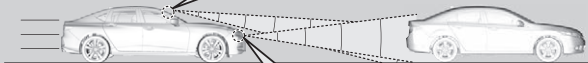

The radar sensor is behind the emblem.

- Vehicle speed for ACC with Low Speed Follow: **A vehicle is detected ahead within ACC with Low Speed Follow range** – ACC with Low Speed Follow operates at speeds up to 90 mph (145 km/h).
- **No vehicle is detected within ACC with Low Speed Follow range** – ACC with Low Speed Follow operates at the speed of about 25 mph (40 km/h) or above.
- Gear position for ACC with Low Speed Follow: In **D** or **S**.

## ■ How to activate the system

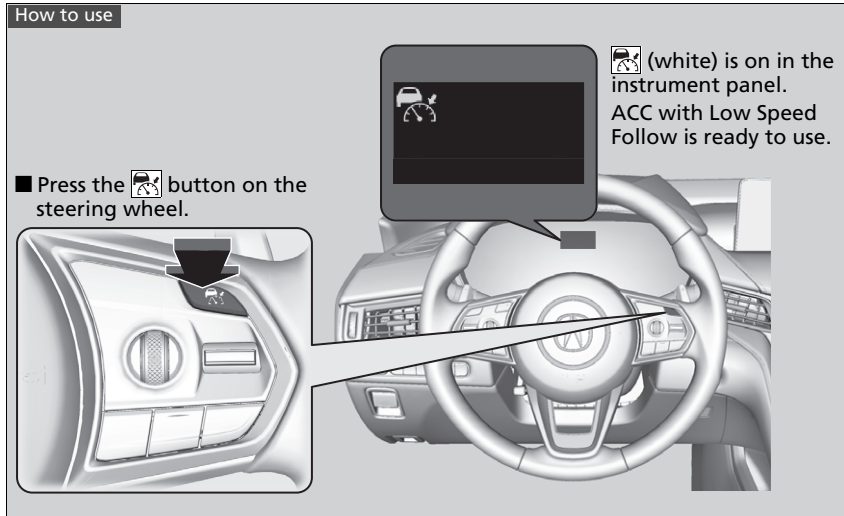

### ▣ Adaptive Cruise Control (ACC) with Low Speed Follow

For directions on the proper handling of the radar sensor, refer to the following page.

▣ **Radar Sensor** P. 482

You can read about handling information for the camera equipped with this system.

▣ **Front Sensor Camera** P. 480

The radar sensor for ACC with Low Speed Follow is shared with the Collision Mitigation Braking System™ (CMBS™).

▣ **Collision Mitigation Braking System™ (CMBS™)** P. 417

ACC with Low Speed Follow may not work properly under certain conditions.

▣ **ACC with Low Speed Follow Conditions and Limitations** P. 436

When not using ACC with Low Speed Follow: Turn off adaptive cruise by pressing the  button.

ⓘ Adaptive Cruise Control (ACC) with Low Speed Follow

Do not use ACC with Low Speed Follow under the following conditions:

- Driving in continuous stop and go traffic.
- On roads with sharp turns.
- On roads with steep downhill sections, as the set vehicle speed can be exceeded by coasting. In such cases, ACC with Low Speed Follow will not apply the brakes to maintain the set speed.
- On roads with toll collection facilities or other objects between lanes of traffic, or in parking areas, or facilities with drive through access.



## ■ To Set the Vehicle Speed

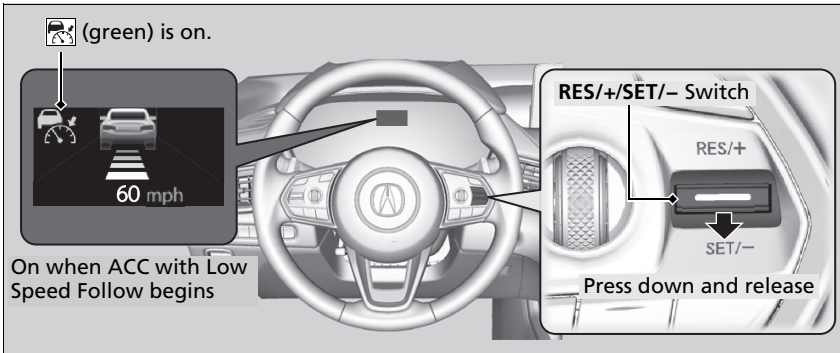

**When driving at about 25 mph (40 km/h) or above:** Take your foot off the pedal and press down the **RES/+ SET/-** switch when you reach the desired speed. The moment you release the switch, the set speed is fixed, and ACC with Low Speed Follow begins.

**When driving slower than about 25 mph (40 km/h):** If the vehicle is moving and the brake pedal is not depressed, pressing the switch fixes the set speed to about 25 mph (40 km/h) regardless of current vehicle speed. If your vehicle is stationary, you can set the vehicle speed even with the brake pedal depressed.

## ▣ To Set the Vehicle Speed

You can switch the displayed set speed measurements on the multi-information display or audio/information screen between mph and km/h.

▶ **Speed/Distance Units** P. 103

▶ **Customized Features** P. 300

The vehicle stability assist™ (VSA®) system, vehicle stability assist™ (VSA®) OFF, adaptive cruise control (ACC) with low speed follow, and safety support indicators may come on in amber along with a message in the multi-information display when you set the power mode to ON after reconnecting a battery.

Drive a short distance at more than 12 mph (20 km/h).

Each indicator should go off. If any do not, have your vehicle checked by a dealer.

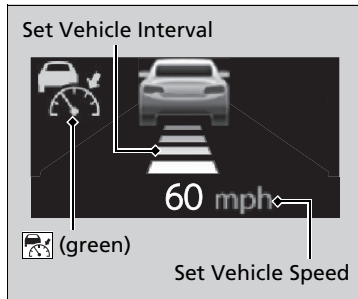

When ACC with Low Speed Follow starts operating, the vehicle icon, interval bars and set speed appear on the multi-information display.

When you use ACC with Low Speed Follow, Straight Driving Assist (a feature of the Electric Power Steering system) is activated. By enabling the steering system to automatically compensate for natural steering pull, Straight Driving Assist makes it easier for you to keep your vehicle in a straight line.

## ■ When in Operation

### ■ There is a vehicle ahead

ACC with Low Speed Follow monitors if a vehicle ahead of you enters the ACC with Low Speed Follow range. If a vehicle is detected doing so, the ACC with Low Speed Follow system maintains or decelerates your vehicle's set speed in order to keep the vehicle's set following-interval from the vehicle ahead.

📏 **To Set or Change Following-interval** P. 440

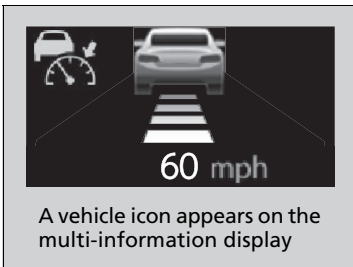
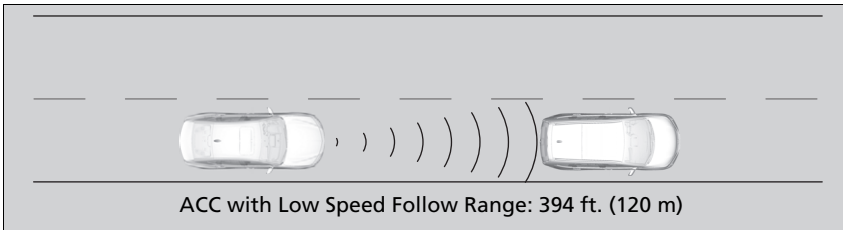

When a vehicle whose speed is slower than your set speed is detected in front of you, your vehicle starts to slow down.

## 📏 When in Operation

If the vehicle detected ahead of you slows down abruptly, or if another vehicle is detected cutting in front of you, a beeper sounds and a message appears on the multi-information display, and the head-up warning lights\* come on.

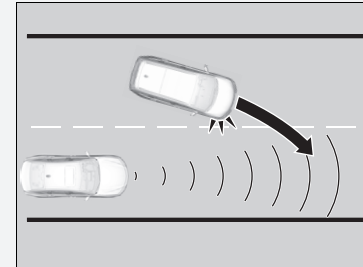

Depress the brake pedal, and keep an appropriate interval from the vehicle ahead.

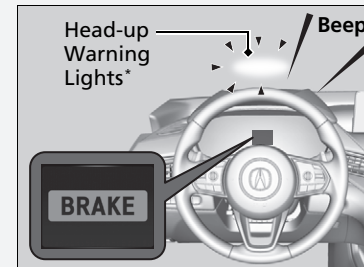

\* Not available on all models

### ■ There is no vehicle ahead

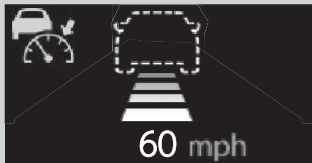

A vehicle icon with dotted-line contour appears on the multi-information display

Your vehicle maintains the set speed without having to keep your foot on the brake or accelerator pedal.

If there previously was a vehicle detected ahead that kept your vehicle from traveling at the set speed, ACC with Low Speed Follow accelerates your vehicle to the set speed, and then maintains it.

### ■ When you depress the accelerator pedal

You can temporarily increase the vehicle speed. In this case, there is no audible or visual alert even if a vehicle is in the ACC with Low Speed Follow range.

ACC with Low Speed Follow stays on unless you cancel it. Once you release the accelerator pedal, the system resumes the set speed.

There are times when the vehicle speed will decrease when the accelerator pedal is lightly applied.

### 🔗 When in Operation

Even if the interval between your vehicle and the vehicle detected ahead is short, ACC with Low Speed Follow may start accelerating your vehicle under the following circumstances:

- The vehicle ahead of you is going at almost the same speed as, or faster than, your vehicle.
- A vehicle that cuts in front of you is going faster than your vehicle, gradually increasing the interval between the vehicles.

You can also set the system to beep when a vehicle in front of you comes in and goes out of the ACC with Low Speed Follow detecting range. Change the **ACC Forward Vehicle Detect Beep** setting.

🔗 **Customized Features** P. 300

### Limitations

You may need to use the brake to maintain a safe interval when using ACC with Low Speed Follow. Additionally, ACC with Low Speed Follow may not work properly under certain conditions.

🔗 **ACC with Low Speed Follow Conditions and Limitations** P. 436

■ **A vehicle detected ahead is within ACC with Low Speed Follow range and slows to a stop**

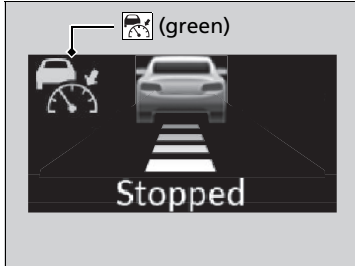

Your vehicle also stops, automatically. The **Stopped** message appears on the multi-information display. When the vehicle ahead of you starts again, the vehicle icon on the multi-information display blinks. If you press the **RES/+SET/-** switch up or down, or depress the accelerator pedal, ACC with Low Speed Follow operates again within the prior set speed.

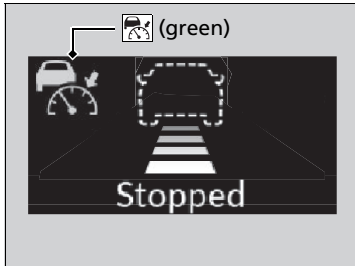

If no vehicle is ahead of you before you resume driving, depressing the accelerator pedal will resume operation of ACC with Low Speed Follow within the prior set speed.

ⓘ A vehicle detected ahead is within ACC with Low Speed Follow range and slows to a stop

**⚠ WARNING**

Exiting a vehicle that has been stopped while the ACC with Low Speed Follow system is operating can result in the vehicle moving without operator control.

A vehicle that moves without operator control can cause a crash, resulting in serious injury or death.

Never exit a vehicle when the vehicle is stopped by ACC with Low Speed Follow.

## ■ ACC with Low Speed Follow Conditions and Limitations

The system may automatically shut off and the  indicator will come on under certain conditions. Some examples of these conditions are listed below. Other conditions may reduce some of the ACC functions.

➤ **Front Sensor Camera** P. 480

➤ **Radar Sensor** P. 482

### ■ Environmental conditions

Driving in bad weather (rain, fog, snow, etc.).

### ■ Roadway conditions

Driving on a snowy or wet roadway (obscured lane marking, vehicle tracks, reflected lights, road spray, high contrast).

### ■ Vehicle conditions

- The outside of the windshield is blocked by dirt, mud, leaves, wet snow, etc.
- An abnormal tire or wheel condition (Wrong sized, varied size or construction, improperly inflated, compact spare tire\*, etc.).
- The camera temperature gets too high.
- The parking brake is applied.
- The front grille is dirty.
- The vehicle is tilted due to a heavy load or suspension modifications.
- Tire chains are installed.

## ⚠ ACC with Low Speed Follow Conditions and Limitations

If you need the radar sensor to be repaired, or removed, or the radar sensor cover is strongly impacted, turn off the system by pressing the  button and take your vehicle to a dealer.

Have your vehicle checked by a dealer if you find any unusual behavior of the system (e.g., the warning message appears too frequently).

### ■ Detection limitations

- A vehicle suddenly crosses in front of you.
- The interval between your vehicle and the vehicle ahead of you is too short.
- A vehicle cuts in front of you at a slow speed, and it brakes suddenly.
- You accelerate rapidly and approach the vehicle ahead of you at high speed.
- The vehicle ahead of you is a motorcycle, bicycle, mobility scooter, or other small vehicle.
- There are animals in front of your vehicle.
- You drive on a curved or winding or undulating road that makes it difficult for the sensor to properly detect a vehicle in front of you.

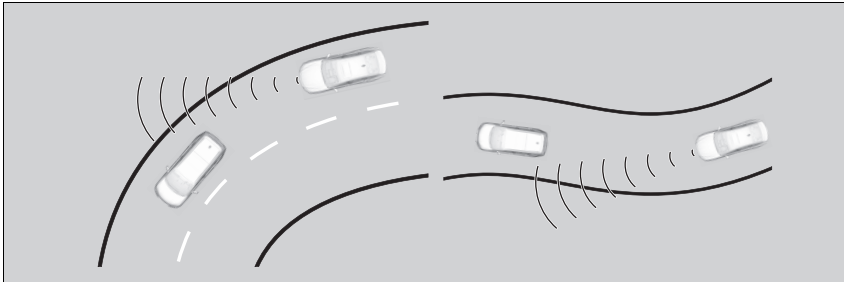

- The speed difference between your vehicle and a vehicle in front of you is significantly large.
- An oncoming vehicle suddenly comes in front of you.
- Your vehicle abruptly crosses over in front of an oncoming vehicle.

### ⚠ ACC with Low Speed Follow Conditions and Limitations

If the front of the vehicle is impacted in any of the following situations, the radar sensor may not work properly. Have your vehicle checked by a dealer:

- The vehicle mounted onto a bump, curb, chock, embankment, etc.
- You drive the vehicle where the water is deep.
- Your vehicle has a frontal collision.

- Driving through a metal bridge.



- The vehicle ahead of you brakes suddenly.
- The vehicle ahead of you has a unique shape.

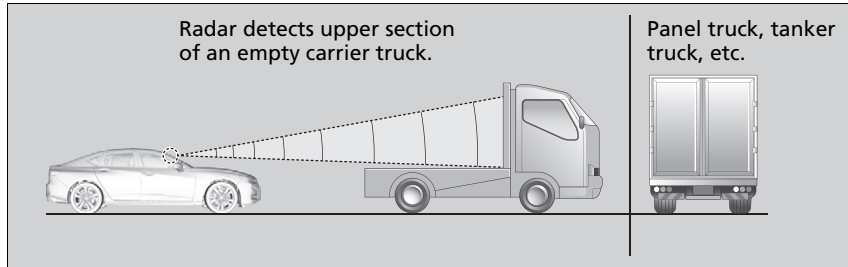

- Your vehicle or the vehicle ahead of you is driving on one edge of the lane.



## ■ To Adjust the Vehicle Speed

Increase or decrease the vehicle speed using the **RES/+**/**SET/-** switch on the steering wheel.

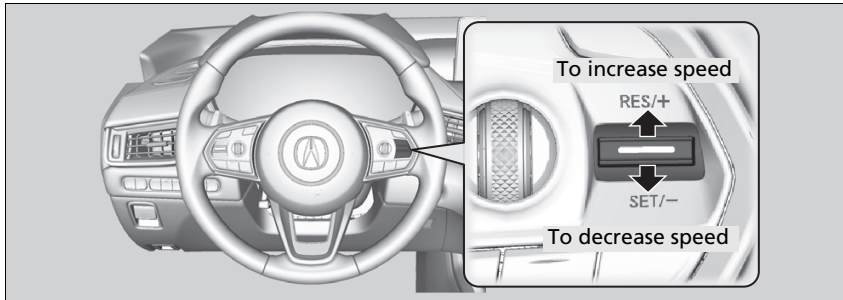

- Each time you press the switch up or down, the vehicle speed is increased or decreased by about 1 mph or 1 km/h accordingly.
- If you keep the switch pressed up or down, the vehicle speed increases or decreases by about 5 mph or 5 km/h accordingly.

## ☒ To Adjust the Vehicle Speed

If a vehicle detected ahead is going at a speed slower than your increased set speed, ACC with Low Speed Follow may not accelerate your vehicle. This is to maintain the set interval between your vehicle and the vehicle ahead.

You can switch the displayed set speed measurements on the audio/information screen or multi-information display between mph and km/h.

- ☒ **Speed/Distance Units** P. 103
- ☒ **Customized Features** P. 300

When you depress the accelerator pedal and then push and release the **SET/-** switch, the current speed of the vehicle is set.



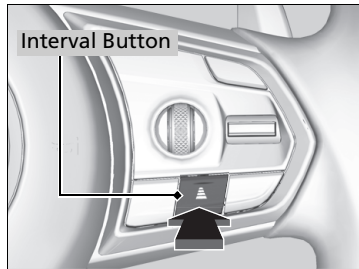

## ■ To Set or Change Following-interval



Press the interval button to change the ACC with Low Speed Follow following-interval. Each time you press the button, the following-interval (the interval behind a vehicle detected ahead of you) setting cycles through short, middle, long, and extra long following-intervals.

Determine the most appropriate following-interval setting based on your specific driving conditions. Be sure to adhere to any following-interval requirements set by local regulation.

The higher your vehicle's following-speed is, the longer the short, middle, long or extra long following-interval becomes. See the following examples for your reference.





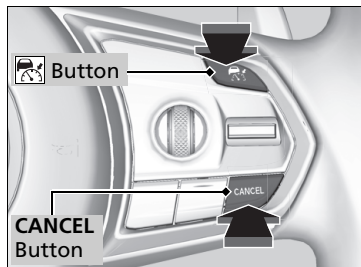

Following-interval		When the Set Speed is:	
		50 mph (80 km/h)	65 mph (104 km/h)
Short		83 feet 25 meters 1.1 sec	100 feet 31 meters 1.1 sec
Middle		110 feet 33 meters 1.5 sec	137 feet 42 meters 1.5 sec
Long		154 feet 47 meters 2.1 sec	200 feet 61 meters 2.1 sec
Extra Long		204 feet 62 meters 2.8 sec	265 feet 81 meters 2.8 sec

When your vehicle stops automatically because a vehicle detected ahead of you has stopped, the interval between the two vehicles will vary based on the ACC with Low Speed Follow interval setting.

## ■ To Cancel



To cancel ACC with Low Speed Follow, do any of the following:

- Press the **CANCEL** button.
  - ▶ The  indicator (green) on the multi-information display changes to the  indicator (white).
- Press the  button.
  - ▶  indicator (green) goes off.
- Depress the brake pedal while the vehicle is moving forward.
  - ▶ The  indicator (green) on the multi-information display changes to the  indicator (white).

## ▶▶ To Cancel

Resuming the prior set speed: After you have canceled ACC with Low Speed Follow, you can activate the ACC with Low Speed Follow with the prior set speed displayed on the multi-information display (in gray) by pressing the **RES/+ / SET/-** switch up even if the vehicle is stopped.

When you turn the ACC with Low Speed Follow off by pressing the **CANCEL** button or depressing the brake pedal, the prior set speed is displayed on the multi-information display in gray.

When pressing the **RES/+ / SET/-** switch, the ACC with Low Speed Follow is activated with displayed speed.

Then, when the  indicator (white) is displayed and you press the **RES/+ / SET/-** switch during the prior set speed (in gray) is not displayed, the current vehicle speed is set as same as the condition of operating the **RES/+ / SET/-** switch.

## ■ Automatic cancellation

The beeper sounds and a message appears on the multi-information display when ACC with Low Speed Follow is automatically canceled. Any of these conditions may cause the ACC with Low Speed Follow to automatically cancel:

- Bad weather (rain, fog, snow, etc.)
- When the radar sensor behind the emblem gets dirty.
- The vehicle ahead of you cannot be detected.
- An abnormal tire condition is detected, or the tires are skidding.
- Driving on a mountainous road, or driving off road for extended periods.
- Abrupt steering wheel movement.
- When the ABS, VSA® or CMBS™ is activated.
- When the ABS or VSA® system indicator comes on.
- When the vehicle is stopped on a very steep slope.
- When you manually apply the parking brake.
- When the detected vehicle within the ACC with Low Speed Follow range is too close to your vehicle.
- The camera behind the rearview mirror, or the area around the camera, including the windshield, gets dirty.
- When the Maximum Load Limit is exceeded.
- The vehicle has repeatedly applied the brakes to maintain the set speed (for example, you are descending a long slope).

The ACC with Low Speed Follow automatic cancellation can be also triggered by the following causes. In these cases, the parking brake will be automatically applied.



- The driver's seat belt is unfastened when the vehicle is stationary.
- The vehicle stops for more than 10 minutes.
- The engine is turned off.

▶▶ To Cancel

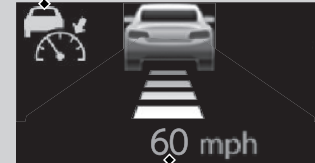
Adaptive Cruise Control (ACC)  
with Low Speed Follow Indicator  
(White)



Prior Set Speed (Gray)

The set speed cannot be set or resumed when ACC with Low Speed Follow has been turned off using the  button. Press the  button to activate the system, then set the desired speed.

## ■ To Switch ACC with Low Speed Follow to Cruise Control

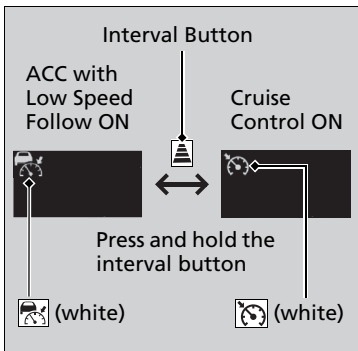

Press and hold the interval button for one second. **Cruise Mode Selected** appears on the multi-information display for two seconds, and then the mode switches to Cruise.

The  comes on.

- Green: The system is on.
- White: The system is standby.

To switch back to ACC with Low Speed Follow, press and hold the interval button again for one second.

### ■ When to use

Desired speed in a range above roughly 25 mph (40 km/h) ~.

## ■ To Set the Vehicle Speed

Take your foot off the pedal and press the **RES/+ / SET/-** switch down when you reach the desired speed.

The moment you release the **RES/+ / SET/-** switch, the set speed is fixed, and cruise control begins. The indicator  (green) comes on.

When you use cruise control, Straight Driving Assist (a feature of the Electric Power Steering system) is activated.

By enabling the steering system to automatically compensate for natural steering pull, Straight Driving Assist makes it easier for you to keep your vehicle in a straight line.

### ▶▶ To Switch ACC with Low Speed Follow to Cruise Control

Always be aware which mode you are in. When you are driving in Cruise mode, the system will not assist you to maintain a following-interval from a vehicle ahead of you.

You can switch the displayed set speed measurements on the audio/information screen or multi-information display between mph and km/h.

- ▶ **Speed/Distance Units** P. 103
- ▶ **Customized Features** P. 300







## ■ To Adjust the Vehicle Speed

Each time you press the **RES/+**/**SET/-** switch up or down, the vehicle speed is increased or decreased by about 1 mph (1 km/h).

If you keep the **RES/+**/**SET/-** switch pressed up or down, the vehicle speed increases or decreases until you release it. This speed is then set.

## ■ To Cancel

To cancel cruise control, do any of the following:

- Press the **CANCEL** button.
  - ▶ The  indicator (green) on the multi-information display changes to the  indicator (white).
- Press the  button.
  - ▶  indicator (green) goes off.
- Depress the brake pedal.
  - ▶ The  indicator (green) on the multi-information display changes to the  indicator (white).

## ▶▶ To Cancel

Resuming the prior set speed:

After you have canceled cruise mode, you can activate the cruise mode with the prior set speed displayed on the multi-information display (in gray) by pressing the **RES/+SET/-** switch up while driving at a speed of at least 25 mph (40 km/h) or more.

When you turn the cruise mode off by pressing the **CANCEL** button or depressing the brake pedal, the prior set speed is displayed on the multi-information display in gray.

When pressing the **RES/+SET/-** switch up, the cruise mode is activated with displayed speed.

Then, when the  indicator is displayed and you press the **RES/+SET/-** switch up during the prior set speed (in gray) is not displayed, the current vehicle speed is set as same as the condition of operating the **RES/+SET/-** switch down.



⌘ To Cancel

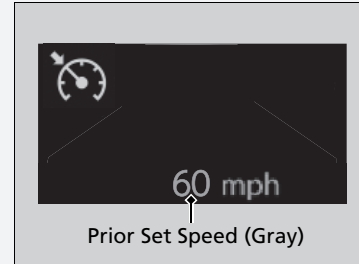

You cannot set or resume in the following situations:

- When vehicle speed is less than 25 mph (40 km/h)
- When the  button is turned off

At vehicle speeds of 22 mph (35 km/h) or less, cruise mode is canceled automatically.

## Lane Keeping Assist System (LKAS)

Provides steering input to help keep the vehicle in the middle of a detected lane and provides tactile and visual alerts if the vehicle is detected drifting out of its lane.

### ■ Steering input assist

The system applies torque to the steering to keep the vehicle between the left and right lane lines. The applied torque becomes stronger as the vehicle gets closer to either of the lane lines.



■ Front Sensor Camera  
Monitors the lane lines

■ Tactile and visual alerts  
Rapid vibrations on the steering wheel and a warning display alert you that the vehicle is drifting out of a detected lane.

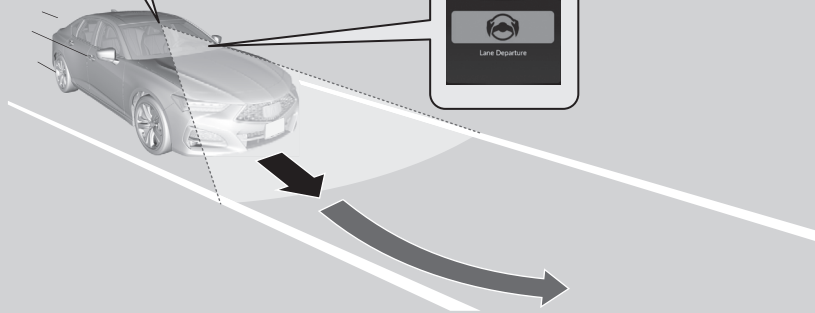

When you operate the turn signals to change lanes, the system is suspended, and resumes after the signals are off.

If you make a lane change without operating the turn signals, the LKAS alerts activate, and torque is applied to the steering.

### ▶ Lane Keeping Assist System (LKAS)

#### Important Safety Reminders

The LKAS is for your convenience only. It is not a substitute for your vehicle control. The system does not work if you take your hands off the steering wheel or fail to steer the vehicle.

Do not place objects on the instrument panel. Objects may reflect on the windshield and prevent correct detection of the traffic lanes.

The LKAS only alerts you when lane drift is detected without a turn signal in use. The LKAS may not detect all lane markings or lane departures; accuracy will vary based on weather, speed, and lane marker condition. It is always your responsibility to safely operate the vehicle and avoid collisions.

The LKAS is convenient when it is used on freeways.

The LKAS may not work properly or may work improperly under the certain conditions:

▶ **LKAS Conditions and Limitations** P. 454

You can read about handling information for the camera equipped with this system.

▶ **Front Sensor Camera** P. 480

The LKAS may not function as designed while driving in frequent stop and go traffic, or on roads with sharp curves.

### ■ Lane Keep Support Function

Provides assistance to keep the vehicle in the center of the lane. When the vehicle nears a white or yellow line, steering force of the electric power steering will become stronger.

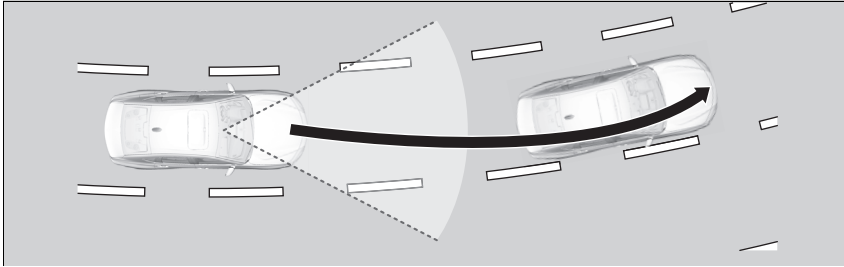

### ■ Lane Departure Warning Function

When the vehicle enters the warning area, the LKAS alerts you with slight steering wheel vibration as well as a warning display.

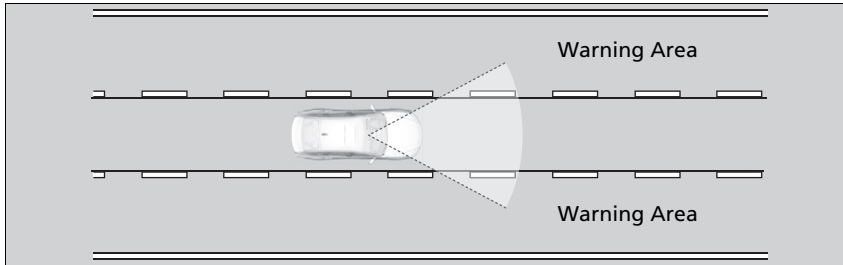

### ☒ Lane Keeping Assist System (LKAS)

When it fails to detect lanes, the system will temporarily be canceled. When a lane is detected, the system will recover automatically.

## ■ When the System can be Used

The system can be used when the following conditions are met.

- The lane in which you are driving has detectable lane markers on both sides, and your vehicle is in the center of the lane.
- The vehicle is traveling between about 45 and 90 mph (72 and 145 km/h).
- You are driving on a straight or slightly curved road.
- The turn signals are off.
- The brake pedal is not depressed.
- The wipers are not in continuous high speed operation.

## ■ How to activate the system

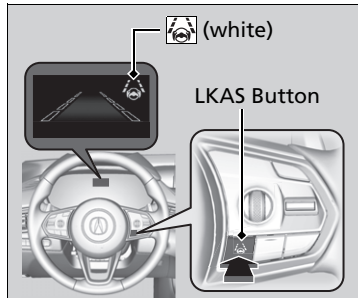

1. Press the LKAS button.

- ▶ LKAS indicator (white) and lane outlines appear on the multi-information display. The system is ready to use.

## ⚠ When the System can be Used

If the vehicle drifts toward either left or right lane line due to the system applying torque, turn off the LKAS and have your vehicle checked by a dealer.

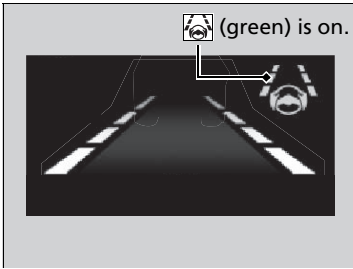

2. Keep your vehicle near the center of the lane while driving.
  - ▶ The LKAS indicator changes from white to green and the dotted outer lines change to solid ones once the system starts operating after detecting the left and right lane markings.

## ■ To Cancel

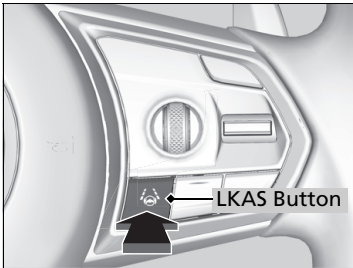

Press the LKAS button.

The LKAS is turned off every time you stop the engine, even if you turned it on the last time you drove the vehicle.

 (white) is on.

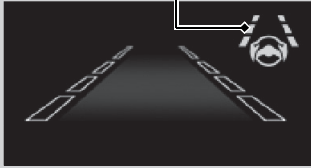

When the LKAS is suspended, the lane lines on the multi-information display change to contour lines, and the beeper sounds (if activated).

■ **The system operation is suspended if you:**

- Turning the wipers to continuous high speed operation.
  - ▶ Both **LO** and **INT** mode or **OFF** will resume LKAS.
- Decrease the vehicle speed to about 40 mph (64 km/h) or less.
  - ▶ Increasing the vehicle speed to about 45 mph (72 km/h) or more resumes the LKAS.
- Depress the brake pedal.
  - ▶ The LKAS resumes and starts detecting the lane lines again once you release the brake pedal.

▶▶ The system operation is suspended if you:

You can change the setting for the LKAS. LKAS suspended beep **ON** and **OFF** can be selected.  
▶▶ **Customized Features** P. 300

**■ The LKAS may automatically be suspended when:**

- The system fails to detect lane lines.
- The steering wheel is quickly turned.
- You fail to steer the vehicle.
- Driving through a sharp curve.
- Driving at a speed in excess of approximately 90 mph (145 km/h).

Once these conditions no longer exist, the LKAS automatically resumes.

**■ The LKAS may automatically be canceled when:**

- The camera temperature gets extremely high or low.
- The camera behind the rearview mirror, or the area around the camera, including the windshield, gets dirty.
- The ABS or VSA® system engages.

The beeper sounds if the LKAS is automatically canceled.

## ■ LKAS Conditions and Limitations

The system may not detect lane markings and therefore may not keep the vehicle in the middle of a lane under certain conditions, including the following:

### ■ Environmental conditions

- Driving in bad weather (rain, fog, snow, etc.).
- Sudden changes between light and dark, such as an entrance or exit of a tunnel.
- There is little contrast between lane lines and the roadway surface.
- Driving into low sunlight (e.g., at dawn or dusk).
- Strong light is reflected onto the roadway.
- Driving in the shadows of trees, buildings, etc.
- Shadows of adjacent objects are parallel to lane markings.
- Roadway objects or structures are misinterpreted as lane markers.
- Reflections on the interior of the windshield.
- Driving at night or in a dark condition such as a tunnel.



■ **Roadway conditions**

- Driving on a snowy or wet roadway (obscured lane marking, vehicle tracks, reflected lights, road spray, high contrast).
- Driving on a road with temporary lane markings.
- Faint, multiple, or varied lane markings are visible on the roadway due to road repairs or old lane markings.

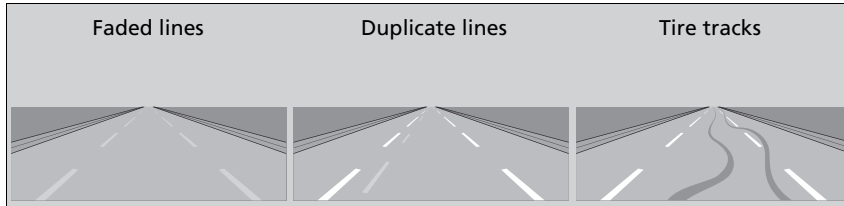

- The roadway has merging, split, or crossing lines (e.g., such as at an intersection or crosswalk).
- The lane markings are extremely narrow, wide, or changing.

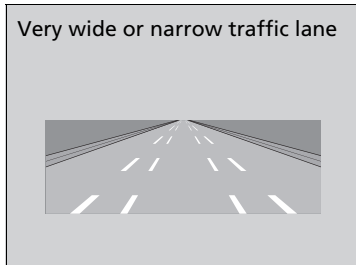

- The vehicle in front of you is driving near the lane lines.
- The road is hilly or the vehicle is approaching the crest of a hill.
- Driving on rough or unpaved roads, or over bumpy surfaces.

- When objects on the road (curb, guard rail, pylons, etc.) are recognized as white lines (or yellow lines).
- Driving on roads with double lines.

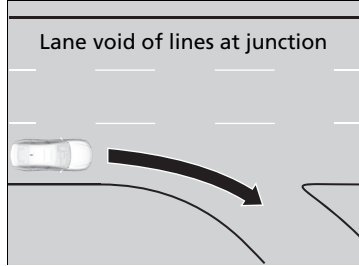

#### ■ Vehicle conditions

- Headlight lenses are dirty or the headlights are not properly adjusted.
- The outside of the windshield is streaked or blocked by dirt, mud, leaves, wet snow, etc.
- The inside of the windshield is fogged.
- The camera temperature gets too high.
- An abnormal tire or wheel condition (wrong sized, varied size or construction, improperly inflated, compact spare tire\*, etc.).
- The vehicle is tilted due to a heavy load or suspension modifications.

## Traffic Jam Assist

The traffic jam assist system uses a radar sensor mounted inside the front grille and a camera mounted to the upper portion of the windshield to detect and monitor left and right white (yellow) traffic lane lines as well as any vehicle ahead. Based on inputs from the radar sensor and camera, the system adjusts the speed of your vehicle to maintain a set interval between your vehicle and the one detected ahead. It also applies steering torque to keep your vehicle in the center of the detected lane when you are driving in heavy traffic.

### ■ How Traffic Jam Assist works

If you are in heavy traffic and Adaptive Cruise Control with Low Speed Follow is active, the traffic jam assist system, upon detecting the traffic lane lines and a vehicle ahead, will apply steering torque to help keep your vehicle in the center of the lane. The system adjusts the speed of your vehicle to maintain a set interval between your vehicle and the one detected ahead.

#### ⓘ Traffic Jam Assist

### ⚠ WARNING

Improper reliance on Traffic Jam Assist can cause a crash resulting in injury or death. Always maintain full control over your vehicle even when this system is active, and only use when on expressways or freeways. Traffic Jam Assist is not an autonomous driving system.

### ⚠ WARNING

Failure to securely park vehicle when stopped while Adaptive Cruise Control with Low Speed Follow is active can allow the vehicle to roll away, resulting in a crash causing injury or death. Never stop the vehicle and exit it without placing it in Park and setting the parking brake.

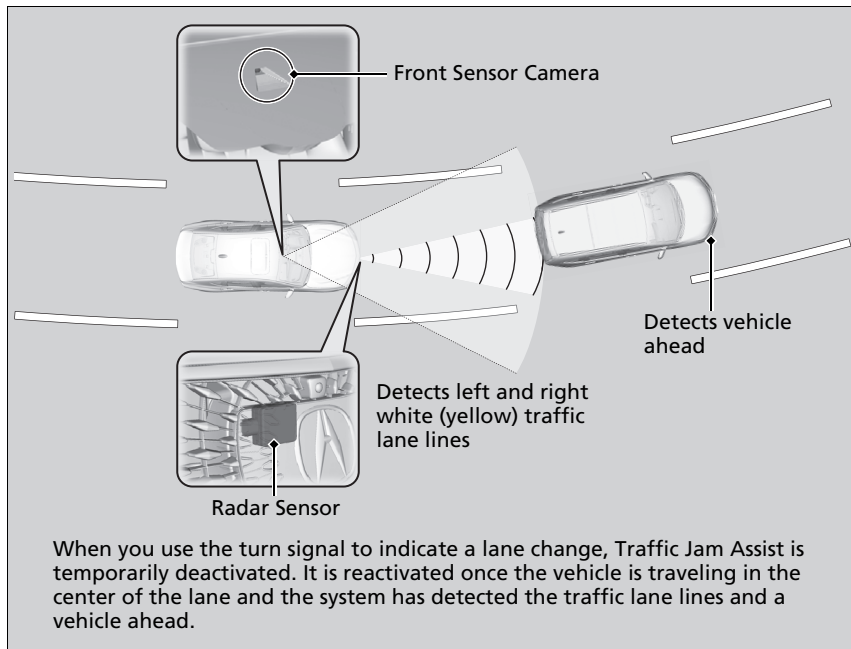

When the driver takes direct control of steering, the steering assist function is temporarily canceled. The torque applied to steering may not be noticeable when the driver has direct control of steering, or when the surface of the road is rough or uneven.

▶▶ Traffic Jam Assist

You can read about handling information for the camera equipped with this system.

▶ **Front Sensor Camera** P. 480

Traffic Jam Assist may not always be able to detect lane division lines or a vehicle traveling ahead. Depending on weather and road conditions and other factors, Traffic Jam Assist may not function normally. Always be aware of your surroundings and the road conditions, and conduct yourself in a manner conducive to safe driving. Traffic Jam Assist may not function properly when you are driving through a sharp curve or repeatedly accelerating and decelerating.

Traffic Jam Assist may not work properly under the certain conditions:

▶ **Traffic Jam Assist: Conditions and limitations** P. 464

## Traffic Jam Assist Activation

Traffic Jam Assist is activated when all of the following circumstances exist:

- LKAS is active.
- ACC with Low Speed Follow is active.
- The vehicle speed is between 0 and 45mph (0 and 72km/h) and there is a vehicle detected traveling ahead.
- The lane in which you are driving has detectable lane markers on both sides, and your vehicle is in the center of the lane.
- You are driving on a straight or slightly curved road.
- The driver is gripping the steering wheel.

Do not use Traffic Jam Assist in any of the following situations:

- You are traveling on a road with sharp curves.
  - ▶ The system may not allow your vehicle to respond in a manner best suited for the road conditions.
- You are entering a toll booth, interchange, service area, or parking area.
  - ▶ If the vehicle ahead disappears from the travel path of your vehicle, your vehicle may suddenly accelerate to resume the set speed.
- You are driving in adverse weather (rain, fog, snow, etc.).
  - ▶ The system may not be able to correctly determine the interval between your vehicle and the one ahead.
- The surface of the road is slippery, for example, it is icy or covered with snow.
  - ▶ The tires may slip, causing you to lose control of the vehicle.
- You are driving in a HOV lane and motorcycles are passing you to the side, or you are required to keep your vehicle to the right or the left of the lane.
  - ▶ The system may not be able to correctly determine the vehicle ahead.

*Continued*

### ▶▶ Traffic Jam Assist Activation

Refer to the following page for proper handling of the Adaptive Cruise Control with Low Speed Follow:

▶ **Adaptive Cruise Control (ACC) with Low Speed Follow** P. 428

Refer to the following page for proper handling of the Lane Keeping Assist System (LKAS):

▶ **Lane Keeping Assist System (LKAS)** P. 448

Refer to the following page for steering buttons and displays:

▶ **Operation Switches for the ACC with Low Speed Follow/LKAS/Traffic Jam Assist**  
P. 414

## ■ How Traffic Jam Assist Works

### ■ When a vehicle is traveling ahead

When a vehicle ahead of yours is detected entering the Traffic Jam Assist detection area, Traffic Jam Assist adjusts the speed of your vehicle to maintain the selected interval between your vehicle and the one ahead. It also applies steering torque to keep your vehicle in the center of the detected lane.

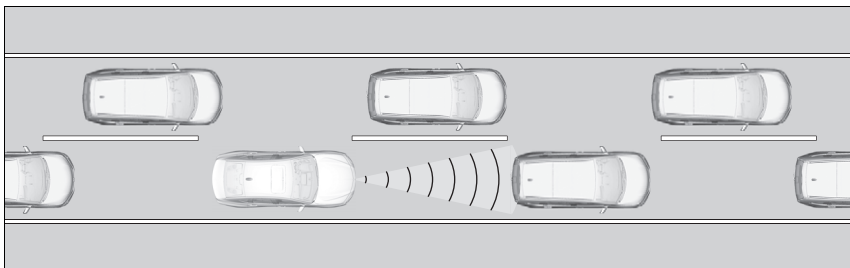

## ☒ How Traffic Jam Assist Works

If your vehicle veers too far to the right or the left of the white (yellow) traffic lane lines while Traffic Jam Assist is active, deactivate Traffic Jam Assist and have an authorized Acura dealer inspect your vehicle.

In some cases the system cannot properly detect the traffic lane lines and, as a result, will not provide steering assistance.

### ☒ Traffic Jam Assist: Conditions and limitations P. 464

If the driver takes his or her hands off the steering wheel or does not adequately maintain control of steering, the warning below will appear.

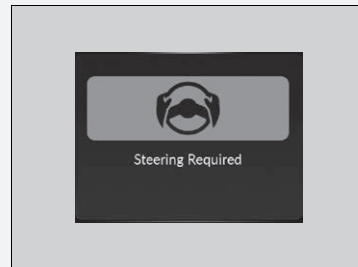

If the driver does not grip the steering wheel after the warning above has repeatedly appeared, a warning buzzer will sound and Traffic Jam Assist will be canceled.

You can have the head-up display\* show you the current state of Traffic Jam Assist.

### ☒ Head-Up Display\* P. 111

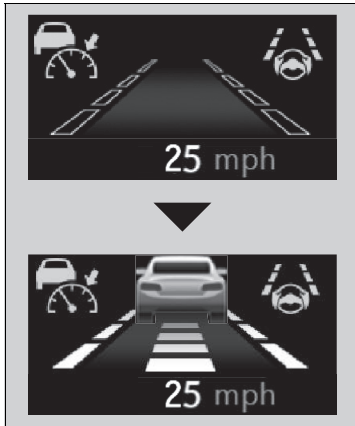

Keep your vehicle near the center of the lane while driving.

- ▶ Traffic Jam Assist will be activated once the camera has detected the white (yellow) traffic lane lines on either side of the lane and the radar sensor and camera have detected a vehicle driving ahead.

The dotted outer lines change to solid ones and a vehicle icon appears on the multi-information display.

### ■ When no vehicle is traveling ahead

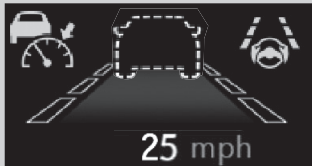

The dotted outer lines and a vehicle icon with a dotted-line contour appear on the multi-information display.

If the vehicle detected ahead disappears from the travel path of your vehicle (for example, it changes lanes), Traffic Jam Assist will be deactivated temporarily and your vehicle will gradually accelerate until it reaches the set speed, after which it will maintain that speed.

### ☒ How Traffic Jam Assist Works

If the vehicle detected ahead suddenly slows down, or if another vehicle is detected cutting in front of yours, a warning buzzer will sound, and a warning in the multi-information display and head-up warning\* will appear.

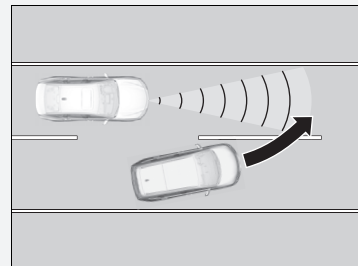

Depress the brake pedal and take direct control of steering.

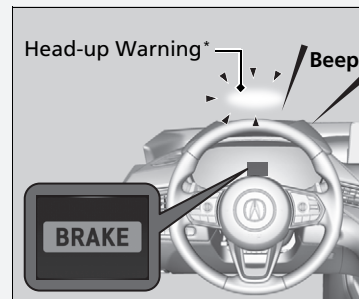



## ■ Canceling Traffic Jam Assist

To cancel Traffic Jam Assist, you can do any of the following:

- Press the  button.
- Press the LKAS button.
- When the ACC with Low Speed Follow is deactivated.

### ■ When Traffic Jam Assist may automatically be suspended when:

The system is temporarily canceled automatically under the following circumstances.

- The system fails to detect lane lines.
- The vehicle ahead of you cannot be detected.
- The steering wheel is turned quickly.
- You fail to steer the vehicle.
- The vehicle in front of you is driving near the lane lines.

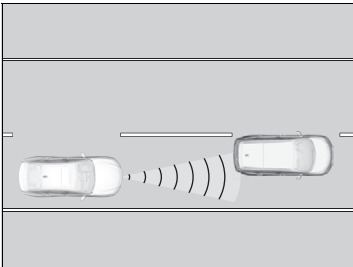

- The wipers are set to high.
- The interval between your vehicle and the one traveling ahead is over 197 feet (60m).

Once these conditions no longer exist, the Traffic Jam Assist automatically resumes.

### ⊗ How Traffic Jam Assist Works

If you are traveling slower than the vehicle detected ahead or a vehicle that is detected cutting in front of you and the interval between your vehicle and the detected vehicle gradually increases, your vehicle will continue to follow that vehicle without emitting any warning, even if the interval between the vehicle is minimal.

### ⊗ When Traffic Jam Assist may automatically be suspended when:

You are traveling over 45mph (72km/h).

▶ When the speed of the vehicle reaches 45mph (72km/h), Traffic Jam Assist is deactivated and LKAS is activated instead. Once the speed of the vehicle drops to under 42mph (68km/h), Traffic Jam Assist is reactivated.

### ■ When Traffic Jam Assist may automatically be canceled when:

It is possible that under any of the following circumstances, broken lines representing traffic lane lines will appear in the multi-information display, a buzzer will sound, and Traffic Jam Assist will be canceled.

- The temperature of the camera is too high.
- The camera behind the rearview mirror, or the area around the camera, including the windshield, is dirty.

### ■ Traffic Jam Assist: Conditions and limitations

Under the following circumstances, some features of Traffic Jam Assist may not work.

#### ■ Vehicle conditions

- The front grille is dirty.
- Headlight lenses are dirty or the headlights are not properly adjusted.
- The outside of the windshield is streaked or blocked by dirt, mud, leaves, wet snow, etc.
- The inside of the windshield is fogged up.
- Your vehicle is fitted with tires or wheels of differing size, type, or structure, or the tires are not properly inflated.
- The vehicle is tilted due to a heavy load or suspension modifications.
- The interval between your vehicle and the detected vehicle ahead of you is too short.
- Snow chains are installed on the tires.

### ■ Environmental conditions

- Bad weather (rain, fog, snow, etc.).
- You are driving into low sunlight (e.g., at dawn or dusk).
- Strong light is reflected onto your vehicle or the roadway.
- Brightness in the immediate area suddenly changes between light and dark, such as at the entrance or exit of a tunnel.
- The road has puddles or the surface of the road is shiny due to recent rainfall.
- Shadows are cast across the lane lines (e.g., trees, buildings, guardrails, vehicle, etc.).
- Spray or snow coming off the vehicle ahead.
- Driving at night or in a dark condition such as a tunnel.

### ■ Roadway conditions

Certain features of the road can interfere with proper camera operation. Here are some examples:

- The lines are not very distinguishable from the surface of the road.
- The section of the road has lane restrictions or temporarily marked lanes.
- The lines are faded, removed lines remain visible next to newer lines (duplicate lines), or the road is marked with tire tracks.

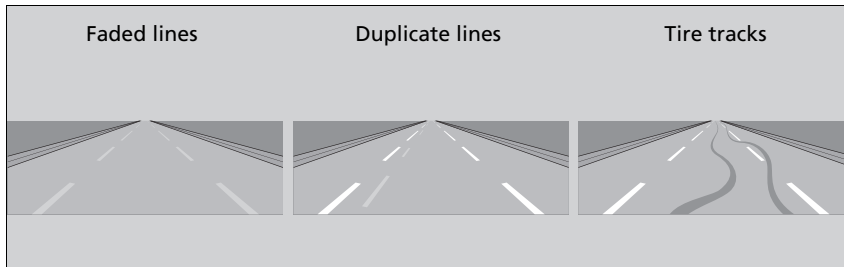

*Continued*

- The roadway has merging, split, or crossing lines (e.g., such as at an intersection or crosswalk).
- The lane markings are extremely narrow, wide, or of inconsistent width.

Very wide or narrow traffic lane

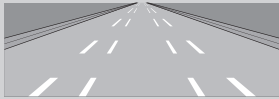

- The lane lines are partly concealed by your vehicle or another vehicle.
- The road is hilly or the vehicle is approaching the crest of a hill.
- The vehicle is shaking considerably because of an uneven road surface, etc.
- Objects on the road (curb, guard rail, pylons, etc.) are recognized as white lines (or yellow lines).
- The lines appear distorted or they briefly disappear out of the camera detection range due to an uneven road surface.
- The road is unpaved, or has a rough or bumpy surface.
- The roads has double lines.
- The surface of the road is slippery due to icy or snowy conditions.
- Sections of the paved road are obscured by puddles or snow.
- The road has ruts.

- The section of the road branches off or merges with another road.

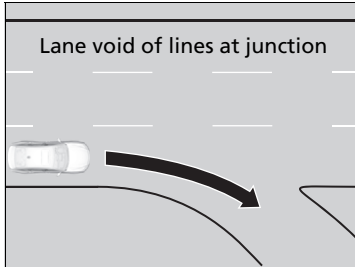

■ **Certain features of the road can interfere with proper radar sensor operation. Here are some examples:**

- The road has curves, undulations, slopes, etc.

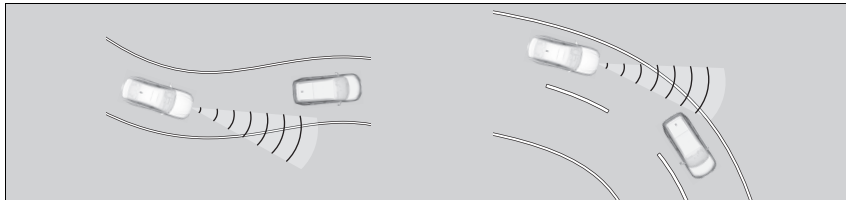

- The radar beam is reflecting off multiple items that are within close proximity of your vehicle. This can happen when you are driving, for example, across a narrow truss bridge.

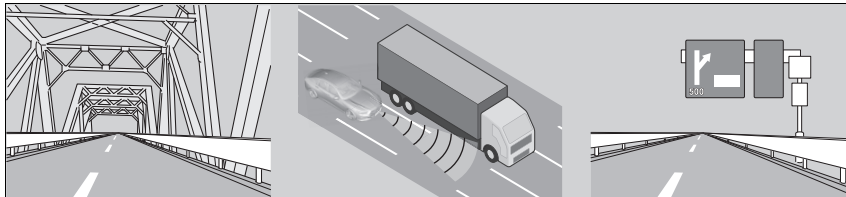

Continued

### ■ Detection limitations

- The vehicle ahead suddenly accelerates.
- The vehicle ahead is a panel truck or a vehicle whose shape is not of standard dimensions.

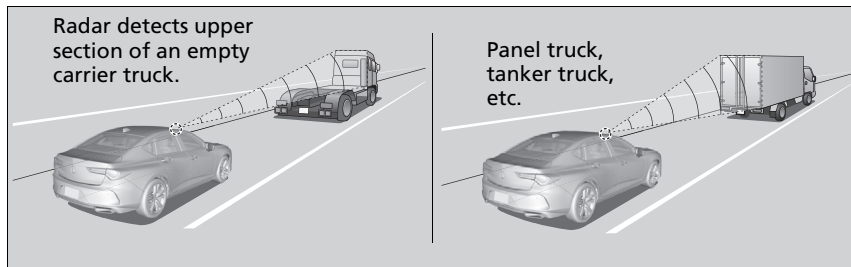

- The vehicle ahead of you is a motorcycle, bicycle, mobility scooter, or other small vehicle.
- The ground clearance of the vehicle ahead is unusually high.

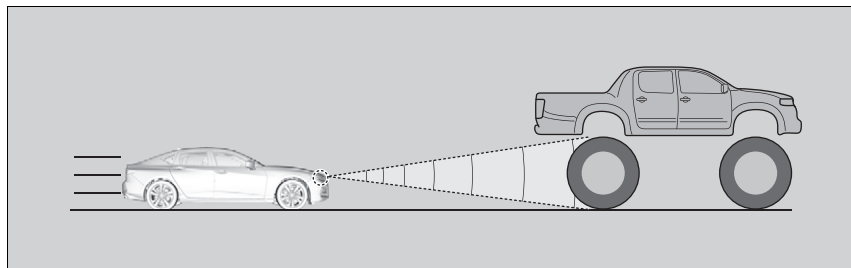

- A vehicle suddenly cuts in front of yours.

## Road Departure Mitigation (RDM) System

Alerts and helps to assist you when the system detects a possibility of your vehicle unintentionally crossing over detected lane markings and/or leaving the roadway altogether.

### ■ How the System Works

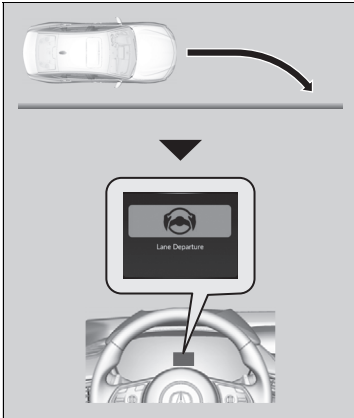

The front camera behind the rearview mirror monitors left and right lane markings (in white or yellow). If your vehicle is getting too close to detected lane markings without a turn signal activated, the system, in addition to a visual alert, applies steering torque and alerts you with rapid vibrations on the steering wheel, to help you remain within the detected lane.

▶ **Customized Features** P. 300

As a visual alert, the **Lane Departure** message appears on the multi-information display.

If the system determines that its steering input is insufficient to keep your vehicle on the roadway, it may apply braking.

▶ Braking is applied only when the lane markings are solid continuous lines.

The system cancels assisting operations when you turn the steering wheel to avoid crossing over detected lane markings.

If the system operates several times without detecting driver response, the system beeps to alert you.

### ▣ Road Departure Mitigation (RDM) System

#### Important Safety Reminder

Like all assistance systems, the RDM system has limitations.

Over-reliance on the RDM system may result in a collision. It is always your responsibility to keep the vehicle within your driving lane.

The RDM system only alerts you when lane drift is detected without a turn signal in use. The RDM system may not detect all lane markings or lane or roadway departures; accuracy will vary based on weather, speed and lane marker condition. It is always your responsibility to safely operate the vehicle and avoid collisions.

You can read about handling information for the camera equipped with this system.

▶ **Front Sensor Camera** P. 480

The RDM system may not work properly or may work improperly under the certain conditions:

▶ **RDM Conditions and Limitations** P. 472

There are times when you may not notice RDM functions due to your operation of the vehicle, or road surface conditions.

## ■ How the System Activates

The system becomes ready to start searching for lane markings when all the following conditions are met:

- The vehicle is traveling between about 45 and 90 mph (72 and 145 km/h).
- The vehicle is on a straight or slightly curved road.
- The turn signals are off.
- The brake pedal is not depressed.
- The wipers are not in continuous high speed operation.
- The vehicle is not accelerating or braking, and the steering wheel is not being turned.
- The system makes a determination that the driver is not actively accelerating, braking or steering.

## ▣ How the System Activates

The RDM system may automatically shut off and the safety support indicator (amber) comes and stays on.

### ▣ Indicators P. 78

RDM system function can be impacted when the vehicle is:



- Not driven within a traffic lane.
- Driven on the inside edge of a curve, or outside of a lane.
- Driven in a narrow lane.

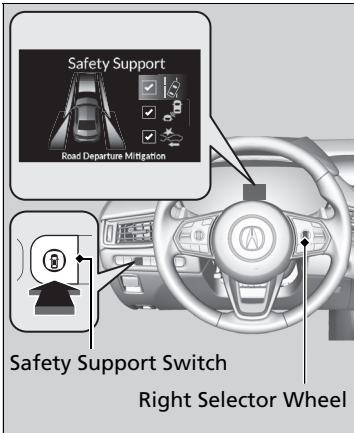

## RDM On and Off



When you turn the RDM on and off, do the following.

1. Press the safety support switch.
2. Roll the right selector wheel to the  symbol and push it.
  - ▶ The message appears on the multi-information display when the system becomes on or off.
  - ▶ A check mark appears in the box and the color of the  symbol changes green when the system is on. The check mark disappears and the color of the  symbol changes gray when the system is off.

The RDM is in the previously selected on (checked) or off (unchecked) setting each time you start the engine.

## RDM On and Off

When you have selected **Warning Only** from the customized options using the audio/information screen, the system does not operate the steering wheel and braking.

▶ **Customized Features P. 300**

If LKAS is off and you have selected **Narrow** from the customized options using the multi information display, the message below will appear in case the system determines a possibility of your vehicle crossing over detected lane markings.

▶ **Customized Features P. 300**

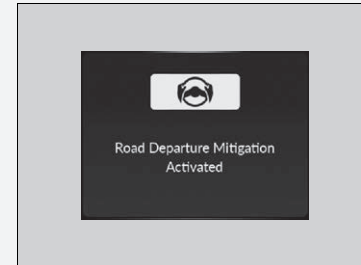

In the following case, a beeper sounds, a message related to the ACC with Low Speed Follow appears on the multi-information display, and the braking function controlled by the Road Departure Mitigation system is canceled.

- The vehicle has repeatedly applied the brakes to maintain the set speed (for example, you are descending a long slope).

Continued

## ■ RDM Conditions and Limitations

The system may not properly detect lane markings and the position of your vehicle under certain conditions. Some examples of these conditions are listed below.

### ■ Environmental conditions

- Driving in bad weather (rain, fog, snow, etc.).
- Sudden changes between light and dark, such as an entrance or exit of a tunnel.
- There is little contrast between lane lines and the roadway surface.
- Driving into low sunlight (e.g., at dawn or dusk).
- Strong light is reflected onto the roadway.
- Driving in the shadows of trees, buildings, etc.
- Shadows of adjacent objects are parallel to lane markings.
- Roadway objects or structures are misinterpreted as lane markers.
- Reflections on the interior of the windshield.
- Driving at night or in a dark condition such as a tunnel.

### ⌘ RDM On and Off

The vehicle stability assist™ (VSA®) system, vehicle stability assist™ (VSA®) OFF, adaptive cruise control (ACC) with low speed follow, and safety support indicators may come on in amber along with a message in the multi-information display when you set the power mode to ON after reconnecting a battery.  
Drive a short distance at more than 12 mph (20 km/h).  
Each indicator should go off. If any do not, have your vehicle checked by a dealer.

**■ Roadway conditions**

- Driving on a snowy or wet roadway (obscured lane marking, vehicle tracks, reflected lights, road spray, high contrast).
- Driving on a road with temporary lane markings.
- Faint, multiple, or varied lane markings are visible on the roadway due to road repairs or old lane markings.
- The roadway has merging, split, or crossing lines (e.g., such as at an intersection or crosswalk).
- The lane markings are extremely narrow, wide, or changing.
- The vehicle in front of you is driving near the lane lines.
- The road is hilly or the vehicle is approaching the crest of a hill.
- Driving on rough or unpaved roads, or over bumpy surfaces.
- When objects on the road (curb, guard rail, pylons, etc.) are recognized as white lines (or yellow lines).
- Driving on roads with double lines.

**■ Vehicle conditions**

- Headlight lenses are dirty or the headlights are not properly adjusted.
- The outside of the windshield is streaked or blocked by dirt, mud, leaves, wet snow, etc.
- The inside of the windshield is fogged.
- The camera temperature gets too high.
- An abnormal tire or wheel condition (wrong sized, varied size or construction, improperly inflated, compact spare tire\*, etc.).
- The vehicle is tilted due to a heavy load or suspension modifications.
- When tire chains are installed.

\* Not available on all models

## Traffic Sign Recognition System

Reminds you of road sign information of the current speed limit, your vehicle has just passed through, showing it on the multi-information display and the head-up display\*.

### ■ How the System Works

When the camera located behind the rearview mirror captures traffic signs while driving, the system displays the ones that are recognized as designated for your vehicle. The sign icon will be displayed until the vehicle reaches a predetermined time and distance.

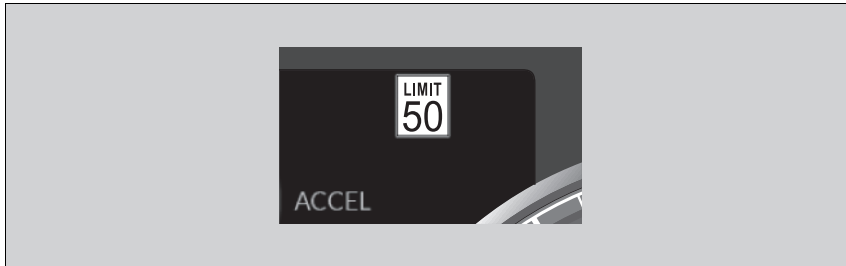

The sign icon also may switch to another one or disappear when:

- The other designated limit is detected.
- You make a turn with a turn signal at an intersection.

### ⚠ Traffic Sign Recognition System

Not all signs may be displayed, but any signs posted on roadsides should not be ignored. The system does not work on the designated traffic signs of all the countries you travel, nor in all situations. Do not rely too much on the system. Always drive at speeds appropriate for the road conditions.

Never apply a film or attach any objects to the windshield that could obstruct the camera's field of vision and cause the system to operate abnormally. Scratches, nicks, and other damage to the windshield within the camera's field of vision can cause the system to operate abnormally. If this occurs, we recommend that you replace the windshield with a genuine Acura replacement windshield. Making even minor repairs within the camera's field of vision or installing an aftermarket replacement windshield may also cause the system to operate abnormally. After replacing the windshield, have a dealer recalibrate the camera. Proper calibration of the camera is necessary for the system to operate properly.

If the system does not detect any traffic signs while you are driving, the image below may appear.



#### ☒ Traffic Sign Recognition System

To help reduce the likelihood that high interior temperatures will cause the camera's sensing system to shut off, when parking, find a shady area or face the front of the vehicle away from the sun. If you use a reflective sun shade, do not allow it to cover the camera housing.

Covering the camera can concentrate heat on it.

You can read about handling information for the camera equipped with this system.

➤ **Front Sensor Camera** P. 480

## ■ Traffic Sign Recognition System Conditions and Limitations

The traffic sign recognition system may not be able to recognize the traffic sign in the following cases.

### ■ Vehicle conditions

- Headlight lenses are dirty or the headlights are not properly adjusted.
- The outside of the windshield is blocked by dirt, mud, leaves, wet snow, etc.
- The inside of the windshield is fogged.
- There are portions remaining to be wiped.
- An abnormal tire or wheel condition (wrong sized, varied size or construction, improperly inflated, compact spare tire\*, etc.).
- The vehicle is tilted due to a heavy load or suspension modifications.

### ■ Environmental conditions

- Driving into low sunlight (e.g., at dawn or dusk).
- Strong light is reflected onto the roadway.
- Sudden changes between light and dark, such as an entrance or exit of a tunnel.
- When you drive in the shadows of trees, buildings, etc.
- Driving at night, in dark areas such as long tunnels.
- Driving in bad weather (rain, fog, snow, etc.).
- A vehicle in front of you is traveling flying up spray or snow.

## ⌘ Traffic Sign Recognition System Conditions and Limitations

When the traffic sign recognition system malfunctions,  appears on the multi-information display. If this message does not disappear, have your vehicle checked by a dealer.



**■ The position or the condition of the traffic sign**

- A sign is hard to be found since it is in a complicated area.
- A sign is located far away from your vehicle.
- A sign is located where the beam of the headlight is hard to reach.
- A sign is on a corner or bend in the road.
- Faded or bent signs.
- Rotated or damaged signs.
- A sign is covered with mud, snow, or frost.
- A part of the sign is hidden by the trees, or the sign itself is hidden by a vehicle and others.
- Light (a streetlight) or a shadow is reflected on the surface of the sign.
- A sign is too bright or too dark (an electric sign).
- A sign of a small size.

**■ Other conditions**

- When you are driving at a high speed.

The traffic sign recognition system may not operate correctly, such as displaying a sign that does not follow the actual regulation for the roadway or does not exist at all in the following cases.

- ▶ A speed limit sign may display at a higher or lower speed than the actual speed limit.
- There is a supplementary sign with further information such as weather, time, vehicle type, school zone, etc.
- Figures on the sign are hard to read (electric signs, numbers on the sign are blurred, etc.).
- A sign is in the vicinity of the lane you are driving even though it is not for the lane (speed limit sign situated at the junction between the side road and the main road, etc.).
- There are things that look similar to the color or shape of the recognition object (similar sign, electric sign, signboard, structure, etc.).
- A truck or another large vehicle with a sticker of the speed limit sign on the back are traveling in front of you.



## ■ Signs Displayed on the Multi-Information Display and Head-up Display\*

The speed limit sign icon is displayed on the right half of the screen.

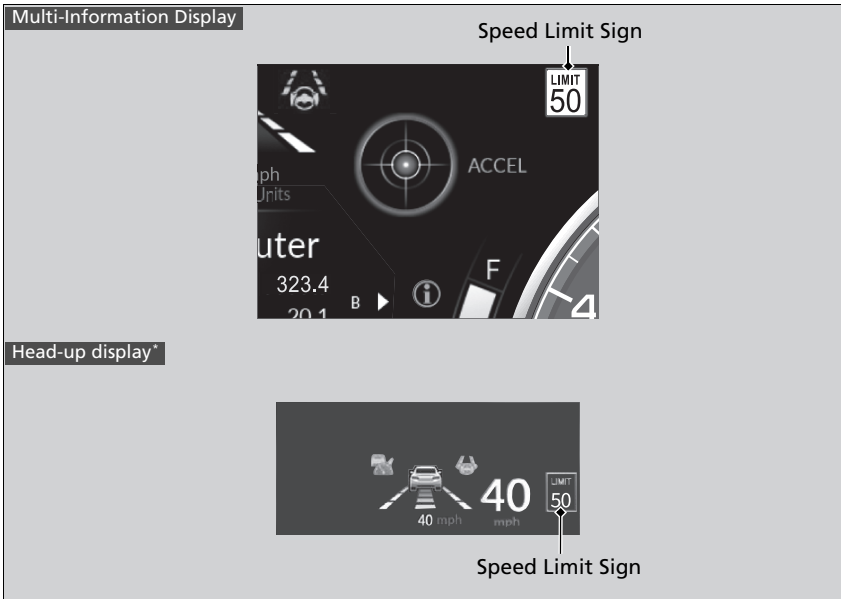

\* Not available on all models

## Front Sensor Camera

The camera, used in systems such as LKAS, RDM, ACC with Low Speed Follow, CMBS™, and Traffic Jam Assist is designed to detect an object that triggers any of the systems to operate its functions.

### ■ Camera Location and Handling Tips

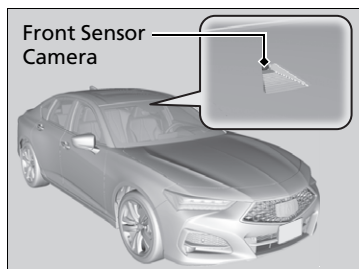

This camera is located behind the rearview mirror.

To help reduce the likelihood that high interior temperatures will cause the camera's sensing system to shut off, when parking, find a shady area or face the front of the vehicle away from the sun. If you use a reflective sun shade, do not allow it to cover the camera housing. Covering the camera can concentrate heat on it.

### ▣ Front Sensor Camera

Never apply a film or attach any objects to the windshield, the hood, or the front grille that could obstruct the camera's field of vision and cause the system to operate abnormally. Scratches, nicks, and other damage to the windshield within the camera's field of vision can cause the system to operate abnormally. If this occurs, we recommend that you replace the windshield with a genuine Acura replacement windshield. Making even minor repairs within the camera's field of vision or installing an aftermarket replacement windshield may also cause the system to operate abnormally. After replacing the windshield, have a dealer recalibrate the camera. Proper calibration of the camera is necessary for the system to operate properly.

Do not place an object on the top of the instrument panel. It may reflect onto the windshield and prevent the system from detecting lane lines properly.

## ⌘ Front Sensor Camera

If the **Some Driver Assist Systems Cannot Operate: Camera Temperature Too High** message appears:

- Use the climate control system to cool down the interior and, if necessary, also use defroster mode with the airflow directed towards the camera.
- Start driving the vehicle to lower the windshield temperature, which cools down the area around the camera.

If the **Some Driver Assist Systems Cannot Operate: Clean Front Windshield** message appears:

- Park your vehicle in a safe place, and clean the windshield. If the message does not disappear after you have cleaned the windshield and driven for a while, have your vehicle checked by a dealer.

## Radar Sensor

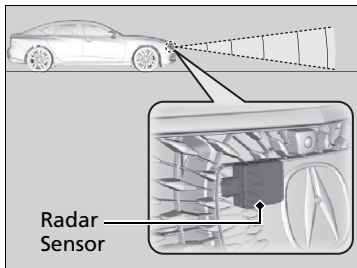

The radar sensor is behind the emblem.

### ⊠ Radar Sensor

Avoid strong impacts to the radar sensor cover.

For the CMBS™ to work properly:

- Always keep the radar sensor cover clean.
- Never use chemical solvents or polishing powder for cleaning the sensor cover. Clean it with water or a mild detergent.
- Do not put a sticker on the radar sensor cover or replace the radar sensor cover.

If you need the radar sensor to be repaired, or removed, or the radar sensor cover is strongly impacted, turn off the system by using the safety support switch and take your vehicle to a dealer.

⊠ **CMBS™ On and Off** P. 421

If the vehicle is involved in any of the following situations, the radar sensor may not work properly. Have your vehicle checked by a dealer:

- Your vehicle is involved in a frontal collision
- Your vehicle drives through deep water or is submerged in deep water
- Your vehicle strongly strikes a bump, curb, chock, or embankment that could jar the radar sensor

## Brake System

### ■ Parking Brake

Use the parking brake to keep the vehicle stationary when parked. When the parking brake is applied, you can manually or automatically release it.

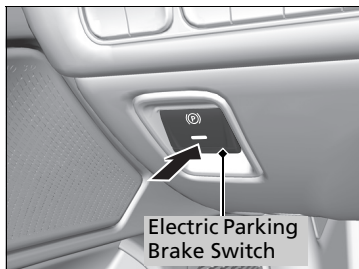

#### ■ To apply

The electric parking brake can be applied any time the vehicle has battery, no matter which position the power mode is in.

Press the electric parking brake switch gently and securely.

- ▶ The indicator in the switch comes on.
- ▶ The parking brake and brake system indicator comes on.

#### ⌘ Brake System

When you depress the brake pedal, you may hear a whirring sound from the engine compartment. This is because the brake system is in operation, and it is normal.

#### ⌘ Parking Brake

You may hear the electric parking brake system motor operating from the rear wheel area when you apply or release the parking brake. This is normal.

The brake pedal may slightly move due to the electric parking brake system operation when you apply or release the parking brake. This is normal.

You cannot apply or release the parking brake if the battery goes dead.

➤ **If the Battery Is Dead** P. 593

**If you press and hold the electric parking brake switch while driving, the brakes on all four wheels are applied by the electric servo brake system until the vehicle comes to a stop. The electric parking brake then applies, and the switch should be released.**

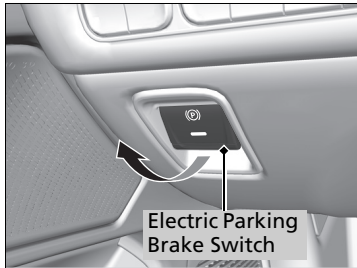

### ■ To release

The power mode must be in ON in order to release the electric parking brake.

1. Depress the brake pedal.
2. Pull the electric parking brake switch.
  - ▶ The indicator in the switch goes off.
  - ▶ The parking brake and brake system indicator goes off.

Manually releasing the parking brake using the switch helps your vehicle start slowly and smoothly when facing down hill on steep hills.

### ▣ Parking Brake

In the following situations, the parking brake automatically operates.

- When the vehicle stops more than 10 minutes while ACC with Low Speed Follow is activated.
- When the driver's seat belt is unfastened while your vehicle is stopped automatically by ACC with Low Speed Follow.
- When the engine is turned off, except by Auto Idle Stop system, while ACC with Low Speed Follow is activated.
- When the vehicle stops with the automatic brake hold system activated for more than 10 minutes.
- When the driver's seat belt is unfastened while your vehicle is stopped and automatic brake hold is applied.
- When the engine is turned off, except by Auto Idle Stop system, while automatic brake hold is applied.
- When there is a problem with the Automatic Brake Hold System while automatic brake hold is applied.

### ■ Automatic parking brake feature operation

If the automatic parking brake feature has been activated:

- The parking brake is applied automatically when you set the power mode to VEHICLE OFF.
- To confirm that the parking brake is applied, check if the Parking Brake and Brake System indicator (red) is on.

➤ **Activating and deactivating the automatic parking brake feature** P. 486

### ■ To release automatically

Depressing the accelerator pedal releases the parking brake.

Use the accelerator pedal to release the brake when you are starting the vehicle facing uphill, or in a traffic jam.

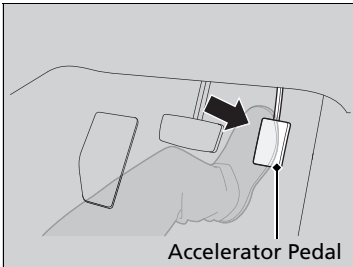

Gently depress the accelerator pedal. When on a hill, it may require more accelerator input to release.

- ▶ The parking brake and brake system indicator goes off.

You can release the parking brake automatically when:

- You are wearing the driver's seat belt.
- The engine is running.
- The transmission is not in **P** or **N**.

### ⊠ Parking Brake

If the parking brake cannot be released automatically, release it manually.

When the vehicle is traveling uphill, the accelerator pedal may need to be pressed farther to automatically release the electric parking brake.

The parking brake cannot be released automatically while the following indicators are on:

- Malfunction indicator lamp
- Transmission system indicator

The parking brake may not be released automatically while the following indicators are on:

- Electric parking brake system indicator
- VSA® system indicator
- **ABS** indicator
- Supplemental restraint system indicator

### ■ Activating and deactivating the automatic parking brake feature

With the power mode in ON, carry out the following steps to either activate or deactivate the automatic parking brake feature.

1. Put the transmission into [P].
2. Without depressing the brake pedal, press and release the parking brake switch.
  - ▶ Check that the Parking Brake and Brake System indicator (red) has come on.
3. Press and hold the parking brake switch. When you hear a beeping sound, release the switch and within 3 seconds press and hold the switch again.
4. When you hear a sound indicating that the procedure is completed, release the switch.
  - ▶ Two beeps indicates that the feature has been activated.
  - ▶ One beep indicates that the feature has been deactivated.
  - ▶ When you have completed activating the feature, the parking brake will remain applied after you turn off the engine.
  - ▶ To confirm that the parking brake is applied, check if the Parking Brake and Brake System indicator (red) is on.

If you need to temporarily deactivate the feature for when putting your vehicle through a conveyor type car wash, you can follow the procedure explained below.

1. Depress the brake pedal and bring the vehicle to a stop.
2. Set the power mode to VEHICLE OFF and then within 2 seconds pull up the parking brake switch.
  - ▶ Activation and deactivation settings for the feature will not be affected.
  - ▶ Before temporarily deactivating the feature, make sure to first turn off both ACC with Low Speed Follow and the automatic brake hold system.
  - ▶ To confirm that the parking brake is applied, check if the Parking Brake and Brake System indicator (red) is on.

### ▣ Parking Brake

In cold climates, the parking brake may freeze in place if applied.

When parking the vehicle, chock the wheels and make sure the automatic parking brake feature is deactivated.

Also, when putting your vehicle through a conveyor-type car wash or when having your vehicle towed, deactivate the automatic parking brake feature and leave the parking brake released.



## ■ Foot Brake

Your vehicle is equipped with disc brakes at all four wheels. The brake assist system increases the stopping force when you depress the brake pedal hard in an emergency situation. The anti-lock brake system (ABS) helps you retain steering control when braking very hard.

🔧 **Brake Assist System** P. 491

🔧 **Anti-lock Brake System (ABS)** P. 490

## ☒ Foot Brake

Check the brakes after driving through deep water, or if there is a buildup of road surface water. If necessary, dry the brakes by lightly depressing the pedal several times.

If you hear a continuous metallic friction sound when applying the brakes, this is caused by the brake wear indicator rubbing on the brake rotor and indicates that the brake pads need to be replaced. Have the vehicle checked by a dealer. If you hear only an occasional squeak or squeal when you initially apply the brake pedal, this may be normal and caused by high frequency vibration of the brake pads against the rotating brake disc.

Constantly using the brake pedal while going down a long hill builds up heat, which reduces the brake effectiveness. Apply engine braking by taking your foot off the accelerator pedal and downshifting to a lower gear.

Do not rest your foot on the brake pedal while driving, as it will lightly apply the brakes and cause them to lose effectiveness over time and reduce pad life. It will also confuse drivers behind you.

## ■ Automatic Brake Hold

Keeps the brake applied after releasing the brake pedal until the accelerator pedal is pressed. You can use this system while the vehicle is temporarily stopped, like at traffic lights and in heavy traffic.

## ▶▶ Automatic Brake Hold

### ⚠ WARNING

Activating the automatic brake hold system on steep hills or slippery roads may still allow the vehicle to move if you remove your foot from the brake pedal.

If a vehicle unexpectedly moves, it may cause a crash resulting in serious injury or death.

Never activate the automatic brake hold system or rely on it to keep a vehicle from moving when stopped on a steep hill or slippery roads.

### ⚠ WARNING

Using the automatic brake hold system to park the vehicle may result in the vehicle unexpectedly moving.

If a vehicle moves unexpectedly, it may cause a crash, resulting in serious injury or death.

Never leave the vehicle when braking is temporarily kept by automatic brake hold and always park the vehicle by putting the transmission in **P** and applying the parking brake.

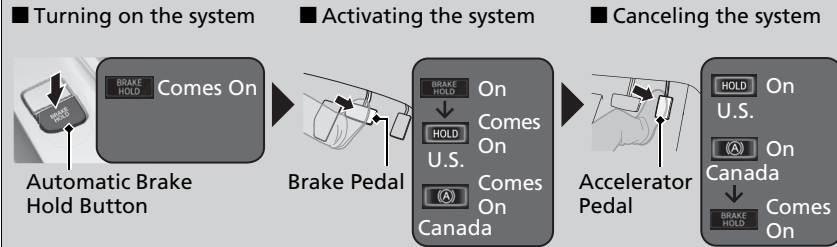

Fasten your seat belt properly, then start the engine. Press the automatic brake hold button.

- The automatic brake hold system indicator comes on. The system is turned on.

Depress the brake pedal to come to a complete stop. The transmission must not be in **P** or **R**.

- The automatic brake hold indicator comes on. Braking is kept for up to 10 minutes.
- Release the brake pedal after the automatic brake hold indicator comes on.

Depress the accelerator pedal while the transmission is in a position other than **P** or **N**. The system is canceled and the vehicle starts to move.

- The automatic brake hold indicator goes off. The system continues to be on.

■ **The system automatically cancels when:**

- You engage the parking brake.
- You depress the brake pedal and put the transmission into **P** or **R**.

■ **The system automatically cancels and the parking brake is applied when:**

- Braking is kept for more than 10 minutes.
- The driver's seat belt is unfastened.
- The engine is turned off.
- There is a problem with automatic brake hold system.

■ **Turning off the automatic brake hold system**

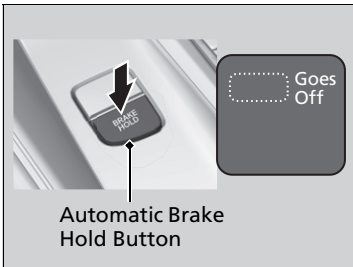

While the system is on, press the automatic brake hold button again.

- ▶ The automatic brake hold system indicator goes off.

If you want to turn off automatic brake hold while the system is in operation, press the automatic brake hold button with the brake pedal depressed.

⌘ Automatic Brake Hold

While the system is activated, you can turn off the engine or park the vehicle through the same procedure as you normally do.

⌘ **When Stopped** P. 492

Whether the system is on, or the system is activated, the automatic brake hold turns off once the engine is off.

⌘ Turning off the automatic brake hold system

Make sure to turn off the automatic brake hold system before using an automated car wash.

You may hear an operating noise if the vehicle moves while the automatic brake hold system is in operation.

## Anti-lock Brake System (ABS)

### ■ ABS

Helps prevent the wheels from locking up, and helps you retain steering control by pumping the brakes rapidly, much faster than you can.

The electronic brake distribution (EBD) system, which is part of the ABS, also balances the front-to-rear braking distribution according to vehicle loading.

You should never pump the brake pedal. Let the ABS work for you by always keeping firm, steady pressure on the brake pedal. This is sometimes referred to as “stomp and steer.”

### ■ ABS operation

The brake pedal may pulsate slightly when the ABS is working. Depress the brake pedal and keep holding the pedal firmly down. On dry pavement, you will need to press on the brake pedal very hard before the ABS activates. However, you may feel the ABS activate immediately if you are trying to stop on snow or ice.

ABS may activate when you depress the brake pedal when driving on:

- Wet or snow covered roads.
- Roads paved with stone.
- Roads with uneven surfaces, such as potholes, cracks, manholes, etc.

When the vehicle speed goes under 6 mph (10 km/h), the ABS stops.

### ► Anti-lock Brake System (ABS)

#### NOTICE

The ABS may not function correctly if you use a tire of the wrong size or type.

If the **ABS** indicator comes on while driving, there may be a problem with the system. While normal braking will not be affected, there is a possibility that the ABS will not be operating. Have your vehicle checked by a dealer immediately.

The ABS is not designed for the purpose of reducing the time or distance it takes for a vehicle to stop: It is designed to limit brake lockup which can lead to skidding and loss of steering control.

In the following cases, your vehicle may need more distance to stop than a vehicle without the ABS:

- You are driving on rough or uneven road surfaces, such as gravel or snow.
- The tires are equipped with tire chains.

The following may be observed with the ABS system:

- Motor sounds coming from the engine compartment when the brakes are applied, or when system checks are being performed after the engine has been started and while the vehicle accelerates.
- Brake pedal and/or the vehicle body vibration when ABS activates.

These vibrations and sounds are normal to ABS systems and are no cause for concern.

## Brake Assist System

Designed to assist the driver by generating greater braking force when you depress the brake pedal hard during emergency braking.

### ■ Brake assist system operation

Press the brake pedal firmly for more powerful braking.

## When Stopped

1. Depress the brake pedal firmly.
2. With the brake pedal depressed, press the electric parking brake switch slowly, but fully.
3. Change the shift position to **P**.
4. Turn off the engine.
  - ▶ The parking brake and brake system indicator goes off in about 30 seconds.

### ▣ Parking Your Vehicle

#### **WARNING**

The vehicle can roll away if left unattended without confirming that Park is engaged.

A vehicle that rolls away could cause a crash resulting in serious injury or death.

Always keep your foot on the brake pedal until you have confirmed that **P** is shown on the gear position Indicator.

Do not park your vehicle near flammable objects, such as dry grass, oil, or timber. Heat from the exhaust can cause a fire.

#### **NOTICE**

The following can damage the transmission:

- Depressing the accelerator and brake pedals simultaneously.
- Holding the vehicle in place when facing uphill by depressing the accelerator pedal.
- Changing into **P** before the vehicle stops completely.

Always set the parking brake, in particular if you are parked on an incline.

#### ⚠ When Stopped

In extremely cold temperatures, the parking brake may freeze up if applied. If such temperatures are expected, do not apply the parking brake but, if parking on a slope, either turn the front wheels so they will contact the curb if the vehicle rolls down the slope or block the wheels to keep the vehicle from moving. If you do not take either precaution, the vehicle may roll unexpectedly, leading to a crash.

## Parking Sensor System \*

The corner and center sensors monitor obstacles around your vehicle, and the beeper and audio/information screen let you know the approximate distance between your vehicle and the obstacle.

### ■ The sensor location and range

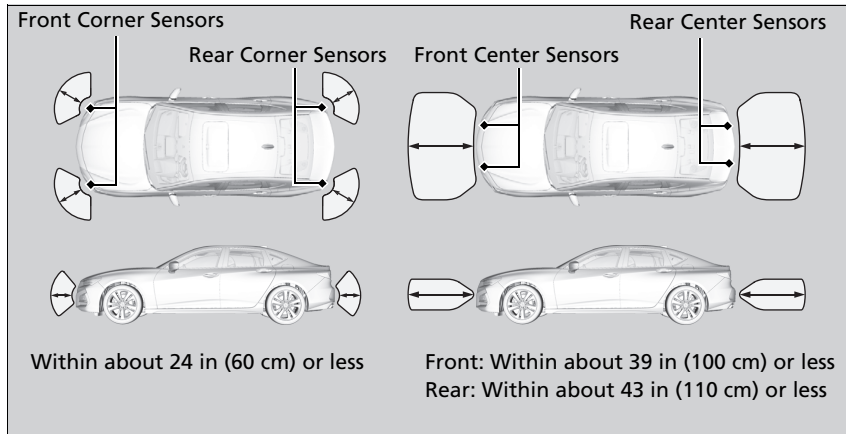

### ▣ Parking Sensor System \*

Even when the system is on, always confirm if there is no obstacle near your vehicle before parking.

The system may not work properly when:

- The sensors are covered with snow, ice, mud or dirt.
- The vehicle is on uneven surface, such as grass, bumps, or a hill.
- The vehicle has been out in hot or cold weather.
- The system is affected by devices that emit ultrasonic waves.
- Driving in bad weather.

The system may not sense:

- Thin or low objects.
- Sonic-absorptive materials, such as snow, cotton, or sponge.
- Objects directly under the bumper.

Do not put any accessories on or around the sensors.

When you set the power mode to ON, the system will be in the previously selected condition.



## ■ Parking sensor system on and off

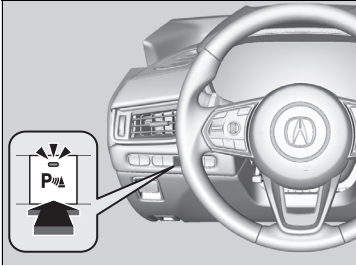

With the power mode in ON, press the parking sensor system button to turn the system on or off. The indicator in the button comes on when the system is on.

The rear center and corner sensors and the front corner sensors start to detect an obstacle when the transmission is in **[R]**, and the vehicle speed is less than 5 mph (8 km/h).

The front center and corner sensors start to detect an obstacle when the transmission is not in **[P]** or **[R]**, and the vehicle speed is less than 5 mph (8 km/h).

■ When the distance between your vehicle and obstacles becomes shorter

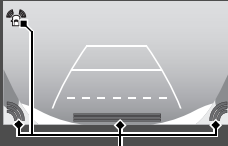
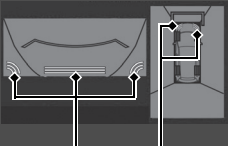
Interval between beeps	Distance between the Bumper and Obstacle		Indicator	Audio/Information Screen
	Corner Sensors	Center Sensors		
Moderate	—	Front: About 27-24 in (70-60 cm) Rear: About 41-24 in (105-60 cm)	Blinks in Yellow*1	<div data-bbox="1182 297 1458 348" data-label="Text"> <p>Models with multi-view rear camera system</p> </div>  <div data-bbox="1177 527 1458 572" data-label="Text"> <p>Indicators light up where the sensor detects an obstacle.</p> </div>
Short	About 24-18 in (60-45 cm)	About 24-18 in (60-45 cm)	Blinks in Amber	
Very short	About 18-14 in (45-35 cm)	About 18-14 in (45-35 cm)		
Continuous	About 14 in (35 cm) or less	About 14 in (35 cm) or less	Blinks in Red	<div data-bbox="1190 602 1453 652" data-label="Text"> <p>Models with surround view camera system</p> </div>  <div data-bbox="1177 829 1458 874" data-label="Text"> <p>Indicators light up where the sensor detects an obstacle.</p> </div>

\*1: At this stage, only the center sensors detect obstacles.

## ■ Turning off All Rear Sensors

1. Make sure that the parking sensor system is not activated. Set the power mode to VEHICLE OFF (LOCK).
2. Press and hold the parking sensor system button, and set the power mode to ON.
3. Keep pressing the button for 10 seconds. Release the button when the indicator in the button flashes.
4. Press the button again. The indicator in the button goes off.
  - ▶ The beeper sounds twice. The rear sensors are now turned off.

To turn the rear sensors on again, follow the above procedure. The beeper sounds three times when the rear sensors come back on.

### ☒ Turning off All Rear Sensors

When you set the gear position to **[R]**, the indicator in the parking sensor system button blinks as a reminder that the rear sensors have been turned off.

## Cross Traffic Monitor\*

Monitors the rear corner areas using the radar sensors when reversing, and alerts you if a vehicle approaching from a rear corner is detected.

The system is convenient when you are backing out of a parking space.

### ⓘ Cross Traffic Monitor\*

#### CAUTION

Cross Traffic Monitor cannot detect all approaching vehicles and may not detect an approaching vehicle at all.

Failure to visually confirm that it is safe to back up the vehicle before doing so may result in a collision.

Do not solely rely on the system when reversing; always also use your mirrors, and look behind and to the sides of your vehicle before reversing.

## ■ How the System Works

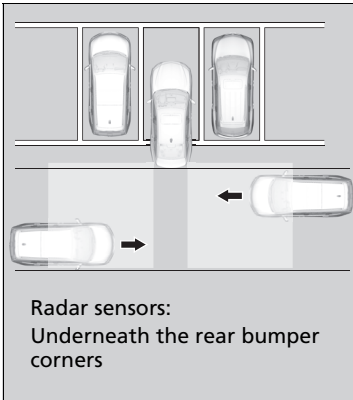

The system activates when:

- The power mode is in ON.
- The Cross Traffic Monitor is turned on.
  - ▶ **Cross Traffic Monitor On and Off** P. 502
- The transmission is in **R**.
- Your vehicle is moving at 3 mph (5 km/h) or lower.

When a vehicle is detected approaching from a rear corner, Cross Traffic Monitor alerts you with a buzzer and a displayed warning.

The system will not detect a vehicle that approaches from directly behind your vehicle, nor will it provide alerts about a detected vehicle when it moves directly behind your vehicle.

The system does not provide alerts for a vehicle that is moving away from your vehicle, and it may alert for pedestrians, bicycles, or stationary objects.

## ⊠ Cross Traffic Monitor\*

Cross Traffic Monitor may not detect or may delay alerting an approaching vehicle, or may alert without an approaching vehicle under the following conditions:

- An obstacle, such as another vehicle and a wall, near your vehicle's rear bumper, is blocking the radar sensor's scope.
- Your vehicle is moving at the speed of about 3 mph (5 km/h) or higher.
- A vehicle is approaching at the speed other than between about 6 mph (10 km/h) and 16 mph (25 km/h).
- The system picks up external interference such as other radar sensors from another vehicle or strong radio wave transmitted from a facility nearby.
- Either corner of the rear bumper is covered with snow, ice, mud or dirt.
- When there is bad weather.
- Your vehicle is on an incline.
- Your vehicle is tilted due to a heavy load in the rear.
- Your vehicle is reversing towards a wall, a pole, a vehicle, and so on.
- The rear bumper or the sensors have been improperly repaired or the rear bumper has been deformed.

Have your vehicle checked by a dealer.

\* Not available on all models

🔍 Cross Traffic Monitor\*

For proper operation, always keep the rear bumper corner area clean.  
Do not cover the rear bumper corner area with labels or stickers of any kind.

The parking sensor system's alerting buzzer overrides the Cross Traffic Monitor buzzer when the sensors are detecting obstacles at the closest range.

## When the System Detects a Vehicle

### Models with multi-view rear camera system

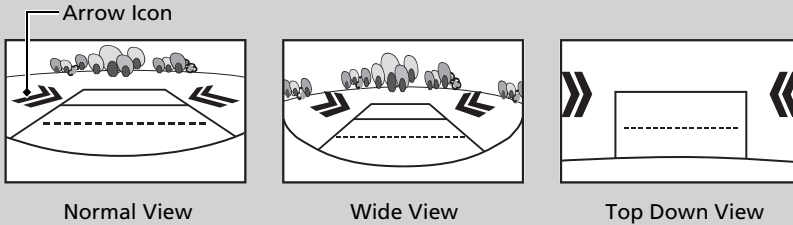

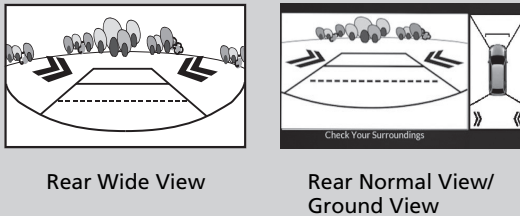

### Models with surround view camera system



An arrow icon appears on the side a vehicle is approaching on the audio/information screen.

### When the System Detects a Vehicle

If the  on the lower right changes to  in amber when the transmission is in **R**, mud, snow or ice, etc. may have accumulated in the vicinity of the sensor. The system is temporarily canceled. Check the bumper corners for any obstructions, and thoroughly clean the area if necessary.

If the  comes on when the transmission is in **R**, there may be a problem with the Cross Traffic Monitor system. Do not use the system and have your vehicle checked by a dealer.

If the display remains the same with the transmission in **R**, there may be a problem with the rear camera system and the Cross Traffic Monitor system. Do not use the system and have your vehicle checked by a dealer.

## ■ Cross Traffic Monitor On and Off

You can switch the system on and off using the audio/information screen.

📄 **Customized Features** P. 300

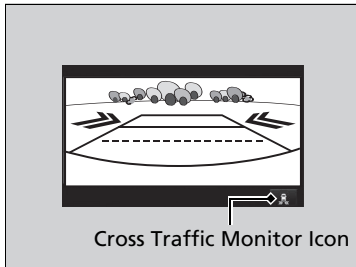

The system can also be turned on and off on the audio/information screen by pressing the Cross Traffic Monitor icon.



## About Your Multi-View Rear Camera

The audio/information screen can display your vehicle's rear view. The display automatically changes to the rear view when the transmission is put into **R**.

### Multi-View Rear Camera Display Area

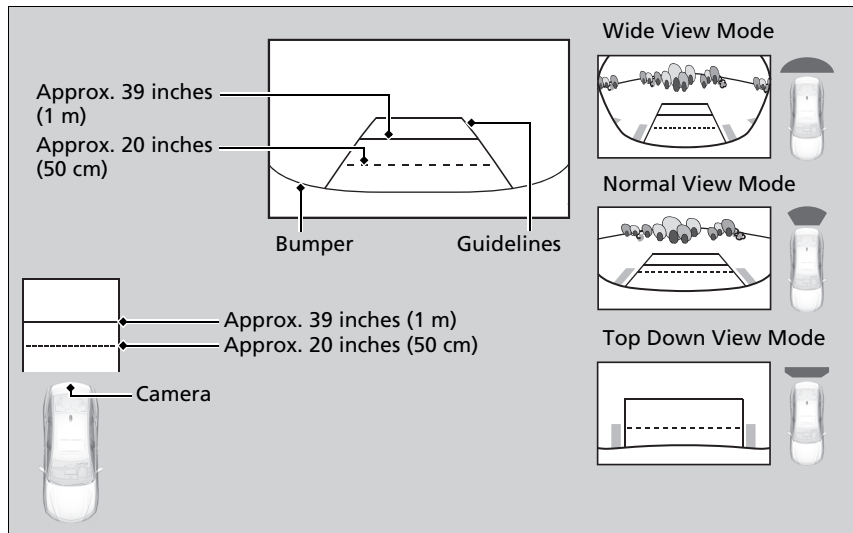

### About Your Multi-View Rear Camera

The rear camera view is restricted. You cannot see the corner ends of the bumper or what is underneath the bumper. Its unique lens also makes objects appear closer or farther than they actually are.

Visually confirm that it is safe to drive before backing up. Certain conditions (such as weather, lighting, and high temperatures) may also restrict the rear view. Do not rely on the rearview display which does not give you all information about conditions at the back of your vehicle.

If the camera lens is covered with dirt or moisture, use a soft, moist cloth to keep the lens clean and free of debris.

**Guidelines** appear when you put the transmission into **R**.

You can change the **Guidelines** setting.

➤ **Customized Features** P. 300

**Off:** Guidelines do not appear.

**Fixed:** Fixed Guidelines appear.

**Dynamic:** Guidelines that move according to the steering wheel direction appear.

**Both:** Fixed guidelines and dynamic guidelines appear.

You can view three different camera modes on the rearview display. Swipe to highlight the view mode icon and click the A-zone touchpad to change the mode.

➤ **True Touchpad Interface** P. 209

: Wide view mode

: Normal view mode

: Top down view mode

- If you were last using Wide view mode or Normal view mode, the same view mode will be activated the next time you put the transmission into **R**.
- If you were using Top down view mode before you turned off the power system, Wide view mode will be activated the next time you set the power mode to ON and put the transmission into **R**.
- If you were using Top down view mode and 10 seconds elapsed after you took the transmission out of **R**, Wide view mode will be activated the next time you put the transmission into **R**.
- If you were using Top down view mode and put the transmission back into **R** within 10 seconds after you took it out of **R**, Wide view mode will be activated.

# Surround View Camera System\*

Is a four camera system that views areas commonly known as “blind spots” from different angles, then displays the images on the audio/information screen. This system can be used to:

- Check for obstacles when you are moving in **R**.
  - **Using the Surround View Camera System** P. 509
- Check the right and left sides of the vehicle while crossing at intersections with poor visibility (obstructed view, etc.).
  - **Checking from the front wide view at intersections** P. 511
- Check for obstacles in front of the vehicle when parking or maneuvering in confined areas.
  - **Checking the sides of your vehicle** P. 511

## Surround View Camera System\*

### **WARNING**

Failure to visually assess the area around the vehicle (directly or by use of the mirrors) may result in a crash causing serious injury or death.

The areas shown in the surround view camera system display are limited. The display may not show all pedestrians or other objects around your vehicle.

Do not solely rely only on the surround view camera system display to assess whether it is safe to move your vehicle.

### **WARNING**

Failure to pay proper attention to your surroundings while driving may result in a crash causing serious injury or death.

To help mitigate the chances of a collision, only look at the surround view camera system display when it is safe to do so.

\* Not available on all models

## Displaying an Image From the Surround View Cameras

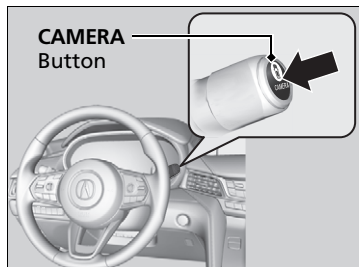

### ■ For frontal views:

Press the **CAMERA** button when the vehicle is stationary or moving at 12 mph (20 km/h) or slower. Press the button again to switch camera views.

### ■ For rear reviews:

Change the gear position to **R** when the vehicle is stationary. Press the **CAMERA** button to switch to rear view mode.

You can customize the display setting.

➤ **Customized Features** P. 300



### ▶▶ Surround View Camera System\*

The surround view camera system does not eliminate all blind spots. The system is for your convenience only.

Always keep the camera lenses clean and free from debris.

### ▶▶ Displaying an Image From the Surround View Cameras

The navigation system is disabled when the gear position is in **R**.

Pressing the  (home) or  (back) button while the surround view camera system screen is displayed cancels the front view screen of the surround view camera system.

If you press the **CAMERA** button while the vehicle speed is more than 16 mph (25 km/h), the standby screen appears.

When the vehicle speed is reduced below 12 mph (20 km/h), the screen switches to a surround view camera system image.

## ■ Camera Locations and Images

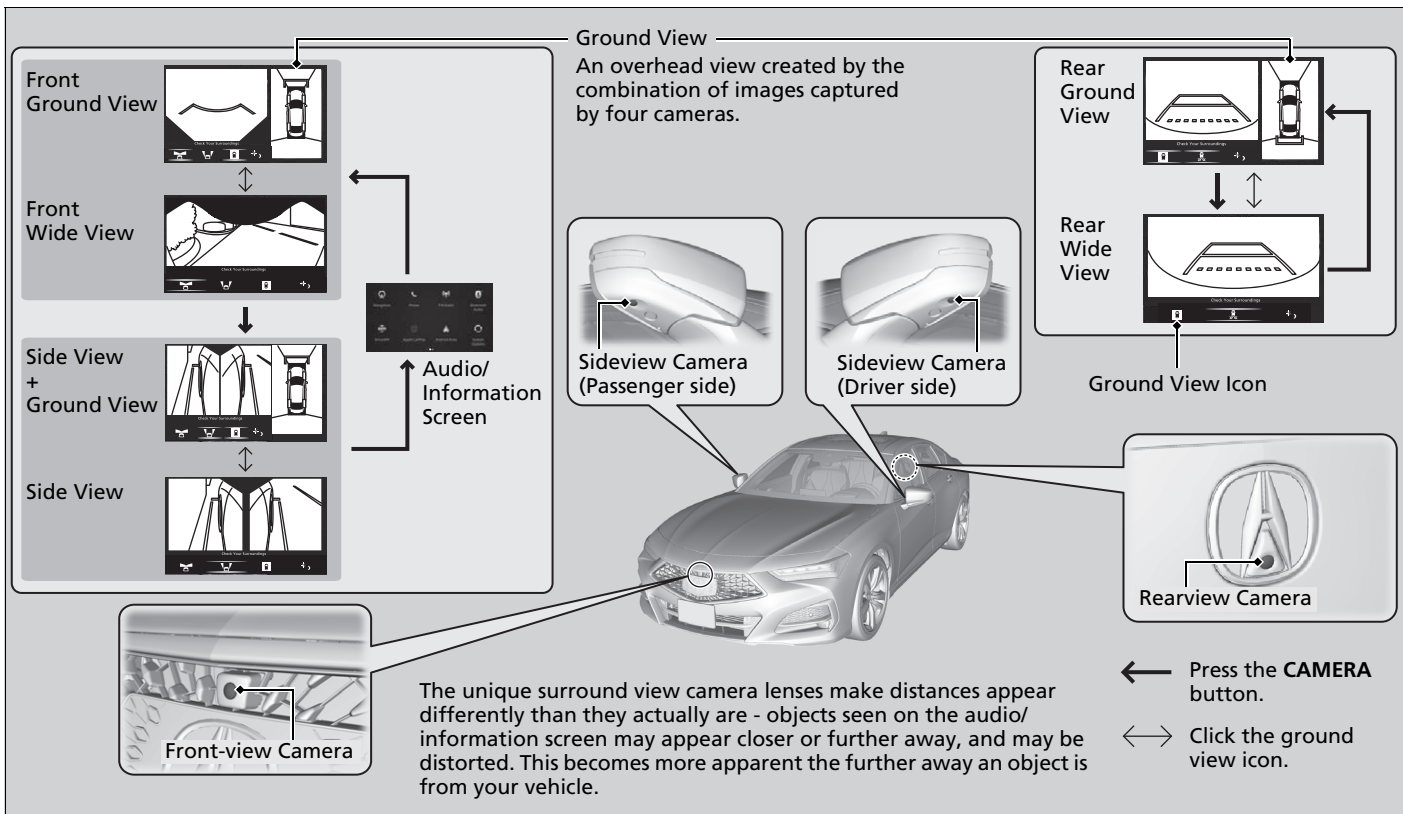

## ■ Reference Lines and Guides

The following can be displayed when the system is on.

**Guide lines:** Help you to get a sense of a distance between your vehicle and the rear surroundings. The distance may appear differently than the actual distance.

**Projection lines:** Indicate vehicle direction while the steering wheel is in the current position.

## ☒ Reference Lines and Guides

The positions/distances indicated by the guide lines and camera views on the display may differ from the actual positions/distances due to the changes in the vehicle height, road conditions, and other factors. The guide lines should be used as a reference only.

The guide lines can be turned on and off using the audio/information screen.

☒ **Customized Features** P. 300

If you turn the guide lines off, they remain off until you turn them back on.

## ■ Using the Surround View Camera System

### ■ Checking for Obstacles at the Back of Your Vehicle

The display automatically changes to the rear view when the gear position is changed to **R**.

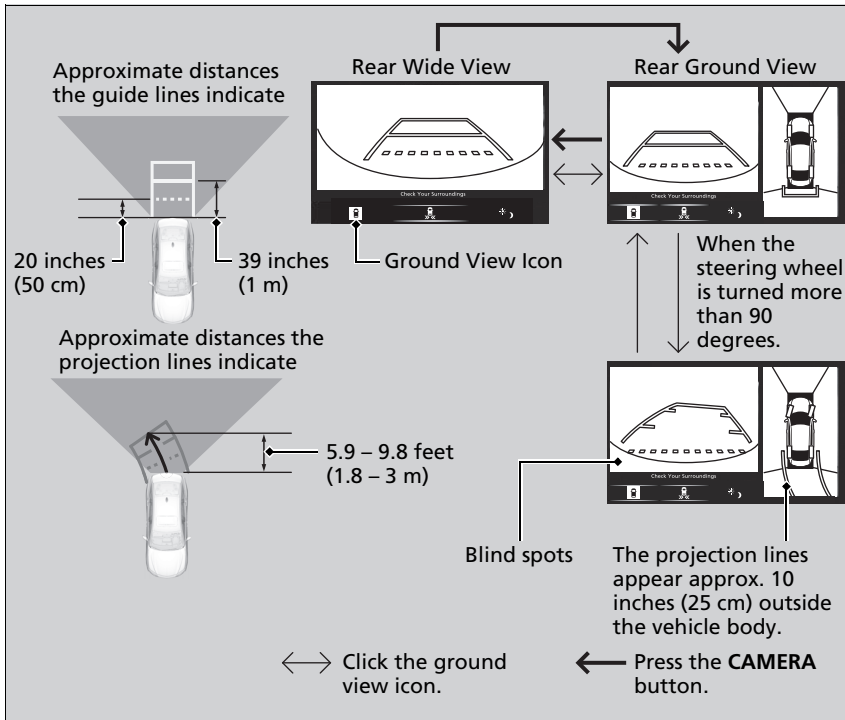

### ☒ Using the Surround View Camera System

The ground view can be displayed even with the door mirrors folded. However, the viewable angle and blind spot change.

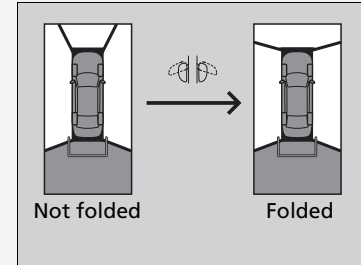

### ☒ Checking for Obstacles at the Back of Your Vehicle

When changing the gear position from/to **R**, you may experience a delay in switching between the audio/information screen and a rear view image.

### ■ Checking for the sides of your vehicle

You can display the front ground view screen using all the four cameras for the system. Pressing the **CAMERA** button when the vehicle speed is at below 12 mph (20 km/h) changes the image as follows.

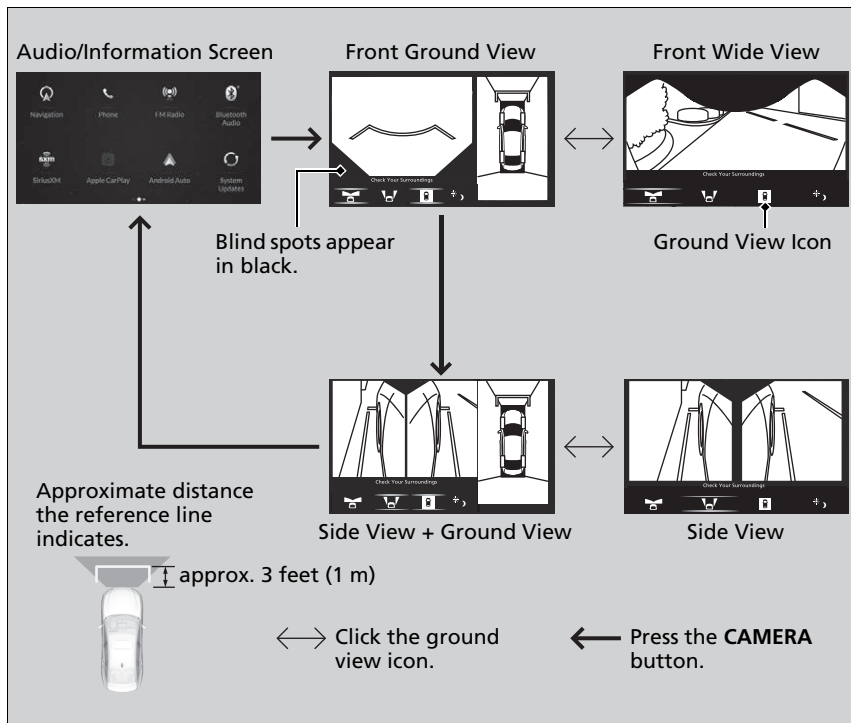

### ☒ Checking for the sides of your vehicle

If the vehicle speed exceeds 16 mph (25 km/h) while the front or side view image from the multi-view camera is displayed, the screen automatically switches to the audio/information screen.

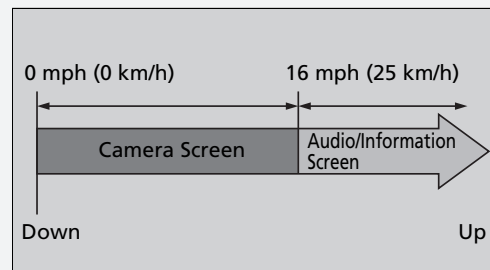



### ■ Checking from the front wide view at intersections

The front wide view screen is useful when you need to check for vehicles crossing from either direction at an intersection with poor visibility.

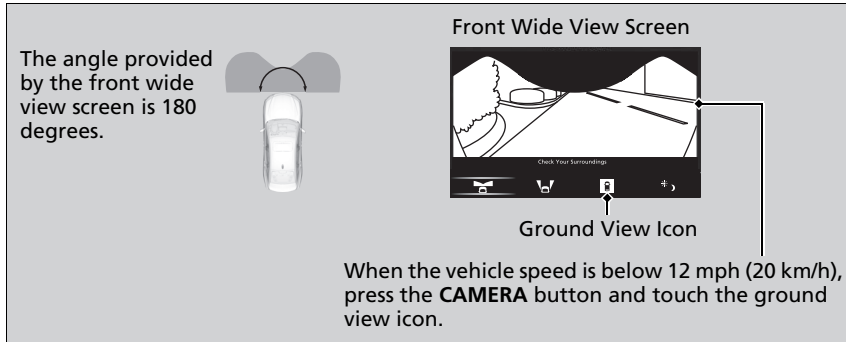

### ■ Checking the sides of your vehicle

The side view screens are convenient when you pull over at a curb or tollbooth, or slowly pass by oncoming vehicles on a narrow road.

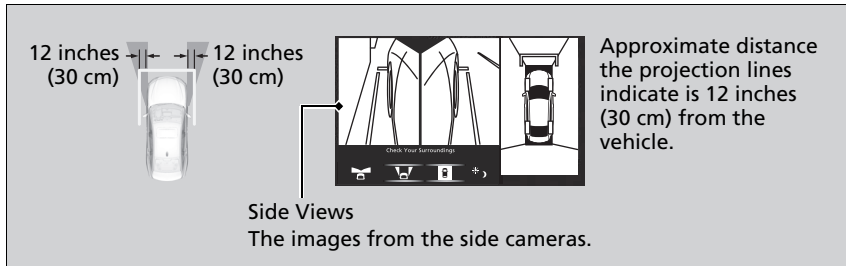

### ☒ Checking from the front wide view at intersections

The front wide view image is a wide-angled view. The displayed image will be largely distorted, and objects may appear closer or more distant than they actually are.

### ☒ Checking the sides of your vehicle

When the door mirrors are folded, the side views cannot be displayed.

**■ Surround view camera system limitations**

The system may not work properly under the following conditions.

Conditions		Solutions
The images may not appear clearly when:	<ul style="list-style-type: none"> <li>You activate the system in bad weather (heavy rain, snow, fog, etc.) or in the dark.</li> <li>Camera temperatures are high.</li> <li>A sudden change between light and dark such as an entrance or exit of a tunnel.</li> <li>You drive into the sunlight (e.g., at dawn or dusk.)</li> </ul>	Do not use the surround view camera system but rely only on visual confirmation until the conditions allow the system to work properly.
	<ul style="list-style-type: none"> <li>A camera lens is covered with dirt, moisture, or debris.</li> <li>A camera lens is scratched.</li> </ul>	Clean rear camera lenses with a soft cloth moisturized with water, mild detergent or glass cleaner.
	The audio/information screen is dirty.	Wipe off the screen using a soft dry cloth.
A camera angle is altered.	A camera or the area around the camera has been severely impacted.	Do not use the surround view camera system and contact a dealer.
The parts are replaced such as the front grille, trunk, doors, or door mirrors.		
An error message is displayed while the surround view camera system is in use.		

## Fuel Information

### ■ Fuel recommendation

#### Unleaded premium gasoline, pump octane number 91 or higher

Use of a lower octane gasoline can cause occasional metallic knocking noise in the engine and will result in decreased engine performance.

Use of a gasoline with a pump octane less than 87 can lead to engine damage. The use of regular unleaded gasoline can cause metallic knocking noises in the engine and will result in decreased engine performance.

### ■ Top tier detergent gasoline

Because the level of detergency and additives in gasoline vary in the market, Acura endorses the use of "TOP TIER Detergent Gasoline" where available to help maintain the performance and reliability of your vehicle. TOP TIER Detergent Gasoline meets a new gasoline standard jointly established by leading automotive manufacturers to meet the needs of today's advanced engines.

Qualifying gasoline retailers will, in most cases, identify their gasoline as having met "TOP TIER Detergent Gasoline" standards at the retail location. This fuel is guaranteed to contain the proper level of detergent additives and be free of metallic additives. The proper level of detergent additives, and absence of harmful metallic additives in gasoline, help avoid build-up of deposits in your engine and emission control system.

For further important fuel-related information for your vehicle, or on information on gasoline that does not contain MMT, visit Acura Owners at [owners.acura.com](http://owners.acura.com). In Canada, visit [www.acura.ca](http://www.acura.ca) for additional information on gasoline. For more information on top tier gasoline, visit [www.toptiergas.com](http://www.toptiergas.com).

### ■ Fuel tank capacity: 15.9 US gal (60 L)

#### ⌘ Fuel Information

##### NOTICE

We recommend quality gasoline containing detergent additives that help prevent fuel system and engine deposits. In addition, in order to maintain good performance, fuel economy, and emissions control, we strongly recommend the use of gasoline that does NOT contain harmful manganese-based fuel additives such as MMT, if such gasoline is available.

Use of gasoline with these additives may adversely affect performance, and cause the malfunction indicator lamp on your instrument panel to come on. If this happens, contact a dealer for service. Some gasoline today is blended with oxygenates such as ethanol. Your vehicle is designed to operate on oxygenated gasoline containing up to 15% ethanol by volume. Do not use gasoline containing methanol. If you notice any undesirable operating symptoms, try another service station or switch to another brand of gasoline.

## How to Refuel

Your fuel tank is not equipped with a fuel filler cap. You can insert the filler nozzle directly into the filler neck. The tank seals itself again when you pull out the filler nozzle.

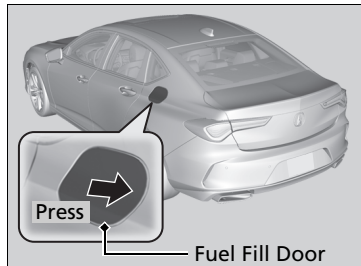

1. Stop your vehicle with the service station pump on the left side of the vehicle in the rear.
2. Turn off the engine.
3. Unlock the driver's door using the master door lock switch.
  - ▶ The fuel fill door on the outer side of the vehicle will unlock.

### 🔓 Locking/Unlocking the Doors from the Inside P. 130

4. Press and release the area indicated by the arrow to release the fuel fill door. You will hear a click and the lid will open slightly.
5. Manually pull the fuel fill door to a fully open position.

### 🔓 How to Refuel

## ⚠️ WARNING

Gasoline is highly flammable and explosive. You can be burned or seriously injured when handling fuel.

- Stop the engine, and keep heat, sparks, and flame away.
- Handle fuel only outdoors.
- Wipe up spills immediately.

The fuel filler opening is designed to accept only service station filler nozzles for refueling. Use of smaller diameter tubes (e.g., those used to siphon fuel for other uses) or other non-service station devices can damage the area in and around the filler opening.

Use the master door lock switch to unlock the fuel fill door.

The vehicle doors and fuel fill door automatically relock if the remote unlock function is used. This can be deactivated by briefly opening then closing the driver's door.

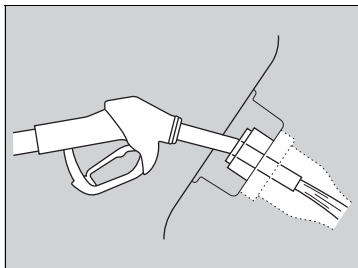

6. Place the end of the filler nozzle on the lower part of filler opening, then insert it slowly and fully.
  - ▶ Make sure that the end of the filler nozzle goes down along with the filler pipe.
  - ▶ Keep the filler nozzle level.
  - ▶ When the tank is full, the filler nozzle will click off automatically.
  - ▶ After filling, wait about five seconds before removing the filler nozzle.
7. Shut the fuel fill door by hand.

#### ▣ How to Refuel

If the filler nozzle keeps turning off when the tank is not full, there may be a problem with the pump's fuel vapor recovery system. Try filling at another pump. If this does not fix the problem, consult a dealer.

The filler nozzle automatically stops to leave space in the fuel tank so that fuel does not overflow as a result of changes in air temperature.

Do not continue to add fuel after the filler nozzle has automatically stopped. Additional fuel can exceed the full tank capacity.

If you have to refuel your vehicle from a portable container, use the funnel provided with your vehicle.

▣ **Refueling From a Portable Fuel Container**  
P. 615

## Improving Fuel Economy and Reducing CO<sub>2</sub> Emissions

Achieving fuel economy and reducing CO<sub>2</sub> emissions is dependent on several factors, including driving conditions, load weight, idling time, driving habits, and vehicle condition. Depending on these and other factors, you may not achieve the rated fuel economy of this vehicle.

### Maintenance and Fuel Economy

You can optimize your fuel economy with proper maintenance of your vehicle. Always maintain your vehicle in accordance with the messages displayed on the multi-information display.

- Use engine oil with the viscosity recommended.
  - ▣ **Recommended Engine Oil** P. 530
- Maintain the specified tire pressure.
- Do not load the vehicle with excess cargo.
- Keep your vehicle clean. A buildup of snow or mud on your vehicle's underside adds weight and increases wind resistance.

### Improving Fuel Economy and Reducing CO<sub>2</sub> Emissions

Direct calculation is the recommended method to determine actual fuel consumed while driving.



In Canada, posted fuel economy numbers are established following a simulated test. For more information on how this test is performed, please visit <https://www.nrcan.gc.ca> and search for "fuel consumption testing" in the search field at the top of the page.

# Maintenance

This chapter discusses basic maintenance.



## Before Performing Maintenance

Inspection and Maintenance .....	518
Safety When Performing Maintenance.....	519
Parts and Fluids Used in Maintenance	
Service .....	520

## Maintenance Minder™ .....

521

## Maintenance Under the Hood

Maintenance Items Under the Hood.....	527
Opening the Hood .....	528
Engine Compartment Cover.....	529
Recommended Engine Oil .....	530
Oil Check.....	531
Adding Engine Oil.....	532

Changing the Engine Oil and Oil Filter....	533
Engine Coolant.....	535
Transmission Fluid.....	537
Brake Fluid.....	538
Refilling Window Washer Fluid.....	538

## Replacing Light Bulbs .....

539

## Checking and Maintaining Wiper

### Blades .....

541

## Checking and Maintaining Tires

Checking Tires .....	544
Tire and Loading Information Label.....	545
Tire Labeling .....	545
DOT Tire Quality Grading (U.S. Vehicles)..	547

Wear Indicators .....	549
Tire Service Life .....	549
Tire and Wheel Replacement .....	550
Tire Rotation .....	551
Winter Tires .....	552
<b>Battery</b> .....	553

## Remote Transmitter Care

Replacing the Button Battery .....	557
------------------------------------	-----

## Climate Control System Maintenance .....

559

## Cleaning

Interior Care .....	560
Exterior Care.....	562

## Accessories and Modifications .....

565

## Inspection and Maintenance

For your safety, perform all listed inspections and maintenance to keep your vehicle in good condition. If you become aware of any abnormality (noise, smell, insufficient brake fluid, oil residue on the ground, etc.), have your vehicle inspected by a dealer. (Note, however, that service at a dealer is not mandatory to keep your warranties in effect.) Refer to the separate maintenance booklet for detailed maintenance and inspection information.

### Types of Inspection and Maintenance

#### ■ Daily inspections

Perform inspections before long distance trips, when washing the vehicle, or when refueling.

#### ■ Periodic inspections

- Check the brake fluid level monthly.
  - **Brake Fluid** P. 538
- Check the tire pressure monthly. Examine the tread for wear and foreign objects.
  - **Checking and Maintaining Tires** P. 544
- Check the operation of the exterior lights monthly.
  - **Replacing Light Bulbs** P. 539
- Check the condition of the wiper blades at least every six months.
  - **Checking and Maintaining Wiper Blades** P. 541

### Inspection and Maintenance

#### U.S. models

**Maintenance, replacement, or repair of emissions control devices and systems may be done by any automotive repair establishment or individuals using parts that are “certified” to EPA standards.**

According to state and federal regulations, failure to perform maintenance on the maintenance main items marked with # will not void your emissions warranties. However, all maintenance services should be performed in accordance with the intervals indicated by the multi-information display.

➤ **Maintenance Service Items** P. 524

If you want to perform complex maintenance tasks that require more skills and tools, you can purchase a subscription to the Service Express website at [www.techinfo.acura.com](http://www.techinfo.acura.com).

➤ **Authorized Manuals** P. 628

If you want to perform maintenance yourself, make sure that you have the necessary tools and skills first. After performing maintenance, update the records in the separate maintenance booklet.



## Safety When Performing Maintenance

Some of the most important safety precautions are given here. However, we cannot warn you of every conceivable hazard that can arise in performing maintenance. Only you can decide whether you should perform a given task.

### Maintenance Safety

- To reduce the possibility of fire or explosion, keep cigarettes, sparks, and flames away from the battery and all fuel related parts.
- Never leave rags, towels, or other flammable objects under the hood.
  - ▶ Heat from the engine and exhaust can ignite them, causing a fire.
- To clean parts, use a commercially available degreaser or parts cleaner, not gasoline.
- Wear eye protection and protective clothing when working with the battery or compressed air.
- Engine exhaust contains carbon monoxide, which is poisonous and can kill you.
  - ▶ Only operate the engine if there is sufficient ventilation.

### Vehicle Safety

- The vehicle must be in a stationary condition.
  - ▶ Make sure your vehicle is parked on level ground, the parking brake is set, and the engine is off.
- Be aware that hot parts can burn you.
  - ▶ Make sure to let the engine and exhaust system cool thoroughly before touching vehicle parts.
- Be aware that moving parts can injure you.
  - ▶ Do not start the engine unless instructed, and keep your hands and limbs away from moving parts.
  - ▶ Do not open the hood while the Auto Idle Stop function is activated.

#### ⚠ Safety When Performing Maintenance

### ⚠ WARNING

Improperly maintaining this vehicle or failing to correct a problem before driving can cause a crash in which you can be seriously hurt or killed.

Always follow the inspection and maintenance recommendations according to the schedules in this owner's manual.

### ⚠ WARNING

Failure to properly follow maintenance instructions and precautions can cause you to be seriously hurt or killed.

Always follow the procedures and precautions in this owner's manual.

## Parts and Fluids Used in Maintenance Service

---

The use of Acura genuine parts and fluids is recommended when maintaining and servicing your vehicle. Acura genuine parts are manufactured according to the same high quality standards used in Acura vehicles.

### ▶ Parts and Fluids Used in Maintenance Service

---

#### **NOTICE**

Do not press the engine cover forcibly. This may damage the engine cover and component parts.

If the engine oil life is less than 15%, you will see the Maintenance Minder messages appear on the multi-information display every time you set the power mode to ON. The messages notify you when to change the engine oil, or when to bring your vehicle to a dealer for indicated maintenance services.

## To Use Maintenance Minder™

### ■ Displaying the Maintenance Minder Information

Maintenance items, which should be serviced at the same time that you replace the engine oil, appear on the multi-information display.

You can view them on the engine oil life screen at any time.

1. Set the power mode to ON.
2. Press the right selector wheel until the content is displayed.
3. Roll the right selector wheel until the **Maintenance** screen is displayed. The engine oil life appears on the multi-information display along with maintenance items due soon.

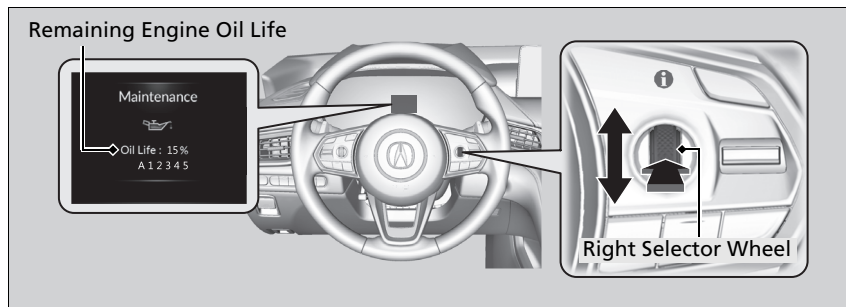

### ▣ Displaying the Maintenance Minder Information





Based on the engine operating conditions, the remaining engine oil life is calculated and displayed as a percentage.

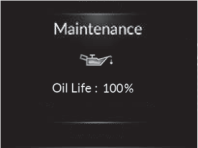

Displayed Engine Oil Life (%)	Calculated Engine Oil Life (%)
100	100 to 91
90	90 to 81
80	80 to 71
70	70 to 61
60	60 to 51
50	50 to 41
40	40 to 31
30	30 to 21
20	20 to 16
15	15 to 11
10	10 to 6
5	5 to 1
0	0

There is a list of maintenance main and sub items you can view on the multi-information display.

▣ **Maintenance Service Items** P. 524

## Maintenance Minder Messages on the Multi-Information Display

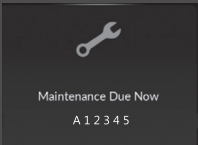
Maintenance Message	Oil Life Display	Explanation	Information
		When you select the <b>Maintenance</b> screen, it displays codes for maintenance items due at the next engine oil change, along with the percentage of engine oil life remaining.	
<b>Maintenance Due Soon</b>  Maintenance Due Soon A 1 2 3 4 5	15% 	The remaining engine oil life is 15 to 6 percent. Once you switch the display by rolling the right selector wheel, this message will go off.	The engine oil is approaching the end of its service life, and the maintenance items should be inspected and serviced soon.

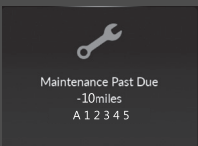
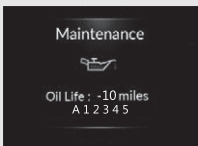
Maintenance Message	Oil Life Display	Explanation	Information
<p><b>Maintenance Due Now</b></p> 	<p>5%</p> 	<p>The remaining engine oil life is 5 to 1 percent. Roll the right selector wheel to switch to another display.</p>	<p>The engine oil has almost reached the end of its service life, and the maintenance items should be inspected and serviced as soon as possible.</p>
<p><b>Maintenance Past Due</b></p> 	<p>Negative Distance</p> 	<p>The remaining engine oil life has passed its service life, and a negative distance appears. Roll the right selector wheel to switch to another display.</p>	<p>The engine oil life has passed. The maintenance items must be inspected and serviced immediately.</p>

The maintenance minder indicator (🔧) comes on along with the Maintenance message.

## Maintenance Service Items

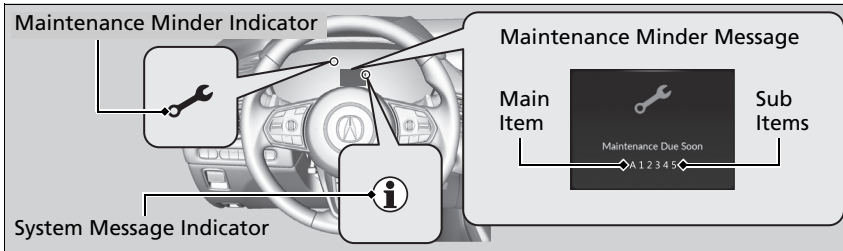

### U.S. models

CODE	Maintenance Main Items
A	<ul style="list-style-type: none"> <li>• Replace engine oil*<sup>1</sup></li> </ul>
B	<ul style="list-style-type: none"> <li>• Replace engine oil*<sup>1</sup> and oil filter</li> <li>• Inspect front and rear brakes</li> <li>• Check expiration date for Temporary Tire Repair Kit bottle (if equipped)</li> <li>• Inspect tie rod ends, steering gearbox, and boots</li> <li>• Inspect suspension components</li> <li>• Inspect driveshaft boots</li> <li>• Inspect brake hoses and lines (Including ABS/VSA®)</li> <li>• Inspect all fluid levels and condition of fluids</li> <li>• Inspect exhaust system<sup>#</sup></li> <li>• Inspect fuel lines and connections<sup>#</sup></li> </ul>

\*1: If a Maintenance Minder Indicator and message does not appear more than 12 months after the display is reset, change the engine oil every year.

#: See information on maintenance and emissions warranty.

\*2: If you drive in dusty conditions, replace the air cleaner element every 15,000 miles (24,000 km).

### Maintenance Service Items

- Adjust the valves during services A, B, 1, 2, or 3 if they are noisy.

CODE	Maintenance Sub Items
1	<ul style="list-style-type: none"> <li>• Rotate tires</li> </ul>
2	<ul style="list-style-type: none"> <li>• Replace air cleaner element*<sup>2</sup></li> <li>• Replace dust and pollen filter*<sup>3</sup></li> <li>• Inspect drive belt</li> </ul>
3	<ul style="list-style-type: none"> <li>• Replace transmission fluid and transfer* fluid</li> </ul>
4	<ul style="list-style-type: none"> <li>• Replace spark plugs</li> <li>• Inspect valve clearance</li> </ul>
5	<ul style="list-style-type: none"> <li>• Replace engine coolant</li> </ul>
6	<ul style="list-style-type: none"> <li>• Replace rear differential fluid*<sup>4</sup></li> </ul>
7	<ul style="list-style-type: none"> <li>• Replace brake fluid*<sup>5</sup></li> </ul>

\*3: If you drive primarily in urban areas that have high concentrations of soot in the air from industry and from diesel-powered vehicles, replace the dust and pollen filter every 15,000 miles (24,000 km).

\*4: Driving in mountainous areas at very low vehicle speeds results in higher level of mechanical (Shear) stress to fluid. This requires differential fluid changes more frequently than recommended by the Maintenance Minder. If you regularly drive your vehicle under these conditions, have the differential fluid changed at 7,500 miles (12,000 km), then every 15,000 miles (24,000 km).

\*5: If a Maintenance Minder Indicator does not appear more than 36 months after the display for item 7 is reset, change the brake fluid every 3 years.

**Canadian models**

▣ Maintenance Service Items

- Adjust the valves during services A, 0, 9, 1, 2, or 3 if they are noisy.

CODE	Maintenance Main Items
A	• Replace engine oil* <sup>1</sup>
0	• Replace engine oil* <sup>1</sup> and oil filter

- \*1: If a Maintenance Minder Indicator and message does not appear more than 12 months after the display is reset, change the engine oil every year.
- \*2: If you drive in dusty conditions, replace the air cleaner element every 24,000 km (15,000 miles).
- \*3: If you drive primarily in urban areas that have high concentrations of soot in the air from industry and from diesel-powered vehicles, replace the dust and pollen filter every 24,000 km (15,000 miles).
- \*4: Driving in mountainous areas at very low vehicle speeds results in higher level of mechanical (Shear) stress to fluid. This requires differential fluid changes more frequently than recommended by the Maintenance Minder.  
If you regularly drive your vehicle under these conditions, have the differential fluid changed at 12,000 km (7,500 miles), then every 24,000 km (15,000 miles).
- \*5: If a Maintenance Minder Indicator does not appear more than 36 months after the display for item 7 is reset, change the brake fluid every 3 years.
- # : See information on maintenance and emissions warranty.

CODE	Maintenance Sub Items
1	• Rotate tires
2	• Replace air cleaner element* <sup>2</sup> • Replace dust and pollen filter* <sup>3</sup> • Inspect drive belt
3	• Replace transmission fluid and transfer fluid
4	• Replace spark plugs • Inspect valve clearance
5	• Replace engine coolant
6	• Replace rear differential fluid* <sup>4</sup>
7	• Replace brake fluid* <sup>5</sup>
9	• Service front and rear brakes • Check expiration date for Temporary Tire Repair Kit bottle (If equipped) • Inspect these items: <ul style="list-style-type: none"> <li>• Tie rod ends, steering gearbox, and boots</li> <li>• Suspension components</li> <li>• Driveshaft boots</li> <li>• Brake hoses and lines (including ABS/VSA®)</li> <li>• All fluid levels and condition of fluids</li> <li>• Exhaust system#</li> <li>• Fuel lines and connections#</li> </ul>

## ■ Resetting the Display

Reset the maintenance minder information display if you have performed the maintenance service.

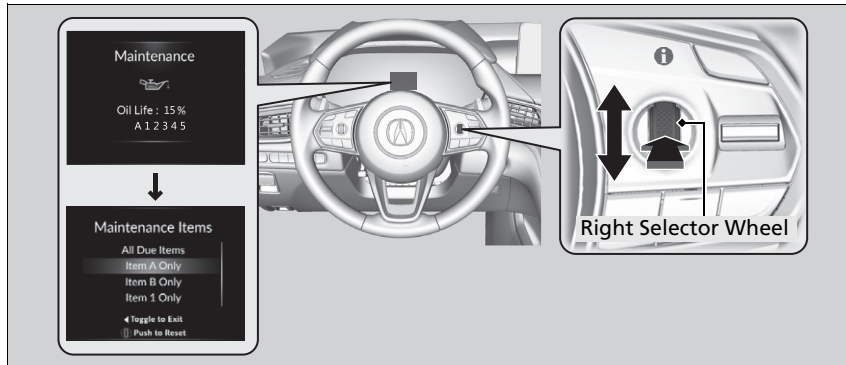

1. Set the power mode to ON.
2. Press the right selector wheel until the content is displayed.
3. Roll the right selector wheel until the **Maintenance** screen is displayed.
4. Press and hold the right selector wheel for about 10 seconds to enter the reset mode.
5. Roll the right selector wheel to select a maintenance item to reset, or to select **All Due Items** (You can also move the right selector wheel to the left to end the process).
6. Press the right selector wheel to reset the selected item.
7. Repeat from step 4 for other items you wish to reset.

## ►► Resetting the Display

### NOTICE

Failure to reset the Maintenance Minder™ display after a maintenance service results in the system showing incorrect maintenance intervals, which can lead to serious mechanical problems.

The dealer will reset the Maintenance Minder™ display after completing the required maintenance service. If someone other than a dealer performs maintenance service, reset the Maintenance Minder™ display yourself.

You can also reset the Maintenance Minder™ display using the audio/information screen.

► **Customized Features** P. 300



## Maintenance Items Under the Hood

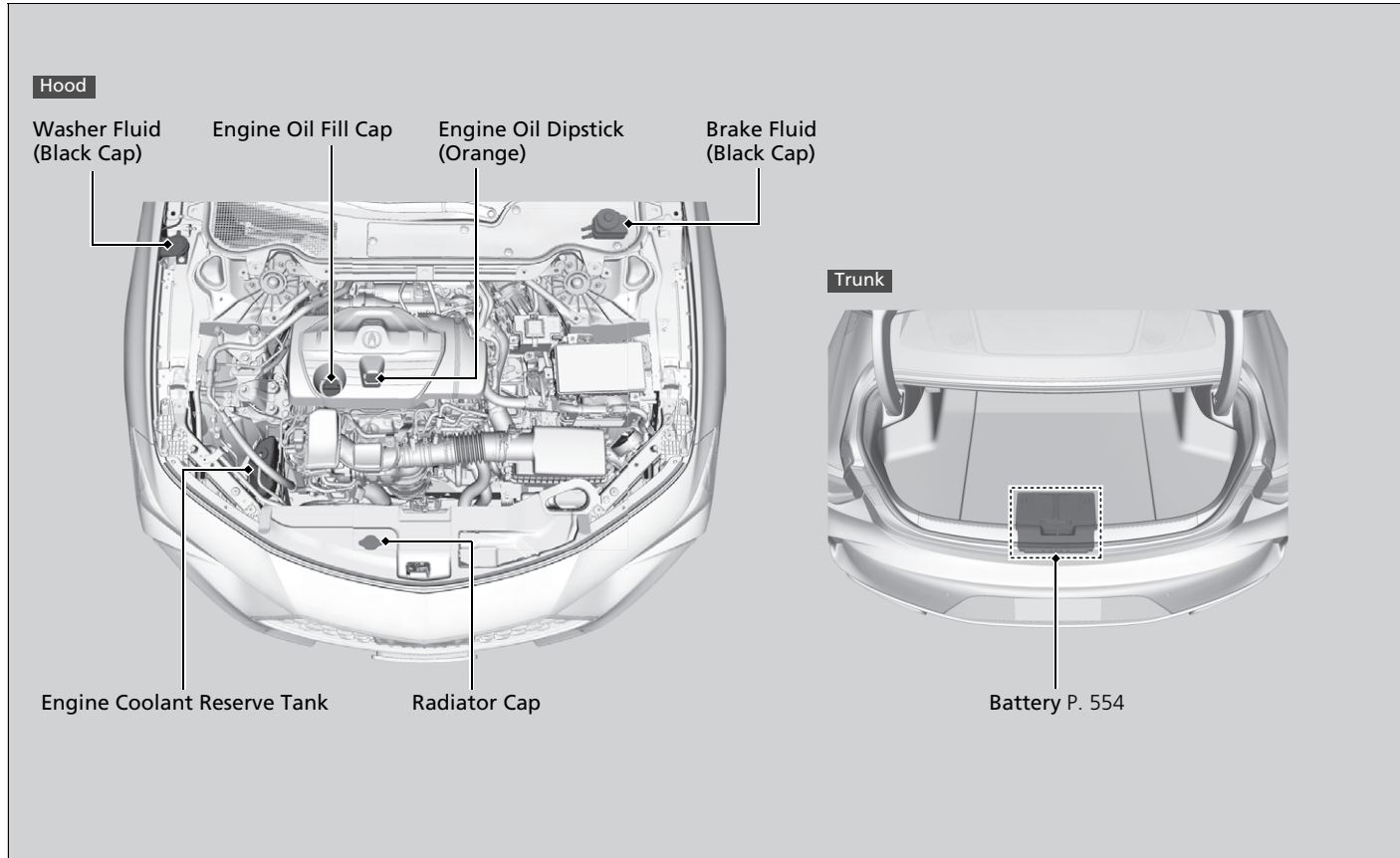

## Opening the Hood

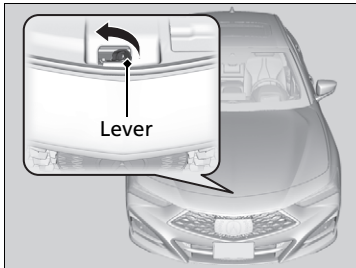

1. Park the vehicle on a level surface, and set the parking brake.
2. Pull the hood release handle under the driver's side lower corner of the dashboard.
  - The hood will pop up slightly.
3. Push the hood latch lever (located under the front edge of the hood to the center) to the side and raise the hood. Once you have raised the hood slightly, you can release the lever.
4. Lift the hood up most of the way.
  - The hydraulic supports will lift it up the rest of the way and hold it up.

When closing, lower it to approximately 12 inches (30 cm), then press down firmly with your hands.

### ►► Opening the Hood

#### NOTICE

Do not open the hood when the wiper arms are raised. The hood will strike the wipers, resulting in possible damage to the hood and/or the wipers.

#### NOTICE

Do not press the engine cover forcibly. This may damage the engine cover and component parts.

When closing the hood, check that the hood is securely latched.

If the hood latch lever moves stiffly, or if you can open the hood without lifting the lever, the latch mechanism should be cleaned and lubricated.

Do not open the hood while the Auto Idle Stop function is activated.

## Engine Compartment Cover

The component parts in the engine compartment are protected by a cover. You may need to remove the cover when you perform certain maintenance work.

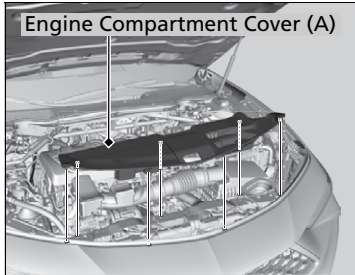

Engine Compartment Cover (A)

### Engine Compartment Cover (A)

Pull up on the engine compartment cover carefully until all pins are removed from their grommets.

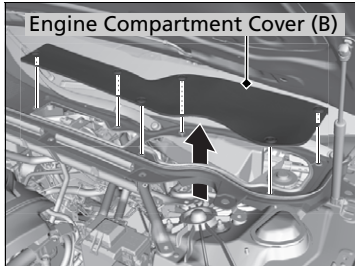

Engine Compartment Cover (B)

### Engine Compartment Cover (B)

Release the all holding clips, and then push up the engine compartment cover.

- The holding clips shall remain attached to the engine compartment cover.

### Engine Compartment Cover (B)

#### Holding clip

To release:  
Push down the center pin of the clip.

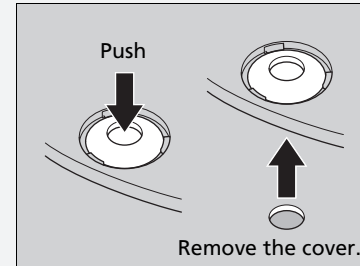

To lock:

Before returning cover to engine compartment, push until the center pin is raised. In that state, return the engine compartment cover and then push the center pin until the pin is flat.

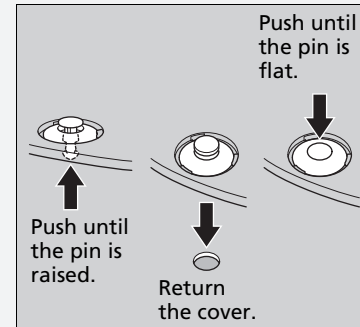

## Recommended Engine Oil

Use a genuine engine oil or another commercial engine oil of suitable type and viscosity (for the ambient temperature) as shown in the image that follows.

Oil is a major contributor to your engine’s performance and longevity. If you drive the vehicle with insufficient or deteriorated oil, the engine may fail or be damaged.

Genuine Engine Oil	Commercial Engine Oil
<ul style="list-style-type: none"> <li>• Acura Genuine Motor Oil</li> </ul>	<ul style="list-style-type: none"> <li>• Premium-grade 0W-20 detergent oil with an API Certification Seal on the container.</li> </ul>
<p style="text-align: center;">Ambient Temperature</p>	<p style="text-align: center;">Ambient Temperature</p>

\*1: Formulated to improve fuel economy.

### ■ Synthetic oil

You may also use synthetic motor oil if it is labeled with the API Certification Seal and is the specified viscosity grade.

### ►► Recommended Engine Oil

#### Engine Oil Additives

Your vehicle does not require oil additives. In fact, they may adversely affect the engine performance and durability.

The following seal indicates the oil is energy conserving and that it meets the American Petroleum Institute’s latest requirements.



## Oil Check

We recommend that you check the engine oil level every time you refuel.

Park the vehicle on level ground.

Wait approximately three minutes after turning the engine off before you check the oil.

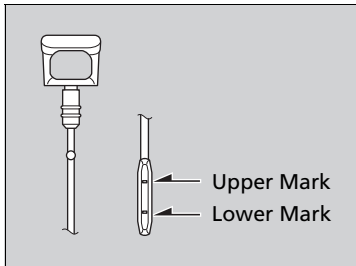
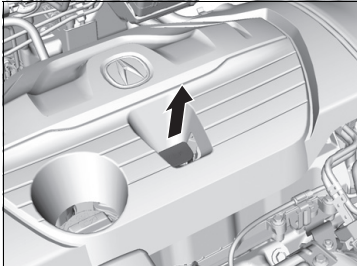

1. Remove the dipstick (orange).
2. Wipe the dipstick with a clean cloth or paper towel.
3. Insert the dipstick back all the way into its hole.
4. Remove the dipstick again, and check the level. It should be between the upper and lower marks. Add oil if necessary.

### Oil Check

If the oil level is near or below the lower mark, slowly add oil, being careful not to overfill.

## Adding Engine Oil

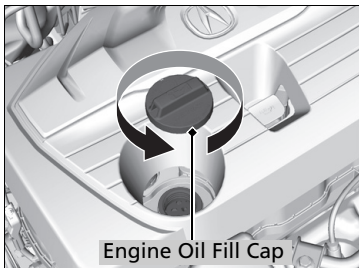

1. Unscrew and remove the engine oil fill cap.
2. Add oil slowly.
3. Reinstall the engine oil fill cap, and tighten it securely.
4. Wait for three minutes and recheck the engine oil dipstick.

### ► Adding Engine Oil

#### NOTICE

Do not fill the engine oil above the upper mark. Overfilling the engine oil may result in leaks and engine damage.

If any oil spills, wipe it away immediately. Spilled oil may damage the engine compartment components.

## Changing the Engine Oil and Oil Filter

You must change the engine oil and oil filter regularly in order to maintain the engine's lubrication. The engine may be damaged if they are not changed regularly.

Change the oil and filter in accordance with the maintenance message on the multi-information display.

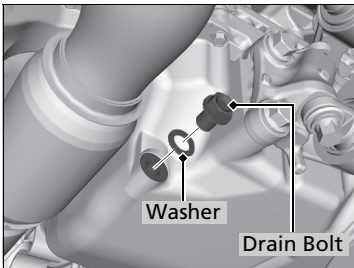
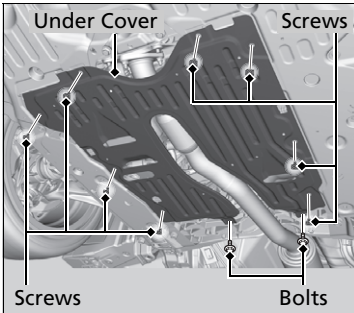

1. Run the engine until it reaches normal operating temperature, and then turn the engine off.
2. Open the hood and remove the engine oil fill cap.
3. Remove the screws and bolts on the undercarriage by turning counterclockwise and remove the under cover.
4. Remove the drain bolt and washer from the bottom of the engine, and drain the oil into a suitable container.

### Changing the Engine Oil and Oil Filter

#### NOTICE

You may damage the environment if you do not dispose of the oil in a suitable way. If you are changing the oil by yourself, appropriately dispose of the used oil. Put the oil in a sealed container and take it to a recycling center. Do not throw the oil away into a garbage can or onto the ground.

You will need a special wrench to replace the oil filter. You can buy this wrench from a dealer.

When installing the new oil filter, follow the instructions supplied with the oil filter.

Reinstall the engine oil fill cap. Start the engine. If the low oil pressure warning appears, turn off the engine, and check your work.

Continued

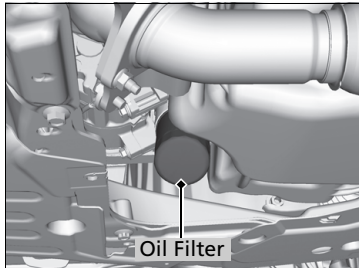

5. Remove the oil filter and dispose of the remaining oil.
6. Check that the filter gasket is not stuck to the engine contact surface.
  - If it is stuck, you must detach it.
7. Wipe away dirt and dust adhering to the contact surface of the engine block, and install a new oil filter.
  - Apply a light coat of new engine oil to the filter gasket.
8. Put a new washer on the drain bolt, then reinstall the drain bolt.
  - Tightening torque:  
30 lbf·ft (40 N·m, 4.0 kgf·m)
9. Pour the recommended engine oil into the engine.
  - Engine oil change capacity (including filter):  
5.0 US qt (4.8 L)
10. Reinstall the engine oil fill cap securely and start the engine.
11. Run the engine for a few minutes, and then check that there is no leak from the drain bolt or oil filter.
12. Stop the engine, wait for three minutes, and then check the oil level on the dipstick.
  - If necessary, add more engine oil.



## Engine Coolant

### Specified coolant: Acura Long Life Antifreeze/Coolant Type 2

This coolant is premixed with 50% antifreeze and 50% water. Do not add any straight antifreeze or water.

We recommend you check the engine coolant level every time you refuel. Check the reserve tank first. If it is completely empty, also check the coolant level in the radiator. Add the engine coolant accordingly.

### Reserve Tank

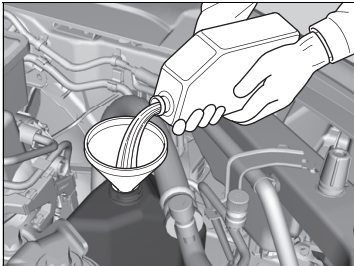
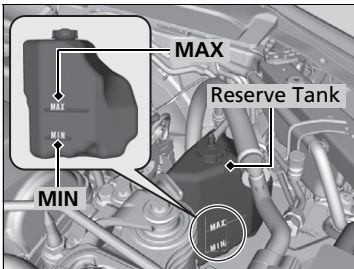

1. **Make sure the engine and radiator are cool.**
2. Check the amount of coolant in the reserve tank.
  - If the coolant level is below the **MIN** mark, add the specified coolant until it reaches the **MAX** mark.
3. Inspect the cooling system for leaks.

### Engine Coolant

## ⚠ WARNING

Removing the radiator cap while the engine is hot can cause the coolant to spray out, seriously scalding you.

Always let the engine and radiator cool down before removing the radiator cap.

### NOTICE

Genuine Acura engine coolant is a 50/50 mixture of antifreeze and water that can withstand freezing at temperatures as low as about  $-31^{\circ}\text{F}$  ( $-35^{\circ}\text{C}$ ). If your vehicle is consistently subjected to temperatures below this, the concentration of antifreeze in the coolant should be increased. Consult a dealer for details.

If Acura antifreeze/coolant is not available, you may use another major brand of non-silicate coolant as a temporary replacement. Check that it is a high quality coolant recommended for aluminum engines. Continued use of any non-Acura coolant can result in corrosion, causing the cooling system to malfunction or fail. Have the cooling system flushed and refilled with Acura antifreeze/coolant as soon as possible.

Do not add rust inhibitors or other additives to your vehicle's cooling system. They may not be compatible with the coolant or with the engine components.

Continued

## ■ Radiator

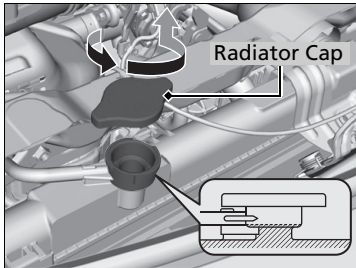

1. **Make sure the engine and radiator are cool.**
2. Remove the engine compartment cover (A).  
    **🔧 Engine Compartment Cover** P. 529
3. Turn the radiator cap 1/8 turn counterclockwise and relieve any pressure in the cooling system.
4. Turn the radiator cap counterclockwise to remove it.
5. The coolant level should be up to the base of the filler neck. Add coolant if it is low.
6. Put the radiator cap back on, and tighten it fully.

## 🔧 Radiator

### NOTICE

Pour the fluid slowly and carefully so you do not spill any. Clean up any spills immediately; they can damage components in the engine compartment.

## Transmission Fluid

### Automatic Transmission Fluid

**Specified fluid: Acura ATF-type 2.0**

Have a dealer check the fluid level and replace if necessary.

Do not attempt to check or change the automatic transmission fluid yourself.

#### Automatic Transmission Fluid

##### NOTICE

**Do not mix Acura ATF-type 2.0 with other transmission fluids.**

Using a transmission fluid other than Acura ATF-type 2.0 may adversely affect the operation and durability of your vehicle's transmission, and damage the transmission.

Any damage caused by using a transmission fluid that is not equivalent to Acura ATF-type 2.0 is not covered by Acura's new vehicle limited warranty.

## Brake Fluid

**Specified fluid: Acura Heavy Duty Brake Fluid DOT 3**

### ■ Checking the Brake Fluid

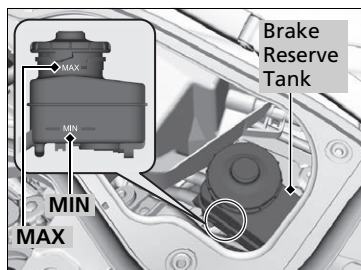

When checking the brake fluid, remove the engine compartment cover (B).

➤ **Engine Compartment Cover** P. 529

The fluid level should be between the **MIN** and **MAX** marks on the side of the reserve tank.

### Refilling Window Washer Fluid

Check the amount of window washer fluid.

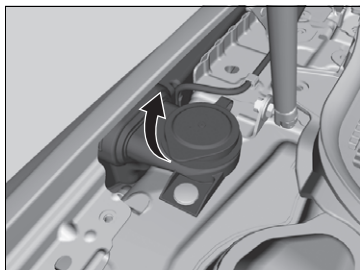

**All models**

Pour the washer fluid carefully. Do not overflow the reservoir.

If the level is low, fill the washer reservoir.

**Canadian models**

If the washer fluid is low, a message appears on the multi-information display.

### » Brake Fluid

#### **NOTICE**

Brake fluid marked DOT 5 is not compatible with your vehicle's braking system and can cause extensive damage.

If the specified brake fluid is not available, you should use only DOT 3 or DOT 4 fluid from a sealed container as a temporary replacement.

Using any non-Acura brake fluid can cause corrosion and decrease the longevity of the system. Have the brake system flushed and refilled with Acura Heavy Duty Brake Fluid DOT 3 as soon as possible.

If the brake fluid level is at or below the **MIN** mark, have a dealer inspect the vehicle for leaks or worn brake pads as soon as possible.

### » Refilling Window Washer Fluid

#### **NOTICE**

Do not use engine antifreeze or a vinegar/water solution in the windshield washer reservoir. Antifreeze can damage your vehicle's paint. A vinegar/water solution can damage the windshield washer pump.

Use only commercially available windshield washer fluid.

Avoid prolonged use of hard water to prevent lime scale build up.

## Headlights

---

Headlights are LED type. Have an authorized Acura dealer inspect and replace the light assembly.

## Fog Lights \*

---

Fog lights are LED type. Have an authorized Acura dealer inspect and replace the light assembly.

## Front Turn Signal, Parking/Daytime Running and Front Side Marker Lights

---

Front turn signal, parking/daytime running and front side marker lights are LED type. Have an authorized Acura dealer inspect and replace the light assembly.

## Side Turn Signal/Emergency Indicator Lights

---

Door mirror side turn lights are LED type. Have an authorized Acura dealer inspect and replace the light assembly.

### Headlights

The headlight aim is set by the factory, and does not need to be adjusted. However, if you regularly carry heavy items in the trunk, have the aiming readjusted at a dealer or by a qualified technician.

\* Not available on all models

## **Brake, Rear Turn Signal and Taillight/Rear Side Marker Lights**

---

Brake, rear turn signal and taillight/rear side marker lights are LED type. Have an authorized Acura dealer inspect and replace the light assembly.

## **Taillights and Back-Up Lights**

---

Taillights and back-up lights are LED type. Have an authorized Acura dealer inspect and replace the light assembly.

## **Rear License Plate Light**

---

Rear license plate light is LED type. Have an authorized Acura dealer inspect and replace the light assembly.

## **High-Mount Brake Light**

---

High-mount brake light is LED type. Have an authorized Acura dealer inspect and replace the light assembly.

## **Puddle Lights\***

---

Puddle lights are LED type. Have an authorized Acura dealer inspect and replace the light assembly.

## Checking Wiper Blades

If the wiper blade rubber has deteriorated, it will leave streaks, become noisy, and the hard surfaces of the blade may scratch the window glass.

## Changing the Wiper Blade Rubber

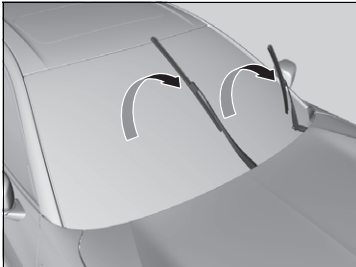
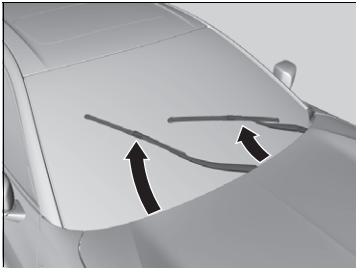

1. Set the power mode to VEHICLE OFF.
2. While holding the wiper switch in the **MIST** position, set the power mode to ON, then to VEHICLE OFF.
  - ▶ Both wiper arms are set to the maintenance position as shown in the image.
3. Lift both wiper arms.

### Changing the Wiper Blade Rubber

#### NOTICE

Avoid dropping the wiper arm onto the windshield, it may damage the wiper arm and/or the windshield.

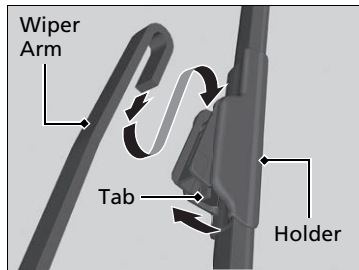

**4.** Press up on and hold the tab, then slide the holder off the wiper arm.

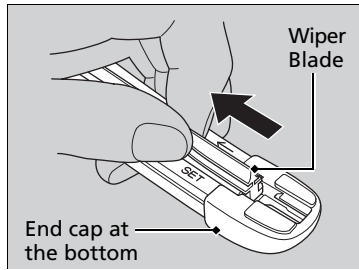

**5.** Pull the end of the wiper blade in the direction of the arrow in the image until it is out of the holder's end cap.

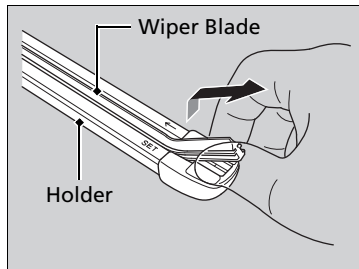

**6.** Pull the wiper blade in the opposite direction to slide it out of the holder.



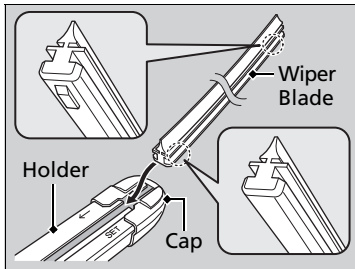

7. Insert the flat side of the new wiper blade onto the bottom part of the holder. Insert the blade all the way.
8. Install the end of the wiper blade into the cap.
9. Slide the holder onto the wiper arm until it locks.
10. Lower both wiper arms.
11. Set the power mode to ON and hold the wiper switch in the **MIST** position until both wiper arms return to the standard position.

## Checking Tires

To safely operate your vehicle, your tires must be of the proper type and size, in good condition with adequate tread, and properly inflated.

### ■ Inflation guidelines

Properly inflated tires provide the best combination of handling, tread life, and comfort. Refer to the driver's doorjamb label or specifications page for the specified pressure.

Underinflated tires wear unevenly, adversely affect handling and fuel economy, and are more likely to fail from overheating.

Overinflated tires make your vehicle ride harshly, are more prone to road hazards, and wear unevenly.

Every day before you drive, look at each of the tires. If one looks lower than the others, check the pressure with a tire gauge.

At least once a month or before long trips, use a gauge to measure the pressure in all tires, including the spare\*. Even tires in good condition can lose 1–2 psi (10–20 kPa, 0.1–0.2 kgf/cm<sup>2</sup>) per month.

### ■ Inspection guidelines

Every time you check inflation, also examine the tires and valve stems. Look for:

- Bumps or bulges on the side or in the tread. Replace the tire if you find any cuts, splits, or cracks in the side of the tire. Replace it if you see fabric or cord.
- Remove any foreign objects and inspect for air leaks.
- Uneven tread wear. Have a dealer check the wheel alignment.
- Excessive tread wear.

➤ **Wear Indicators** P. 549

- Cracks or other damage around valve stem.

\* Not available on all models

### ☞ Checking Tires

## ⚠ WARNING

Using tires that are excessively worn or improperly inflated can cause a crash in which you can be seriously hurt or killed.

Follow all instructions in this owner's manual regarding tire inflation and maintenance.

Measure the air pressure when tires are cold. This means the vehicle has been parked for at least three hours, or driven less than 1 mile (1.6 km). If necessary, add or release air until the specified pressure is reached.

If checked when hot, tire pressure can be as much as 4–6 psi (30–40 kPa, 0.3–0.4 kgf/cm<sup>2</sup>) higher than if checked when cold.

➤ **Tire Fill Assist** P. 406

Have a dealer check the tires if you feel a consistent vibration while driving. New tires and any that have been removed and reinstalled should be properly balanced.

## Tire and Loading Information Label

The label attached to the driver's doorjamb provides necessary tire and loading information.

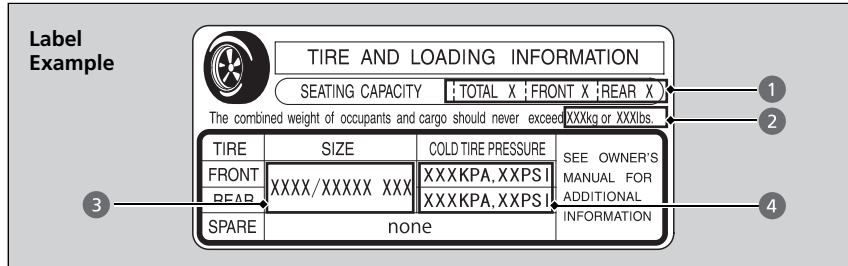

### ☒ Tire and Loading Information Label

The tire and loading information label attached to the driver's doorjamb contains:

- 1 The number of people your vehicle can carry.
- 2 The total weight your vehicle can carry. Do not exceed this weight.
- 3 The original tire sizes for front, rear, and spare.
- 4 The proper cold tire pressure for front, rear, and spare.

## Tire Labeling

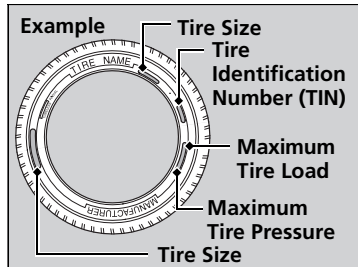

The tires that came on your vehicle have a number of markings. Those you should be aware of are described as shown.

### ☒ Tire Sizes

Following is an example of tire size with an explanation of what each component means.

#### **P235/60 R18 102T**

P: Vehicle type (P indicates passenger vehicle).

235: Tire width in millimeters.

60: Aspect ratio (the tire's section height as a percentage of its width).

R: Tire construction code (R indicates radial).

18: Rim diameter in inches.

102: Load index (a numerical code associated with the maximum load the tire can carry).

T: Speed symbol (an alphabetical code indicating the maximum speed rating).

### ■ Tire Sizes

Whenever tires are replaced, they should be replaced with tires of the same size.

Continued

## ■ Tire Identification Number (TIN)

The tire identification number (TIN) is a group of numbers and letters that look like the example in the side column. TIN is located on the sidewall of the tire.

## ■ Glossary of Tire Terminology

**Cold Tire Pressure** – The tire air pressure when the vehicle has been parked for at least three hours or driven less than 1 mile (1.6 km).

**Load Rating** – Means the maximum load that a tire is rated to carry for a given inflation pressure.

**Maximum Inflation Pressure** – The maximum tire air pressure that the tire can hold.

**Maximum Load Rating** – Means the load rating for a tire at the maximum permissible inflation pressure for that tire.

**Recommended Inflation Pressure** – The cold tire inflation pressure recommended by the manufacturer.

**Treadwear Indicators (TWI)** – Means the projections within the principal grooves designed to give a visual indication of the degrees of wear of the tread.

## ►► Tire Identification Number (TIN)

### **DOT B97R FW6X 2209**

DOT: This indicates that the tire meets all requirements of the U.S. Department of Transportation.

B97R: Manufacturer's identification mark.

FW6X: Tire type code.

22 09: Date of manufacture.

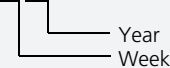

## DOT Tire Quality Grading (U.S. Vehicles)

The tires on your vehicle meet all U.S. Federal Safety Requirements. All tires are also graded for treadwear, traction, and temperature performance according to Department of Transportation (DOT) standards. The following explains these gradings.

### ■ Uniform Tire Quality Grading

Quality grades can be found where applicable on the tire sidewall between tread shoulder and maximum section width.

### ■ Treadwear

The treadwear grade is a comparative rating based on the wear rate of the tire when tested under controlled conditions on a specified government test course. For example, a tire graded 150 would wear one and one-half (1 1/2) times as well on the government course as a tire graded 100. The relative performance of tires depends upon the actual conditions of their use, however, and may depart significantly from the norm due to variations in driving habits, service practices and differences in road characteristics and climate.

### ▣ Uniform Tire Quality Grading

For example:  
**Treadwear 200**  
**Traction AA**  
**Temperature A**

All passenger car tires must conform to Federal Safety Requirements in addition to these grades.

## ■ Traction

The traction grades, from highest to lowest, are AA, A, B, and C. Those grades represent the tire's ability to stop on wet pavement as measured under controlled conditions on specified government test surfaces of asphalt and concrete. A tire marked C may have poor traction performance.

## ■ Temperature

The temperature grades are A (the highest), B, and C, representing the tire's resistance to the generation of heat and its ability to dissipate heat when tested under controlled conditions on a specified indoor laboratory test wheel. Sustained high temperature can cause the material of the tire to degenerate and reduce tire life, and excessive temperature can lead to sudden tire failure. The grade C corresponds to a level of performance which all passenger car tires must meet under the Federal Motor Vehicle Safety Standard No. 109. Grades B and A represent higher levels of performance on the laboratory test wheel than the minimum required by law.

## ⌘ Traction

Warning: The traction grade assigned to this tire is based on straight-ahead braking traction tests, and does not include acceleration, cornering, hydroplaning, or peak traction characteristics.

## ⌘ Temperature

Warning: The temperature grade for this tire is established for a tire that is properly inflated and not overloaded. Excessive speed, underinflation, or excessive loading, either separately or in combination, can cause heat buildup and possible tire failure.

## Wear Indicators

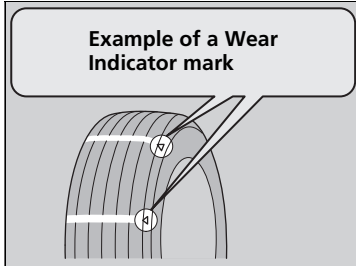

The groove where the wear indicator is located is about 1/16 inch (about 1.6 mm) shallower than elsewhere on the tire. If the tread has worn so that the indicator is exposed, replace the tire. **Worn out tires have poor traction on wet roads.**

## Tire Service Life

The life of your tires is dependent on many factors, including driving habits, road conditions, vehicle loading, inflation pressure, maintenance history, speed, and environmental conditions (even when the tires are not in use).

In addition to regular inspections and inflation pressure maintenance, it is recommended that you have annual inspections performed once the tires reach five years old. All tires, including the spare\*, should be removed from service after 10 years from the date of manufacture, regardless of their condition or state of wear.

\* Not available on all models

### ☒ Checking Tires

#### High speed driving

We recommend that you do not drive faster than the posted speed limits and conditions allow. If you drive at sustained high speeds (over 132 mph or 213 km/h)\*<sup>1</sup>/(over 133 mph or 214 km/h)\*<sup>2</sup>, adjust the cold tire pressures as shown below to avoid excessive heat build up and sudden tire failure.

Tire Size	235/50R18 97V
Pressure	Front: 36 psi (250 kPa, 2.5 kgf/cm <sup>2</sup> ) Rear: 33 psi (230 kPa, 2.3 kgf/cm <sup>2</sup> )

Tire Size	255/40R19 96W
Pressure	Front: 38 psi (260 kPa, 2.6 kgf/cm <sup>2</sup> ) Rear: 35 psi (240 kPa, 2.4 kgf/cm <sup>2</sup> )

\*1: Models with 235/50R18 97V

\*2: Models with 255/40R19 96W

## Tire and Wheel Replacement

Replace your tires with radials of the same size, load range, speed rating, and maximum cold tire pressure rating (as shown on the tire's sidewall). Using tires of a different size or construction can cause certain vehicle systems such as the ABS and Vehicle Stability Assist™ (VSA®) system to work incorrectly.

It is best to replace all four tires at the same time. If that isn't possible, replace the front or rear tires in pairs.

Whenever you have a tire replaced or reset, make sure that the rubber valve stem is replaced and that the TPMS sensor is transferred from the old valve stem to the new one.

If you replace a wheel, make sure that the wheel's specifications match those of the original wheels.

### ▶▶ Tire and Wheel Replacement

#### **WARNING**

Installing improper tires on your vehicle can affect handling and stability. This can cause a crash in which you can be seriously hurt or killed.

Always use the size and type of tires recommended in this owner's manual.



## Tire Rotation

Rotating tires according to the maintenance messages on the multi-information display helps to distribute wear more evenly and increase tire life.

### ■ Tires without rotation marks

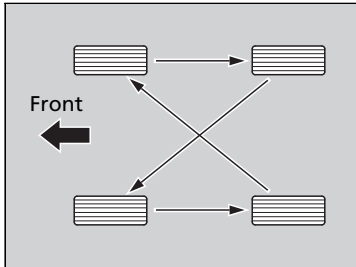

Rotate the tires as shown here.

### ■ Tires with rotation marks

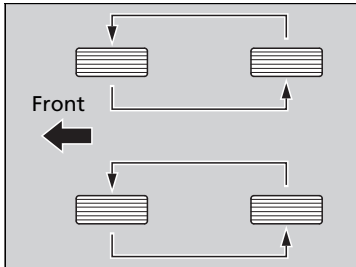

Rotate the tires as shown here.

### ☒ Tire Rotation

Tires with directional tread patterns should only be rotated front to back (not from one side to the other). Directional tires should be mounted with the rotation indication mark facing forward, as shown below.

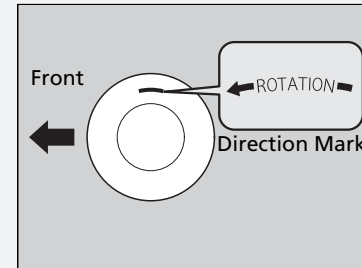

## Winter Tires

If driving on snowy or frozen roads, mount all season marked **M+S** tires, snow tires, or tire chains; reduce speed; and maintain sufficient distance between vehicles when driving.

Be particularly careful when operating the steering wheel or brakes to prevent skidding.

Use tire chains, snow tires, or all season tires when necessary or according to the law.

When mounting, refer to the following points.

For winter tires:

- Select the size and load ranges that are the same as the original tires.
- Mount the tires to all four wheels.

For tire chains:

- Install them on the front tires only.
- Because your vehicle has limited tire clearance, we strongly recommend using the chains listed below:

### **Cable-type: Auto-Trac 0155505**

- Follow the chain manufacturer's instruction when installing. Mount them as tightly as you can.
- Check that the chains do not touch the brake lines or suspension.
- Drive slowly.

### ❧ Winter Tires

## **⚠ WARNING**

Using the wrong chains, or not properly installing chains, can damage the brake lines and cause a crash in which you can be seriously injured or killed.

Follow all instructions in this owner's manual regarding the selection and use of tire chains.

### **NOTICE**

Traction devices that are the wrong size or improperly installed can damage your vehicle's brake lines, suspension, body, and wheels. Stop driving if they are hitting any part of the vehicle.

When tire chains are mounted, follow the chain manufacturer's instructions regarding vehicle operational limits.

If your vehicle is equipped with summer tires, be aware that these tires are not designed for winter driving conditions. For more information, contact a dealer.

## Checking the Battery

The condition of the battery is monitored by a sensor located on the negative terminal of the battery. If there is a problem with this sensor, the multi-information display will display a warning message. If this happens, have your vehicle inspected by a dealer.

Check the battery terminals for corrosion monthly.

⌘ Battery

### **WARNING**

The battery gives off explosive hydrogen gas during normal operation.

A spark or flame can cause the battery to explode with enough force to kill or seriously hurt you.

When conducting any battery maintenance, wear protective clothing and a face shield, or have a skilled technician do it.

**WARNING:** Battery post, terminals, and related accessories contain lead and lead compounds.

**Wash your hands after handling.**

When you find corrosion, clean the battery terminals by applying a baking powder and water solution. Clean the terminals with a damp towel. Cloth/towel dry the battery. Coat the terminals with grease to help prevent future corrosion.

When replacing the battery, the replacement must be of the same specifications. Consult a dealer for more information.

*Continued*

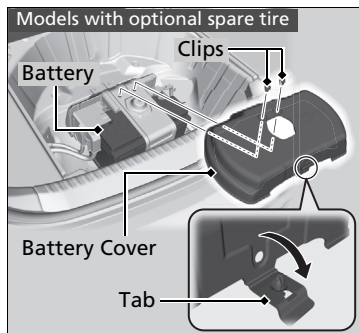
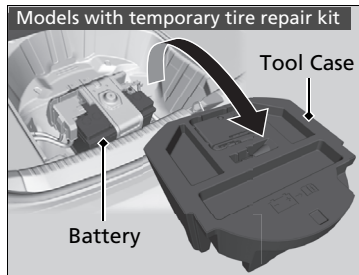
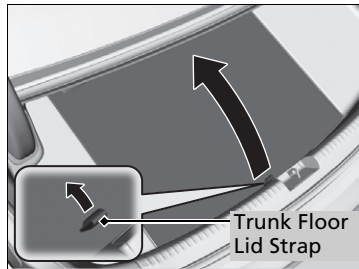

To access the battery terminals:

1. Pull up on the trunk floor lid strap until it is completely open.

Models with temporary tire repair kit

2. Remove the tool case.

Models with optional spare tire

2. Remove the tool case and spare tire.

**Getting Ready to Replace the Flat Tire**  
P. 584

3. Remove the clips.
4. Flip the tab to unlock the cover.
5. Remove the battery cover.

▶▶ Battery

Models with optional spare tire

To remove the clip:

Insert a flat-tip screwdriver, lift and remove the center pin to remove the clip.

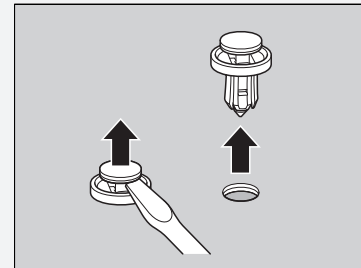

To insert the clip:

Insert the clip with the center pin raised, and push until it is flat.

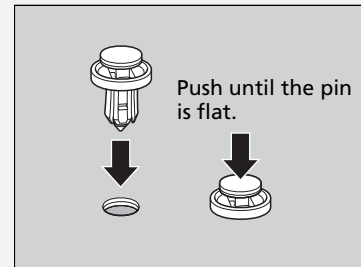

If your vehicle's battery is disconnected or goes dead:

- The audio system is disabled.
  - **Reactivating the audio system** P. 205
- The clock resets.
  - **Clock** P. 116

**Canadian models only**

- The immobilizer system needs to be reset.
  - **Immobilizer System Indicator** P. 91

⌘ **Battery**

The battery installed in this vehicle is specifically designed for a model with Auto Idle Stop. Using a battery other than this specified type may shorten the battery life, and prevent Auto Idle Stop from activating. If you need to replace the battery, make sure to select the specified type and size. Ask a dealer for more details.

## Charging the AGM Battery

AGM labeled batteries like those installed in your vehicle require a compatible charger to be properly charged. Damage to the battery can result if the battery is charged improperly or with the wrong equipment. For more information on how to charge your vehicle's AGM battery, consult a dealer.

### ⚠ Battery

The vehicle stability assist™ (VSA®) system, vehicle stability assist™ (VSA®) OFF, adaptive cruise control (ACC) with low speed follow, and safety support may come on in amber along with a message in the multi-information display when you set the power mode to ON after re-connecting a battery.

Drive a short distance at more than 12 mph (20 km/h).

Each indicator should go off. If any do not, have your vehicle checked by a dealer.

### **WARNING**

- Failure to use and correctly install a battery and Battery Stopper (foam block) specifically designed for this vehicle could cause a hydrogen gas leak inside the vehicle, resulting in a fire or explosion that may cause injury or death.
- Only install a 12V AGM battery designed for use in this vehicle.
- Contact your Acura dealer for more information.

## Replacing the Button Battery

Models without remote engine start system

If the indicator does not come on when the button is pressed, replace the battery.

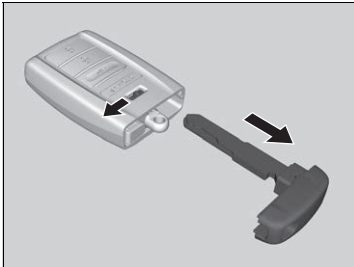

**Battery type: CR2032**

1. Remove the built-in key.

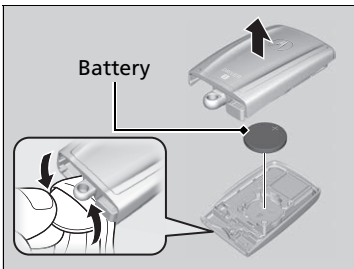

2. Remove the upper half of the cover by carefully prying on the edge with a coin.

▶ Wrap a coin with a cloth to prevent scratching the keyless access remote.

▶ Remove carefully to avoid losing the buttons.

3. Make sure to replace the battery with the correct polarity.

▶ Replacing the Button Battery

### **⚠ WARNING**

#### **CHEMICAL BURN HAZARD**

The battery that powers the remote transmitter can cause severe internal burns and can even lead to death if swallowed. Keep new and used batteries away from children.

If you suspect that a child has swallowed the battery, seek medical attention immediately.

#### **NOTICE**

An improperly disposed of battery can damage the environment. Always confirm local regulations for battery disposal.

Replacement batteries are commercially available or at a dealer.

**Models with remote engine start system**

If the indicator does not come on when the button is pressed, replace the battery.

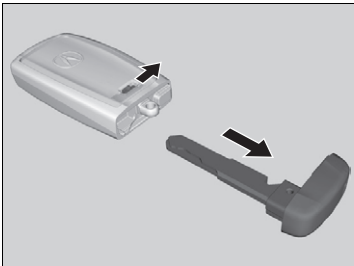

**Battery type: CR2032**

1. Remove the built-in key.
  - ▶ As a convenience, lightly place masking tape over the remote buttons to hold them in place.
2. Remove the upper half of the cover by carefully prying on the edge with a coin.
  - ▶ Wrap a coin with a cloth to prevent scratching the transmitter.
3. Press down on the center of the assembly and remove the battery.
  - ▶ When removing the button battery, be careful not to touch parts around it.
4. Make sure to replace the battery with the correct polarity.

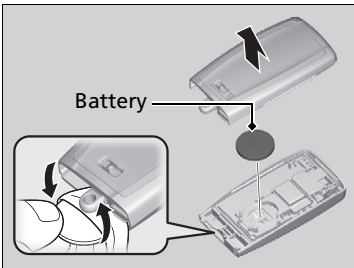

▶▶ Replacing the Button Battery

**Models with remote engine start system**

**NOTICE**

The Remote transmitter is equipped with two batteries: A standard replaceable CR2032 coin button battery and an integral non-replaceable rechargeable battery. To prevent permanent damage to the rechargeable battery, replace the CR2032 battery every three to four years.



## Air Conditioning

To ensure proper and safe operation, the Society of Automotive Engineers (SAE J2845) recommends that the refrigerant system only be serviced by trained and certified technicians.

Never repair or replace the air conditioning evaporator (cooling coil) with one removed from a used or salvaged vehicle.

New replacement mobile air conditioning evaporators must be certified (and labeled) as meeting SAE Standard J2842.

## Dust and Pollen Filter

The climate control system is equipped with a dust and pollen filter that collects pollen, dust, and other debris in the air. The Maintenance Minder™ messages will let you know when to replace the filter.

We recommend that you replace the dust and pollen filter sooner when using your vehicle in areas with high concentrations of dust.

### Climate Control System Maintenance

#### NOTICE

Vented refrigerant is harmful to the environment. To avoid refrigerant from venting, never replace the evaporator with one removed from a used or salvaged vehicle.

Refrigerant in your vehicle's air conditioning system is flammable and can be ignited during servicing if proper procedures are not followed.

The air conditioner label is found under the hood:

➤ **Safety Labels** P. 76

➤ **Specifications** P. 618

#### Canadian models



 : Caution

 : Flammable Refrigerant

 : Requires Registered Technician to Service

 : Air Conditioning System

### Dust and Pollen Filter

If the airflow from the climate control system deteriorates noticeably, and the windows fog up easily, the filter may need to be replaced. Please contact a dealer for replacement.

## Interior Care

Use a damp cloth with a mixture of mild detergent and warm water to remove dirt. Use a clean cloth to remove detergent residue.

### ■ Cleaning Seat Belts

Use a soft brush with a mixture of mild soap and warm water to clean the seat belts. Let the belts air dry. Wipe the openings of the seat belt anchors using a clean cloth.

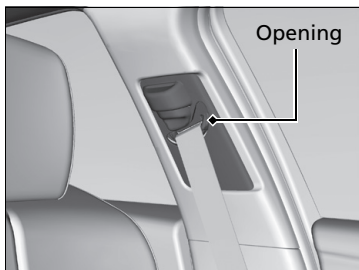

### ▣ Interior Care

Do not spill liquids inside the vehicle. Electrical devices and systems may malfunction if liquids are splashed on them.

Do not use silicone based sprays on electrical devices such as audio devices and switches. Doing so may cause the items to malfunction or cause a fire inside the vehicle.

If a silicone based spray is inadvertently used on electrical devices, consult a dealer.

Depending on their composition, chemicals and liquid aromatics may cause discoloration, wrinkles, and cracking to resin-based parts and textiles. Do not use alkali solvents or organic solvents such as benzene or gasoline.

After using chemicals, make sure to gently wipe them away using a dry cloth.

Do not place used cloths on top of resin based parts or textiles for long periods of time without washing.

## ■ Cleaning the Window

Wipe using a glass cleaner.

## ▣ Cleaning the Window

Wires are mounted to the inside of the rear window. Wipe along the same direction as the wires with a soft cloth so as not to damage them.

Be careful not to spill fluids, such as water or glass cleaner, on or around the cover of both the front sensor camera and the rainfall/light sensor\*.

➤ **Automatic Operation (automatic lighting control)** P. 149

➤ **Automatic Intermittent Wipers\*** P. 156

➤ **Front Sensor Camera** P. 480

## ■ Floor Mats

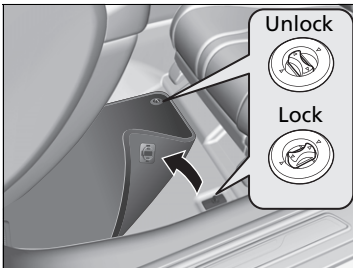

The front floor mats hook over floor anchors, which keep them from sliding forward. To remove a mat for cleaning, turn the anchor knob(s) to the unlock position. When reinstalling the mat after cleaning, turn the knob(s) to the lock position.

**Do not put additional floor mats on top of the anchored mats.**

## ▣ Floor Mats

If you use any floor mats that were not originally provided with your vehicle, make sure they are designed for your specific vehicle, fit correctly, and are securely anchored by the floor anchors. Position the rear seat floor mat properly. If they are not properly positioned, the floor mat can interfere with the front seat functions.

## ■ Maintaining Genuine Leather

To properly clean leather:

1. Use a vacuum or soft dry cloth first to remove any dirt or dust.
2. Clean the leather with a soft cloth dampened with a solution comprised of 90% water and 10% neutral soap.
3. Wipe away any soap residue with a clean damp cloth.
4. Wipe away residual water and allow leather to air dry in the shade.

\* Not available on all models

## ▣ Maintaining Genuine Leather

It is important to clean or wipe away dirt or dust as soon as possible. Spills can soak into leather resulting in stains. Dirt or dust can cause abrasions in the leather. In addition, please note that some dark colored clothing can rub onto the leather seats resulting in discoloration or stains.

## Exterior Care

Dust off the vehicle body after you drive. Regularly inspect your vehicle for scratches on painted surfaces. A scratch on a painted surface can result in body rust. If you find a scratch, promptly repair it.

### ■ Washing the Vehicle

Wash the vehicle regularly. Wash more frequently when driving in the following conditions:

- If driving on roads with road salt.
- If driving in coastal areas.
- If tar, soot, bird droppings, insects, or tree sap are stuck to painted surfaces.
- If driving in conditions that cause build up of mud, snow, ice or other debris on the left side inner fender vent.

### ■ Using an Automated Car Wash

- Make sure to follow the instructions indicated on the automated car wash.
- Fold in the door mirrors.
- For models equipped with automatic intermittent wipers, turn the wipers off.

### ■ Using High Pressure Cleaners

- Keep sufficient distance between the cleaning nozzle and the vehicle body.
- Take particular care around the windows. Standing too close may cause water to enter the vehicle interior.
- Do not spray high pressure water directly into the engine compartment. Instead, use low pressure water and a mild detergent.

### ⓘ Washing the Vehicle

Do not spray water into the air intake vents. It can cause a malfunction.

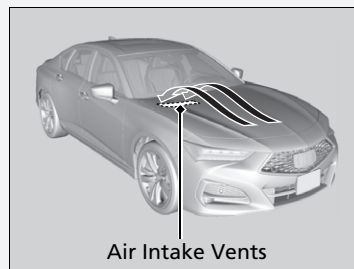

Do not spray water onto the fuel fill door directly. A high-pressure spray may cause it to open.

Do not spray water onto the capless unit when the fuel fill door is open. It can cause damage to the fuel system or engine.

If you need to lift the wiper arms away from the windshield, first set the wiper arms to the maintenance position.

➤ **Changing the Wiper Blade Rubber** P. 541

### ⓘ Using an Automated Car Wash

When using an automated car wash that pulls the vehicle through with a conveyor, make sure the transmission is in **[N]** position.

➤ **If you want to keep the transmission in **[N]** position [car wash mode]** P. 384

## ■ Applying Wax

A good coat of automotive body wax helps protect your vehicle's paint from the elements. Wax will wear off over time and expose your vehicle's paint to the elements, so reapply as necessary.

## ■ Maintaining the Bumpers and Other Resin Coated Parts

If you get gasoline, oil, engine coolant, or battery fluid on resin coated parts, they may be stained or the coating may peel. Promptly wipe it away using a soft cloth and clean water.

## ■ Cleaning the Window

Wipe using a glass cleaner.

## ■ Maintaining Aluminum Wheels

Aluminum is susceptible to deterioration caused by salt and other road contaminants. When necessary, as early as possible use a sponge and mild detergent to wipe away these contaminants. Do not use a stiff brush or harsh chemicals (including some commercial wheel cleaners). These can damage the protective finish on aluminum alloy wheels, resulting in corrosion. Depending on the type of finish, the wheels also may lose their luster or appear burnished. To avoid water stains, wipe the wheels dry with a cloth while they are still wet.

### ☒ Applying Wax

#### NOTICE

Chemical solvents and strong cleaners can damage the paint, metal, and plastic on your vehicle. Wipe away spills immediately.

### ☒ Maintaining the Bumpers and Other Resin Coated Parts

Ask a dealer about the correct coating material when you want to repair the painted surface of the parts made of resin.

## ■ Fogged Exterior Light Lenses

The inside lenses of exterior lights (headlights, brake lights, etc.) may fog temporarily if you have driven in the rain, or after the vehicle has been run through a car wash. Dew condensation also may build up inside the lenses when there is a significant enough difference between the ambient and inside lens temperatures (similar to vehicle windows fogging up in rainy conditions). These conditions are natural processes, not structural design problems in the exterior lights.

Lens design characteristics may result in moisture developing on the light lens frame surfaces. This also is not a malfunction.

However, if you see large amounts of water accumulation, or large water drops building up inside the lenses, have your vehicle inspected by a dealer.

## Accessories

When installing accessories, check the following:

- Do not install accessories on the windshield. They can obstruct your view and delay your reaction to driving conditions.
- Do not install any accessories over areas marked SRS Airbag, on the sides or backs of the front seats, on front or side pillars, or near the side windows. Accessories installed in these areas may interfere with proper operation of the vehicle's airbags or may be propelled into you or another occupant if the airbags deploy.
- Be sure electronic accessories do not overload electrical circuits or interfere with proper operation of your vehicle.
  - **Fuses** P. 605
- Before installing any electronic accessory, have the installer contact a dealer for assistance. If possible, have a dealer inspect the final installation.

### Accessories and Modifications

## **WARNING**

**Improper accessories or modifications can affect your vehicle's handling, stability, and performance, and cause a crash in which you can be seriously hurt or killed.**

**Follow all instructions in this owner's manual regarding accessories and modifications.**

Acura Genuine accessories are recommended to ensure proper operation on your vehicle.

## Modifications

---

Do not modify your vehicle in a manner that may affect its handling, stability, or reliability, or install non-genuine Acura parts or accessories that may have a similar effect.

Even minor modifications to vehicle systems can affect overall vehicle performance. Always make sure all equipment is properly installed and maintained, and do not make any modification to your vehicle or its systems that might cause your vehicle to no longer meet federal, state, province, territory, and local regulations.

The on-board diagnostic port (OBD-II/SAE J1962 connector) installed on this vehicle is intended to be used with automobile system diagnostic devices or with other devices that Acura has approved. Use of any other type of device may adversely affect the vehicle's electronic systems or allow them to be compromised, possibly resulting in a system malfunction, drained battery, or other unexpected problems.

Do not modify or attempt to repair any of the electrical components.



# Handling the Unexpected

This chapter explains how to handle unexpected troubles.

<b>Tools</b> .....	568
<b>If a Tire Goes Flat</b>	
Temporarily Repairing a Flat Tire.....	569
Changing a Flat Tire .....	583
<b>Engine Does Not Start</b>	
Checking the Engine .....	590
If the Keyless Access Remote Battery is Weak .....	591
Emergency Engine Stop .....	592
<b>If the Battery Is Dead</b> .....	593
<b>Overheating</b> .....	595
<b>Indicator, Coming On/Blinking</b>	
If the Low Oil Pressure Warning Appears ..	597

If the Charging System Indicator Comes On .....	598
If the Slow Down! Reduced Stopping Power Warning Appears .....	598
If the Malfunction Indicator Lamp Comes On or Blinks .....	599
If the Brake System Indicator (Red) Comes On or Blinks .....	600
If the Electric Power Steering (EPS) System Indicator Comes On .....	601
If the Brake System Indicator (Red) Comes On or Blinks at the Same Time When the Brake System Indicator (Amber) Comes On ..	602

If the Low Tire Pressure/TPMS Indicator Comes On or Blinks .....	603
If the Transmission System Indicator Blinks along with the Warning Message.....	604
<b>Fuses</b> .....	605
<b>Emergency Towing</b> .....	612
<b>If You Cannot Unlock the Fuel Fill Door</b> ..	613
<b>If You Cannot Open the Trunk</b> .....	614
<b>Refueling</b>	
Refueling From a Portable Fuel Container .....	615

## Types of Tools

### Types of Tools

The tools are stored in the trunk.

Models with temporary tire repair kit

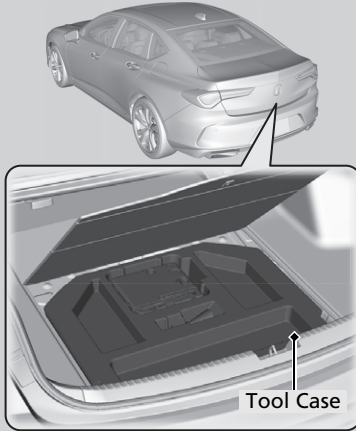

Funnel

Models with optional spare tire

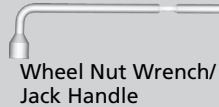
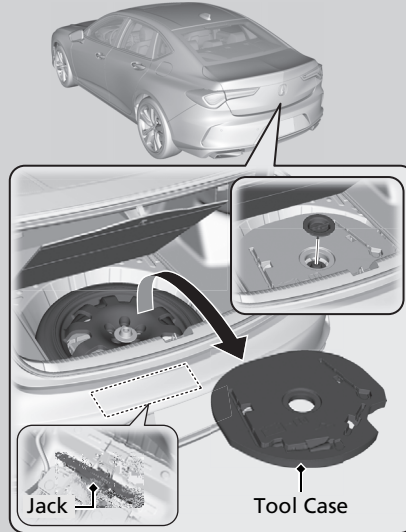

Wheel Nut Wrench/  
Jack Handle

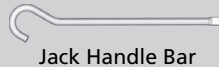

Jack Handle Bar



Jack



Funnel

## Temporarily Repairing a Flat Tire

If the tire has a large cut or is otherwise severely damaged, you will need to have the vehicle towed. If the tire only has a small puncture, from a nail for instance, you can use the temporary tire repair kit so that you can drive to the nearest service station for a more permanent repair.

If a tire goes flat while driving, grasp the steering wheel firmly, and brake gradually to reduce speed. Then stop in a safe place.

1. Park the vehicle on a firm, level, non-slippery surface and apply the parking brake.
2. Put the transmission into **P**.
3. Turn on the hazard warning lights and set the power mode to VEHICLE OFF (LOCK).

### Temporarily Repairing a Flat Tire

The kit should not be used in the following situations. Instead, contact a dealer or roadside assistance to have the vehicle towed.

- The tire sealant has expired.
- More than one tire is punctured.
- The puncture or cut is larger than 3/16 inch (4.8 mm).
- The tire side wall is damaged or the puncture is outside the contact area.



When the puncture is:	Use Kit
Smaller than 3/16 inch (4.8 mm)	Yes
Larger than 3/16 inch (4.8 mm)	No

- Damage has been caused by driving with the tire extremely under inflated.
- The tire bead is no longer seated.
- The rim is damaged.

Do not remove a nail or screw that punctured the tire. If you remove it from the tire, you may not be able to repair the puncture using the kit.

#### NOTICE

Do not use a puncture-repairing agent other than the one provided in the kit that came with your vehicle. If a different agent is used, you may permanently damage the tire pressure sensor.

## ■ Getting Ready to Temporarily Repair the Flat Tire

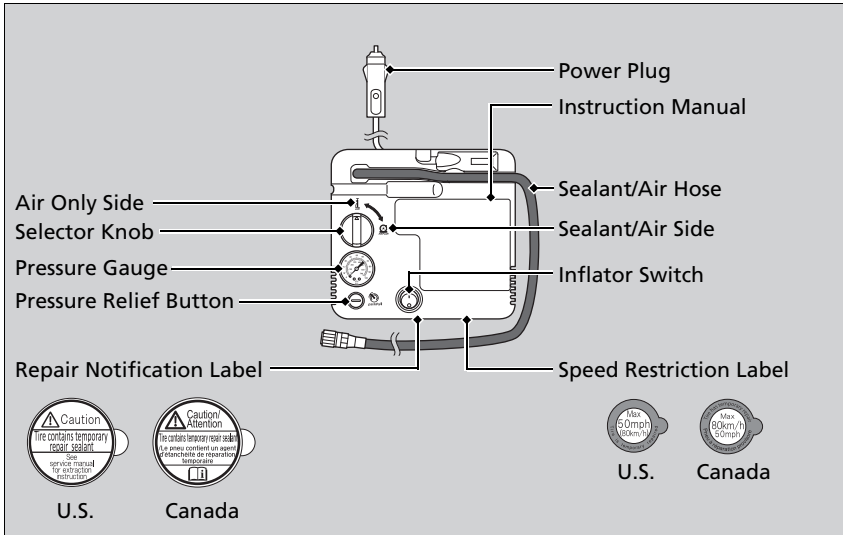

## ▶▶ Getting Ready to Temporarily Repair the Flat Tire

Repair notification label and speed restriction label are applied to the side of temporary tire repair kit.

When making a temporary repair, carefully read the instruction manual provided with the kit.

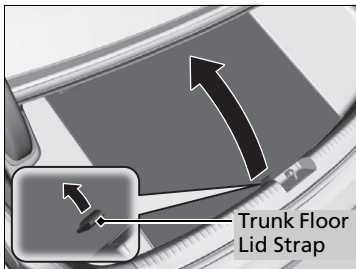

1. Pull up on the trunk floor lid strap until it is completely open.

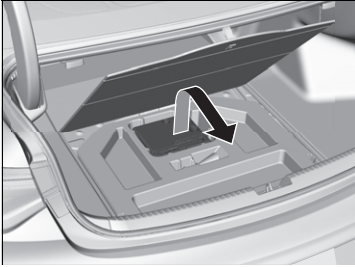

2. Remove the kit.
3. Place the kit face up, on flat ground near the flat tire, and away from traffic. Do not place the kit on its side.

## ■ Injecting Sealant and Air

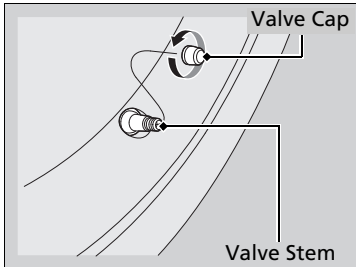

1. Remove the valve cap from the tire valve stem.

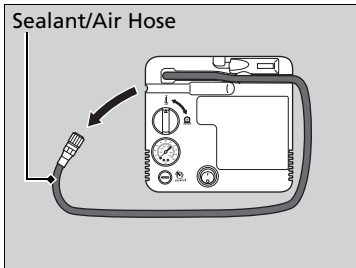

2. Remove the sealant/air hose from the packaging.

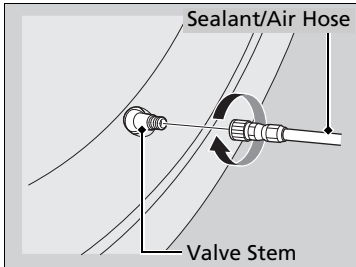

3. Attach the sealant/air hose onto the tire valve stem. Screw it until it is tight.

## ▶▶ Injecting Sealant and Air

**⚠ CAUTION**

Tire sealant contains substances that are harmful if inhaled, ingested or if contact is made with the eyes or skin.

Always use in a well-ventilated area and use gloves and safety glasses for protection; do not ingest.

For skin or eye contact, flush with cool water; if ingested, rinse mouth with water. In all cases, seek medical attention if necessary.

In cold temperatures, the sealant may not flow easily. In this situation, warm it up for five minutes before using.

The sealant can permanently stain clothing and other materials. Be careful during handling and wipe away any spills immediately.

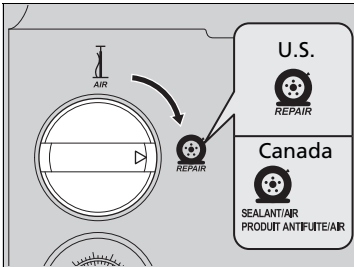
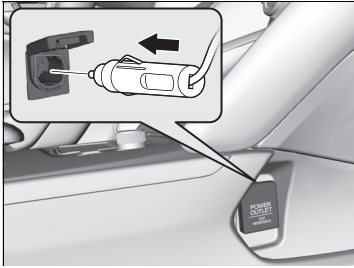

4. Plug in the compressor to the accessory power socket.
  - ▶ Be careful not to pinch the cord in a door or window.
  - ▶ Do not plug any other electric devices into other accessory power sockets.
    - ✦ **Accessory Power Sockets** P. 187
5. Start the engine.
  - ▶ Keep the engine running while injecting sealant and air.
    - ✦ **Carbon Monoxide Gas** P. 75
6. Turn the selector knob to **REPAIR**<sup>\*1</sup>, **SEALANT/AIR**<sup>\*2</sup>, **PRODUIT ANTIFUITE/AIR**<sup>\*2</sup>.

✦ **Injecting Sealant and Air**

**⚠ WARNING**

Running the engine with the vehicle in an enclosed or even partly enclosed area can cause a rapid build-up of toxic carbon monoxide.

Breathing this colorless, odorless gas can cause unconsciousness and even death. Only run the engine to power the air compressor with the vehicle outdoors.

**NOTICE**

Do not operate the temporary tire repair kit compressor for more than 15 minutes. The compressor can overheat and become permanently damaged.

There are two accessory power sockets:

- In the console compartment
- In the front of the passenger lower pocket
  - ✦ **Accessory Power Sockets** P. 187

Until the sealant injection is complete, the pressure shown on the pressure gauge will appear higher than actual. After the sealant injection is complete the pressure will drop and then begin to rise again as the tire is inflated with air. This is normal. To accurately measure the air pressure using the gauge, turn the air compressor off only after the sealant injection is complete.

\*1: U.S. models  
\*2: Canadian models

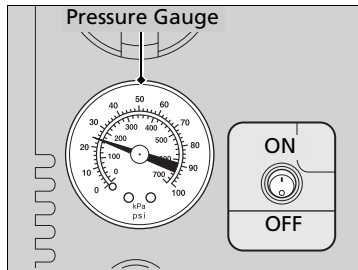

7. Press the inflator switch to turn on the compressor.
  - ▶ The compressor starts injecting sealant and air into the tire.
  - ▶ When the sealant injection is complete continue to add air.

**8. Models with 235/50R18 97V tires**

After the air pressure reaches front: 32 psi (220 kPa)/rear: 30 psi (210 kPa), turn off the kit.

**Models with 255/40R19 96W tires**

After the air pressure reaches 32 psi (220 kPa), turn off the kit.

- ▶ To check the pressure, occasionally turn off the compressor and read the gauge.

9. Unplug the power plug from the accessory power socket.
10. Unscrew the sealant/air hose from the tire valve stem. Reinstall the valve cap.

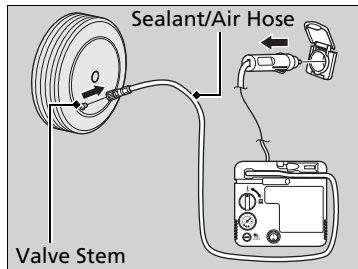

▶▶ Injecting Sealant and Air

If the required air pressure is not reached within 10 minutes, the tire may be too severely damaged for the kit to provide the necessary seal, and your vehicle will need to be towed.

See an Acura dealer for a replacement sealant bottle and proper disposal of an empty bottle.



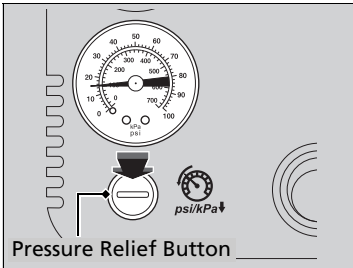

11. Press the pressure relief button until the gauge returns 0 psi (0 kPa).

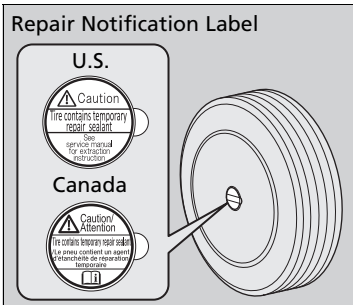

12. Apply the repair notification label to the flat surface of the wheel.
  - ▶ The wheel surface must be clean to ensure the label adheres properly.

## ■ Distributing the Sealant in the Tire

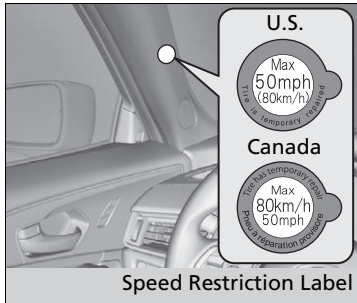

1. Apply the speed restriction label to the location as shown.
2. Drive the vehicle for about 10 minutes.
  - ▶ Do not exceed 50 mph (80 km/h).
3. Stop the vehicle in a safe place.

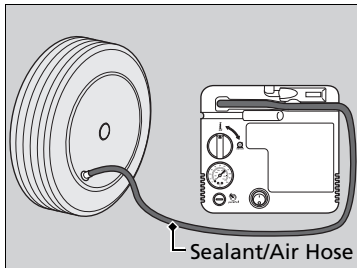

4. Recheck the air pressure using the sealant/air hose on the compressor.

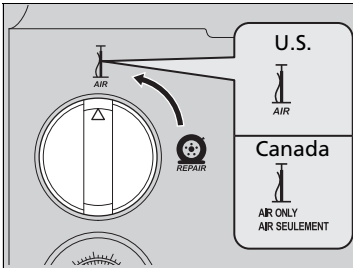

5. Turn the selector knob to **AIR**<sup>\*1</sup>, **AIR ONLY**<sup>\*2</sup>, **AIR SEULEMENT**<sup>\*2</sup>.
  - ▶ Do not turn the air compressor on to check the pressure.
    - **Inflating an Under-inflated Tire** P. 580
6. If the air pressure is
  - Less than 25 psi (175 kPa):  
Do not add air or continue driving. The leak is too severe. Call for help and have your vehicle towed.
    - **Emergency Towing** P. 612

**Models with 235/50R18 97V tires**

- Front: 32 psi (220 kPa)/rear: 30 psi (210 kPa) or more:

**Models with 255/40R19 96W tires**

- 32 psi (220 kPa) or more:  
Continue driving for another 10 minutes or until you reach the nearest service station, whichever is sooner. Do not exceed 50 mph (80 km/h). If you have not reached a service station, stop and check the tire pressure.
  - ▶ If the air pressure does not go down after the 10 minute driving, you do not need to check the pressure any more.

\*1: U.S. models  
\*2: Canadian models

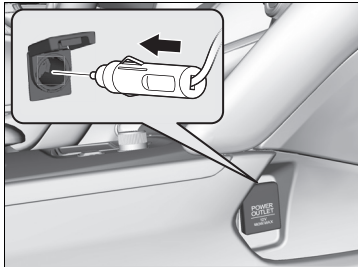

**Models with 235/50R18 97V tires**

- Greater than 25 psi (175 kPa), but less than front: 32 psi (220 kPa)/rear: 30 psi (210 kPa):

Turn the air compressor on to inflate the tire until the tire pressure reaches front: 32 psi (220 kPa)/rear: 30 psi (210 kPa).

**Models with 255/40R19 96W tires**

- Greater than 25 psi (175 kPa), but less than 32 psi (220 kPa):

Turn the air compressor on to inflate the tire until the tire pressure reaches 32 psi (220 kPa).

➤ **Inflating an Under-inflated Tire** P. 580

Then drive carefully for 10 more minutes or until you reach the nearest service station, whichever is sooner. Do not exceed 50 mph (80 km/h). If you have not reached a service station, stop and check the tire pressure.

- ▶ You should repeat this procedure as long as the air pressure is within this range.

▶▶ Distributing the Sealant in the Tire

**⚠ WARNING**

Running the engine with the vehicle in an enclosed or even partly enclosed area can cause a rapid build-up of toxic carbon monoxide.

Breathing this colorless, odorless gas can cause unconsciousness and even death. Only run the engine to power the air compressor with the vehicle outdoors.

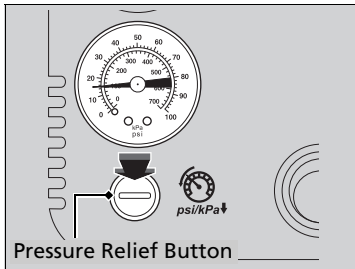

7. Unplug the kit from the accessory power socket.
8. Unscrew the sealant/air hose from the tire valve stem. Reinstall the valve cap.
9. Press the pressure relief button until the gauge returns to 0 psi (0 kPa).
10. Repackage and properly stow the kit.

## ■ Inflating an Under-inflated Tire

You can use the kit to inflate a non-punctured under-inflated tire.

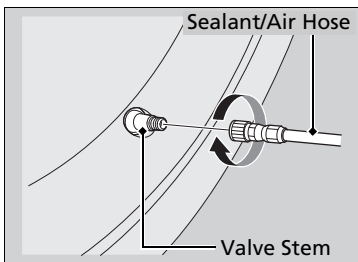
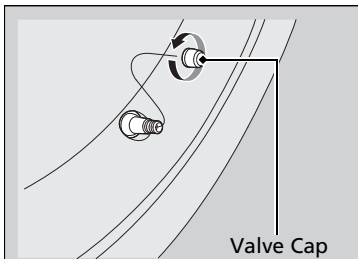
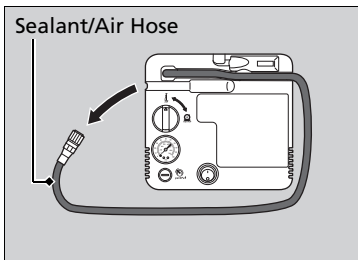

1. Open the trunk floor lid.
  - **Getting Ready to Temporarily Repair the Flat Tire** P. 570
2. Remove the kit from the case.
3. Place the kit, face up, on flat ground near the flat tire, away from traffic. Do not place the kit on its side.
4. Remove the sealant/air hose from the kit.
5. Remove the valve cap.
6. Attach the sealant/air hose onto the tire valve stem. Screw it until it is tight.

## ▶▶ Inflating an Under-inflated Tire

### ⚠ **WARNING**

Running the engine with the vehicle in an enclosed or even partly enclosed area can cause a rapid build-up of toxic carbon monoxide.

Breathing this colorless, odorless gas can cause unconsciousness and even death. Only run the engine to power the air compressor with the vehicle outdoors.

**NOTICE**  
Do not operate the temporary tire repair kit compressor for more than 15 minutes. The compressor can overheat and become permanently damaged.

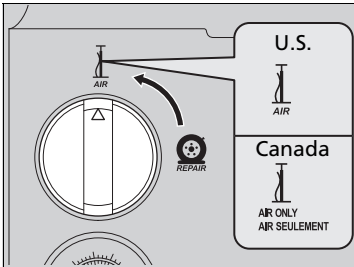
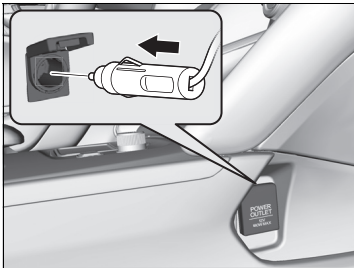

7. Plug in the kit to the accessory power socket.
  - Be careful not to pinch the cord in a door or window.
  - Do not plug any other electronic devices into other accessory power sockets.

➤ **Accessory Power Sockets** P. 187
8. Start the engine.
  - Keep the engine running while injecting air.

➤ **Carbon Monoxide Gas** P. 75
9. Turn the selector knob to **AIR**\*<sup>1</sup>, **AIR ONLY**\*<sup>2</sup>, **AIR SEULEMENT**\*<sup>2</sup>.
10. Press the inflator switch to turn on the kit.
  - The compressor starts to inject air into the tire.
11. Inflate the tire to the specified air pressure.

\*1: U.S. models

\*2: Canadian models

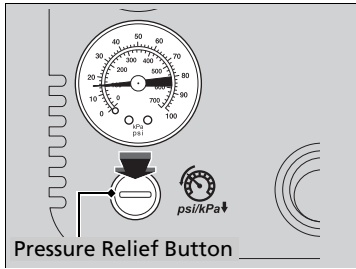

- 12.** Turn off the kit.
  - ▶ Check the pressure gauge on the air compressor.
  - ▶ If overinflated, press the pressure relief button.
- 13.** Unplug the kit from the accessory power socket.
- 14.** Unscrew the sealant/air hose from the tire valve stem. Reinstall the valve cap.
- 15.** Press the pressure relief button until the gauge returns to 0 psi (0 kPa).
- 16.** Repackage and properly stow the kit.



Models with optional spare tire

## Changing a Flat Tire

If a tire goes flat while driving, grasp the steering wheel firmly, and brake gradually to reduce speed. Then, stop in a safe place. Replace the flat tire with a compact spare tire. Go to a dealer as soon as possible to have the full-size tire repaired or replaced.

1. Park the vehicle on a firm, level, non-slippery surface and apply the parking brake.
2. Put the transmission into **P**.
3. Turn on the hazard warning lights and set the power mode to VEHICLE OFF (LOCK).

### ✕ Changing a Flat Tire

Follow compact spare precautions:

Periodically check the tire pressure of the compact spare. It should be set to the specified pressure.

Specified Pressure: 60 psi (420 kPa, 4.2 kgf/cm<sup>2</sup>)

When driving with the compact spare tire, keep the vehicle speed under 50 mph (80 km/h). Replace with a full-size tire as soon as possible.

The compact spare tire and wheel in your vehicle are specifically for this model. Do not use them with another vehicle. Do not use another type of compact spare tire or wheel with your vehicle.

Do not mount tire chains on a compact spare tire. If a chain-mounted front tire goes flat, remove one of the full-size rear tires and replace it with the compact spare tire. Remove the flat front tire and replace it with the full-size tire that was removed from the rear. Mount the tire chains on the front tire.

Do not use a puncture-repairing agent other than the Tire Repair Kit provided with your vehicle, as some tire repair agents can cause damage to the pressure sensors.

#### NOTICE

Do not use the jack if it doesn't work properly. Call your dealer or a professional towing service.

## ■ Getting Ready to Replace the Flat Tire

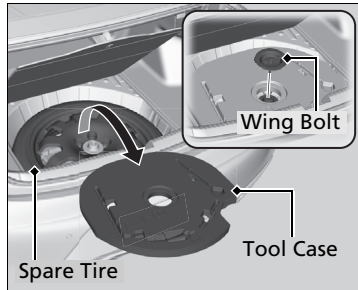

1. Open the trunk floor lid.
  - **Getting Ready to Temporarily Repair the Flat Tire** P. 570
2. Take the wheel nut wrench out of the tool case.
3. Unscrew the wing bolt and remove the tool case. Then, remove the compact spare tire.

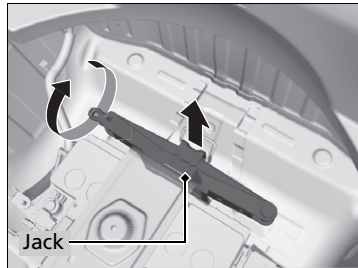

4. Take the jack out of the trunk.
  - Turn the jack's end bracket to loosen it, then remove it.

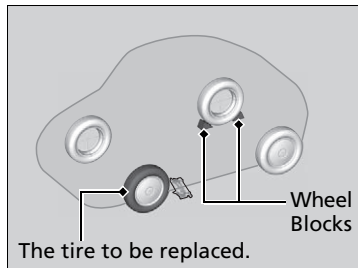

5. Place a wheel block or rock in front and rear of the wheel diagonal to the flat tire.

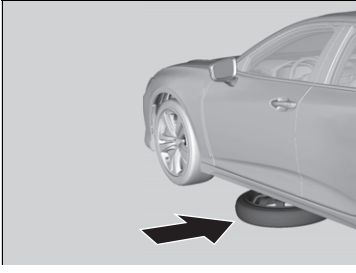

6. Place the compact spare tire (wheel side up) under the vehicle body, near the tire that needs to be replaced.

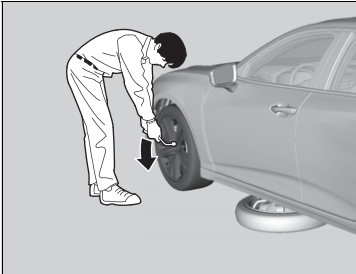

7. Loosen each wheel nut about one turn using the wheel nut wrench.

## ■ How to Set Up the Jack

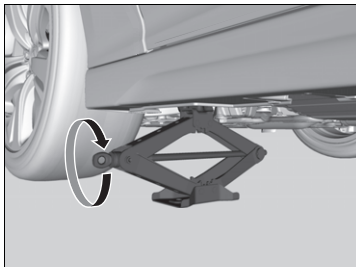
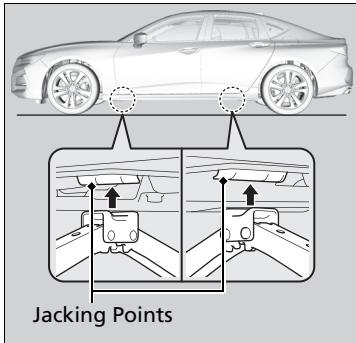

1. Place the jack under the jacking point closest to the tire to be changed.

2. Turn the end bracket clockwise as shown in the image until the top of the jack contacts the jacking point.

▶ Make sure that the jacking point tab is resting in the jack notch.

## ▣ How to Set Up the Jack

### **⚠ WARNING**

The vehicle can easily roll off the jack, seriously injuring anyone underneath.

Follow the directions for changing a tire exactly, and never get under the vehicle when it is supported only by the jack.

Do not use the jack with people or luggage in the vehicle.

Use the jack provided in your vehicle. Other jacks may not support the weight ("load") or may not fit the jacking point.

The following instructions must be followed to use the jack safely:

- Do not use while the engine is running.
- Use only where the ground is firm and level.
- Use only at the jacking points.
- Do not get in the vehicle while using the jack.
- Do not put anything on top of or underneath the jack.

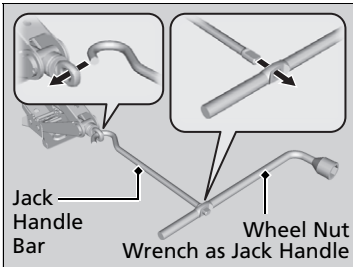

3. Raise the vehicle, using the jack handle bar and the jack handle, until the tire is off the ground.

## ■ Replacing the Flat Tire



1. Remove the wheel nuts and flat tire.

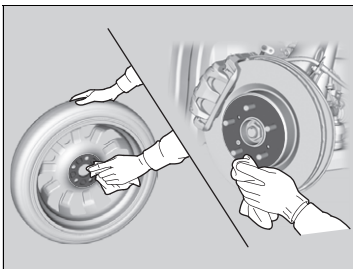

2. Wipe the mounting surfaces of the wheel with a clean cloth.
3. Mount the compact spare tire.
4. Screw the wheel nuts until they touch the lips around the mounting holes, then stop rotating.

## ▣ Replacing the Flat Tire

Do not over tighten the wheel nuts by applying extra torque using your foot or a pipe.

*Continued*

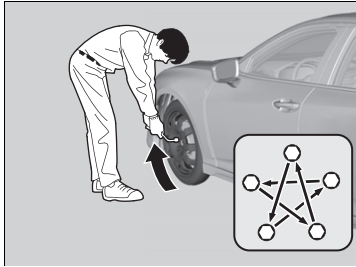

5. Lower the vehicle and remove the jack. Tighten the wheel nuts in the order indicated in the image. Go around, tightening the nuts, two to three times in this order.

**Wheel nut torque:**

94 lbf·ft (127 N·m, 13 kgf·m)

### ■ Storing the Flat Tire

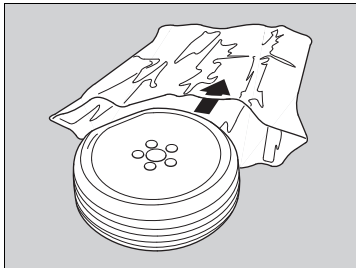

1. Put the flat tire in the storage bag provided with your vehicle.
  - The storage bag is in the spare tire tub.
2. Knot the top of the storage bag.
3. Securely put the wheel nut wrench and jack handle bar back in the tool case. Store the case and jack in the trunk.

### ► Storing the Flat Tire

## ⚠ WARNING

Loose items can fly around the interior in a crash and can seriously injure the occupants.  
Store the wheel, jack, and tools securely before driving.

## ■ TPMS and the Compact Spare Tire

If you replace a flat tire with the spare tire, the low tire pressure/TPMS indicator comes on while you are driving. After driving for a few miles (kilometers), **Tire Pressure Monitor System Problem. Check Tire Pressure. See Your Dealer.** will appear on the multi-information display and the indicator will start blinking for a short time and then stay on; however, this is normal and is no cause for concern.

If you replace the tire with a full-size tire, the warning message on the multi-information display and the low tire pressure/TPMS indicator will go off after a few miles (kilometers).

## ▣ TPMS and the Compact Spare Tire

The system cannot monitor the pressure of the spare tire. Manually check the spare tire pressure to be sure that it is correct.

Use the TPMS specific wheels. Each is equipped with a tire pressure sensor mounted inside the tire behind the valve stem.

## Checking the Engine

If the engine does not start, check the starter.

### ☞ Checking the Engine

If you must start the vehicle immediately, use an assisting vehicle or booster battery to jump start it.

☞ **If the Battery Is Dead** P. 593

### Starter condition

### Checklist

#### **Starter doesn't turn or turns over slowly.**

The battery may be dead. Check each of the items on the right and respond accordingly.

#### **Check for a message on the multi-information display.**

- If the **To Start, Hold Remote Near Start Button** message appears
  - ☞ **If the Keyless Access Remote Battery is Weak** P. 591
- ▶ Make sure the keyless access remote is in its operating range.
  - ☞ **ENGINE START/STOP Button Operating Range** P. 144

#### **Check the brightness of the interior lights.**

Turn on the interior lights and check the brightness.

- If the interior lights do not come on at all
  - ☞ **Battery** P. 553
- If the interior lights come on normally ☞ **Fuses** P. 605

#### **The starter turns over normally but the engine doesn't start.**

There may be a problem with the fuse. Check each of the items on the right and respond accordingly.

#### **Review the engine start procedure.**

Follow its instructions, and try to start the engine again. ☞ **Starting the Engine** P. 372

#### **Check the immobilizer system indicator.**

When the immobilizer system indicator is blinking, the engine cannot be started.

☞ **Immobilizer System** P. 137

#### **Check the fuel level.**

There should be enough fuel in the tank. ☞ **Fuel Gauge** P. 97

#### **Check the fuse.**

Check all fuses, or have the vehicle checked by a dealer.

☞ **Inspecting and Changing Fuses** P. 611

#### **If the problem continues:**

☞ **Emergency Towing** P. 612



## If the Keyless Access Remote Battery is Weak

If the beeper sounds, the **To Start, Hold Remote Near Start Button** message appears on the multi-information display, the **ENGINE START/STOP** button flashes, and the engine won't start, start the engine as follows:

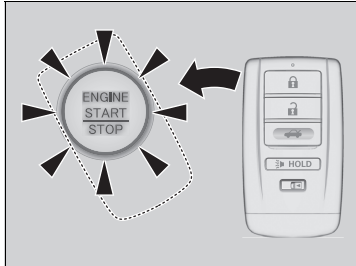

1. Touch the center of the **ENGINE START/STOP** button with the **A** logo on the keyless access remote while the **ENGINE START/STOP** button is flashing.

The buttons on the keyless access remote should be facing you.

- ▶ The **ENGINE START/STOP** button flashes for about 30 seconds.

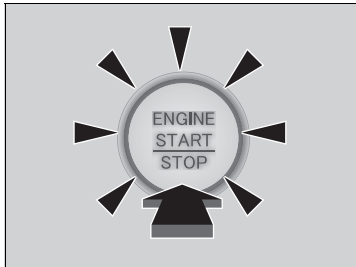

2. Depress the brake pedal and press the **ENGINE START/STOP** button within 10 seconds after the beeper sounds and the **ENGINE START/STOP** button changes from flashing to on.

- ▶ If you don't depress the pedal, the mode will change to ACCESSORY.

## Emergency Engine Stop

The **ENGINE START/STOP** button may be used to stop the engine due to an emergency situation even while driving. If you must stop the engine, do either of the following operations:

- Press and hold the **ENGINE START/STOP** button for about two seconds.
- Firmly press the **ENGINE START/STOP** button three times.

The steering wheel will not lock. However, because turning off the engine disables the power assist the engine provides to the steering and braking systems, it will require significantly more physical effort and time to steer and slow the vehicle. Use both feet on the brake pedal to slow down the vehicle and stop immediately in a safe place.

The gear position automatically changes to **P** after the vehicle comes to a complete stop. Then, the power mode changes to VEHICLE OFF.

### ⚠ Emergency Engine Stop

Do not press the **ENGINE START/STOP** button while driving unless it is absolutely necessary for the engine to be turned off.

If you press the **ENGINE START/STOP** button while driving, the beeper sounds.

## Jump Starting Procedure

Turn off the power to electric devices, such as audio and lights. Turn off the engine, then open the hood.

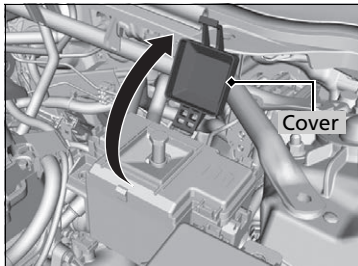

1. Open the cover of the Jump start box.

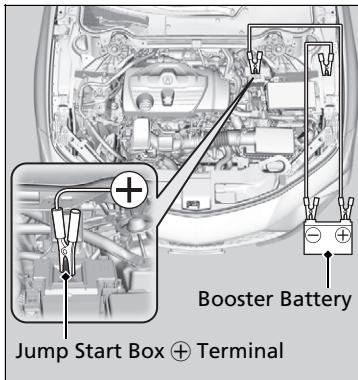

2. Connect the first jumper cable to your vehicle's jump start box  $\oplus$  terminal as shown. Do not connect this jumper cable to any other part.

3. Connect the other end of the first jumper cable to the booster battery  $\oplus$  terminal.

▶ Use a 12-volt booster battery only.

▶ When using an automotive battery charger to boost your 12-volt battery, select a lower charging voltage than 15-volt. Check the charger manual for the proper setting.

4. Connect the second jumper cable to the booster battery  $\ominus$  terminal.

## If the Battery Is Dead

### **⚠ WARNING**

A battery can explode if you do not follow the correct procedure, seriously injuring anyone nearby.

Keep all sparks, open flames, and smoking materials away from the battery.

Securely attach the jumper cables clips so that they do not come off when the engine vibrates. Also be careful not to tangle the jumper cables or allow the cable ends to touch each other while attaching or detaching the jumper cables.

Battery performance degrades in cold conditions and may prevent the engine from starting.

You cannot use the terminals to jump start another vehicle or to charge the 12-volt battery.

*Continued*

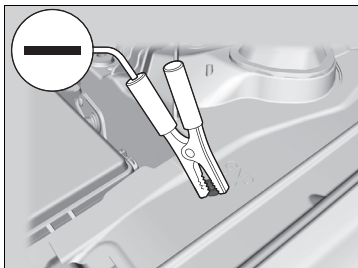

5. Connect the other end of the second jumper cable to the GND terminal as shown. Do not connect this jumper cable to any other part.
6. If your vehicle is connected to another vehicle, start the assisting vehicle's engine and increase its rpm slightly.
7. Attempt to start your vehicle's engine. If it turns over slowly, check that the jumper cables have good metal-to-metal contact.

### ■ What to Do After the Engine Starts

Once your vehicle's engine has started, remove the jumper cables in the following order.

1. Disconnect the jumper cable from your vehicle's ground.
2. Disconnect the other end of the jumper cable from the booster battery ⊖ terminal.
3. Disconnect the jumper cable from your vehicle's jump start box ⊕ terminal.
4. Disconnect the other end of the jumper cable from the booster battery ⊕ terminal.

Have your vehicle inspected by a nearby service station or a dealer.

### ⚠ If the Battery Is Dead

The vehicle stability assist™ (VSA®) system, vehicle stability assist™ (VSA®) OFF, adaptive cruise control (ACC) with low speed follow, and safety support indicators may come on in amber along with a message in the multi-information display when you set the power mode to ON after reconnecting a battery.

Drive a short distance at more than 12 mph (20 km/h).

Each indicator should go off. If any do not, have your vehicle checked by a dealer.

## How to Handle Overheating

Overheating symptoms are as follows:

- The temperature gauge pointer is at the **H** mark or the engine suddenly loses power.
- The **Engine Temperature Too Hot. Do Not Drive. Allow Engine To Cool.** message appears on the multi-information display.
- Steam or spray comes out of the engine compartment.

### ■ First thing to do

1. Immediately park the vehicle in a safe place.
2. Turn off all accessories and turn on the hazard warning lights.
  - ▶ **No steam or spray present:** Keep the engine running and open the hood.
  - ▶ **Steam or spray is present:** Turn off the engine and wait until it subsides. Then, open the hood.

### 🔧 How to Handle Overheating

## ⚠️ WARNING

Steam and spray from an overheated engine can seriously scald you.

Do not open the hood if steam is coming out.

### NOTICE

Continuing to drive with the temperature gauge pointer at the **H** mark may damage the engine.

Continuing to drive with the **Engine Temperature Too Hot. Do Not Drive. Allow Engine To Cool.** message on the multi-information display may damage the engine.

### ■ Next thing to do

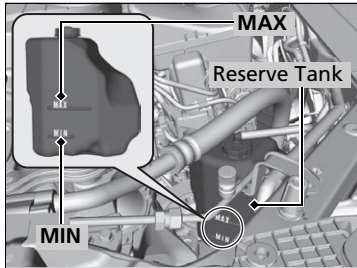

1. Check that the cooling fan is operating and stop the engine once the temperature gauge pointer comes down.
  - If the cooling fan is not operating, immediately stop the engine.
2. Once the engine has cooled down, inspect the coolant level and check the cooling system components for leaks.
  - If the coolant level in the reserve tank is low, add coolant until it reaches the **MAX** mark.
  - If there is no coolant in the reserve tank, check that the radiator is cool. Cover the radiator cap with a heavy cloth and open the cap. If necessary, add coolant up to the base of the filler neck, and put the cap back on.

### ■ Last thing to do

Once the engine has cooled sufficiently, restart it and check the temperature gauge. If the temperature gauge pointer has gone down, resume driving. If it has not gone down, contact a dealer for repairs.

### ► How to Handle Overheating

## **⚠ WARNING**

Removing the radiator cap while the engine is hot can cause the coolant to spray out, seriously scalding you.

Always let the engine and radiator cool down before removing the radiator cap.

If the coolant is leaking, contact a dealer for repairs.

Use water as an emergency/temporary measure only. Have a dealer flush the system with proper antifreeze as soon as possible.

## If the Low Oil Pressure Warning Appears



### ■ Reasons for the warning to appear

Appears when the engine oil pressure is low.

### ■ What to do as soon as the warning appears

1. Immediately park the vehicle on level ground in a safe place.
2. If necessary, turn the hazard warning lights on.

### ■ What to do after parking the vehicle

1. Stop the engine and let it sit for approximately three minutes.
  - ▶ Add oil as necessary.
    - **Oil Check** P. 531
3. Start the engine and check the low oil pressure warning.
  - ▶ The warning disappears: Start driving again.
  - ▶ The warning does not disappear within 10 seconds: Immediately stop the engine and contact a dealer for repairs.

### ☒ If the Low Oil Pressure Warning Appears

#### NOTICE

Running the engine with low oil pressure can cause serious mechanical damage almost immediately.

## If the Charging System Indicator Comes On



### ■ Reasons for the indicator to come on

Comes on when there is a problem with the charging system.

### ■ What to do when the indicator comes on

Stop in a safe place and have your vehicle checked by a dealer immediately.

## If the Slow Down! Reduced Stopping Power Warning Appears



### ■ Reasons for the warning to appear

Appears when braking ability is reduced.

### ■ What to do as soon as the warning appears

Slow down and drive carefully. Have your vehicle checked by a dealer.

### ▶▶ If the Charging System Indicator Comes On

If you need to stop temporarily, do not turn off the engine. Restarting the engine may rapidly discharge the battery.

If the charging system warning or battery indicator illuminate and there is a rotten egg smell in the vehicle, roll down the windows to prevent accumulation of gasses in the vehicle.



## If the Malfunction Indicator Lamp Comes On or Blinks



### ■ Reasons for the indicator lamp to come on or blink

- Comes on when there is a problem with the engine emissions control system.
- Blinks when engine misfiring is detected.

### ■ What to do when the indicator lamp comes on

Avoid high speeds and immediately get your vehicle inspected at a dealer.

### ■ What to do when the indicator lamp blinks

Park the vehicle in a safe place with no flammable items and wait at least 10 minutes or more with the engine stopped until it cools.

### ⓘ If the Malfunction Indicator Lamp Comes On or Blinks

#### NOTICE

If you drive with the malfunction indicator lamp on, the emissions control system and the engine could be damaged.

If the malfunction indicator lamp blinks again when restarting the engine, drive to the nearest dealer at 31 mph (50 km/h) or less. Have your vehicle inspected.

## If the Brake System Indicator (Red) Comes On or Blinks

U.S.



Canada



### ■ Reasons for the indicator to come on

- The brake fluid is low.
- There is a malfunction in the brake system.

### ■ What to do when the indicator comes on while driving

Depress the brake pedal lightly to check pedal pressure.

- If normal, check the brake fluid level the next time you stop.
- If abnormal, take immediate action. If necessary, downshift the transmission to slow the vehicle using engine braking.

### ■ Reasons for the indicator to blink

- There is a problem with the electric parking brake system.

### ■ What to do when the indicator blinks

- Avoid using the parking brake and have your vehicle checked by a dealer immediately.

### ☒ If the Brake System Indicator (Red) Comes On or Blinks

Have your vehicle repaired immediately.

It is dangerous to drive with low brake fluid. If there is no resistance from the brake pedal, stop immediately in a safe place. If necessary downshift the gears.

If the brake system indicator (red) and **ABS** indicator come on simultaneously, the electronic brake distribution system is not working. This can result in vehicle instability under sudden braking. Have your vehicle inspected by a dealer immediately.

If the Brake System Indicator (Red) blinks at the same time when the Brake System Indicator (Amber) comes on, the parking brake may not work. Avoid using the parking brake and have your vehicle checked by a dealer immediately.

### ☒ If the Brake System Indicator (Red) Comes On or Blinks at the Same Time When the Brake System Indicator (Amber) Comes On P. 602

If you repeatedly operate the electric parking brake in a short period of time, the brake stops operating to prevent heating of the system and the indicator blinks.

It returns to its original state in approximately 1 minute.

## If the Electric Power Steering (EPS) System Indicator Comes On

---



### ■ Reasons for the indicator to come on

- Comes on when there is a problem with the EPS system.
- If you depress the accelerator pedal repeatedly to increase the engine speed while the engine is idling, the indicator comes on, and sometimes the steering wheel becomes harder to operate.

### ■ What to do when the indicator comes on

Stop the vehicle in a safe place and restart the engine.

If the indicator comes on and stays on, immediately have your vehicle inspected by a dealer.

## If the Brake System Indicator (Red) Comes On or Blinks at the Same Time When the Brake System Indicator (Amber) Comes On

### ☒ If the Brake System Indicator (Red) Comes On or Blinks at the Same Time When the Brake System Indicator (Amber) Comes On

If you apply the parking brake, you may not be able to release it.

If the brake system indicator (red) and the brake system indicator (amber) come on at the same time, the parking brake is working.

If the brake system indicator (red) blinks at the same time when the brake system indicator (amber) comes on, the parking brake may not work because it is checking the system.



■ If the brake system indicator (red) comes on or blinks at the same time when the brake system indicator (amber) comes on, release the parking brake manually or automatically.

☒ Parking Brake P. 483

- If the brake system indicator (red) continuously comes on or blinks at the same time when the brake system indicator (amber) comes on, stop the vehicle in a safe place and have it inspected by a dealer immediately.

▶ Prevents the vehicle from moving gear position to **P**.



- If only the brake system indicator (red) is turned off, avoid using the parking brake and have your vehicle checked by a dealer immediately.

## If the Low Tire Pressure/TPMS Indicator Comes On or Blinks



### ■ Reasons for the indicator to come on or blink

A tire pressure is significantly low. If there is a problem with the TPMS, the indicator blinks for about one minute, and then stays on.

If the compact spare tire\* is installed, the indicator will either come on or it will first blink for about one minute, then stay on.

### ■ What to do when the indicator comes on

Drive carefully and avoid abrupt cornering and hard braking.

Stop your vehicle in a safe place. Check the tire pressure and adjust the pressure to the specified level. The specified tire pressure is on a label on the driver side doorjamb.

If the compact spare tire\* causes the indicator to come on, change the tire to a full-size tire.

### ■ What to do when the indicator blinks, then remains on

Have the tire inspected by a dealer as soon as possible. If the compact spare tire\* causes the indicator to first blink, and then stay on, change the tire to a full-size tire. The indicator goes off after driving for a few miles (kilometers).

### ▶▶ If the Low Tire Pressure/TPMS Indicator Comes On or Blinks

#### NOTICE

Driving on an extremely underinflated tire can cause it to overheat. An overheated tire can fail. Always inflate your tires to the prescribed level.

TPMS with Tire Fill Assist provides visual and audible assistance during tire pressure adjustment. With the power mode in ON, while you adjust tire pressure up or down, the system alerts you as follows:

**Below recommended pressure:** The beeper sounds and exterior lights flash once every five seconds.

**At recommended pressure:** The beeper sounds and exterior lights flash rapidly for three seconds with five seconds intervals.

**Above recommended pressure:** The beeper sounds and lights flash twice every two seconds.

\* Not available on all models

## If the Transmission System Indicator Blinks along with the Warning Message

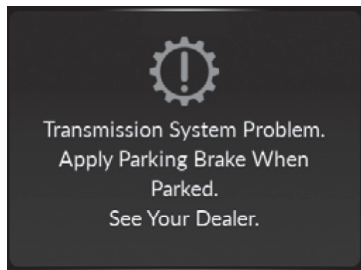

### ■ Reasons for the indicator to blink

The transmission is malfunctioning.

### ■ What to do when the indicator blinks

- Immediately have your vehicle inspected by a dealer.
- Put the transmission into **N** after starting the engine.
  - ▶ Check if the **N** position in the instrument panel and the indicator on the **N** button light/blink.
  - ▶ The engine cannot be turned on unless the parking brake is set.
    - ▶ **Emergency Towing** P. 372

### ▶ If the Transmission System Indicator Blinks along with the Warning Message

You may not be able to start the engine.

Make sure to set the parking brake when parking your vehicle.

Call a professional towing service if you need to tow your vehicle.

▶ **Emergency Towing** P. 612

## Fuse Locations

If any electrical devices are not working, set the power mode to VEHICLE OFF (LOCK) and check to see if any applicable fuse is blown.

### ■ Engine Compartment Fuse Box Type A

Fuse locations are shown on the fuse box cover. Locate the fuse in question by the fuse number and box cover number.

Located at the engine compartment on the left side. Push the tabs to open the box.

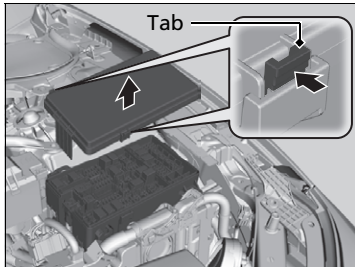

### ■ Circuit protected and fuse rating

	Circuit Protected	Amps
1	FUSE BOX MAIN	60 A
	PREMIUM AMP*	(40 A)
	BASE AMP*	(30 A)
	FET MODULE 1	30 A
	ST MAGNET SW	30 A
	WIPER MOTOR	30 A
	–	–
	–	(70 A)
	FUSE BOX OPTION 1	30 A
2	–	(40 A)
	DR SEAT	60 A
	IG MAIN	30 A
	FET MODULE 2	30 A
	–	(40 A)
3	–	(30 A)
	ABS/VSA MOTER	40 A
	–	(40 A)
	–	(40 A)
	BLOWER MOTER	40 A

	Circuit Protected	Amps
4	FET MODULE 3	60 A
	VST 1	(30 A)
	VST 2	(30 A)
	SUB FAN	30 A
5	R H/L LO	10 A
6	IG COIL	15 A
7	DBW	15 A
8	DR P/SEAT 2	30 A
9	INJECTOR	20 A
10	TCU 3	10 A
11	L H/L LO	10 A
12	TCU 2	10 A
13	TCU	15 A
14	MAIN RLY	15 A
15	VBS/VBU	10 A
16	BRAKE LT	5 A
17	BACK UP	10 A
18	WASHER	15 A
19	–	–
20	–	–

\* Not available on all models

Handling the Unexpected

	Circuit Protected	Amps
21	RR H/SEAT*	(20 A)
22	–	–
23	–	–
24	–	–
25	–	–
26	–	–
27	–	–
28	–	–
29	–	–
30	–	–
31	FUEL PUMP	15 A
32	STARTER CUT	10 A
33	VSA/ABS	10 A
34	DR P/SEAT 1	30 A
35	DR P/SEAT 3	30 A
36	FR DEICER*	(15 A)
37	STRLD	7.5 A
38	–	–
39	MISS SOL 2	10 A
40	IGPS (LAF)	10 A

	Circuit Protected	Amps
41	IGPS SUB	10 A
42	VBACT	10 A
46	ACC (VST)	10 A
47	METER (VST)	10 A
48	BACK UP (VST)	10 A
49	IDAS (VST)	10 A
50	BCM (VST)	10 A
51	–	–
52	–	–
53	–	–
54	–	–
55	–	–
56	–	–
57	–	–



### ■ Engine Compartment Fuse Box Type B

Located near the fuse box type A.  
Push the tabs to open the box.

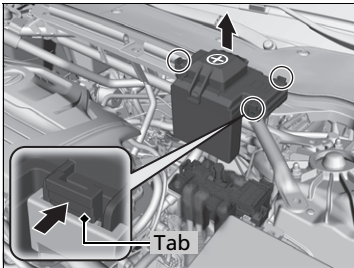

Locate the fuse in question by the fuse number and box cover number.

### ■ Circuit protected and fuse rating

	Circuit Protected	Amps
1	MAIN FUSE	150 A
2	R/B ACG	125 A
3	EPS	80 A
4	VSA	40 A
5	ESB	40 A
6	–	(30 A)
7	FAN1	30 A

### ■ Driver's Side Interior Fuse Box

Located under the dashboard.

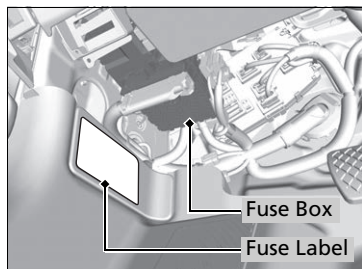

Fuse locations are shown on the label on the under panel.

Locate the fuse in question by the fuse number and label number.

### ■ Circuit protected and fuse rating

	Circuit Protected	Amps
1	–	–
2	L SIDE DOOR UNLOCK	10 A
3	R SIDE DOOR UNLOCK	10 A
4	ACC	10 A
5	–	–
6	SRS	10 A
7	–	–
8	R H/L HI	10 A

	Circuit Protected	Amps
9	SMART	10 A
10	POWER DISTRIBUTION MODULE	10 A
11	L SIDE DOOR LOCK	10 A
12	DR DOOR LOCK	(10 A)
13	R SIDE DOOR LOCK	10 A
14	A/C	10 A
15	DRL	10 A
16	CTR ACC SOCKET	20 A
17	HAZARD	10 A
18	L H/L HI	10 A
19	HORN	15 A
20	IMG	10 A
21	DR DOOR UNLOCK	(10 A)
22	–	–
23	–	–
24	–	–
25	–	–
26	–	–
27	–	–
28	–	–
29	FUSE BOX ENGINE COMPARTMENT	20 A
30	–	–

	Circuit Protected	Amps
31	–	–
32	RADIO	15 A
33	–	–
34	–	–
35	ACG	10 A
36	METER	10 A
37	OPTION	10 A
38	MOONROOF	20 A
39	–	–
40	–	–
41	–	–
42	HEATED STEERING WHEEL*	(10 A)
43	–	–
44	–	–
45	TCU	10 A
46	SRS	10 A
47	–	–
48	SBW	10 A
49	DOOR LOCK	20 A
50	FRONT ACC SOCKET	20 A
51	REAR R P/W	20 A
52	RR L P/W	20 A
53	AS P/W	20 A
54	DRIVER P/W	20 A
55	–	–

### ■ Rear Fuse Box

Located on the left side of cargo area.  
Remove the cover by pushing on the tab.

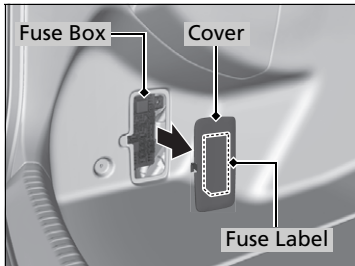

Fuse locations are shown on the cover.  
Locate the fuse in question by the fuse number and box cover number.

### ■ Circuit protected and fuse rating

	Circuit Protected	Amps
1	PASSENGER P/SEAT 2	30 A
2	BMS	10 A
3	–	(15 A)
4	4WD*	(10 A)
5	PASSENGER P/SEAT 1	30 A
6	PASSENGER P/SEAT 3	30 A
7	ACTIVE DAMPER SYSTEM*	(15 A)
8	–	–
9	–	–
10	–	–
11	–	–
12	FUEL PUMP	30 A
13	–	–
14	REAR DEFROSTER	40 A
15	4WD*	(30 A)
16	–	–
17	IG MAIN 2	30 A
18	–	–
19	–	–

\* Not available on all models

### ■ Trunk Room Fuse Box

Located under the trunk room near the ⊕ terminal on the battery.

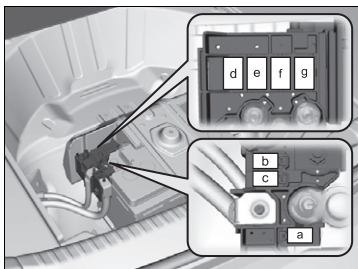
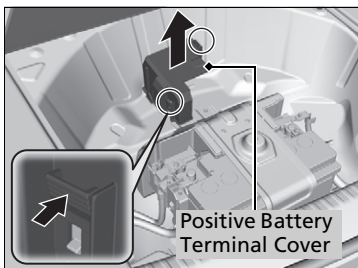

#### Models without optional spare tire

Pull up on the trunk floor lid strap, and remove the tool case.

➤ **Getting Ready to Temporarily Repair the Flat Tire** P. 570

#### Models with optional spare tire

Pull up on the trunk floor lid strap, unscrew the wing bolt, and remove the tool case. Then, remove the compact spare tire and battery cover.

➤ **Checking the Battery** P. 553

#### All models

Remove the cover on the ⊕ terminal (as shown).  
Replacement of this fuse should be done by a dealer.

### ■ Circuit protected and fuse rating

	Circuit Protected	Amps
a	Battery	450 A
b	–	150 A
c	Jump Start Box	200 A
d	–	80 A
e	Rear Box 1	70 A
f	Fuse Box 2	60 A
g	Rear Box 2	70 A

## Inspecting and Changing Fuses

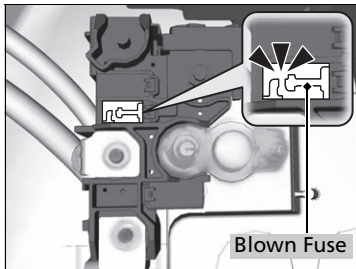
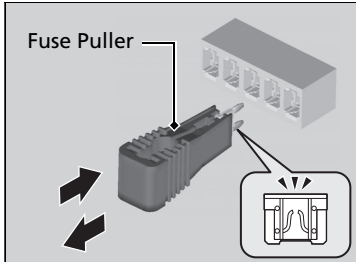
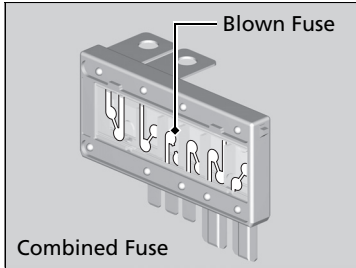

1. Set the power mode to VEHICLE OFF (LOCK). Turn headlights and all accessories off.
2. Remove the fuse box cover.
3. Check the large fuse in the engine compartment.
  - ▶ If the fuse is blown, use a Phillips-head screwdriver to remove the screw and replace it with a new one.
4. Inspect the small fuses in the engine compartment and the vehicle interior.
  - ▶ If there is a blown fuse, remove it with the fuse puller and replace it with a new one.
5. Check the fuses on the battery in the trunk room.
  - ▶ If the fuse is blown, have it replaced by a dealer.

### Inspecting and Changing Fuses

#### NOTICE

Replacing a fuse with one that has a higher rating greatly increases the chances of damaging the electrical system.

Use the charts to locate the fuse in question and confirm the specified amperage on the fuse label.

➤ **Fuse Locations** P. 605

Replace fuse with a spare fuse of the same specified amperage.

There is a fuse puller on the back of the engine compartment fuse box cover type A.

Call a professional towing service if you need to tow your vehicle.

## AWD models

### ■ Flat bed equipment

The operator loads your vehicle on the back of a truck.

**This is the only way you can safely transport your vehicle.**

Any other towing method will damage the vehicle's drive system.

## 2WD models

### ■ Flat bed equipment

The operator loads your vehicle on the back of a truck.

**This is the best way to transport your vehicle.**

### ■ Wheel lift equipment

The tow truck uses two pivoting arms that go under the front tires and lift them off the ground. The rear tires remain on the ground. **This is an acceptable way to tow your vehicle.**

## » Emergency Towing

### NOTICE

Trying to lift or tow your vehicle by the bumpers will cause serious damage. The bumpers are not designed to support the vehicle's weight.

### 2WD models

Make sure the parking brake is released. If you cannot release the parking brake, your vehicle must be transported by the flat bed equipment.

➤ **Parking Brake** P. 483

### NOTICE

Improper towing such as towing behind a motorhome or other motor vehicle can damage the transmission.

Never tow your vehicle with just a rope or chain. It is very dangerous since ropes or chains may shift from side to side or break.

## ■ What to Do If Unable to Unlock the Fuel Fill Door

If you cannot unlock the fuel fill door, use the following procedure.

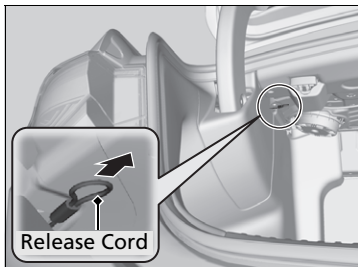

1. Open the trunk.
2. Pull the release cord towards you.
  - ▶ The release cord unlocks the fuel fill door when it is pulled.
3. Open the fuel fill door.

➤ **How to Refuel** P. 514

## ☒ If You Cannot Unlock the Fuel Fill Door

After taking these steps, contact a dealer to have the vehicle checked.

## ■ What to Do If Unable to Open the Trunk

If you cannot open the trunk, use the following procedure.

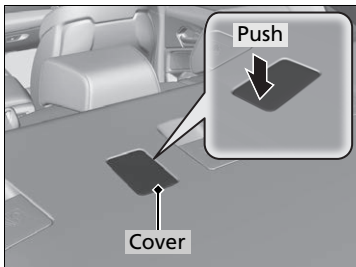

1. Remove the cover located behind the rear seat.

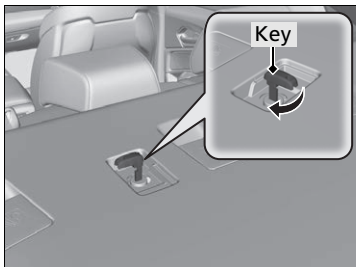

2. Insert the key into the cylinder and turn the key to the right.
  - ▶ The trunk unlocks and opens.

## ☒ If You Cannot Open the Trunk

Following up:

After taking these steps, contact a dealer to have the vehicle checked.



## Refueling From a Portable Fuel Container

If you have run out of fuel and need to refuel your vehicle from a portable fuel container, use the funnel provided with your vehicle.

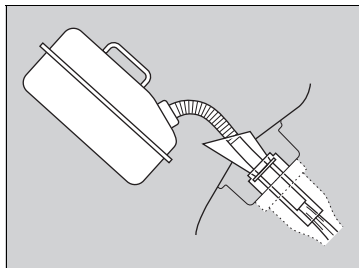
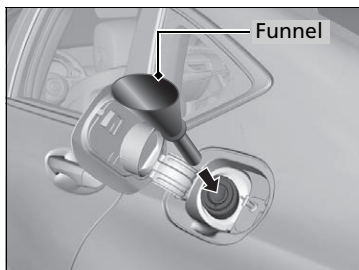

1. Turn off the engine.
2. Press on the edge of the fuel fill door to make it pop up slightly.
  - ▶ The fuel fill door opens.
  - ▶ **How to Refuel** P. 514
3. Take the funnel out of the tool case in the trunk.
  - ▶ **Types of Tools** P. 568
4. Place the end of the funnel on the lower part of filler opening, then insert it slowly and fully.
  - ▶ Make sure that the end of the funnel goes down along with the filler pipe.
5. Fill the tank with fuel from the portable fuel container.
  - ▶ Pour fuel carefully so you do not spill any.
6. Remove the funnel from the filler neck.
  - ▶ Wipe up any fuel from the funnel before storing it.
7. Shut the fuel fill door by hand.

### Refueling From a Portable Fuel Container

#### **WARNING**

Gasoline is highly flammable and explosive. You can be burned or seriously injured when handling fuel.

- Stop the engine, and keep heat, sparks, and flame away.
- Handle fuel only outdoors.
- Wipe up spills immediately.

#### **NOTICE**

Do not insert the nozzle of a portable fuel container or any funnel other than the one provided with your vehicle. Doing so can damage the fuel system. Do not try to pry open or push open the sealed fuel tank with foreign objects. This can damage the fuel system and its seal.

Make sure the fuel in the portable fuel container is gasoline before you refuel.



# Information

This chapter includes your vehicle's specifications, locations of identification numbers, and other information required by regulation.

<b>Specifications</b> .....	618
<b>Identification Numbers</b>	
Vehicle Identification Number (VIN), Engine Number, and Transmission Number .....	620
<b>Devices that Emit Radio Waves</b> .....	621
<b>Reporting Safety Defects</b> .....	622
<b>Emissions Testing</b>	
Testing of Readiness Codes .....	623
<b>Warranty Coverages</b> .....	625
<b>Authorized Manuals</b> .....	628
<b>Client Service Information</b> .....	629

## ■ Vehicle Specifications

Model	TLX
No. of Passengers:	
Front	2
Rear	3
Total	5
<b>Weights:</b>	
Gross Vehicle Weight Rating	See the certification label on the driver's doorjamb
Gross Axle Weight Rating (Front)	See the certification label on the driver's doorjamb
Gross Axle Weight Rating (Rear)	See the certification label on the driver's doorjamb

## ■ Air Conditioning

Refrigerant Type	HFO-1234yf (R-1234yf)
Charge Quantity	17.8 – 19.6 oz (505 – 555 g)
Lubricant Type	ND-OIL 14(POE)
Quantity	4.27 – 5.19 cu-in (70 – 85 cm <sup>3</sup> )

## ■ Engine Specifications

Displacement	121.76 cu-in (1,996 cm <sup>3</sup> )
Spark Plugs	NGK DILKAR8P8SY

## ■ Fuel

Type	Unleaded premium gasoline, Pump octane number of 91 or higher
Fuel Tank Capacity	15.9 US gal (60 L)

## ■ Washer Fluid

Tank Capacity	U.S.: 2.6 US qt (2.5 L) Canada: 5.8 US qt (5.5 L)
---------------	--

## ■ Light Bulbs

Headlights (Low Beam)	LED
Headlights (High Beam)	LED
Fog Lights*	LED
Front Turn Signal Lights	LED
Parking/Daytime Running Lights	LED
Front Side Marker Lights	LED
Side Turn Signal Lights (on Door Mirrors)	LED
Brake Lights	LED
Brake/Taillights/Rear Side Marker Lights	LED
Brake/Taillights	LED
Back-Up Lights	LED
Rear Turn Signal Lights	LED
High-Mount Brake Light	LED
Rear License Plate Light	LED
Puddle Lights*	LED
<b>Interior Lights</b>	
Front and Rear Map Lights	LED
Front and Rear Ambient Lights	LED
Vanity Mirror Lights	1.4 W
Console Compartment Light	LED
Glove Box Light	1.4 W
Door Inner Handle Lights	LED
Trunk Light	5 W
Foot Lights*	LED

■ Brake Fluid

Specified	Acura Heavy Duty Brake Fluid DOT 3
-----------	------------------------------------

■ Automatic Transmission Fluid

Specified	Acura ATF-type 2.0
-----------	--------------------

Capacity	Change	4.5 US qt (4.3 L)* <sup>1</sup>
		5.1 US qt (4.8 L)* <sup>2</sup>

\*1: 2WD models

\*2: AWD models

■ Rear Differential Fluid\*

Specified	Acura DPSF-II
-----------	---------------

Capacity	Change	1.76 US qt (1.67 L)
----------	--------	---------------------

■ Engine Oil

Recommended	-Acura Genuine Motor Oil 0W-20
	-API Premium-grade 0W-20 detergent oil

Change	4.6 US qt (4.4 L)
--------	-------------------

Capacity	Change	5.0 US qt (4.8 L)
	including filter	

■ Engine Coolant

Specified	Acura Long Life Antifreeze/Coolant Type 2
-----------	---

Ratio	50/50 with distilled water
-------	----------------------------

Capacity	1.31 US gal (4.96 L)
----------	----------------------

	(change including the remaining 0.17 US gal (0.66 L) in the reserve tank)
--	--

■ Tire

Regular	Size	235/50R18 97V
		255/40R19 96W

Regular	Pressure psi (kPa [kgf/cm <sup>2</sup> ])	Front	32 (220 [2.2])
		Rear	30 (210 [2.1]) <sup>*1</sup> 32 (220 [2.2]) <sup>*2</sup>

Compact Spare <sup>*3</sup>	Size	T145/60R20 105M
	Pressure psi (kPa [kgf/cm <sup>2</sup> ])	60 (420 [4.2])

Wheel Size	Regular	18 x 8J <sup>*1</sup>
	Compact Spare <sup>*3</sup>	19 x 8 1/2J <sup>*2</sup>

	Compact Spare <sup>*3</sup>	20 x 4 1/2T
--	-----------------------------	-------------

For the tire size information, see the label on driver's doorjamb.

\*1: Models with 235/50R18 tires

\*2: Models with 255/40R19 tires

\*3: Vehicles with optional spare tire

\* Not available on all models

## Vehicle Identification Number (VIN), Engine Number, and Transmission Number

Your vehicle has a 17-digit vehicle identification number (VIN) used to register your vehicle for warranty purposes, and for licensing and insuring your vehicle. The locations of your vehicle's VIN, engine number, and transmission number are shown as follows.

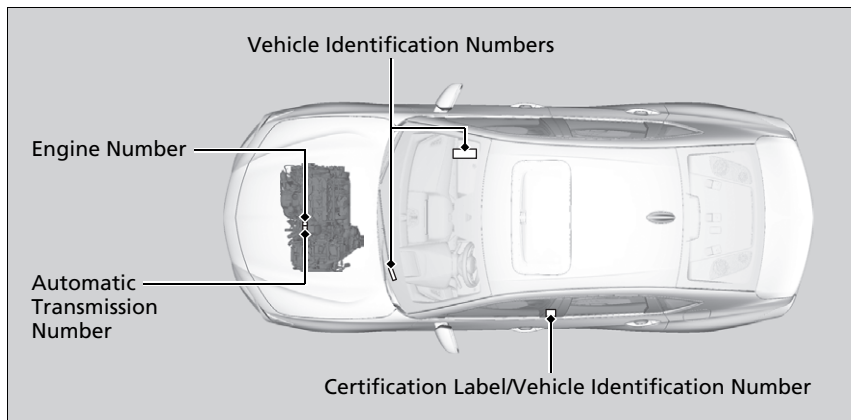

### Vehicle Identification Number (VIN), Engine Number, and Transmission Number

The interior vehicle identification number (VIN) is located under the cover.

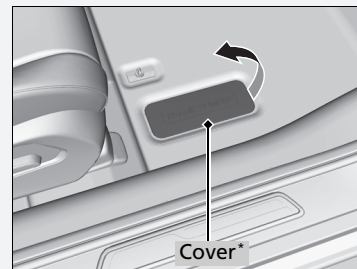

Each radio frequency device installed in the vehicle conforms to the requirements and standards of the regulation listed below:

As required by the FCC:

This device complies with Part 15 of the FCC rules. Operation is subject to the following two conditions: (1) This device may not cause harmful interference, and (2) this device must accept any interference received, including interference that may cause undesired operation.

Changes or modifications not expressly approved by the party responsible for compliance could void the user's authority to operate the equipment.

This device complies with Industry Canada licence-exempt RSS standard(s).

Operation is subject to the following two conditions: (1) this device may not cause interference, and (2) this device must accept any interference, including interference that may cause undesired operation of the device.

In the U.S.

If you believe that your vehicle has a defect which could cause a crash or could cause injury or death, you should immediately inform the National Highway Traffic Safety Administration (NHTSA) in addition to notifying American Honda Motor Co., Inc.

If NHTSA receives similar complaints, it may open an investigation, and if it finds that a safety defect exists in a group of vehicles, it may order a recall and remedy campaign. However, NHTSA cannot become involved in individual problems between you, your dealer, or American Honda Motor Co., Inc.

To contact NHTSA, you may call the Vehicle Safety Hotline toll-free at 1-888-327-4236 (TTY: 1-800-424-9153); go to <http://www.safercar.gov>; or write to: Administrator, NHTSA, 1200 New Jersey Avenue, SE., Washington, DC 20590. You can also obtain other information about motor vehicle safety from <http://www.safercar.gov>.

In Canada

If you believe that your vehicle has a defect which could cause a crash or could cause injury or death, you should immediately inform Honda Canada Inc. and you may also inform Transport Canada.

If Transport Canada receives similar complaints, it may open an investigation, and if it finds that a safety defect exists in a group of vehicles, it may lead to a recall and remedy campaign. However, Transport Canada cannot become involved in individual problems between you, your dealer, or Honda Canada Inc.

To contact Transport Canada's Defect Investigations and Recalls Division, you may call 1-800-333-0510. For more information on reporting safety defects or about motor vehicle safety, go to <http://www.tc.gc.ca/roadsafety>.



## Testing of Readiness Codes

Your vehicle has readiness code as part of the onboard self diagnostic system. Some states use these codes for testing to verify whether your vehicle's emissions components are working properly. The codes may not be read properly if testing is performed just after the battery has gone dead or been disconnected.

To check if they are set, set the power mode to ON, without starting the engine. The malfunction indicator lamp will come on for several seconds. If it then goes off, the readiness codes are set. If it blinks five times, the readiness codes are not set.

If you are required to have your vehicle tested before the readiness codes are ready, prepare the vehicle for retesting by doing the following:

1. Fill the gas tank to approximately 3/4 full.
2. Park the vehicle and leave the engine off for 6 hours or more.
3. Make sure the ambient temperature is between 40°F and 95°F (4°C and 35°C).
4. Start the engine without touching the accelerator pedal, and let it idle for 20 seconds.
5. Keep the vehicle in **P**. Increase the engine speed to 2,000 rpm, and hold it there for about 3 minutes.
6. Let the engine idle with your foot off the accelerator for 20 seconds.

### Testing of Readiness Codes

The readiness codes are erased when the battery is disconnected, and set again only after several days of driving under a variety of conditions.

If a testing facility determines that the readiness codes are not set, you may be requested to return at a later date to complete the test.

If the testing facility determines the readiness codes are still not set, see a dealer.

7. Select a nearby, lightly traveled major highway where you can maintain a speed of 50 to 60 mph (80 to 97 km/h) for at least 20 minutes. Drive on the highway in **D**. Do not use cruise control. When traffic allows, drive for 90 seconds without moving the accelerator pedal. (Vehicle speed may vary slightly; this is okay.) If you cannot do this for a continuous 90 seconds because of traffic conditions, drive for at least 30 seconds, then repeat it two more times (for a total of 90 seconds).
8. Drive in city or suburban traffic for at least 10 minutes. When traffic conditions allow, let the vehicle coast for several seconds without using the accelerator pedal or the brake pedal.
9. Park the vehicle and leave the engine off for 30 minutes.

## ■ U.S. Owners

Your new vehicle is covered by these warranties:

***New Vehicle Limited Warranty*** – covers your new vehicle, except for the emissions control systems and accessories, against defects in materials and workmanship.

***Emissions Control Systems Defects Warranty and Emissions Performance Warranty*** – these two warranties cover your vehicle's emissions control systems. Time, mileage, and coverage are conditional. Please read your warranty booklet for exact information.

***Seat Belt Limited Warranty*** – a seat belt that fails to function properly is covered by a limited warranty. Please read your warranty booklet for details.

***Rust Perforation Limited Warranty*** – all exterior body panels are covered against rusting from the inside out for the specified time period, regardless of mileage.

***Accessory Limited Warranty*** – Acura accessories are covered under this warranty. Time and mileage limits depend on the type of accessory and other factors. Please read your warranty booklet for details.

***Replacement Parts Limited Warranty*** – covers all Acura replacement parts against defects in materials and workmanship.

**Replacement Battery Limited Warranty** – provides prorated coverage for a replacement battery purchased from your dealer.

**Replacement Muffler Lifetime Limited Warranty** – provides coverage for as long as the purchaser of the muffler owns the vehicle.

Restrictions and exclusions apply to all these warranties. Please read the Acura warranty information booklet that came with your vehicle for precise information on warranty coverages. Your vehicle's original tires are covered by their manufacturer. Tire warranty information is in a separate booklet.

■ **Statement on Warranty Coverage for Aftermarket and Recycled Parts**

The Magnuson-Moss Warranty Act, 15 U.S.C. s.2301 et seq., makes it illegal for motor vehicle manufacturers to void a motor vehicle warranty or deny warranty coverage solely because an aftermarket or recycled part has been used to repair the vehicle or someone other than the authorized service provider performed service on the vehicle. This provision does not apply to a new motor vehicle purchased solely for commercial or industrial use.

Under federal law, a manufacturer may deny warranty coverage and charge for repairs to a vehicle if it is discovered that an aftermarket or recycled part installed on the vehicle is defective or was installed incorrectly and caused damage to another part of the vehicle otherwise covered under warranty. The Federal Trade Commission requires that a manufacturer demonstrate that an aftermarket or recycled part or service performed by a person other than an authorized service provider caused damage to another part of the vehicle otherwise covered under warranty before denying warranty coverage. Additionally, federal law allows a manufacturer to void a motor vehicle warranty or deny warranty coverage if the manufacturer provides the article or service to consumers free of charge under the warranty or the manufacturer has secured a waiver from the Federal Trade Commission.

#### ■ Canadian Owners

Please refer to the warranty manual that came with your vehicle.

#### ■ EPA Contact Information

An owner may obtain further information concerning emission warranties or report violations of the terms of the emission warranties by contacting:

Director,  
Light-Duty Vehicle Center,  
U.S. Environmental Protection Agency,  
Attention: Warranty Claim  
2000 Traverwood Drive,  
Ann Arbor, MI 48105;  
[complianceinfo@epa.gov](mailto:complianceinfo@epa.gov)

## ■ Service Express

For electronic copies of service publications, you can purchase a subscription to Service Express. Visit [www.techinfo.acura.com](http://www.techinfo.acura.com) for pricing and options.

## ■ For U.S. Owners

Manuals can be purchased from Helm Incorporated. You can order a manual by phone at 1 (800) 782-4356 (credit card orders only), or online at [www.helminc.com](http://www.helminc.com).

## ■ For Canadian Owners

Please contact a dealer to order any manuals that you may require.

Acura dealership personnel are trained professionals who should be able to deal with any problems you may encounter with your vehicle. If, however, you are faced with a problem that they cannot resolve to your satisfaction, contact Acura Client Relations/Services.

## U.S. Owners

American Honda Motor Co., Inc.  
Acura Client Relations  
Mail Stop 100-5E-8F  
1919 Torrance Blvd.  
Torrance, CA 90501-2746  
Tel: 1 (800) 382-2238

## Canadian Owners

Honda Canada Inc.  
Acura Client Services  
180 Honda Boulevard Markham, ON  
L6C 0H9  
Tel: 1-888-9-ACURA-9  
Fax: 1-877-939-0909  
E-mail: [acura\\_cr@ch.honda.com](mailto:acura_cr@ch.honda.com)

## In Puerto Rico and the U.S. Virgin Islands

Bella International  
P.O. Box 190816  
San Juan, PR 00919-0816  
Tel: 1 (787) 620-7546

## Client Service Information

When you call or write, please give us the following information:

- Vehicle Identification Number
  - ▣ **Vehicle Identification Number (VIN), Engine Number, and Transmission Number** P. 620
- Date of purchase
- Odometer reading of your vehicle
- Your name, address, and telephone number
- A detailed description of the problem
- Name of the dealer who sold the vehicle to you

## A

ABS (Anti-lock Brake System).....	490
Accessories and Modifications.....	565
Accessory Power Sockets.....	187
AcuraLink®.....	356
AcuraWatch™.....	23, 413
Adaptive Cruise Control (ACC) with Low Speed Follow.....	93, 428
Additives	
Coolant.....	535
Engine Oil.....	530
Washer.....	538
Additives, Engine Oil.....	530
Adjusting	
Armrest.....	177
Front Seats.....	166
Head Restraints.....	172
Mirrors.....	163
Steering Wheel.....	162
Agile Handling Assist.....	404
Air Conditioning System (Climate Control System).....	195
Defrosting the Windshield and Windows.....	197
Dust and Pollen Filter.....	559
Sensors.....	199
Synchronized Mode.....	198
Air Pressure.....	545, 619
Airbags.....	43
Advanced Airbags.....	49
Airbag Care.....	60

Driver's Knee Airbag.....	51
Event Data Recorder.....	0
Front Airbags (SRS).....	46
Indicator.....	57, 88
Passenger Airbag Off Indicator.....	58
Sensors.....	43
Side Airbags.....	54
Side Curtain Airbags.....	56
AM/FM Radio.....	236
Android Auto.....	270
Anti-lock Brake System (ABS).....	490
Indicator.....	88
Apple CarPlay.....	266
Armrest.....	177
AT&T Hotspot.....	264
Audio Remote Controls.....	206
Audio System.....	202
Adjusting the Sound.....	231
Audio/Information Screen.....	212
Auxiliary Input Jack.....	204
Display Setup.....	232
Error Messages.....	274
General Information.....	277
Home Screen.....	216
How to Update Wirelessly.....	225
How to Update with a USB Device.....	229
How to use Siri Eyes Free.....	265
iPod.....	253
Limitations for Manual Operation.....	232
MP3/WMA/AAC.....	256
Reactivating.....	205

Remote Controls.....	206
Security Code.....	205
Status Area.....	221
System Updates.....	225
Theft Protection.....	205
True Touchpad Interface.....	209
USB Flash Drives.....	256, 279
USB Ports.....	203
Audio/Information Screen.....	212
Authorized Manuals.....	628
Auto Door Locking/Unlocking.....	133
Auto High-Beam.....	152
Indicator.....	90
Auto Idle Stop.....	395
OFF Button.....	397
Automatic Brake Hold.....	488
Indicator.....	82, 488
Automatic Folding Door Mirror.....	165
Automatic Lighting.....	149
Automatic Transmission.....	379
Creeping.....	379
Kickdown.....	379
Operating the Shift Button.....	20, 382
Shifting.....	380
Auxiliary Input Jack.....	204
Average Fuel Economy.....	102

## B

## Battery

Charging (Battery).....	556
-------------------------	-----



Charging System Indicator .....	83, 598
If the Battery Is Dead.....	593
Maintenance (Checking the Battery) .....	553
<b>Belts (Seat)</b> .....	36
<b>Beverage Holders</b> .....	182
<b>Blind spot information System</b> .....	410
<b>Bluetooth® Audio</b> .....	259
<b>Bluetooth® HandsFreeLink®</b> .....	327
<b>Booster Seats (For Children)</b> .....	74
<b>Brake System</b> .....	483
Anti-lock Brake System (ABS) .....	490
Automatic Brake Hold.....	488
Brake Assist System.....	491
Fluid .....	538
Foot Brake .....	487
Indicator .....	80, 81, 82, 600
Indicator (Red) .....	602
Parking Brake.....	483
<b>Brightness Control (Instrument Panel)</b> ...	157
<b>Built-in Key</b> .....	119
<b>Bulb Replacement</b> .....	539
Brake, Rear Turn Signal and Taillight/Rear Side Marker Lights .....	540
Fog Lights.....	539
Front Turn Signal, Parking/Daytime Running and Front Side Marker Lights...	539
Headlights .....	539
High-Mount Brake Light.....	540
Puddle Lights .....	540
Rear License Plate Light.....	540

Side Turn Signal/Emergency Indicator Lights .....	539
Taillights and Back-Up Lights .....	540
<b>Bulb Specifications</b> .....	618

## C

<b>CAMERA Button</b> .....	506
<b>Carbon Monoxide Gas</b> .....	75
<b>Carrying Cargo</b> .....	367, 369
<b>Certification Label</b> .....	620
<b>Changing Bulbs</b> .....	539
<b>Charging System Indicator</b> .....	83, 598
<b>Child Safety</b> .....	61
Childproof Door Locks.....	132
<b>Child Seat</b> .....	61
Booster Seats.....	74
Child Seat for Infants.....	63
Child Seat for Small Children .....	64
Installing a Child Seat with a Lap/Shoulder Seat Belt .....	69
Larger Children.....	73
Rear-facing Child Seat .....	63
Selecting a Child Seat .....	65
Using a Tether .....	71
<b>Childproof Door Locks</b> .....	132
<b>Cleaning the Exterior</b> .....	562
<b>Cleaning the Interior</b> .....	560
<b>Client Service Information</b> .....	629

<b>Climate Control System</b> .....	195
Defrosting the Windshield and Windows.....	197
Dust and Pollen Filter.....	559
Sensors .....	199
Synchronized Mode.....	198
<b>Clock</b> .....	116
<b>CMBS™ (Collision Mitigation Braking System™)</b> .....	417
<b>Coat Hooks</b> .....	184
<b>Collision Mitigation Braking System™ (CMBS™)</b> .....	417
<b>Compact Spare Tire (Optional)</b> .....	583, 619
<b>Console Compartment</b> .....	181
<b>Controls</b> .....	115
<b>Coolant (Engine)</b> .....	535
Adding to the Radiator.....	536
Adding to the Reserve Tank.....	535
Overheating .....	595
<b>Creeping (Automatic Transmission)</b> .....	379
<b>Cross Traffic Monitor</b> .....	498
<b>Cup Holders</b> .....	182
<b>Customized Features</b> .....	300
<b>D</b>	
<b>Daytime Running Lights</b> .....	151
<b>Dead Battery</b> .....	593
<b>Defaulting All the Settings</b> .....	323
<b>Defrosting the Windshield and Windows</b> .....	197

Devices that Emit Radio Waves.....	621
<b>Dimming</b>	
Headlights .....	148
Rearview Mirror.....	163
Dipstick (Engine Oil).....	531
Directional Signals (Turn Signal).....	147
Door Mirrors .....	164
<b>Doors</b> .....	118
Auto Door Locking .....	133
Auto Door Unlocking.....	133
Door Open Indicator .....	35
Keys .....	118
Locking/Unlocking the Doors from the Inside.....	15, 130
Locking/Unlocking the Doors from the Outside.....	121
Lockout Prevention System .....	128
DOT Tire Quality Grading .....	547
Driver Attention Monitor.....	107
<b>Driving</b> .....	365
Automatic Transmission.....	379
Braking.....	483
Shifting Gear .....	380
Starting the Engine.....	372
Driving Position Memory System.....	160
Dust and Pollen Filter .....	559
Dynamic Mode Switch.....	389

## E

<b>Electric Power Steering (EPS) System</b>	
Indicator.....	88, 601
<b>Electronic Stability Control (ESC)</b> .....	402
<b>Emergency</b> .....	612
<b>Emissions Testing (Readiness Codes)</b> .....	623
<b>Engine</b> .....	620
Coolant.....	535
If the Battery Is Dead .....	593
Oil.....	530
Remote Engine Start.....	374
Starting.....	372
<b>Engine Coolant</b> .....	535
Adding to the Radiator.....	536
Adding to the Reserve Tank.....	535
Overheating .....	595
Temperature Gauge .....	97
<b>Engine Oil</b> .....	530
Adding.....	532
Checking.....	531
Displaying Oil Life.....	521
Low Oil Pressure Indicator .....	597
Recommended Engine Oil .....	530
<b>ENGINE START/STOP Button</b> .....	144
Exhaust Gas Hazard (Carbon Monoxide) ..	75
Exterior Care (Cleaning).....	562
Exterior Mirrors .....	164

## F

<b>Features</b> .....	201
-----------------------	-----

## Filters

Dust and Pollen.....	559
Oil .....	533
<b>Flat Tire</b> .....	569
<b>Floor Mats</b> .....	561
<b>Fluids</b>	
Automatic Transmission .....	537
Brake .....	538
Engine Coolant .....	535
Windshield Washer .....	538
<b>FM/AM Radio</b> .....	236
<b>Fog Lights</b> .....	151
Indicator .....	90
<b>Foot Brake</b> .....	487
<b>Front Airbags (SRS)</b> .....	46
<b>Front Seats</b> .....	166
Adjusting.....	166
<b>Front Sensor Camera</b> .....	480
<b>Fuel</b> .....	22, 513
Economy.....	516
Gauge .....	97
Instant Fuel Economy .....	102
Low Fuel Indicator.....	87
Range .....	102
Recommendation.....	513, 618
Refueling .....	513
<b>Fuel Economy</b> .....	516
<b>Fuel Fill Door</b> .....	22, 514
<b>Fuses</b> .....	605
Inspecting and Changing.....	611
Locations .....	605

## G

### Gasoline (Fuel)

Economy.....	516
Gauge .....	97
Information.....	513
Instant Fuel Economy .....	102
Low Fuel Indicator.....	87
Refueling .....	513

### Gauges.....

### Glass (care).....

### Glove Box.....

## H

### Handling the Unexpected.....

### HandsFreeLink® (HFL).....

Automatic Import of Cellular Phonebook and Call History.....	338
Automatic Transferring .....	337
Displaying Messages .....	350
Favorite Contacts .....	339
HFL Buttons .....	327
HFL Menus.....	331
HFL Status Display.....	329
In Case of Emergency .....	360
Limitations for Manual Operation.....	330
Making a Call .....	340
Options During a Call.....	344
Phone Setup .....	333
Receiving a Call.....	343
Receiving a Text Message.....	348

### Ring Tone.....

### Selecting a Phone .....

### To Set Up a Text Message Options.....

### Hazard Warning Button.....

### HD Radio™.....

### Head Restraints.....

### Headlights.....

### Aiming .....

### Auto High-Beam System.....

### Automatic Operation.....

### Dimming .....

### Operating.....

### Head-Up Display .....

### Heated Steering Wheel.....

### Heaters (Seat) .....

### HFL (HandsFreeLink®).....

### High Beam Indicator .....

### Hill Start Assist System .....

### HomeLink® Universal Transceiver.....

### Honda App License Agreement.....

## I

### Identification Numbers .....

### Vehicle Identification Number (VIN),

### Engine Number and Transmission

### Number .....

### llumination Control.....

### Immobilizer System .....

### Indicator .....

### Indicators.....

### Adaptive Cruise Control (ACC) with Low

### Speed Follow (Amber) .....

### Adaptive Cruise Control (ACC) with Low

### Speed Follow (White/Green).....

### Anti-lock Brake System (ABS).....

### Auto High-Beam .....

### Auto Idle Stop (Green).....

### Auto Idle Stop OFF .....

### Auto Idle Stop Suspend.....

### Auto Idle Stop System (Amber).....

### Automatic Brake Hold .....

### Automatic Brake Hold System .....

### Charging System.....

### Cruise Mode Indicator (White/Green) .....

### Door and Trunk Open .....

### Electric Power Steering (EPS) System..

### Fog Light.....

### High Beam .....

### Immobilizer System .....

### Lane Keeping Assist System (LKAS)

### (Amber).....

### Lane Keeping Assist System (LKAS)

### (White/Green).....

### Lights On .....

### Low Fuel .....

### Low Oil Pressure.....

### Low Tire Pressure/TPMS.....

### M (sequential mode) Indicator/Gear

### Selection Indicator .....

### Maintenance Minder .....

- Malfunction Indicator Lamp ..... 83, 599
  - Parking Brake and Brake System
    - (Amber) ..... 82, 602
  - Parking Brake and Brake System (Red) ..... 80, 81, 600, 602
  - Safety Support Indicator (Amber) ..... 94
  - Safety Support Indicator (Green/Gray) ..... 96
  - Seat Belt Reminder ..... 37, 87
  - Security System Alarm ..... 91
  - Shift Position ..... 83
  - Super Handling-All Wheel Drive™ (SH-AWD®) ..... 92
  - Supplemental Restraint System ..... 57, 88
  - System Message ..... 92
  - Transmission System ..... 84
  - Turn Signal and Hazard Warning ..... 90
  - Vehicle Stability Assist™ (VSA®) OFF... 89, 403
  - Vehicle Stability Assist™ (VSA®) System ..... 89, 402
  - Information ..... 617
  - Instant Fuel Economy ..... 102
  - Instrument Panel ..... 77
    - Brightness Control ..... 157
  - Integrated Dynamics System ..... 388
    - Dynamic Mode Switch ..... 389
  - Interior Convenience Items ..... 187
  - Interior Lights ..... 178
  - Interior Rearview Mirror ..... 163
  - iPad ..... 278
  - iPhone ..... 278
  - iPod ..... 253, 278
- J**
- Jack (Wheel Nut Wrench) ..... 586
  - Jump Starting ..... 593
- K**
- Key Number Tag ..... 120
  - Keyless Access System ..... 121
  - Keyless Lockout Prevention ..... 128
  - Keys ..... 118
    - Lockout Prevention ..... 128
    - Number Tag ..... 120
    - Rear Door Won't Open ..... 132
    - Remote Transmitter ..... 126
    - Two-way Keyless Access Remote ..... 129, 374
    - Types and Functions ..... 118
  - Kickdown (Automatic Transmission) ..... 379
  - Knee Airbags ..... 51
- L**
- Lane Keeping Assist System (LKAS) ..... 448
  - LATCH (Child Seats) ..... 66
  - Legal Information ..... 292
  - License Information ..... 295
  - Lights ..... 148, 539
    - Automatic ..... 149
    - Bulb Replacement ..... 539
    - Daytime Running Lights ..... 151
    - Fog Lights ..... 151
    - High Beam Indicator ..... 90
    - Interior ..... 178
    - Light Switches ..... 148
    - Lights On Indicator ..... 90
    - Turn Signals ..... 147
  - Load Limits ..... 369
  - Locking/Unlocking ..... 118
    - Auto Door Locking/Unlocking ..... 133
    - Childproof Door Locks ..... 132
    - From Inside ..... 130
    - From Outside ..... 121
    - Keys ..... 118
    - Using a Key ..... 127
  - Lockout Prevention System ..... 128
  - Low Battery Charge ..... 598
  - Low Fuel Indicator ..... 87
  - Low Keyless Access Remote Signal Strength ..... 120
  - Low Oil Pressure Indicator ..... 597
  - Lower Anchors ..... 66
  - Lubricant Specifications Chart ..... 619
  - Luggage (Maximum Load Limit) ..... 369
  - Lumbar Support ..... 166
- M**
- Maintenance ..... 103, 517
    - Battery ..... 553
    - Brake Fluid ..... 538
    - Cleaning ..... 560
    - Climate Control System ..... 559
    - Coolant ..... 535

Maintenance Minder™	521
Oil	531
Precautions	518
Radiator	536
Remote Transmitter	557, 558
Replacing Light Bulbs	539
Safety	519
Service Items	524
Tires	544
Transmission Fluid	537
Under the Hood	527
<b>Malfunction Indicator Lamp</b>	<b>83, 599</b>
<b>Map Lights</b>	<b>179</b>
<b>Maximum Load Limit</b>	<b>369</b>
<b>Meters, Gauges</b>	<b>97</b>
<b>Mirrors</b>	<b>163</b>
Adjusting	163
Door	164
Exterior	164
Interior Rearview	163
<b>Modifications (and Accessories)</b>	<b>565</b>
<b>Moonroof</b>	<b>143</b>
<b>MP3</b>	<b>256</b>
<b>MP3/WMA/AAC</b>	<b>256</b>
<b>Multi-Information Display</b>	<b>98</b>
Switching the Display	100
<b>Multi-View Rear Camera</b>	<b>503</b>
<b>N</b>	
<b>Navigation</b>	<b>102</b>

<b>Numbers (Identification)</b>	<b>620</b>
<b>O</b>	
<b>Odometer</b>	<b>98</b>
<b>Oil (Engine)</b>	<b>530, 619</b>
Adding	532
Checking	531
Displaying Oil Life	521
Low Oil Pressure Indicator	597
Recommended Engine Oil	530, 619
Viscosity	530, 619
<b>Open Source Licenses</b>	<b>294</b>
<b>Opening</b>	
Trunk	614
<b>Opening/Closing</b>	
Hood	528
Moonroof	143
Power Windows	140
Trunk	134
<b>Operating the Switches Around the Steering Wheel</b>	<b>144</b>
<b>Outside Temperature Display</b>	<b>99</b>
<b>Overheating</b>	<b>595</b>
<b>P</b>	
<b>Paddle Shifters (Sequential Mode)</b>	<b>387</b>
<b>Panic Mode</b>	<b>139</b>
<b>Parking</b>	<b>492</b>
<b>Parking Brake</b>	<b>483</b>

<b>Parking Brake and Brake System Indicator</b>	<b>600</b>
<b>Parking Brake and Brake System Indicator (Amber)</b>	<b>82</b>
<b>Parking Brake and Brake System Indicator (Red)</b>	<b>80, 81, 602</b>
<b>Parking Sensor System</b>	<b>494</b>
<b>Passenger Airbag Off Indicator</b>	<b>58</b>
<b>Passing Indicators</b>	<b>148</b>
<b>Playing Bluetooth® Audio</b>	<b>259</b>
<b>Power Windows</b>	<b>140</b>
<b>Precautions While Driving</b>	<b>378</b>
Rain	378
<b>Pregnant Women</b>	<b>41</b>
<b>Puncture (Tire)</b>	<b>569</b>
<b>R</b>	
<b>Radar Sensor</b>	<b>482</b>
<b>Radiator</b>	<b>536</b>
<b>Radio (AM/FM)</b>	<b>236</b>
<b>Radio (SiriusXM®)</b>	<b>240</b>
<b>Range</b>	<b>102</b>
<b>Readiness Codes (Emissions Testing)</b>	<b>623</b>
<b>Rear Defogger/Heated Door Mirror Button</b>	<b>159</b>
<b>Rear Seats</b>	<b>176</b>
Seat Heaters	193
<b>Rearview Mirror</b>	<b>163</b>

Refueling.....	513	Fastening .....	39	Shifting (Transmission) .....	20, 380
Fuel Gauge.....	97	Installing a Child Seat with a Lap/Shoulder Seat Belt.....	69	Shoulder Anchor .....	40
Gasoline .....	513, 618	Pregnant Women.....	41	Side Airbags .....	54
Low Fuel Indicator .....	87	Reminder .....	37	Side Curtain Airbags.....	56
Regulations .....	408, 547, 621	Warning Indicator .....	37, 87	Siri Eyes Free.....	265
Remote Engine Start with Vehicle		Seat Heaters.....	192, 193	SiriusXM® Radio .....	240
Feedback .....	374	Seat Ventilation.....	192	Snow Tires .....	552
Remote Transmitter.....	126	Seats .....	166	Spare Tire (Optional) .....	583, 619
Maintenance (Replacing).....	557	Adjusting .....	166	Spark Plugs .....	618
Replacement		Front Seats .....	166	Specifications .....	618
Battery.....	557, 558	Lumbar Support .....	166	Specified Fuel .....	513, 618
Bulbs .....	539	Rear Seats .....	176	Speed Limit Information .....	99
Fuses .....	605, 607, 608	Seat Control Interface .....	168	Speed/Distance Units .....	103
Tires .....	550	Seat Heaters.....	192, 193	Speedometer.....	97
Wiper Blade Rubber.....	541	Ventilation .....	192	Sport Gauge Settings.....	104
Reporting Safety Defects .....	622	Security System.....	137	SRS Airbags (Airbags) .....	46
Resetting a Trip Meter .....	101	Immobilizer System Indicator.....	91	Starting Assist Brake Function .....	401
Reverse Tilt Door Mirror.....	165	Security System Alarm Indicator.....	91	Starting the Engine.....	372
Road Departure Mitigation (RDM).....	469	Select Button .....	380	Does Not Start .....	590
On and Off.....	471	Operation.....	382	Engine Switch Buzzer.....	146
		Selecting a Child Seat.....	65	If the Battery Is Dead.....	593
		Sequential Mode .....	386	Remote Engine Start .....	374
		Sequential Mode Operation.....	387	Steering Wheel .....	162
		Setting the Clock .....	116	Adjusting .....	162
		SH-AWD® (Super Handling-All Wheel Drive™).....	405	Stopping .....	492
		Shift Button .....	20, 380	Storage Items .....	180
		Shift Position Indicator .....	83, 382	Summer Tires.....	552
		Shift Positions		Super Handling-All Wheel Drive™ (SH-AWD®).....	405
		Automatic Transmission .....	380	Supplemental Restraint System (SRS) .....	46
				Surround View Camera System .....	505

## S

Safe Driving.....	31
Safety Labels .....	76
Safety Message .....	3
Safety Support .....	110
Seat Belts.....	36
Adjusting the Shoulder Anchor .....	40
Automatic Seat Belt Tensioners.....	38
Checking .....	42

Switches (Around the Steering Wheel) .....	6, 7, 144
Synchronized Mode .....	198
System Message Indicator .....	92
System Updates .....	225

## T

Tachometer .....	103
Temperature	
Gauge .....	97
Outside Temperature Display .....	99
Temperature Sensor .....	99, 199
Temporary Tire Repair Kit .....	570
Time (Setting) .....	116
Tire Fill Assist .....	406
Tire Pressure Monitoring System (TPMS)	
Indicator .....	89
Tire Pressure Monitoring System (TPMS)	
with Tire Fill Assist .....	406
Indicator .....	603
Tire Fill Assist .....	406
Tire Repair Kit .....	569
Tires .....	544
Air Pressure .....	545, 619
Chains .....	552
Checking and Maintaining .....	544
Flat Tire (Puncture) .....	569, 583
Inspection .....	544
Labeling .....	545
Puncture (Flat Tire) .....	569, 583

Regulations .....	547
Rotation .....	551
Spare (Optional) .....	583, 619
Summer .....	552
Temporary Tire Repair Kit .....	570
Wear Indicators .....	549
Winter .....	552
Tools .....	568
Towing a Trailer .....	371
Towing Behind a Motorhome .....	371
Emergency .....	612
TPMS (Tire Pressure Monitoring System)	
Indicator .....	89
TPMS (Tire Pressure Monitoring System)	
with Tire Fill Assist .....	406
Indicator .....	603
Tire Fill Assist .....	406
Traffic Jam Assist .....	457
Traffic Sign Recognition System .....	474
Transmission .....	20, 380
Automatic .....	20, 380
Gear Position Indicator .....	83, 382
Number .....	620
Sequential Mode .....	386
Transmission System	
Indicator .....	84
Trip Computer .....	101
Trip Meter .....	101
Troubleshooting .....	567
Blown Fuse .....	605, 607, 608
Brake Pedal Vibrates .....	27

Buzzer Sounds When Opening Door .....	27
Emergency Towing .....	612
Engine Won't Start .....	590
Flat Tire/Puncture .....	569
Noise When Braking .....	29
Overheating .....	595
Premium Gasoline .....	513, 618
Puncture/Flat Tire .....	569, 583
Rear Door Won't Open .....	27, 132
Warning Indicators .....	78
True Touchpad Interface .....	209
Trunk .....	134
Lid .....	134
Light Bulbs .....	618
Main Switch .....	136
Unable to Open .....	614
Turn Signals .....	147
Indicators (Instrument Panel) .....	90
Turn-by-Turn Directions .....	114
Two-way Keyless Access Remote .....	129, 374

## U

Under-Floor Storage Area .....	185
Unlocking the Doors .....	121
Unlocking the Front Doors from the	
Inside .....	15, 130
USB Flash Drives .....	256, 279
USB Ports .....	203
Using the Keyless Access System .....	121

## V

Valet Mode .....	136
Vanity Mirrors .....	9
Vehicle Identification Number .....	620
Vehicle Speed .....	114
Vehicle Stability Assist™ (VSA®) .....	402
Off Button .....	403
Off Indicator .....	89, 403
System Indicator .....	89, 402
Viscosity (Oil) .....	530, 619
Voice Control Operation .....	233
Voice Portal Screen .....	234
Voice Recognition .....	233
VSA® (Vehicle Stability Assist™) .....	402

## W

Warning Indicator On/Blinking .....	597
Warning Labels .....	76
Warnings .....	103
Warranties (Warranty Manual provided separately) .....	625
Watts .....	618
Wear Indicators (Tire) .....	549
Wheel Nut Wrench (Jack Handle) .....	586
Wi-Fi Connection .....	262
Window Washers .....	155
Adding/Refilling Fluid .....	538
Switch .....	155
Windows (Opening and Closing) .....	140

## Windshield

Cleaning .....	561, 563
Defrosting/Defogging .....	197
Washer Fluid .....	538
Wiper Blades .....	541
Wipers and Washers .....	155
Winter Tires .....	552
Snow Tires .....	552
Tire Chains .....	552
Wipers and Washers .....	155
Checking and Replacing Wiper Blades .....	541
Wireless Charger .....	188
WMA .....	256
Worn Tires .....	544









**owners.acura.com (U.S.)**  
**acura.ca (Canada)**

31TGV600  
OM-13578  
00X31-TGV-6000

2021 Acura TLX Owner's Manual  
© 2020 Honda Motor Co., Ltd. — All Rights Reserved

Printed in U.S.A.