

California Proposition 65 Warning

WARNING: This product contains or emits chemicals known to the state of California to cause cancer and birth defects or other reproductive harm.

Event Data Recorders

This vehicle is equipped with an event data recorder (EDR).

The main purpose of an EDR is to record, in certain crash or near crash-like situations, such as an air bag deployment or hitting a road obstacle, data that will assist in understanding how a vehicle's systems performed. **The EDR is designed to record data related to vehicle dynamics and safety systems for a short period of time, typically 30 seconds or less. The EDR in this vehicle is designed to record such data as:**

- **How various systems in your vehicle were operating;**
- **Whether or not the driver and passenger safety belts were buckled/fastened;**
- **How far (if at all) the driver was depressing the accelerator and/or brake pedal; and,**
- **How fast the vehicle was traveling.**

These data can help provide a better understanding of the circumstances in which crashes and injuries occur. NOTE: EDR data are recorded by your vehicle only if a non-trivial crash situation occurs; no data are recorded by the EDR under normal driving conditions and no personal data (e.g., name, gender, age, and crash location) are recorded. However, other parties, such as law enforcement, could combine the EDR data with the type of personally identifying data routinely acquired during a crash investigation.

To read data recorded by an EDR, special equipment is required, and access to the vehicle or the EDR is needed. In addition to the vehicle manufacturer, other parties, such as law enforcement, that have the special equipment, can read the information if they have access to the vehicle or the EDR.

The data belongs to the vehicle owner and may not be accessed by anyone else except as legally required or with the permission of the vehicle owner.

Service Diagnostic Recorders

This vehicle is equipped with service-related devices that record information about powertrain performance. The data can be used to verify emissions law requirements and/or help technicians diagnose and solve service problems. It may also be combined with data from other sources for research purposes, but it remains confidential.

California Perchlorate Contamination Prevention Act

The airbags, seat belt tensioners, and CR type batteries in this vehicle may contain perchlorate materials - special handling may apply. See www.dtsc.ca.gov/hazardouswaste/perchlorate/

As you read this manual, you will find information that is preceded by a **NOTICE** symbol. This information is intended to help you avoid damage to your vehicle, other property, or the environment.

A Few Words About Safety

Your safety, and the safety of others, is very important. And operating this vehicle safely is an important responsibility.

To help you make informed decisions about safety, we have provided operating procedures and other information on labels and in this manual. This information alerts you to potential hazards that could hurt you or others.

Of course, it is not practical or possible to warn you about all the hazards associated with operating or maintaining your vehicle. You must use your own good judgment.

You will find this important safety information in a variety of forms, including:

- **Safety Labels** - on the vehicle.
- **Safety Messages** - preceded by a safety alert symbol  and one of three signal words: **DANGER**, **WARNING**, or **CAUTION**. These signal words mean:

 You **WILL** be KILLED or SERIOUSLY HURT if you don't follow instructions.

 You **CAN** be KILLED or SERIOUSLY HURT if you don't follow instructions.

 You **CAN** be HURT if you don't follow instructions.

- **Safety Headings** - such as Important Safety Precautions.
- **Safety Section** - such as Safe Driving.
- **Instructions** - how to use this vehicle correctly and safely.

This entire book is filled with important safety information - please read it carefully.

This owner's manual should be considered a permanent part of the vehicle and should remain with the vehicle when it is sold.

This owner's manual covers all models of your vehicle. You may find descriptions of equipment and features that are not on your particular model.

Images throughout this owner's manual (including the front cover) represent features and equipment that are available on some, but not all, models. Your particular model may not have some of these features.

This owner's manual is for vehicles sold in the United States and Canada.

The information and specifications included in this publication were in effect at the time of approval for printing. Honda Motor Co., Ltd. reserves the right, however, to discontinue or change specifications or design at any time without notice and without incurring any obligation.

➤ Safe Driving P. 25

For Safe Driving P. 26

Seat Belts P. 31

Airbags P. 39

➤ Instrument Panel P. 67

Indicators P. 68

Gauges and Multi-Information Display P. 95

➤ Controls P. 119

Setting the Clock P. 120

Locking and Unlocking the Doors P. 121

Opening and Closing the Moonroof P. 145

Adjusting the Seats P. 164

➤ Features P. 187

Audio System* P. 188

Audio System Basic Operation* P. 192

HomeLink® Universal Transceiver P. 224

➤ Driving P. 257

Before Driving P. 258

Towing a Trailer P. 263

Parking Your Vehicle P. 332

Multi-View Rear Camera P. 340

➤ Maintenance P. 345

Before Performing Maintenance P. 346

Maintenance Minder™ P. 349

Checking and Maintaining Wiper Blades P. 372

Climate Control System Maintenance P. 388

Cleaning P. 389

➤ Handling the Unexpected P. 395

Tools P. 396

If a Tire Goes Flat P. 397

Overheating P. 420

Indicator, Coming On/Blinking P. 422

➤ Information P. 431

Specifications P. 432

Identification Numbers P. 434

Emissions Testing P. 437

Warranty Coverages P. 439

Contents

Child Safety P. 52

Exhaust Gas Hazard P. 64

Safety Labels P. 65

Opening and Closing the Tailgate P. 133
Operating the Switches Around the Steering Wheel P. 146
Interior Lights/Interior Convenience Items P. 171

Security System P. 139

Opening and Closing the Windows P. 142
Adjusting the Mirrors P. 161
Climate Control System P. 182

Audio Error Messages* P. 217
Bluetooth® HandsFreeLink® P. 226

General Information on the Audio System* P. 220
Compass* P. 255

Off-Highway Driving Guidelines P. 268
Refueling P. 341

When Driving P. 270
Fuel Economy and CO₂ Emissions P. 343

Braking P. 320
Accessories and Modifications P. 344

Maintenance Under the Hood P. 353
Checking and Maintaining Tires P. 376

Replacing Light Bulbs P. 365
Battery P. 385

Remote Transmitter Care P. 386

Engine Does Not Start P. 414
Fuses P. 426

Jump Starting P. 417
Emergency Towing P. 429

Shift Lever Does Not Move P. 419
When You Cannot Open the Tailgate P. 430

Devices that Emit Radio Waves P. 435
Authorized Manuals P. 441

Reporting Safety Defects P. 436
Client Service Information P. 442

Quick Reference Guide P. 4

Safe Driving P. 25

Instrument Panel P. 67

Controls P. 119

Features P. 187

Driving P. 257

Maintenance P. 345

Handling the Unexpected P. 395



Information P. 431

Index P. 443

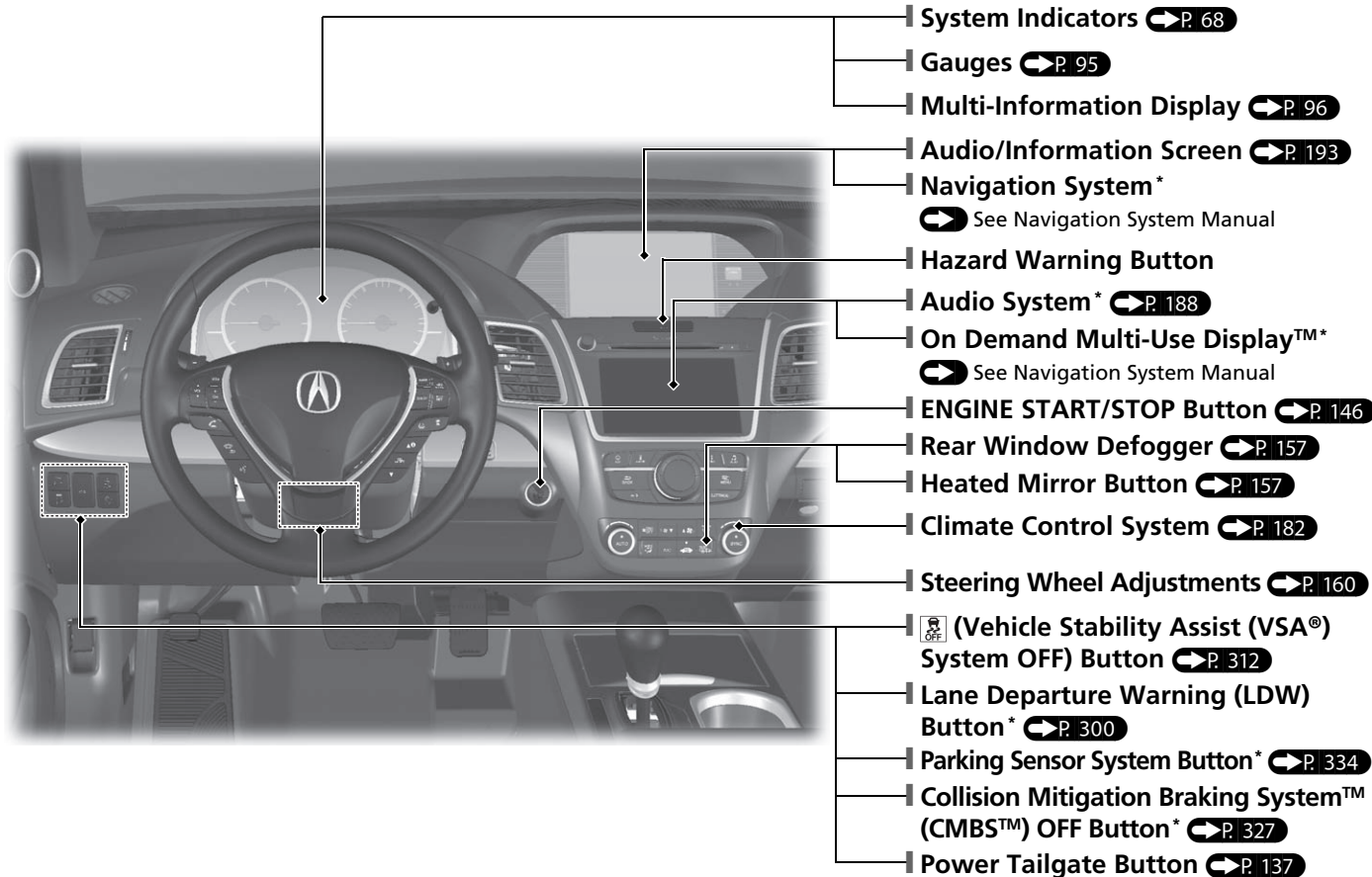
Visual Index

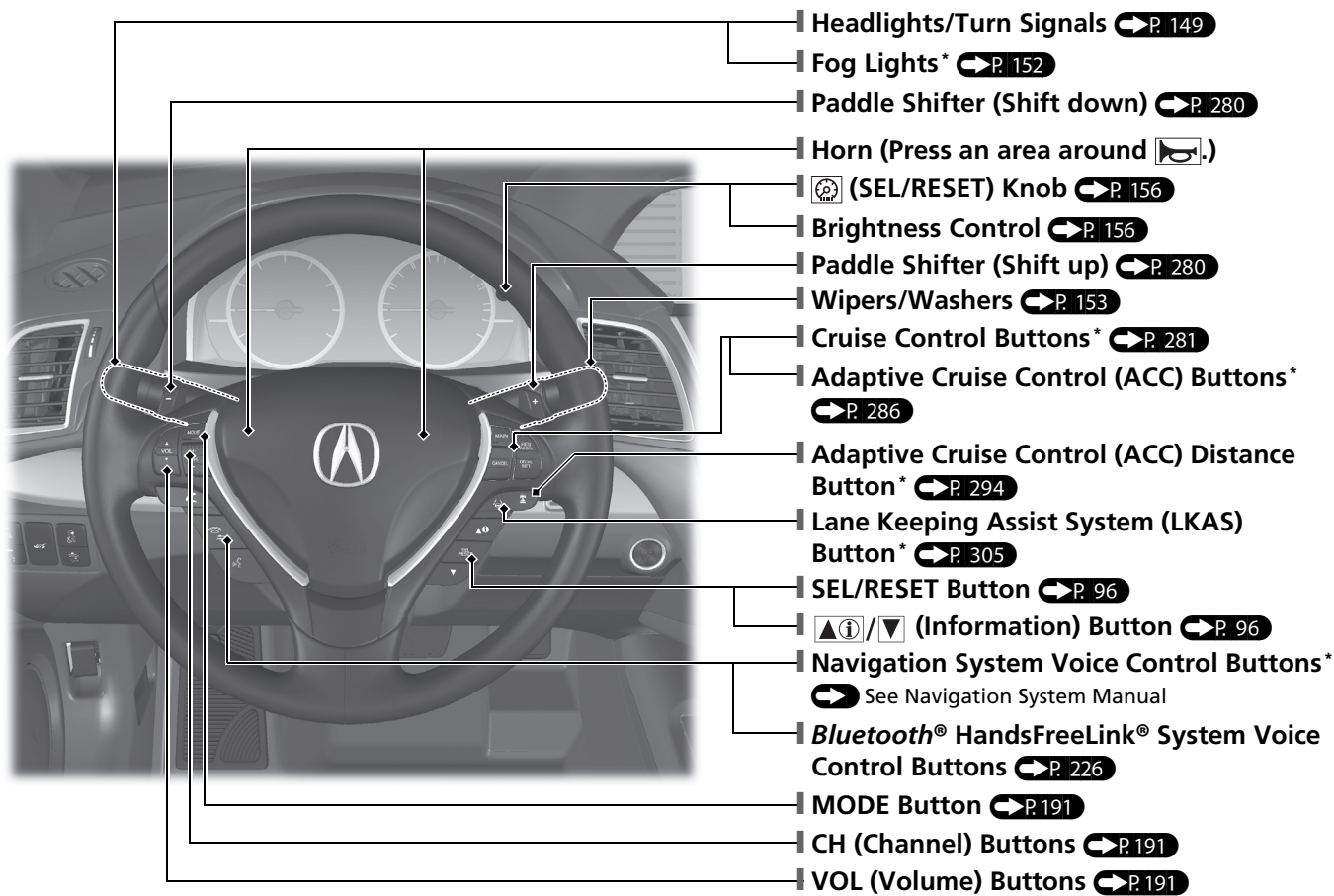



- Headlights/Turn Signals ➔ P. 149
- Fog Lights* ➔ P. 152
- Paddle Shifter (Shift down) ➔ P. 280
- Horn (Press an area around )
-  (SEL/RESET) Knob ➔ P. 156
- Brightness Control ➔ P. 156
- Paddle Shifter (Shift up) ➔ P. 280
- Wipers/Washers ➔ P. 153
- Cruise Control Buttons* ➔ P. 281
- Adaptive Cruise Control (ACC) Buttons* ➔ P. 286
- Adaptive Cruise Control (ACC) Distance Button* ➔ P. 294
- Lane Keeping Assist System (LKAS) Button* ➔ P. 305
- SEL/RESET Button ➔ P. 96
-  (Information) Button ➔ P. 96
- Navigation System Voice Control Buttons* ➔ See Navigation System Manual
- Bluetooth® HandsFreeLink® System Voice Control Buttons ➔ P. 226
- MODE Button ➔ P. 191
- CH (Channel) Buttons ➔ P. 191
- VOL (Volume) Buttons ➔ P. 191

* Not available on all models

Visual Index

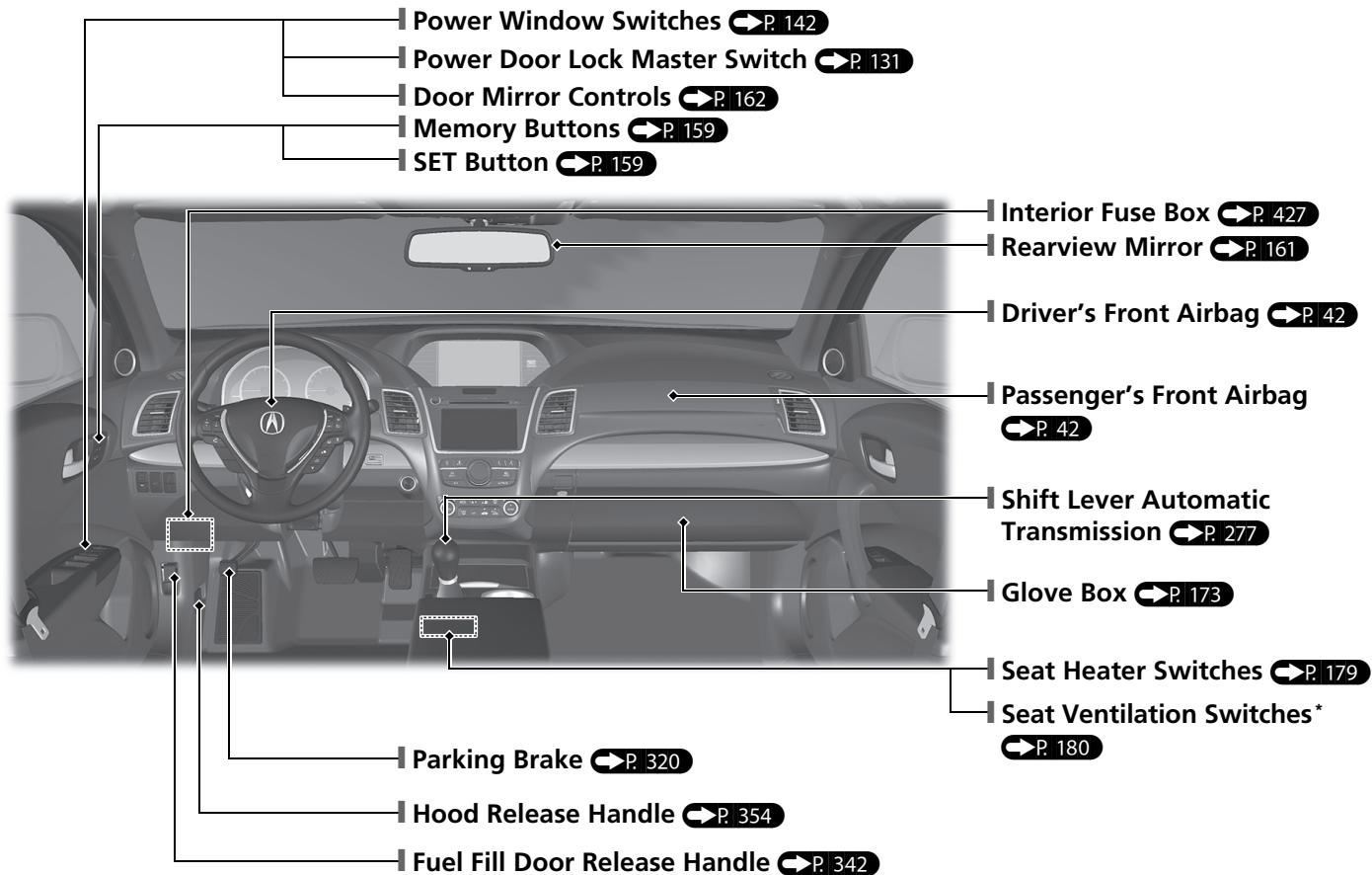

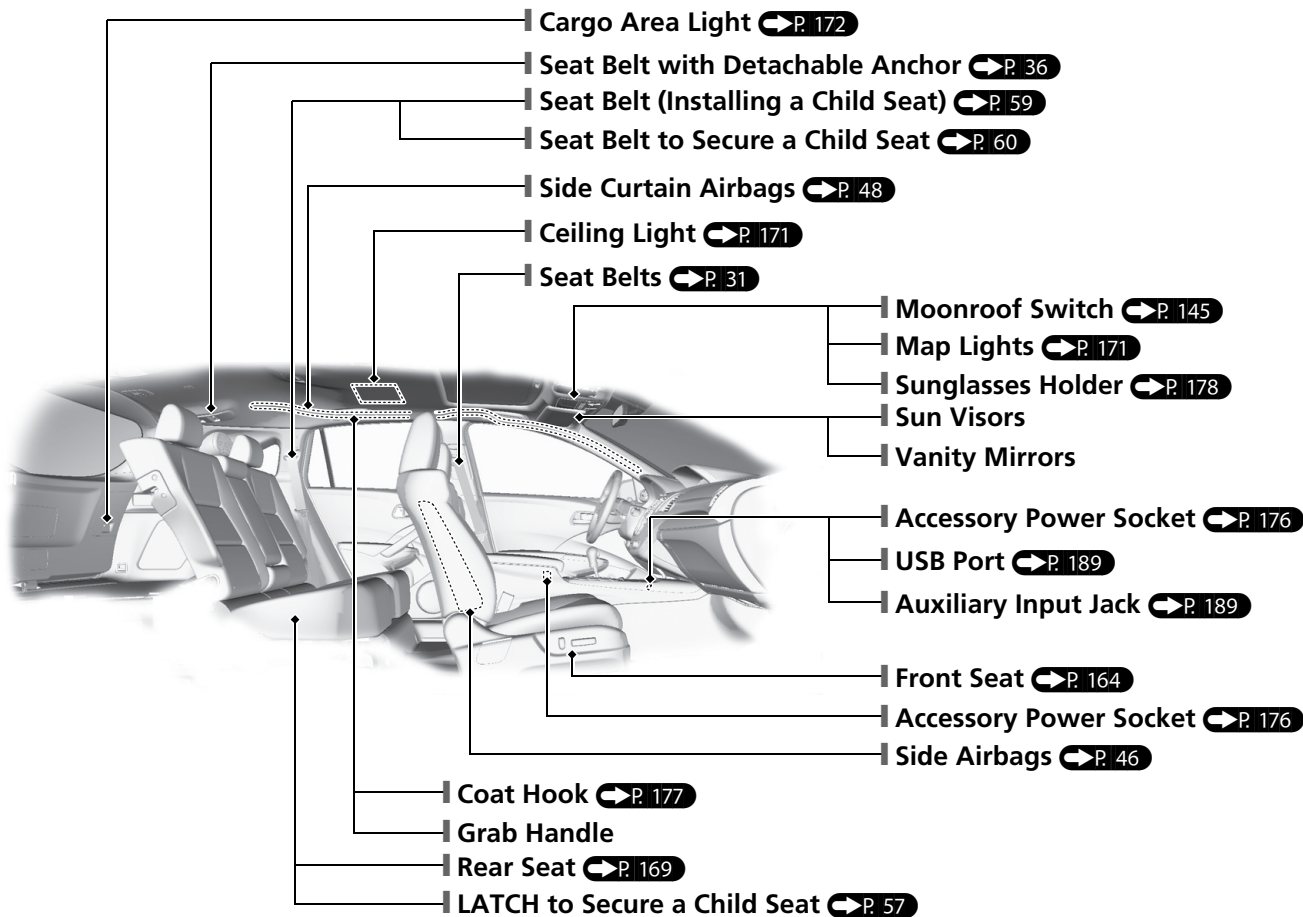

Visual Index

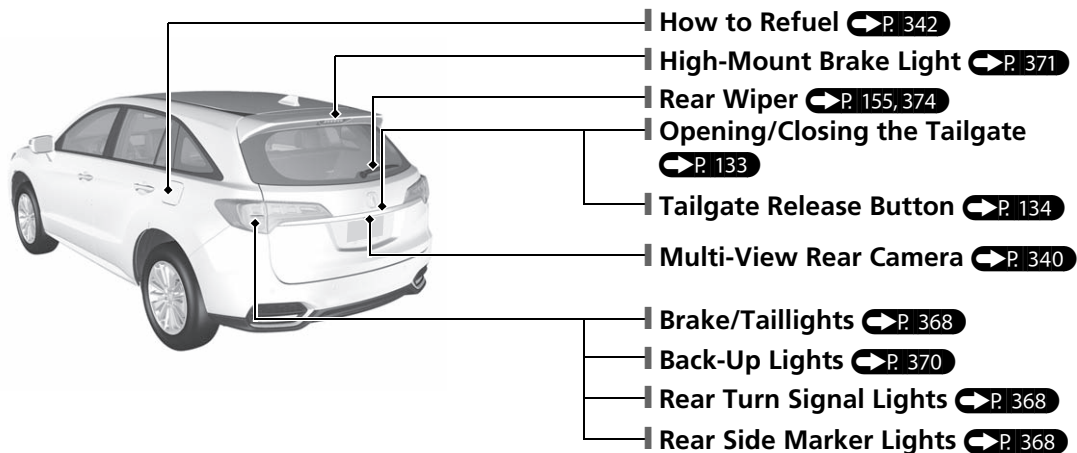
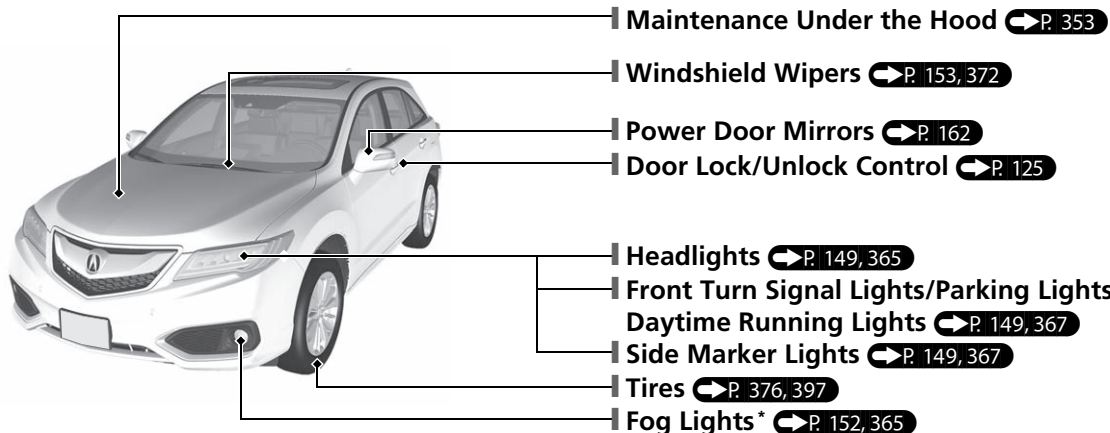

Safe Driving P. 25

Airbags P. 39

- Your vehicle is fitted with airbags to help protect you and your passengers during a moderate-to-severe collision.

Child Safety P. 52

- All children 12 and younger should be seated in the rear seat.
- Smaller children should be properly restrained in a forward-facing child seat.
- Infants must be properly restrained in a rear-facing child seat.

Exhaust Gas Hazard P. 64

- Your vehicle emits dangerous exhaust gases that contain carbon monoxide. Do not run the engine in confined spaces where carbon monoxide gas can accumulate.

Seat Belts P. 31

- Fasten your seat belt and sit upright well back in the seat.
- Check that your passengers are wearing their seat belts correctly.

Before Driving Checklist P. 30

- Before driving, check that the front seats, head restraints, steering wheel, and mirrors have been properly adjusted.















Fasten your lap belt as low as possible.

Instrument Panel ➔ P. 67





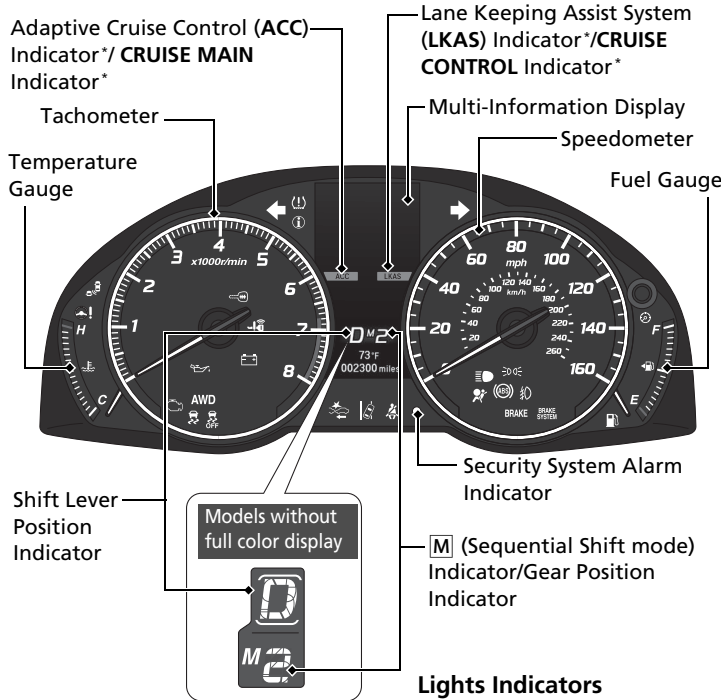

Gauges ➔ P. 95 / Multi-Information Display ➔ P. 96 / System Indicators ➔ P. 68

System Indicators



-  Malfunction Indicator Lamp
-  Low Oil Pressure Indicator
-  Charging System Indicator
-  Anti-lock Brake System (ABS) Indicator
-  Vehicle Stability Assist (VSA®) System Indicator
-  VSA® OFF Indicator
-  Door and Tailgate Open Indicator*
-  Immobilizer System Indicator
- U.S.**
 **BRAKE** Parking Brake and Brake System Indicator (Red)
- Canada**
 Low Tire Pressure/TPMS Indicator
-  Keyless Access System Indicator
-  Lane Departure Warning (LDW) Indicator*
-  Blind spot information (BSI) System Indicator*



System Indicators

- AWD** All-Wheel Drive (AWD) with Intelligent Control System Indicator*
-  Turn Signal and Hazard Warning Indicators
-  Electric Power Steering (EPS) System Indicator
-  Low Fuel Indicator
-  Seat Belt Reminder Indicator
-  Supplemental Restraint System Indicator
- CRUISE MAIN** CRUISE MAIN Indicator*
- CRUISE CONTROL** CRUISE CONTROL Indicator*
-  System Message Indicator
- U.S.**
BRAKE SYSTEM Brake System Indicator (Amber)
- Canada**
-  Collision Mitigation Braking System™ (CMBS™) Indicator*

Lights Indicators

-  Lights On Indicator
-  High Beam Indicator
-  Fog Light Indicator*

Controls P. 119

Clock P. 120

Models without navigation system

- 1 Press and hold the **CLOCK (AUX)** button until **Adjust Clock** appears.
- 2 Press Preset **4** (Hour) or **5** (Minute) to set the time.
- 3 Press the **CLOCK** button again to set the time.

To set the time to the nearest hour: Press and hold the **CLOCK** button until **Adjust Clock** appears, then press the **6** (Reset) button.

Depending on the displayed time, the clock sets forward or backward.

Example:

1:06 will reset to 1:00

1:53 will reset to 2:00

Models with navigation system

The navigation system receives signals from GPS satellites, updating the clock automatically.

ENGINE START/STOP Button P. 146

Press the button to change the vehicle's power mode.

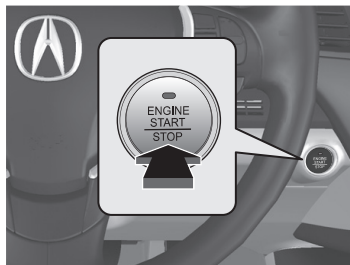

Turn Signals P. 149

Turn Signal Control Lever

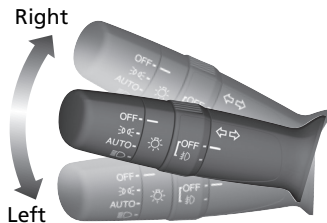

Lights P. 149

Light Control Switches

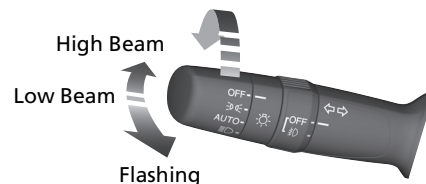

Wipers and Washers P. 153

Wiper/Washer Control Lever

Adjustment Ring

- ☰: Low Sensitivity*¹
: Lower speed, fewer sweeps*²
- ☷: High Sensitivity*¹
: Higher speed, more sweeps*²

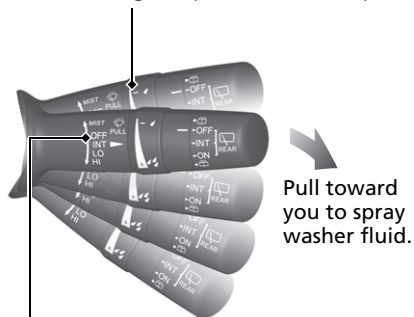

MIST
OFF

AUTO*¹: Wiper speed varies automatically

INT*²: Low speed with intermittent

LO: Low speed wiper

HI: High speed wiper

*1: Models with automatic intermittent wipers

*2: Models without automatic intermittent wipers

Models with automatic intermittent wipers

AUTO should always be turned **OFF** before cleaning the windshield or driving through a car wash.

Steering Wheel P. 160

- To adjust, pull the adjustment lever towards you, adjust to the desired position, then lock the lever back in place.



Unlocking the Front Doors from the Inside P. 130

- Pull either front door inner handle to unlock and open it at the same time.

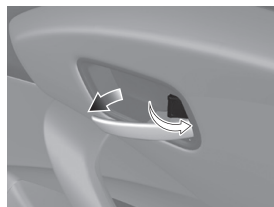

Tailgate P. 133

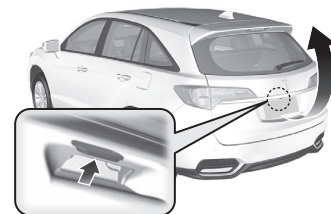

- Press the tailgate release button to unlock and open the tailgate.
- Press the power tailgate button on the instrument panel or the remote transmitter to open and close the power tailgate.

Power Door Mirrors P. 162

- With the power mode in ON, move the selector switch to L or R.
- Push the appropriate edge of the adjustment switch to adjust the mirror.
- Place the selector switch in the L or R position to use the reverse tilt door mirror feature.
- Press the folding button* to fold in and out the door mirrors.

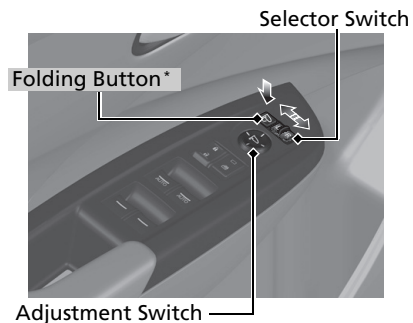

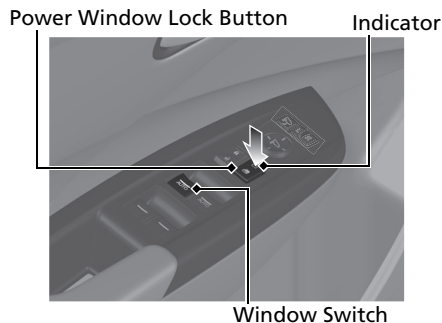

Power Windows P. 142

- With the power mode in ON, open and close the power windows.
- If the power window lock button is in the off position, each passenger's window can be opened and closed with its own switch.
- If the power window lock button is in the on position (indicator on), each passenger's window switch is disabled.



Climate Control System P. 182

- Press the **AUTO** button to activate the climate control system.
- Press the  button to turn the system on or off.
- Press the  button to defrost the windshield.

Models with navigation system

The climate control system is voice operable. See the navigation system manual for complete details.

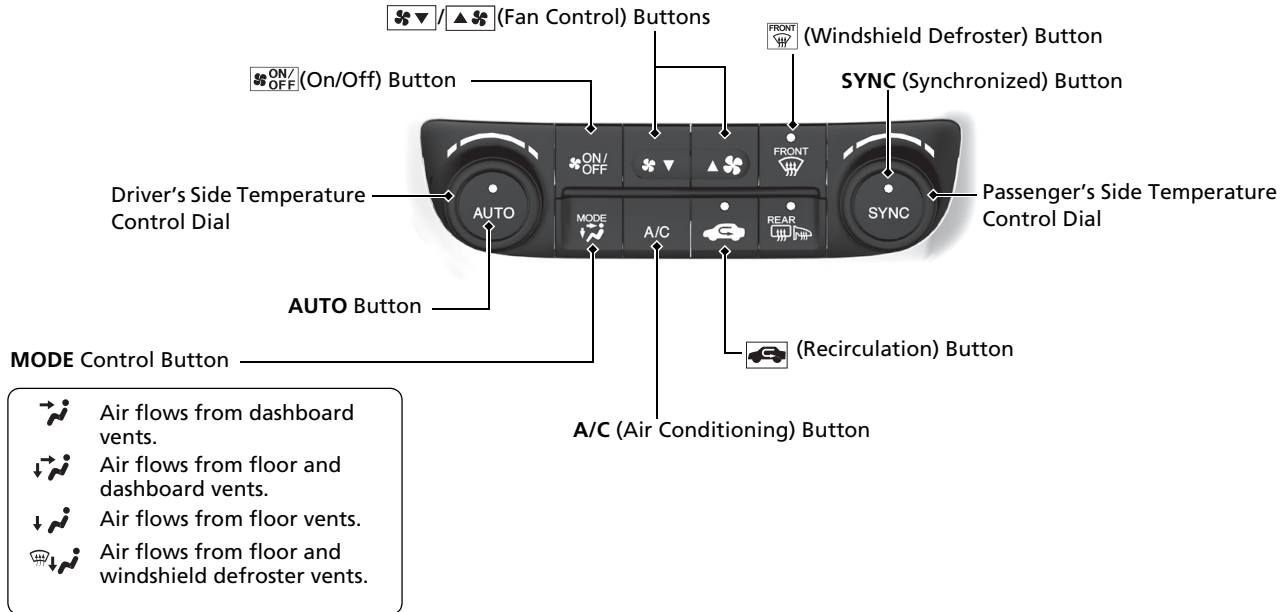

Features P. 187

Audio System* P. 188

For navigation system operation  See Navigation System Manual

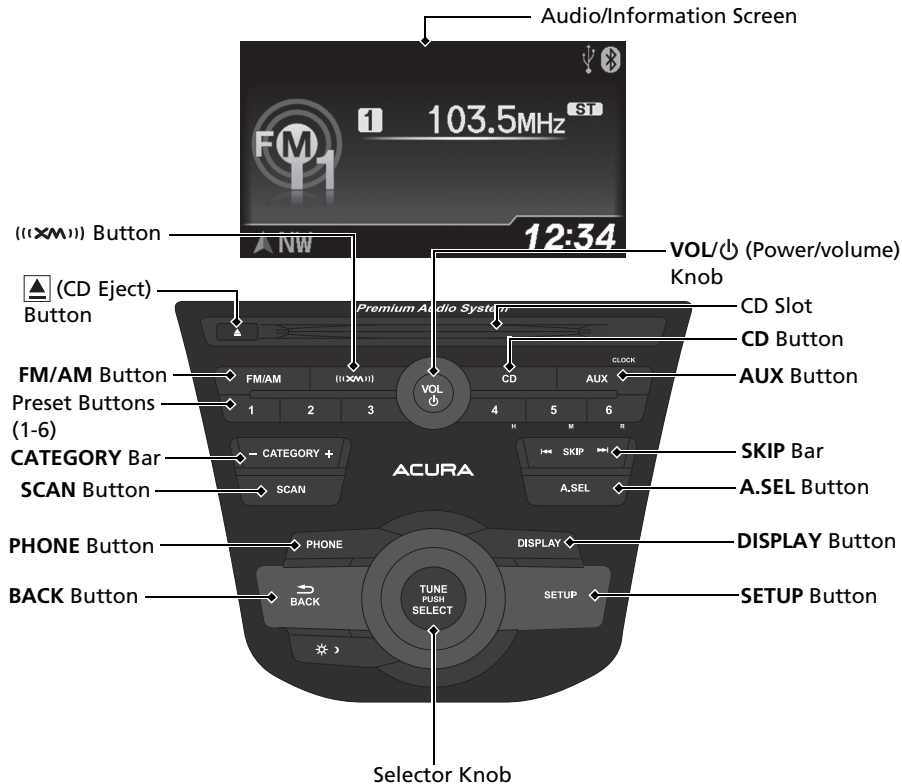

● Audio Remote Controls P. 191

VOL (Volume) Buttons

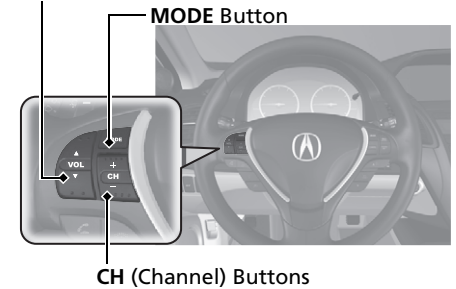

● VOL (Volume) Button

Press and release to adjust the volume up/down.

● MODE Button

Press and release to change the audio mode: FM1/FM2/AM/SiriusXM®1/SiriusXM®2/CD/AUX.

● CH (Channel) Button

Radio: Press and release to change the preset station.
Press and hold to select the next or previous strong station.

CD/USB device:

Press and release to skip to the beginning of the next song or return to the beginning of the current song.
Press and hold to change a folder.

Driving P. 257

Automatic Transmission P. 277

- Shift to **P** and depress the brake pedal when starting the engine.

● Shifting

P **Park**
Turn off or start the engine.
Transmission is locked.

R **Reverse**
Used when reversing.

N **Neutral**
Transmission is not locked.

D **Drive**
Normal driving. D-paddle shift mode can be used.

S **S Position**
Sequential shift mode can be used.

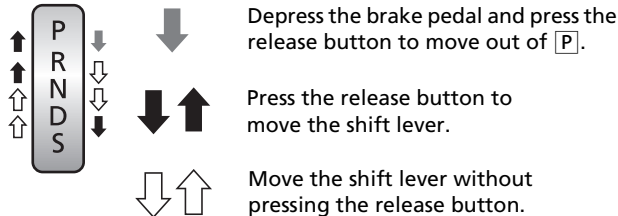
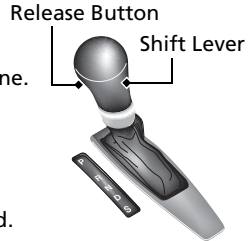

Paddle Shifters P. 279

- Paddle shifters allow you to shift gears much like a manual transmission (1st through 6th). This is useful for engine braking.
- D-paddle shift mode: The transmission will shift back to automatic mode once the system detects that the vehicle is cruising.
- Sequential shift mode: Holds the selected gear, and the **M** indicator comes on.

Models without full color display

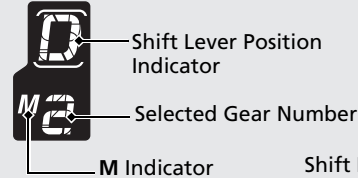

- The selected gear position is shown in the instrument panel.

Models with full color display

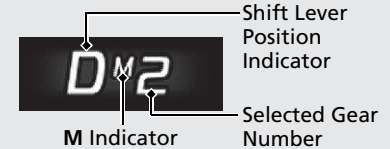

Shift Down (-)
Paddle Shifter

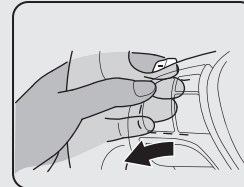

Shift Up (+)
Paddle Shifter

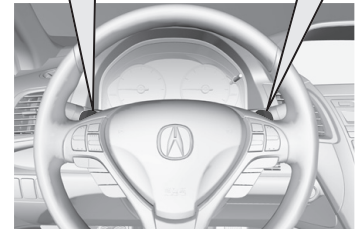
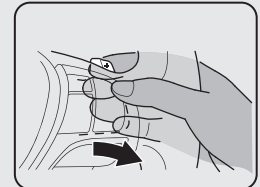

VSA® OFF Button P. 312

- The vehicle stability assist (VSA®) system helps stabilize the vehicle during cornering, and helps maintain traction while accelerating on loose or slippery road surfaces.
- VSA® comes on automatically every time you start the engine.
- To turn VSA® on or off, press and hold the button until you hear a beep.

Cruise Control* P. 281

- Cruise control allows you to maintain a set speed without keeping your foot on the accelerator pedal.
- To use cruise control, press the **CRUISE** button, then press **DECEL/SET** once you have achieved the desired speed (above 25 mph or 40 km/h).

Tire Pressure Monitoring System (TPMS) P. 316

- TPMS monitors tire pressure.
- TPMS is turned on automatically every time you start the engine.

Refueling P. 341

Fuel recommendation: Unleaded premium gasoline with a pump octane number 91 or higher recommended

Fuel tank capacity: 16 US gal (60.5 L)

- 1** Pull the fuel fill door release handle.
- 2** Turn the fuel fill cap slowly to remove the cap.
- 3** Place the cap in the holder on the fuel fill door.
- 4** After refueling, screw the cap back on until it clicks at least once.

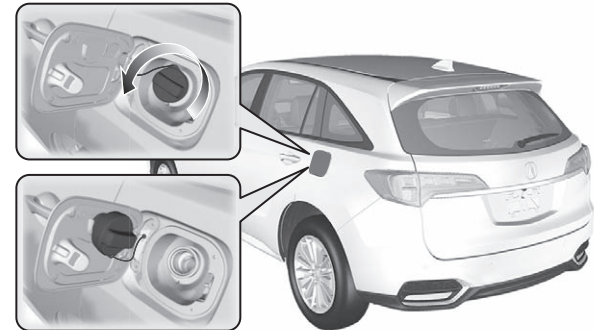
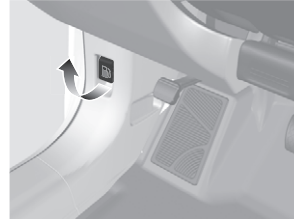

AcuraWatch™*

AcuraWatch™ is a driver support system which employs the use of two distinctly different kinds of sensors, a radar sensor located in the front grille and a front sensor camera mounted to the interior side of the windshield, behind the rear view mirror.

The camera is located behind the rearview mirror.

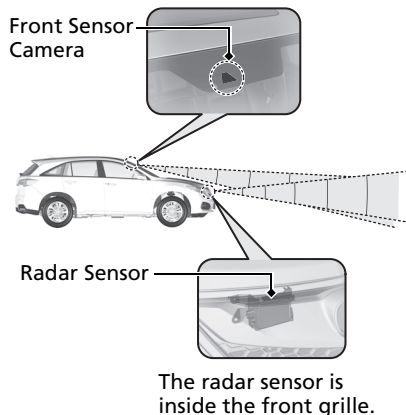

Adaptive Cruise Control (ACC)* P.286

Helps maintain a constant vehicle speed and a set following-distance behind a vehicle detected ahead of yours, without you having to keep your foot on the brake or the accelerator.

Lane Keeping Assist System (LKAS)* P.303

Provides steering input to help keep the vehicle in the middle of a detected lane and provides audible and visual alerts if the vehicle is detected drifting out of its lane.

Collision Mitigation Braking System™ (CMBS™)* P.324

Can assist you when there is a possibility of your vehicle colliding with a vehicle or a pedestrian detected in front of yours. The CMBS™ is designed to alert you when a potential collision is determined, as well as to reduce your vehicle speed to help minimize collision severity when a collision is deemed unavoidable.

Maintenance P. 345

Under the Hood P. 353

- Check engine oil, engine coolant, and windshield washer fluid. Add when necessary.
- Check brake fluid.
- Check the battery condition monthly.

- 1** Pull the hood release handle under the corner of the dashboard.

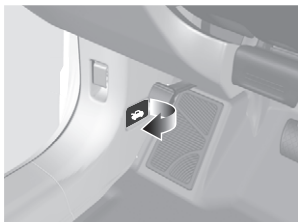

- 2** Locate the hood latch lever, slide the lever, and lift up the hood.



- 3** When finished, close the hood and make sure it is firmly locked in place.

Wiper Blades P. 372

- Replace blades if they leave streaks across the windshield.

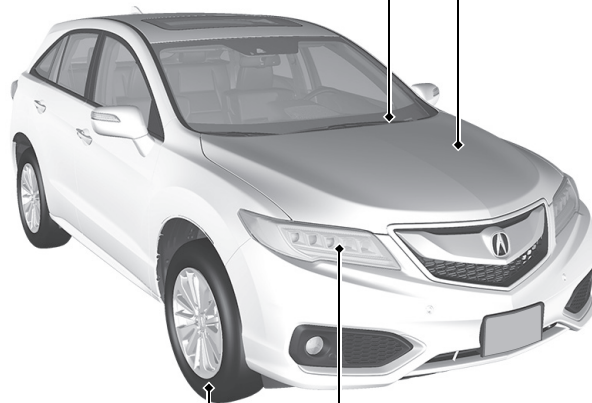

Tires P. 376

- Inspect tires and wheels regularly.
- Check tire pressures regularly.
- Install snow tires for winter driving.

Lights P. 365

- Inspect all lights regularly.

Handling the Unexpected ➔ P. 395

Flat Tire ➔ P. 397

Vehicles with tire repair kit

- Park in a safe location and repair the flat tire using the tire repair kit.

Vehicles with a compact spare tire

- Park in a safe location and replace the flat tire with the compact spare tire in the cargo area.



Indicators Come On ➔ P. 422

- Identify the indicator and consult the owner's manual.

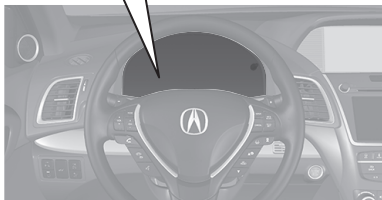

Engine Won't Start ➔ P. 414

- If the battery is dead, jump start using a booster battery.

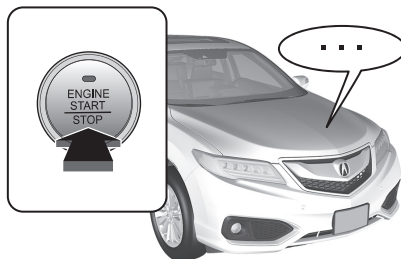

Blown Fuse ➔ P. 426

- Check for a blown fuse if an electrical device does not operate.

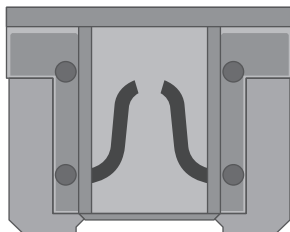

Overheating ➔ P. 420

- Park in a safe location. If you do not see steam under the hood, open the hood, and let the engine cool down.



Emergency Towing ➔ P. 429

- Call a professional towing service if you need to tow your vehicle.



What to Do If

Q The power mode does not change from **VEHICLE OFF (LOCK)** to **ACCESSORY**.
Why?

- A**
- The steering wheel may be locked.
 - Move the steering wheel left and right after pressing the **ENGINE START/STOP** button.



Q The power mode does not change from **ACCESSORY** to **VEHICLE OFF (LOCK)**.
Why?

- A** The shift lever should be moved to **P**.

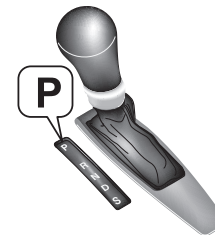

Q Why does the brake pedal pulsate slightly when applying the brakes?

- A** This can occur when the ABS activates, and does not indicate a problem. Apply firm, steady pressure on the brake pedal. Never pump the brake pedal.

► ABS operation  **P. 322**

Q The rear door cannot be opened from inside the vehicle. Why?

A Check if the childproof lock is in the lock position. If so, open the rear door with the outside door handle. To cancel this function, push the lever to the unlock position.

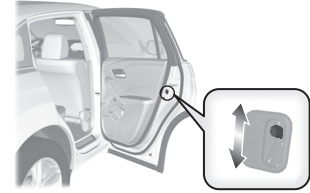

Q Why do the doors lock after I unlocked the doors using a remote transmitter?

A If you do not open the doors within 30 seconds, the doors are relocked automatically for security.

Q Why does the beeper sound when I open the driver's door?

A The beeper sounds when:

- The exterior lights are left on.
- The power mode is in ACCESSORY.

Q Why does the beeper sound when I start driving?

A The beeper sounds when:

- Driver and/or front passenger are not wearing their seat belts.
- The parking brake lever is not fully released.

Q Why do I hear a screeching sound when I apply the brake pedal?

A The brake pads may need to be replaced. Have your vehicle inspected by a dealer.

Q Is it possible to use unleaded gasoline with a Pump Octane Number (PON) of 87 or higher on this vehicle?

A Unleaded gasoline with a Pump Octane Number (PON) of 91 or higher is recommended. Use of lower octane gasoline can cause occasional metallic knocking noise in the engine and will result in decreased engine performance. Use of gasoline with a pump octane less than 87 can lead to engine damage.

Safe Driving

You can find many safety recommendations throughout this chapter, and throughout this manual.

For Safe Driving

Important Safety Precautions	26
Important Handling Information.....	28
Your Vehicle's Safety Features.....	29

Seat Belts

About Your Seat Belts.....	31
Fastening a Seat Belt.....	34
Seat Belt Inspection.....	38

Airbags

Airbag System Components.....	39
Types of Airbags	42
Front Airbags (SRS)	42

Side Airbags	46
Side Curtain Airbags.....	48
Airbag System Indicators.....	49
Airbag Care	51

Child Safety

Protecting Child Passengers	52
Safety of Infants and Small Children	54
Safety of Larger Children	62

Exhaust Gas Hazard

Carbon Monoxide Gas.....	64
--------------------------	----

Safety Labels

Label Locations	65
-----------------------	----

The following pages explain your vehicle's safety features and how to use them properly. The safety precautions below are ones that we consider to be among the most important.

Important Safety Precautions

■ Always wear your seat belt

A seat belt is your best protection in all types of collisions. Airbags are designed to supplement seat belts, not replace them. So even though your vehicle is equipped with airbags, make sure you and your passengers always wear your seat belts, and wear them properly.

■ Restrain all children

Children age 12 and under should ride properly restrained in a back seat, not the front seat. Infants and small children should be restrained in a child seat. Larger children should use a booster seat and a lap/shoulder seat belt until they can use the belt properly without a booster seat.

■ Be aware of airbag hazards

While airbags can save lives, they can cause serious or fatal injuries to occupants who sit too close to them, or are not properly restrained. Infants, young children, and short adults are at the greatest risk. Be sure to follow all instructions and warnings in this manual.

■ Don't drink and drive

Alcohol and driving don't mix. Even one drink can reduce your ability to respond to changing conditions, and your reaction time gets worse with every additional drink. So don't drink and drive, and don't let your friends drink and drive, either.

▣ Important Safety Precautions

Some states, provinces and territories prohibit the use of cell phones other than hands-free devices by the driver while driving.

■ **Pay appropriate attention to the task of driving safely**

Engaging in cell phone conversation or other activities that keep you from paying close attention to the road, other vehicles, and pedestrians could lead to a crash. Remember, situations can change quickly, and only you can decide when it is safe to divert some attention away from driving.

■ **Control your speed**

Excessive speed is a major factor in crash injuries and deaths. Generally, the higher the speed, the greater the risk, but serious injuries can also occur at lower speeds. Never drive faster than is safe for current conditions, regardless of the maximum speed posted.

■ **Keep your vehicle in safe condition**

Having a tire blowout or a mechanical failure can be extremely hazardous. To reduce the possibility of such problems, check your tire pressures and condition frequently, and perform all regularly scheduled maintenance.

Important Handling Information

Your vehicle has higher ground clearance than a passenger vehicle designed for use only on pavement. Higher ground clearance has many advantages for off-highway driving. It allows you to travel over bumps, obstacles, and rough terrain. It also provides good visibility so you can anticipate problems earlier.

These advantages come at some cost. Because your vehicle is taller and rides higher off the ground, it has a higher center gravity making it more susceptible to tripping or roll over if you make abrupt turns. Utility vehicles have a significantly higher rollover rate than other types of vehicles. In a rollover crash, an unbelted person is significantly more likely to die than a person wearing a seat belt. As a reminder, make sure you and your passengers always wear seat belts.

► Important Handling Information

For information on how to reduce the risk of rollover, read:

► **Driving Guidelines for Your Utility Vehicle**
P. 275

► **Off-Highway Driving Guidelines** P. 268

Failure to operate your vehicle correctly might result in a crash or a rollover.

Your Vehicle's Safety Features

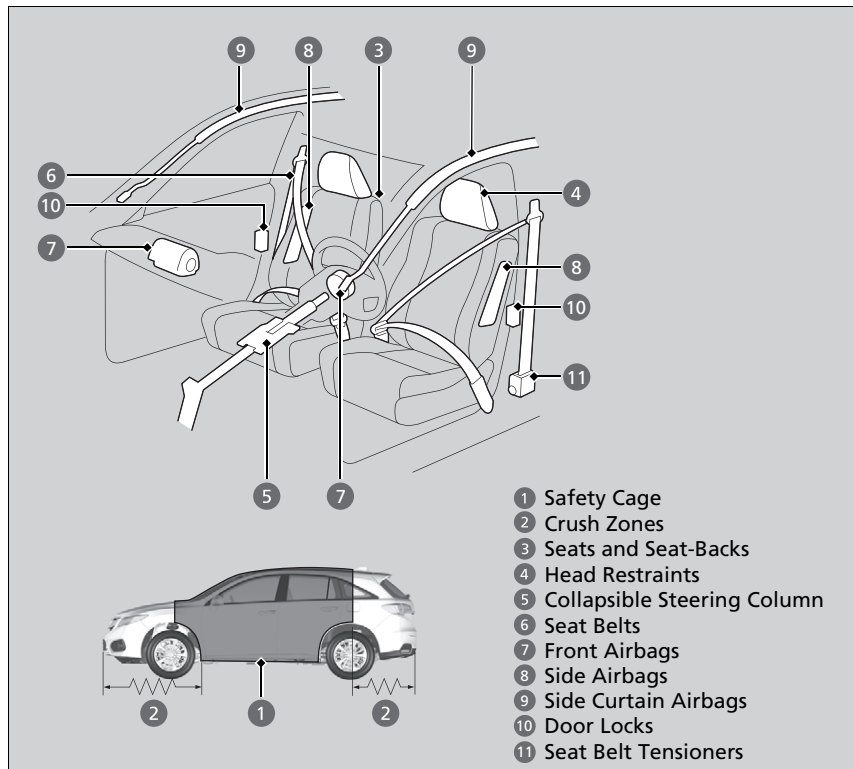

The following checklist will help you take an active role in protecting yourself and your passengers.

▣ Your Vehicle's Safety Features

Your vehicle is equipped with many features that work together to help protect you and your passengers during a crash.

Some features do not require any action on your part. These include a strong steel framework that forms a safety cage around the passenger compartment, front and rear crush zones, a collapsible steering column, and tensioners that tighten the front seat belts in a sufficient crash.

However, you and your passengers cannot take full advantage of these features unless you remain seated in the correct position and always wear your seat belts. In fact, some safety features can contribute to injuries if they are not used properly.

■ Safety Checklist

For the safety of you and your passengers, make a habit of checking these items each time before you drive.

- After everyone has entered the vehicle, be sure all doors and the tailgate are closed and locked. Locking the doors and the tailgate helps prevent an occupant from being ejected and an outsider from unexpectedly opening a door or the tailgate.
 - **Locking/Unlocking the Doors from the Inside** P. 130
- Adjust your seat to a position suitable for driving. Be sure the front seats are adjusted as far to the rear as possible while allowing the driver to control the vehicle. Sitting too close to a front airbag can result in serious or fatal injury in a crash.
 - **Adjusting the Seats** P. 164
- Adjust head restraints to the proper position. Head restraints are most effective when the center of the head restraint aligns with the center of your head. Taller persons should adjust their head restraint to the highest position.
 - **Adjusting the Head Restraints** P. 166
- Always wear your seat belt, and make sure you wear it properly. Confirm that any passengers are properly belted as well.
 - **Fastening a Seat Belt** P. 34
- Protect children by using seat belts or child seats according to a child's age, height and weight.
 - **Child Safety** P. 52

▶▶ Safety Checklist

If the door and tailgate open indicator* is on and a message appears on the multi-information display, a door and/or the tailgate is not completely closed. Close all doors and the tailgate tightly until the message disappears.

- **Door and Tailgate Open Indicator*** P. 74
- **Multi-Information Display Warning and Information Messages** P. 89



About Your Seat Belts

Seat belts are the single most effective safety device because they keep you connected to the vehicle so that you can take advantage of many built-in safety features. They also help keep you from being thrown against the inside of the vehicle, against other passengers, or out of the vehicle. When worn properly, seat belts also keep your body properly positioned in a crash so that you can take full advantage of the additional protection provided by the airbags.

In addition, seat belts help protect you in almost every type of crash, including:

- frontal impacts
- side impacts
- rear impacts
- rollovers

■ Lap/shoulder seat belts

All five seating positions are equipped with lap/shoulder seat belts with emergency locking retractors. In normal driving the retractor lets you move freely while keeping some tension on the belt. During a collision or sudden stop the retractor locks to restrain your body. The front passenger's and rear seat belts also have a lockable retractor for use with child seats.

➤ **Installing a Child Seat with a Lap/Shoulder Seat Belt** P. 59

➤ About Your Seat Belts

⚠ WARNING

Not wearing a seat belt properly increases the chance of serious injury or death in a crash, even though your vehicle has airbags.

Be sure you and your passengers always wear seat belts and wear them properly.

Seat belts cannot completely protect you in every crash. But in most cases, seat belts can reduce your risk of serious injury.

Most states and all Canadian provinces and territories require you to wear seat belts.

The emergency locking retractor may lock if you lean forward too quickly. Slower movements will allow the belt to extend fully without locking.

■ Proper use of seat belts

Follow these guidelines for proper use:

- All occupants should sit upright, well back in the seat, and remain in that position for the duration of the trip. Slouching and leaning reduces the effectiveness of the belt and can increase the chance of serious injury in a crash.
- Never place the shoulder part of a lap/shoulder seat belt under your arm or behind your back. This could cause very serious injuries in a crash.
- Two people should never use the same seat belt. If they do, they could be very seriously injured in a crash.
- Do not put any accessories on the seat belts. Devices intended to improve comfort or reposition the shoulder part of a seat belt can reduce the protective capability and increase the chance of serious injury in a crash.

■ Seat Belt Reminder



Your vehicle monitors front seat belt use. If the power mode is set to ON before the driver's seat belt is fastened, a beeper will sound and the indicator will blink. If the driver does not fasten the belt before the beeper stops, the indicator will remain on.

The beeper will also periodically sound and the indicator will blink while driving until the driver's and front passenger's seat belts are fastened.

▶▶ About Your Seat Belts

If a rear seat passenger moves around and extends the seat belt, the lockable retractor may activate. If this happens, release the retractor by unfastening the seat belt and allow the belt to retract completely. Then refasten the belt.

▶▶ Seat Belt Reminder

The indicator will also come on if a front passenger does not fasten their seat belt within 6 seconds after the power mode is set to ON. When no one is sitting in the front passenger's seat, or a child or small adult is riding there, the indicator will not come on. This is because the weight sensors in the seat cannot detect their presence.

Automatic Seat Belt Tensioners

The front seats are equipped with automatic seat belt tensioners to enhance safety.

The tensioners automatically tighten the front seat belts during a moderate-to-severe frontal collision, sometimes even if the collision is not severe enough to inflate the front airbags.

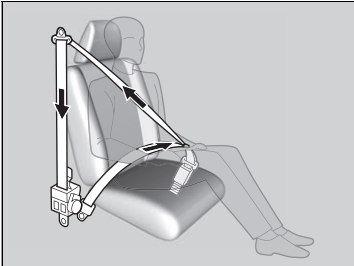

Automatic Seat Belt Tensioners

The seat belt tensioners can only operate once. If a tensioner is activated, the SRS indicator will come on. Have a dealer replace the tensioner and thoroughly inspect the seat belt system as it may not offer protection in a subsequent crash.

During a moderate-to-severe side impact, the tensioner on that side of the vehicle also activates.

Fastening a Seat Belt

After adjusting a front seat to the proper position, and while sitting upright and well back in the seat:

➤ **Adjusting the Seats** P. 164

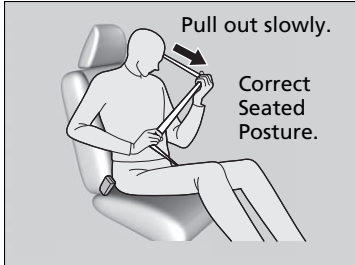

1. Pull the seat belt out slowly.

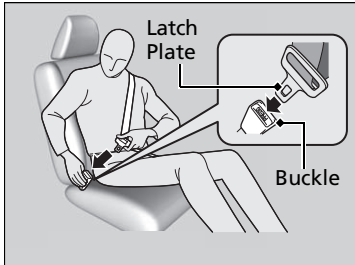

2. Insert the latch plate into the buckle, then tug on the belt to make sure the buckle is secure.

▶ Make sure that the belt is not twisted or caught on anything.

Fastening a Seat Belt

No one should sit in a seat with an inoperative seat belt or one that does not appear to be working correctly. Using a seat belt that is not working properly may not protect the occupant in a crash. Have a dealer check the belt as soon as possible.

Never insert any foreign objects into the buckle or retractor mechanism.



3. Position the lap part of the belt as low as possible across your hips, then pull up on the shoulder part of the belt so the lap part fits snugly. This lets your strong pelvic bones take the force of a crash and reduces the chance of internal injuries.
4. If necessary, pull up on the belt again to remove any slack, then check that the belt rests across the center of your chest and over your shoulder. This spreads the forces of a crash over the strongest bones in your upper body.

■ Adjusting the Shoulder Anchor

The front seats have adjustable shoulder anchors to accommodate taller and shorter occupants.

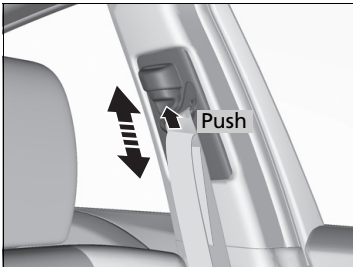

1. Move the anchor up and down while holding the release button.
2. Position the anchor so that the belt rests across the center of your chest and over your shoulder.

⌘ Fastening a Seat Belt

⚠ WARNING

Improperly positioning the seat belts can cause serious injury or death in a crash.

Make sure all seat belts are properly positioned before driving.

To release the belt, push the red **PRESS** button then guide the belt by hand until it has retracted completely.

When exiting the vehicle, be sure the belt is out of the way and will not get caught by closing the door.

⌘ Adjusting the Shoulder Anchor

The shoulder anchor height can be adjusted to four levels. If the belt contacts your neck, lower the height one level at a time.

After an adjustment, make sure that the shoulder anchor position is secure.

Seat Belt with Detachable Anchor

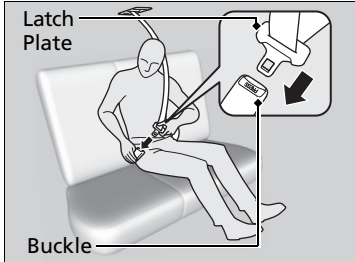
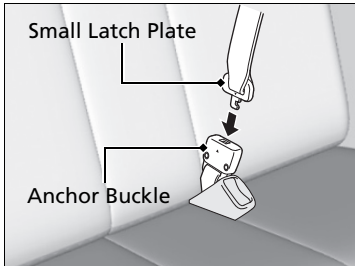
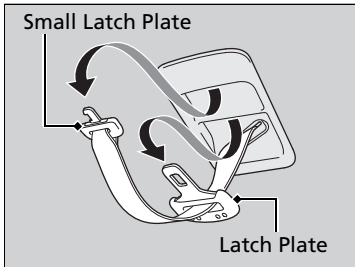

1. Pull out the seat belt's small latch plate and the latch plate from each holding slot in the ceiling.

2. Line up the triangle marks on the small latch plate and anchor buckle. Make sure the seat belt is not twisted. Attach the belt to the anchor buckle.

3. Insert the latch plate into the buckle. Properly fasten the seat belt the same way you fasten the lap/shoulder seat belt.

Seat Belt with Detachable Anchor

WARNING

Using the seat belt with the detachable anchor unlatched increases the chance of serious injury or death in a crash.

Before using the seat belt, make sure the detachable anchor is correctly latched.

To unlatch the detachable anchor, insert the latch plate into the slot on the side of the anchor buckle.

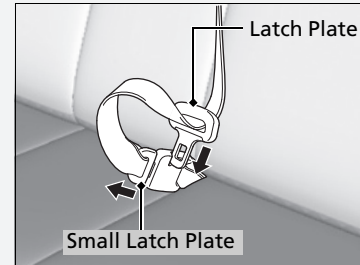

Advice for Pregnant Women

If you are pregnant, the best way to protect yourself and your unborn child when driving or riding in a vehicle is to always wear a seat belt and keep the lap part of the belt as low as possible across the hips.

Wear the shoulder belt across the chest avoiding the abdomen.



Wear the lap part of the belt as low as possible across the hips.

Advice for Pregnant Women

Each time you have a checkup, ask your doctor if it is okay for you to drive.

To reduce the risk of injuries to both you and your unborn child that can be caused by an inflating front airbag:

- When driving, sit upright and adjust the seat as far back as possible while allowing full control of the vehicle.
- When sitting in the front passenger's seat, adjust the seat as far back as possible.

Seat Belt Inspection

Regularly check the condition of your seat belts as follows:

- Pull each belt out fully, and look for frays, cuts, burns, and wear.
- Check that the latches work smoothly and the belts retract easily.
 - ▶ If a belt does not retract easily, cleaning the belt may correct the problem. Only use a mild soap and warm water. Do not use bleach or cleaning solvents. Make sure the belt is completely dry before allowing it to retract.

Any belt that is not in good condition or working properly will not provide proper protection and should be replaced as soon as possible.

A belt that has been worn during a crash may not provide the same level of protection in a subsequent crash. Have your seat belts inspected by a dealer after any collision.

Seat Belt Inspection

WARNING

Not checking or maintaining seat belts can result in serious injury or death if the seat belts do not work properly when needed.

Check your seat belts regularly and have any problem corrected as soon as possible.

Airbag System Components

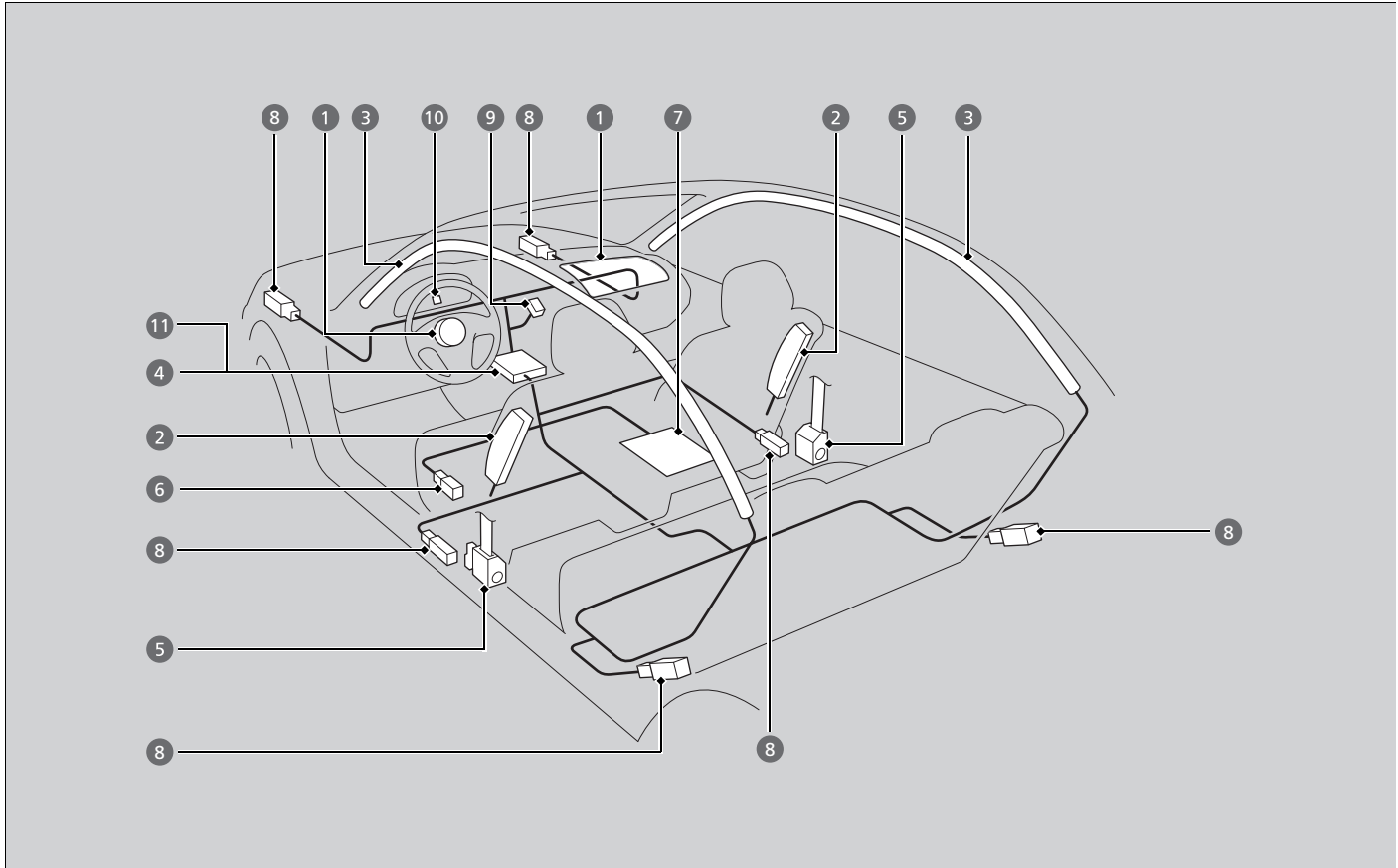

The front, front side, and side curtain airbags are deployed according to the direction and severity of impact. Both side curtain airbags are deployed in a rollover. The airbag system includes:

- 1 Two SRS (Supplemental Restraint System) front airbags. The driver's airbag is stored in the center of the steering wheel; the front passenger's airbag is stored in the dashboard. Both are marked **SRS AIRBAG**.
- 2 Two side airbags, one for the driver and one for a front passenger. The airbags are stored in the outer edges of the seat-backs. Both are marked **SIDE AIRBAG**.
- 3 Two side curtain airbags, one for each side of the vehicle. The airbags are stored in the ceiling, above the side windows. The front and rear pillars are marked **SIDE CURTAIN AIRBAG**.
- 4 An electronic control unit that continually monitors and can records information about the sensors, the airbag activators, the seat belt tensioners, and driver and front passenger seat belt use when the power mode is in ON.
- 5 Automatic front seat belt tensioners. The driver's and front passenger's seat belts incorporate sensors that detect whether or not they are fastened.
- 6 A driver's seat position sensor. If the seat is too far forward, the airbag will inflate with less force.
- 7 Weight sensors in the front passenger's seat. The front passenger's airbag will be turned off if the weight on the seat is 65 lbs (29 kg) or less (the weight of an infant or small child).
- 8 Impact sensors that can detect a moderate to severe front or side impact.
- 9 An indicator on the dashboard that alerts you that the front passenger's front airbag has been turned off.
- 10 An indicator on the instrument panel that alerts you to a possible problem with your airbag system or seat belt tensioners.
- 11 A rollover sensor that detects whether the vehicle is about to roll over.

Important Facts About Your Airbags

Airbags can pose serious hazards. To do their job, airbags must inflate with tremendous force. So, while airbags help save lives, they can cause burns, bruises, and other minor injuries, and sometimes even fatal ones if occupants are not wearing their seat belts properly and sitting correctly.

What you should do: Always wear your seat belt properly, and sit upright and as far back from the steering wheel as possible while allowing full control of the vehicle. A front passenger should move their seat as far back from the dashboard as possible.

Remember, however, that no safety system can prevent all injuries or deaths that can occur in a severe crash, even when seat belts are properly worn and the airbags deploy.

Do not place hard or sharp objects between yourself and a front airbag.

Carrying hard or sharp objects on your lap, or driving with a pipe or other sharp object in your mouth, can result in injuries if your front airbag inflates.

Do not attach or place objects on the front airbag covers. Objects on the covers marked **SRS AIRBAG** could interfere with the proper operation of the airbags or be propelled inside the vehicle and hurt someone if the airbags inflate.

Important Facts About Your Airbags

Do not attempt to deactivate your airbags. Together, airbags and seat belts provide the best protection.

When driving, keep hands and arms out of the deployment path of the front airbag by holding each side of the steering wheel. Do not cross an arm over the airbag cover.

Types of Airbags

Your vehicle is equipped with three types of airbags:

- **Front airbags:** Airbags in front of the driver's and front passenger's seats.
- **Side airbags:** Airbags in the driver's and front passenger's seat-backs.
- **Side curtain airbags:** Airbags above the side windows.

Each is discussed in the following pages.

Front Airbags (SRS)

The front SRS airbags inflate in a moderate-to-severe frontal collision to help protect the head and chest of the driver and/or front passenger.

SRS (Supplemental Restraint System) indicates that the airbags are designed to supplement seat belts, not replace them. Seat belts are the occupant's primary restraint system.

Housing Locations

The front airbags are housed in the center of the steering wheel for the driver, and in the dashboard for the front passenger. Both airbags are marked **SRS AIRBAG**.

Types of Airbags

The airbags can inflate whenever the power mode is in ON.

After an airbag inflates in a crash, you may see a small amount of smoke. This is from the combustion process of the inflator material and is not harmful. People with respiratory problems may experience some temporary discomfort. If this occurs, get out of the vehicle as soon as it is safe to do so.

Front Airbags (SRS)

Dual-Stage, Multiple-Threshold Front Airbags (SRS)

Your vehicle is equipped with dual-stage, multiple-threshold front airbags (SRS).

During a frontal crash severe enough to cause one or both front airbags to deploy, the airbags can inflate at different rates, depending on the severity of the crash, whether or not the seat belts are latched, and/or other factors. Frontal airbags are designed to supplement the seat belts to help reduce the likelihood of head and chest injuries in frontal crashes.

■ Operation

Front airbags are designed to inflate during moderate-to-severe frontal collisions. When the vehicle decelerates suddenly, the sensors send information to the control unit which signals one or both front airbags to inflate.

A frontal collision can be either head-on or angled between two vehicles, or when a vehicle crashes into a stationary object, such as a concrete wall.

■ How the Front Airbags Work

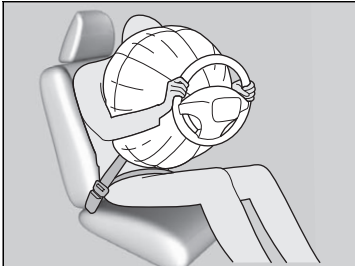

While your seat belt restrains your torso, the front airbag provides supplemental protection for your head and chest.

The front airbags deflate immediately so that they won't interfere with the driver's visibility or the ability to steer or operate other controls.

The total time for inflation and deflation is so fast that most occupants are not aware that the airbags deployed until they see them lying in front of them.

☒ How the Front Airbags Work

Although the driver's and front passenger's airbags normally inflate within a split second of each other, it is possible for only one airbag to deploy. This can happen if the severity of a collision is at the margin, or threshold, that determines whether or not the airbags will deploy. In such cases, the seat belt will provide sufficient protection, and the supplemental protection offered by the airbag would be minimal.

■ When front airbags should not deploy

Minor frontal crashes: Front airbags were designed to supplement seat belts and help save lives, not to prevent minor scrapes, or even broken bones that might occur during a less than moderate-to-severe frontal crash.

Side impacts: Front airbags can provide protection when a sudden deceleration causes a driver or front passenger to move towards the front of the vehicle. Side airbags and side curtain airbags have been specifically designed to help reduce the severity of injuries that can occur during a moderate-to-severe side impact which can cause the driver or passenger to move towards the side of the vehicle.

Rear impacts: Head restraints and seat belts are your best protection during a rear impact. Front airbags cannot provide any significant protection and are not designed to deploy in such collisions.

Rollovers: Seat belts and, in vehicles equipped with a rollover sensor, side airbags and side curtain airbags offer the best protection in a rollover. Because front airbags could provide little if any protection, they are not designed to deploy during a rollover.

■ When front airbags deploy with little or no visible damage

Because the airbag system senses sudden deceleration, a strong impact to the vehicle framework or suspension might cause one or more of the airbags to deploy. Examples include running into a curb, the edge of a hole, or other low fixed object that causes a sudden deceleration in the vehicle chassis. Since the impact is underneath the vehicle, damage may not be readily apparent.

■ When front airbags may not deploy, even though exterior damage appears severe

Since crushable body parts absorb crash energy during an impact, the amount of visible damage does not always indicate proper airbag operation. In fact, some collisions can result in severe damage but no airbag deployment because the airbags would not have been needed or would not have provided protection even if they had deployed.

Advanced Airbags

Your front airbags have advanced features to help reduce the likelihood of airbag related injuries to smaller occupants.

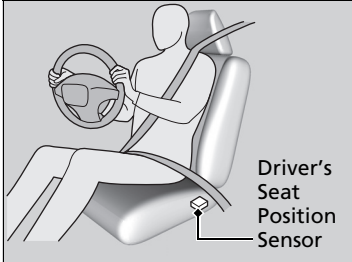

The driver's advanced front airbag system includes a seat position sensor.

If the seat is too far forward, the airbag inflates with less force, regardless of the severity of the impact.

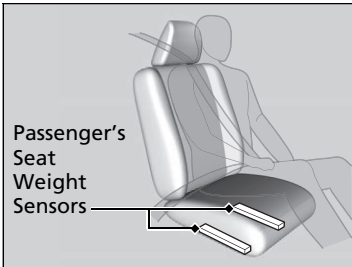

The passenger's advanced front airbag system has weight sensors.

Although Acura recommends against carrying an infant or small child in front, if the sensors detect the weight of a child (up to about 65 lbs or 29 kg), the system will automatically turn off the passenger's front airbag.

Advanced Airbags

If there is a problem with the driver's seat position sensor, the SRS indicator will come on and the airbag will inflate with full (normal) force, regardless of the driver's seating position.

For both advanced front airbags to work properly:

- Do not spill any liquid on or under the seats.
- Do not put any object under the passenger's seat.
- Make sure any objects are positioned properly on the floor. Improperly positioned objects can interfere with the advanced airbag sensors.
- All occupants should sit upright and wear their seat belts properly.
- Do not place any cover over the passenger side dashboard.

Side Airbags

The side airbags help protect the upper torso of the driver or a front passenger during a moderate-to-severe side impact.

Housing Locations

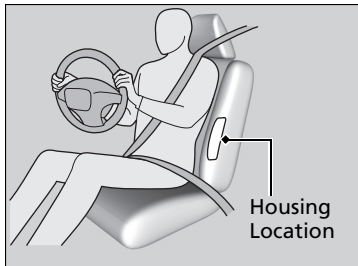

The side airbags are housed in the outside edge of the driver's and passenger's seat-backs.

Both are marked **SIDE AIRBAG**.

Operation

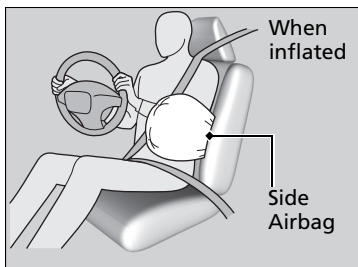

When the sensors detect a moderate-to-severe side impact, the control unit signals the side airbag on the impact side to immediately inflate.

Side Airbags

Do not attach accessories on or near the side airbags. They can interfere with the proper operation of the airbags, or hurt someone if an airbag inflates.

Do not cover or replace the front seat-back covers without consulting a dealer. Improperly replacing or covering front seat-back covers can prevent your side airbags from properly deploying during a side impact.

■ When a side airbag deploys with little or no visible damage

Because the airbag system senses sudden acceleration, a strong impact to the side of the vehicle's framework can cause a side airbag to deploy. In such cases, there may be little or no damage, but the side impact sensors detected a severe enough impact to deploy the airbag.

■ When a side airbag may not deploy, even though visible damage appears severe

It is possible for a side airbag to not deploy during an impact that results in apparently severe damage. This can occur when the point of impact was towards the far front or rear of the vehicle, or when the vehicle's crushable body parts absorbed most of the crash energy. In either case, the side airbag would not have been needed nor provided protection even if it had deployed.

Side Curtain Airbags

Side curtain airbags help protect the heads of the driver and passengers in outer seating positions during a moderate-to-severe side impact. The side curtain airbags equipped in this vehicle are also designed to help reduce the likelihood of partial and complete ejection of vehicle occupants through side windows in crashes, particularly rollover crashes.

Housing Locations

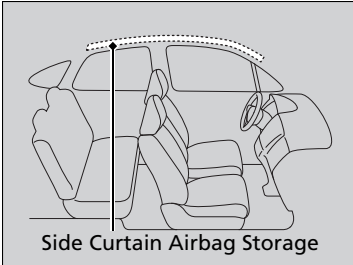

The side curtain airbags are located in the ceiling above the side windows on both sides of the vehicle.

Operation

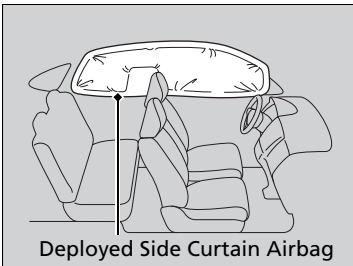

The side curtain airbag is designed to deploy in a rollover or a moderate-to-severe side impact.

Side Curtain Airbags

If the SRS control unit senses that your vehicle is about to rollover, it immediately deploys both side curtain airbags and activates both front seat belt tensioners.

If the impact is on the passenger's side, the passenger's side curtain airbag will inflate even if there are no occupants on that side of the vehicle.

To get the best protection from the side curtain airbags, occupants should wear their seat belts properly and sit upright and well back in their seats.

Do not attach any objects to the side windows or roof pillars as they can interfere with the proper operation of the side curtain airbags.

■ When side curtain airbags deploy in a frontal collision

One or both side curtain airbags may inflate in a moderate to severe angled frontal collision.

In this case, the side curtain airbags will deploy slightly after the front airbags.

Airbag System Indicators

If a problem occurs in the airbag system, the SRS indicator will come on and a message appears on the multi-information display.

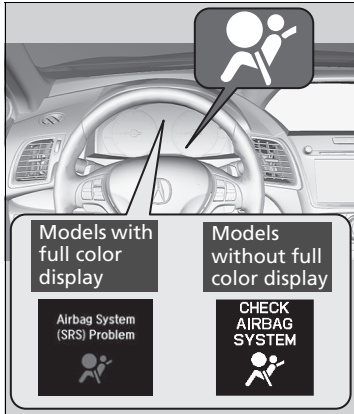
SRS (Supplemental Restraint System) Indicator**■ When the power mode is set to ON**

The indicator comes on for a few seconds, then goes off. This tells you the system is working properly.

If the indicator comes on at any other time, or does not come on at all, have the system checked by a dealer as soon as possible. If you don't, your airbags and seat belt tensioners may not work properly when they are needed.

▶▶ SRS (Supplemental Restraint System) Indicator

⚠ WARNING

Ignoring the SRS indicator can result in serious injury or death if the airbag systems or tensioners do not work properly.

Have your vehicle checked by a dealer as soon as possible if the SRS indicator alerts you to a possible problem.

Continued

■ Passenger Airbag Off Indicator

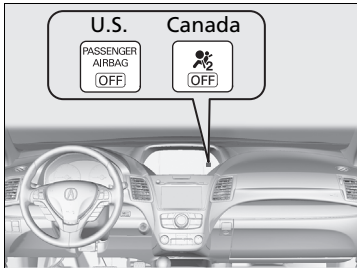

■ When the passenger airbag off indicator comes on

The indicator comes on to alert you that the passenger's front airbag has been turned off. This occurs when the front passenger's weight sensors detect 65 lbs (29 kg) or less, the weight of an infant or small child, on the seat.

Infants and small children should always ride properly restrained in a back seat.

▶ **Child Safety** P. 52

Objects placed on the seat can also cause the indicator to come on.

If the front passenger seat is empty, the passenger's front airbag will not deploy and the indicator will not come on.

▶▶ Passenger Airbag Off Indicator

If the indicator comes on with no front passenger and no objects on the passenger's seat, or with an adult riding there, something may be interfering with the weight sensors. Such as:

- An object hanging on the seat or in the seat-back pocket.
- A child seat or other object pressing against the rear of the seat-back.
- A rear passenger pushing or pulling on the back of the front passenger's seat.
- The front seat or seat-back is forced back against an object on the seat or floor behind it.
- An object placed under the front passenger's seat.

If none of these conditions exist, have your vehicle checked by a dealer as soon as possible.

The passenger airbag off indicator may come on and goes off repeatedly if the total weight on the seat is near the airbag cutoff threshold.

Airbag Care

You do not need to, and should not, perform any maintenance on or replace any airbag system components yourself. However, you should have your vehicle inspected by a dealer in the following situations:

■ When the airbags have deployed

If an airbag has inflated, the control unit and other related parts must be replaced. Similarly, once an automatic seat belt tensioner has been activated, it must be replaced.

■ When the vehicle has been in a moderate-to-severe collision

Even if the airbags did not inflate, have your dealer inspect the following: the driver's seat position sensor, weight sensors in the passenger's seat, front seat belt tensioners, and each seat belt that was worn during the crash.

■ Do not remove or modify a front seat without consulting a dealer

This would likely disable the driver's seat position sensor or the weight sensors in the passenger's seat. If it is necessary to remove or modify a front seat to accommodate a person with disabilities, contact an Acura dealer. For U.S. vehicles, Acura Client Service at 1-800-382-2238 and for Canadian vehicles, Acura Client Service at 1-888-9-ACURA-9.

✘ Airbag Care

We recommend against the use of salvaged airbag system components, including the airbag, tensioners, sensors, and control unit.

Protecting Child Passengers

Each year, many children are injured or killed in vehicle crashes because they are either unrestrained or not properly restrained. In fact, vehicle accidents are the number one cause of death of children ages 12 and under.

To reduce the number of child deaths and injuries, every state, Canadian province and territory requires that infants and children be properly restrained when they ride in a vehicle.

Children should sit properly restrained in a rear seat. This is because:

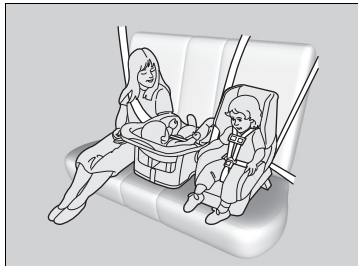

- An inflating front or side airbag can injure or kill a child sitting in the front seat.
- A child in the front seat is more likely to interfere with the driver's ability to safely control the vehicle.
- Statistics show that children of all sizes and ages are safer when they are properly restrained in a rear seat.

Protecting Child Passengers

⚠ WARNING

Children who are unrestrained or improperly restrained can be seriously injured or killed in a crash.

Any child too small for a seat belt should be properly restrained in a child seat. A larger child should be properly restrained with a seat belt, using a booster seat if necessary.

The National Highway Traffic Safety Administration and Transport Canada recommend that all children ages 12 and under be properly restrained in a rear seat. Some states or provinces/territories have laws restricting where children may ride.

- Any child who is too small to wear a seat belt correctly must be restrained in an approved child seat that is properly secured to the vehicle using either the lap belt portion of the lap/shoulder belt or the lower anchors of the LATCH system.
- Never hold a child on your lap because it is impossible to protect them in the event of a collision.
- Never put a seat belt over yourself and a child. During a crash, the belt would likely press deep into the child and cause serious or fatal injuries.
- Never let two children use the same seat belt. Both children could be very seriously injured in a crash.
- Do not allow children to operate the doors, windows or seat adjustments.
- Do not leave children in the vehicle unattended, especially in hot weather when the inside of the vehicle can get hot enough to kill them. They could also activate vehicle controls causing it to move unexpectedly.

▶▶ Protecting Child Passengers

⚠ WARNING

Allowing a child to play with a seat belt or wrap one around their neck can result in serious injury or death.

Instruct children not to play with any seat belt and make sure any unused seat belt a child can reach is buckled, fully retracted, and locked.

To deactivate a lockable retractor, release the buckle and allow the seat belt to wind up all the way.

To remind you of the passenger's front airbag hazards and child safety, your vehicle warning came with a label on the dashboard (U.S. models) and has labels on the front visors. Please read and follow the instructions on these labels.

▶▶ **Safety Labels** P. 65

Safety of Infants and Small Children

Protecting Infants

An infant must be properly restrained in a rear-facing, reclining child seat until the infant reaches the seat manufacturer's weight or height limit for the seat, and the infant is at least one year old.

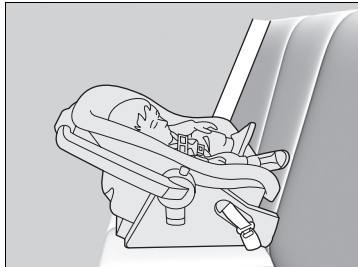

Positioning a rear-facing child seat

Child seats must be placed and secured in a rear seating position.

When properly installed, a rear-facing child seat may prevent the driver or a front passenger from moving their seat all the way back, or from locking their seat-back in the desired position.

It can also interfere with proper operation of the passenger's advanced front airbag system.

➤ **Airbags** P. 39

If this occurs, we recommend that you install the child seat directly behind the front passenger's seat, move the seat as far forward as needed, and leave it unoccupied. Or, you may wish to get a smaller rear-facing child seat.

Protecting Infants

WARNING

Placing a rear-facing child seat in the front seat can result in serious injury or death during a crash.

Always place a rear-facing child seat in the rear seat, not the front.

Rear-facing child seats should never be installed in a forward facing position.

Always refer to the child seat manufacturer's instructions before installation.

Protecting Smaller Children

If a child is at least one year old and within the weight range indicated by the child seat manufacturer, the child should be properly restrained in a firmly secured forward-facing child seat.

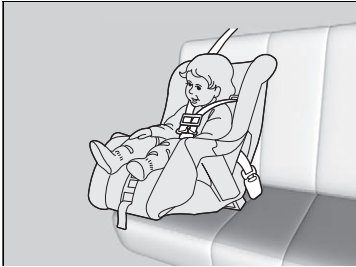

Forward-facing child seat placement

We strongly recommend placing a forward-facing child seat in a rear seating position.

Placing a forward-facing child seat in the front seat can be hazardous, even with advanced front airbags that automatically turn the passenger's front airbag off. A rear seat is the safest place for a child.

Protecting Smaller Children

WARNING

Placing a forward-facing child seat in the front seat can result in serious injury or death if the front airbag inflates.

If you must place a forward-facing child seat in front, move the vehicle seat as far back as possible, and properly restrain the child.

Educate yourself about the laws and regulations regarding child seat use where you are driving, and follow the child seat manufacturer's instructions.

Many experts recommend use of a rear-facing seat up to age two, if the child's height and weight are appropriate for a rear-facing seat.

■ Selecting a Child Seat

Most child seats are LATCH-compatible (Lower Anchors and Tethers for Children). Some have a rigid-type connector, while others have a flexible-type connector. Both are equally easy to use. Some existing and previously owned child seats can only be installed using the seat belt. Whichever type you choose, follow the child seat manufacturer's use and care instructions as well as the instructions in this manual. Proper installation is key to maximizing your child's safety.

In seating positions and vehicles not equipped with LATCH, a LATCH compatible child seat can be installed using the seat belt and a top tether for added security. This is because all child seats are required to be designed so that they can be secured with the lap part of a lap/shoulder belt. In addition, the child seat manufacturer may advise that a seat belt be used to attach a LATCH-compatible seat once a child reaches a specified weight. Please read the child seat owner's manual for proper installation instructions.

■ Important consideration when selecting a child seat

Make sure the child seat meets the following three requirements:

- The child seat is the correct type and size for the child.
- The child seat is the correct type for the seating position.
- The child seat is compliant with Federal Motor Vehicle Safety Standard 213 or Canadian Motor Vehicle Safety Standard 213.

▶▶ Selecting a Child Seat

Installation of a LATCH-compatible child seat is simple.

LATCH-compatible child seats have been developed to simplify the installation process and reduce the likelihood of injuries caused by incorrect installation.

Installing a LATCH-Compatible Child Seat

A LATCH-compatible child seat can be installed in either of the two outer rear seats. A child seat is attached to the lower anchors with either the rigid or flexible type of connectors.

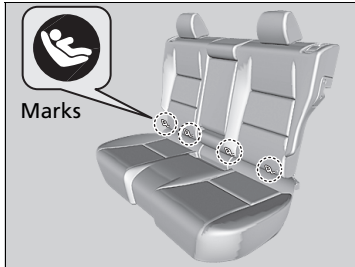

1. Locate the lower anchors under the marks.

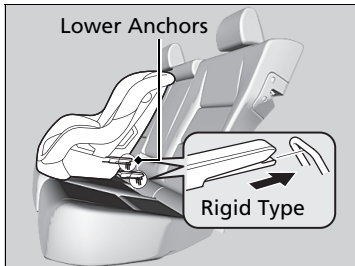

2. Place the child seat on the vehicle seat then attach the child seat to the lower anchors according to the instructions that came with the child seat.

▶ When installing the child seat, make sure that the lower anchors are not obstructed by the seat belt or any other object.

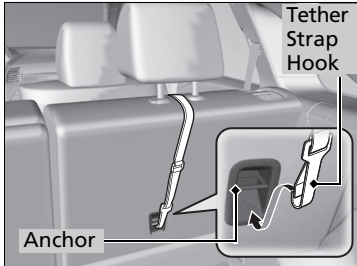
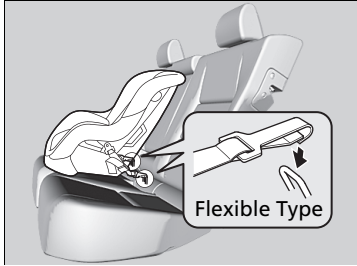

3. Put the head restraint to its upper-most position, then route the tether strap between the head restraint legs, and secure the tether strap hook onto the anchor.
4. Tighten the tether strap as instructed by the child seat manufacturer.
5. Make sure the child seat is firmly secured by rocking it forward and back and side to side; little movement should be felt.
6. Make sure any unused seat belt that a child can reach is buckled, the lockable retractor is activated, and the belt is fully retracted and locked.

▶ **Protecting Child Passengers** P. 52

▶▶ Installing a LATCH-Compatible Child Seat

For your child's safety, when using a child seat installed using the LATCH system, make sure that the seat is properly secured to the vehicle. A child seat that is not properly secured will not adequately protect a child in a crash and may cause injury to the child or other vehicle occupants.

Installing a Child Seat with a Lap/Shoulder Seat Belt



1. Place the child seat on the vehicle seat.
2. Route the seat belt through the child seat according to the seat manufacturer's instructions, and insert the latch plate into the buckle.
 - ▶ Insert the latch plate fully until it clicks.



3. Slowly pull the shoulder part of the belt all the way out until it stops. This activates the lockable retractor.
4. Let the seat belt completely wind up into the retractor, then try to pull it out to make sure the retractor is locked.
 - ▶ If you are able to pull the shoulder belt out, the lockable retractor is not activated. Pull the seat belt all the way out, and repeat steps 3 – 4.



5. Grab the shoulder part of the seat belt near the buckle, and pull up to remove any slack from the lap part of the belt.
 - ▶ When doing this, place your weight on the child seat and push it into the vehicle seat.

Installing a Child Seat with a Lap/Shoulder Seat Belt

A child seat that is not properly secured will not adequately protect a child in a crash and may cause injury to the child or other vehicle occupants.

Continued



6. Make sure the child seat is firmly secured by rocking it forward and back and side to side; little movement should be felt.
7. Make sure any unused seat belt that a child can reach is buckled, the lockable retractor is activated, and the belt is fully retracted and locked.

▶ **Protecting Child Passengers** P. 52

▶▶ Installing a Child Seat with a Lap/Shoulder Seat Belt

To deactivate a lockable retractor, release the buckle and allow the seat belt to wind up all the way.

▶▶ Adding Security with a Tether

Since a tether can provide additional security to the lap/shoulder seat belt installation, we recommend using a tether whenever one is available.

■ Adding Security with a Tether

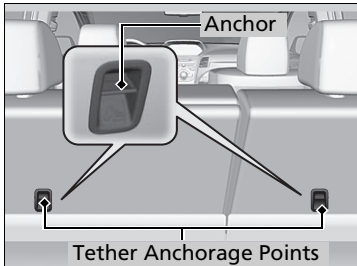

Two tether anchorage points are provided behind the rear outer seating positions and one in the ceiling for the rear center. A child seat that is installed with a seat belt and comes with a tether can use the tether for additional security.

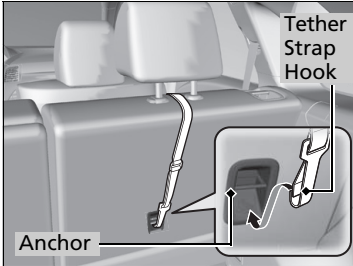

■ **Using an outer anchor**

1. Put the head restraint to its upper-most position, then route the tether strap through the head restraint legs. Make sure the strap is not twisted.
2. Secure the tether strap hook onto the anchor.
3. Tighten the tether strap as instructed by the child seat manufacturer.

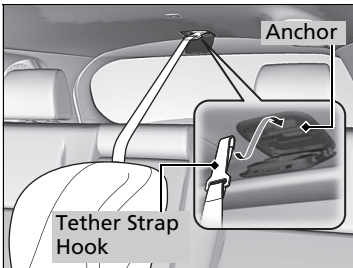

■ **Using the center anchor**

1. Lower the head restraint to its lowest position.
2. Open the anchor cover.
3. Route the tether strap over the head restraint. Make sure the strap is not twisted.
4. Secure the tether strap hook onto the anchor.
5. Tighten the tether strap as instructed by the child seat manufacturer.

Safety of Larger Children

Protecting Larger Children

The following pages give instructions on how to check proper seat belt fit, what kind of booster seat to use if one is needed, and important precautions for a child who must sit in front.

Checking Seat Belt Fit

When a child is too big for a child seat, secure the child in a rear seat using the lap/shoulder seat belt. Have the child sit upright and all the way back, then answer the following questions.



Checklist

- Do the child's knees bend comfortably over the edge of the seat?
- Does the shoulder belt cross between the child's neck and arm?
- Is the lap part of the seat belt as low as possible, touching the child's thighs?
- Will the child be able to stay seated like this for the whole trip?

If you answer yes to all these questions, the child is ready to wear the lap/shoulder seat belt correctly. If you answer no to any question, the child needs to ride on a booster seat until the seat belt fits properly without a booster seat.

Safety of Larger Children

WARNING

Allowing a child age 12 or under to sit in front can result in injury or death if the passenger's front airbag inflates.

If a larger child must ride in front, move the vehicle seat as far to the rear as possible, have the child sit up properly and wear the seat belt properly, using a booster seat if needed.

Booster Seats



If a lap/shoulder seat belt cannot be used properly, position the child in a booster seat in a rear seating position. For the child's safety, check that the child meets the booster seat manufacturer's recommendations.

Protecting Larger Children-Final Checks

Your vehicle has a rear seat where children can be properly restrained. If you ever have to carry a group of children, and a child must ride in front:

- Make sure you read and fully understand the instructions and safety information in this manual.
- Move the front passenger seat as far back as possible.
- Have the child sit upright and well back in the seat.
- Check that the seat belt is properly positioned so that the child is secure in the seat.

Monitoring child passengers

We strongly recommend that you keep an eye on child passengers. Even older, more mature children sometimes need to be reminded to fasten their seat belts and sit up properly.

Booster Seats

When installing a booster seat, make sure to read the instructions that came with it, and install the seat accordingly. There are high- and low-type booster seats. Choose a booster seat that allows the child to wear the seat belt correctly.

Some U.S. states and Canadian provinces and territories require children to use a booster seat until they reach a given age or weight (e.g. 6 years or 60 lbs). Be sure to check current laws in the state or province, or territory where you intend to drive.

Carbon Monoxide Gas

The engine exhaust from this vehicle contains carbon monoxide, a colorless, odorless, and highly toxic gas. As long as you properly maintain your vehicle, carbon monoxide gas will not get into the interior.

■ Have the exhaust system inspected for leaks whenever

- The exhaust system is making an unusual noise.
- The exhaust system may have been damaged.
- The vehicle is raised for an oil change.

When you operate a vehicle with the tailgate open, airflow can pull exhaust gas into the interior and create a hazardous condition. If you must drive with the tailgate open, open all the windows and set the climate control system as shown below.

1. Select the fresh air mode.
2. Select the  mode.
3. Set the fan speed to high.
4. Set the temperature control to a comfortable setting.

Adjust the climate control system in the same manner if you sit in your parked vehicle with the engine running.

Carbon Monoxide Gas

WARNING

Carbon monoxide gas is toxic. Breathing it can cause unconsciousness and even kill you.

Avoid any enclosed areas or activities that expose you to carbon monoxide.

An enclosed area such as a garage can quickly fill up with carbon monoxide gas. Do not run the engine with the garage door closed. Even when the garage door is open, drive out of the garage immediately after starting the engine.

Label Locations

These labels are in the locations shown. They warn you of potential hazards that can cause serious injury or death. Read these labels carefully.

If a label comes off or becomes hard to read (except for the U.S. dashboard label which may be removed by the owner), contact a dealer for a replacement.

Sun Visor

U.S. models

▲ WARNING

EVEN WITH ADVANCED AIR BAGS



- Children can be killed or seriously injured by the air bag.
- The back seat is the safest place for children.
- Never put a rear-facing child seat in the front.
- Always use seat belts and child restraints.
- See owner's manual for more information about air bags.

Canadian models

<p>CAUTION</p> <p>TO AVOID SERIOUS INJURY:</p> <ul style="list-style-type: none"> • FOR MAXIMUM SAFETY PROTECTION IN ALL TYPES OF CRASHES, YOU MUST ALWAYS WEAR YOUR SAFETY BELT. • DO NOT INSTALL REARWARD-FACING CHILD SEATS IN ANY FRONT PASSENGER SEAT POSITION. • DO NOT SIT OR LEAN UNNECESSARILY CLOSE TO THE AIR BAG. • DO NOT PLACE ANY OBJECTS OVER THE AIR BAG OR BETWEEN THE AIR BAG AND YOURSELF. • SEE THE OWNER'S MANUAL FOR FURTHER INFORMATION AND EXPLANATIONS. 	<p>PRECAUTIONS:</p> <p>POUR EVITER DES BLESSURES GRAVES:</p> <p>MAXIMALE LORS D'UNE COLLISION BOUCLEZ TOUJOURS VOTRE CEINTURE DE SECURITE.</p> <ul style="list-style-type: none"> • N'INSTALLEZ JAMAIS UN SIEGE POUR ENFANTS FAISANT FACE A L'ARRIERE SUR LE SIEGE DU PASSAGER AVANT. • NE VOUS APPUYEZ PAS ET NE VOUS ASSOYEZ PAS PRES DU COUSSIN GONFLABLE. • NE DEPOSEZ AUCUN OBJET SUR LE COUSSIN GONFLABLE OU ENTRE LE COUSSIN GONFLABLE ET VOUS. • LISEZ LE GUIDE UTILISATEUR POUR DE PLUS AMPLES RENSEIGNEMENTS.
---------------------------------------------------------------------------------------------------------------------------------------------------------------------------------------------------------------------------------------------------------------------------------------------------------------------------------------------------------------------------------------------------------------------------------------------------------------------------------------------------------------------------------------------	--------------------------------------------------------------------------------------------------------------------------------------------------------------------------------------------------------------------------------------------------------------------------------------------------------------------------------------------------------------------------------------------------------------------------------------------------------------------------------------------------------------------------------------------------------------------------

Dashboard

U.S. models only

This Vehicle is Equipped with Advanced Air Bags

Even with Advanced Air Bags

Children can be killed or seriously injured by the air bag. The back seat is the safest place for children. Never put a rear-facing child seat in the front. Always use seat belts and child restraints. See owner's manual for more information about air bags.

to be removed by owner only.

Sun Visor

U.S. models only

▲ WARNING: HIGHER ROLLOVER RISK



Avoid Abrupt Maneuvers and Excessive Speed. Always Buckle Up. See Owner's Manual For Further Information.



Radiator Cap

DANGER WARNING

危險 警告

- ▶ NEVER OPEN WHEN HOT. Hot coolant will scald you.
- ▶ NEVER PING QUAND CHAUD. Hot coolant will scald you.
- ▶ NEVER OPEN WHEN HOT. Hot coolant will scald you.
- ▶ NEVER PING QUAND CHAUD. Hot coolant will scald you.

1.1

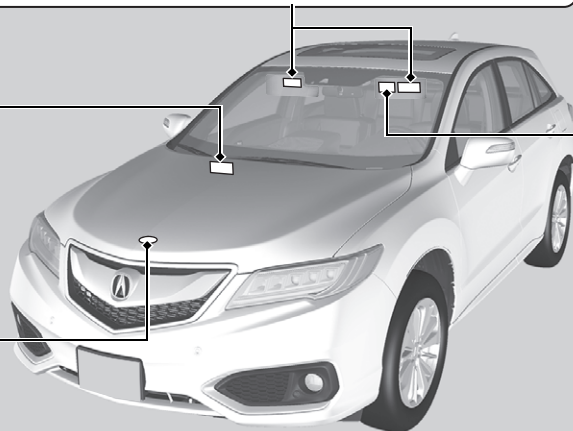



Instrument Panel

This chapter describes the buttons, indicators, and gauges that are used while driving.





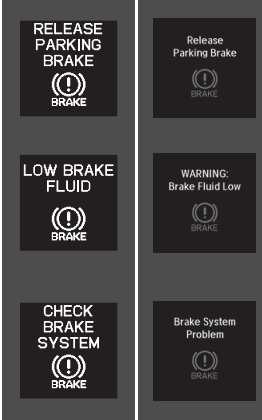

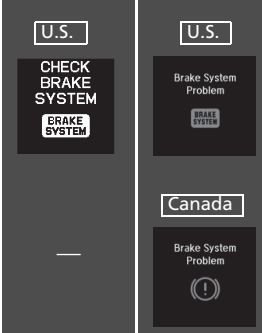

Indicators	68
Multi-Information Display Warning and Information Messages.....	84
Gauges and Multi-Information Display	
Gauges.....	95
Multi-Information Display	96

Indicators











Indicator	Name	On/Blinking	Explanation	Message*1
 <p>(Red)</p>	Parking Brake and Brake System Indicator (Red)	<ul style="list-style-type: none"> Comes on for a few seconds when you set the power mode to ON, then goes off if the parking brake has been released. Comes on when the parking brake is applied, and goes off when it is released. Comes on when the brake fluid level is low. Comes on if there is a problem with the brake system. The beeper sounds and the indicator comes on if you drive with the parking brake not fully released. 	<ul style="list-style-type: none"> Comes on while driving - Make sure the parking brake is released. Check the brake fluid level. <ul style="list-style-type: none"> ➤ What to do when the indicator comes on while driving P. 424 Comes on along with the ABS indicator - Have the vehicle checked by a dealer. <ul style="list-style-type: none"> ➤ If the Brake System Indicator (Red) Comes On P. 424 	
 <p>(Amber)</p>	Brake System Indicator (Amber)	<ul style="list-style-type: none"> Comes on for a few seconds when you set the power mode to ON, then goes off. Comes on if there is a problem with a system related to braking other than the conventional brake system. 	<ul style="list-style-type: none"> Stays on constantly - Have the vehicle checked by a dealer. 	

*1: On the left: Models without full color display
On the right: Models with full color display

Indicator	Name	On/Blinking	Explanation	Message*1
	Low Oil Pressure Indicator	<ul style="list-style-type: none"> • Comes on when you set the power mode to ON, and goes off when the engine starts. • Comes on when the engine oil pressure is low. 	<ul style="list-style-type: none"> • Comes on while driving - Immediately stop in a safe place. <ul style="list-style-type: none"> ▶ If the Low Oil Pressure Indicator Comes On P. 422 	<div style="display: flex; justify-content: space-around;"> <div style="background-color: #333; color: white; padding: 5px; text-align: center;"> CHECK ENGINE OIL LEVEL  </div> <div style="background-color: #333; color: white; padding: 5px; text-align: center;"> Engine Oil Low  </div> </div>
	Malfunction Indicator Lamp	<ul style="list-style-type: none"> • Comes on when you set the power mode to ON, and goes off either when the engine starts or after several seconds if the engine does not start. If "readiness codes" have not been set, it blinks five times before it goes off. • Comes on if there is a problem with the emissions control system. • Blinks when a misfire in the engine's cylinders is detected. 	<ul style="list-style-type: none"> • Readiness codes are part of the on board diagnostics for the emissions control systems. <ul style="list-style-type: none"> ▶ Testing of Readiness Codes P. 437 • Comes on while driving - Have the vehicle checked by a dealer. • Blinks while driving - Stop in a safe place where there are no flammable objects. Stop the engine for 10 minutes or more, and wait for it to cool down. Then, take the vehicle to a dealer. <ul style="list-style-type: none"> ▶ If the Malfunction Indicator Lamp Comes On or Blinks P. 423 	<div style="display: flex; justify-content: space-around;"> <div style="background-color: #333; color: white; padding: 5px; text-align: center;"> CHECK EMISSION SYSTEM  </div> <div style="background-color: #333; color: white; padding: 5px; text-align: center;"> Emissions System Problem  </div> </div>

Instrument Panel

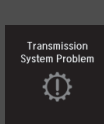
*1: On the left: Models without full color display
 On the right: Models with full color display















Indicator	Name	On/Blinking	Explanation	Message*1	
	Charging System Indicator	<ul style="list-style-type: none"> Comes on when you set the power mode to ON, and goes off when the engine starts. Comes on when the battery is not charging. 	<ul style="list-style-type: none"> Comes on while driving - Turn off the climate control system and rear defogger in order to reduce electricity consumption. ☒ If the Charging System Indicator Comes On P. 422 		
 *2  *3	Shift Lever Position Indicator	<ul style="list-style-type: none"> Indicates current shift lever position. 	<ul style="list-style-type: none"> ☒ Shifting P. 277 	—	—
 *2  *3	Transmission Indicator	<ul style="list-style-type: none"> Blinks if the transmission system has a problem. 	<ul style="list-style-type: none"> Blinks while driving - Avoid sudden starts and acceleration and have the vehicle checked by a dealer immediately. 		
 *2  *3	M (sequential shift mode) Indicator/Gear Position Indicator	<ul style="list-style-type: none"> Comes on when the manual sequential shift mode is applied. 	<ul style="list-style-type: none"> ☒ Sequential Shift Mode P. 279 	—	—

*1: On the left: Models without full color display







On the right: Models with full color display

*2: Models with full color display







*3: Models without full color display

Indicator	Name	On/Blinking	Explanation	Message*1
	Seat Belt Reminder Indicator	<ul style="list-style-type: none"> Comes on and the beeper sounds if you are not wearing a seat belt when you set the power mode to ON. If the front passenger is not wearing a seat belt, the indicator comes on about a few seconds later. Blinks while driving if either you or the front passenger has not fastened a seat belt. The beeper sounds and the indicator blinks at regular intervals. 	<ul style="list-style-type: none"> The beeper stops and the indicator goes off when you and the front passenger fasten their seat belts. Stays on after you or the front passenger has fastened the seat belt - A detection error may have occurred in the sensor. Have the vehicle checked by a dealer.  Seat Belt Reminder P. 32 	<div style="display: flex; justify-content: space-around;"> <div style="background-color: #333; color: white; padding: 5px; text-align: center;"> FASTEN SEAT BELT  </div> <div style="background-color: #333; color: white; padding: 5px; text-align: center;"> Fasten Seat Belt  </div> </div> <div style="display: flex; justify-content: space-around; margin-top: 10px;"> <div style="background-color: #333; color: white; padding: 5px; text-align: center;"> FASTEN PASSENGER SEAT BELT  </div> <div style="background-color: #333; color: white; padding: 5px; text-align: center;"> Fasten Passenger's Seat Belt  </div> </div>
	Low Fuel Indicator	<ul style="list-style-type: none"> Comes on when the fuel reserve is running low (approximately 2.5 U.S. gal./9.2 Liter left). Blinks if there is a problem with the fuel gauge. 	<ul style="list-style-type: none"> Comes on - Refuel your vehicle as soon as possible. Blinks - Have the vehicle checked by a dealer. 	<div style="display: flex; justify-content: space-around;"> <div style="background-color: #333; color: white; padding: 5px; text-align: center;"> LOW FUEL  </div> <div style="background-color: #333; color: white; padding: 5px; text-align: center;"> Fuel Low  </div> </div> <div style="display: flex; justify-content: space-around; margin-top: 10px;"> <div style="background-color: #333; color: white; padding: 5px; text-align: center;"> CHECK FUEL GAUGE SYSTEM  </div> <div style="background-color: #333; color: white; padding: 5px; text-align: center;"> Fuel Gauge System Problem  </div> </div>
	Anti-lock Brake System (ABS) Indicator	<ul style="list-style-type: none"> Comes on for a few seconds when you set the power mode to ON, then goes off. If it comes on at any other time, there is a problem with the ABS. 	<ul style="list-style-type: none"> Stays on constantly - Have the vehicle checked by a dealer. With this indicator on, your vehicle still has normal braking ability but no anti-lock function.  Anti-lock Brake System (ABS) P. 322 	<div style="display: flex; justify-content: space-around;"> <div style="background-color: #333; color: white; padding: 5px; text-align: center;"> CHECK ABS SYSTEM  </div> <div style="background-color: #333; color: white; padding: 5px; text-align: center;"> Anti-Lock Brake System Problem  </div> </div>









*1: On the left: Models without full color display
 On the right: Models with full color display

Indicator	Name	On/Blinking	Explanation	Message* ¹	
	Supplemental Restraint System Indicator	<ul style="list-style-type: none"> • Comes on for a few seconds when you set the power mode to ON, then goes off. • Comes on if a problem with any of the following is detected: <ul style="list-style-type: none"> - Supplemental restraint system - Side airbag system - Side curtain airbag system - Seat belt tensioner 	<ul style="list-style-type: none"> • Stays on constantly or does not come on at all - Have the vehicle checked by a dealer. 		
	All-Wheel Drive (AWD) with Intelligent Control System Indicator*	<ul style="list-style-type: none"> • Comes on for a few seconds when you set the power mode to ON, then goes off. • Comes on if there is a problem with the AWD with intelligent control system. • Blinks when the AWD with intelligent control system is overheated. The system is inactive. 	<ul style="list-style-type: none"> • Stays on constantly - the engine drives only the front wheels in this state. Have the vehicle checked by a dealer. • Blinks while driving - the engine drives only the front wheels in this state. Stop in a safe place, shift to [P], and idle the engine until the indicator goes off. If the indicator does not stop blinking, take your vehicle to a dealer. <ul style="list-style-type: none"> ➤ All-Wheel Drive (AWD) with Intelligent Control System* P. 316 		



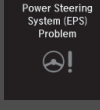

*1: On the left: Models without full color display
 On the right: Models with full color display

Indicator	Name	On/Blinking	Explanation	Message*1	
	Vehicle Stability Assist (VSA®) System Indicator	<ul style="list-style-type: none"> • Comes on for a few seconds when you set the power mode to ON, then goes off. • Blinks when VSA® is active. • Comes on if there is a problem with the VSA® system or hill start assist system. 	<ul style="list-style-type: none"> • Stays on constantly - Have the vehicle checked by a dealer. <ul style="list-style-type: none"> ➤ Vehicle Stability Assist (VSA®), aka Electronic Stability Control (ESC), System P. 311 		
	Vehicle Stability Assist (VSA®) OFF Indicator	<ul style="list-style-type: none"> • Comes on for a few seconds when you set the power mode to ON, then goes off. • Comes on when you deactivate VSA®. 	<ul style="list-style-type: none"> ➤ VSA® On and Off P. 312 		



*1: On the left: Models without full color display
 On the right: Models with full color display

Indicator	Name	On/Blinking	Explanation	Message*1	
	Door and Tailgate Open Indicator*	<ul style="list-style-type: none"> Comes on for a few seconds if you set the power mode to ON, then goes off. Comes on if any door or the tailgate is not completely closed. The beeper sounds and the indicator comes on if any door or the tailgate is opened while driving. 	<ul style="list-style-type: none"> Goes off when all doors and the tailgate are closed. 		
					
					
	Electric Power Steering (EPS) System Indicator	<ul style="list-style-type: none"> Comes on when you set the power mode to ON, and goes off when the engine starts. Comes on if there is a problem with the Electric Power Steering (EPS) System. 	<ul style="list-style-type: none"> Stays on constantly or does not come on at all - Have the vehicle checked by a dealer. <ul style="list-style-type: none"> ➤ If the Electric Power Steering (EPS) System Indicator Comes On P. 424 		







*1: On the left: Models without full color display
 On the right: Models with full color display
 *2: Models without full color display

Indicator	Name	On/Blinking	Explanation	Message*1	
	Low Tire Pressure/TPMS Indicator	<ul style="list-style-type: none"> • Comes on for a few seconds when you set the power mode to ON. • Comes on if the tire pressure of any of the tires becomes significantly low. • Blinks for about one minute, and then stays on if there is a problem with the TPMS, or when a compact spare tire is temporarily installed. 	<ul style="list-style-type: none"> • Comes on while driving - Stop in a safe place, check tire pressures, and inflate the tire(s) if necessary. • Blinks and remains on - Have the vehicle checked by a dealer. If the vehicle is fitted with a compact spare, get your regular tire repaired or replaced and put back on your vehicle as soon as you can. 		
	Turn Signal and Hazard Warning Indicators	<ul style="list-style-type: none"> • The turn signal indicators blink when you operate the turn signal lever. • If you press the hazard warning button, both indicators and all turn signals blink at the same time. 	<ul style="list-style-type: none"> • Does not blink or blinks rapidly - A turn signal light bulb has blown. Change the bulb immediately. <ul style="list-style-type: none"> ✉ Front Turn Signal Light/Parking Light/Daytime Running Light and Front Side Marker Light Bulbs P. 367 	—	—
	High Beam Indicator	<ul style="list-style-type: none"> • Comes on when the high beam headlights are on. 	—	—	—

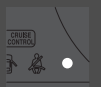











*1: On the left: Models without full color display
 On the right: Models with full color display

Indicator	Name	On/Blinking	Explanation	Message*1	
	Lights On Indicator	<ul style="list-style-type: none"> Comes on whenever the light switch is on, or in AUTO when the exterior lights are on. 	<ul style="list-style-type: none"> If you set the power mode to ACCESSORY or VEHICLE OFF (LOCK) while the lights are on, a chime sounds when the driver's door is opened. 	—	—
	Fog Light Indicator*	<ul style="list-style-type: none"> Comes on when the fog lights are on. 	—	—	—
	Immobilizer System Indicator	<ul style="list-style-type: none"> Comes on briefly when you set the power mode to ON, then goes off. Comes on if the immobilizer system cannot recognize the key information. 	<ul style="list-style-type: none"> Blinks - You cannot start the engine. Set the power mode to VEHICLE OFF (LOCK), then select the ON mode again. Repeatedly blinks - The system may be malfunctioning. Have the vehicle checked by a dealer. Do not attempt to alter this system or add other devices to it. Electrical problems can occur. 	—	—

*1: On the left: Models without full color display
 On the right: Models with full color display

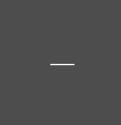
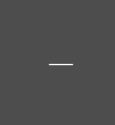
Indicator	Name	On/Blinking	Explanation	Message*1	
	Security System Alarm Indicator	<ul style="list-style-type: none"> Blinks when the security system alarm has been set. 	 Security System Alarm P. 139	—	—
	System Message Indicator	<ul style="list-style-type: none"> Comes on for a few seconds when you set the power mode to ON, then goes off. Comes on along with a beep when a problem is detected. A system message on the multi-information display appears at the same time. 	<ul style="list-style-type: none"> While the indicator is on, press the  /  (information) button to see the message again. Refer to the Indicators information in this chapter when a system message appears on the multi-information display. Take the appropriate action for the message. The multi-information display does not return to the normal screen unless the warning is canceled, or the  /  button is pressed. 	—	—



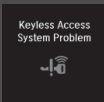
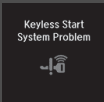



*1: On the left: Models without full color display
 On the right: Models with full color display

Indicator	Name	On/Blinking	Explanation	Message*1	
 *2  *3	CRUISE MAIN Indicator*	<ul style="list-style-type: none"> Comes on when you press the CRUISE button. 	 Cruise Control * P. 281		
 *2  *3	CRUISE CONTROL Indicator*	<ul style="list-style-type: none"> Comes on if you have set a speed for cruise control. 	 Cruise Control * P. 281		
	Keyless Access System Indicator	<ul style="list-style-type: none"> Comes on for a few seconds when you change the power mode to ON, then goes off. Comes on as soon as a problem is detected in the keyless access system or keyless starting system. 	<ul style="list-style-type: none"> Have your vehicle checked by a dealer. 	 	 

*1: On the left: Models without full color display
 On the right: Models with full color display

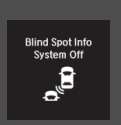

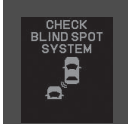
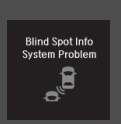

*2: Models with full color display

*3: Models without full color display

Indicator	Name	On/Blinking	Explanation	Message*1
	Blind spot information (BSI) System Indicator*	<ul style="list-style-type: none"> Comes on for a few seconds when you change the power mode to ON, then goes off. Stays on while BSI is turned off. 	—	 
		<ul style="list-style-type: none"> Comes on when mud, snow, or ice accumulates in the vicinity of sensor. 	<ul style="list-style-type: none"> Comes on while driving - Remove the obstacle in the vicinity of sensor.  Blind spot information (BSI) System* P. 313 	 
		<ul style="list-style-type: none"> Comes on if there is a problem with the system. 	<ul style="list-style-type: none"> Comes on while driving - Have your vehicle checked by a dealer. 	 

*1: On the left: Models without full color display
 On the right: Models with full color display

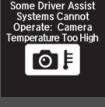
Models with LDW



Indicator	Name	On/Blinking	Explanation	Message
	Lane Departure Warning (LDW) Indicator	<ul style="list-style-type: none"> • Comes on for a few seconds when you change the power mode to ON, then goes off. • Comes on if there is a problem with the LDW system. 	<ul style="list-style-type: none"> • Stays on constantly - Have your vehicle checked by a dealer. 	
		<ul style="list-style-type: none"> • Comes on when the LDW system shuts itself off. 	<ul style="list-style-type: none"> • Stays on - The temperature inside the camera is too high. Use the climate control system to cool down the camera. The system activates when the temperature inside the camera cools down.  Front Sensor Camera * P. 284 	
			<ul style="list-style-type: none"> • Stays on - The area around the camera is blocked by dirt, mud, etc. Stop your vehicle in a safe place, and wipe it off with a soft cloth. • Have your vehicle checked by a dealer if the indicator and message come back on after you cleaned the area around the camera.  Front Sensor Camera * P. 284 	

Indicator	Name	On/Blinking	Explanation	Message
	Adaptive Cruise Control (ACC) Indicator (Amber)*	<ul style="list-style-type: none"> Comes on for a few seconds when you set the power mode to ON, then goes off. Comes on if there is a problem with ACC. 	<ul style="list-style-type: none"> Comes on while driving - Have your vehicle checked by a dealer. 	
	Adaptive Cruise Control (ACC) Indicator (Green)*	<ul style="list-style-type: none"> Comes on when you press the MAIN button. 	<p>➤ Adaptive Cruise Control (ACC)* P. 286</p>	—
	Lane Keeping Assist System (LKAS) Indicator (Amber)*	<ul style="list-style-type: none"> Comes on for a few seconds when you set the power mode to ON, then goes off. Comes on if there is a problem with the LKAS. 	<ul style="list-style-type: none"> Stays on constantly - Have your vehicle checked by a dealer. 	
	Lane Keeping Assist System (LKAS) Indicator (Green)*	<ul style="list-style-type: none"> Comes on when you press the MAIN button. 	<p>➤ Lane Keeping Assist System (LKAS)* P. 303</p>	—





Instrument Panel

* Not available on all models

Models with CMBS™

Indicator	Name	On/Blinking	Explanation	Message
	Collision Mitigation Braking System™ (CMBS™) Indicator	<ul style="list-style-type: none"> • Comes on for a few seconds when you change the power mode to ON, then goes off. • Comes on when you deactivate the CMBS™. A multi-information display message appears for five seconds. • Comes on if there is a problem with the CMBS™. 	<ul style="list-style-type: none"> • Stays on constantly without the CMBS™ off - Have your vehicle checked by a dealer. <ul style="list-style-type: none"> ➤ Collision Mitigation Braking System™ (CMBS™)* P. 324 	

Models with CMBS™

Indicator	Name	On/Blinking	Explanation	Message
	Collision Mitigation Braking System™ (CMBS™) Indicator	<ul style="list-style-type: none"> Comes on when the CMBS™ system shuts itself off. 	<ul style="list-style-type: none"> Stays on - The area around the camera is blocked by dirt, mud, etc. Stop your vehicle in a safe place, and wipe it off with a soft cloth. <ul style="list-style-type: none"> ➤ Front Sensor Camera * P. 284 	
		<ul style="list-style-type: none"> When the radar sensor gets dirty, stop your vehicle in a safe place, and wipe off dirt using a soft cloth. Have your vehicle checked by a dealer if the message does not disappear even after you clean the sensor cover. <ul style="list-style-type: none"> ➤ Collision Mitigation Braking System™ (CMBS™) * P. 324 		
		<ul style="list-style-type: none"> Stays on - The temperature inside the camera is too high. Use the climate control system to cool down the camera. The system activates when the temperature inside the camera cools down. <ul style="list-style-type: none"> ➤ Front Sensor Camera * P. 284 		





* Not available on all models

Multi-Information Display Warning and Information Messages







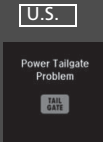
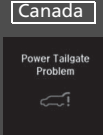

The following messages appear only on the multi-information display. Press the / (information) button to see the message again with the system message indicator on.

Message*1		Condition	Explanation
		<ul style="list-style-type: none"> Appears when the fuel fill cap is loose or is not installed. 	<ul style="list-style-type: none"> Tighten Fuel Cap Message P. 423
	<div style="border: 1px solid black; padding: 2px;">Canadian models</div>	<ul style="list-style-type: none"> Appears when the washer fluid is low. 	<ul style="list-style-type: none"> Refill washer fluid. Refilling Window Washer Fluid P. 364
		<ul style="list-style-type: none"> Appears while you are customizing the settings and the shift lever is moved out of P. 	<ul style="list-style-type: none"> Customized Features P. 102, 108
		<ul style="list-style-type: none"> Appears when the transmission fluid temperature is too high. 	<ul style="list-style-type: none"> Stop in a safe place in P. Let the engine idle until the message disappears.

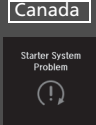

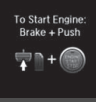





*1: On the left: Models without full color display
On the right: Models with full color display

Message*1		Condition	Explanation
 	<ul style="list-style-type: none"> • Appears when the scheduled maintenance is due soon. • Consequently, SERVICE DUE NOW/ Maintenance Due Soon and SERVICE PAST DUE/Maintenance Past Due follow. 	<p>➤ Maintenance Minder Messages on the Multi-Information Display P. 350</p>	
 	<ul style="list-style-type: none"> • Appears when the engine coolant temperature gets abnormally high. 	<p>➤ Overheating P. 420</p>	
 	<ul style="list-style-type: none"> • Appears when there is a problem with the power tailgate system. 	<ul style="list-style-type: none"> • Manually open or close the power tailgate. • Have the vehicle checked by a dealer. 	
			



*1: On the left: Models without full color display
 On the right: Models with full color display

Message*1		Condition	Explanation
 		<ul style="list-style-type: none"> Appears if there is a problem with the starting system. 	<ul style="list-style-type: none"> As a temporary measure, press and hold the ENGINE START/STOP button for 15 seconds while depressing the brake pedal and manually start the engine. Have the vehicle checked by a dealer.
 		<ul style="list-style-type: none"> Appears after you unlock and open the driver's door. 	<p>➔ Starting the Engine P. 270</p>
 		<ul style="list-style-type: none"> Appears three seconds after the TO START ENGINE/To Start Engine message appears. 	<p>➔ Starting the Engine P. 270</p>
 		<ul style="list-style-type: none"> Appears when the steering wheel is locked. 	<ul style="list-style-type: none"> Move the steering wheel left and right after pressing the ENGINE START/STOP button.







*1: On the left: Models without full color display
 On the right: Models with full color display

Message*1		Condition	Explanation
		<ul style="list-style-type: none"> Appears if you press the ENGINE START/STOP button to turn the engine off without the shift lever in P. 	<ul style="list-style-type: none"> Press the ENGINE START/STOP button twice after moving the shift lever to P.
		<ul style="list-style-type: none"> Appears when the power mode is in ACCESSORY. 	—
		<ul style="list-style-type: none"> Appears after the driver's door is opened when the power mode is in ACCESSORY. 	<ul style="list-style-type: none"> Press the ENGINE START/STOP button twice with your foot off the brake pedal to change the power mode to VEHICLE OFF (LOCK).
		<ul style="list-style-type: none"> Appears when you close the door with the power mode in ON without the keyless access remote inside the vehicle. 	<ul style="list-style-type: none"> The message goes off when you bring the keyless access remote back inside the vehicle, and close the door. <p>➤ Keyless Access Remote Reminder P. 148</p>

*1: On the left: Models without full color display
 On the right: Models with full color display

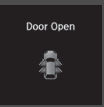

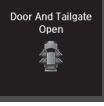
Message*1	Condition	Explanation
	<ul style="list-style-type: none"> • Appears when the keyless access remote battery becomes weak. 	<ul style="list-style-type: none"> • Replace the battery as soon as possible. <ul style="list-style-type: none"> ➤ Replacing the Button Battery P. 386
	<ul style="list-style-type: none"> • Appears if the keyless access remote's battery is too weak to start the engine or the key is not with you when starting the engine. A beeper sounds six times. 	<ul style="list-style-type: none"> ➤ If the Keyless Access Remote Battery is Weak P. 415

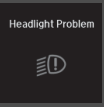
* 1: On the left: Models without full color display
 On the right: Models with full color display



Message*1	Condition	Explanation
<div style="display: flex; justify-content: space-around;"> <div style="text-align: center;">    </div> <div style="text-align: center;">    </div> </div>	<ul style="list-style-type: none"> • Appears if any door or the tailgate is not completely closed. • The beeper sounds and the message appears if any door or the tailgate is opened while driving. 	<ul style="list-style-type: none"> • Goes off when all doors and the tailgate are closed.
<div style="display: flex; justify-content: space-around;"> <div style="text-align: center;">  </div> <div style="text-align: center;">  </div> </div>	<ul style="list-style-type: none"> • Appears when there is a problem with the headlights. 	<ul style="list-style-type: none"> • Appears while driving - The low beam headlights may not be on. When conditions allow you to drive safely, have your vehicle checked by a dealer as soon as possible.

*1: On the left: Models without full color display
 On the right: Models with full color display

Models with parking sensor system

Message	Condition	Explanation
 <p>Parking Sensor System Problem</p>	<ul style="list-style-type: none"> • Appears if there is a problem with the parking sensor system. 	<ul style="list-style-type: none"> • Check if the area around the sensor(s) is covered with mud, ice, snow, etc. If the indicator(s) stays on even after you clean the area, have the system checked by a dealer.
 <p>WARNING: Approaching Object</p>	<ul style="list-style-type: none"> • Appears if there are obstacles around the sensors. 	<ul style="list-style-type: none"> • Check for obstacles near your vehicle to make sure it is safe to park.

Models with ACC

Message	Condition	Explanation
	<ul style="list-style-type: none"> Flashes when the system senses a likely collision with a vehicle in front of you. 	<ul style="list-style-type: none"> Take the appropriate means to prevent a collision (apply the brakes, change lanes, etc.). <ul style="list-style-type: none"> ➤ Collision Mitigation Braking System™ (CMBS™)* P. 324 ➤ Adaptive Cruise Control (ACC)* P. 286
	<ul style="list-style-type: none"> Appears when ACC has been automatically canceled. 	<ul style="list-style-type: none"> You can resume the set speed after the condition that caused ACC to cancel improves. Press the RES/ACCEL button. <ul style="list-style-type: none"> ➤ Adaptive Cruise Control (ACC)* P. 286
	<ul style="list-style-type: none"> Appears if anything covers the radar sensor cover and prevents the sensor from detecting a vehicle in front. May appear when driving in bad weather (rain, snow, fog, etc.). 	<ul style="list-style-type: none"> When the radar sensor gets dirty, stop your vehicle in a safe place, and wipe off dirt using a soft cloth. Have your vehicle checked by a dealer if the message does not disappear even after you clean the sensor cover.

* Not available on all models

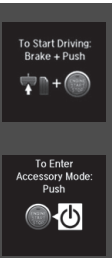

Models with two-way keyless access remote

Message	Condition	Explanation
	<ul style="list-style-type: none"> • Appears when you unlock and open the driver's door while the engine is running by two-way keyless access remote. 	<p>➤ Remote Engine Start with Vehicle Feedback* P. 272</p>

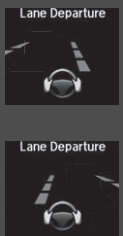
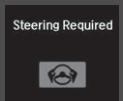
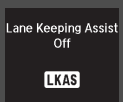
Models with LKAS

Message	Condition	Explanation
	<ul style="list-style-type: none"> • Appears when the vehicle is driving out of a detected lane. The beeper sounds simultaneously. • Beeps and a warning display alert you that the vehicle is drifting out of a detected lane. 	<ul style="list-style-type: none"> • Keep the vehicle within the lane you are driving. • The color of either line changes from white to amber as the vehicle gets closer to that side of the lane line.
	<ul style="list-style-type: none"> • Blinks when you fail to steer the vehicle. The beeper sounds simultaneously. 	<ul style="list-style-type: none"> • Operate the steering wheel to resume the LKAS.
	<ul style="list-style-type: none"> • Appears when the LKAS is in operation, or the LKAS button is pressed, but there is a problem with a system related to the LKAS. The LKAS cancels automatically. The beeper sounds simultaneously. 	<ul style="list-style-type: none"> • If any other system indicators come on, such as the VSA®, ABS and brake system, take appropriate action.

Models with LKAS

Message	Condition	Explanation
	<ul style="list-style-type: none"> • Appears if the temperature inside the camera is too high. • The LKAS and ACC have been automatically canceled. 	<ul style="list-style-type: none"> • Use the climate control system to cool down the camera. • Goes off - The camera has been cooled down. Pressing the LKAS button and MAIN button can resume the system. <ul style="list-style-type: none"> ➤ Front Sensor Camera* P. 284 ➤ Adaptive Cruise Control (ACC)* P. 286 ➤ Lane Keeping Assist System (LKAS)* P. 303
	<ul style="list-style-type: none"> • Appears when the area around the camera is blocked by dirt, mud, etc. Stop your vehicle in a safe place, and wipe it off with a soft cloth. • May appear when driving in bad weather (rain, snow, fog, etc.). 	<ul style="list-style-type: none"> • Have your vehicle checked by a dealer if the indicator and message come back on after you cleaned the area around the camera.

Gauges

Gauges include the speedometer, tachometer, fuel gauge, and related indicators. They are displayed when the power mode is in ON.

Speedometer

Displays your driving speed in mph (U.S.) or km/h (Canada).

Tachometer

Shows the number of engine revolutions per minute.

Fuel Gauge

Displays the amount of fuel left in the fuel tank.

Temperature Gauge

Displays the temperature of the engine coolant.

Fuel Gauge

NOTICE

You should refuel when the reading approaches **E**. Running out of fuel can cause the engine to misfire, damaging the catalytic converter.

The actual amount of remaining fuel may differ from the fuel gauge reading.

Temperature Gauge

NOTICE

Driving with the temperature gauge pointer in the upper zone can cause serious engine damage. Pull safely to the side of the road and allow engine temperature to return to normal.

➤ **Overheating** P. 420

Multi-Information Display

The multi-information display shows the odometer, trip meter, outside temperature indicator, and other gauges. It also displays important messages such as warnings and other helpful information.

Switching the Display

Main displays

Press the / (information) button or the **SEL/RESET** button to change the display.

Models without full color display

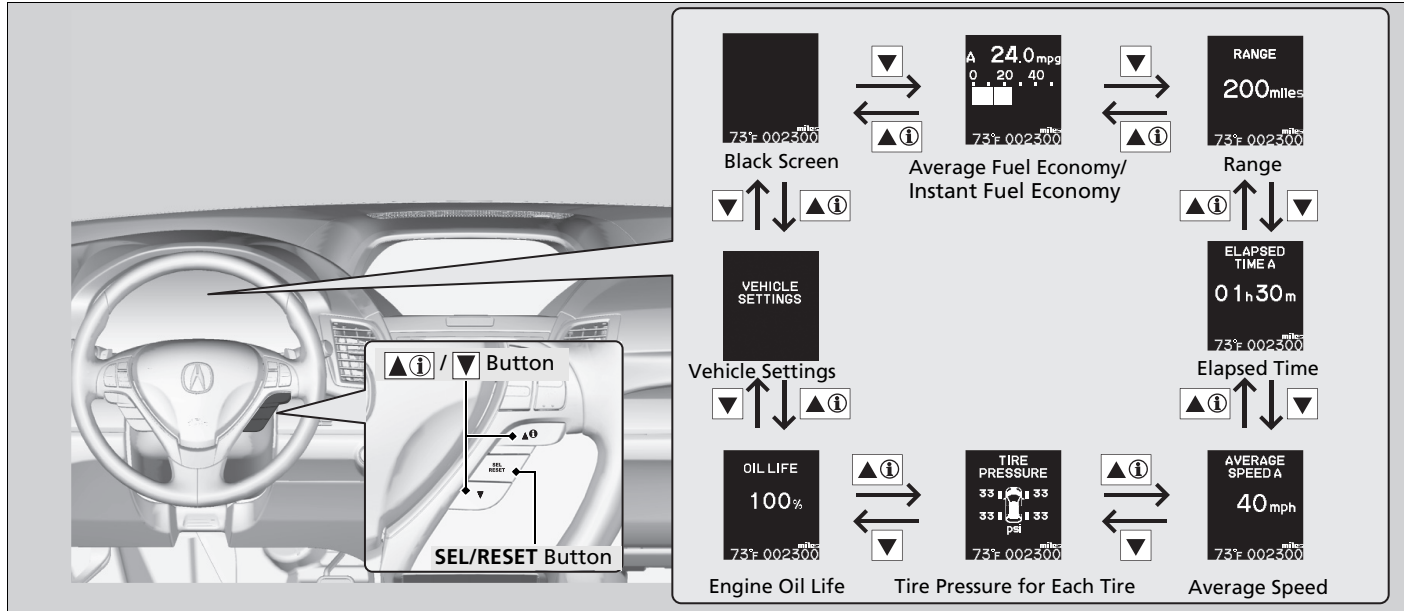

Models with full color display

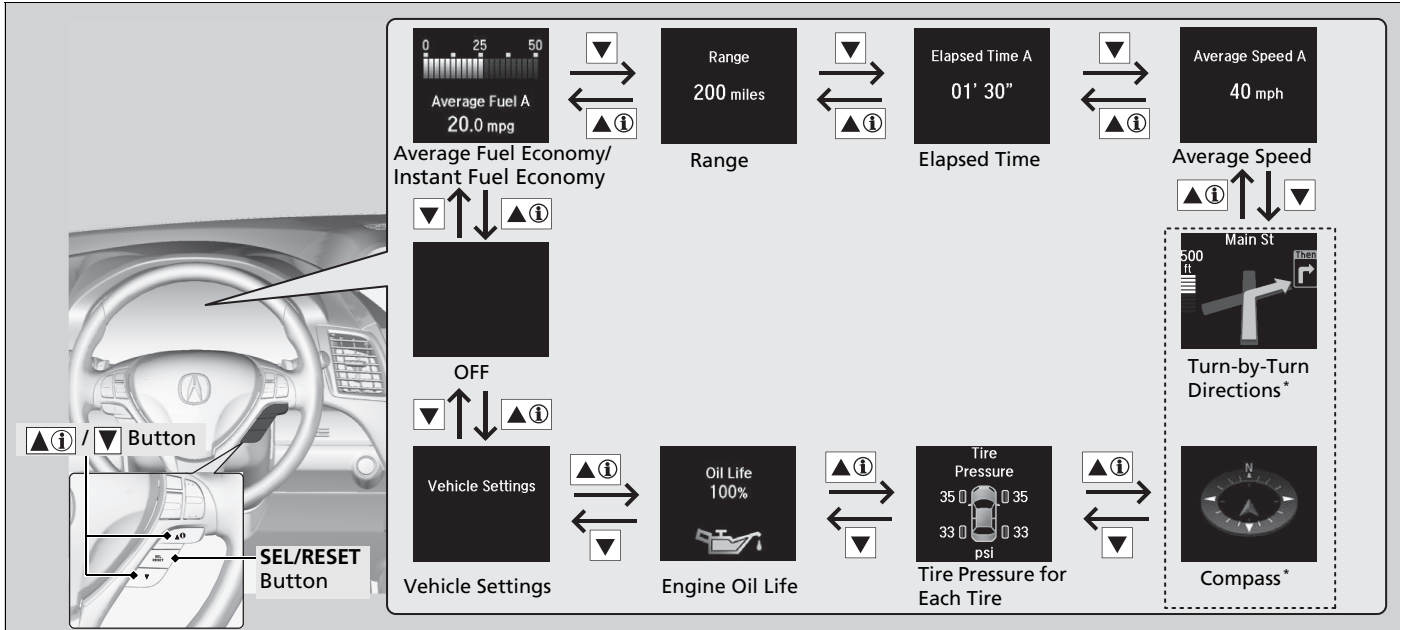

Instrument Panel

* Not available on all models

■ Lower displays

Press the **SEL/RESET** button to change the display.

Models without full color display

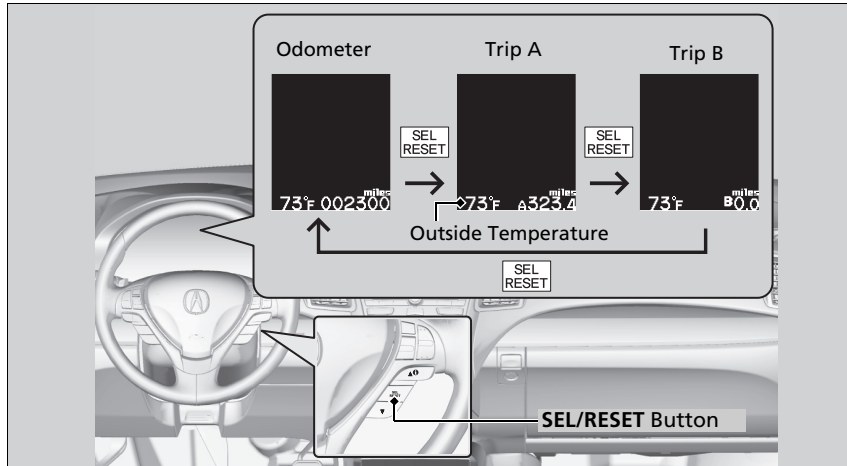

Models with full color display

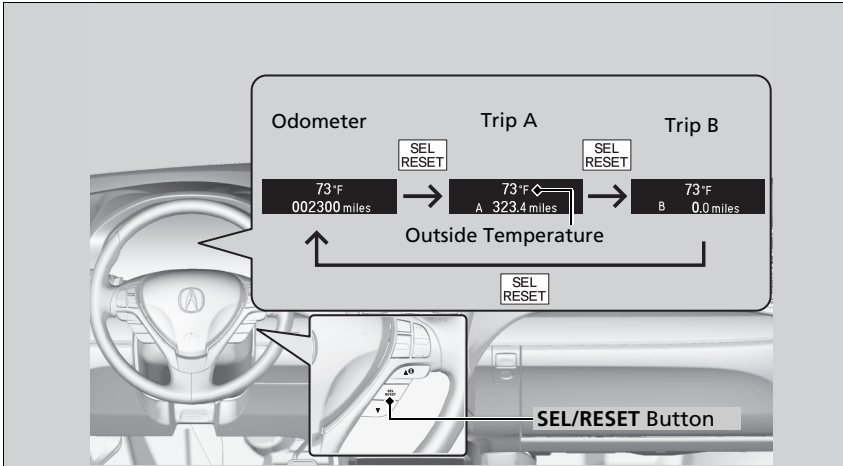

Odometer

Shows the total number of miles (U.S.) or kilometers (Canada) that your vehicle has accumulated.

■ Trip Meter

Shows the total number of miles (U.S.) or kilometers (Canada) driven since the last reset. Meters A and B can be used to measure two separate trips.

■ Resetting a trip meter

To reset a trip meter, display it, then press and hold the **SEL/RESET** button. The trip meter is reset to **0.0**.

■ Outside Temperature

Shows the outside temperature in Fahrenheit (U.S.) or Celsius (Canada).

■ Adjusting the outside temperature display

Adjust the temperature reading up to $\pm 5^{\circ}\text{F}$ or $\pm 3^{\circ}\text{C}$ if the temperature reading seems incorrect.

■ Average Fuel Economy

Shows the estimated average fuel economy of each trip meter in mpg (U.S.) or l/100 km (Canada). The display is updated at set intervals. When a trip meter is reset, the average fuel economy is also reset.

■ Instant Fuel Economy

Shows the instant fuel economy as a bar graph in mpg (U.S.) or l/100 km (Canada).

» Trip Meter

Switch between trip meter A and trip meter B by pressing the **SEL/RESET** button.

» Outside Temperature

The temperature sensor is in the front bumper. Road heat and exhaust from another vehicle can affect the temperature reading when your vehicle speed is less than 19 mph (30 km/h).

It may take several minutes for the display to be updated after the temperature reading has stabilized.

Use the multi-information display's customized features to correct the temperature.

► **Customized Features** P. 102, 108

» Average Fuel Economy

You can change when to reset the average fuel economy.

► **Customized Features** P. 102, 108

■ Range

Shows the estimated distance you can travel on the remaining fuel. This distance is estimated from the fuel economy of your previous trips.

■ Elapsed Time

Shows the time elapsed since Trip A or Trip B was reset.

■ Average Speed

Shows the average speed in mph (U.S.) or km/h (Canada) since Trip A or Trip B was reset.

■ Turn-by-Turn Directions*

Shows you turn-by-turn driving directions to your destination linked with the navigation system.

➤ **Refer to the Navigation System Manual**

■ Tire Pressure Monitor

Shows each tire's pressure.

➤ **Tire Pressure Monitoring System (TPMS)** P. 316

■ Engine Oil Life

Shows the remaining oil life and Maintenance Minder™.

➤ **Maintenance Minder™** P. 349

⌘ Elapsed Time

You can change when to reset the elapsed time.

➤ **Customized Features** P. 102, 108

⌘ Average Speed

You can change when to reset the average speed.

➤ **Customized Features** P. 102, 108

⌘ Turn-by-Turn Directions*

The multi-information display shows a compass when the route guidance is not used.

You can select whether the turn-by-turn display comes on or not during the route guidance.

➤ **Customized Features** P. 108

➤ **Refer to the Navigation System Manual**



* Not available on all models

Models without full color display

Customized Features



Use the multi-information display to customize certain features.

How to customize

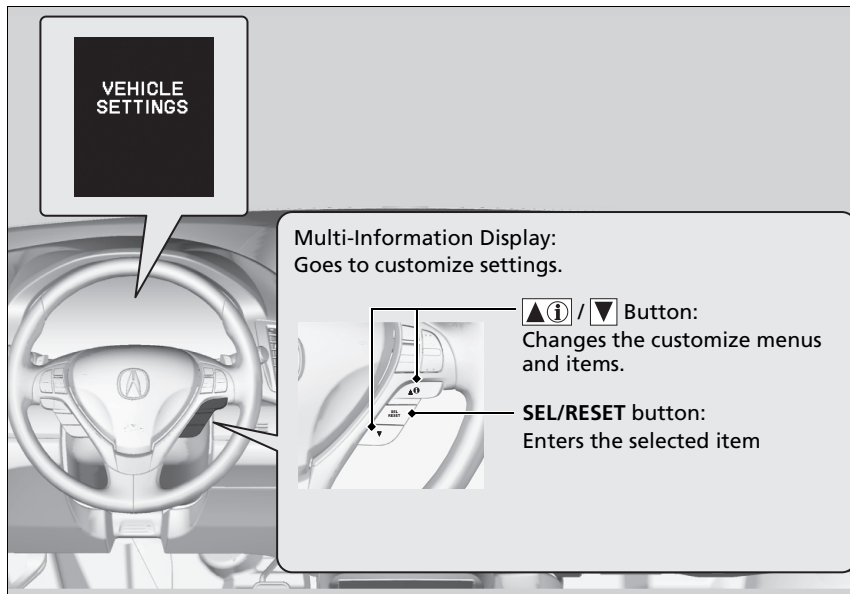
Select the **VEHICLE SETTINGS** screen by pressing the  /  button while the power mode is in ON, and the vehicle is at a complete stop. Press the **SEL/RESET** button.



Customized Features

To customize other features, press the  /  button.

- ▶ **List of customizable options** P. 105
- ▶ **Example of customization settings** P. 116

Customization is possible when you see the driver's ID (**DRIVER 1** or **DRIVER 2**) on the screen. The driver's ID indicates which remote transmitter you have used to unlock the driver's door. The customized settings are recalled every time you unlock the driver's door with that remote.

When you customize settings: Shift to 

■ Customization flow

Press the  /  button.

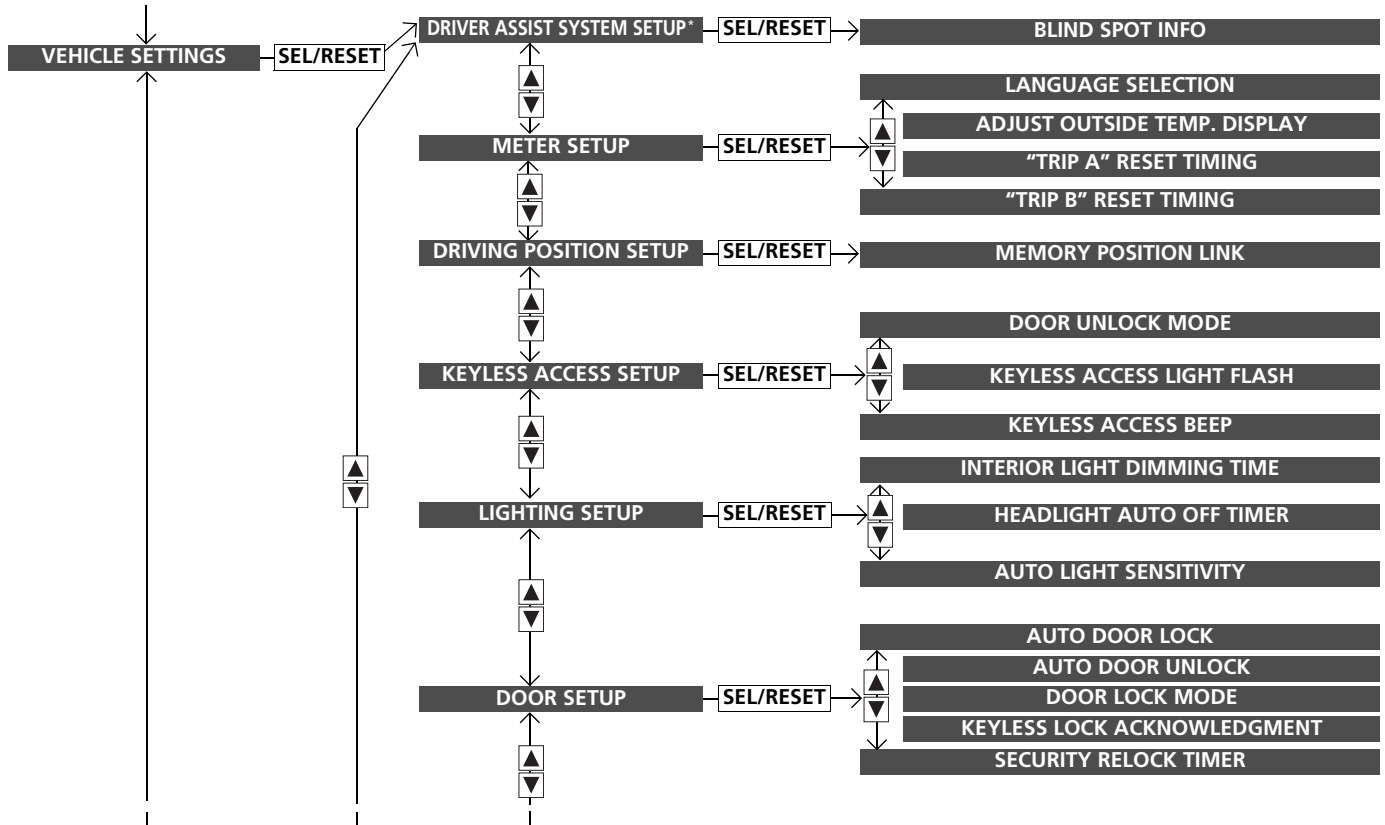

Instrument Panel

* Not available on all models

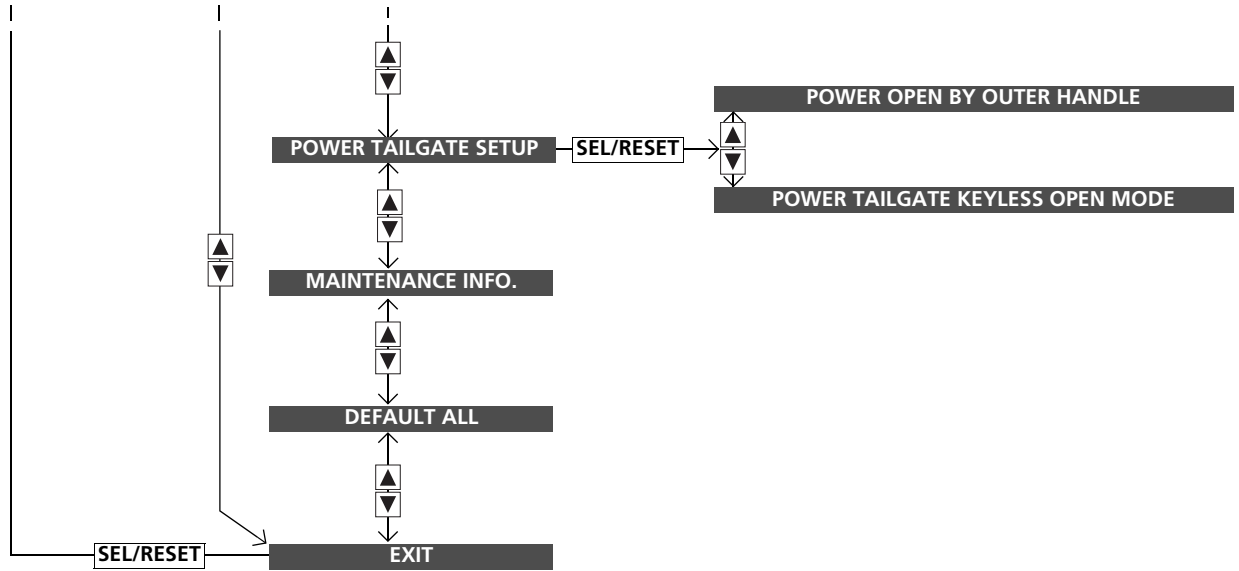

■ List of customizable options

Setup Group	Customizable Features	Description	Selectable Settings
DRIVER ASSIST SYSTEM SETUP*	BLIND SPOT INFO	Changes the setting for the blind spot information.	AUDIBLE AND VISUAL ALERT*¹/VISUAL ALERT/OFF
	LANGUAGE SELECTION	Changes the displayed language.	ENGLISH*¹/Francais/Español
	ADJUST OUTSIDE TEMP. DISPLAY	Adjusts the temperature reading by a few degrees.	-5°F ~ ±0°F*¹ ~ +5°F (U.S.) -3°C ~ ±0°C*¹ ~ +3°C (Canada)
METER SETUP	"TRIP A" RESET TIMING	Changes the setting of how to reset trip meter A, average fuel economy A, average speed A, and elapsed time A.	WITH REFUEL/IGN OFF/ MANUALLY RESET*¹
	"TRIP B" RESET TIMING	Changes the setting of how to reset trip meter B, average fuel economy B, average speed B, and elapsed time B.	WITH REFUEL/IGN OFF/ MANUALLY RESET*¹
DRIVING POSITION SETUP	MEMORY POSITION LINK	Changes the driver's seat position to a stored setting.	ON*¹/OFF

*1:Default Setting

* Not available on all models

Setup Group	Customizable Features	Description	Selectable Settings
KEYLESS ACCESS SETUP	DOOR UNLOCK MODE	Changes which doors unlock when you grab the driver's door handle and tailgate handle. When you press the tailgate release button, if you chose DRIVER DOOR ONLY , only tailgate is unlatched. If you chose ALL DOORS , tailgate is unlatched and all doors are unlocked.	DRIVER DOOR ONLY*¹/ALL DOORS
	KEYLESS ACCESS LIGHT FLASH	Causes some exterior lights to blink when you unlock/lock the doors.	ON*¹/OFF
	KEYLESS ACCESS BEEP	Sets the beeper sound or not when you grab the either front door handle.	ON*¹/OFF
LIGHTING SETUP	INTERIOR LIGHT DIMMING TIME	Changes the length of time the interior lights stay on after you close the doors.	60 sec/30 sec*¹/15 sec
	HEADLIGHT AUTO OFF TIMER	Changes the length of time the exterior lights stay on after you close the driver's door.	60 sec/30 sec/15 sec*¹/0 sec
	AUTO LIGHT SENSITIVITY	Changes the timing for the headlights to come on.	MAX/HIGH/MID*¹/LOW/MIN

*1: Default Setting

Setup Group	Customizable Features	Description	Selectable Settings
DOOR SETUP	AUTO DOOR LOCK	Changes the setting for when the doors automatically lock.	WITH VEH SPD^{*1}/SHIFT FROM [P]/OFF
	AUTO DOOR UNLOCK	Changes the setting for when the doors automatically unlock.	WHEN DRIVER'S DOOR OPENS^{*1}/WHEN SHIFTING INTO PARK/WHEN IGNITION SWITCHED OFF/OFF
	DOOR LOCK MODE	Sets up either the driver's door or all doors to unlock on the first push of the remote.	DRIVER DOOR^{*1}/ALL DOORS
	KEYLESS LOCK ACKNOWLEDGMENT	LOCK/UNLOCK- The exterior lights flash. LOCK (2nd push)- The beeper sounds.	ON^{*1}/OFF
	SECURITY RELOCK TIMER	Changes the time it takes for the doors to relock and the security system to set after you unlock the vehicle without opening any door.	90 sec/60 sec/30 sec^{*1}
POWER TAILGATE SETUP	POWER OPEN BY OUTER HANDLE	Changes the setting to open power tailgate by tailgate outer handle.	ON (POWER/MANUAL)^{*1}/OFF (MANUAL ONLY)
	POWER TAILGATE KEYLESS OPEN MODE	Changes the keyless setting for when the power tailgate opens.	ANYTIME^{*1}/WHEN UNLOCKED
MAINTENANCE INFO.		Resets/ Cancels the engine oil life display when you have performed the maintenance service.	RESET/CANCEL
DEFAULT ALL		Cancels/Resets all the customized settings as default.	CANCEL/SET



*1: Default Setting

Models with full color display

Customized Features



Use the multi-information display to customize certain features.

How to customize

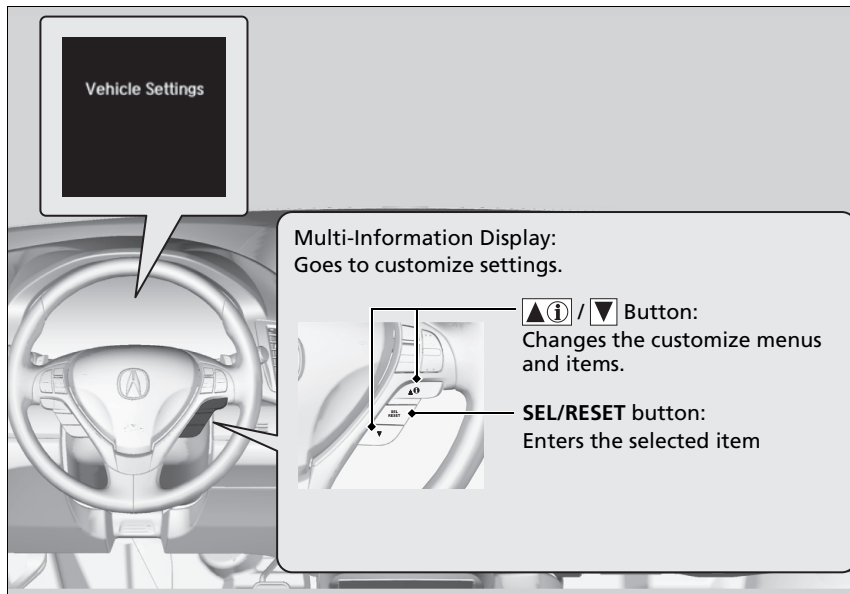
Select the **Vehicle Settings** screen by pressing the  /  button while the power mode is in ON, and the vehicle is at a complete stop. Press the **SEL/RESET** button.



Customized Features

To customize other features, press the  /  button.

- ▶ **List of customizable options** P. 111
- ▶ **Example of customization settings** P. 116

Customization is possible when you see the driver's ID (**DRIVER 1** or **DRIVER 2**) on the screen. The driver's ID indicates which remote transmitter you have used to unlock the driver's door. The customized settings are recalled every time you unlock the driver's door with that remote.

When you customize settings: Shift to .

■ Customization flow

Press the / button.

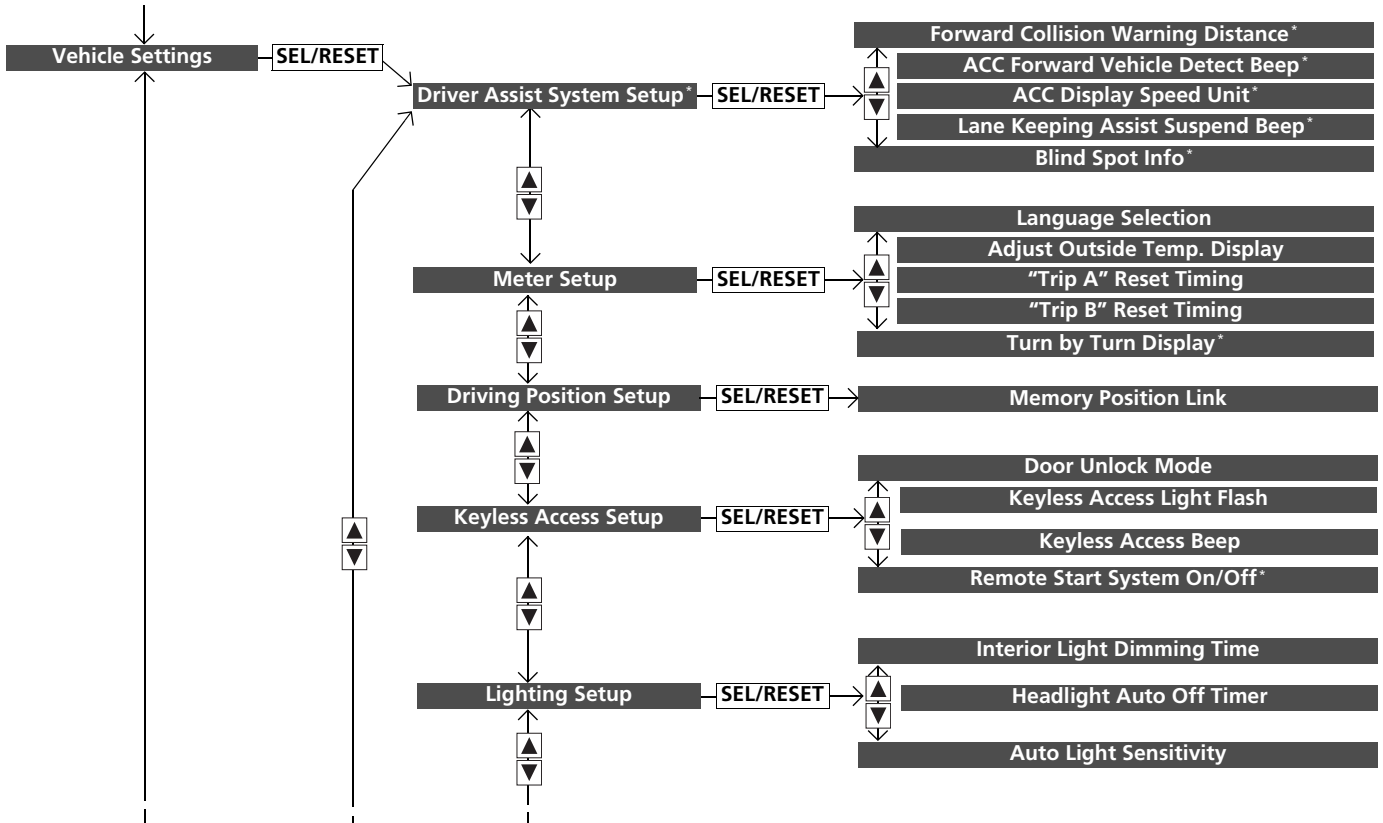

Instrument Panel

* Not available on all models

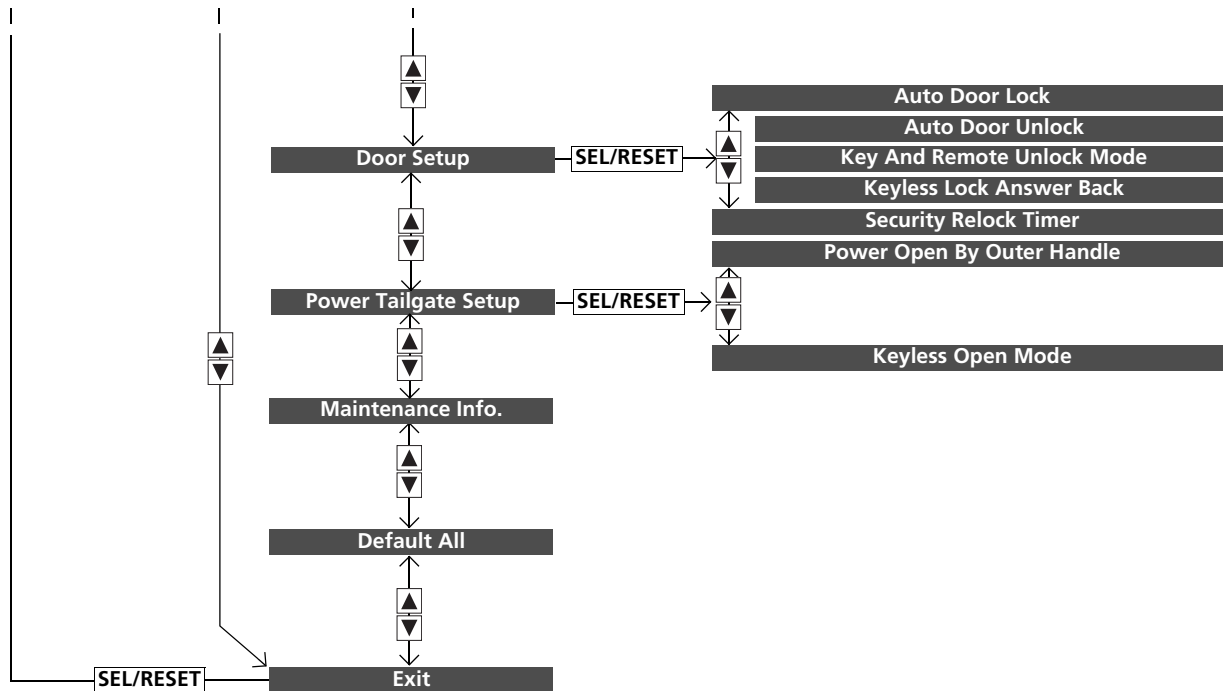

■ List of customizable options

Setup Group	Customizable Features	Description	Selectable Settings
Driver Assist System Setup*	Forward Collision Warning Distance*	Changes at which distance CMBS™ alerts.	Long/Normal*¹/Short
	ACC Forward Vehicle Detect Beep*	Causes the system to beep when the system detects a vehicle, or when the vehicle goes out of the ACC range.	On/Off*¹
	ACC Display Speed Unit*	Changes the speed unit for ACC on the multi-information display.	mph*¹/km/h (U.S.) mph/km/h*¹ (Canada)
	Lane Keeping Assist Suspend Beep*	Causes the system to beep when the LKAS is suspended.	On/Off*¹
	Blind Spot Info*	Changes the setting for the blind spot information.	Audible And Visual Alert*¹/Visual Alert/Off

*1:Default Setting

* Not available on all models

Setup Group	Customizable Features	Description	Selectable Settings
Meter Setup	Language Selection	Changes the displayed language.	English^{*1}/Français/ Español
	Adjust Outside Temp. Display	Adjusts the temperature reading by a few degrees.	-5°F ~ ±0°F^{*1} ~ +5°F (U.S.) -3°C ~ ±0°C^{*1} ~ +3°C (Canada)
	"Trip A" Reset Timing	Changes the setting of how to reset trip meter A, average fuel economy A, average speed A, and elapsed time A.	When Refueled/IGN Off/ Manually Reset^{*1}
	"Trip B" Reset Timing	Changes the setting of how to reset trip meter B, average fuel economy B, average speed B, and elapsed time B.	When Refueled/IGN Off/ Manually Reset^{*1}
	Turn by Turn Display[*]	Selects whether the turn-by-turn display comes on during the route guidance.	On^{*1}/Off

*1:Default Setting

Setup Group	Customizable Features	Description	Selectable Settings
Driving Position Setup	Memory Position Link	Changes the driver's seat position to a stored setting.	On*¹/Off
	Door Unlock Mode	Changes which doors unlock when you grab the driver's door handle and tailgate handle. When you press the tailgate release button, if you chose Driver Door Only , only tailgate is unlatched. If you chose All Doors , tailgate is unlatched and all doors are unlocked.	Driver Door Only*¹/All Doors
Keyless Access Setup	Keyless Access Light Flash	Causes some exterior lights to flash when you unlock/lock the doors.	On*¹/Off
	Keyless Access Beep	Causes the beeper to sound when you unlock/lock the doors.	On*¹/Off
	Remote Start System On/Off*	Turns the remote engine start feature on and off.	On*¹/Off
	Interior Light Dimming Time	Changes the length of time the interior lights stay on after you close the doors.	60sec/30sec*¹/15sec
Lighting Setup	Headlight Auto Off Timer	Changes the length of time the exterior lights stay on after you close the driver's door.	60sec/30sec/15sec*¹/0sec
	Auto Light Sensitivity	Changes the timing for the headlights to come on.	Max/High/Mid*¹/Low/Min

*1: Default Setting

* Not available on all models

Setup Group	Customizable Features	Description	Selectable Settings
Door Setup	Auto Door Lock	Changes the setting for when the doors automatically lock.	With Vehicle Speed^{*1}/Shift From P/Off
	Auto Door Unlock	Changes the setting for when the doors automatically unlock.	All Doors When Driver's Door Opens^{*1}/All Doors When Shifted To Park/All Doors When Ignition Switched Off/Off
	Key And Remote Unlock Mode	Sets up either the driver's door or all doors to unlock on the first operation of the remote or built-in key.	Driver Door^{*1}/ All Doors
	Keyless Lock Answer Back	LOCK/UNLOCK- The exterior lights flash. LOCK (2nd push)- The beeper sounds.	On^{*1}/Off
	Security Relock Timer	Changes the time it takes for the doors to relock and the security system to set after you unlock the vehicle without opening any door.	90sec/60sec/30sec^{*1}

*1: Default Setting

Setup Group	Customizable Features	Description	Selectable Settings
Power Tailgate Setup	Power Open By Outer Handle	Changes the setting to open power tailgate by tailgate outer handle.	On (Power/Manual)*¹/Off (Manual Only)
	Keyless Open Mode	Changes the keyless setting for when the power tailgate opens.	Anytime*¹/When Unlocked
Maintenance Info.		Resets/Cancel the engine oil life display when you have performed the maintenance service.	Cancel/Reset
Default All		Cancels/Resets all the customized settings as default.	Cancel/Set

*1: Default Setting

All models

■ **Example of customization settings**

The steps for changing the “TRIP A” RESET TIMING/“Trip A” Reset Timing setting to **WITH REFUEL/When Refueled** are shown below. The default setting for “TRIP A” RESET TIMING/“Trip A” Reset Timing is **MANUALLY RESET/Manually Reset**.

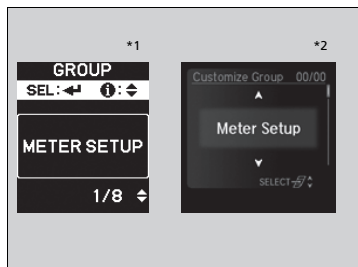
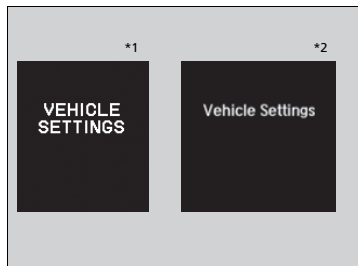

*1 : Models without full color display
 *2 : Models with full color display

1. Press / button to select **VEHICLE SETTINGS/Vehicle Settings**, then press the **SEL/RESET** button.

2. Press the / button until **METER SETUP/Meter Setup** appears on the display.
3. Press the **SEL/RESET** button.
 - ▶ **LANGUAGE SELECTION/Language Selection** appears first in the display.

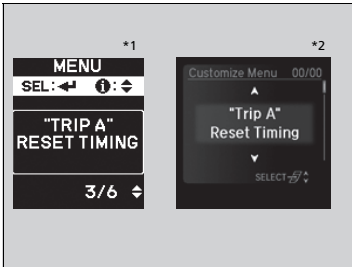

4. Press the / button until **“TRIP A”RESET TIMING** appears on the display, then press the **SEL/RESET** button.

▶ The display switches to the customization setup screen, where you can select **WITH REFUEL/When Refueled**, **IGN OFF/IGN Off**, **MANUALLY RESET/Manually Reset**, or **EXIT/Exit**.



5. Press the / button and select **WITH REFUEL/When Refueled**, then press the **SEL/RESET** button.

▶ The **WITH REFUEL/When Refueled** setup screen appears, then the display returns to the customization menu screen.



6. Press the / button until **EXIT/Exit** appears on the display, then press the **SEL/RESET** button.

7. Repeat Step 6 until you return to the normal screen.

*1: Models without full color display

*2: Models with full color display

Controls

This chapter explains how to operate the various controls necessary for driving.



Setting the Clock	120
Locking and Unlocking the Doors	
Key Types and Functions	121
Low Keyless Access Remote Signal Strength	124
Locking/Unlocking the Doors from the Outside	125
Locking/Unlocking the Doors from the Inside ...	130
Childproof Door Locks	131
Auto Door Locking/Unlocking	132
Opening and Closing the Tailgate ...	133
Security System	
Immobilizer System	139
Security System Alarm.....	139

Opening and Closing the Windows	142
Opening and Closing the Moonroof	145
Operating the Switches Around the Steering Wheel	
ENGINE START/STOP Button.....	146
Turn Signals	149
Light Switches.....	149
Fog Lights*	152
Daytime Running Lights	152
Wipers and Washers	153
Brightness Control	156
Rear Defogger/Heated Door Mirror Button ...	157
Driving Position Memory System	158



Adjusting the Steering Wheel	160
Adjusting the Mirrors	
Interior Rearview Mirror	161
Power Door Mirrors	162
Adjusting the Seats	
Adjusting the Seat Positions.....	164
Interior Lights/Interior Convenience Items	
Interior Lights	171
Interior Convenience Items	173
Climate Control System	
Using Automatic Climate Control	182
Synchronized Mode	184
Automatic Climate Control Sensors.....	185

* Not available on all models





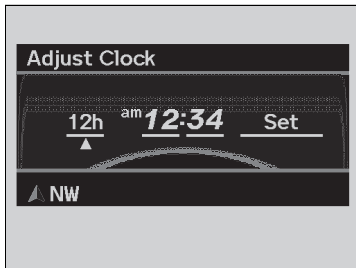

Clock

You can adjust the time in the clock display with the power mode in ON.

■ Using the SETUP button

1. Press the **SETUP** button.
2. Rotate  to select **Adjust Clock**, then press .



3. Rotate  to select the item you want to change (12/24 hour mode, hour, minute). Then press .
4. Rotate  to make the adjustment.
5. Press  to enter your selection. The display returns to **Adjust Clock**. Repeat steps 3 to 5 to adjust other items.
6. To enter the selection, Rotate  and select **Set**, then press .
7. Press the **SETUP** button to go back to the normal display.

⌘ Clock

These indications are used to show how to operate the selector knob.

Rotate  to select.

Press  to enter.

To set the time to the nearest hour:

Press and hold the **CLOCK** button until **Adjust Clock** appears, then press the  (Reset) button.

Depending on the displayed time, the clock sets forward or backward.

Example:

1:06 will reset to 1:00

1:53 will reset to 2:00

Models with navigation system

The clock is automatically updated through the navigation system, so the time does not need to be adjusted.

Key Types and Functions

This vehicle comes with the following keys:

Keys

Models without two-way keyless access remote



Models with two-way keyless access remote



Use the keyless access remote to start and stop the engine, and to lock and unlock all the doors and tailgate. You can also use the keyless access system to lock and unlock the doors and tailgate.

Key Types and Functions

All of the keys have an immobilizer system. The immobilizer system helps to protect against vehicle theft.

Immobilizer System P. 139

The keys contain precision electronics. Adhere to the following advice to prevent damage to the electronics:

- Do not leave the keys in direct sunlight, or in locations with high temperature or high humidity.
- Do not drop the keys or set heavy objects on them.
- Keep the keys away from liquids.
- Do not take the keys apart except for replacing the battery.

If the circuits in the keys are damaged, the engine may not start, and the keyless access system may not work.

If the keys do not work properly, have them inspected by a dealer.

Models with two-way keyless access remote

You can remotely start the engine using the two-way keyless access remote.

Remote Engine Start with Vehicle Feedback* P. 272

* Not available on all models

■ Keyless access remote

Models without two-way keyless access remote

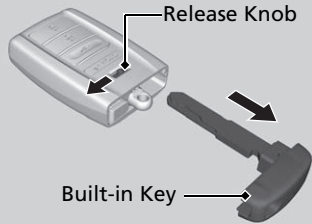

Models with two-way keyless access remote

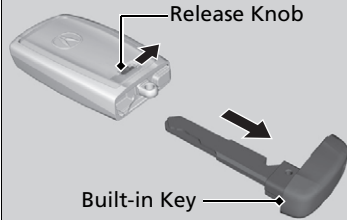

The built-in key can be used to lock/unlock the doors and the tailgate when the keyless access remote battery becomes weak and the power door lock/unlock operation is disabled.

To remove the built-in key, pull it out while pressing the release button. To reinstall the built-in key, push the built-in key into the keyless access remote until it clicks.

■ Key Number Tag

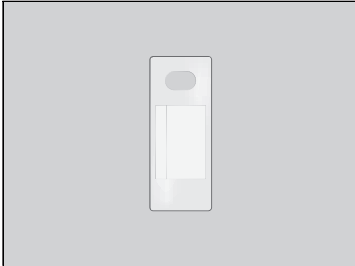

Contains a number that you will need if you purchase a replacement key.

☒ Key Number Tag

Keep the key number tag separate from the key in a safe place outside of your vehicle.
If you wish to purchase an additional key, contact a dealer.

If you lose your key and you cannot start the engine, contact a dealer.

Low Keyless Access Remote Signal Strength

The vehicle transmits radio waves to locate the keyless access remote when locking/unlocking the doors, opening the tailgate, or to start the engine.

In the following cases, locking/unlocking the doors or opening the tailgate or starting the engine may be inhibited or operation may be unstable:

- Strong radio waves are being transmitted by nearby equipment.
- You are carrying the keyless access remote together with telecommunications equipment, laptop computers, cell phones, or wireless devices.
- A metallic object is touching or covering the keyless access remote.

Low Keyless Access Remote Signal Strength

Communication between the keyless access remote and the vehicle consumes the keyless access remote's battery.

The keyless access remote battery lasts about two years. This changes by how often you use the remote. The battery is consumed whenever the keyless access remote is receiving strong radio waves. Avoid placing it near electrical appliances such as televisions and personal computers.

Locking/Unlocking the Doors from the Outside

■ Using the Keyless Access System

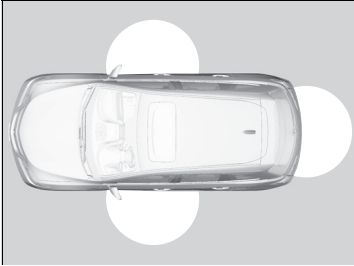

When you carry the keyless access remote, you can lock/unlock the doors and the tailgate.

You can lock/unlock the doors within a radius of about 32 inches (80 cm) of the outside door handle. You can open the tailgate within about 32 inches (80 cm) radius from the tailgate release button.

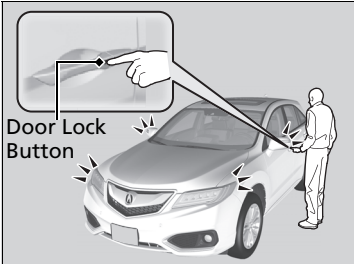

■ Locking the doors and tailgate

Press the door lock button on the front door or the tailgate.

- ▶ Some exterior lights flash; the beeper sounds; all the doors and tailgate lock; and the security system sets.

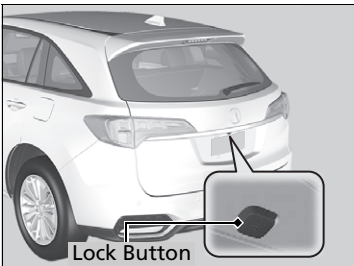

☒ Locking/Unlocking the Doors from the Outside

You can lock or unlock doors using the remote transmitter or keyless access system only when the power mode is in VEHICLE OFF.

☒ Using the Keyless Access System

- The driver must carry the keyless access remote and not leave it in the vehicle when you get out.
- A person who is not carrying the keyless access remote can lock/unlock the doors if a person who is carrying it is within range.
- The door may be unlocked if the door handle is covered with water in heavy rain or in a car wash if the keyless access remote is within range.
- If you grip a front door handle wearing gloves, the door sensor may be slow to respond or may not respond by unlocking the doors.
- The door might not open if you pull it immediately after gripping the door handle. Grip the handle again and confirm that the door is unlocked before pulling the handle.

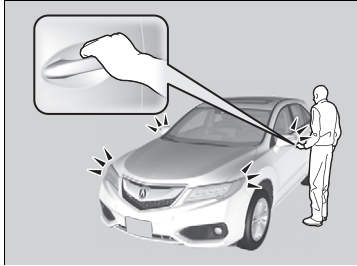

■ Unlocking the doors and tailgate

- Grab the driver's door handle:
- ▶ The driver's door unlocks.
 - ▶ Some exterior lights flash twice and the beeper sounds twice.

- Grab the front passenger's door handle:
- ▶ All the doors unlock.
 - ▶ Some exterior lights flash twice and the beeper sounds twice.

- Press the tailgate release button:
- ▶ The tailgate unlocks and opens.
 - ▶ Some exterior lights flash twice and the beeper sounds twice.

➤ **Using the Tailgate Release Button** P. 134

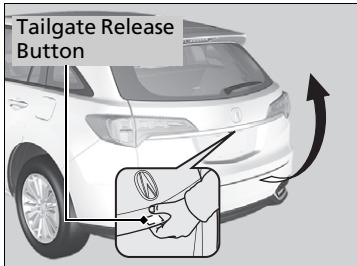

▶▶ Using the Keyless Access System

- Even within the 32 inches (80 cm) radius, you may not be able to lock/unlock the doors with the keyless access remote if it is above or below the outside handle.
- The keyless access remote may not operate if it is too close to the door and door glass.

If you do not open a door within 30 seconds of unlocking the vehicle, the doors will automatically relock.

The light flash, beep and unlock settings can be customized using the multi-information display.

➤ **Customized Features** P. 102, 108

Using the Remote Transmitter

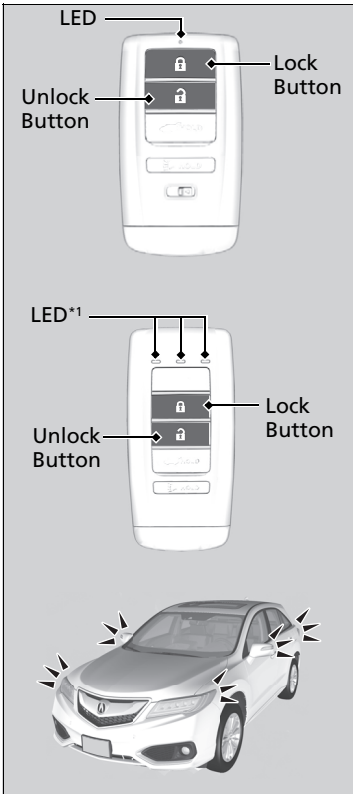

*1: **Checking Door Lock Status*** P. 129

Locking the doors

Press the lock button.

Once:

- ▶ Some exterior lights flash, all the doors and tailgate lock, and the security system sets.

Twice (within five seconds after the first push):

- ▶ A beeper sounds and verifies the security system is set.

Unlocking the doors

Press the unlock button.

Once:

- ▶ Some exterior lights flash twice, and the driver's door unlocks.

Twice:

- ▶ The remaining doors and tailgate unlock.

Using the Remote Transmitter

If you do not open a door within 30 seconds of unlocking the vehicle with the remote transmitter, the doors will automatically relock.

You can change the relock timer setting.

- ▶ **Customized Features** P. 102, 108

If the interior light switch is in the door activated position, the interior lights come on when you press the unlock button.

No doors opened: The lights fade out after 30 seconds.

Doors relocked with the remote: The lights go off immediately.

- ▶ **Interior Lights** P. 171

The remote transmitter uses low-power signals, so the operating range may vary depending on the surroundings.

The remote will not lock the vehicle when a door is open.

If the distance at which it works varies, the battery is probably low.

If the LED does not come on when you press a button, the battery is dead.

- ▶ **Replacing the Button Battery** P. 386

You can customize the door unlock mode setting.

- ▶ **Customized Features** P. 102, 108

■ Locking/Unlocking the Doors Using a Key

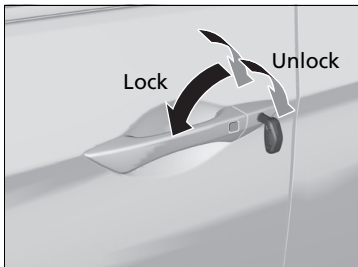

Fully insert the key and turn it.

■ Locking a Door Without Using a Key

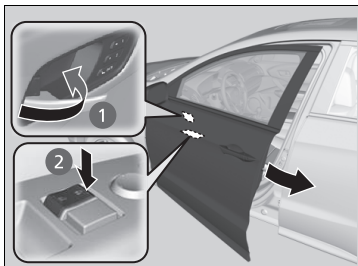

■ Locking the driver's door

Push the lock tab forward **1** or push the master door lock switch in the lock direction **2**, and close the door.

■ Locking the passenger's doors

Push the lock tab forward and close the door.

■ Lockout prevention system

The doors and the tailgate cannot be locked when the keyless access remote is inside the vehicle, and any door or the tailgate is open.

▶▶ Locking/Unlocking the Doors Using a Key

When you lock the driver's door with a key, all of the other doors and tailgate lock at the same time. When unlocking, the driver's door unlocks first. Turn the key a second time within a few seconds to unlock the remaining doors and the tailgate.

You can customize the door unlock mode setting.

▶ **Customized Features** P. 102, 108

▶▶ Locking a Door Without Using a Key

When you lock the driver's door, all the other doors and tailgate lock at the same time. Make sure you have the key with you when locking a door from the outside.

■ Checking Door Lock Status*

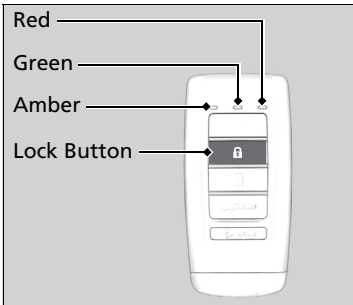

You can remotely check if your vehicle's doors are all locked or any are unlocked using the keyless access remote from extended distances.

Press the lock button, the Amber (left) LED blinks once. Then after three seconds one of the following feedback will come:

- Green (center) comes on: Acknowledges that the doors are locked.
- Red (right) comes on: Acknowledges that doors are not locked, or any door is not completely closed.
- Red (right) blinks three times: The remote does not receive the door lock status from the vehicle.

☒ Checking Door Lock Status*

Operate the remote in an open space. If there are buildings or other obstacles between your vehicle and the remote, the remote may not work even within the operable range. However, the range of unlock, all doors, and panic functions are the same as the standard keyless access remote.

➤ **Using the Remote Transmitter** P. 127

When checking the door lock status, you can also start or stop the engine.

➤ **Remote Engine Start with Vehicle Feedback*** P. 272

* Not available on all models

Locking/Unlocking the Doors from the Inside

Using the Lock Tab

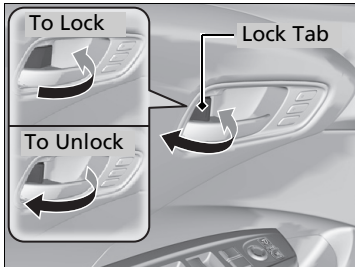

■ **Locking a door**
Push the lock tab forward.

■ **Unlocking a door**
Pull the lock tab rearward.

Unlocking Using the Inner Handle of Front Doors

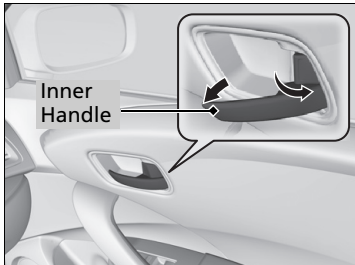

Pull the front door inner handle.
▶ The door unlocks and opens in one motion.

Using the Lock Tab

When you lock the door using the lock tab on the driver's door, all the other doors and tailgate lock at the same time.

When you unlock the door using the lock tab on the driver's door, only the driver's door will unlock.

Unlocking Using the Inner Handle of Front Doors

The front door inner handles are designed to allow front seat occupants to open the door in one motion. However this feature requires that front seat occupants never pull a front door inner handle while the vehicle is in motion.

Children should always ride in a rear seat where childproof door locks are provided.

▶ **Childproof Door Locks** P. 131

■ Using the Master Door Lock Switch

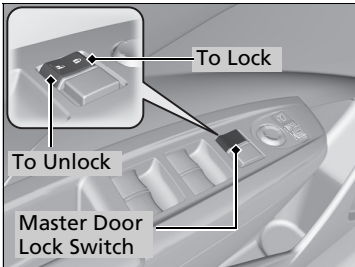

Press the master door lock switch in as shown to lock or unlock all doors and the tailgate.

Childproof Door Locks

The childproof door locks prevent the rear doors from being opened from the inside regardless of the position of the lock tab.

■ Setting the Childproof Door Locks

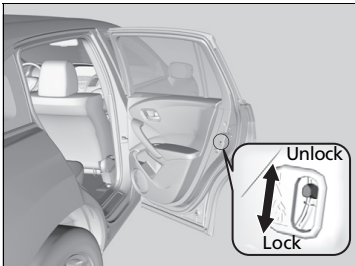

Slide the lever in the rear door to the lock position, and close the door.

■ When opening the door

Open the door using the outside door handle.

☒ Using the Master Door Lock Switch

When you lock/unlock the driver's door using the master door lock switch, all the other doors and the tailgate lock/unlock at the same time.

☒ Childproof Door Locks

To open the door from the inside when the childproof door lock is on, put the lock tab in the unlock position, lower the rear window, put your hand out of the window, and pull the outside door handle.

Auto Door Locking/Unlocking

Your vehicle locks all doors and unlocks all doors or the driver's door automatically when a certain condition is met.

■ Auto Door Locking

■ Drive lock mode

All doors and tailgate lock when the vehicle's speed reaches about 10 mph (15 km/h).

■ Auto Door Unlocking

■ Driver's door open mode

All doors unlock when the driver's door is opened.

▶▶ Auto Door Locking/Unlocking

You can turn off or change to another auto door locking/unlocking setting using the multi-information display.

▶ **Customized Features** P. 102, 108

Precautions for Opening/Closing the Tailgate

Always make sure individuals and objects are clear of the tailgate before opening or closing it.

■ Opening the tailgate

- Open the tailgate all the way.
 - ▶ If it is not fully opened, the tailgate may come down accidentally by its own weight.
- Be careful when it is windy. The wind may cause the tailgate to close.

■ Closing the tailgate

Keep the tailgate closed while driving to:

- ▶ Avoid possible damage.
- ▶ Prevent exhaust gas from leaking into the vehicle.
- ▶ **Carbon Monoxide Gas** P. 64

⚠ Precautions for Opening/Closing the Tailgate

Be careful not to hit your head on the tailgate or to put your hands between the tailgate and the cargo area when closing the gate.

When operating the power tailgate, make sure there is enough space around your vehicle. People near the tailgate may be seriously hurt if the tailgate hits or closes on their heads. Be especially cautious if children are around.

When you are storing or picking up luggage from the cargo area while the engine is idling, do not stand in front of the exhaust pipe. You may get burned.

Do not allow any passenger in the cargo space. They may get hurt during hard braking, a sudden acceleration, or a crash.

Using the Tailgate Release Button

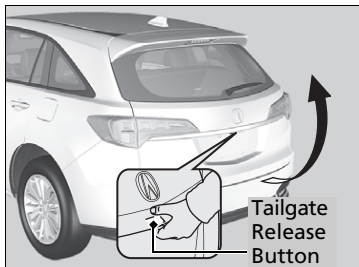

When all the doors are unlocked or press the tailgate unlock button on the remote transmitter, the tailgate is unlocked.

Press the tailgate release button for more than one second, and wait until you hear two beeps before you lift open the tailgate.

▶ Releasing the release button within one second with one beep enables the power tailgate operations.

▶ Opening/Closing the Power Tailgate

P. 135

If you are carrying the keyless access remote, you do not have to unlock the tailgate before opening it.

To manually close the tailgate, grab the inner handle, pull the tailgate down, and push it closed from outside.

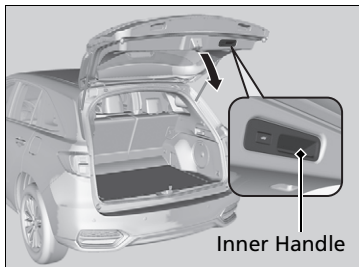

▶▶ Using the Tailgate Release Button

- Do not leave the keyless access remote in the vehicle when you get out. Carry it with you.
- Even if you are not carrying the keyless access remote, you can unlock the tailgate while someone else with the remote is within range.

Opening/Closing the Power Tailgate

The power tailgate can be operated by pressing the power tailgate button on the remote transmitter, pressing the power tailgate switch on the dashboard, or pressing the button on the tailgate.

■ The power tailgate can be opened when:

- The tailgate is fully closed.
- The shift lever is in **P**.

■ The power tailgate can be closed when:

- The tailgate is fully open.
- The shift lever is in **P**.

ⓘ Opening/Closing the Power Tailgate

⚠ WARNING

Closing a power tailgate while anyone is in the path of the tailgate can cause serious injury.

Make sure everyone is clear before closing the power tailgate.

NOTICE

Do not push or pull on the power tailgate when it is being automatically opened or closed. Forcibly opening or closing the power tailgate while in operation can deform the tailgate frame.

When operating the power tailgate, make sure there is enough space around your vehicle. People near the tailgate may be seriously hurt if the tailgate hits or closes on their heads. Be especially cautious if children are around.

The power tailgate may not open or close under the following conditions:

- You start the engine while the tailgate is automatically opening or closing.
- The vehicle is parked on a steep hill.
- The vehicle is swayed in a strong wind.
- The tailgate or the roof is covered with snow or ice.

If you close the power tailgate when all the doors are locked, the power tailgate locks automatically.

Remote Transmitter

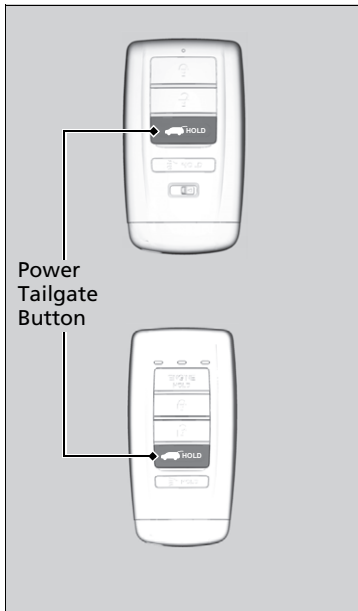

Press the power tailgate button for more than one second to operate.

To reverse direction while the power tailgate is in operation, press the button again. The beeper sounds three times and the tailgate reverses direction.

Customizing when to open the tailgate

ANYTIME/Anytime: The power tailgate unlocks and opens at the same time. This is the default setting.

WHEN UNLOCKED/When Unlocked: The tailgate opens when all doors are unlocked.

► Customized Features P. 102, 108

Opening/Closing the Power Tailgate

If you replace the battery or the power tailgate fuse while the tailgate is open, the power tailgate may be disabled. The power tailgate resumes once you manually close the tailgate.

Installing aftermarket components other than Acura genuine accessories on the power tailgate may prevent it from fully opening or closing.

Make sure the power tailgate is fully open before you get your luggage in and out.

Make sure the power tailgate is fully closed before you start the vehicle.

The beeper sounds when you start driving while the power tailgate is still open, or closing.

If the power tailgate meets resistance while opening or closing, the auto reverse feature reverses the direction. The beeper sounds three times.

The auto reverse function stops sensing when the tailgate is almost closed to make sure that it fully closes.

Do not touch the sensors located on both sides of the tailgate. The power tailgate does not close if you touch either sensor when you are trying to close the tailgate.

Be careful not to scratch the sensors with a sharp object. If scratched, they can be damaged, and the power tailgate closing feature malfunctions.

■ Power Tailgate Button

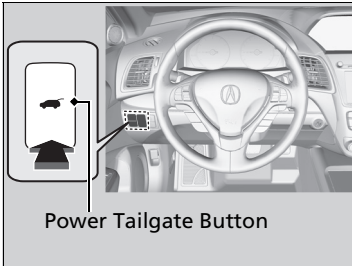

To open or close the power tailgate, press the power tailgate button on the dashboard for about one second. The beeper sounds and some exterior lights flash.

To reverse direction while the power tailgate is in operation, press the button again. The beeper sounds three times and the tailgate reverses direction.

■ Power Tailgate Close Button

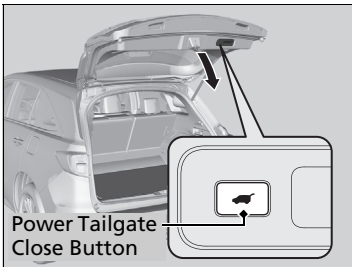

Press the button on the tailgate to close the power tailgate. If you press the button again while the power tailgate is closing, it stops and reverses direction.

■ Auto-Closer

If you manually close the power tailgate, it latches automatically.

☒ Power Tailgate Close Button

If you push the power tailgate close button while the tailgate is automatically opening or closing, the power tailgate operation stops. Use caution if the tailgate stops in the middle of either operation. It may suddenly swing up or down.

☒ Auto-Closer

The auto-closer feature does not activate if you push the tailgate release button while the power tailgate is closing.

Do not put any force on the tailgate while the power tailgate is latching.

Keep your hands away from the tailgate when you manually close the tailgate and let it latch automatically. It is dangerous to put your hands around the tailgate as it starts to latch itself.

■ Power Tailgate Fail-safe Mode

The power tailgate fail-safe mode detects if there is an extra load on the tailgate (for example, it is covered with snow). If an extra load is detected, the tailgate opens completely then lowers to the close position.

⌘ Power Tailgate Fail-safe Mode

If you try to manually close the power tailgate immediately after it fully opens, the power tailgate fail-safe mode may activate.

Once the power tailgate fail-safe mode activates, wait until the power tailgate fully closes. Keep away from the power tailgate when it is in motion.

If the power tailgate fail-safe mode constantly activates, consult at a dealer.

Immobilizer System

The immobilizer system prevents a key that has not been pre-registered from starting the engine. Each key contains electronic transmitters that use electronic signals to verify the key.

Pay attention to the following when selecting the ACCESSORY mode with the **ENGINE START/STOP** button:

- Do not allow objects that emit strong radio waves near the **ENGINE START/STOP** button.
- Make sure the key is not covered by or touching a metal object.
- Do not bring a key from another vehicle's immobilizer system with the keyless access remote.

Security System Alarm

The security system alarm activates when the doors, tailgate, or hood are opened without the key, remote transmitter or keyless access system.

However, the alarm goes off when a door is opened with the key, then the shift lever is moved out of **[P]** or the hood is opened before the power mode is set to ON.

■ When the security system alarm activates

The horn sounds intermittently, and all of the exterior lights flash.

■ To deactivate the security system alarm

Unlock the vehicle using the remote transmitter, or keyless access system. The system, along with the horn and flashing lights, is deactivated.

☒ Immobilizer System

NOTICE

Leaving the keyless access remote in the vehicle can result in theft or accidental movement of the vehicle. Always take the key with you whenever you leave the vehicle unattended.

Do not alter the system or add other devices to it. Doing so may damage the system and make your vehicle inoperable.

☒ Security System Alarm

The security alarm continues for a maximum of two minutes until the security system alarm deactivates.

■ Setting the security system alarm

The security system alarm automatically sets when the following conditions have been met:

- The power mode is in VEHICLE OFF (LOCK).
- The hood is closed.
- All doors and the tailgate are locked from outside with the key, remote transmitter, or keyless access system.

■ When the security system alarm sets

The security system alarm indicator in the instrument panel blinks. When the blinking interval changes after about 15 seconds, the security system alarm is set.

■ To cancel the security system alarm

The security system alarm is canceled when the vehicle is unlocked using the remote transmitter, keyless access system, or the power mode is set to ON. The security system alarm indicator goes off at the same time.

ⓘ Security System Alarm

Do not set the security system alarm when someone is in the vehicle or a window is open. The system can accidentally activate when:

- Unlocking the door with the lock tab.
- Moving the shift lever out of **P**.

If the battery goes dead after you have set the security system alarm, the security alarm may go off once the battery is recharged or replaced.

If this occurs, deactivate the security system alarm by unlocking a door using the remote transmitter, or keyless access system.

Do not attempt to alter this system or add another device to it.

Panic Mode

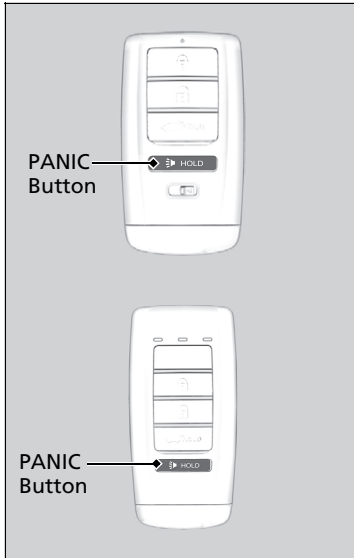

■ The panic button on the remote transmitter

If you press the PANIC button for approximately one second, the following will occur for about 30 seconds:

- The horn sounds.
- Some exterior lights flash.

■ Canceling panic mode

Press any button on the remote transmitter, or set the power mode to ON.

Opening/Closing the Power Windows

The power windows can be opened and closed when the power mode is in ON, using the switches on the doors. The driver side switches can be used to open and close all of the windows.

The power window lock button on the driver side must be switched off (not pushed in, indicator off) to open and close the windows from anywhere other than the driver's seat.

When the power window lock button is pushed in, the indicator comes on and you can only operate the driver's window. Turn the power window lock button on when children are in the vehicle.

Opening/Closing the Power Windows

WARNING

Closing a power window on someone's hands or fingers can cause serious injury.

Make sure your passengers are away from the windows before closing them.

The power windows can be operated for up to 10 minutes after you set the power mode to VEHICLE OFF.

Opening either front door cancels this function.

Auto Reverse

If a power window senses resistance when closing automatically, it will stop closing and reverse direction.

The driver's window auto reverse function is disabled when you continuously pull up the switch.

The auto reverse function stops sensing when the window is almost closed to ensure that it fully closes.

Opening/Closing Windows with Auto-Open/Close Function

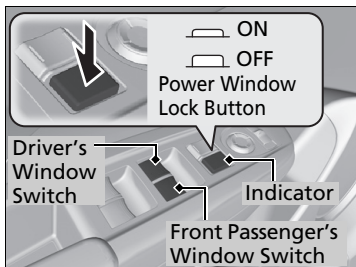

Automatic operation

To open: Push the switch down firmly.

To close: Pull the switch up firmly.

The window opens or closes completely. To stop the window at any time, push or pull the switch briefly.

Manual operation

To open: Push the switch down lightly, and hold it until the desired position is reached.

To close: Pull the switch up lightly, and hold it until the desired position is reached.

■ Opening/Closing Windows without Auto-Open/Close Function

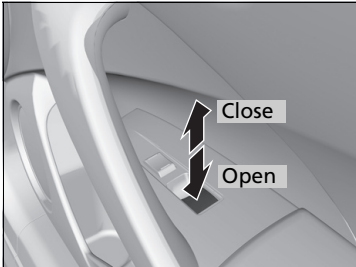

To open: Push the switch down.

To close: Pull the switch up.

Release the switch when the window reaches the desired position.

■ Opening the Windows and Moonroof with the Remote

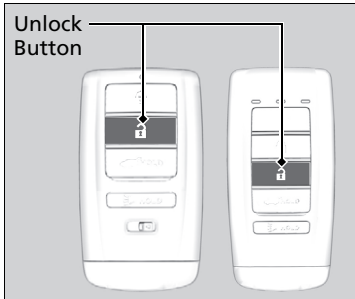

To open: Press the unlock button twice within 10 seconds and hold it down for the second time. If the windows stop midway, repeat the procedure.

■ Opening/Closing the Windows and Moonroof with the Key

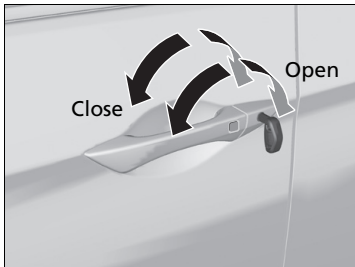

To open: Unlock the driver's door with the key. Within 10 seconds of returning the key to the central position, turn the key in the unlock direction and hold it there.

To close: Lock the driver's door with the key. Within 10 seconds of returning the key to the central position, turn the key in the lock direction and hold it there.

Release the key to stop the windows/moonroof at the desired position. If you want further adjustment, repeat the same operation.

Opening/Closing the Moonroof

You can only operate the moonroof when the power mode is in ON. Use the switch in the front of the ceiling to open and close the moonroof.

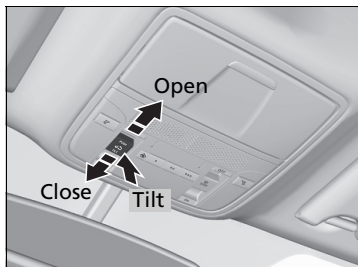

Automatic operation

To open: Pull the switch back firmly.

To close: Push the switch forward firmly.

The moonroof will automatically open or close all the way. To stop the moonroof midway, touch the switch briefly.

Manual operation

To open: Pull the switch back lightly, and hold it until the desired position is reached.

To close: Push the switch forward lightly, and hold it until the desired position is reached.

Tilting the moonroof up

To tilt: Push on the center of the moonroof switch.

To close: Push the switch forward firmly, then release.

Opening/Closing the Moonroof

⚠ WARNING

Opening or closing the moonroof on someone's hands or fingers can cause serious injury.

Make sure all hands and fingers are clear of the moonroof before opening or closing it.

NOTICE

Opening the moonroof in below freezing temperature or when it is covered with snow or ice can damage the moonroof panel or motor.

The power moonroof can be operated for up to 10 minutes after you set the power mode to VEHICLE OFF.

Opening either front door cancels this function.

When resistance is detected, the auto reverse function causes the moonroof to change directions, then stop. Auto reverse stops sensing when the moonroof is almost closed to ensure that it fully closes. Make sure that all objects, including fingers, are clear of the moonroof.

ENGINE START/STOP Button

Changing the Power Mode

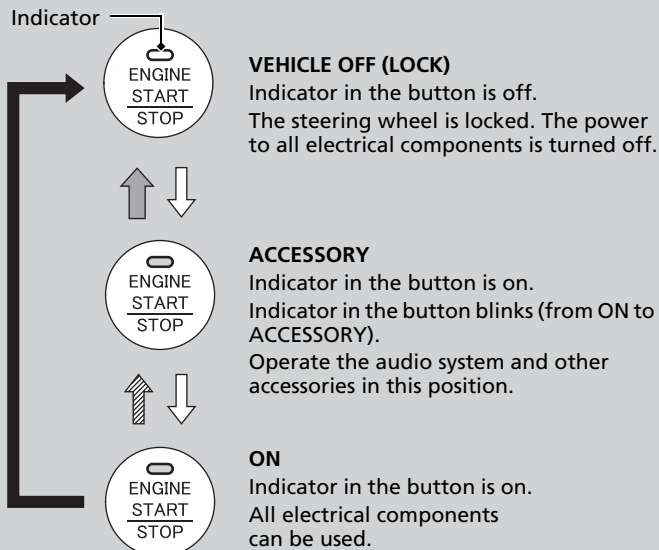

Without pressing the brake pedal

- : Press the **ENGINE START/STOP** button to change the mode.
- : Press the button without the shift lever in **P**.
- : Shift to Park, then press the button.
- U.S. models**
: Shift to **P**.

ENGINE START/STOP Button

ENGINE START/STOP Button Operating Range

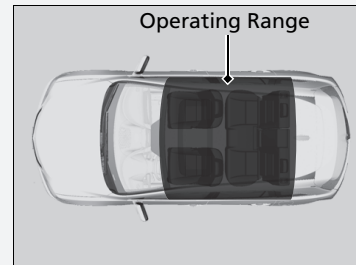

You can start the engine when the keyless access remote is inside the vehicle.
The engine may also run if the keyless access remote is close to the door or window, even if it is outside the vehicle.

ON mode:
Indicator in the button is off, if the engine is running.

If the keyless access remote battery is weak, beeper sounds and the **TO START, HOLD REMOTE NEAR START BUTTON/To Start, Hold Remote Near Start Button** message appears on the multi-information display.

If the Keyless Access Remote Battery is Weak P. 415

■ Power Mode Reminder

If you open the driver's door when the power mode is set to ACCESSORY, a warning buzzer sounds.

⊠ ENGINE START/STOP Button

If the power mode does not change from VEHICLE OFF to ACCESSORY, press the **ENGINE START/STOP** button while moving the steering wheel left and right. The steering wheel will unlock, allowing the mode to change.

■ Keyless Access Remote Reminder

Models with full color display

Keyless Remote
Not Detected



Models without full color display

KEYLESS
REMOTE NOT
DETECTED



Warning buzzers may sound from inside or/ and outside the vehicle to remind you that the keyless access remote is out of the vehicle. If the buzzer continues even after the remote is put back inside, place it within its operational range.

■ When the power mode is in ON

If the keyless access remote is taken out of the vehicle, and the driver's door is closed, warning buzzers sound from both inside and outside the vehicle. A warning message on the multi-information display notifies the driver inside that the remote is out.

■ When the power mode is in ACCESSORY or in VEHICLE OFF (LOCK)

If the keyless access remote is taken out of the vehicle, and the driver's door is closed, a warning buzzer sounds from outside the vehicle.

▶▶ Keyless Access Remote Reminder

When the keyless access remote is within the system's operational range, and the driver's door is closed, the warning function cancels.

If the keyless access remote is taken out of the vehicle after the engine has been started, you can no longer change the **ENGINE START/STOP** button mode or restart the engine. Always make sure if the remote is in your vehicle when you operate the **ENGINE START/STOP** button.

Removing the keyless access remote from the vehicle through a window does not activate the warning buzzer.

Do not put a keyless access remote on the dashboard or in the glove box. It may cause the warning buzzer to go off. Under some other conditions that can prevent the vehicle from locating the remote, the warning buzzer may also go off even if the remote is within the system's operational range.

Turn Signals

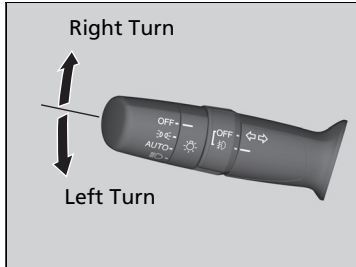

The turn signals can be used when the power mode is in ON.

■ One-touch turn signal

When you lightly push up or down and release the turn signal lever, the exterior turn signals and turn signal indicator blink three times.

This feature can be used when signaling for a lane change.

Light Switches

■ Manual Operation

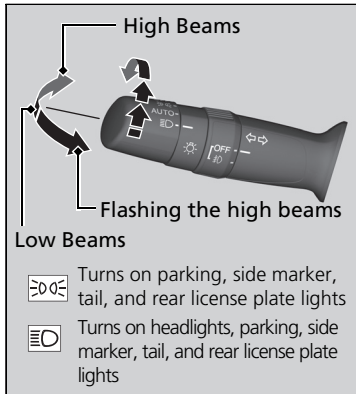

Rotating the light switch turns the lights on and off, regardless of the power mode setting.

■ High beams

Push the lever forward until you hear a click.

■ Low beams

When in high beams, pull the lever back to return to low beams.

■ Flashing the high beams

Pull the lever back, and release it.

☞ Light Switches

If you leave the power mode in VEHICLE OFF (LOCK) while the lights are on, a chime sounds when the driver's door is opened.

Do not leave the lights on when the engine is off because it will cause the battery to discharge.

■ Automatic Lighting Control

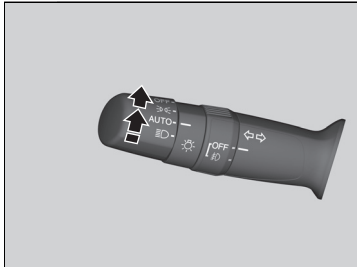

Automatic lighting control can be used when the power mode is in ON.

When you turn the light switch to **AUTO**, the headlights and other exterior lights will switch on and off automatically depending on the ambient brightness.

- ▶ You can change the auto light sensitivity setting.
- ▶ **Customized Features** P. 102, 108

▶▶ Automatic Lighting Control

We recommend that you turn on the lights manually when driving at night, in a dense fog, or in dark areas such as long tunnels or parking facilities.

The light sensor is in the location shown below. Do not cover this light sensor with anything; otherwise, the automatic lighting system may not work properly.

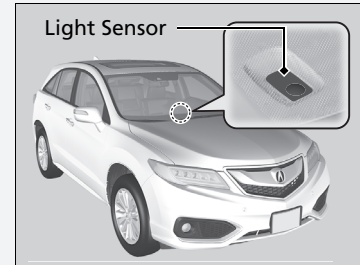

Adjust the auto light sensitivity as follows:

Setting	The exterior lights come on when the ambient light is at
MAX	
HIGH	
MID	
LOW	
MIN	

■ Headlight Integration with Wiper*

The headlights automatically come on when the wipers are used several times within certain number of intervals while the headlight switch is in **AUTO**. The headlights automatically go off a few minutes after the wipers are stopped.

■ Automatic Lighting Off Feature

The headlights, all other exterior lights, and the instrument panel lights turn off 15 seconds after you set the power mode to VEHICLE OFF (LOCK), take the remote with you, and close the driver's door.

If you set the power mode to VEHICLE OFF (LOCK) with the headlight switch on, but do not open the door, the lights turn off after 10 minutes (three minutes, if the switch is in the **AUTO** position).

The lights turn on again when you unlock or open the driver's door. If you unlock the door, but do not open it within 15 seconds, the lights go off. If you open the driver's door, you will hear a lights on reminder chime.

* Not available on all models

▣ Headlight Integration with Wiper*

This feature activates while the headlights are in **AUTO**. The instrument panel brightness does not change when the headlights come on.

If the ambient light is dark, the automatic lighting control overrides this feature, and the headlights come on whether or not the wipers cycle several times.

▣ Automatic Lighting Off Feature

You can change the headlight auto off timer setting.

▣ **Customized Features** P. 102, 108

Fog Lights*

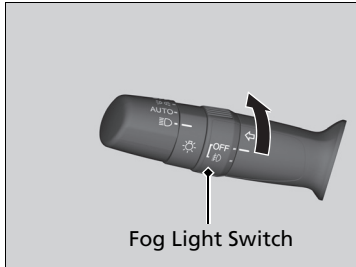

When the low beam headlights are on, turn the fog light switch on to use the fog lights.

▶▶ Fog Lights*

The fog lights go off when the headlights turn off, or when the daytime running lights are on.

Daytime Running Lights

The position/daytime running lights comes on when the following conditions have been met:

- The power mode is in ON.
- The headlight switch is off, **AUTO**, or in .
- The parking brake is released.

The lights remain on even if you set the parking brake. Setting the power mode to VEHICLE OFF (LOCK) will turn off the daytime running lights.

The daytime running lights are off the headlight switch is turned on, or when the headlight switch is in **AUTO** and it is getting darker outside.

Wipers and Washers

■ Front Wiper/Washer

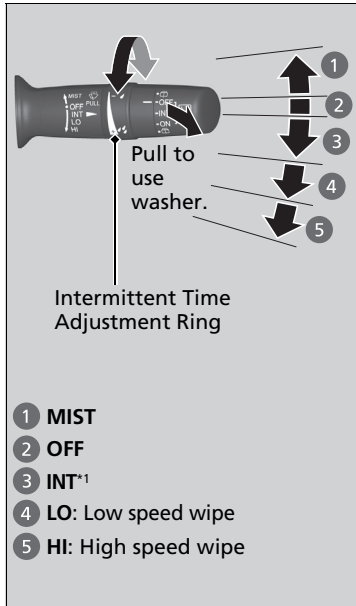

- 1 MIST
- 2 OFF
- 3 INT*1
- 4 LO: Low speed wipe
- 5 HI: High speed wipe

The windshield wipers and washers can be used when the power mode is in ON.

■ MIST

The wipers run at high speed until you release the lever.

■ Wiper switch (OFF, INT*1, LO, HI)

Move the lever up or down to change the wiper settings.

■ Adjusting wiper operation

Turn the adjustment ring to adjust wiper operation.

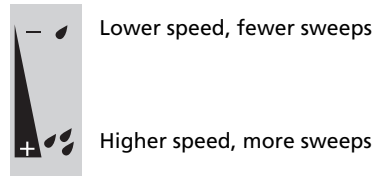

■ Washer

Sprays while you pull the lever toward you. When you release the lever for more than one second, the spray stops, the wipers sweep two or three more times to clear the windshield, then stop.

*1: Models with manual intermittent operation

» Wipers and Washers

NOTICE

Do not use the wipers when the windshield is dry. The windshield will get scratched, or the rubber blades will get damaged.

NOTICE

In cold weather, the blades may freeze to the windshield, becoming stuck. Operating the wipers in this condition may damage the wipers. Use the defroster to warm the windshield, then turn the wipers on.

If the vehicle speeds up while the wipers are operating intermittently, the length of the wipe interval shortens.

When the vehicle starts moving, the wipers make a single sweep. When the vehicle speeds up, the wiper operation's shortest delay setting (🔊) and the LO setting become the same.

Turn the washers off if no washer fluid comes out. The pump may get damaged.

The wiper motor is equipped with a breaker that may stop motor operation temporarily to prevent an overload. Wiper operation will return to normal within a few minutes, once the circuit has returned to normal.

■ Automatic Intermittent Wipers*

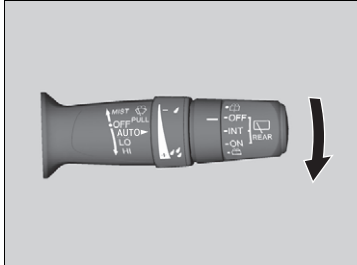

When you push the lever down to **AUTO**, the windshield wipers sweep once, and go into the automatic mode.

The wipers operate intermittently, at low speed, or at high speed and stop in accordance with the amount of rainfall the rainfall sensor detects.

■ Auto sensitivity adjustment

When the wiper function is set to **AUTO**, you can adjust the sensitivity of the rain fall sensor (using the adjustment ring) so that wipers will operate in accordance with your preference.

Sensor sensitivity



Low sensitivity:
Lower speed, fewer sweeps

High sensitivity:
Higher speed, more sweeps

▶▶ Wipers and Washers

If the wiper stops operating due to any obstacle such as the build-up of snow, park the vehicle in a safe place.

Rotate the wiper switch to **OFF**, and set the power mode to ACCESSORY or VEHICLE OFF (LOCK), then remove the obstacle.

▶▶ Automatic Intermittent Wipers*

The rainfall sensor is in the location shown below.

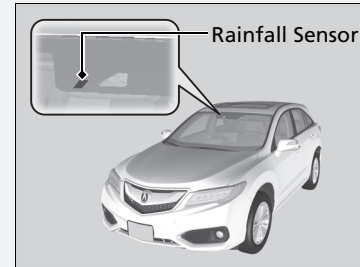

NOTICE

AUTO should always be turned **OFF** before the following situation in order to prevent severe damage to the wiper system:

- Cleaning the windshield
- Driving through a car wash
- No rain present

■ Rear Wiper/Washer

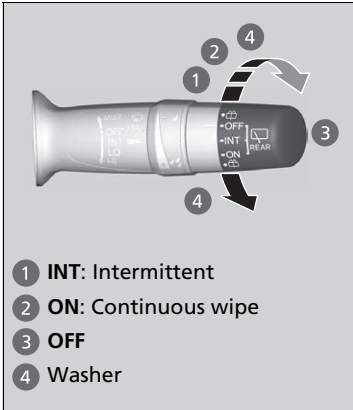

- 1 INT: Intermittent
- 2 ON: Continuous wipe
- 3 OFF
- 4 Washer

The rear wiper and washer can be used when the power mode is in ON.

■ Wiper switch (OFF, INT, ON)

Change the wiper switch setting according to the amount of rain.

■ Washer ()

Sprays while you rotate the switch to this position.

Hold it to activate the wiper and to spray the washer. Once released, it stops operating after a few more sweeps.

■ Operating in reverse

When you shift the transmission to **R** with the front wiper activated, the rear wiper operates automatically as follows even if its switch is off.

Front Wiper Position	Rear Wiper Operation
INT (Intermittent)	Intermittent
LO (Low speed wipe) HI (High speed wipe)	Continuous

Brightness Control

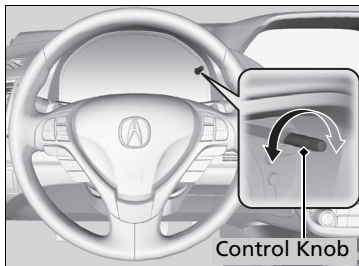

When the power mode is in ON, you can use the brightness control knob to adjust instrument panel brightness.

Brighten: Turn the knob to the right.

Dim: Turn the knob to the left.

You will hear a beep when the brightness reaches minimum or maximum. The multi-information display will return to its original state several seconds after you adjust the brightness.

▶▶ Brightness Control

Instrument panel brightness varies, depending on whether the exterior lights are on or off. The instrument panel dims to reduce glare when they are on.

When it is bright outside and the headlight integration with the wiper is activated, the instrument panel brightness does not change.

Pressing the  (SEL/RESET) knob switches the display.

If you turn the knob to the right until the brightness display is up to max, a beep sound. This cancels the reduced instrument panel brightness when the exterior lights are on.

Models with full color display

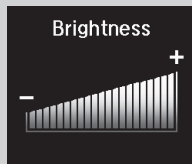

Models without full color display



Rear Defogger/Heated Door Mirror Button

Press the rear defogger and heated door mirror button to defog the rear window and mirrors when the power mode is in ON.

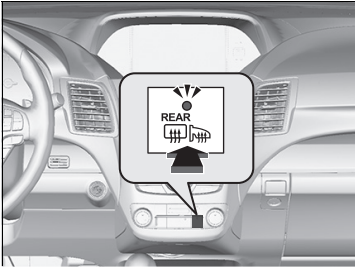

The rear defogger and heated door mirrors automatically switch off after 10-30 minutes depending on the outside temperature. However, if the outside temperature is 32°F (0°C) or below, they do not automatically switch off.

▶▶ Rear Defogger/Heated Door Mirror Button

NOTICE

When cleaning the inside of the rear window, be careful not to damage the heating wires. It is critical to wipe the window from side to side along the defogger heating wires.

This system consumes a lot of power, so turn it off when the window has been defogged. Also, do not use the system for a long period when the engine is idling. This may weaken the battery, making it difficult to start the engine.

Driving Position Memory System

You can store two driver's seat and door mirror positions with the driving position memory system.

When you unlock and open the driver's door with a remote transmitter, the seat and door mirrors adjust automatically to one of the two preset positions.

The multi-information display shows you which remote transmitter you used to unlock the vehicle when you enter.

- Driver 1 transmitter is linked to memory button 1.
- Driver 2 transmitter is linked to memory button 2.

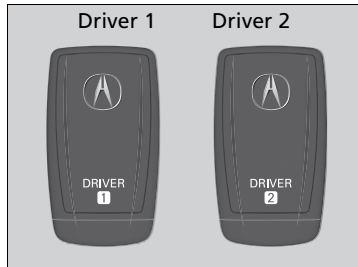

▶▶ Driving Position Memory System

Using the multi-information display, you can disable the automatic seat adjustment function.

▶ **Customized Features** P. 102, 108

■ Storing a Position in Memory

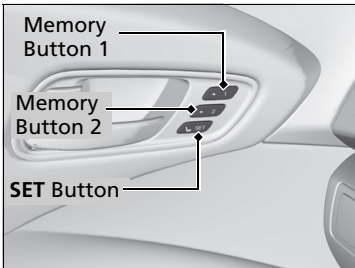

1. Set the power mode to ON. Adjust the driver's seat and the door mirrors to the desired position.
2. Press the **SET** button.
 - ▶ You will hear a beep, and the memory button indicator light will blink.
3. Press and hold memory button **1** or **2** within five seconds of pressing the **SET** button.
 - ▶ Once the seat and the door mirrors position has been memorized, the indicator light on the button you pressed stays on.

■ Recalling the Stored Position

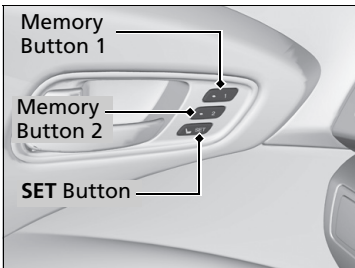

1. Move the shift lever to **P**.
2. Apply the parking brake.
3. Press a memory button (**1** or **2**).
 - ▶ You will hear a beep, and the indicator light will blink.

The seat and the door mirrors will automatically move to the memorized positions. When they have finished moving, you will hear a beep, and the indicator light stays on.

⊠ Storing a Position in Memory

After you press the **SET** button, the storing operation will be canceled when:

- You do not press the memory button within five seconds.
- You readjust the seat position before the double-beep.
- You readjust the door mirrors.
- You set the power mode to any position except ON.

⊠ Recalling the Stored Position

The seat and the door mirrors will stop moving if you:

- Press the **SET** button, or a memory button (**1** or **2**).
- Adjust the seat position.
- Adjust the door mirrors.
- Shift into any position except **P**.

Adjusting the Steering Wheel

The steering wheel height and distance from your body can be adjusted so that you can comfortably grip the steering wheel in an appropriate driving posture.

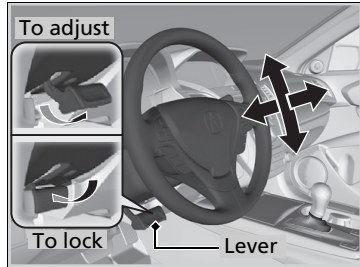

1. Pull the steering wheel adjustment lever up.
 - ▶ The steering wheel adjustment lever is under the steering column.
2. Move the steering wheel up or down, and in or out.
 - ▶ Make sure you can see the instrument panel gauges and indicators.
3. Push the steering wheel adjustment lever down to lock the steering wheel in position.
 - ▶ After adjusting the position, make sure you have securely locked the steering wheel in place by trying to move it up, down, in, and out.

Adjusting the Steering Wheel

⚠ WARNING

Adjusting the steering wheel position while driving may cause you to lose control of the vehicle and be seriously injured in a crash.

Adjust the steering wheel only when the vehicle is stopped.

Make any steering wheel adjustments before you start driving.

Interior Rearview Mirror

Adjust the angle of the rearview mirror when you are sitting in the correct driving position.

Automatic Dimming Rearview Mirror and Power Door Mirrors*

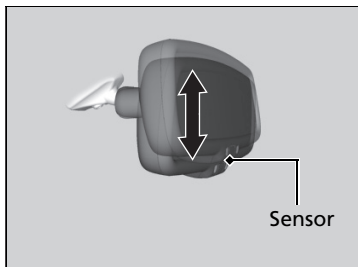

When driving after dark, the automatic dimming rearview mirror and power door mirrors* reduce the glare from headlights behind you.

* Not available on all models

Adjusting the Mirrors

Keep the inside and door mirrors clean and adjusted for best visibility.

Adjust the mirrors before you start driving.

➤ **Adjusting the Seat Positions** P. 164

Automatic Dimming Rearview Mirror and Power Door Mirrors*

The auto dimming function cancels when the shift position is in **R**.

Power Door Mirrors

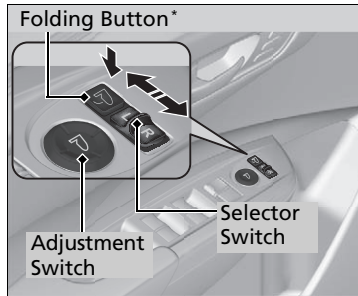

You can adjust the door mirrors when the power mode is in ON.

■ Mirror position adjustment

L/R selector switch: Select the left or right mirror. After adjusting the mirror, return the switch to the center position.

Mirror position adjustment switch: Press the switch left, right, up, or down to move the mirror.

■ Folding door mirrors*

Press the folding button to fold in and out the door mirrors.

■ Reverse Tilt Door Mirror

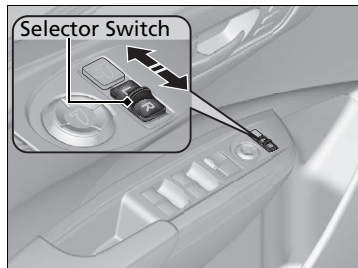

If activated, either side door mirror automatically tilts downward when you put the shift lever in **[R]**; this improves close-in visibility on the selected side of the vehicle when reversing. The mirror automatically returns to its original position when you shift out of **[R]**.

To activate this feature, set the power mode to ON, and slide the selector switch to the left or right side.

Expanded View Driver's Mirror

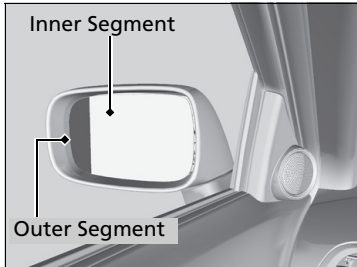

The driver side door mirror has outer and inner segments.

The outer segment is slightly curved to provide a wider angle view than a standard flat mirror. This wider view may help you check areas that are not visible using a standard door mirror.

Expanded View Driver's Mirror

Objects visible in the outer segment of the driver side door mirror appear smaller than objects in the rest of the mirror. But in fact, they are closer than they appear.

Do not rely on your mirrors. Always look to the side and behind your vehicle before changing lanes.

Adjusting the Seat Positions

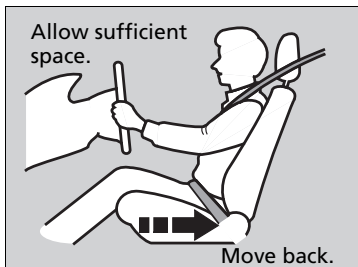

Adjust the driver's seat as far back as possible while allowing you to maintain full control of the vehicle. You should be able to sit upright, well back in the seat and be able to adequately press the pedals without leaning forward, and grip the steering wheel comfortably. The passenger's seat should be adjusted in a similar manner, so that it is as far back from the front airbag in the dashboard as possible.

■ Adjusting the front power seats

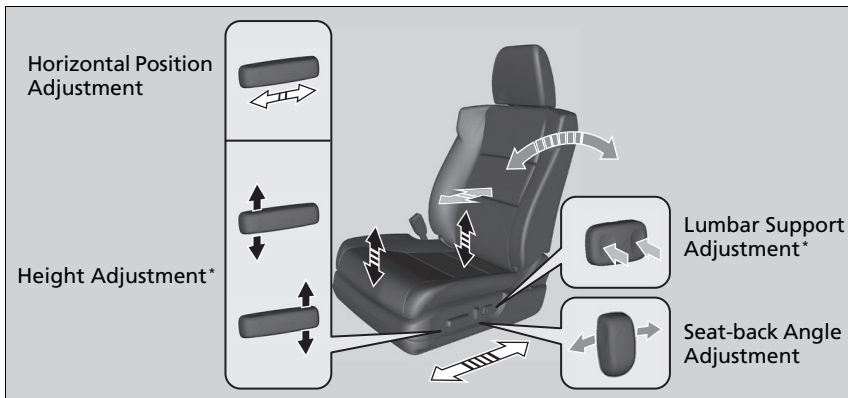

▶▶ Adjusting the Seats

⚠ WARNING

Sitting too close to a front airbag can result in serious injury or death if the front airbags inflate.

Always sit as far back from the front airbags as possible while maintaining control of the vehicle.

The National Highway Traffic Safety Administration and Transport Canada recommend that drivers allow at least 10 inches (25 cm) between the center of the steering wheel and the chest.

Always make seat adjustments before driving.

■ Adjusting the Seat-Backs

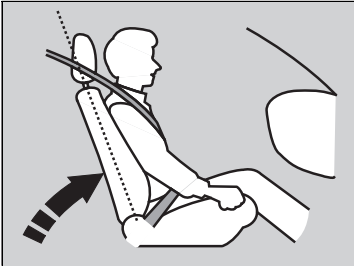

Adjust the driver's seat-back to a comfortable, upright position, leaving ample space between your chest and the airbag cover in the center of the steering wheel.

The front seat passenger should also adjust their seat-back to a comfortable, upright position.

Reclining a seat-back so that the shoulder part of the belt no longer rests against the occupant's chest reduces the protective capability of the belt. It also increases the chance of sliding under the belt in a crash and being seriously injured. The farther a seat-back is reclined, the greater the risk of injury.

▣ Adjusting the Seat-Backs

⚠ WARNING

Reclining the seat-back too far can result in serious injury or death in a crash.

Adjust the seat-back to an upright position, and sit well back in the seat.

Do not put a cushion, or other object, between the seat-back and your back. Doing so may interfere with proper seat belt or airbag operation.

If you cannot get far enough away from the steering wheel and still reach the controls, we recommend that you investigate whether some type of adaptive equipment may help.

■ Adjusting the Head Restraints

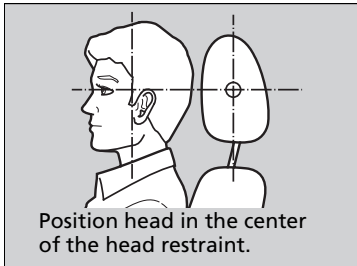

Your vehicle is equipped with head restraints in all seating positions.

Head restraints are most effective for protection against whiplash and other rear-impact crash injuries when the center of the back of the occupant's head rests against the center of the restraint. The tops of the occupant's ears should be level with the center height of the restraint.

■ Adjusting the front and rear outer head restraint positions

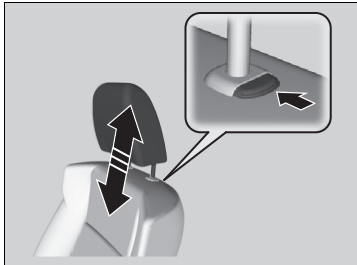

To raise the head restraint: Pull it upward.

To lower the head restraint: Push it down while pressing the release button.

►► Adjusting the Head Restraints

⚠ WARNING

Improperly positioning head restraints reduces their effectiveness and increases the likelihood of serious injury in a crash.

Make sure head restraints are in place and positioned properly before driving.

For the head restraint system to work properly:

- Do not hang any items on the head restraints, or from the restraint legs.
- Do not place any object between an occupant and the seat-back.
- Install each restraint in its proper location.

■ Changing the Rear Center Seat Head Restraint Position

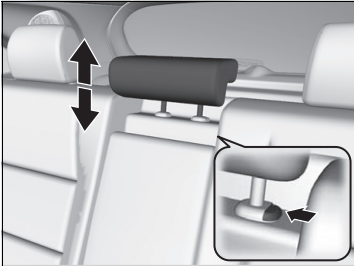

A passenger sitting in a center back seating position should adjust the height of their head restraint to an appropriate position before the vehicle begins moving.

To raise the head restraint:

Pull it upward.

To lower the head restraint:

Push it down while pressing the release button.

■ Removing and Reinstalling the Head Restraints

Head restraints can be removed for cleaning or repair.

To remove a head restraint:

Pull the restraint up as far as it will go. Then push the release button, and pull the restraint up and out.

To reinstall a head restraint:

Insert the legs back in place, then adjust the head restraint to an appropriate height while pressing the release button. Pull up on the restraint to make sure it is locked in position.

☒ Removing and Reinstalling the Head Restraints

⚠ WARNING

Failure to reinstall, or correctly reinstall, the head restraints can result in severe injury during a crash.

Always replace the head restraints before driving.

■ Maintain a Proper Sitting Position

After all occupants have adjusted their seats and head restraints, and put on their seat belts, it is very important that they continue to sit upright, well back in their seats, with their feet on the floor, until the vehicle is safely parked and the engine is off.

Sitting improperly can increase the chance of injury during a crash. For example, if an occupant slouches, lies down, turns sideways, sits forward, leans forward or sideways, or puts one or both feet up, the chance of injury during a crash is greatly increased.

In addition, an occupant who is out of position in the front seat can be seriously or fatally injured in a crash by striking interior parts of the vehicle or being struck by an inflating front airbag.

►► Maintain a Proper Sitting Position

WARNING

Sitting improperly or out of position can result in serious injury or death in a crash.

Always sit upright, well back in the seat, with your feet on the floor.

Rear Seats

Folding Down the Rear Seats

Separately fold down the left and right halves of the rear seat to make room for cargo.

To fold down the seat

1. Store the center seat belt first. Insert the latch plate into the slot on the side of the anchor buckle.
2. Retract the seat belt into the holder on the ceiling.
 - ▶ **Seat Belt with Detachable Anchor** P. 36
3. Lower the center head restraint to its lowest position. Put the armrest back into the seat-back.

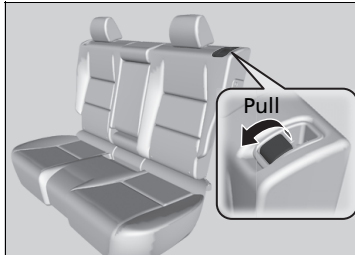

From the rear door side

4. Pull the release lever.

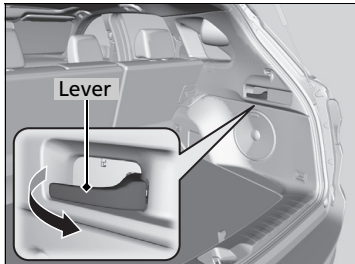

From the cargo area side

4. Pull the release lever.

Folding Down the Rear Seats

Remove any items from the rear seat cushion and floor before you fold down the rear seat.

When you fold down one side of the rear seats and use the non-recessed part of the cargo area, make sure to secure the cargo. Loose items can fly forward and cause injury if you have to brake hard.

The front seats must be far enough forward so they do not interfere with the rear seats as they fold down.

Make sure all items in the cargo area or items extending to the rear seats are properly secured. Loose items can fly forward if you have to brake hard.

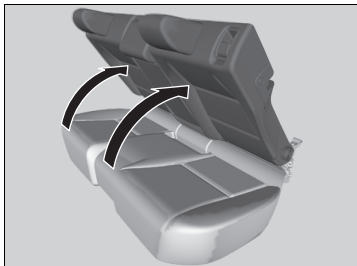

■ **To return the seat to the original position**

Pull up the seat-back in the upright position.

►► To return the seat to the original position

Make sure the seat-back, head restraints and seat cushion are securely latched back into place before driving. Also, make sure all rear shoulder belts are positioned in front of the seat-back, and the center shoulder belt is re-positioned in the holding slot.

Armrest

■ **Using the Rear Seat Armrest**

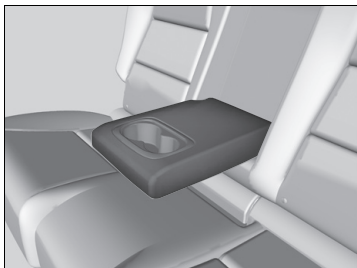

Pull down the armrest in the center seat-back.

Interior Lights

Interior Light Switches

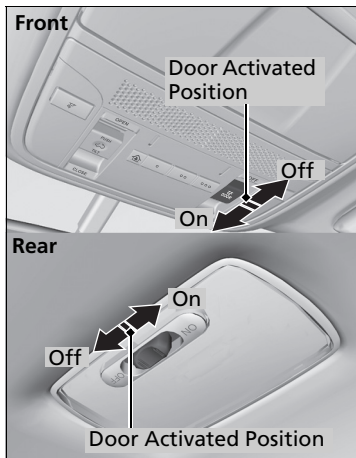

■ ON

The interior lights come on regardless of whether the doors are open or closed.

■ Door activated

The interior lights come on in the following situations:

- When any of the doors are opened.
- You unlock the driver's door.
- When the power mode is set to VEHICLE OFF (LOCK).

■ OFF

The interior lights remain off regardless of whether the doors are open or closed.

Map Lights

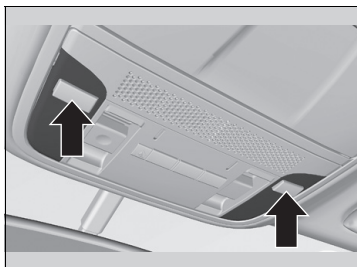

The map lights can be turned on and off by pressing the  button.

☒ Interior Light Switches

In the door activated position, the interior lights fade out and go off about 30 seconds after the doors are closed.

The lights go off after 30 seconds in the following situations:

- When you unlock the driver's door but do not open it.
- When you set the power mode to VEHICLE OFF (LOCK) but do not open a door.

You can change the interior lights dimming time.

☒ **Customized Features** P. 102, 108

The interior lights go off immediately in the following situations:

- When you lock the driver's door.
- When you close the driver's door in ACCESSORY mode.
- When you set the power mode to ON.

If you leave any of the doors open in VEHICLE OFF (LOCK) mode, the interior lights go off after about 15 minutes.

☒ Map Lights

When the interior light switch is in the door activated position and any door is open, the map light will not go off when you press the button.

■ Cargo Area Lights

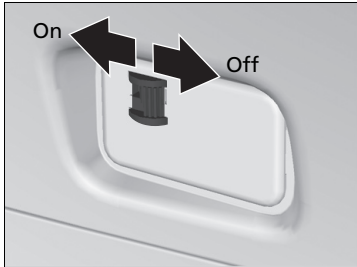

■ ON

The light comes on when you open the tailgate, and goes off when closed.

■ OFF

The light stays off with or without opening the tailgate.

Interior Convenience Items

■ Glove Box

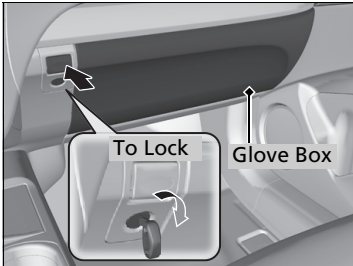

Press the button to open the glove box. You can lock the glove box with the built-in key.

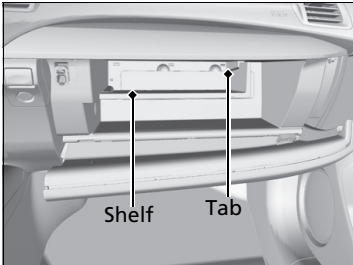

■ Removable shelf

The shelf in the glove box is detachable. To remove it, disengage the tabs.

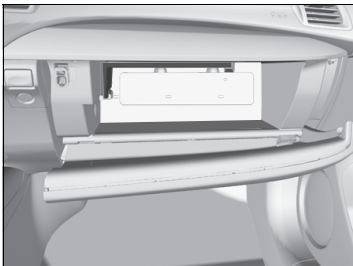

The removed shelf can be stored upside down in the glove box.

☒ Glove Box

⚠ WARNING

An open glove box can cause serious injury to your passenger in a crash, even if the passenger is wearing the seat belt.

Always keep the glove box closed while driving.

■ Console Compartment

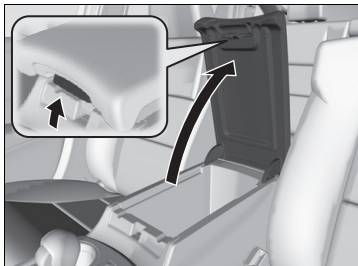

Pull the handle to open the console compartment.

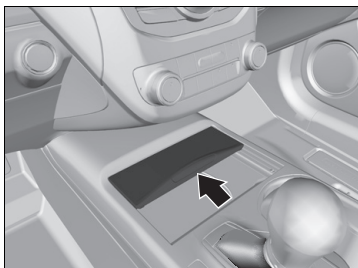

Slide the lid using the release knob to open or close the console compartment.

■ Beverage Holders

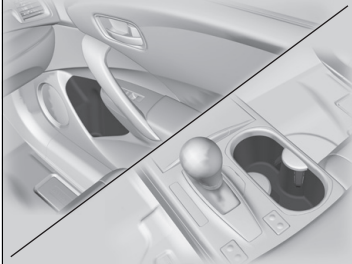

■ Front seat beverage holders

Are located in the console between the front seats.

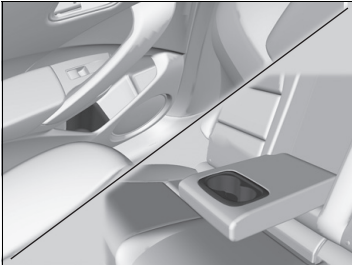

■ Rear seat beverage holders

Fold the armrest down to use the rear seat beverage holders.

☒ Beverage Holders

NOTICE

Spilled liquids can damage the upholstery, carpeting, and electrical components in the interior.

Be careful when you are using the beverage holders. Hot liquid can scald you.

■ Accessory Power Sockets

The accessory power sockets can be used when the power mode is in ACCESSORY or ON.

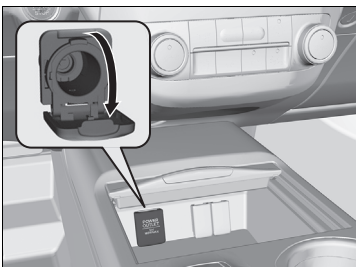

■ Accessory power socket (console compartment)

Open the cover to use it.

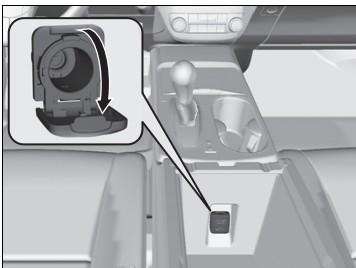

»» Accessory Power Sockets

NOTICE

Do not insert an automotive type cigarette lighter element.

This can overheat the power socket.

The accessory power socket is designed to supply power for 12 volt DC accessories that are rated 180 watts or less (15 amps).

To prevent battery drain, only use the power socket with the engine running.

When each socket is being used simultaneously, the combined power rating of the accessories should not exceed 180 watts (15 amps).

■ Coat Hooks

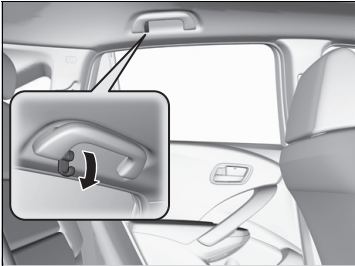

There is a coat hook on the rear grab handle of both sides. Pull it down to use it.

■ Cargo Hooks

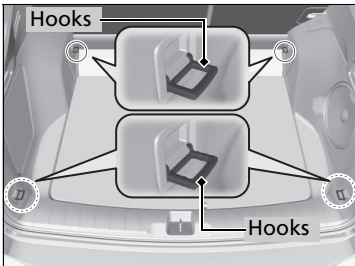

Use floor cargo hooks to secure luggage in the cargo area.

☒ Coat Hooks

The coat hooks are not designed for large or heavy items.

■ Sunglasses Holder

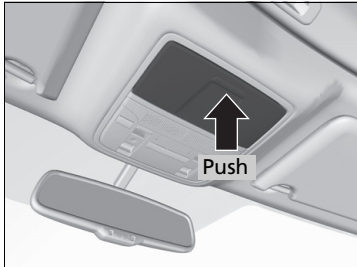

To open the sunglasses holder, push and release the indent. To close, push it again until it latches.

You can store eyeglasses and other small items in this holder.

☒ Sunglasses Holder

Keep the holder closed while driving except when accessing stored items.

■ Seat Heaters and Ventilation



■ Front Seat Heaters*

If the power mode is in ON: The **HI** setting heats the seats faster than the **LO** setting.



While in **HI**, the heater cycles on and off.

- The appropriate indicator will be on while the seat heater is on. Briefly press the switch on the opposite side to turn the heater off. The indicator will be off. When a comfortable temperature is reached, select **LO** to keep the seat warm.

▣ Front Seat Heaters*

⚠ WARNING

Heat induced burns are possible when using seat heaters.

Persons with a diminished ability to sense temperature (e.g., persons with diabetes, lowerlimb nerve damage, or paralysis) or with sensitive skin should not use seat heaters.

Do not use the seat heaters even in **LO** when the engine is off. Under such conditions, the battery may be weakened, making the engine difficult to start.

In the **LO** setting, the heater runs continuously and does not automatically turn off.

* Not available on all models



■ Front Seat Heaters and Ventilation *

If the power mode is in ON:

Seat heater - The **HI** setting heats the seats faster than the **LO** setting.

Seat ventilation - The **HI** setting ventilates the seats faster than the **LO** setting.



Press the seat heater or the seat ventilation button:

Once - The **HI** setting (three indicators on)

Twice - The **MID** setting (two indicators on)

Three times - The **LO** setting

Four times - The OFF setting (no indicators on)

When a comfortable temperature is reached while using the seat heaters in **HI**, select **MID** or **LO** to keep the seat warm.

▣ Front Seat Heaters and Ventilation *

⚠ WARNING

Heat induced burns are possible when using seat heaters.

Persons with a diminished ability to sense temperature (e.g., persons with diabetes, lowerlimb nerve damage, or paralysis) or with sensitive skin should not use seat heaters.

Do not use the seat heaters and the seat ventilation even in **LO** when the engine is OFF. Under such conditions, the battery may be weakened, making the engine difficult to start.

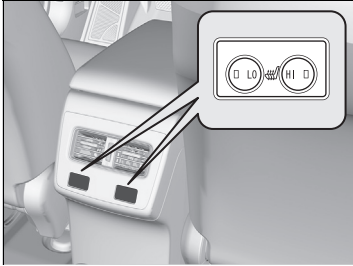

■ Rear Seat Heaters*

If the power mode is in ON: The **HI** setting heats the seats faster than the **LO** setting.

There is no heater in the rear center seating position.

While in **HI**, the heater cycles on and off.

- The appropriate indicator will be on while the seat heater is on. Briefly press the button on the opposite side to turn the heater off. The indicator will be off. When a comfortable temperature is reached, select **LO** to keep the seat warm.

⊠ Rear Seat Heaters*

⚠ WARNING

Heat induced burns are possible when using seat heaters.

Persons with a diminished ability to sense temperature (e.g., persons with diabetes, lowerlimb nerve damage, or paralysis) or with sensitive skin should not use seat heaters.

Do not use the seat heaters even in **LO** when the engine is off. Under such conditions, the battery may be weakened, making the engine difficult to start.

In the **LO** setting, the heater runs continuously and does not automatically turn off.

* Not available on all models

Using Automatic Climate Control

The automatic climate control system maintains the interior temperature you select. The system also selects the proper mix of heated or cooled air that will as quickly as possible, raise or lower the interior temperature to your preference.

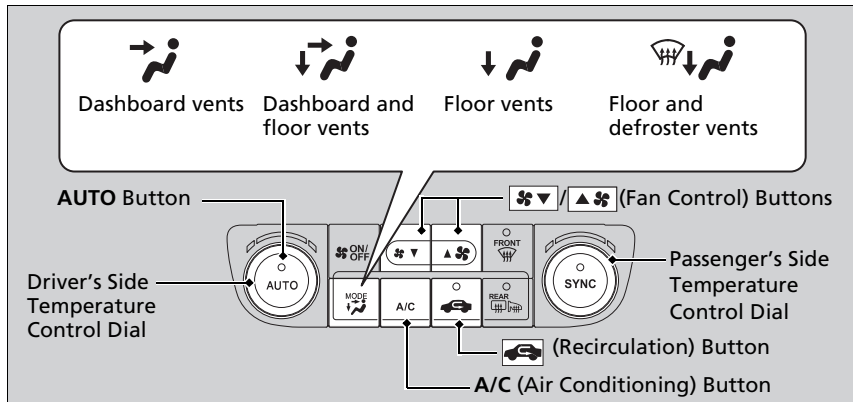

Use the system when the engine is running.

1. Press the **AUTO** button.
2. Adjust the interior temperature using the driver's side or passenger's side control dial.
3. Press the **ON/OFF** button to cancel.

■ Switching between the recirculation and fresh air modes

Press the  button and switch the mode depending on environmental conditions. Recirculation Mode (indicator on): Recirculates air from the vehicle's interior through the system.

Fresh Air Mode (indicator off): Maintains outside ventilation. Keep the system in fresh air mode in normal situations.

✎ Using Automatic Climate Control

If any buttons are pressed while using the climate control system in **AUTO**, the function of the button that was pressed will take priority. The **AUTO** indicator will go off, but functions unrelated to the button that was pressed will be controlled automatically.

To prevent cold air from blowing in from outside, the fan may not start immediately when the **AUTO** button is pressed.

If the interior is very warm, you can cool it down more rapidly by partially opening the windows, turning the system on **AUTO**, and setting the temperature to low. Change the fresh mode to recirculation mode until the temperature cools down.

When you set the temperature to the lower or upper limit, **Lo** or **Hi** is displayed.

Pressing the  button switches the climate control system between on and off. When turned on, the system returns to your last selection.

Defrosting the Windshield and Windows

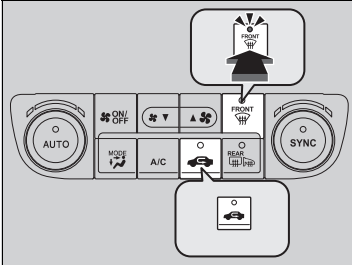

Pressing the  button turns the air conditioning system on and automatically switches the system to fresh air mode.

Pressing the  button again to turn off, the system returns to the previous settings.

To rapidly defrost the windows

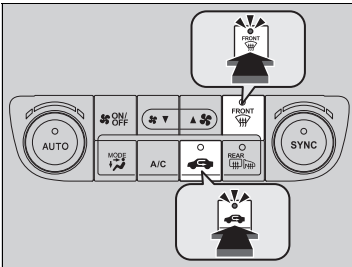

1. Press the  button.
2. Press the  button.

Defrosting the Windshield and Windows

For your safety, make sure you have a clear view through all the windows before driving.

Do not set the temperature near the upper or lower limit.

When cold air hits the windshield, the outside of the windshield may fog up.

If the side windows fog up, adjust the vents so that the air hits the side windows.

To rapidly defrost the windows

After defrosting the windows, switch over to fresh air mode.

If you keep the system in recirculation mode, the windows may fog up from humidity. This impedes visibility.

Synchronized Mode

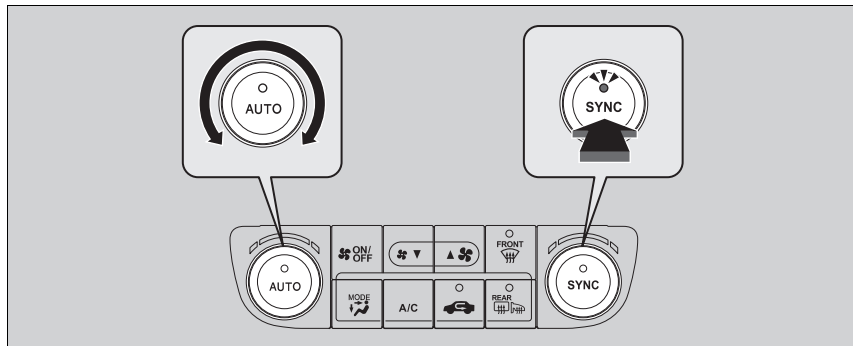

You can set the temperature synchronously for the driver side and the passenger side in synchronized mode.

1. Press the **SYNC** button.
 - The system will switch to synchronized mode.
2. Adjust the temperature using driver's side temperature control dial.

Press the **SYNC** button to return to dual mode.

► Synchronized Mode

When you press the  button, the system changes to synchronized mode.

When the system is in dual mode, the driver side temperature and the passenger side temperature can be set separately.

Models with navigation system

In AUTO mode, the system adjusts each temperature based on the information of the sunlight sensor and the sun position updated by the navigation system's GPS.

Automatic Climate Control Sensors

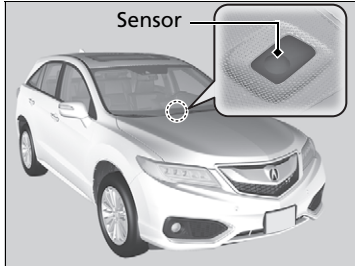

The automatic climate control system is equipped with sensors. Do not cover or spill any liquid on them.

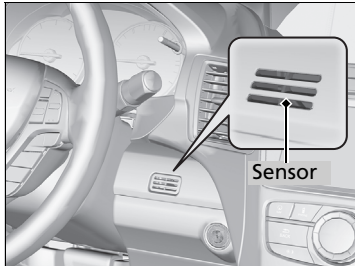

Features

This chapter describes how to operate technology features.

Audio System*		
About Your Audio System	188	
USB Port	189	
Auxiliary Input Jack	189	
Audio System Theft Protection	190	
Audio Remote Controls.....	191	
Audio System Basic Operation*	192	
Audio/Information Screen	193	
Wallpaper Setup	196	
Display Setup	198	
Adjusting the Sound	199	
Playing the AM/FM Radio	200	
Playing the SiriusXM® Radio	202	
Playing a CD	204	
Playing an iPod	207	
Playing Pandora®	210	
Playing a USB Flash Drive	212	
Playing <i>Bluetooth</i> ® Audio.....	215	
Audio Error Messages*	217	
General Information on the Audio System*	220	
HomeLink® Universal Transceiver		
Training HomeLink	224	
<i>Bluetooth</i>® HandsFreeLink®		
Using HFL	226	
HFL Menus.....	228	
Compass*		255

* Not available on all models

About Your Audio System

On models with navigation system, see Navigation System Manual for operation of the audio system, AcuraLink, *Bluetooth*® HandsFreeLink®, and voice commands for these features.

The audio system features AM/FM radio and the SiriusXM® Radio service. It can also play audio CDs, WMA/MP3/AAC files, iPod, iPhone, USB flash drives, and *Bluetooth*® devices.

You can operate the audio system from the buttons and switches on the panel, or the remote controls on the steering wheel.

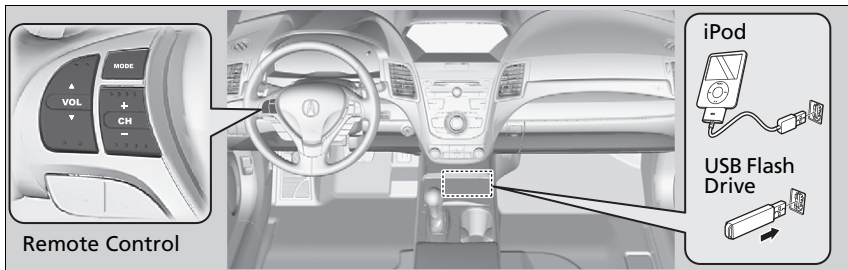

About Your Audio System

SiriusXM® Radio is available on a subscription basis only. For more information on SiriusXM® Radio, contact a dealer.

General Information on the Audio System* P. 220

SiriusXM® Radio is available in the United States and Canada, except Hawaii, Alaska, and Puerto Rico.

SiriusXM® is a registered trademark of SiriusXM Radio, Inc.

Video CDs, DVDs, and 3-inch (8-cm) mini CDs are not supported.

iPod, iPhone and iTunes are trademarks of Apple Inc.

State or local laws may prohibit the operation of handheld electronic devices while operating a vehicle.

USB Port

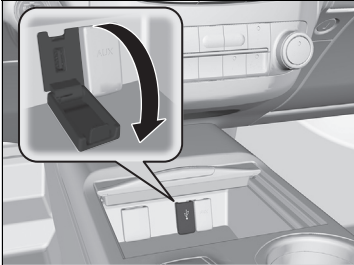

1. Open the cover.
2. Install the iPod dock connector or the USB flash drive to the USB port.

Auxiliary Input Jack

Use the jack to connect standard audio devices.

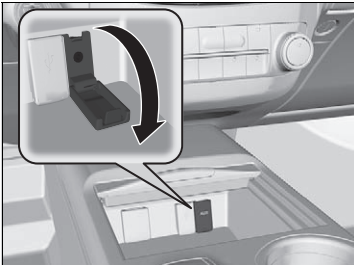

1. Open the AUX cover.
2. Connect a standard audio device to the input jack using a 1/8 inch (3.5 mm) stereo miniplug.
 - ▶ The audio system automatically switches to the AUX mode.

⌘ USB Port

- Do not leave the iPod or USB flash drive in the vehicle. Direct sunlight and high temperatures may damage it.
- Do not connect the iPod or USB flash drive using a hub.
- Do not use a device such as a card reader or hard disk drive, as the device or your files may be damaged.
- We recommend backing up your data before using the device in your vehicle.
- Displayed messages may vary depending on the device model and software version.

If the audio system does not recognize the iPod, try reconnecting it a few times or reboot the device. To reboot, follow the manufacturer's instructions provided with the iPod or visit www.apple.com/ipod.

⌘ Auxiliary Input Jack

To switch the mode, press any of the audio mode buttons. You can return to the AUX mode by pressing the **AUX** button.

You cannot use the auxiliary input jack if you replace the audio system.

Audio System Theft Protection

The audio system is disabled when it is disconnected from the power source, such as when the battery is disconnected or goes dead.

■ Reactivating the audio system

1. Set the power mode to ON, and turn on the audio system.
 - ▶ If you set the power mode to ACCESSORY, you will be requested to enter the audio security code. See step 3.
2. Press and hold the power button again for more than two seconds.
 - ▶ The audio system is reactivated when the system's control unit recognizes that the system is in your vehicle.
If the control unit fails to recognize, **ENTER CODE** appears on the audio/information screen.
3. Enter the audio security code using the preset buttons. If you enter an incorrect digit, continue to the last digit, then try again. If you do not enter the code correctly after 10 tries, leave the system for one hour before trying again, or visit a dealer to have the system reset.

▶▶ Audio System Theft Protection

U.S. models

Find the audio system's security code and serial number label in your owner's manual kit.

We recommend that you write down the serial number in this owner's manual.

Do not store the label in your vehicle. If you lose the label, you must first retrieve the serial number, and then obtain the code.

You can find out about your serial number and security code from a dealer.

You can register the security code at Acura Owners (owners.acura.com), and find information on how to retrieve the serial number and obtain the code at radio-navicode.acura.com.

Audio Remote Controls

Allows you to operate the audio system while driving.

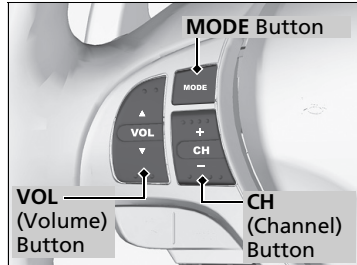

MODE Button

Cycles through the audio modes as follows:
FM1→FM2→AM→SiriusXM®1→SiriusXM®2
→CD→AUX

VOL Button

Press ▲: Increases the volume.

Press ▼: Decreases the volume.

CH Button

- When listening to the radio
 - Press [+]: Selects the next preset radio station.
 - Press [-]: Selects the previous preset radio station.
 - Press and hold [+]: Selects the next strong station.
 - Press and hold [-]: Selects the previous strong station.
- When listening to a CD, iPod, USB flash drive, or *Bluetooth*® Audio
 - Press [+]: Skips to the next song.
 - Press [-]: Goes back to the beginning of the current or previous song.
- When listening to a CD or USB flash drive
 - Press and hold [+]: Skips to the next folder.
 - Press and hold [-]: Goes back to the previous folder.
- When listening to Pandora®*
 - Press [+]: Skips to the next song.
 - Press and hold [+]: Selects the next station.
 - Press and hold [-]: Selects the previous station.

* Not available on all models

Audio Remote Controls

Some sources will only appear when available, such as when a CD is inserted or when a compatible device is connected.

To use the audio system function, the power mode must be in ACCESSORY or ON.

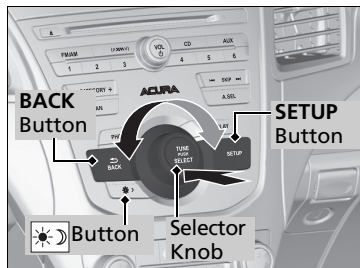

Use the selector knob or **SETUP** button to access some audio functions.

Press to switch between the normal and extended display for some functions.

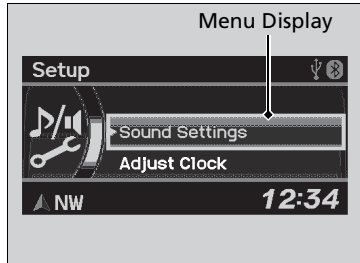

Selector knob: Rotate left or right to scroll through the available choices. Press to set your selection.

SETUP button: Press to select any mode such as the RDS Information, Sound Settings, Play Mode, Resume/Pause, or Adjust Clock.

BACK button: Press to go back to the previous display.

button: Press to change the audio/ information screen brightness. The brightness can be set differently for the day time and night time.

Press once for the day time mode.

Press twice for the night time mode.

Adjust the brightness using .

▶▶ Audio System Basic Operation*

These indications are used to show how to operate the selector knob.

Rotate to select.

Press to enter.

Press the **MODE**, , , or button on the steering wheel to change any audio setting.

▶▶ **Audio Remote Controls** P. 191

Setup Menu Items

▶▶ **Radio Data System (RDS)** P. 201

▶▶ **Adjusting the Sound** P. 199

▶▶ **How to Select a Play Mode** P. 206



▶▶ **To pause or resume a file** P. 216

▶▶ **Setting the Clock** P. 120

Audio/Information Screen

Displays audio status and wallpaper. It allows you to go to various setup options.

Switching the Display

Press **DISPLAY** button. Rotate  and select the mode from the three display modes. Press .

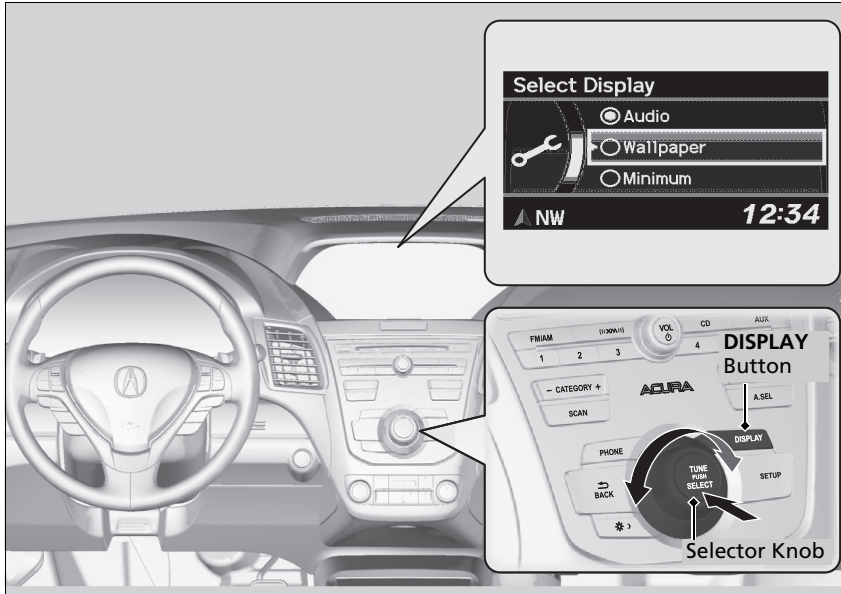

■ Audio Display

Shows the current audio information.

▶ **Audio System Basic Operation*** P. 192

■ Wallpaper

Shows a clock screen or an image you import.



▶ **Wallpaper Setup** P. 196

■ Minimum Display

Minimizes the display by only showing the compass, audio status, and clock on the display.

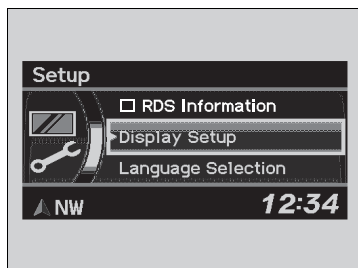



■ Setting Options

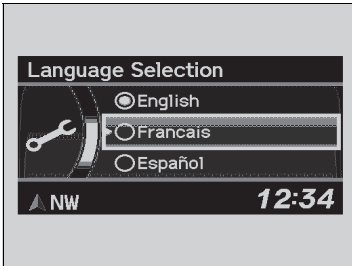

1. Press **SETUP** button.
2. Rotate  and select the setup option you want to change. Press .

Language Selection



1. Rotate  to select **Language Selection**, then press .
2. Rotate  to select the language, then press .

Wallpaper Setup

You can change, store, and delete the wallpaper on the audio/information screen.

Models with navigation system

See the navigation system manual for how to change the wallpaper.

Import Wallpaper

You can import up to three images, one at a time, for wallpaper from a USB flash drive.







1. Connect the USB flash drive to the port.
 ▶ **USB Port** P. 189
2. Press the **SETUP** button.
3. Rotate to select **Display Setup**, then press .
4. Rotate to select **Wallpaper**, then press .
5. Rotate to select **Import**, then press .
6. Rotate to select a desired picture, then press .
7. The preview of the imported data is displayed.
8. Press to save the data.
 - ▶ The confirmation message will appear. Then the display will return to the import wallpaper list.
9. Rotate to select the place to save the data, then press .
 - ▶ The confirmation message will appear.

Wallpaper Setup







- When importing wallpaper files, the image must be in the USB flash drive's root directory. Images in a folder cannot be imported.
- The file format of the image that can be imported is BMP (bmp) or JPEG (jpg).
- Images between 1,680 x 936 (display's maximum image size) and 420 x 234 pixels in size can be displayed in full screen.
- The number of files that can be selected is up to 255.
- Up to 64 characters can be displayed in the file name.

If the USB flash drive does not have any pictures, **No compatible images were found. See Owner's Manual.** will appear.

Select Wallpaper

1. Rotate  to select **Select** on the wallpaper setup menu, then press .
 - ▶ The screen will change to the wallpaper list.
2. Rotate  to select desired wallpaper and press .
 - ▶ The confirmation message will appear. Then the display will return to the wallpaper setup menu.

Delete Wallpaper





1. Rotate  to select **Delete** on the wallpaper setup menu, then press .
 - ▶ The screen will change to the delete wallpaper list.
2. Rotate  to select wallpaper that you want to delete and press .
 - ▶ The confirmation message will appear.
3. Rotate  to select **OK**, then press  to delete completely.
 - ▶ The confirmation message will appear.

Display Setup

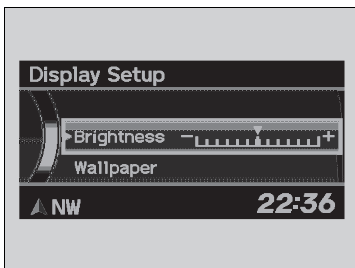
You can change brightness or color theme on the audio/information screen.







Brightness

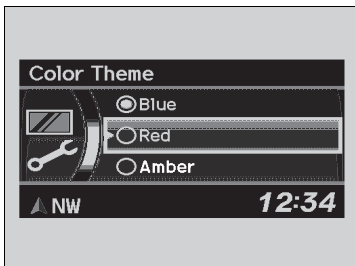

1. Press the **SETUP** button.
2. Rotate  to select **Display Setup**, then press .
3. Rotate  to select **Brightness**, then press .
4. Rotate  to adjust the setting.

Color Theme



1. Press the **SETUP** button.
2. Rotate  to select **Display Setup**, then press .
3. Rotate  to select **Color Theme**, then press . Rotate  to setting you want, then press .

Adjusting the Sound

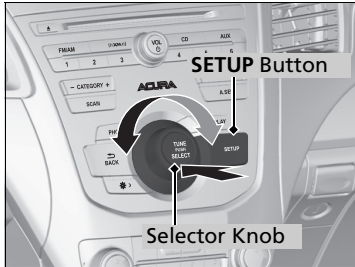

Press the **SETUP** button, and rotate to select **Sound Settings**, then press . Rotate to scroll through the following choices:

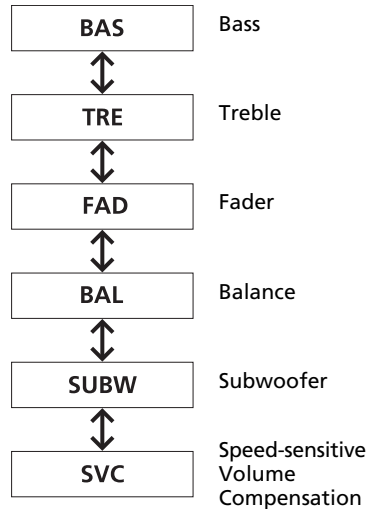
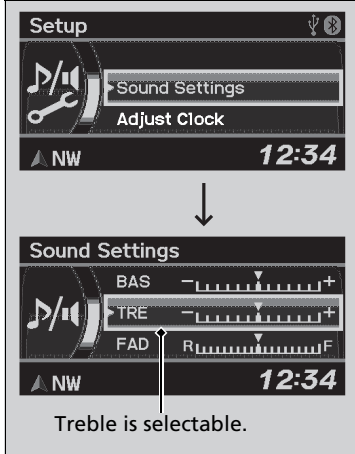

Adjusting the Sound

The **SVC** has four modes: **OFF**, **LOW**, **MID**, and **HIGH**.

SVC adjusts the volume level based on the vehicle speed. As you go faster, audio volume increases. As you slow down, audio volume decreases.

Playing the AM/FM Radio



VOL/⏻ (Power/volume) Knob

Press to turn the audio system on and off.
Turn to adjust the volume.

CATEGORY Bar

Press either side to display and select an RDS category.

FM/AM Button

Press to select a band.

SCAN Button

Press to sample each of the strongest stations on the selected band for 10 seconds. To turn off scan, press the button again.

BACK Button

Press to go back to the previous display.

Selector Knob

Press and turn to tune the radio frequency.

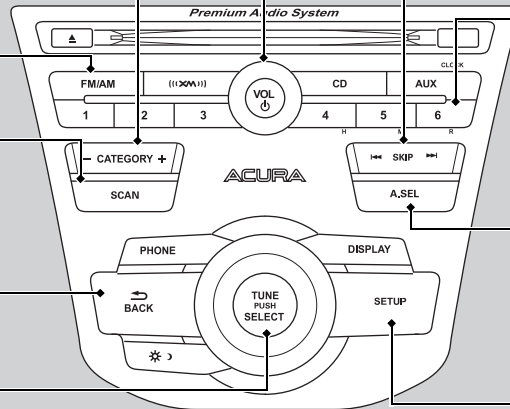

SKIP Bar

Press to search up and down the selected band for a station with a strong signal.

Preset Buttons (1-6)

To store a station:
1. Tune to the selected station.
2. Pick a preset button and hold it until you hear a beep.

To listen to a stored station, select a band, then press the preset button.

A.SEL (Auto Select) Button

Press to scan both bands and store the strongest station in each preset. To turn off auto select, press the button again. This restores the presets you originally set.

SETUP Button



Press to display menu items.

Radio Data System (RDS)

Provides text data information related to your selected RDS capable FM station.

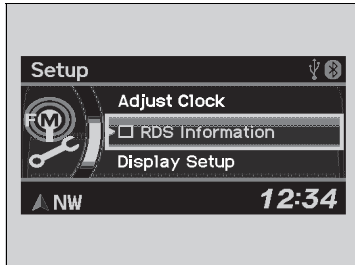
RDS information



1. Press the **SETUP** button and rotate  to select **RDS Information**.
2. Each time you press , the RDS Information switches between on and off.

To find an RDS station from your selected program category

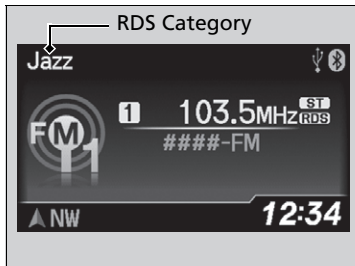

1. Press the **CATEGORY** bar to display and select an RDS category.
2. Use **SKIP** or **SCAN** to select an RDS station.

▶▶ Playing the AM/FM Radio

The **ST** indicator appears on the display indicating stereo FM broadcasts. Stereo reproduction in AM is not available.

Switching the Audio Mode
Pressing the **MODE** button on the steering wheel.
▶ **Audio Remote Controls** P. 191

You can store 6 AM stations and 12 FM stations into the preset button memory. FM1 and FM2 let you store six stations each.

A.SEL function scans and stores up to 6 AM stations and 12 FM stations with a strong signal into the preset button memory.

If you do not like the stations auto select has stored, you can manually store your preferred frequencies.

Playing the SiriusXM® Radio

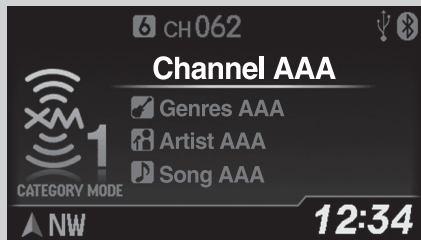

VOL/⏻ (Power/volume) Knob

Press to turn the audio system on and off.

Turn to adjust the volume.

(Ⓜ) (SiriusXM®) Button

Press to select SiriusXM® Radio.

CATEGORY Bar

Press either side to display and select an SiriusXM® Radio category.

SCAN Button

Press to sample all channels (in the channel mode), or channels within a category (in the category mode).

Each sampling continues for a few seconds. Press **SCAN** again to cancel scanning and continue listening to the channel.

BACK Button

Press to go back to the previous display.

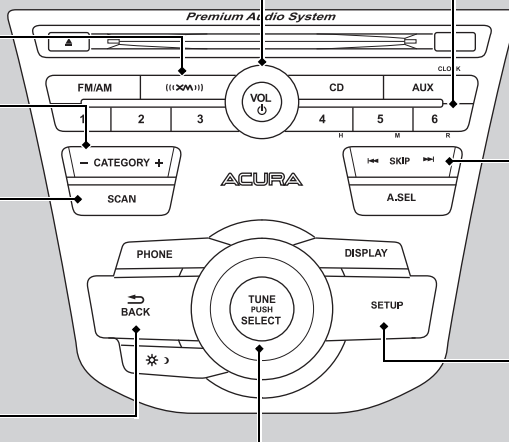

Preset Buttons (1-6)

To store a channel:

1. Tune to the selected channel.
2. Pick a preset button and hold it until you hear a beep.

To listen to a stored channel, select SiriusXM®, then press the preset button.

SKIP Bar

Press ◀ or ▶ to the previous or next channel.

SETUP Button

Press to display menu items.

Selector Knob

Press and turn to select channels.

To Play the SiriusXM® Radio

1. Press the **(SiriusXM)** button to select the SiriusXM® radio band (**SiriusXM®1** or **SiriusXM®2**).
2. Press the **SETUP** button, rotate **(Up)** to select **SiriusXM® Mode**, and press **(Enter)**. Rotate **(Up)** to select **Channel Mode** or **Category Mode**, then press **(Enter)**.
3. Select a channel using the **TUNE (Up)**, **SKIP, CATEGORY, SCAN**, or Preset buttons.

To Select a Channel from a List

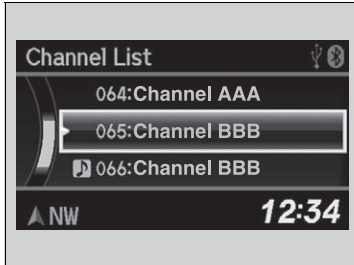

1. Press **(Enter)** to display a channel list.
2. Rotate **(Up)** to select a channel, then press **(Enter)**.

▶▶ Playing the SiriusXM® Radio

In the channel mode, all available channels are selectable. In the category mode, you can select a channel within a category (**Jazz, Rock, Classical**, etc.).

You can store 12 SiriusXM® stations in the preset buttons. **SiriusXM®1** and **SiriusXM®2** let you store 6 stations each.

There may be instances when SiriusXM® Radio does not broadcast all the data fields (artist name, title). This does not indicate a problem with your audio system.

Playing a CD

Your audio system supports audio CDs, CD-Rs and CD-RWs in either MP3, WMA, or AAC format. With the CD loaded, press the **CD** button.

The diagram illustrates the Acura audio system interface. At the top, a display screen shows 'Track AAA', 'Genres AAA', 'Artists AAA', and a progress bar at 1'23". Below the screen is a 'Premium Audio System' unit with a 'CD Slot' and a 'VOL' knob. The unit features a 'CD Button' and a 'SKIP Bar' with left and right arrow buttons. Below the unit is a 'PHONE' button, a 'TUNE PUSH SELECT' knob, a 'DISPLAY' button, and a 'SETUP' button. A 'BACK' button is located at the bottom left. The 'ACURA' logo is centered on the unit.

SCAN Button
 You will get a 10-second sampling of each song.

- Press to sample all tracks on the CD (all files in the current folder in MP3, WMA, or AAC).
- Press and hold to sample the first file in each of the main folders (MP3, WMA, or AAC).
- To turn off scan, press the button.

(CD Eject) Button
 Press to eject a CD.

CATEGORY Bar
 Press **+** to skip to the next folder, and **-** to skip to the beginning of the previous folder in MP3, WMA, or AAC.

BACK Button
 Press to go back to the previous display.

VOL/⏻ (Power/volume) Knob
 Press to turn the audio system on and off.
 Turn to adjust the volume.

CD Slot
 Insert a CD about halfway into the CD slot.

CD Button
 Press to play a CD.

SKIP Bar
 Press **⏮** or **⏭** to change tracks (files in MP3, WMA, or AAC).
 Press and hold to move rapidly within a track/file.

SETUP Button
 Press to display menu items.

Selector Knob
 Turn to change tracks/files.
 Press and turn to select an item, then press to set your selection.

How to Select a File from a Folder with the Selector Knob (MP3/WMA)

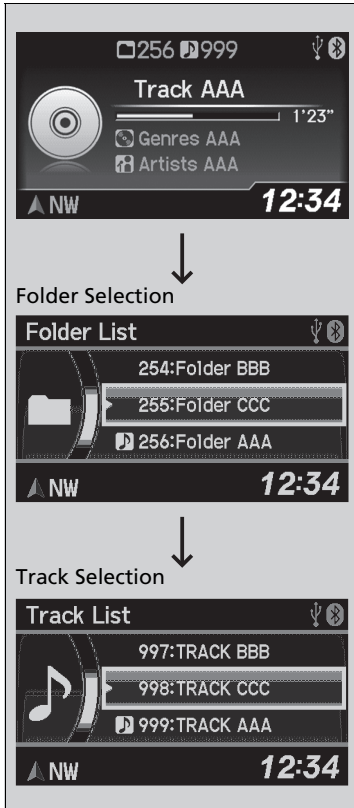

1. Press to switch the display to a folder list.
2. Rotate to select a folder.
3. Press to change the display to a list of files in that folder.
4. Rotate to select a file, then press .

▶▶ Playing a CD

NOTICE

Do not use CDs with adhesive labels. The label can cause the CD to jam in the unit.

WMA files protected by digital rights management (DRM) cannot be played.

The audio system displays **Unplayable File**, then skips to the next file.

Text data appears on the display under the following circumstances:

- When you select a new folder, file, or track.
- When you change the audio mode to CD.
- When you insert a CD.

If you eject the CD but do not remove it from the slot, the system reloads the CD automatically after several seconds.

Continued

How to Select a Play Mode

You can select repeat and random modes when playing a track or file.

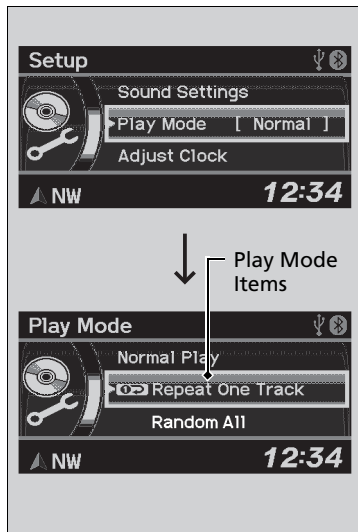

1. Press the **SETUP** button.
2. Rotate to select **Play Mode**, then press .
3. Rotate to select a mode, then press .

How to Select a Play Mode

Press the **BACK** button to go back to the previous display, and press the **SETUP** button to cancel this setting mode.

Play Mode Menu Items

Normal Play

Repeat One Track: Repeats the current track/file(s).

Random All: Plays all tracks/files in random order.

To turn off a play mode

1. Press the **SETUP** button.
2. Rotate to select **Play Mode**, then press .
3. Rotate to select **Normal Play**, then press .

Playing an iPod



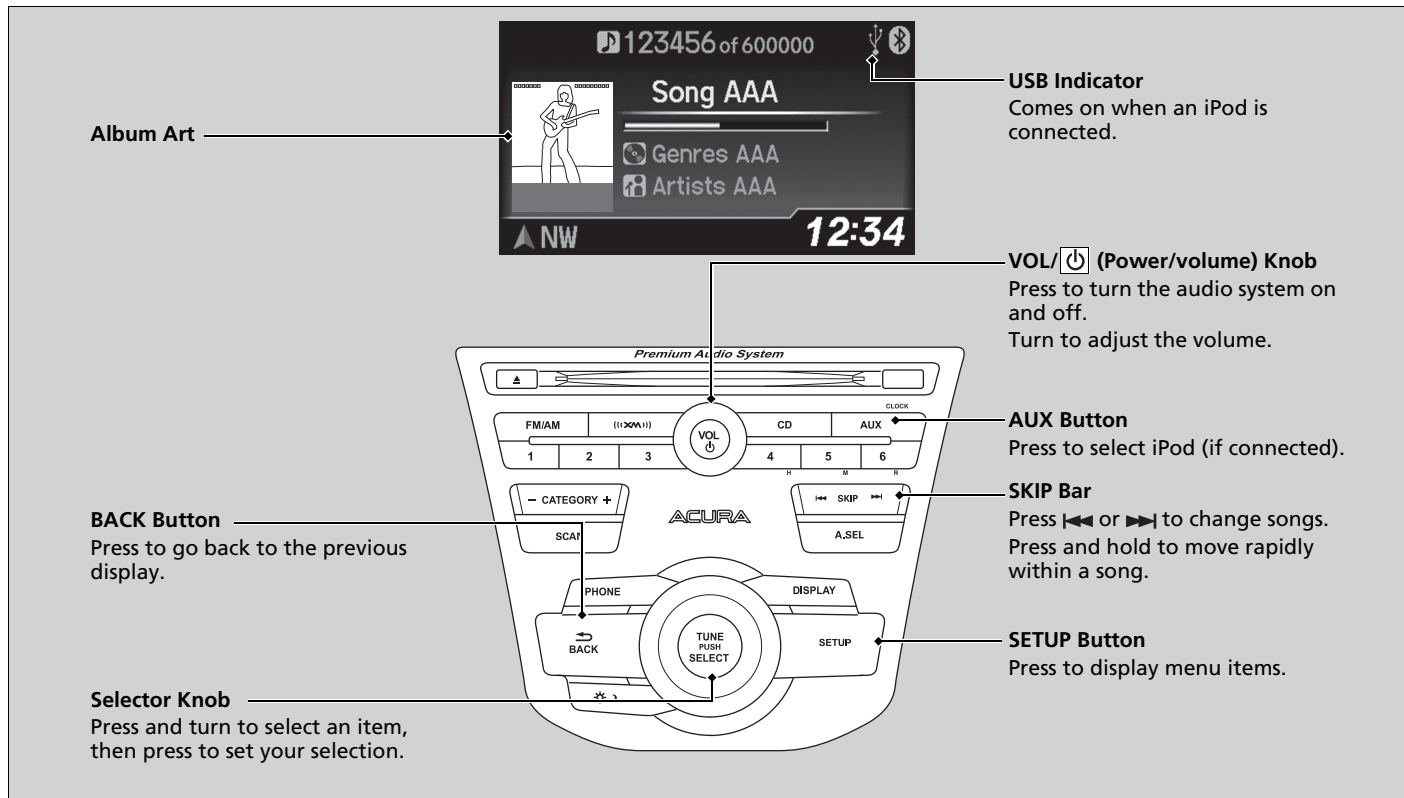

Connect the iPod using your dock connector to the USB port, then press the **AUX** button.

 **USB Port** P. 189

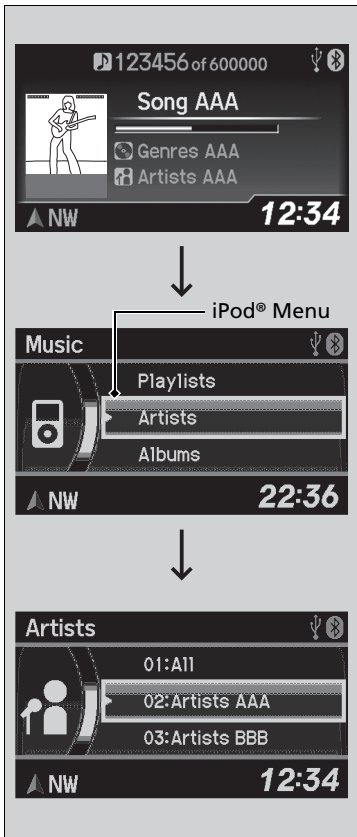

■ How to Select a File from the iPod Menu



1. Press  to display the iPod menu.
2. Rotate  to select a menu.
3. Press  to display the items on that menu.
4. Rotate  to select an item, then press .

▶▶ Playing an iPod

Available operating functions vary on models or versions. Some functions may not be available on the vehicle's audio system.

If there is a problem, you may see an error message on the audio/information screen.

 **iPod/USB Flash Drive** P. 218

How to Select a Play Mode

You can select repeat and shuffle modes when playing a file.

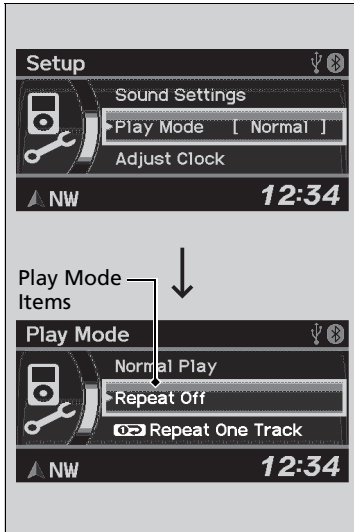

1. Press the **SETUP** button.
2. Rotate to select **Play Mode**, then press .
3. Rotate to select a mode, then press .

■ To turn off a play mode

1. Press the **SETUP** button.
2. Rotate to select **Play Mode**, then press .
3. Rotate to select **Normal Play**, then press .

▶▶ How to Select a Play Mode

Play Mode Menu Items

Shuffle Off: Turns off the shuffle mode.

Shuffle: Plays all available files in a selected list (playlists, artists, albums, songs, genres, or composers) in random order.

Shuffle Albums: Plays all available albums in a selected list (playlists, artists, albums, songs, genres, or composers) in random order.

Repeat Off: Turns off the repeat mode.

Repeat One Track: Repeats the current file.

U.S. models

iPhone use only

Playing Pandora®

Activate Pandora®, and connect the iPhone using your dock connector to the USB port, then press the **AUX** button.

➤ **USB Port** P. 189

Rating Icon

Album Art

VOL/⏻ (Power/volume) Knob

Press to turn the audio system on and off.
Turn to adjust the volume.

CATEGORY Bar

Press **+** to the next station.
Press **-** to the previous station.

BACK Button

Press to go back to the previous display.

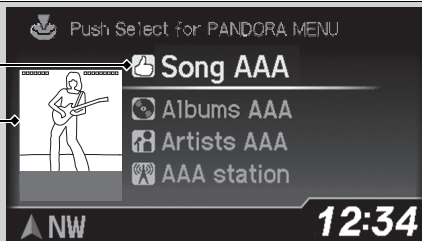

AUX Button

Press to select iPhone (if connected when the Pandora® application is activated).

SKIP Bar

Press **▶▶** to skip a song.

Selector Knob

Press to enter PANDORA MENU.
Press and turn to select an item, then press to set your selection.

SETUP Button

Press to display menu items.

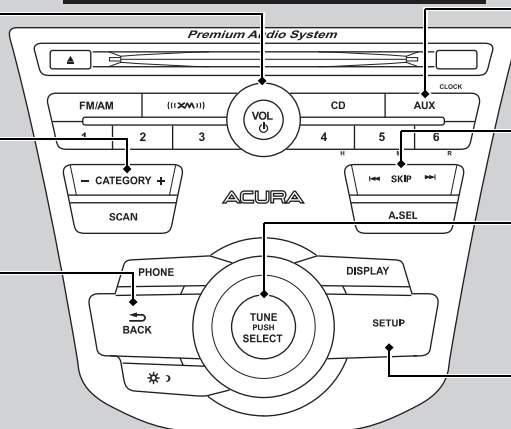





Pandora® Menu

You can operate some of the Pandora menu items from your vehicle's audio system. The available items are:

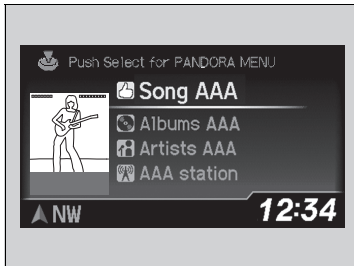
- **Station List** (**QuickMix** is also available)
- **Like**
- **Dislike**
- **Resume/Pause**
- **SKIP**
- **Bookmark this song**
- **Bookmark this artist**

■ Operating a menu item



1. Press  to display the **PANDORA MENU**.
2. Rotate  to select a menu.
3. Press  to display the items on that menu.

▶▶ Playing Pandora®

Pandora® is a personalized Internet radio service that selects music based on an artist, song, or genre a user enters, and streams what is likely to be of interest.

To use this service in your vehicle, the Pandora® app must first be installed on your iPhone. Visit www.pandora.com for more information.

If you cannot operate Pandora® through the audio system, it may be streaming through *Bluetooth*® Audio. Make sure Pandora® mode on your audio system is selected.

▶▶ Pandora® Menu

Available operating functions vary on software versions. Some functions may not be available on the vehicle's audio system.

If there is a problem, you may see an error message on the audio/information screen.

▶▶ **Pandora®** P. 219

You can skip the song or select **Dislike** only a predetermined number of times in an hour.

Playing a USB Flash Drive

Your audio system reads and plays sound files on a USB flash drive in either MP3, WMA or AAC*1 format.

Connect your USB flash drive to the USB port, then press the **AUX** button.

➔ **USB Port** P. 189

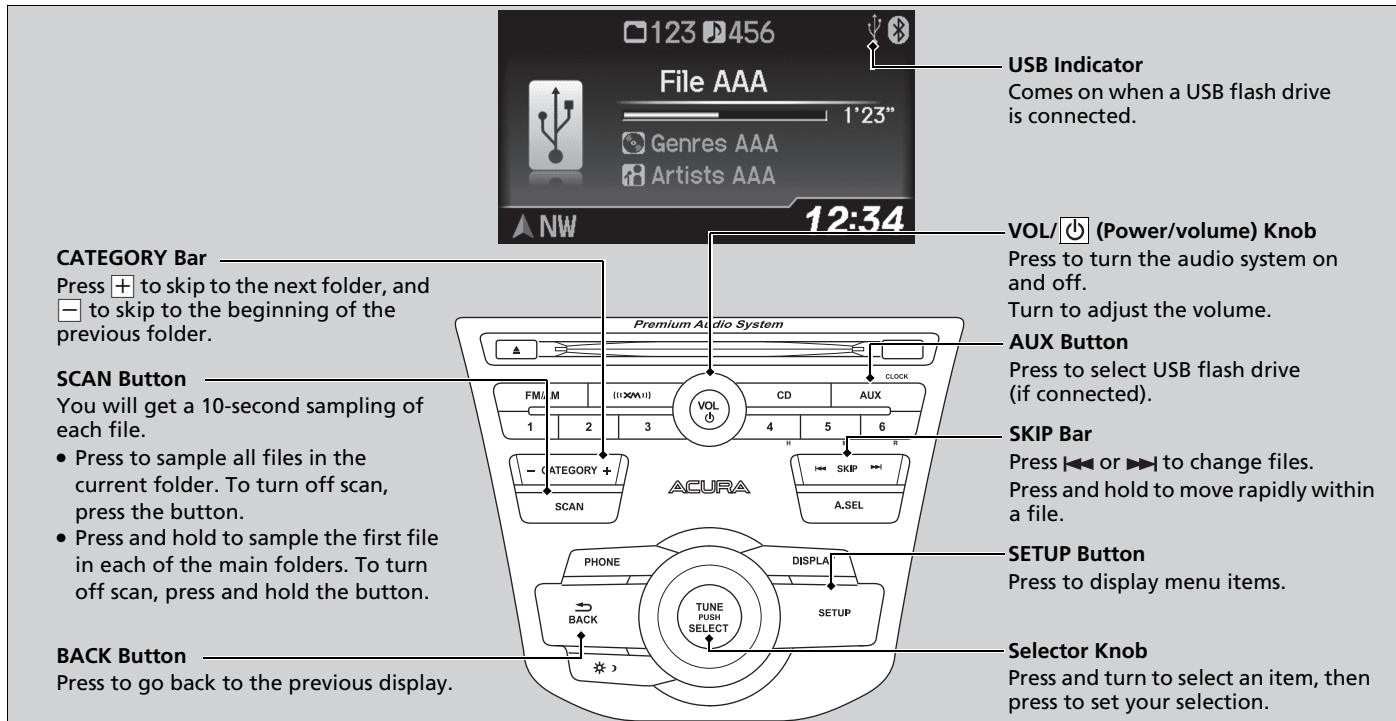

*1: Only AAC format files recorded with iTunes are playable on this unit.

How to Select a File from a Folder with the Selector Knob

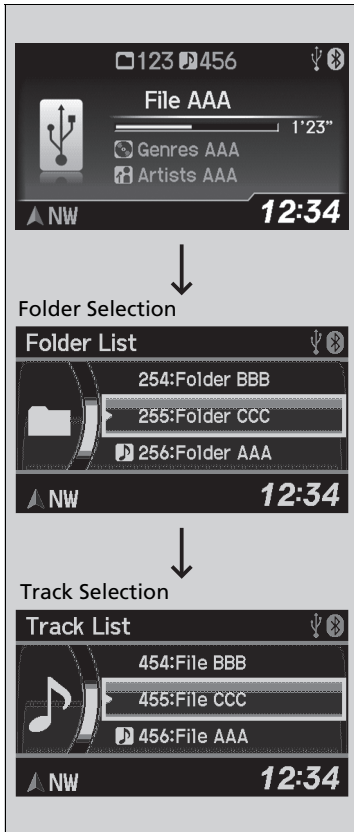

1. Press to switch the display to a folder list.
2. Rotate to select a folder.
3. Press to change the display to a list of files in that folder.
4. Rotate to select a file, then press .

▶▶ Playing a USB Flash Drive

Use the recommended USB flash drives.

▶ **General Information on the Audio System***
P. 220

Files in WMA format protected by digital rights management (DRM) are not played.

The audio system displays **Unplayable File**, and then skips to the next file.





If there is a problem, you may see an error message on the audio/information screen.

▶ **iPod/USB Flash Drive** P. 218

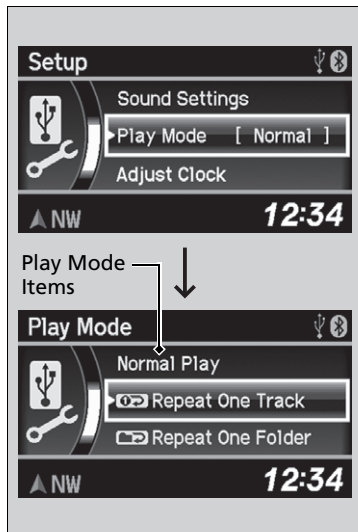



How to Select a Play Mode

You can select repeat and random modes when playing a file.



1. Press the **SETUP** button.
2. Rotate  to select **Play Mode**, then press .
3. Rotate  to select a mode, then press .

To turn off a play mode

1. Press the **SETUP** button.
2. Rotate  to select **Play Mode**, then press .
3. Rotate  to select **Normal Play**, then press .

How to Select a Play Mode

Play Mode Menu Items

Normal Play

Repeat One Track: Repeats the current file.

Repeat One Folder: Repeats all files in the current folder.

Random in Folder: Plays all files in the current folder in random order.

Random All: Plays all files in random order.

Playing *Bluetooth*® Audio

Your audio system allows you to listen to music from your *Bluetooth*-compatible phone.

This function is available when the phone is paired and linked to the vehicle's *Bluetooth*® HandsFreeLink® (HFL) system.

📖 **Phone Setup** P. 233

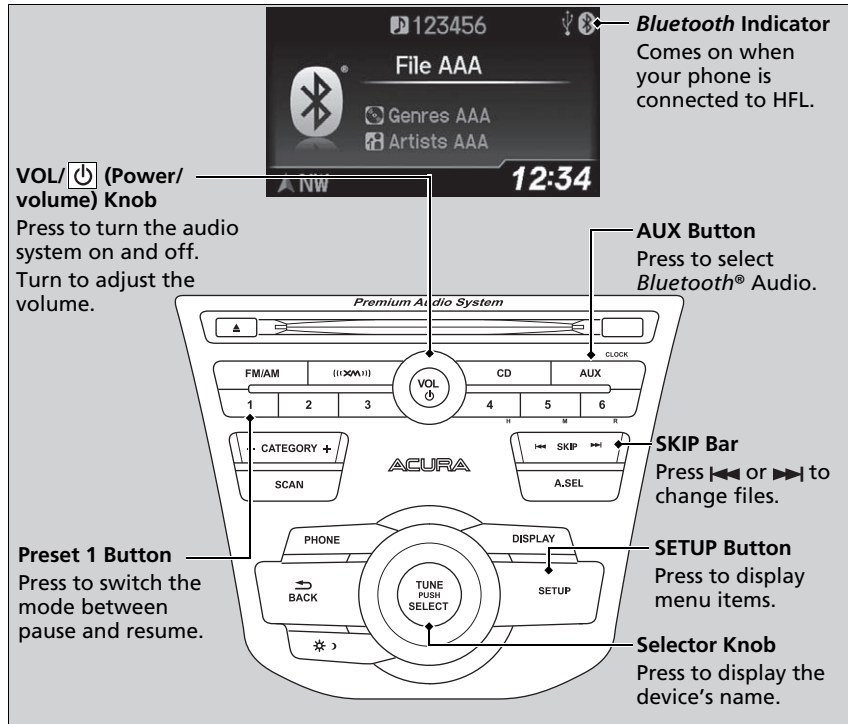

▶▶ Playing *Bluetooth*® Audio

Not all *Bluetooth*-enabled phones with streaming audio capabilities are compatible with the system.

For a list of compatible phones:

- U.S.: Visit www.acura.com/handsfreelink, or call 1-888-528-7876.
- Canada: Visit www.handsfreelink.ca, or call 1-888-528-7876.

In some states, it may be illegal to perform some data device functions while driving.

If more than one phone is paired to the HFL system, there will be a delay before the system begins to play.

Continued

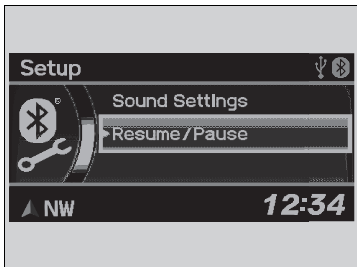

■ To Play *Bluetooth*® Audio Files



1. Make sure that your phone is paired and linked to HFL.
2. Press the **AUX** button.

If the phone is not recognized, another HFL-compatible phone, which is not compatible for *Bluetooth*® Audio, **may be** already linked.

■ To pause or resume a file

1. Press the **SETUP** button.
2. Rotate  to select **Resume/Pause**, then press .

Each time you press , the setting switches between Pause and Resume.

■ Switching to HFL

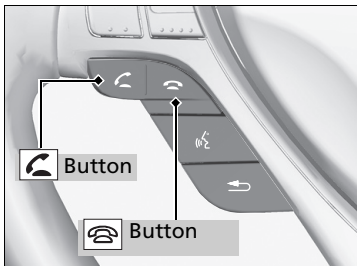

Press the  (pick-up) button on the steering wheel to receive a call when *Bluetooth*® Audio is playing.

 **Bluetooth**® HandsFreeLink® P. 226

Press the  (hang-up) button to end the call and return to *Bluetooth*® Audio.

▶▶ To Play *Bluetooth*® Audio Files

To play the audio files, you may need to operate your phone. If so, follow the phone manufacturer's operating instructions.

The pause function may not be available on some phones.

If any audio device is connected to the auxiliary input jack, you may need to press the **AUX** button repeatedly to select the *Bluetooth*® Audio system.



Switching to another mode pauses the music playing from your phone.

▶▶ Switching to HFL

If you receive a call while *Bluetooth*® Audio is in the pause mode, it will resume play after ending the call.

CD Player

If a disc error occurs, you may see the following error messages.

Error Message	Cause	Solution
Unplayable File	Track/file format not supported	<ul style="list-style-type: none"> • Current track/file will be skipped. The next supported track/file plays automatically.
Bad Disc Please check owners manual. Push Eject	Mechanical error	<ul style="list-style-type: none"> • Press the  (eject) button and remove the disc, and check that the error message is cleared. • Check that the disc is not damaged or deformed, and insert the disc again. <ul style="list-style-type: none"> ➤ Protecting CDs P. 222
Mecha Error		
Bad Disc Please check owners manual.	Servo error	<ul style="list-style-type: none"> • If the error message reappears, press the  button, and pull out the disc. • Insert a different disc. If the new disc plays, there is a problem with the first disc. • If the error message repeats, or the disc cannot be removed, contact a dealer. Do not try to force the disc out of the player.
Check Disc	Disc error	<ul style="list-style-type: none"> • Check that the disc is not damaged or deformed. <ul style="list-style-type: none"> ➤ Protecting CDs P. 222

* Not available on all models

iPod/USB Flash Drive

If an error occurs while playing an iPod or USB flash drive, you may see the following error messages. If you cannot clear the error message, contact a dealer.

Error Message	Solution
USB Error	Appears when there is a problem with the USB adapter unit. Check if the device is compatible with the USB adapter unit.
Bad USB Device Please Check Owners Manual.	Appears when an incompatible device is connected. Disconnect the device. Then turn the audio system off, and turn it on again. Do not reconnect the device that caused the error.
No Song	Appears when the iPod is empty. Check that compatible files are stored on the device.
Unsupported Ver	Appears when an unsupported iPod is connected. If it appears when a supported iPod is connected, update the iPod software to the newer version.
Retry Connection	Appears when the system does not acknowledge the iPod. Reconnect the iPod.
Unplayable File	Appears when the files in the USB flash drive are DRM or an unsupported format. This error message appears for about 3 seconds, then plays the next song.
No Data	Appears when the USB flash drive is empty or there are no MP3, WMA, or AAC files in the USB flash drive. Check that compatible files are stored on the device.
Unsupported	Appears when an unsupported device is connected. If it appears when a supported device is connected, reconnect the device.

U.S. models

Pandora®

If an error occurs while playing Pandora®, you may see the following error messages.

If you cannot clear the error message, contact a dealer.

Error Message	Solution
PANDORA No Station	Appears when there is no station list on the device. Use the device to create a station.
PANDORA Requires Update	Appears when Pandora version is not supported. Please update the device application.
PANDORA Unavailable	Appears when Pandora is performing system maintenance. Try again later.
PANDORA Cannot Connect	Appears when Pandora is unable to play music. Check your device.
PANDORA Loading...	Appears when Pandora is loading.

SiriusXM® Radio Service

Subscribing to SiriusXM® Radio

1. You need your radio ID ready before registering for subscription. To see the ID in the display: Turn the selector knob until **0** appears.
2. Have your radio ID and credit card number ready, and either call or visit the SiriusXM® website to subscribe.

Receiving SiriusXM® Radio

Press the **(SiriusXM®)** (SiriusXM®) button and stay in this mode for about 30 minutes until the service is activated. Make sure your vehicle is in an open area with good reception.

SiriusXM® Radio Display Messages

Loading...:

SiriusXM® is loading the audio or program information.

Channel Off Air:

The channel is not currently broadcasting.

Channel Not Authorized:

SiriusXM® radio is receiving information update from the network.

No Signal:

The signal is too weak in the current location.

-----:

No such channel exists, the channel is not part of your subscription, or the artist or title information is unavailable.

Check Antenna:

There is a problem with the SiriusXM® antenna. Contact a dealer.

Subscribing to SiriusXM® Radio

Contact Information for SiriusXM® Radio:

US: SiriusXM® Radio at www.siriusxm.com or (800) 852-9696

Canada: SiriusXM® Canada at www.siriusxm.ca, or (877) 209-0079

Receiving SiriusXM® Radio

The SiriusXM® satellites are in orbit over the equator; therefore, objects south of the vehicle may cause satellite reception interruptions. Satellite signals are more likely to be blocked by tall buildings and mountains the farther north you travel from the equator.

You may experience reception problems under the following circumstances:

- In a location with an obstruction to the south of your vehicle.
- In tunnels
- On the lower level of a multi-tiered road
- Large items carried on the roof rack

Recommended CDs

- Use only high-quality CD-R or CD-RW discs labeled for audio use.
- Use only CD-R or CD-RW discs on which the recordings are closed.
- Play only standard round-shaped CDs.

The CD packages or jackets should have one of these marks.



CDs with MP3, WMA or AAC files

- Some software files may not allow for audio play or text data display.
- Some versions of MP3, WMA or AAC formats may be unsupported.

Recommended CDs

A Dual-disc cannot play on this audio unit. If recorded under certain conditions, a CD-R or CD-RW may not play either.

Continued

■ Protecting CDs

Follow these precautions when handling or storing CDs:

- Store a CD in its case when it is not being played.
- When wiping a CD, use a soft clean cloth from the center to the outside edge.
- Handle a CD by its edge. Never touch either surface.
- Never insert foreign objects into the CD player.
- Keep CDs out of direct sunlight and extreme heat.
- Do not place stabilizer rings or labels on the CD.
- Avoid fingerprints, liquids, and felt-tip pens on the CD.

▶▶ Protecting CDs

NOTICE

Do not insert a damaged CD. It may be stuck inside and damage the audio unit.

Examples:

- Bubbled, wrinkled, labeled, and excessively thick CDs



Bubbled/
Wrinkled



With Label/
Sticker



Using
Printer Label
Kit



Sealed



With Plastic Ring

- Damaged CDs



Chipped/
Cracked



Warped



Burrs

- Poor quality CDs

- Small CDs



3-inch (8-cm) CD

Compatible iPod, iPhone, and USB Flash Drives

■ iPod and iPhone Model Compatibility

Model
iPod (5th generation)
iPod classic 80GB/160GB (launch in 2007)
iPod classic 120GB (launch in 2008)
iPod classic 160GB (launch in 2009)
iPod nano (1st to 7th generation*) *launch in 2012
iPod touch (1st to 5th generation*) *launch in 2012
iPhone 3G/iPhone 3GS/iPhone 4/iPhone 4s/iPhone 5/iPhone 5s/iPhone 5c

■ USB Flash Drives

- Use a recommended USB flash drive of 256 MB or higher.
- Some digital audio players may not be compatible.
- Some USB flash drives (e.g., a device with security lockout) may not work.
- Some software files may not allow for audio play or text data display.
- Some versions of MP3, WMA, or AAC formats may be unsupported.

⌘ iPod and iPhone Model Compatibility

This system may not work with all software versions of these devices.

⌘ USB Flash Drives

Files on the USB flash drive are played in their stored order. This order may be different from the order displayed on your PC or device.

The HomeLink® Universal Transceiver can be programmed to operate up to three remote controlled devices around your home, such as garage doors, lighting, or home security systems.

■ Important Safety Precautions

Refer to the safety information that came with your garage door opener to test that the safety features are functioning properly. If you do not have the safety information, contact the manufacturer.

Before programming HomeLink, make sure that people and objects are out of the way of the garage or gate to prevent potential injury or damage.

When programming a garage door opener, park just outside the garage door's path.

Training HomeLink

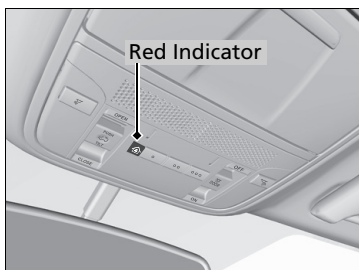

If you have not trained any of the buttons in HomeLink before, you should erase any previously learned codes. To do this:

- Press and hold the two outside buttons for about 20 seconds, until the red indicator blinks. Release the buttons, and proceed to step 1.
- If you are training the second or third button, go directly to step 1.

HomeLink® Universal Transceiver

HomeLink® is a registered trademark of Gentex Corporation.

Before programming HomeLink to operate a garage door opener, confirm that the opener has an external entrapment protection system, such as an "electronic eye," or other safety and reverse stop features. If it does not, HomeLink may not be able to operate it.

Training a Button

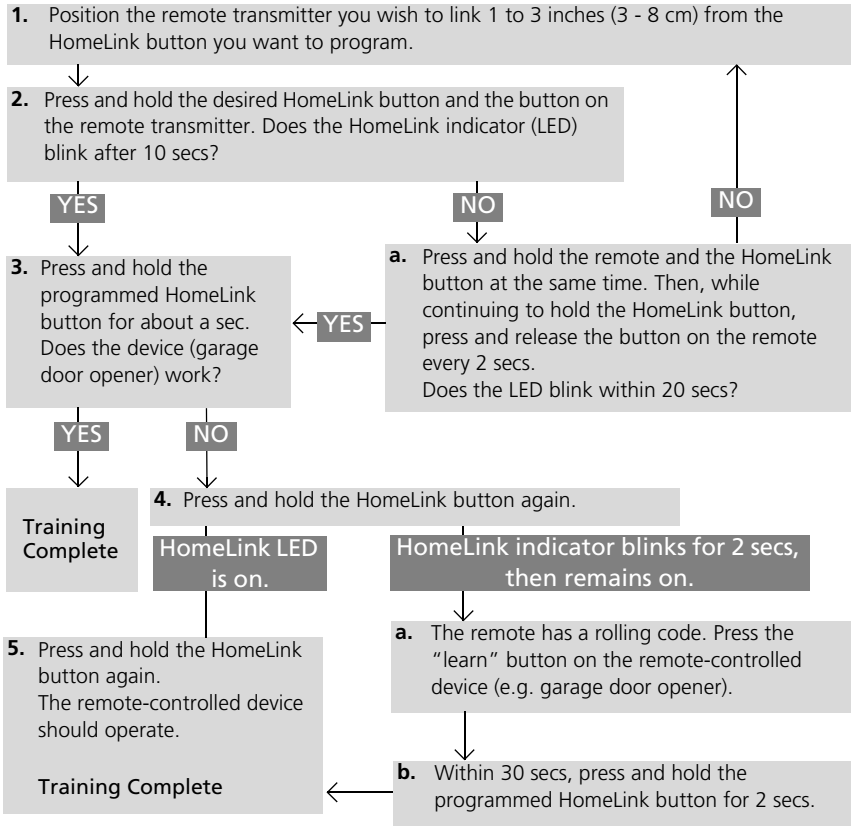

Training HomeLink

Retraining a Button
 If you want to retrain a programmed button for a new device, you do not have to erase all button memory. You can replace the existing memory code using this procedure:

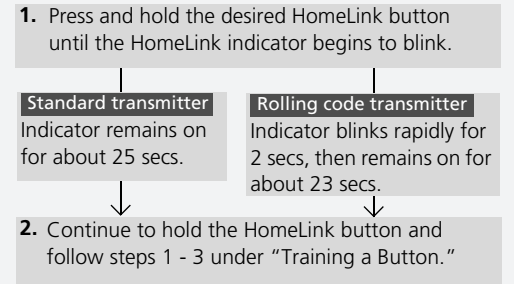

Erasing Codes
 To erase all the codes, press and hold the two outside buttons until the HomeLink indicator begins to blink (about 10 to 20 secs). You should erase all codes before selling the vehicle.

If you have any problems, see the device's instructions, visit www.homelink.com, or call HomeLink at (800) 355-3515.

Models with navigation system

For models with navigation system, see Navigation System Manual for how to operate *Bluetooth*® HandsFreeLink®.

Models without navigation system

Bluetooth® HandsFreeLink® (HFL) allows you to place and receive phone calls using your vehicle's audio system, without handling your cell phone.

Using HFL

HFL Buttons

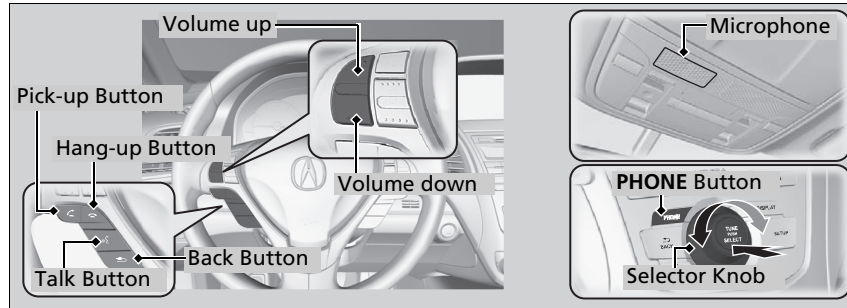



 **(Pick-up) button:** Press to go directly to the **Phone** screen or to answer an incoming call.

 **(Hang-up) button:** Press to end a call.

 **(Talk) button:** Press to call a number with a stored voice tag.

 **(Back) button:** Press to cancel a command.

PHONE button: Press to go directly to the **Phone** screen.

Selector knob: Rotate  to select an item on the screen, then press .

Bluetooth® HandsFreeLink®

To use HFL, you need a *Bluetooth*-compatible cell phone. For a list of compatible phones, pairing procedures, and special feature capabilities:

- U.S.: Visit www.acura.com/handsfreelink, or call 1-888-528-7876.
- Canada: Visit www.handsfreelink.ca, or call 1-888-528-7876.

Voice control tips

- Aim the vents away from the ceiling and close the windows, as noise coming from them may interfere with the microphone.
- Press and release the  button when you want to call a number using a stored voice tag. Speak clearly and naturally after a beep.
- If the microphone picks up voices other than yours, the command may be misinterpreted.
- To change the volume level, use the audio system's volume knob or the remote audio controls on the steering wheel.

State or local laws may prohibit the operation of handheld electronic devices while operating a vehicle.

HFL Status Display

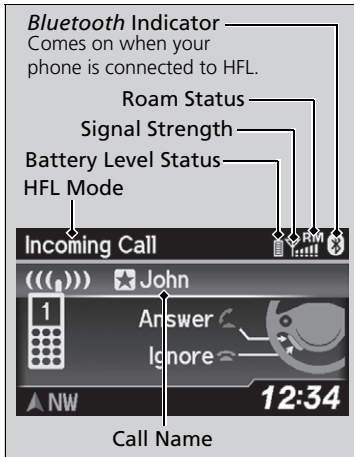

The audio/information screen notifies you when there is an incoming call.

Limitations for Manual Operation

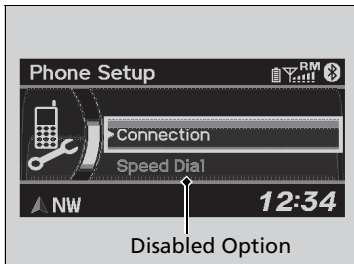

Certain manual functions are disabled or inoperable while the vehicle is in motion. You cannot select a grayed-out option until the vehicle is stopped.

Only previously stored speed dial entries with voice tags can be called using the talk button while the vehicle is in motion.

▶ **Speed Dial** P. 243

Bluetooth® HandsFreeLink®

Bluetooth® Wireless Technology

The *Bluetooth*® word mark and logos are registered trademarks owned by *Bluetooth* SIG, Inc., and any use of such marks by Honda Motor Co., Ltd., is under license. Other trademarks and trade names are those of their respective owners.

HFL Limitations

An incoming call on HFL will interrupt the audio system when it is playing. It will resume when the call is ended.

HFL Status Display

The information that appears on the audio/information screen varies between phone models.

You can change the system language to English, French, or Spanish.

▶ **Language Selection** P. 195

HFL Menus

The power mode must be in ACCESSORY or ON to use HFL.

PHONE or 

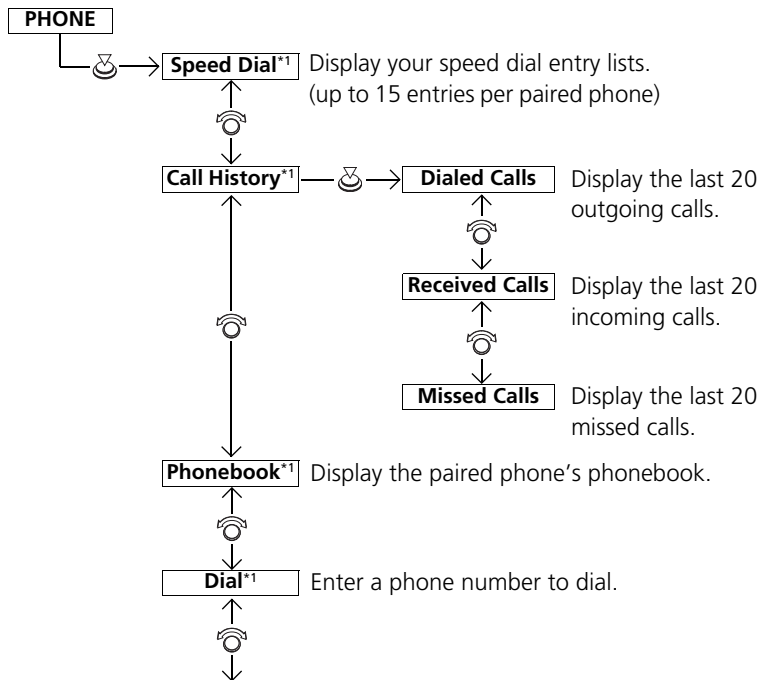

HFL Menus

To use HFL, you must first pair your *Bluetooth*-compatible cell phone to the system while the vehicle is parked.

Some functions are limited while driving. A message appears on the screen when the vehicle is moving and the operation is canceled.

*1: Appears only when a phone is connected to HFL.

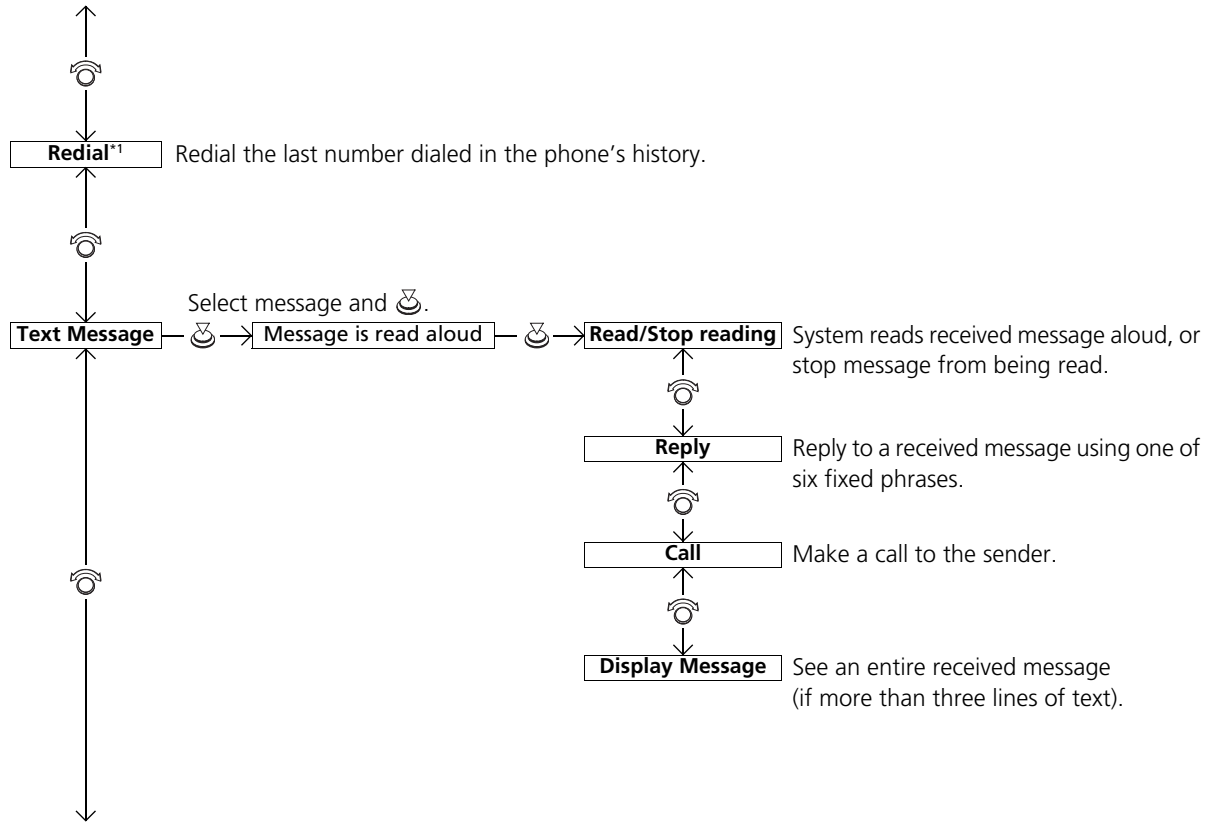

*1: Appears only when a phone is connected to HFL.

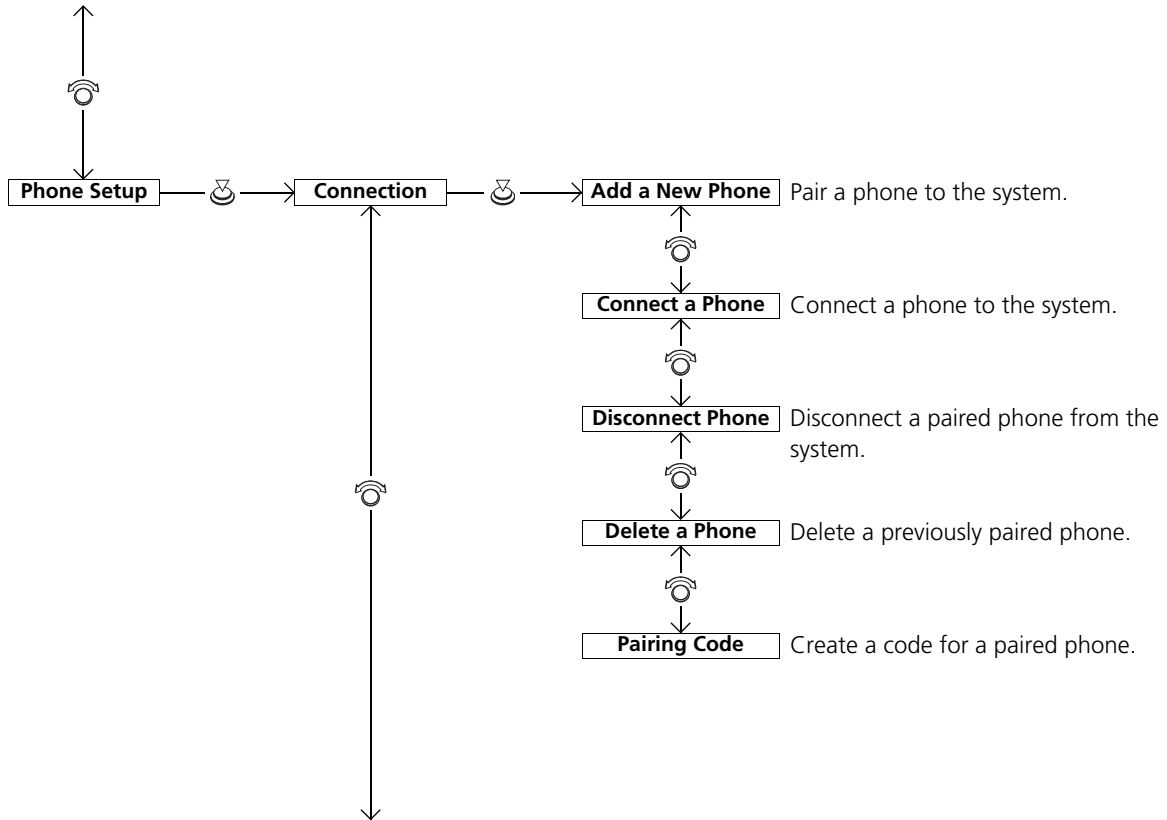

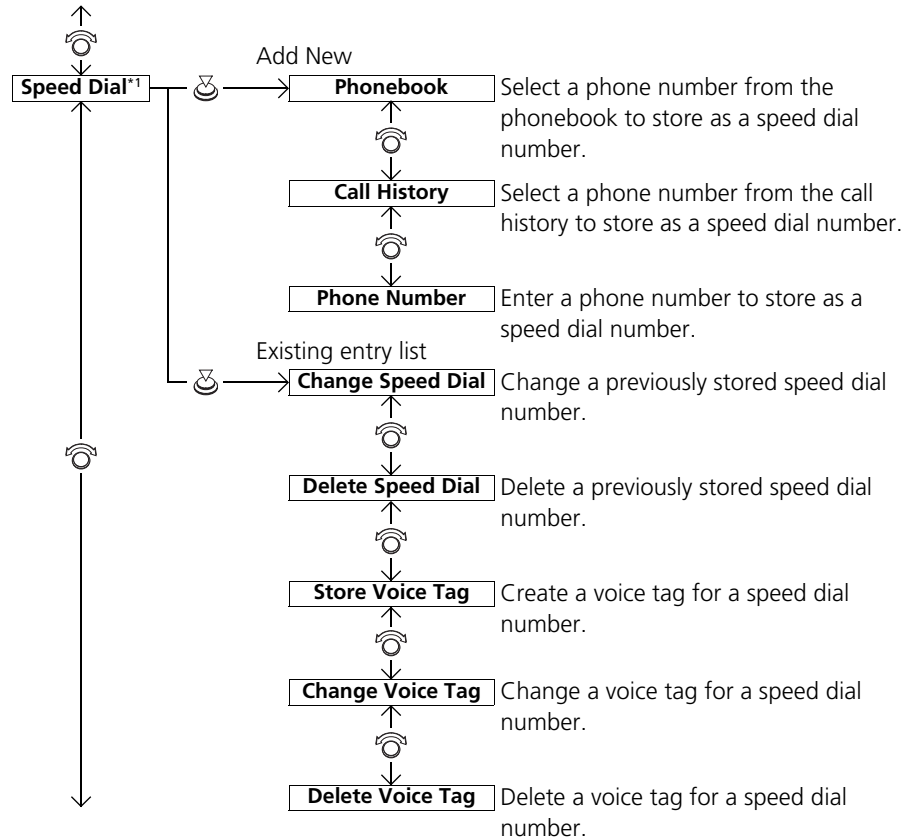

*1: Appears only when a phone is connected to HFL.

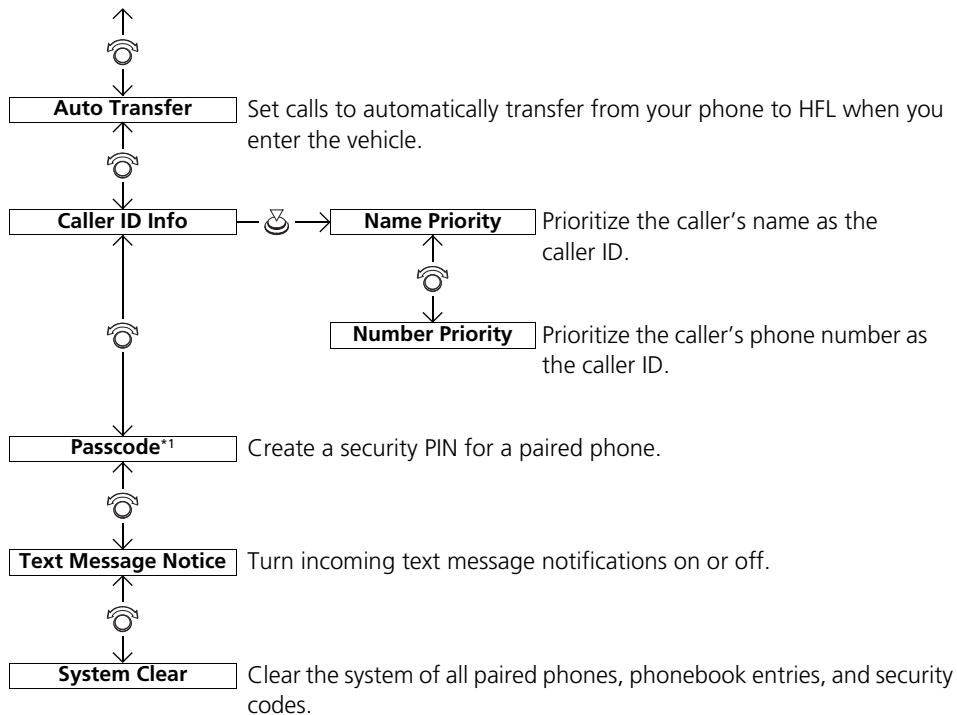



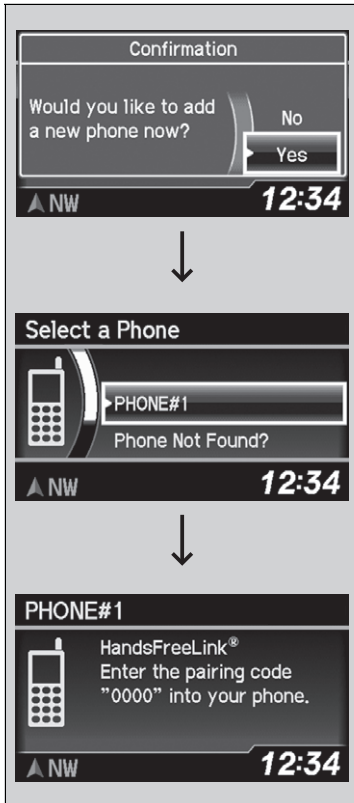

*1: Appears only when a phone is connected to HFL.

Phone Setup



■ To pair a cell phone (when there is no phone paired to the system)

1. Press the **PHONE** button or the  button.
2. Rotate  to select **Yes**, then press .
3. Make sure your phone is in search or discoverable mode, then press .
 - ▶ HFL automatically searches for a *Bluetooth* device.
4. When your phone appears on the list, select it by pressing .
 - ▶ If your phone doesn't appear, select **Phone Not Found?** and search for *Bluetooth* devices using your phone. From your phone, select **HandsFreeLink**.
5. HFL gives you a four-digit pairing code to input on your phone. When your phone prompts you, input the four-digit pairing code.
6. You will receive a notification on the screen if pairing is successful.

☒ Phone Setup

Your *Bluetooth*-compatible phone must be paired to HFL before you can make and receive hands-free calls.

Phone Pairing Tips:

- You cannot pair your phone while the vehicle is moving.
- Up to six phones can be paired.
- Your phone's battery may drain faster when it is paired to HFL.
- If your phone is not ready for pairing or not found by the system within three minutes, the system will time out and returns to idle.

Once you have paired a phone, you can see it displayed on the screen with one or two icons on the right side.

These icons indicate the following:







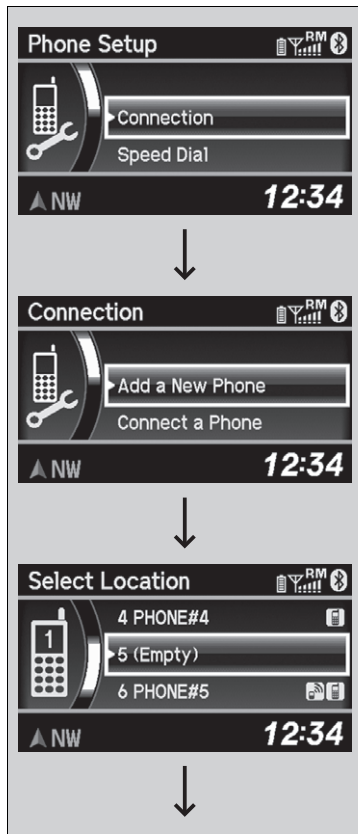

: The phone can be used with HFL.

: The phone is compatible with *Bluetooth*® Audio.

Continued



■ **To pair a cell phone (when a phone has already been paired to the system)**

1. Press the **PHONE** button or the  button.
 - ▶ If a prompt appears asking to connect to a phone, select **No** and proceed with step 2.
2. Rotate  to select **Phone Setup**, then press .
3. Rotate  to select **Connection**, then press .
4. Rotate  to select **Add a New Phone**, then press .
 - ▶ The screen changes to **Select Location**.
5. Rotate  to select **Empty**, then press .

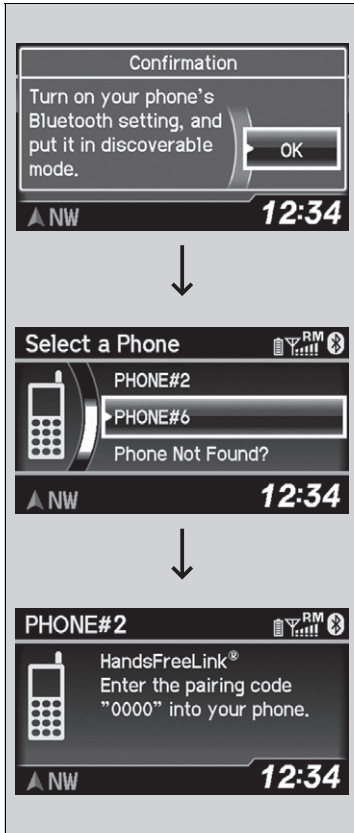

6. Make sure your phone is in search or discoverable mode, then press .
 - ▶ HFL automatically searches for a *Bluetooth* device.
7. When your phone appears on the list, select it by pressing .
 - ▶ If your phone doesn't appear, select **Phone Not Found?** and search for *Bluetooth* devices using your phone. From your phone, select **HandsFreeLink**.
8. HFL gives you a four-digit pairing code to input on your phone. When your phone prompts you, input the four-digit pairing code.
9. You will receive a notification on the screen if pairing is successful.

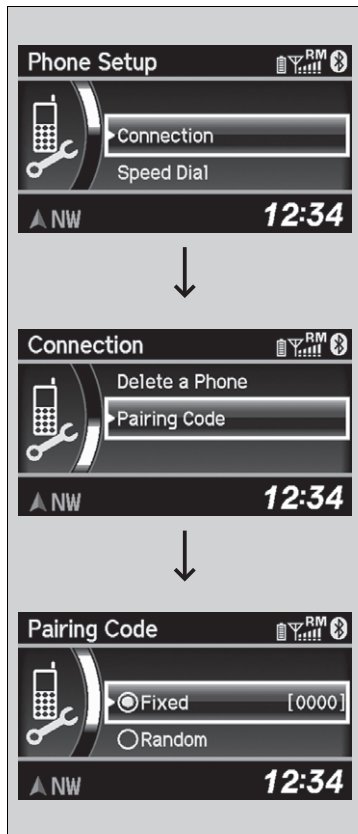

■ To change the pairing code setting

1. Press the **PHONE** button or the button.
2. Rotate to select **Phone Setup**, then press .
3. Rotate to select **Connection**, then press .
4. Rotate to select **Pairing Code**, then press .
5. Rotate to select **Fixed** or **Random**, then press .

▶▶ To change the pairing code setting





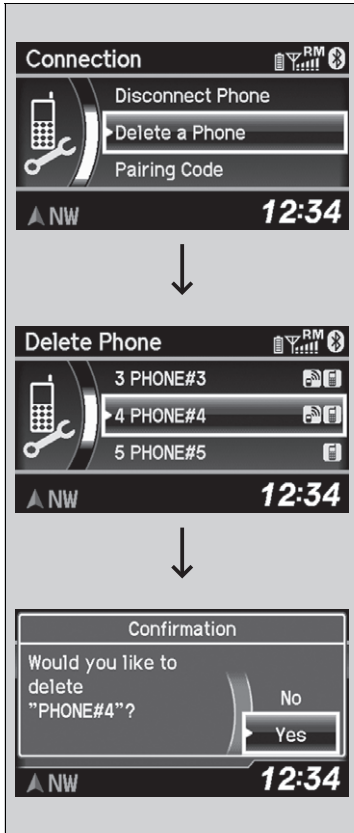

The default pairing code is "0000" until you change the setting.

To create your own, select **Fixed**, and delete the current code, then enter a new one.

For a randomly generated pairing code each time you pair a phone, select **Random**.



■ **To delete a paired phone**

1. Press the **PHONE** button or the  button.
2. Rotate  to select **Phone Setup**, then press .
 - ▶ Repeat the procedure to select **Connection**, then **Delete a Phone**.
3. Rotate  to select a phone you want to delete, then press .
4. You will receive a confirmation message on the screen. Rotate  to select **Yes**, then press .
 - ▶ You will receive a notification on the screen if it is successful.

■ To Set Up a Message Notice Option

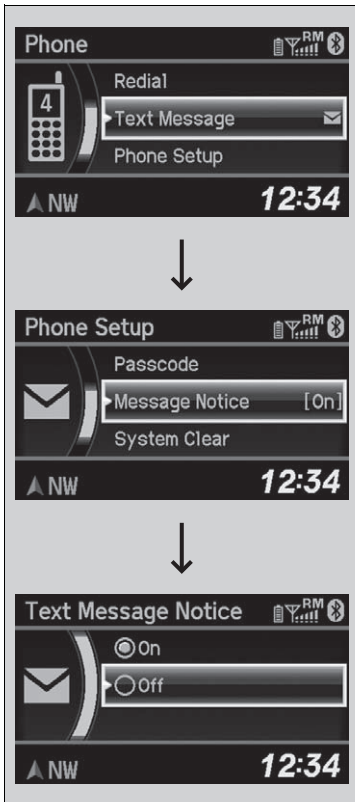

1. Press the **PHONE** button or the button.
2. Rotate to select **Phone Setup**, then press .
3. Rotate to select **Message Notice**, then press .
4. Rotate to select a mode you want, then press .

▶▶ To Set Up a Message Notice Option









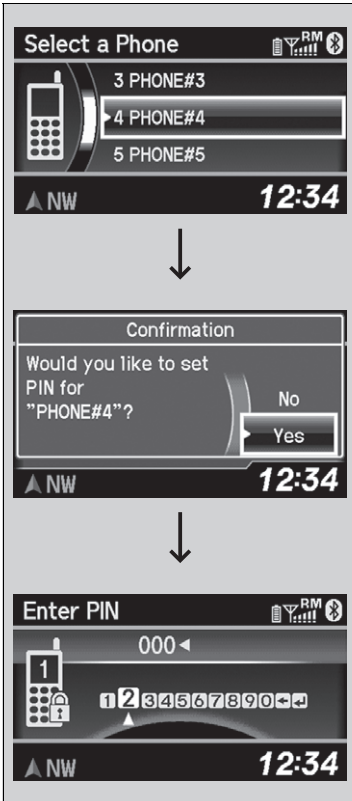

On: A pop-up notification comes on every time you receive a new text message.

Off: The message you receive is stored in the system without notification.

■ To Create a Security PIN

You can protect each of the six cell phones with a security PIN.



1. Press the **PHONE** button or the  button.
2. Rotate  to select **Phone Setup**, then press .
 - ▶ Repeat the procedure to select **Passcode**.
3. Select a phone you want to add a security PIN to.
 - ▶ Rotate  to select a phone you want to add a security PIN to, then press .
4. You will receive a confirmation message on the screen.
 - ▶ Rotate  to select **Yes**, then press .
5. Enter a new four-digit number.
 - ▶ Rotate  to select, then press . Press  to delete. Press  to enter the security PIN.
6. Re-enter the four-digit number.
 - ▶ The screen returns to the screen in step 2.

▶▶ To Create a Security PIN

In the phone is already security PIN protected, you need to enter the current security PIN before clearing the PIN or creating a new one.

■ Automatic Transferring

If you get into the vehicle while you are on the phone, the call can be automatically transferred to HFL.

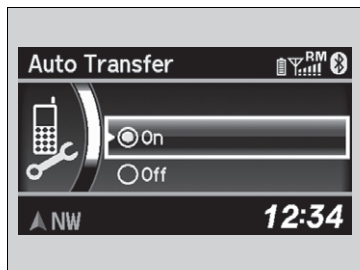

1. Press the **PHONE** button or the button.
2. Rotate to select **Phone Setup**, then press .
 - ▶ Repeat the procedure to select **Auto Transfer**.
3. Rotate to select **On**, then press .
4. You will receive a notification on the screen if the change is successful.

■ Caller's ID Information

You can select a caller's information to be displayed when you have an incoming call.



1. Press the **PHONE** button or the button.
2. Rotate to select **Phone Setup**, then press .
 - ▶ Repeat the procedure to select **Caller ID Info**.
3. Rotate to select a mode you want, then press .
4. You will receive a notification on the screen if the change is successful.

☒ Caller's ID Information

Name Priority mode: A caller's name is displayed if it is stored in the phonebook.

Number Priority mode: A caller's phone number is displayed.

■ To Clear the System

Security codes, paired phones, all stored voice tags, all speed dial entries, and all imported phonebook data are erased.

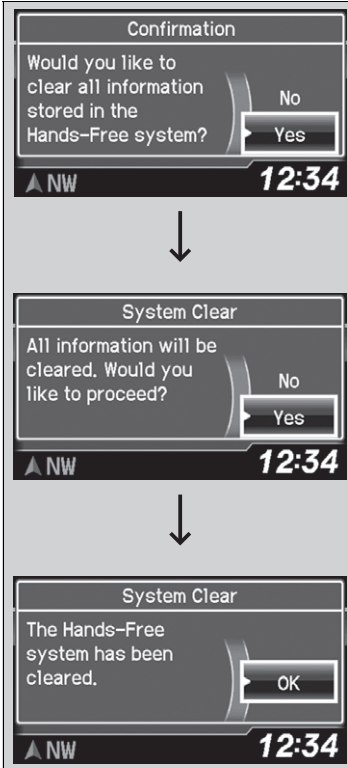

1. Press the **PHONE** button or the button.
2. Rotate to select **Phone Setup**, then press .
 - ▶ Repeat the procedure to select **System Clear**.
3. Rotate to select **Yes**, then press .
4. You will receive a notification message on the screen. Rotate to select **Yes**, then press .
5. You will receive a notification message on the screen. Rotate to finish.

■ Automatic Import of Cellular Phonebook and Call History

When your phone is paired, the contents of its phonebook and call history are automatically imported to HFL.

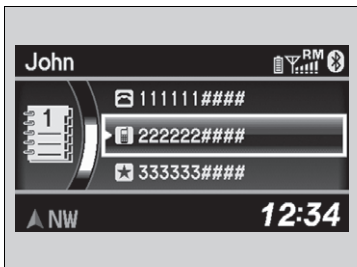

▶ Automatic Import of Cellular Phonebook and Call History

When you select a person from the list in the cellular phonebook, you can see up to three category icons. The icons indicate what types of numbers are stored for that name.



On some phones, it may not be possible to import the category icons to HFL.

The phonebook is updated after every connection. Call history is updated after every connection or call.

Speed Dial

Up to 15 speed dial numbers can be stored per phone.

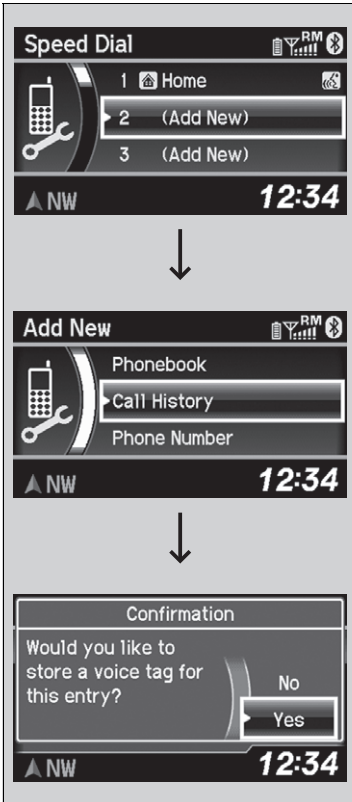

To store a speed dial number:

1. Press the **PHONE** button or the button.
2. Rotate to select **Phone Setup**, then press .
 - ▶ Repeat the procedure to select **Speed Dial**, then **Add New**.
3. Rotate to select a place to choose a number from, then press .
 - By **Phonebook**:
 - ▶ Select a number from the linked cell phone's imported phonebook.
 - By **Call History**:
 - ▶ Select a number from the call history.
 - By **Phone Number**:
 - ▶ Input the number manually.
4. When the speed dial is successfully stored, you are asked to create a voice tag for the number. Rotate to select **Yes** or **No**, then press .
5. Using the button, follow the prompts to say the name for the speed dial entry.

Speed Dial

You can use the audio preset buttons during a call to store a speed dial number:

1. Press and hold the desired audio preset button during a call.
2. The contact information for the active call will be stored for the corresponding speed dial.

When a voice tag is stored, press the button to call the number using the voice tag.

Continued

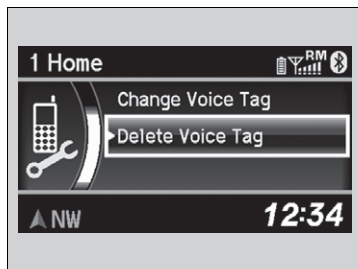

■ **To add a voice tag to a stored speed dial number**

1. Press the **PHONE** button or the button.
2. Rotate to select **Phone Setup**, then press .
 - ▶ Repeat the procedure to select **Speed Dial**.
3. Select an existing speed dial entry.
4. Rotate to select **Store Voice Tag**, then press .
5. Using the button, follow the prompts to complete the voice tag.

■ **To delete a voice tag**

1. Press the **PHONE** button or the button.
2. Rotate to select **Phone Setup**, then press .
 - ▶ Repeat the procedure to select **Speed Dial**.
3. Select an existing speed dial entry.
4. Rotate to select **Delete Voice Tag**, then press .
 - ▶ You will receive a confirmation message on the screen. Rotate to select **Yes**, then press .

▶▶ Speed Dial

Avoid using duplicate voice tags.
 Avoid using "home" as a voice tag.
 It is easier for HFL to recognize a longer name. For example, use "John Smith" instead of "John."

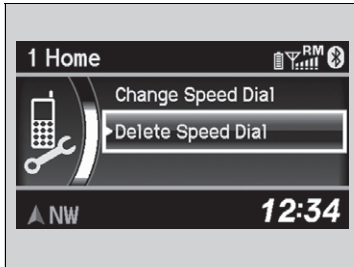

■ To delete a speed dial number

1. Press the **PHONE** button or the button.
2. Rotate to select **Phone Setup**, then press .
 - ▶ Repeat the procedure to select **Speed Dial**.
3. Select an existing speed dial entry.
4. Rotate to select **Delete Speed Dial**, then press .
 - ▶ You will receive a confirmation message on the screen. Rotate to select **Yes**, then press .

■ Making a Call

You can make calls by inputting any phone number, or by using the imported phonebook, call history, speed dial entries, or redial.

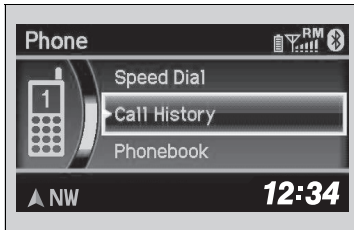

☒ Making a Call

Any voice-tagged speed dial entry can be dialed by voice from any screen.

Press the button and follow the prompts.

The maximum range between your phone and vehicles is 30 feet (10 meters).

Once a call is connected, you can hear the voice of the person you are calling through the audio speakers.

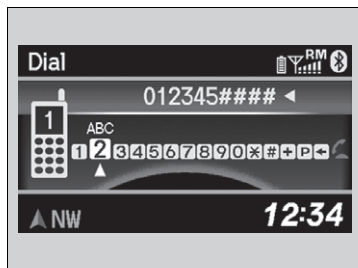
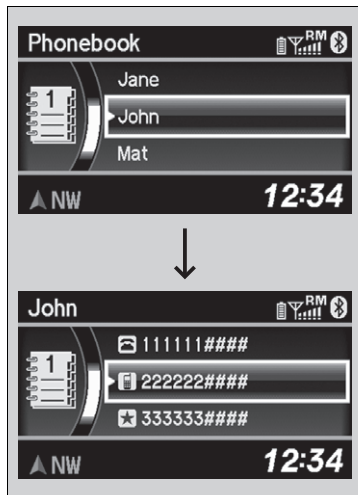

■ To make a call using the imported phonebook

When your phone is paired, the contents of its phonebook are automatically imported to HFL.

1. Press the **PHONE** button or the button.
2. Rotate to select **Phonebook**, then press .
3. The phonebook is stored alphabetically. Rotate to select the initial, then press .
4. Rotate to select a name, then press .
5. Rotate to select a number, then press .
 - ▶ Dialing starts automatically.

■ To make a call using a phone number

1. Press the **PHONE** button or the button.
2. Rotate to select **Dial**, then press .
3. Rotate to select a number, then press .
4. Rotate to select , then press .
 - ▶ Dialing starts automatically.

▶▶ To make a call using the imported phonebook

This function is disabled while the vehicle is moving. However, you can call a stored voice-tagged speed dial number using the talk button.

- ▶ **Limitations for Manual Operation** P. 227
- ▶ **Speed Dial** P. 243

▶▶ To make a call using a phone number

This function is disabled while the vehicle is moving. However, you can call a stored voice-tagged speed dial number using the talk button.

- ▶ **Limitations for Manual Operation** P. 227
- ▶ **Speed Dial** P. 243



■ **To make a call using redial**

1. Press the **PHONE** button or the button.
2. Rotate to select **Redial**, then press .
- ▶ Dialing starts automatically.

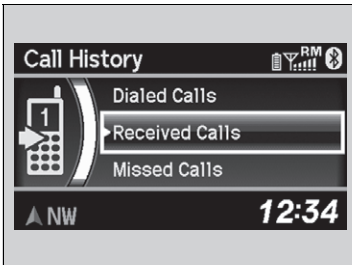

■ **To make a call using the call history**

Call history is stored by **Dialed Calls**, **Received Calls**, and **Missed Calls**.

1. Press the **PHONE** button or the button.
2. Rotate to select **Call History**, then press .
3. Rotate to select **Dialed Calls**, **Received Calls**, or **Missed Calls**, then press .
4. Rotate to select a number, then press .
- ▶ Dialing starts automatically.

■ **To make a call using a speed dial entry**

1. Press the **PHONE** button or the button.
2. Rotate to select **Speed Dial**, then press .
3. Rotate to select a number, then press .
- ▶ Dialing starts automatically.

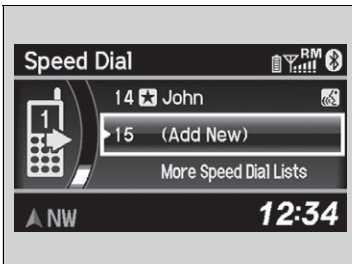

☒ To make a call using the call history

The call history displays the last 20 dialed, received, or missed calls.
(Appears only when a phone is connected to HFL.)

☒ To make a call using a speed dial entry

On the **Phone** screen, the first six speed dials on the list can be directly selected by pressing the corresponding audio preset buttons (1-6).

Select **More Speed Dial Lists** to view another paired phone's speed dial list. You can make a call from that list using the currently connected phone.

When a voice tag is stored, press the button to call the number using the voice tag.

▶ **Speed Dial** P. 243

Any voice-tagged speed dial entry can be dialed by voice from any screen.

Press the button and follow the prompts.

Continued

Receiving a Call

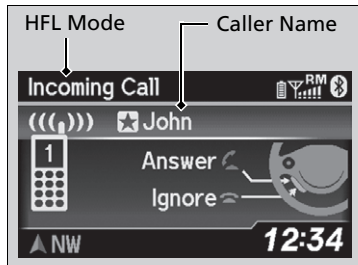

When there is an incoming call, an audible notification sounds (if activated) and the Incoming Call screen appears.

Press the  button to answer the call.

Press the  button to decline or end the call.

Receiving a Call

Call Waiting

Press the  button to put the current call on hold to answer the incoming call.

Press the  button again to return to the current call.

Ignore the incoming call if you do not want to answer it.

Press the  button if you want to hang up the current call.

Options During a Call



The following options are available during a call.

Mute: Mute your voice.

Transfer Call: Transfer a call from HFL to your phone.

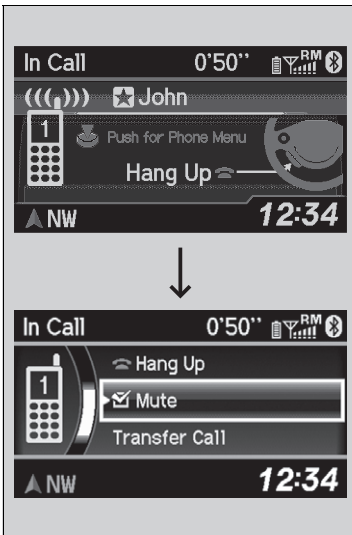
Touch Tones: Send numbers during a call. This is useful when you call a menu-driven phone system.



1. To view the available options, press the **PHONE** button.
2. Rotate  to select the option, then press .
 - ▶ The check box is checked when **Mute** is selected. Select **Mute** again to turn it off.



Options During a Call

Touch Tones: Available on some phones.

■ Receiving a Text Message

HFL can display newly received text messages as well as 20 of the most recently received messages on a linked cell phone. Each received message can be read aloud and replied to using a fixed common phrase.



1. A pop-up appears and notifies you of a new text message.
2. Rotate  to select **Yes** to listen to the message, then press .
 - ▶ The text message is displayed. The system automatically starts reading out the message.
3. To discontinue the message read-out, press the **BACK** button.

▶▶ Receiving a Text Message

Not all phones are compatible with this feature. Check handsfreelink.com for a list of compatible phones.

The system does not display any received messages while you are driving. You can only hear them read aloud.

With some phones, you may be able to display upto 20 most recent text messages.

Only the first three lines of the received message are displayed with this option.

▶ **Displaying an entire message** P. 254

State or local laws may limit your use of the HFL text message feature. Only use the text message feature when conditions allow you to do so safely.

Displaying Messages

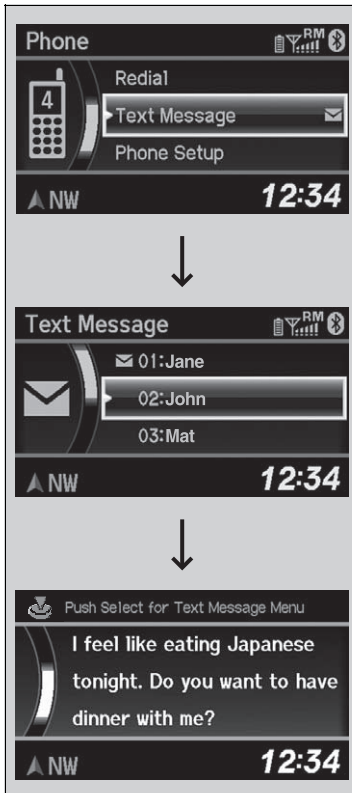

1. Press the **PHONE** button or the button.
2. Rotate to select **Text Message**, then press .
3. Rotate to select a message, then press .
 - ▶ The text message is displayed. The system automatically starts reading the message aloud.

Displaying Messages

The icon appears next to an unread message.

Only the first three lines of the received message are displayed with this option.







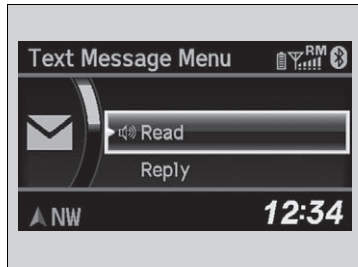

Displaying an entire message P. 254

If you delete a message on the phone, the message is also deleted in the system. If you send a message from the system, the message goes to your phone's outbox.

Continued



■ Using the stop reading or read option

1. Press the **PHONE** button or the  button.
2. Rotate  to select **Text Message**, then press .
3. Rotate  to select a message, then press .
 - ▶ The text message is displayed. The system automatically starts reading the message aloud.
4. Press  to enter the **Text Message Menu**.
5. Rotate  to select **Stop Reading** or **Read**, then press .

▣ Using the stop reading or read option

This option changes to:

- **Stop Reading** while the text message is read out. Select this option to discontinue the message read-out.
- **Read** when you go to the **Text Message** menu, or after you selected **Stop Reading**. Select this option to hear the system reading out the selected message.



■ Reply to a message

You can reply to a message using one of the six common phrases available in the system.

1. Press the **PHONE** button or the button.
2. Rotate to select **Text Message**, then press .
3. Rotate to select a message, then press .
 - ▶ The text message is displayed. The system automatically starts reading out the message.
4. Press to enter the **Text Message Menu**.
5. Rotate to select **Reply**, then press .
6. Rotate to select the reply message, then press .
7. The reply message you selected is displayed. Select **Yes** to send the message.

▶ Reply to a message

The available fixed reply messages are as follows:

- **Talk to you later, I'm driving.**
- **I am on my way.**
- **I'm running late.**
- **OK**
- **Yes**
- **No**

You cannot add, edit, or delete reply messages.

Only certain phones receive and send messages when paired and connected. For a list of compatible phones:

- U.S.: Visit www.handsfreelink.honda.com, or call 1-888-528-7876.
- Canada: Visit www.handsfreelink.ca, or call 1-888-528-7876.

After you reply, the following is displayed:

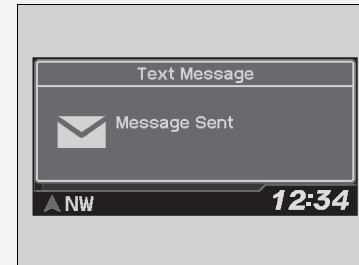

Continued

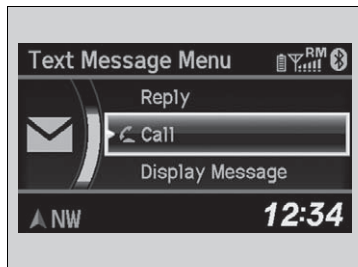

■ Making a call to a sender

You can call the text message sender.

1. Press the **PHONE** button or the button.
2. Rotate to select to **Text Message**, then press .
3. Rotate to select a message, then press .
 - ▶ The text message is displayed. The system automatically starts reading out the message.
4. Press to enter the **Text Message Menu**.
5. Rotate to select **Call**, then press .
 - ▶ HFL begins dialing.

■ Displaying an entire message

1. Press the **PHONE** button or the button.
2. Rotate to select to **Text Message**, then press .
3. Rotate to select a message, then press .
 - ▶ The text message is displayed. The system automatically starts reading out the message.
4. Press to enter the **Text Message Menu**.
5. Rotate to select **Display Message**, then press .
6. Rotate to scroll down and display the entire message.





When you set the power mode to ON, the compass self-calibrates, and the compass display appears.

Compass Calibration

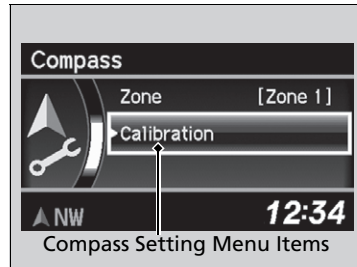
If the compass indicates the wrong direction, or the **CAL.** indicator blinks, you need to manually calibrate the system.



1. Set the power mode to ON.
2. Press and hold the **SETUP** button until the display shows the compass setting menu.
3. Rotate  to select **Calibration**, then press .

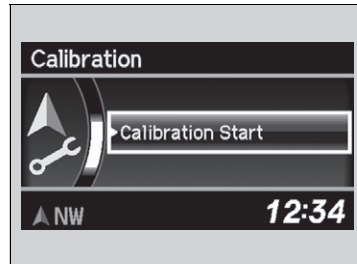

4. When the display changes to **Calibration Start**, press .
5. Drive the vehicle slowly in two circles.
 - ▶ The compass starts to show a direction after the calibration. The **CAL.** indicator goes off.

Compass*

Compass operation can be affected under the following conditions:

- Driving near power lines or stations
- Crossing a bridge
- Passing a large vehicle, or driving near a large object that can cause a magnetic disturbance
- When accessories such as antennas and roof racks are mounted by magnets

Compass Calibration

Calibrate the compass in an open area.





While setting the compass:

- The **BACK** button returns to the previous screen.
- The **SETUP** button cancels the setting mode.

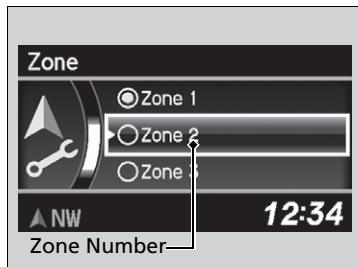
* Not available on all models

Compass Zone Selection



1. Set the power mode to ON.
2. Press and hold the **SETUP** button until the display shows the compass setting menu.
3. Rotate  to select **Zone**, then press . The display shows the current zone number.
4. Rotate  to select the zone number of your area (See Zone Map), then press .

▶▶ Compass Zone Selection

The zone selection is done to compensate the variation between magnetic north and true north.

If the calibration starts while the audio system is in use, the display returns to normal after the calibration is completed.

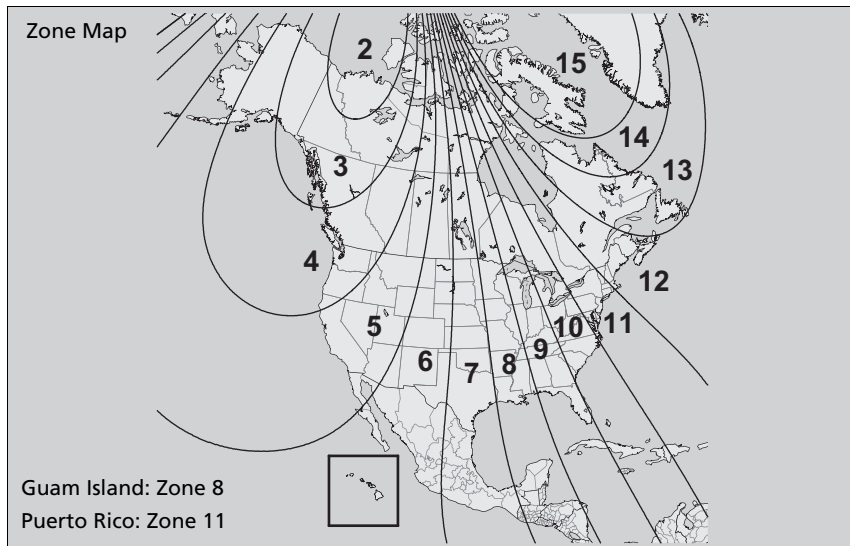



Driving

This chapter discusses driving, refueling, and information on items such as accessories.

Before Driving	258	Vehicle Stability Assist (VSA®), aka Electronic Stability Control (ESC), System	311	Collision Mitigation Braking System™ (CMBS™)*	324
Towing a Trailer	263	Blind spot information (BSI) System*	313	Parking Your Vehicle	
Off-Highway Driving Guidelines	268	All-Wheel Drive (AWD) with Intelligent Control System*	316	When Stopped	332
When Driving		Tire Pressure Monitoring System (TPMS) ...	316	Parking Sensor System*	333
Starting the Engine	270	Tire Pressure Monitoring System (TPMS) - Required Federal Explanation	318	Cross Traffic Monitor*	337
Precautions While Driving.....	275	Braking		Multi-View Rear Camera	340
Automatic Transmission	276	Brake System	320	Refueling	
Shifting.....	277	Anti-lock Brake System (ABS)	322	Fuel Information	341
Cruise Control*.....	281	Brake Assist System.....	323	How to Refuel	342
Front Sensor Camera*	284			Fuel Economy and CO₂ Emissions	343
Adaptive Cruise Control (ACC)*	286			Accessories and Modifications	344
Lane Departure Warning (LDW)*	299				
Lane Keeping Assist System (LKAS)*	303				

* Not available on all models

Driving Preparation

Check the following items before you start driving.

Exterior Checks

- Make sure there are no obstructions on the windows, door mirrors, exterior lights, or other parts of the vehicle.
 - ▶ Remove any frost, snow, or ice.
 - ▶ Remove any snow on the roof, as this can slip down and obstruct your field of vision while driving. If frozen solid, remove ice once it has softened.
 - ▶ When removing ice from around the wheels, be sure not to damage the wheel or wheel components.
- Make sure the hood is securely closed.
 - ▶ If the hood opens while driving, your front view will be blocked.
- Make sure the tires are in good condition.
 - ▶ Check air pressures, and check for damage and excessive wear.
 - ✎ **Checking and Maintaining Tires** P. 376
- Make sure there are no people or objects behind or around the vehicle.
 - ▶ There are blind spots from the inside.

Exterior Checks

NOTICE

When doors are frozen shut, use warm water around the door edges to melt any ice. Do not try to force them open, as this can damage the rubber trim around the doors. When done, wipe dry to avoid further freezing.

Do not pour warm water into the key cylinder. You will be unable to insert the key if the water freezes in the hole.

Heat from the engine and exhaust can ignite flammable materials left under the hood, causing a fire. If you've parked your vehicle for an extended period, inspect and remove any debris that may have collected, such as dried grass and leaves that have fallen or have been carried in for use as a nest by a small animal. Also check under the hood for leftover flammable materials after you or someone else has performed maintenance on your vehicle.

Interior Checks

- Store or secure all items on board properly.
 - ▶ Carrying too much cargo, or improperly storing it, can affect your vehicle's handling, stability, stopping distance, and tires, and make it unsafe.
 - ✦ **Maximum Load Limit** P. 261
- Do not pile items higher than the seat height.
 - ▶ They can block your view and may be thrown forward in the event of sudden braking.
- Do not place anything in the front seat footwells. Make sure to secure the floor mat.
 - ▶ An object or unsecured floor mat can interfere with your brake and accelerator pedal operation while driving.
- If you have any animals on board, do not let them move around in the vehicle.
 - ▶ They may interfere with driving and a crash could occur.
- Securely close and lock all doors and the tailgate.
 - ✦ **Locking/Unlocking the Doors from the Inside** P. 130
- Adjust your seating position properly.
 - ▶ Adjust the head restraint, too.
 - ✦ **Adjusting the Seats** P. 164
 - ✦ **Adjusting the Head Restraints** P. 166
- Adjust the mirrors and steering wheel properly for your driving.
 - ▶ Adjust them while sitting in the proper driving position.
 - ✦ **Adjusting the Steering Wheel** P. 160
 - ✦ **Adjusting the Mirrors** P. 161

Interior Checks

The headlight aim is set by the factory, and does not need to be adjusted. However, if you regularly carry heavy items in the cargo area or tow a trailer, have the aiming readjusted at a dealer or by a qualified technician.

- Be sure items placed on the floor behind the front seats cannot roll under the seats.
 - ▶ They can interfere with the driver's ability to operate the pedals, the operation of the seats, or the operation of the sensors under the seats.
- Everyone in the vehicle must fasten their seat belt.
 - ▶ **Fastening a Seat Belt** P. 34
- Make sure that the indicators in the instrument panel come on when you start the vehicle, and go off soon after.
 - ▶ Always have a dealer check the vehicle if a problem is indicated.
 - ▶ **Indicators** P. 68

Maximum Load Limit

The maximum load for your vehicle is 870 lbs (395 kg). See the Tire and Loading Information label attached to the driver's doorjamb.

Label Example

TIRE	SIZE	COLD TIRE PRESSURE	SEE OWNER'S MANUAL FOR ADDITIONAL INFORMATION
FRONT	XXXX/XXXX XXX	XXXKPA, XXPS I	
REAR	XXXX/XXXX XXX	XXXKPA, XXPS I	
SPARE	XXXX/XXXX XXX	XXXKPA, XXPS I	

This figure includes the total weight of all occupants, cargo, and accessories, and the tongue load if you are towing a trailer.

Steps for Determining Correct Load Limit -

- (1)** Locate the statement "The combined weight of occupants and cargo should never exceed XXX kg or XXX lbs." on your vehicle's placard.
- (2)** Determine the combined weight of the driver and passengers that will be riding in your vehicle.
- (3)** Subtract the combined weight of the driver and passengers from XXX kg or XXX lbs.
- (4)** The resulting figure equals the available amount of cargo and luggage load capacity. For example, if the "XXX" amount equals 1,400 lbs. and there will be five 150 lb. passengers in your vehicle, the amount of available cargo and luggage load capacity is 650 lbs. (1,400 - 750 (5 x 150) = 650 lbs.)

Continued

Maximum Load Limit

⚠ WARNING

Overloading or improper loading can affect handling and stability and cause a crash in which you can be hurt or killed.

Follow all load limits and other loading guidelines in this manual.

Gross Vehicle Weight Rating (GVWR):

The maximum allowable weight of the vehicle, all occupants, all accessories, all cargo, and the tongue load.

➤ **Specifications** P. 432

Gross Axle Weight Rating (GAWR):







The maximum allowable weight of the vehicle axle.

➤ **Specifications** P. 432

- (5) Determine the combined weight of luggage and cargo being loaded on the vehicle. That weight may not safely exceed the available cargo and luggage load capacity calculated in step 4.
- (6) If your vehicle will be towing a trailer, load from your trailer will be transferred to your vehicle. Consult this manual to determine how this reduces the available cargo and luggage load capacity of your vehicle.

In addition, the total weight of the vehicle, all occupants, accessories, cargo, and trailer tongue load must not exceed the Gross Vehicle Weight Rating (GVWR) or the Gross Axle Weight Rating (GAWR). Both are on a label on the driver's doorjamb.

Load Limits Example

<p>Example1</p>  <p>Max Load 870 lbs (395 kg)</p>	\geq	 <p>Passenger Weight 150 lbs x 2 = 300 lbs (68 kg x 2 = 136 kg)</p>	<p>+</p>	 <p>Cargo Weight 570 lbs (259 kg)</p>
<p>Example2</p>  <p>Max Load 870 lbs (395 kg)</p>	\geq	 <p>Passenger Weight 150 lbs x 5 = 750 lbs (68 kg x 5 = 340 kg)</p>	<p>+</p>	 <p>Cargo Weight 120 lbs (55 kg)</p>

Towing Preparation

Towing Load Limits

Your vehicle can tow a trailer if you carefully observe the load limits, use the proper equipment, and follow the towing guidelines. Check the load limits before driving.

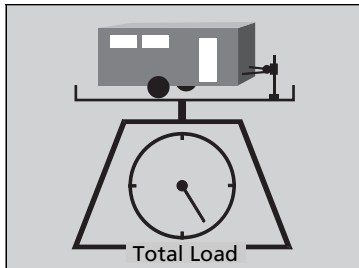

■ Total trailer weight

Maximum allowable weight of the trailer, cargo, and everything in or on it must not exceed 1,500 lbs (680 kg). Towing loads in excess of this can seriously affect vehicle handling and performance and can damage the engine and drivetrain.

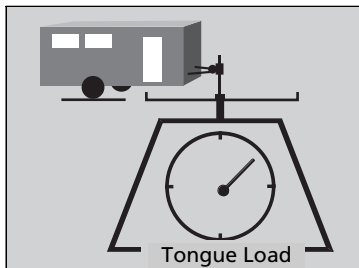

■ Tongue load

The weight of the tongue with a fully loaded trailer on the hitch should be approximately 10% of the total trailer weight.

- Excessive tongue load reduces front tire traction and steering control. Too little tongue load can make the trailer unstable and cause it to sway.
- To achieve a proper tongue load, start by loading 60% of the load toward the front of the trailer and 40% toward the rear. Readjust the load as needed.

⊠ Towing Load Limits

⚠ WARNING

Exceeding any load limit or improperly loading your vehicle and trailer can cause a crash in which you can be seriously hurt or killed.

Check the loading of your vehicle and trailer carefully before starting to drive.

Check if all loads are within limits at a public scale. If a public scale is not available, add the estimated weight of your cargo load to the weight of your trailer (as quoted by the manufacturer), and the tongue load.

Break-in Period

Avoid towing a trailer during your vehicle's first 600 miles (1,000 km).

Never exceed the gross weight ratings. Gross weight information

⊠ **Vehicle Specifications** P. 432

■ Towing Equipment and Accessories

Towing equipment varies by the size of your trailer, how much load you are towing, and where you are towing.

■ Hitches

The hitch must be of an approved type and properly bolted to the underbody.

■ Safety chains

Always use safety chains when you tow a trailer. Leave enough slack to allow the trailer to turn corners easily, but do not allow the chains to drag on the ground.

■ Trailer brakes

Recommended for any trailer with a total weight of 1,000 lbs (450 kg) or more: There are two common types of trailer brakes: surge and electric. Surge brakes are common for boat trailers, since the brakes will get wet. If you choose electric brakes, be sure they are electronically actuated. Do not attempt to attach trailer brakes to your vehicle's hydraulic system, as it will lower braking effectiveness and create a potential hazard.

■ Additional towing equipment

Many states and provinces/territories require special outside mirrors when towing a trailer. Even if mirrors are not required in your locale, you should install special mirrors if visibility is restricted in any way.

► Towing Equipment and Accessories

Make sure that all equipment is properly installed and maintained, and that it meets federal, state, province/territory, and local regulations.

Consult your trailer sales or rental agency if any other items are recommended or required for your towing situation.

The lighting and wiring of trailers can vary by type and brand. If a connector is required, it should only be installed by a qualified technician.

■ Trailer light

Trailer lights and equipment must comply with federal, state, province/territory, and local regulations. Check with your local trailer sales or rental agency for the requirements in the area where you plan to tow.

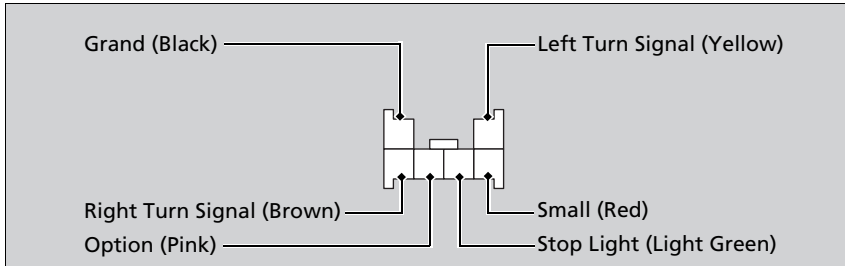

Your trailer lighting connector is located behind the left side panel in the cargo area. Each pin's purpose and wiring color code are shown in the image.

When using a non-Acura trailer lighting harness and converter, get the connector and pins for your vehicle from a dealer.

Driving Safely with a Trailer

■ Things You Need To Know Before Towing a Trailer

- Have the trailer properly serviced and keep it in good condition.
- Make sure that all the weights and load in the vehicle and trailer are within limits.
 - ✎ **Towing Load Limits** P. 263
- Securely attach the hitch, safety chains, and other necessary parts to the trailer.
- Securely store all the items in and on the trailer so that they do not shift while driving.
- Check if the lights and brakes on the trailer are working properly.
- Check the pressures of the trailer tires, including the spare.

■ Towing Speeds and Gears

- Drive slower than normal.
- Obey posted speed limits for vehicles with trailers.
- Use the **[D]** position when towing a trailer on level roads.

■ Turning and Braking

- Turn more slowly and with a wider turning arc than normal.
- Allow more time and distance for braking.
- Do not brake or turn suddenly.

■ Driving in Hilly Terrain

- Monitor your temperature gauge. If it nears the red (Hot) mark, turn off the climate control system and reduce speed. Pull to the side of the road safely to cool down the engine if necessary.
- Shift to the **[S]** position if the transmission shifts frequently.

►► Driving Safely with a Trailer

Operating speed when towing a trailer is restricted up to 100km/h.

Parking

In addition to the normal precautions, place wheel chocks at each of the trailer's tires.

Towing Your Vehicle

Your vehicle is not designed to be towed behind a motor home. If your vehicle needs to be towed in an emergency, refer to the emergency towing information.

 **Emergency Towing** P. 429

General Information

Your vehicle has been designed primarily for use on pavement, however, its higher ground clearance allows you to occasionally travel on unpaved roads. It is not designed for trail-blazing, or other challenging off-road activities.

If you decide to drive on unpaved roads, you will find that it requires somewhat different driving skills and that your vehicle will handle somewhat differently than it does on pavement. Pay attention to the precautions and tips in this section, and get acquainted with your vehicle before leaving the pavement.

Important Safety Precautions

To avoid loss of control or rollover, be sure to follow all precautions and recommendations:

- Be sure to store cargo properly and do not exceed your cargo load limits.
 - **Maximum Load Limit** P. 261
- Whenever you drive, make sure you and your passengers always wear seat belts.
- Keep your speed low, and never go faster than the conditions allow.
- It's up to you to continually assess the situation and drive within the limits.

➤ Off-Highway Driving Guidelines

WARNING

Improperly operating this vehicle on or off-pavement can cause a crash or rollover in which you and your passengers could be seriously injured or killed.

- Follow all instructions and guidelines in this owner's manual.
- Keep your speed low, and don't drive faster than conditions permit.

Failure to operate your vehicle correctly might result in a crash or a rollover.

- **Important Handling Information** P. 28
- **Precautions While Driving** P. 275

Avoiding Trouble

- **Check Out Your Vehicle** before you leave the pavement and make sure that all scheduled maintenance has been completed. Pay special attention to the condition of the tires, and check the tire pressures.
- **Remember** the route you choose presents limits (too steep or bumpy), you have limits (driving skill and comfort), and your vehicle has limits (traction, stability, and power). Failing to recognize these limits will likely put you and your passengers in a hazardous situation.
- **Accelerating and Braking** should be done slowly and gradually. Trying to start or stop too fast can cause a loss of traction and you could lose control.
- **Avoiding Obstacles and Debris** in the road reduces the likelihood of a rollover or damage to your suspension or other components.
- **Driving on Slopes** increases your risk of a rollover, particularly if you attempt to drive across a slope that is too steep. Going straight up or down a slope is usually the safest. If you can't clearly see all conditions or obstacles on a slope, walk it before you drive it. If there is any doubt whether you can safely pass, don't try it. Find another route. If you get stuck when climbing, do not try to turn around. Back down slowly following the same route you took up the hill.
- **Crossing a Stream** - Avoid driving through deep water. If you encounter water in your route (a small stream or large puddle, for example), evaluate it carefully before going ahead. Make sure it is shallow, flowing slowly, and has firm ground underneath. If you are not sure of the depth or the ground, turn around and find another route. Driving through deep water can also damage your vehicle. The water can get into the transmission and differential, diluting the lubricant and causing an eventual failure. It can also wash the grease out of the wheel bearings.
- **If You Get Stuck**, carefully go in the direction that you think will get you unstuck. Do not spin the tires as this will only make things worse and could damage the transmission. If you are unable to free yourself, your vehicle will need to be towed. Front and rear tow hooks are provided for this purpose.

Starting the Engine

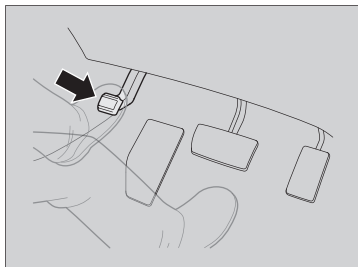

1. Make sure the parking brake is applied.

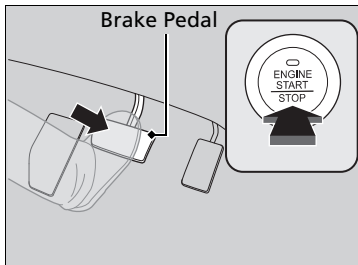

2. Check that the shift lever is in **P**, then depress the brake pedal.

▶ Although it is possible to start the vehicle in **N**, it is safer to start it in **P**.

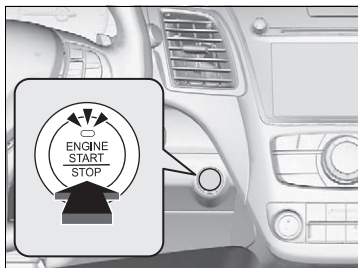

3. Press the **ENGINE START/STOP** button without depressing the accelerator pedal.

Starting the Engine

Keep your foot firmly on the brake pedal when starting the engine.

The engine is harder to start in cold weather and in thinner air found at altitudes above 8,000 feet (2,400 meters).

When starting the engine in cold weather, turn off all electrical accessories such as the lights, climate control system, and rear defogger in order to reduce battery drain.

If you live in a region where winter is extremely cold, an engine block heater will improve starting and warming of the engine. Consult a dealer for details.

If the exhaust system sounds abnormal or you can smell exhaust gas inside the vehicle, have your vehicle checked by a dealer. There may be a problem with the engine or exhaust system.

Bring the keyless access remote close to the **ENGINE START/STOP** button if the battery in the keyless access remote is weak.

▶ **If the Keyless Access Remote Battery is Weak** P. 415

The engine may not start if the keyless access remote is subjected to strong radio waves.

You do not need to hold the **ENGINE START/STOP** button to start the engine.

If the engine does not start, wait at least 30 seconds before trying again.

■ Stopping the Engine

You can turn the engine off when the vehicle is completely stopped.

1. Shift to **P**.
2. Press the **ENGINE START/STOP** button with your foot on the brake pedal.

▶▶ Starting the Engine

The immobilizer system protects your vehicle from theft. If an improperly coded key (or other device) is used, the engine's fuel system is disabled.

▶ **Immobilizer System** P. 139

Continued

■ Remote Engine Start with Vehicle Feedback*

You can remotely start the engine using the two-way keyless access remote from extended distances.

■ To start the engine

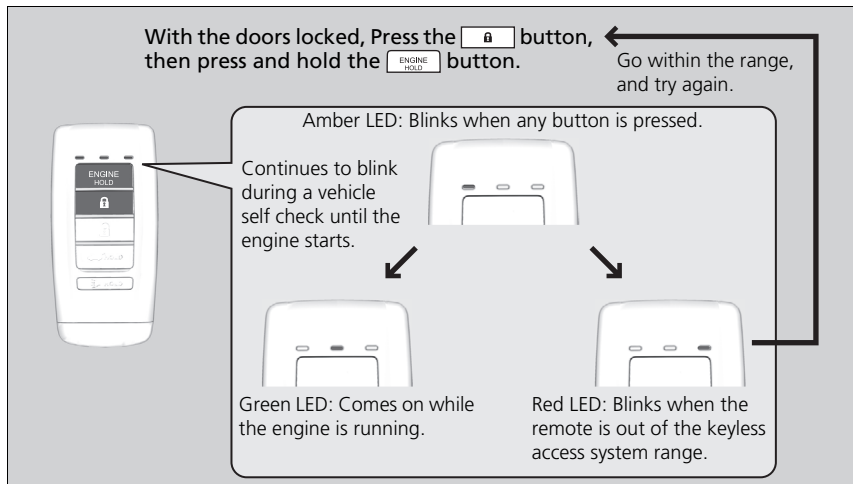

The engine runs for up to 10 minutes without you starting the vehicle.

To extend the run time for another 10 minutes during the first run, press the button, then press and hold the .

▶ The amber LED blinks, then the green LED comes back on if a 10-minute extension request was transmitted successfully.

After pressing the (lock) button, wait for the green LED to blink. This indicates that all the doors and the tailgate are locked.

⚠ Remote Engine Start with Vehicle Feedback*

⚠ WARNING

Engine exhaust contains toxic carbon monoxide.

Breathing carbon monoxide can kill you or cause unconsciousness.

Never use the remote engine starter when the vehicle is parked in a garage or other area with limited ventilation.

If there are buildings and obstacles between your vehicle and the remote, the range will be reduced. This distance may vary by external electrical interference.

The engine may not start by the remote engine start if:

- You have disabled a remote engine start setting using the multi-information display.
- The power mode is not in VEHICLE OFF (LOCK).
- The shift lever is in a position other than **P**.
- The hood is open, or any door or the tailgate is unlocked.
- You have already used the remote twice to start the engine.
- Another registered keyless access remote is in the vehicle.
- There is any antenna failure.
- Door is unlocked with the built-in key.

■ To stop the engine

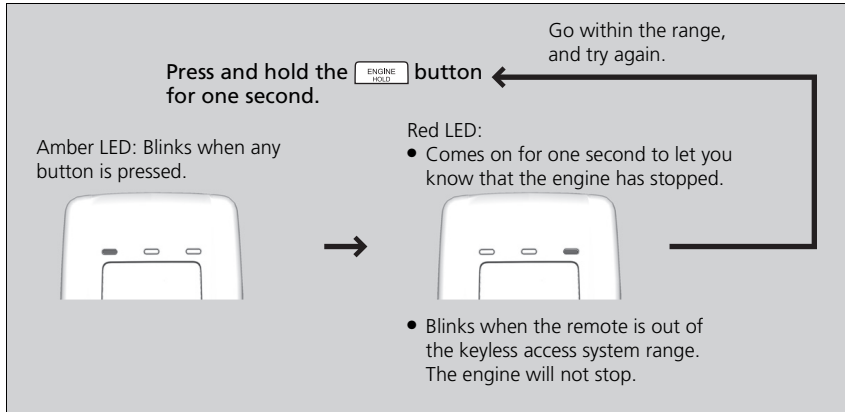

▣ Remote Engine Start with Vehicle Feedback*

- The engine oil pressure is low.
- The engine coolant temperature is extremely high.
- The telematics unit malfunctions.
- The security system alarm is not set.

Before starting the engine, make sure to check the door lock status using the remote. When you press the  button, wait for the green LED to blink. If the red LED turns on, the doors and tailgate did not lock, and the engine does not start.

While the engine is running, the vehicle will automatically precondition inside the vehicle.

When it is warm outside:

- The air conditioning is activated in recirculation mode.

When it is cold outside:

- The defroster is activated at a moderately warm temperature.
- The rear defogger and door mirror heaters are activated.

* Not available on all models

Starting to Drive

When the engine was started using the two-way keyless access remote*

1. Depress the brake pedal and press the **ENGINE START/STOP** button simultaneously.

When the engine was started in any case

2. Keeping your right foot on the brake pedal, release the parking brake. Check that the parking brake indicator has gone off.
➤ **Parking Brake** P. 320
3. Put the shift lever in **[D]**. Select **[R]** when reversing.
4. Gradually release the brake pedal and gently depress the accelerator pedal to pull away.

Hill start assist system

Hill start assist keeps the brake engaged briefly to help prevent the vehicle from rolling on inclines as you move your foot from the brake pedal to the accelerator.

Move the shift lever to **[D]** or **[S]** when facing uphill, or **[R]** when facing downhill, then release the brake pedal.

Starting to Drive

When the engine was started using the two-way keyless access remote*

The engine stops when the shift lever is moved out of **[P]** before the **ENGINE START/STOP** button is pressed. Follow the step 1 when starting to drive.

Hill start assist system

Hill start assist may not prevent the vehicle from rolling downhill on a very steep or slippery slope, and will not operate on small inclines.

Hill start assist is not a replacement for the parking brake.

Precautions While Driving

Driving Guidelines for Your Utility Vehicle

Utility vehicles have a significantly higher rollover rate than other types of vehicles. To prevent rollovers or loss of control:

- Take corners at slower speeds than you would with a passenger vehicle.
- Avoid sharp turns and abrupt maneuvers whenever possible.
- Do not modify your vehicle in any way that you would raise the center of gravity.
- Never carry more than 165 lbs (75 kg) of cargo on the roof rack (Acura accessory).

In Rain

Avoid driving in deep water and on flooded roads. This can damage the engine, driveline, or cause electrical component failure.

Other Precautions

If there is a strong impact with something under the vehicle, stop in a safe location. Check the underside of the vehicle for damage or any fluid leaks.

Precautions While Driving

NOTICE

Do not operate the shift lever while pressing the accelerator pedal. You could damage the transmission.

NOTICE

If you repeatedly turn the steering wheel at an extremely low speed, or hold the steering wheel on the full left or right position for a while, the electric power steering (EPS) system heats up. The system goes into a protective mode, and limits its performance. The steering wheel becomes harder and harder to operate. Once the system cools down, the EPS system is restored. Repeated operation under these conditions can eventually damage the system.

If the power mode is set to ACCESSORY while driving, the engine will shut down and all steering and brake power assist functions will stop, making it difficult to control the vehicle.

Do not put the shift lever in **N**, as you will lose engine braking (and acceleration) performance.

During the first 600 miles (1,000 km) of operation, avoid sudden acceleration or full throttle operation so as not to damage the engine or powertrain.

Avoid hard braking for the first 200 miles (300 km). You should also follow this when the brake pads are replaced.

Driving Guidelines for Your Utility Vehicle

Failure to operate your vehicle correctly might result in a crash or a rollover.

➡ **Important Handling Information P. 28**

Automatic Transmission

■ Creeping

The engine runs at a higher idle speed and creeping increases. Keep the brake pedal firmly depressed when stopped.

■ Kickdown

Quickly depressing the accelerator pedal while driving uphill may cause the transmission to drop to a lower gear, unexpectedly increasing vehicle speed. Depress the accelerator pedal carefully, especially on slippery roads and curves.

Shifting

Change the shift position in accordance with your driving needs.

■ Shift lever positions

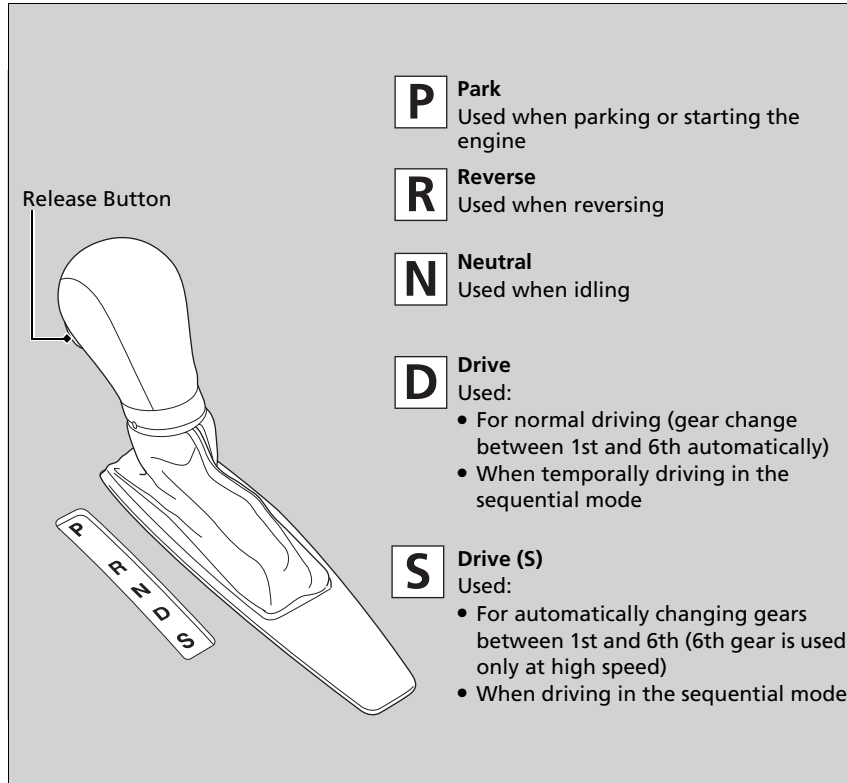

Continued

☒ Shifting

You cannot change the power mode from ON to VEHICLE OFF (LOCK) unless the shift lever is in **P**.

The vehicle may move forward very slightly even in **N** while the engine is cold. Depress the brake pedal firmly and, when necessary, apply the parking brake.

When shifting gears in extremely low temperatures (-22°F/-30°C), there may be a short delay before the shift indicated in the display. Always confirm you are in the correct gear before driving.

■ Shift Lever Operation

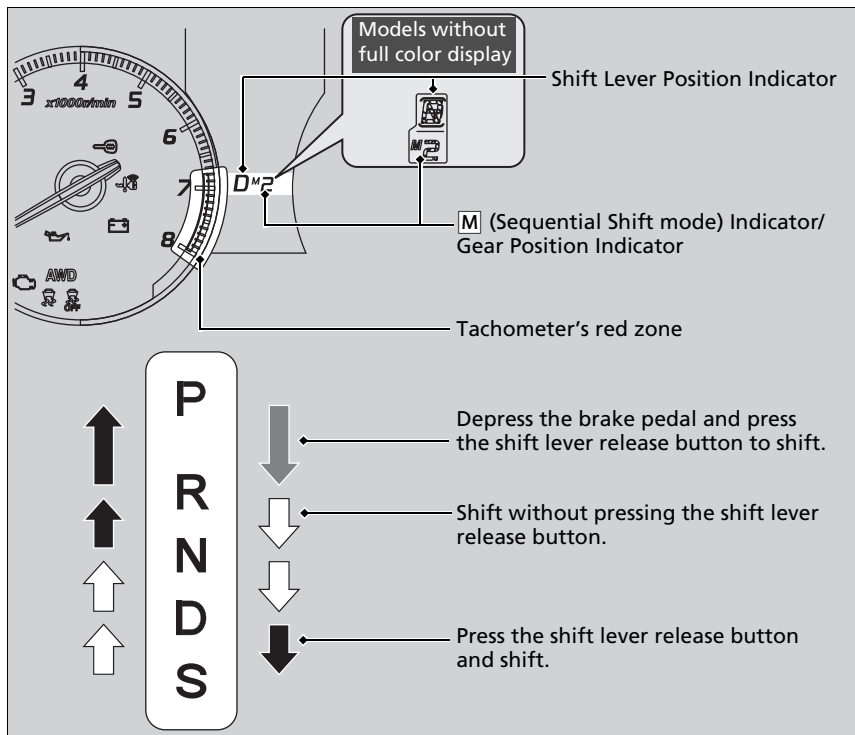

▶▶ Shift Lever Operation

NOTICE

When you change the shift lever from **D** to **R** and vice versa, come to a complete stop and keep the brake pedal depressed. Operating the shift lever before the vehicle has come to a complete standstill can damage the transmission.

Use the shift lever position indicator to check the lever position before pulling away.

Whichever position the shift lever is in when driving, a blinking transmission indicator indicates a transmission problem. Avoid sudden acceleration and have the transmission checked by a dealer as soon as possible.

The fuel supply may be cut off if you drive at engine speeds in or over the tachometer's red zone (engine speed limit). If this happens, you may experience a slight jolt.

It may not be possible to operate the shift lever if the brake pedal is applied while the shift lever release button is held down. Depress the brake pedal first.

Sequential Shift Mode

Use the paddle shifters to change between 1st and 6th gears without removing your hands from the steering wheel. The transmission will switch to the sequential shift mode.

■ When the shift lever is in **D**:

The vehicle will go into the sequential shift mode momentarily, and the gear position indicator will come on.

Once you start traveling at a constant speed, the sequential shift mode will automatically switch off, and the gear position indicator will go off.

Hold the **+** paddle shifter for two seconds to return to normal drive.

■ When the shift lever is in **S**:

The vehicle will go into the sequential shift mode, and the **M** (sequential shift mode) indicator and gear position indicator will come on. At speeds of 6 mph (10 km/h) or less, the vehicle automatically shifts down into 1st gear. It will not automatically shift up, even if vehicle speed increases.

You can only pull away in 1st or 2nd gear.

When switching out of the sequential shift mode, move the shift lever from **S** to **D**. When the sequential shift mode is canceled, the **M** indicator and gear position indicator go off.

■ Second gear lock mode

If you pull the **+** paddle shifter while stopped or driving at 6 mph (10 km/h) or less, the gear position will be locked in 2nd gear. This makes it easier to pull away on slippery surfaces such as snow covered roads.

To cancel the 2nd gear lock mode, pull the **-** paddle shifter, or move the shift lever from **S** to **D**.

■ Sequential Shift Mode Operation

▣ Sequential Shift Mode Operation

Each paddle shift operation makes a single gear change.
To change gears continuously, release the paddle shifter before pulling it again for the next gear.

Recommended Shift Points

Use this table as a guideline for efficient fuel economy and effective emission control.

Shift Up	Normal Acceleration
1st to 2nd	15 mph (24 km/h)
2nd to 3rd	25 mph (40 km/h)
3rd to 4th	40 mph (64 km/h)
4th to 5th	45 mph (72 km/h)
5th to 6th	50 mph (80 km/h)

The gear position indicator blinks when you cannot shift up or down. It indicates that your vehicle speed is not in its allowable gear shifting range. Slightly accelerate to shift up and decelerate to shift down while the indicator is blinking.

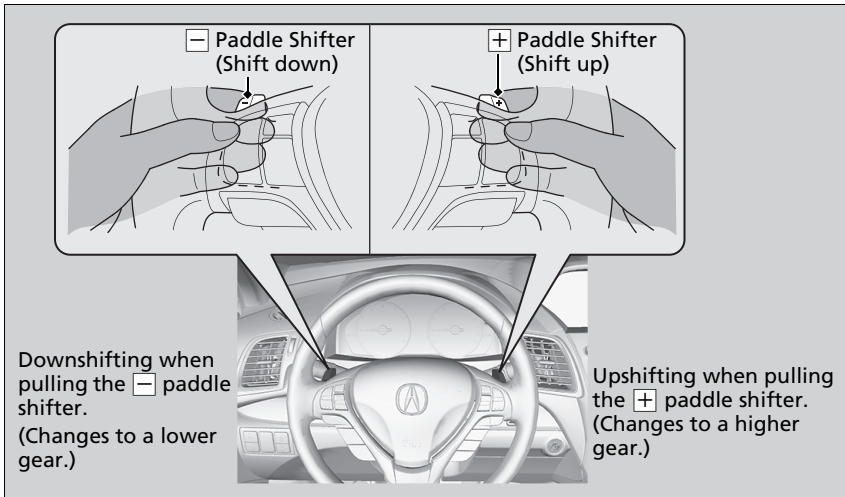

Cruise Control*

Maintains a constant vehicle speed without having to keep your foot on the accelerator. Use cruise control on freeways or open roads where you can travel at a constant speed with little acceleration or deceleration.

When to use

- **Vehicle speed for cruise control:**
Desired speed in a range above roughly 25 mph (40 km/h) ~

Always keep sufficient distance between you and the vehicle in front of you.

- **Shift positions for cruise control:**
In **D** or **S**



How to use

- Press the **CRUISE** button on the steering wheel.



Models with full color display



Models without full color display



CRUISE MAIN is on in the instrument panel. Cruise control is ready to use.

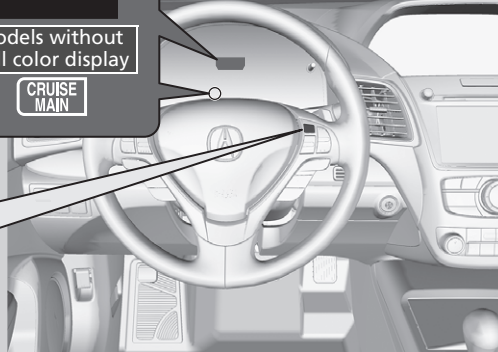

⚠ Cruise Control*

⚠ WARNING

Improper use of the cruise control can lead to a crash.

Use the cruise control only when traveling on open highways in good weather.

It may not be possible to maintain a constant speed when driving uphill or downhill.

When not using cruise control: Turn off cruise control by pressing the **CRUISE** button.

* Not available on all models

■ To Set the Vehicle Speed

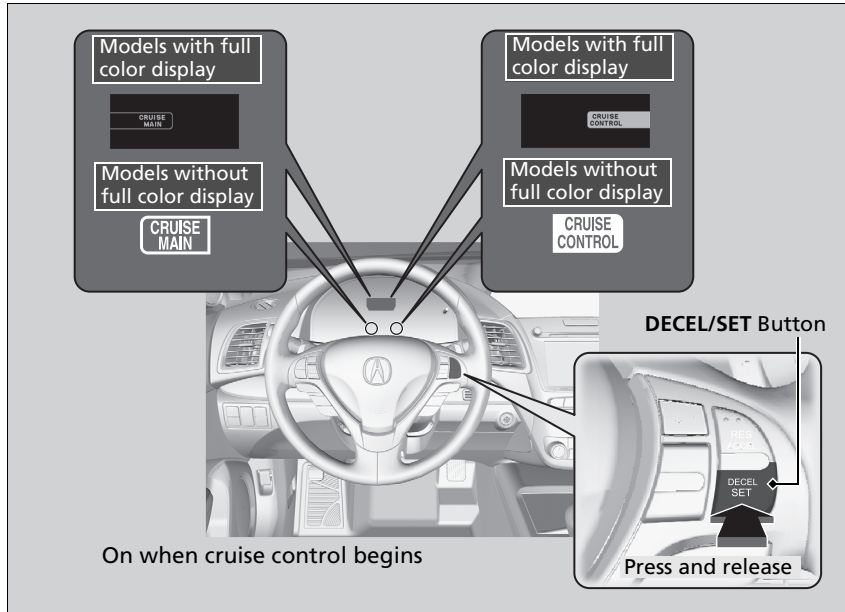

Take your foot off the pedal and press the **DECEL/SET** button when you reach the desired speed.

The moment you release the **DECEL/SET** button, the set speed is fixed, and cruise control begins. The **CRUISE CONTROL** indicator comes on.

■ To Adjust the Vehicle Speed

Increase or decrease the vehicle speed using the **RES/ACCEL** or **DECEL/SET** buttons on the steering wheel.

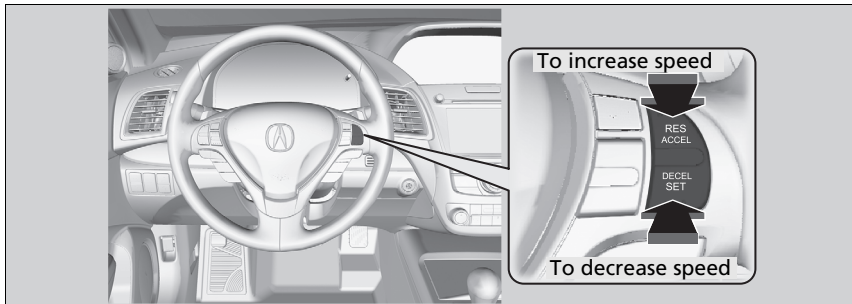

- Each time you press the button, the vehicle speed is increased or decreased by about 1 mph (1.6 km/h).
- If you keep the button pressed, the vehicle speed increases or decreases until you release it. This speed is then set.

■ To Cancel

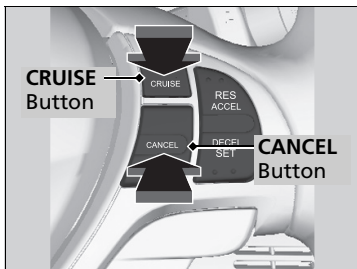

To cancel cruise control, do any of the following:

- Press the **CANCEL** button.
- Press the **CRUISE** button.
- Depress the brake pedal.

The **CRUISE CONTROL** indicator goes off.

☒ To Cancel

Resuming the prior set speed:

After cruise control has been canceled, you can still resume the prior set speed by pressing the **RES/ACCEL** button while driving at a speed of at least 25 mph (40 km/h) or more.

You cannot set or resume in the following situations:

- When vehicle speed is less than 25 mph (40 km/h)
- When the **CRUISE** button is turned off

At vehicle speeds of 22 mph (35 km/h) or less, cruise control is canceled automatically.

Front Sensor Camera*

The camera, used in systems such as LDW, LKAS, ACC, and CMBS™, is designed to detect an object that triggers any of the systems to operate its functions.

■ Camera Location and Handling Tips

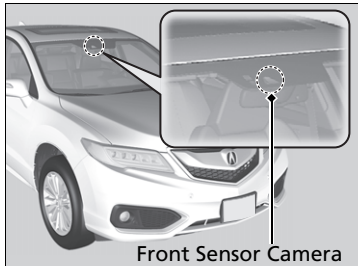

This camera is located behind the rearview mirror.

To help reduce the likelihood that high interior temperatures will cause the camera's sensing system to shut off, when parking, find a shady area or face the front of the vehicle away from the sun. If you use a reflective sun shade, do not allow it to cover the camera housing. Covering the camera can concentrate heat on it.

▣ Front Sensor Camera*

Never apply a film or attach any objects to windshield, the hood, or the front grill that could obstruct the camera's field of vision and cause the system to operate abnormally. Scratches, nicks, and other damage to the windshield within the camera's field of vision can cause the system to operate abnormally. If this occurs, we recommend that you replace the windshield with a genuine Acura replacement windshield. Making even minor repairs within the camera's field of vision or installing an aftermarket replacement windshield may also cause the system to operate abnormally. After replacing the windshield, have a dealer recalibrate the camera. Proper calibration of the camera is necessary for the system to operate properly.

Do not place an object on the top of the instrument panel. It may reflect onto the windshield and prevent the system from detecting lane lines properly.

If the **Some Driver Assist Systems Cannot Operate: Camera Temperature Too High** message appears:

- Use the climate control system to cool down the interior and, if necessary, also use defroster mode with the air flow directed towards the camera.
- Start driving the vehicle to lower the windshield temperature, which cools down the area around the camera.

Front Sensor Camera*

If the **Some Driver Assist Systems Cannot Operate: Clean Front Windshield** message appears:

- Park your vehicle in a safe place, and clean the windshield. If the message does not disappear after you have cleaned the windshield and driven for a while, have your vehicle checked by a dealer.

* Not available on all models

Adaptive Cruise Control (ACC)*

Helps maintain a constant vehicle speed and a set following-distance behind a vehicle detected ahead of yours, without you having to keep your foot on the brake or the accelerator.

When ACC slows your vehicle by applying the brakes, your vehicle's brake lights will illuminate.

▶ Adaptive Cruise Control (ACC)*

⚠ WARNING

Improper use of ACC can lead to a crash.

Use ACC only when travelling on open highways in good weather.

⚠ WARNING

ACC has limited braking capability.

When your vehicle speed drops below 22 mph (35 km/h), ACC will automatically cancel and no longer will apply your vehicle's brakes.

Always be prepared to apply the brake pedal when conditions require.

Important Reminder

As with any system, there are limits to ACC. Use the brake pedal whenever necessary, and always keep a safe distance between your vehicle and other vehicles.

When to use

The camera is located behind the rearview mirror.

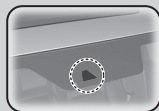

The radar sensor is in the front grille.

■ Vehicle speed for adaptive cruise control: Desired speed in a range above roughly 25 mph (40 km/h) ~

■ Shift positions for adaptive cruise control: In **D** or **S**

■ How to activate the system

■ Press the **MAIN** button on the steering wheel.

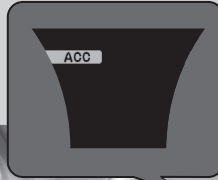
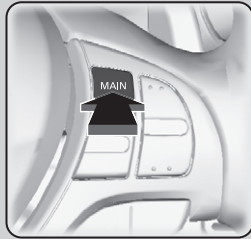

ACC (green) is on in the instrument panel.
ACC is ready to use.



⌘ Adaptive Cruise Control (ACC)*

ACC may not work properly under certain conditions.

➤ **ACC Conditions and Limitations** P. 291

When not using adaptive cruise control: Turn off adaptive cruise by pressing the **MAIN** button. This will also turn off the Lane Keeping Assist System (LKAS).

Do not use the ACC under the following conditions.

- On roads with heavy traffic or while driving in continuous stop and go traffic.
- On roads with sharp turns.
- On roads with steep downhill sections, as the set vehicle speed can be exceeded by coasting. In such cases, the ACC will not apply the brakes to maintain the set speed.
- On roads with toll collection facilities or other objects between lanes of traffic, or in parking areas, or facilities with drive through access.

* Not available on all models

■ To Set the Vehicle Speed

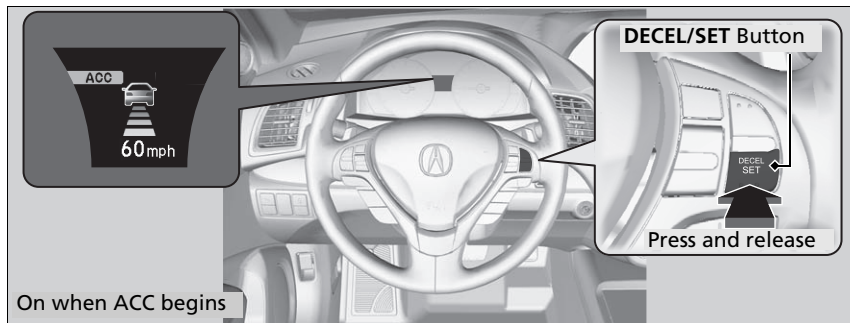

Take your foot off the pedal and press the **DECEL/SET** button when you reach the desired speed.

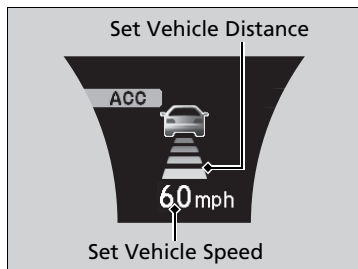

The moment you release the **DECEL/SET** button, the set speed is fixed, and adaptive cruise control begins.

- ▶ A vehicle icon and distance bars appear on the multi-information display.

▶▶ To Set the Vehicle Speed

You can switch the displayed set speed measurements on the multi-information display between mph and km/h.

▶ **Customized Features** P. 108

■ When in Operation

■ There is a vehicle ahead

ACC monitors if a vehicle ahead of you enters the ACC range. If a vehicle is detected doing so, the ACC system maintains or decelerates your vehicle's set speed in order to keep the vehicle's set following-distance from the vehicle ahead.

➤ **To Change Vehicle Distance** P. 294

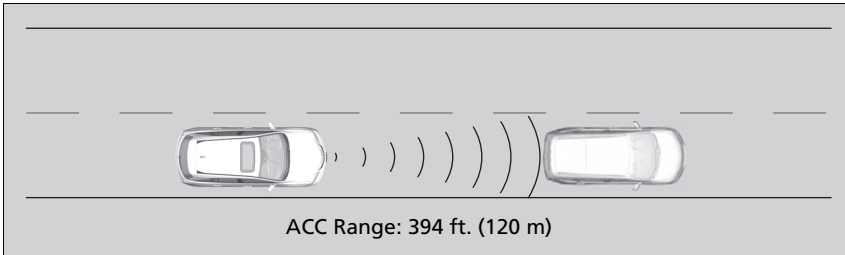

⌘ When in Operation

If the vehicle detected ahead of you slows down abruptly, or if another vehicle is detected cutting in front of you, the beeper sounds and a message appears on the multi-information display to alert you to brake.

Depress the brake pedal, and keep an appropriate distance from the vehicle ahead.

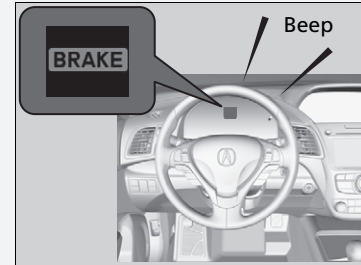

Even if the distance between your vehicle and the vehicle detected ahead is short, ACC may start accelerating your vehicle under the following circumstances:

- The vehicle ahead of you is going at almost the same speed as, or faster than your vehicle.
- A vehicle that cuts in front of you is going faster than your vehicle, gradually distancing itself from you.

■ **There is no vehicle ahead**

Your vehicle cruises at the set speed.

■ **A vehicle ahead is within ACC range and going slower than the set speed**

Your vehicle slows down, and maintains the same speed as the speed of the vehicle ahead to maintain the set following distance.

■ **A vehicle ahead is within ACC range and going at a steady speed**

Your vehicle follows the vehicle ahead of it, keeping a constant distance, without going beyond the set speed.

■ **A vehicle ahead goes out of range**

ACC accelerates your vehicle to the set speed, and then maintains it.

■ **When you depress the accelerator pedal**

You can temporarily increase the vehicle speed. In this case, there is no audible or visual alerts even if a vehicle is in ACC range.

ACC stays on unless you cancel it. Once you release the accelerator pedal, the system resumes the set speed.

There are times when the vehicle speed will decrease when the accelerator pedal is lightly applied.

⌘ When in Operation

You can also set the system to beep when a vehicle detected in front of you comes in and goes out of the ACC detecting range. Change the **ACC Forward Vehicle Detect Beep** setting.

➔ **Customized Features** P. 108

Limitations

You may need to use the brake to maintain a safe distance when using ACC. Additionally, ACC may not work properly under certain conditions.

➔ **ACC Conditions and Limitations** P. 291

■ ACC Conditions and Limitations

The system may automatically shut off and the **ACC** indicator will come on under certain conditions. Some examples of these conditions are listed below. Other conditions may reduce some of the ACC functions.

➤ **Front Sensor Camera*** P. 284

■ Environmental conditions

Driving in bad weather (rain, fog, snow, etc.).

■ Roadway conditions

Driving on a snowy or wet roadway (obscured lane marking, vehicle tracks, reflected lights, road spray, high contrast).

■ Vehicle conditions

- The outside of the windshield is blocked by dirt, mud, leaves, wet snow, etc.
- An abnormal tire or wheel condition (wrong sized, varied size or construction, improperly inflated, compact spare tire*, etc.).
- The camera temperature gets too hot.
- The parking brake is applied.
- When the front grille is dirty.
- When the front of the vehicle tilts up due to heavy cargo in the cargo space or rear seats.
- When tire chains are installed.

* Not available on all models

☒ ACC Conditions and Limitations

The radar sensor for ACC is shared with the Collision Mitigation Braking System™ (CMBS™).

➤ **Collision Mitigation Braking System™ (CMBS™)*** P. 324

You can read about handling information for the camera equipped with this system.

➤ **Front Sensor Camera*** P. 284

■ **Detection limitations**

- A vehicle or pedestrian suddenly crosses in front of you.
- The distance between your vehicle and the vehicle or pedestrian ahead of you is too short.
- A vehicle cuts in front of you at a slow speed, and it brakes suddenly.
- When you accelerate rapidly and approach the vehicle or pedestrian ahead of you at high speed.
- The vehicle ahead of you is a motorcycle, bicycle, mobility scooter, or other small vehicle.
- When there are animals in front of your vehicle.
- When you drive on a curved or winding or undulating road that makes it difficult for the sensor to properly detect a vehicle or a pedestrian in front of you.
- The speed difference between your vehicle and a vehicle in front of you is significantly large.
- An oncoming vehicle suddenly comes in front of you.
- Your vehicle abruptly crosses over in front of an oncoming vehicle.
- When driving through a narrow iron bridge.
- When the vehicle ahead of you brakes suddenly.
- When the vehicle ahead of you has a unique shape.
- When your vehicle or the vehicle ahead of you is driving on one edge of the lane.

■ To Adjust the Vehicle Speed

Increase or decrease the vehicle speed using the **RES/ACCEL** or **DECEL/SET** buttons on the steering wheel.

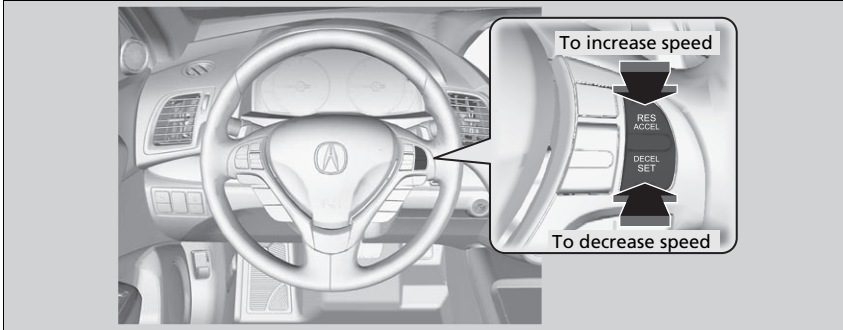

- Each time you press the button, the vehicle speed is increased or decreased by about 1 mph or 1 km/h accordingly.
- If you keep the button pressed, the vehicle speed increases or decreases by about 5 mph or 5 km/h accordingly.

☒ To Adjust the Vehicle Speed

If a vehicle detected ahead is going at a speed slower than your increased set speed, ACC may not accelerate your vehicle. This is to maintain the set following-distance between your vehicle and the vehicle ahead.

You can set the vehicle speed using the **DECEL/SET** button on the steering wheel when adjusting the speed with the accelerator and brake pedals.

Continued

■ To Change Vehicle Distance

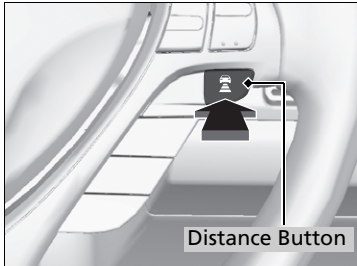





Press the  (distance) button to change the ACC range.

Each time you press the button, the following-distance (the distance behind a vehicle detected ahead of you) setting cycles through extra long, long, middle, and short following-distances.

Determine the most appropriate following-distance setting based on your specific driving conditions. Be sure to adhere to any following-distance requirements set by local regulation.

The higher your vehicle's following-speed is, the longer the short, middle, long or extra long following-distance becomes. See the following examples for your reference.

Vehicle Distance	When the vehicle speed is:	
	50 mph (80 km/h)	65 mph (104 km/h)
 Short	84 feet 26 meters 1.1 sec	102 feet 31 meters 1.1 sec
 Middle	111 feet 34 meters 1.5 sec	139 feet 43 meters 1.5 sec
 Long	155 feet 48 meters 2.1 sec	202 feet 62 meters 2.1 sec
 Extra Long	215 feet 66 meters 3.0 sec	285 feet 87 meters 3.0 sec

■ To Cancel

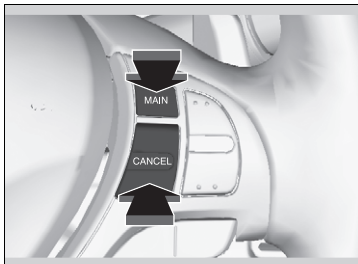

To cancel adaptive cruise control, do any of the following:

- Press the **CANCEL** button.
- Press the **MAIN** button.
- Depress the brake pedal.

■ Automatic cancellation

The beeper sounds and a message appears on the multi-information display when ACC is automatically canceled. Any of these conditions may cause the ACC cancellation:

- Your vehicle speed slows down to 22 mph (35 km/h) and below.
- Bad weather (rain, fog, snow, etc.).
- When the radar sensor in the front grille gets dirty.
- The vehicle ahead of you cannot be detected.
- An abnormal tire condition is detected, or the tires are skidding.
- Driving on a mountainous road, or driving off road for extended periods.
- Abrupt steering wheel movement.
- When the ABS, VSA® is activated.
- When the **ABS** or **VSA®** system indicator comes on.
- When you manually apply the parking brake.
- When the detected vehicle within the ACC range is too close to your vehicle.
- The camera behind the rearview mirror, or the area around the camera, including the windshield, gets dirty.

▶▶ To Cancel

Resuming the prior set speed: After you have canceled adaptive cruise control, you can resume the prior set speed while it is still displayed. Press the **RES/ACCEL** button when driving at a speed of at least 25 mph (40 km/h) or more.

You cannot set or resume when vehicle speed is less than 25 mph (40 km/h).

The set speed cannot be set or resumed when ACC has been turned off using the **MAIN** button. Press the **MAIN** button to activate the system, then set the desired speed.

▶▶ Automatic cancellation

Even though adaptive cruise control has been automatically canceled, you can still resume the prior set speed. Wait until the condition that caused ACC to cancel improves, then press the **RES/ACCEL** button.

■ To Switch ACC to Cruise Control

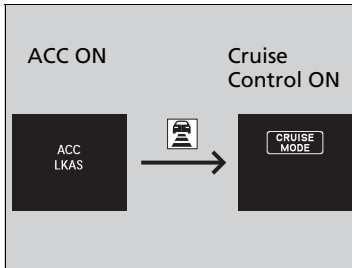

Press and hold the  (distance) button for one second. **Cruise Mode Selected** appears on the driver information interface for two seconds, and then the mode switches to Cruise.

To switch back to ACC, press and hold the  button again for one second. **ACC Mode Selected** appears on the driver information interface for two seconds.

■ When to use

Desired speed in a range above roughly 25 mph (40 km/h) ~.

■ To Set the Vehicle Speed

Take your foot off the pedal and press the **DECEL/SET** button when you reach the desired speed.

The moment you release the **DECEL/SET** button, the set speed is fixed, and cruise control begins. The **CRUISE CONTROL** indicator comes on.

■ To Adjust the Vehicle Speed

Each time you press the **RES/ACCEL** or **DECEL/SET** button, the vehicle speed is increased or decreased by about 1 mph (1.6 km/h).

If you keep the **RES/ACCEL** or **DECEL/SET** button pressed, the vehicle speed increases or decreases until you release it. This speed is then set.

▶▶ To Switch ACC to Cruise Control

Always be aware which mode you are in. When you are driving in Cruise mode, the system will not assist you to maintain a following interval from a vehicle ahead of you.

■ To Cancel

To cancel cruise control, do any of the following:

- Press the **CANCEL** button.
- Press the **MAIN** button.
- Depress the brake pedal.

The **CRUISE CONTROL** indicator goes off.

▶▶ To Cancel

Resuming the prior set speed:

After cruise control has been canceled, you can still resume the prior set speed by pressing the **RES/ACCEL** button while driving at a speed of at least 25 mph (40 km/h) or more.

You cannot set or resume in the following situations:

- When vehicle speed is less than 25 mph (40 km/h)
- When the **MAIN** button is turned off.

At vehicle speeds of 22 mph (35 km/h) or less, cruise control canceled automatically.

Lane Departure Warning (LDW)*

Alerts you when the system determines a possibility of your vehicle unintentionally crossing over detected lane markings.

How the System Works

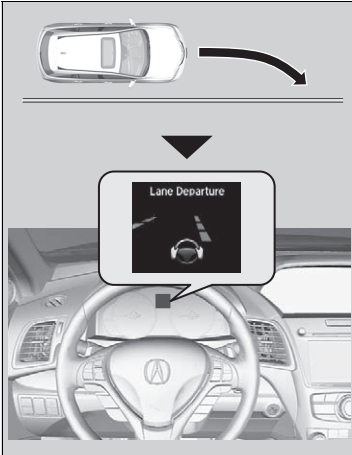

If your vehicle is getting too close to detected left or right side lane markings without a turn signal activated, LDW will give audible and visual alerts.

The beeper sounds and the **Lane Departure** message appears on the multi-information display, letting you know that you need to take appropriate action.

How the System Activates

The system begins to search for lane markings when all the following conditions are met:

- The vehicle is traveling between about 45 and 90 mph (72 and 145 km/h).
- The vehicle is on a straight or slightly curved road.
- The turn signals are off.
- The brake pedal is not depressed.
- The wipers are not in continuous operation.

* Not available on all models

Continued

☒ Lane Departure Warning (LDW)*

Important Safety Reminder

Like all assistance systems, LDW has limitations. Over-reliance on LDW may result in a collision. It is always your responsibility to keep the vehicle within your driving lane.

LDW only alerts you when lane drift is detected without a turn signal in use. LDW may not detect all lane markings or lane departures; accuracy will vary based on weather, speed and lane marker condition. It is always your responsibility to safely operate the vehicle and avoid collisions.

You can read about handling information for the camera equipped with this system.

☒ **Front Sensor Camera*** P. 284

☒ How the System Activates

LDW may automatically shut off and the LDW indicator comes and stays on.

☒ **Indicators** P. 68

■ LDW On and Off

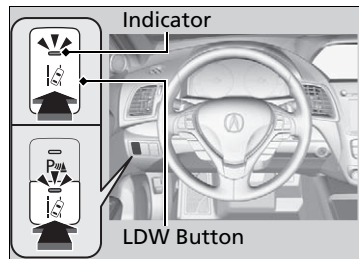

Press the LDW button to turn the system on and off.

- ▶ The indicator in the button comes on when the system is on.

LDW Conditions and Limitations

LDW may not activate or may not recognize lanes, and may activate even when keeping in the middle of a lane, under certain conditions. Some examples of these conditions are listed below.

■ Environmental conditions

- Driving in bad weather (rain, fog, snow, etc.).
- Sudden changes between light and dark, such as an entrance or exit of a tunnel.
- There is little contrast between lane lines and the roadway surface.
- Driving into low sunlight (e.g., at dawn or dusk).
- Strong light is reflected onto the roadway.
- Driving in the shadows of trees, buildings, etc.
- Shadows of adjacent objects are parallel to lane markings.
- Roadway objects or structures are misinterpreted as lane markers.
- Reflections on the interior of the front windshield.

■ Roadway conditions

- Driving on a snowy or wet roadway (obscured lane marking, vehicle tracks, reflected lights, road spray, high contrast).
- Driving on a road with temporary lane markings.
- Faint, multiple, or varied lane markings are visible on the roadway due to road repairs or old lane markings.
- The roadway has merging, split, or crossing lines (e.g., such as at an intersection or crosswalk).
- The lane markings are extremely narrow, wide, or changing.
- The vehicle in front of you is driving near the lane lines.
- The road is hilly or the vehicle is approaching the crest of a hill.
- Driving on rough or unpaved roads, or over bumpy surfaces.

Continued

- When objects on the road (curb, guard rail, pylons, etc.) are recognized as white lines (or yellow lines).
- When driving on roads with double lines.

■ **Vehicle conditions**

- Headlight lenses are dirty or the headlights are not properly adjusted.
- The outside of the windshield is streaked or blocked by dirt, mud, leaves, wet snow, etc.
- The inside of the windshield is fogged.
- The camera temperature gets too hot.
- An abnormal tire or wheel condition (wrong sized, varied size or construction, improperly inflated, compact spare tire*, etc.).
- The vehicle is tilted due to a heavy load or suspension modifications.

Lane Keeping Assist System (LKAS)*

Provides steering input to help keep the vehicle in the middle of a detected lane and provides audible and visual alerts if the vehicle is detected drifting out of its lane.

Beeps and a warning display alert you that the vehicle is drifting out of a detected lane.

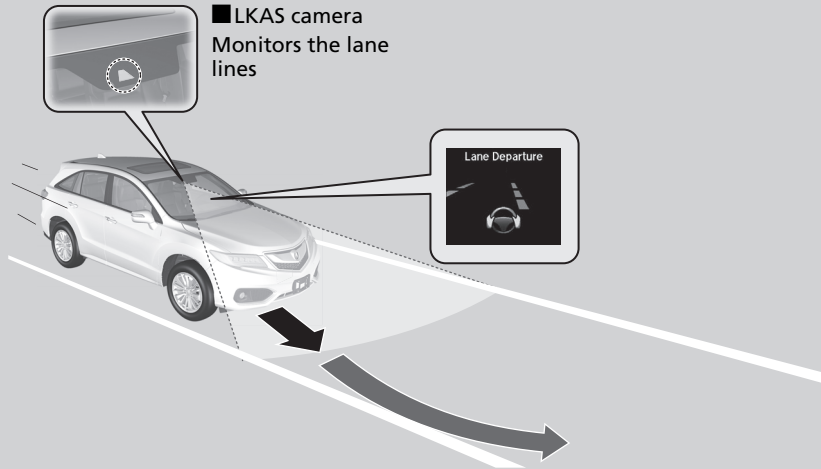

When you operate the turn signals to change lanes, the system is suspended, and resumes after the signals are off.

If you make a lane change without operating the turn signals, the LKAS alerts activate, and torque is applied to the steering.

☒ Lane Keeping Assist System (LKAS)*

Important Safety Reminders

The LKAS is for your convenience only. It is not a substitute for your vehicle control. The system does not work if you take your hands off the steering wheel or fail to steer the vehicle.

☒ Multi-Information Display Warning and Information Messages P. 93

Do not place objects on the instrument panel. Objects may reflect on the front windshield and prevent correct detection of the traffic lanes.

LKAS only alerts you when lane drift is detected without a turn signal in use. LKAS may not detect all lane markings or lane departures; accuracy will vary based on weather, speed, and lane marker condition. It is always your responsibility to safely operate the vehicle and avoid collisions.

The LKAS is convenient when it is used on freeways.

The LKAS may not work properly or may work improperly under the certain conditions:

☒ LKAS Conditions and Limitations P. 309

■ Lane Keep Support Function

Provides assistance to keep the vehicle in the center of the lane. When the vehicle nears a white or yellow line, steering force of the electric power steering will become stronger.

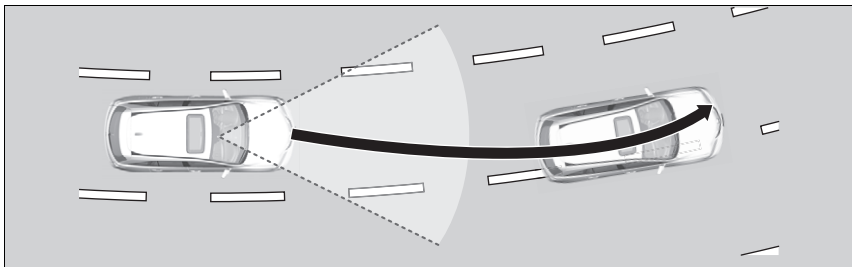

■ Lane Departure Warning Function

When the vehicle enters the warning area, LKAS alerts you with beeps as well as a warning display.

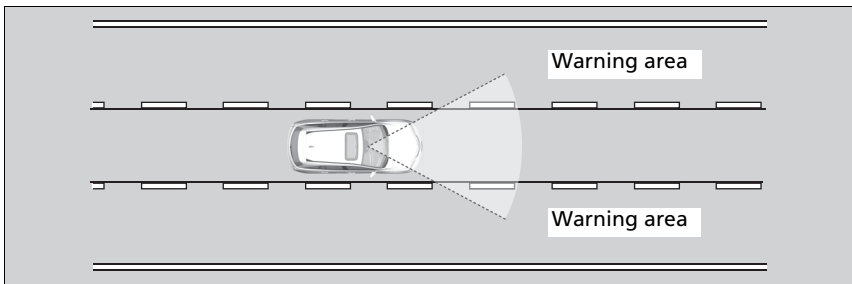

▶ Lane Keeping Assist System (LKAS)*

The LKAS may not function as designed on while driving in frequent stop and go traffic, or on roads with sharp curves.

When it fails to detect lanes, the system will temporarily be cancelled. When lane is detected, system will recover automatically.

You can read about handling information for the camera equipped with this system.

▶ **Front Sensor Camera*** P. 284

If the vehicle drifts toward either left or right lane line due to the system applying torque, turn off the LKAS and have your vehicle checked by a dealer.

■ When the System can be Used

The system can be used when the following conditions are met.

- The lane in which you are driving has detectable lane markers on both sides, and your vehicle is in the center of the lane.
- The vehicle speed is between about 45 and 90 mph (72 and 145 km/h).
- You are driving on a straight or slightly curved road.
- The turn signals are off.
- The brake pedal is not depressed.
- The wipers are not in continuous operation.

■ How to activate the system

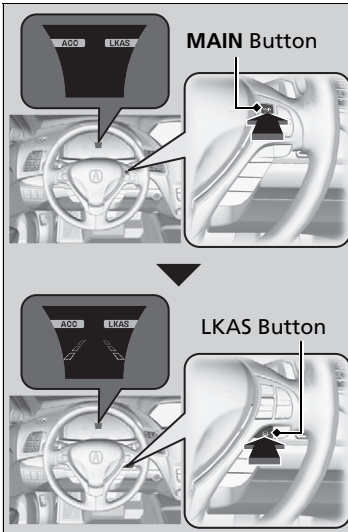

1. Press the **MAIN** button.
 - ▶ The LKAS is on in the multi-information display.
The system is ready to use.
2. Press the LKAS button.
 - ▶ Lane outlines appear on the multi-information display.
The system is activated.

Continued



3. Keep your vehicle near the center of the lane while driving.

- ▶ The dotted outer lines change to solid ones once the system starts operating after detecting the left and right lane markings.

▶▶ When the System can be Used

The LKAS temporarily deactivates when it fails to detect lane lines. When the system detects the lines again, it comes back on automatically.

▶▶ To cancel

Pressing the **MAIN** button also turns ACC on and off.

■ To cancel

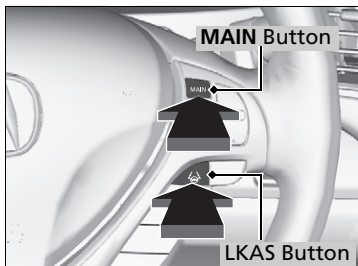

To cancel the LKAS:
Press the **MAIN** or LKAS button.

The LKAS is turned off every time you stop the engine, even if you turned it on the last time you drove the vehicle.

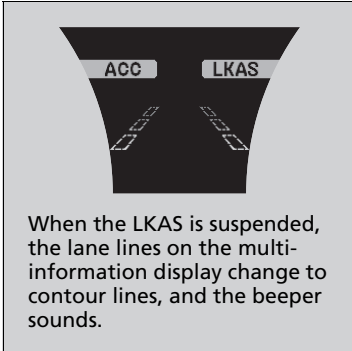

■ **The system operation is suspended if you:**

- Set the wipers to continuous operation.
 - ▶ Turning the wipers off resumes the LKAS.
- Decrease the vehicle speed to about 40 mph (64 km/h) or less.
 - ▶ Increasing the vehicle speed to about 45 mph (72 km/h) or more resumes the LKAS.
- Depress the brake pedal.
 - ▶ The LKAS resumes and starts detecting the lane lines again once you release the brake pedal.

Models with automatic intermittent wipers

- Set the wiper switch to **AUTO** and the wipers operate continuously.
 - ▶ The LKAS resumes when the wipers stop or operate intermittently.

■ **The LKAS may automatically be suspended when:**

- The system fails to detect lane lines.
- The steering wheel is quickly turned.
- You fail to steer the vehicle.
- The vehicle runs on a curved road over the speed limit.

Once these conditions no longer exist, the LKAS automatically resumes.

■ **The LKAS may automatically be canceled when:**

- The camera temperature gets too high.
- The camera behind the rearview mirror, or the area around the camera, including the windshield, gets dirty.
- When driving through a sharp curve.
- When driving at a speed in excess of approximately 90 mph (145 km/h).
- When the ABS or VSA® systems engage.

A beeper will sound if the LKAS is automatically canceled.

LKAS Conditions and Limitations

The system may not detect lane markings and therefore may not keep the vehicle in the middle of a lane under certain conditions, including the following:

■ Environmental conditions

- Driving in bad weather (rain, fog, snow, etc.).
- Sudden changes between light and dark, such as an entrance or exit of a tunnel.
- There is little contrast between lane lines and the roadway surface.
- Driving into low sunlight (e.g., at dawn or dusk).
- Strong light is reflected onto the roadway.
- Driving in the shadows of trees, buildings, etc.
- Shadows of adjacent objects are parallel to lane markings.
- Roadway objects or structures are misinterpreted as lane markers.
- Reflections on the interior of the front windshield.

■ Roadway conditions

- Driving on a snowy or wet roadway (obscured lane marking, vehicle tracks, reflected lights, road spray, high contrast).
- Driving on a road with temporary lane markings.
- Faint, multiple, or varied lane markings are visible on the roadway due to road repairs or old lane markings.
- The roadway has merging, split, or crossing lines (e.g., such as at an intersection or crosswalk).
- The lane markings are extremely narrow, wide, or changing.
- The vehicle in front of you is driving near the lane lines.
- The road is hilly or the vehicle is approaching the crest of a hill.
- Driving on rough or unpaved roads, or over bumpy surfaces.

- When objects on the road (curb, guard rail, pylons, etc.) are recognized as white lines (or yellow lines).
- When driving on roads with double lines.

■ **Vehicle conditions**

- Headlight lenses are dirty or the headlights are not properly adjusted.
- The outside of the windshield is streaked or blocked by dirt, mud, leaves, wet snow, etc.
- The inside of the windshield is fogged.
- The camera temperature gets too high.
- An abnormal tire or wheel condition (wrong sized, varied size or construction, improperly inflated, compact spare tire*, etc.).
- The vehicle is tilted due to a heavy load or suspension modifications.

Vehicle Stability Assist (VSA®), aka Electronic Stability Control (ESC), System

VSA® helps to stabilize the vehicle during cornering if the vehicle turns more or less than what was intended. It also assists in maintaining traction on slippery surfaces. It does so by regulating engine output and selectively applying the brakes.

VSA® Operation

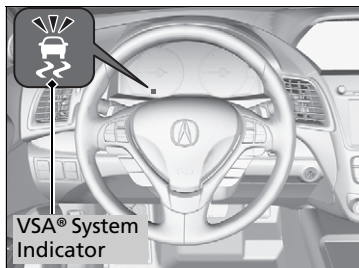

When VSA® activates, you may notice that the engine does not respond to the accelerator. You may also notice some noise from the hydraulic system. You will also see the indicator blink.

Vehicle Stability Assist (VSA®), aka Electronic Stability Control (ESC), System

The VSA® may not function properly if tire type and size are mixed. Make sure to use the same size and type of tire, and the air pressures as specified.

When the VSA® indicator comes on and stays on while driving, there may be a problem with the system. While this may not interfere with normal driving, have your vehicle checked by a dealer immediately.

VSA® cannot enhance stability in all driving situations and does not control the entire braking system. You still need to drive and corner at speeds appropriate for the conditions and always leave a sufficient margin of safety.

The main function of the VSA® system is generally known as Electronic Stability Control (ESC). The system also includes a traction control function.

■ VSA® On and Off

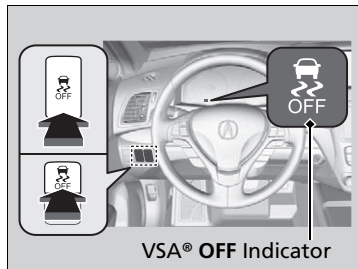

This button is on the driver side control panel. To turn the VSA® system on and off, press and hold it until you hear a beep.

VSA® will stop and the indicator will come on.

To turn it on again, press the  (VSA® **OFF**) button until you hear a beep.

VSA® is turned on every time you start the engine, even if you turned it off the last time you drove the vehicle.

▶▶ Vehicle Stability Assist (VSA®), aka Electronic Stability Control (ESC), System

Without VSA®, your vehicle will have normal braking and cornering ability, but it will not have VSA® traction and stability enhancement.

In certain unusual conditions when your vehicle gets stuck in shallow mud or fresh snow, it may be easier to free it with the VSA® temporarily switched off.

When the VSA® system is off, the traction control system is also off. You should only attempt to free your vehicle with the VSA® off if you are not able to free it when the VSA® is on.

Immediately after freeing your vehicle, be sure to switch VSA® on again. We do not recommend driving your vehicle with the VSA® and traction control systems switched off.

You may hear a motor sound coming from the engine compartment while system checks are being performed immediately after starting the engine or while driving. This is normal.

Blind spot information (BSI) System*

Is designed to detect vehicles in specified alert zones adjacent to your vehicle, particularly in harder to see areas commonly known as “blind spots.”

When the system detects vehicles approaching from behind in adjacent lanes, the appropriate indicator comes on for a few seconds, providing assistance when you change lanes.

■ How the system works

Radar sensors detect a vehicle in the alert zone when your vehicle is moving forward at between 20 mph (32 km/h) and 100 mph (160 km/h).

Alert zone range

- A: Approx. 1.6 ft. (0.5 m)
- B: Approx. 10 ft. (3 m)
- C: Approx. 10 ft. (3 m)

Radar Sensors: underneath the rear bumper corners

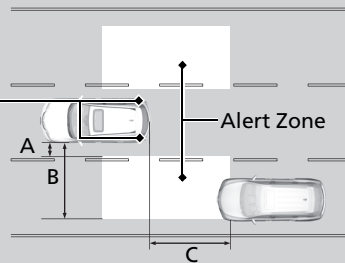

⚠ Blind spot information (BSI) System*

⚠ WARNING

Failure to visually confirm that it is safe to change lanes before doing so may result in a crash and serious injury or death. Do not rely only on the blind spot information system when changing lanes.

Always look in your mirrors, to either side of your vehicle, and behind you for other vehicles before changing lanes.

Important Safety Reminder

Like all assistance systems, BSI has limitations. Over reliance on BSI may result in a collision.

The system is for your convenience only. Even if an object is within the alert zone, the following situations may occur.

- The BSI alert indicator may not come on due to obstruction (splashes, etc.) even without the **BLIND SPOT NOT AVAILABLE/Blind Spot Info Not Available** multi-information display appearing.
- The BSI alert indicator may come on even with the message appearing.

* Not available on all models

■ When the system detects a vehicle

Comes on when:

- A vehicle enters the alert zone from behind to overtake you with a speed difference of no more than 31 mph (50 km/h) from your vehicle.
- You pass a vehicle with a speed difference of no more than 12 mph (20 km/h).

Blinks and a beeper sounds when:

You move the turn signal lever in the direction of the detected vehicle. The beeper sounds three times.

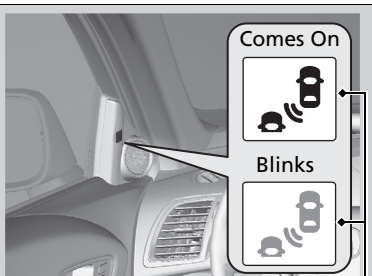

BSI Alert Indicator

▶▶ Blind spot information (BSI) System*

The BSI alert indicator may not come on under the following conditions:

- A vehicle does not stay in the alert zone for more than two seconds.
- A vehicle is parked in a side lane.
- The speed difference between your vehicle and the vehicle you are passing is greater than 6 mph (10 km/h).
- An object not detected by the radar sensors approaches or passes your vehicle.
- A vehicle running in the adjacent lane is a motorcycle or other small vehicle.

The system does not operate when in **R**.

You can change the setting for BSI.

▶ **Customized Features** P. 102, 108

Turn the system off when towing a trailer.

The system may not work properly for the following reasons:

- The added mass tilts the vehicle and changes the radar coverage.
- The trailer itself can be detected by the radar sensors, causing the BSI alert indicators to come on.

▣ Blind spot information (BSI) System*

BSI may be adversely affected when:

- Objects (guard rails, poles, trees, etc.) are detected.
- An object that does not reflect radio waves well, such as a motorcycle, is in the alert zone.
- Driving on a curved road.
- A vehicle is moving from a far lane to the adjacent lane.
- The system picks up external electrical interference.
- The rear bumper or the sensors have been improperly repaired or the rear bumper has been deformed.
- The orientation of the sensors has been changed.
- In bad weather (Heavy rain, snow, and fog).

For a proper BSI use:

- Always keep the rear bumper corner area clean.
- Do not cover the rear bumper corner area with labels or stickers of any kind.
- Take your vehicle to a dealer if you need the rear bumper corner area or the radar sensors to be repaired, or the rear bumper corner area is strongly impacted.

* Not available on all models

All-Wheel Drive (AWD) with Intelligent Control System*

Your vehicle is equipped with the AWD with intelligent control system. When the system senses a loss of front wheel traction, it automatically transfers some power to the rear wheels. This allows you to utilize all available traction and may increase mobility.

You still need to exercise the same care when accelerating, steering, and braking that you would in a two wheel drive vehicle.

If you excessively spin all four wheels and overheat the AWD with intelligent control system, only the front wheels receive power. Stop until the system cools down.

Tire Pressure Monitoring System (TPMS)



Monitors the tire pressure while you are driving. If your vehicle's tire pressure becomes significantly low, the low tire pressure/TPMS indicator comes on and a message appears on the multi-information display.

▶▶ All-Wheel Drive (AWD) with Intelligent Control System*

NOTICE

Do not continuously spin the front tires of your vehicle. Continuously spinning the front tires can cause transmission or rear differential damage.

The AWD with intelligent control system may not function properly if tire type and size are mixed. Make sure to use the same size and type of tire, and the air pressures as specified.

▶ **Tire and Wheel Replacement** P. 382

▶▶ Tire Pressure Monitoring System (TPMS)

Conditions such as low ambient temperature and altitude change directly affect tire pressure and can trigger the low tire pressure/TPMS indicator to come on.

▶ **If the Low Tire Pressure/TPMS Indicator Comes On or Blinks** P. 425

Tire pressure checked and inflated in:

- Warm weather can become under-inflated in colder weather.
- Cold weather can become over-inflated in warmer weather.

The low tire pressure/TPMS indicator will not come on as a result of over inflation.

The TPMS audibly and visually informs you of changes in tire pressure of the individual tire that you are adjusting using audible and visual indications.

▶ **If the Low Tire Pressure/TPMS Indicator Comes On or Blinks** P. 425

Tire Pressure Monitor

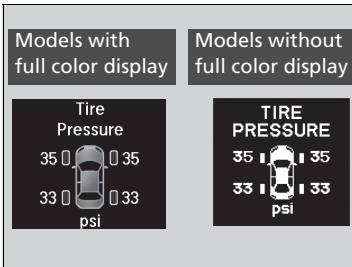

To select the tire pressure monitor, set the power mode to ON, and press the / (information) button until you see the tire pressure screen.

The pressure for each tire is displayed in PSI (U.S.) or kPa (Canada).

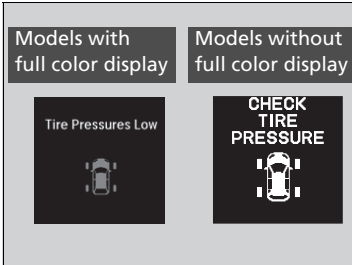

CHECK TIRE PRESSURE/Tire Pressures Low is displayed when a tire has significantly low pressure. The specific tire is displayed on the screen.

Tire Pressure Monitor

The pressure displayed on the multi-information display can be slightly different from the actual pressure as measured by a gauge. If there is a significant difference between the two values, or if the low tire pressure/TPMS indicator and the message on the multi-information display do not go off after you have inflated the tire to the specified pressure, have the system checked by a dealer.

CHECK TPMS SYSTEM/Tire Pressure Monitor Problem may appear if you drive with the compact spare tire*, or there is a problem with the TPMS.

* Not available on all models

Tire Pressure Monitoring System (TPMS) - Required Federal Explanation

Each tire, including the spare (if provided), should be checked monthly when cold and inflated to the inflation pressure recommended by the vehicle manufacturer on the vehicle placard or tire inflation pressure label.

(If your vehicle has tires of a different size than the size indicated on the vehicle placard or tire inflation pressure label, you should determine the proper tire inflation pressure for those tires.)

As an added safety feature, your vehicle has been equipped with a tire pressure monitoring system (TPMS) that illuminates a low tire pressure telltale



when one or more of your tires is significantly under-inflated.

Accordingly, when the low tire pressure telltale illuminates, you should stop and check your tires as soon as possible, and inflate them to the proper pressure.

Driving on a significantly under-inflated tire causes the tire to overheat and can lead to tire failure. Under-inflation also reduces fuel efficiency and tire tread life, and may affect the vehicle's handling and stopping ability.

Please note that the TPMS is not a substitute for proper tire maintenance, and it is the driver's responsibility to maintain

correct tire pressure, even if under-inflation has not reached the level to trigger illumination of the TPMS low tire pressure telltale.

Your vehicle has also been equipped with a TPMS malfunction indicator to indicate when the system is not operating properly. The TPMS malfunction indicator is combined with the low tire pressure telltale. When the system detects a malfunction, the telltale will flash for approximately one minute and then remain continuously illuminated. This sequence will continue upon subsequent vehicle start-ups as long as the malfunction exists.

When the malfunction indicator is illuminated, the system may not be able to detect or signal low tire pressure as intended.

TPMS malfunctions may occur for a variety of reasons, including the installation of replacement or alternate tires or wheels on the vehicle that prevent the TPMS from functioning properly.

Always check the TPMS malfunction telltale after replacing one or more tires or wheels on your vehicle to ensure that the replacement or alternate tires and wheels allow the TPMS to continue to function properly.

Brake System

Parking Brake

Use the parking brake to keep the vehicle stationary when parking.

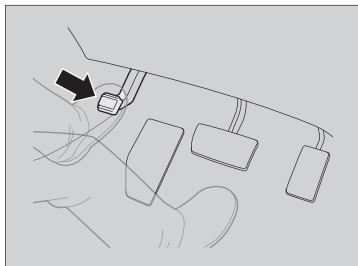

To apply:

Depress the parking brake pedal down with your foot.

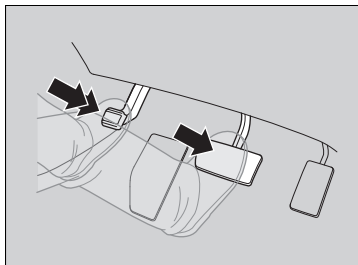

To release:

1. Depress the brake pedal.
2. Depress the parking brake.

Parking Brake

NOTICE

Release the parking brake fully before driving. The rear brakes and axle can be damaged if you drive with the parking brake applied.

If you start driving without fully releasing the parking brake, a buzzer sounds as a warning, and **RELEASE PARKING BRAKE/Release Parking Brake** appears on the multi-information display.

Always apply the parking brake when parking.

Foot Brake

Your vehicle is equipped with disc brakes at all four wheels. A vacuum power assist helps reduce the effort needed on the brake pedal. The brake assist system increases the stopping force when you depress the brake pedal hard in an emergency situation. The anti-lock brake system (ABS) helps you retain steering control when braking very hard.

🔧 **Brake Assist System** P. 323

🔧 **Anti-lock Brake System (ABS)** P. 322

Foot Brake

Check the brakes after driving through deep water, or if there is a buildup of road surface water. If necessary, dry the brakes by lightly depressing the pedal several times.

If you hear a continuous metallic friction sound when applying the brakes, this is caused by the brake wear indicator rubbing on the brake rotor and indicates that the brake pads need to be replaced. Have the vehicle checked by a dealer. If you hear only an occasional squeak or squeal when you initially apply the brake pedal, this may be normal and caused by high frequency vibration of the brake pads against the rotating brake disc.

Constantly using the brake pedal while going down a long hill builds up heat, which reduces the brake effectiveness. Apply engine braking by taking your foot off the accelerator pedal and downshifting to a lower gear.

Do not rest your foot on the brake pedal while driving, as it will lightly apply the brakes and cause them to lose effectiveness over time and reduce pad life. It will also confuse drivers behind you.

Your vehicle is equipped with a hydraulic brake booster that, under certain conditions, such as braking at high altitudes, supplements the vacuum power assist. When the hydraulic brake booster activates, you may hear a motor sound and a slight vibration in the pedal. This is normal.

Anti-lock Brake System (ABS)

ABS

Helps prevent the wheels from locking up, and helps you retain steering control by pumping the brakes rapidly, much faster than you.

The electronic brake distribution (EBD) system, which is part of the ABS, also balances the front-to-rear braking distribution according to vehicle loading.

You should never pump the brake pedal. Let the ABS work for you by always keeping firm, steady pressure on the brake pedal. This is sometimes referred to as “stomp and steer.”

ABS operation

The brake pedal may pulsate slightly when the ABS is working. Keep holding the pedal firmly down. On dry pavement, you will need to press on the brake pedal very hard before the ABS activates. However, you may feel the ABS activate immediately if you are trying to stop on snow or ice.

ABS may activate when you depress the brake pedal when driving on:

- Wet or snow covered roads.
- Roads paved with stone.
- Roads with uneven surfaces, such as potholes, cracks, manholes, etc.

When the vehicle speed goes under 6 mph (10 km/h), the ABS stops.

Anti-lock Brake System (ABS)

NOTICE

The ABS may not function correctly if you use an incorrect tire type and size.

When the **ABS** indicator comes on while driving, there may be a problem with the system. While normal braking is not affected, there is a possibility of the ABS not operating. Have the vehicle checked by a dealer immediately.

The ABS does not reduce the time or distance it takes to stop the vehicle. It only helps with steering control during hard braking.

In the following cases, your vehicle may need more stopping distance than a vehicle without the ABS:

- When driving on rough road surfaces, including when driving on uneven surfaces, such as gravel or snow.
- When tire chains are installed.

The following may be observed with the ABS system:

- Motor sounds coming from the engine compartment when the brakes are applied, or when system checks are being performed after the engine has been started and while vehicle is accelerates.
- Brake pedal and/or the vehicle body vibration when ABS activates.

These vibrations and sounds are normal to ABS systems and are no cause for concern.

Brake Assist System

Designed to assist the driver by generating greater braking force when you depress the brake pedal hard during emergency braking.

■ Brake assist system operation

Press the brake pedal firmly for more powerful braking.

When brake assist operates, the pedal may wiggle slightly and an operating noise may be heard. This is normal. Keep holding the brake pedal firmly down.

Collision Mitigation Braking System™ (CMBS™)*

Can assist you when there is a possibility of your vehicle colliding with a vehicle or a pedestrian detected in front of yours. The CMBS™ is designed to alert you when a potential collision is determined, as well as to reduce your vehicle speed to help minimize collision severity when a collision is deemed unavoidable.

■ How the system works

When to use

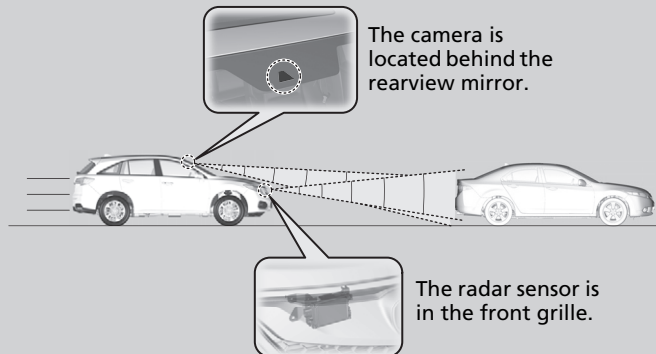

The system starts monitoring the roadway ahead when your vehicle speed is about 3 mph (5 km/h) and there is a vehicle in front of you.

The CMBS™ activates when:

- The speed difference between your vehicle and a vehicle or pedestrian detected in front of you becomes about 3 mph (5 km/h) and over with a chance of a collision.
- Your vehicle speed is about 62 mph (100 km/h) or less and there is a chance of a collision with an oncoming detected vehicle or a pedestrian in front of you.

►► Collision Mitigation Braking System™ (CMBS™)*

Important Safety Reminder

The CMBS™ is designed to reduce the severity of an unavoidable collision. It does not prevent collision nor stop the vehicle automatically. It is still your responsibility to operate the brake pedal and steering wheel appropriately according to the driving conditions.

The CMBS™ may not activate or may not detect a vehicle in front of your vehicle under certain conditions:

► **CMBS™ Conditions and Limitations** P. 328

You can read about handling information for the camera equipped with this system.

► **Front Sensor Camera*** P. 284

■ When the system activates

The system provides visual and audible alerts of a possible collision, and stops if the collision is avoided.

- ▶ Take appropriate action to prevent a collision (apply the brakes, change lanes, etc.).

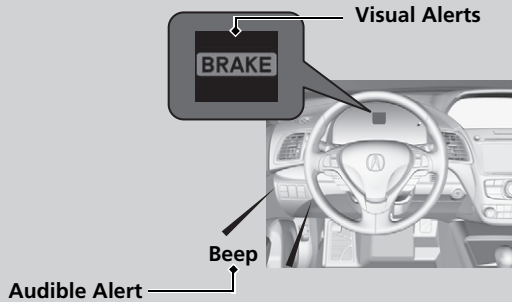

At system's earliest collision alert stage, you can change the distance (**Long/Normal/Short**) between vehicles at which alerts will come on through multi-information display setting options.

- ▶ **List of customizable options** P. 111

▶▶ When the system activates

The camera in the CMBS™ is also designed to detect pedestrians.

However, this pedestrian detection feature may not activate or may not detect a pedestrian in front of your vehicle under certain conditions. Refer to the ones indicating the pedestrian detection limitations from the list.

- ▶ **CMBS™ Conditions and Limitations** P. 328

■ Collision Alert Stages

The system has three alert stages for a possible collision. However, depending on circumstances, the CMBS™ may not go through all of the stages before initiating the last stage.

Distance between vehicles		CMBS™		
		The radar sensor detects a vehicle	Audible & Visual WARNINGS	Braking
Stage one		There is a risk of a collision with the vehicle ahead of you.	When in Long, visual and audible alerts come on at a longer distance from a vehicle ahead than in Normal setting, and in Short , at a shorter distance than in Normal .	—
Stage two		The risk of a collision has increased, time to respond is reduced.	Visual and audible alerts.	Lightly applied
Stage three		The CMBS™ determines that a collision is unavoidable.		Forcefully applied

Driving

■ CMBS™ On and Off

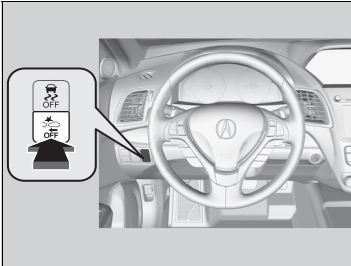

Press this button until the beeper sounds to switch the system on or off.

When the CMBS™ is off:

- The CMBS™ indicator in the instrument panel comes on.
- A message on the multi-information display reminds you that the system is off.

The CMBS™ is in the previously selected ON or OFF setting each time you start the engine.

⊠ Collision Mitigation Braking System™ (CMBS™)*

The CMBS™ may automatically shut off, and the CMBS™ indicator will come and stay on under certain conditions:

➤ **CMBS™ Conditions and Limitations** P. 328

* Not available on all models

■ CMBS™ Conditions and Limitations

The system may automatically shut off and the CMBS™ indicator will come on under certain conditions. Some examples of these conditions are listed below. Other conditions may reduce some of the CMBS™ functions.

📷 **Front Sensor Camera*** P. 284

■ Environmental conditions

- Driving in bad weather (rain, fog, snow, etc.).
- Sudden changes between light and dark, such as an entrance or exit of a tunnel.
- There is little contrast between objects and the background.
- Driving into low sunlight (e.g., at dawn or dusk).
- Strong light is reflected onto the roadway.
- Driving in the shadows of trees, buildings, etc.
- Roadway objects or structures are misinterpreted as vehicles and pedestrians.
- Reflections on the interior of the front windshield.

■ Roadway conditions

- Driving on a snowy or wet roadway (obscured lane marking, vehicle tracks, reflected lights, road spray, high contrast).
- Driving on curvy, winding, or undulating roads.

■ Vehicle conditions

- Headlight lenses are dirty or the headlights are not properly adjusted.
- The outside of the windshield is blocked by dirt, mud, leaves, wet snow, etc.
- The inside of the windshield is fogged.
- An abnormal tire or wheel condition (wrong sized, varied size or construction, improperly inflated, compact spare tire*, etc.).
- When tire chains are installed.
- The vehicle is tilted due to a heavy load or suspension modifications.
- The camera temperature gets too hot.
- Driving with the parking brake applied.
- When the radar sensor in the front grille gets dirty.

■ Detection limitations

- A vehicle or pedestrian suddenly crosses in front of you.
- The distance between your vehicle and the vehicle or pedestrian ahead of you is too short.
- A vehicle cuts in front of you at a slow speed, and it brakes suddenly.
- When you accelerate rapidly and approach the vehicle or pedestrian ahead of you at high speed.
- The vehicle ahead of you is a motorcycle, bicycle, mobility scooter or other small vehicle.
- When there are animals in front of your vehicle.
- When you drive on a curved, winding or undulating road that makes it difficult for the sensor to properly detect a vehicle in front of you.
- The speed difference between your vehicle and a vehicle in front of you is significantly large.
- An oncoming vehicle suddenly comes in front of you.
- Another vehicle suddenly comes in front of you at an intersection, etc.
- Your vehicle abruptly crosses over in front of an oncoming vehicle.

* Not available on all models

Continued

- When driving through a narrow iron bridge.
- When a pedestrian blends in with the background.
- When a pedestrian is bent over or squatting, or when their hands are raised or they are running.
- When several pedestrians are walking ahead in a group.
- When the lead vehicle suddenly slows down.
- When the camera cannot correctly identify that a pedestrian is present due to an unusual shape (holding luggage, body position, size).

Limitations applicable to pedestrian detection only

- When there is a group of people in front of your vehicle walking together side by side.
- Surrounding conditions or belongings of the pedestrian alter the pedestrian's shape, preventing the system from recognizing that the person is a pedestrian.
- When the pedestrian is squatting.
- A strong light is reflected onto the roadway.
- When the pedestrian is shorter than about 3.3 feet (1 meter) or taller than about 6.6 feet (2 meters) in height.

■ With Little Chance of a Collision

The CMBS™ may activate even when you are aware of a vehicle ahead of you, or when there is no vehicle ahead. Some examples of this are:

■ When Passing

Your vehicle approaches another vehicle ahead of you and you change lanes to pass.

■ At an intersection

Your vehicle approaches or passes another vehicle that is making a left or right turn.

■ On a curve

When driving through curves, your vehicle comes to a point where an oncoming vehicle is right in front of you.

■ Through a low bridge at high speed

You drive under a low or narrow bridge at high speed.

■ Speed bumps, road work sites, train tracks, roadside objects, etc.

You drive over speed bumps, steel road plates, etc., or your vehicle approaches train tracks or roadside objects [such as a traffic sign and guard rail] on a curve or, when parking, stationary vehicles and walls.

⊠ Collision Mitigation Braking System™ (CMBS™)*

For the CMBS™ to work properly:

Always keep the radar sensor cover clean.

Never use chemical solvents or polishing powder for cleaning the sensor cover. Clean it with water or a mild detergent.

Do not paint, or apply any coverings or paint to radar sensor area. This can impact CMBS™ operation.

If you need the radar sensor to be repaired, or removed, or the radar sensor cover is strongly impacted, turn off the system by pressing the CMBS™ off button and take your vehicle to a dealer.

* Not available on all models

When Stopped

1. Depress the brake pedal firmly with the shift lever in **D**.
2. Firmly apply the parking brake.
3. Move the shift lever from **D** to **P**.
4. Turn off the engine.

Always set the parking brake firmly, in particular if you are parked on an incline.

» Parking Your Vehicle

Do not park your vehicle near flammable objects, such as dry grass, oil, or timber. Heat from the exhaust can cause a fire.

» When Stopped

NOTICE

The following can damage the transmission:

- Depressing the accelerator and brake pedals simultaneously.
- Holding the vehicle in place when facing uphill by depressing the accelerator pedal.
- Moving the shift lever into **P** before the vehicle stops completely.

In extremely cold temperatures, the parking brake may freeze up if applied. If such temperatures are expected, do not apply the parking brake but, if parking on a slope, either turn the front wheels so they will contact the curb if the vehicle rolls down the slope or block the wheels to keep the vehicle from moving. If you do not take either precaution, the vehicle may roll unexpectedly, leading to a crash.

Parking Sensor System*

The corner and center sensors monitor obstacles near your vehicle. The beeper and audio/information screen let you know the approximate distance between your vehicle and the obstacle.

■ The sensor location and range

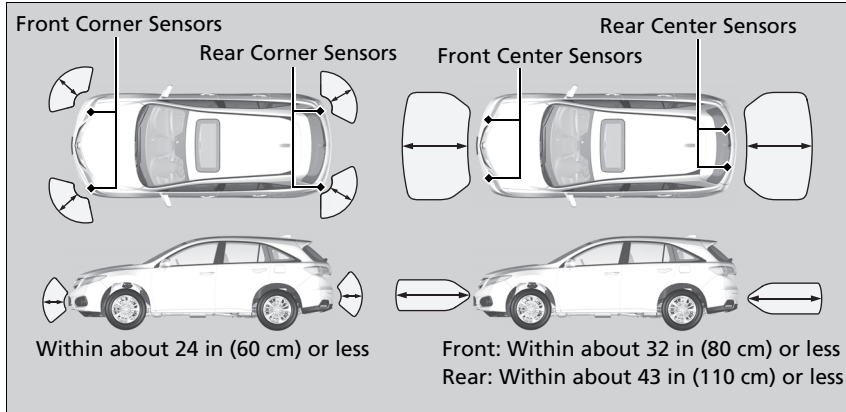

⊠ Parking Sensor System*

Even when the system is on, always confirm if there is no obstacle near your vehicle before parking.

The system may not work properly when:

- The sensors are covered with snow, ice, mud or dirt, etc.
- The vehicle is on uneven surface, such as grass, bumpy road, or a hill.
- The vehicle has been out in hot or cold weather.
- The system is affected by devices that emit ultrasonic waves.
- Driving in bad weather.

The system may not sense:

- Thin or low objects.
- Sonic-absorptive materials, such as snow, cotton, or sponge.
- Objects directly under the bumper.

Do not put any accessories on or around the sensors.

* Not available on all models

Continued

■ Parking sensor system on and off

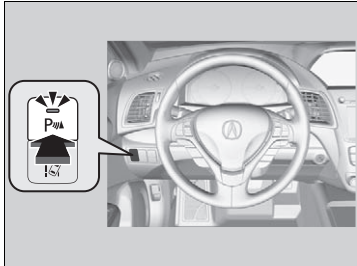

With the power mode in ON, press the parking sensor system button to turn on or off the system. The indicator in the button comes on when the system is on.

The front center and front corner sensors start to detect an obstacle when the shift lever is in any position other than **P** or **R**, and the vehicle speed is less than 5 mph (8 km/h).

The front corner, rear center and rear corner sensors start to detect an obstacle when the shift lever is in **R**, and the vehicle speed is less than 5 mph (8 km/h).

■ When the distance between your vehicle and obstacles behind becomes shorter

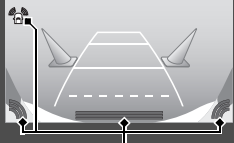
Length of the intermittent beep	Distance between the Bumper and Obstacle		Indicator	Audio/information screen
	Corner Sensors	Center Sensors		
Moderate	—	Front: About 32-24 in (80-60 cm) Rear: About 43-24 in (110-60 cm)	Blinks in Yellow*1	 <p>Indicators light where the sensor detects an obstacle</p>
Short	About 24-18 in (60-45 cm)	About 24-18 in (60-45 cm)	Blinks in Amber	
Very short	About 18-14 in (45-35 cm)	About 18-14 in (45-35 cm)	Blinks in Amber	
Continuous	About 14 in (35 cm) or less	About 14 in (35 cm) or less	Blinks in Red	

*1: At this stage, only the center sensors detect obstacles.

■ Turning off All Rear Sensors

1. Make sure that the parking sensor system is not activated. Set the power mode to VEHICLE OFF (LOCK).
2. Press and hold the parking sensor system button, and set the power mode to ON.
3. Keep pressing the button for 10 seconds. Release the button when the indicator in the button flashes.
4. Press the button again. The indicator in the button goes off.
 - The beeper sounds twice. The rear sensors are now turned off.

To turn the rear sensors on again, follow the above procedure. The beeper sounds three times when the rear sensors come back on.

▣ Turning off All Rear Sensors

When you shift to **[R]**, the indicator in the parking sensor system button blinks as a reminder that the rear sensors have been turned off.

Cross Traffic Monitor*

Monitors the rear corner areas using the radar sensors when reversing, and alerts you if a vehicle approaching from a rear corner is detected.

The system is convenient when you are backing out of a parking space.

ⓘ Cross Traffic Monitor*

⚠ CAUTION

Cross Traffic Monitor cannot detect all approaching vehicles and may not detect an approaching vehicle at all.

Failure to visually confirm that it is safe to back up the vehicle before doing so may result in a collision.

Do not solely rely on the system when reversing; always also use your mirrors, and look behind and to the sides of your vehicle before reversing.

Models with Parking Sensor System

The parking sensor system's alerting buzzer overrides the Cross Traffic Monitor buzzer when the sensors are detecting obstacles at the closest range.

* Not available on all models

Continued

■ How the System Works

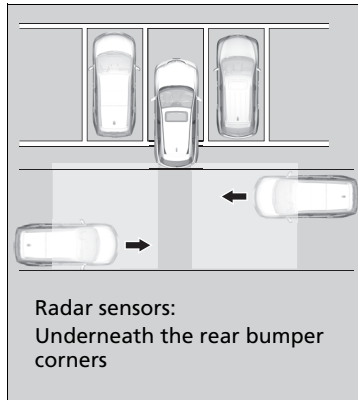

The system activates when:

- The power mode is in ON.
- The transmission is in **R**.
- The Cross Traffic Monitor system is turned on.

▶ **Cross Traffic Monitor On and Off** P. 339

When a vehicle is detected approaching from a rear corner, Cross Traffic Monitor alerts you with a buzzer and a displayed warning.

The system will not detect a vehicle that approaches from directly behind your vehicle, nor will it provide alerts about a detected vehicle when it moves directly behind your vehicle.

The system does not provide alerts for a vehicle that is moving away from your vehicle, and it may alert for pedestrians, bicycles, or stationary objects.

▶ Cross Traffic Monitor*

Cross traffic monitor may not detect or may delay detecting an approaching vehicle, or may alert detection without an approaching vehicle under the following conditions:

- An obstacle, such as another vehicle and a wall, near your vehicle's rear bumper, is blocking the radar sensor's scope.
- Your vehicle is moving at the speed of about 3 mph (5 km/h) or higher.
- A vehicle is approaching at the speed other than between about 6 and 16 mph (10 and 25 km/h).
- The system picks up external interference such as other radar sensors from another vehicle or strong radio wave transmitted from a facility nearby.
- Either corner of the rear bumper is covered with snow, ice, mud or dirt.
- When there is bad weather.
- Your vehicle is on an incline.
- Your vehicle is tilted due to a heavy load in the rear.
- Your vehicle is reversing towards a wall, a poll, a vehicle, etc.
- The rear bumper or the sensors have been improperly repaired or the rear bumper has been deformed. Have a vehicle checked by a dealer.

For proper operation, always keep the rear bumper corner area clean.

Do not cover the rear bumper corner area with labels or stickers of any kind.

■ When the System Detects a Vehicle

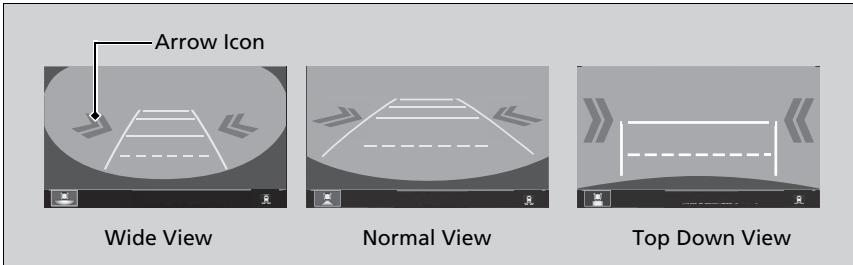

An arrow icon appears on the side a vehicle is approaching on the audio/information screen.

■ Cross Traffic Monitor On and Off

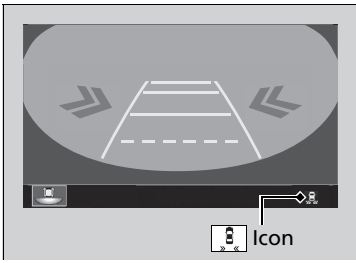

You can switch on and off the system using the audio/information screen.

⊗ When the System Detects a Vehicle

If the on the lower right changes to in amber when the shift lever is in **R**, obstructions (mud, snow, ice, etc.) may have accumulated in the vicinity of the sensor. The system is temporarily canceled. Check the bumper corners for any obstructions, and thoroughly clean the area if necessary.

If the comes on in amber when the shift lever is in **R**, there may be a problem with the Cross Traffic Monitor system. Do not use the system and have your vehicle checked by a dealer.

Multi-View Rear Camera

About Your Multi-View Rear Camera

Models with navigation system

For models with navigation system, see Navigation System Manual.

Models without navigation system

The audio/information screen can display your vehicle's rear view. The display automatically changes to the rear view when the shift lever is moved to **R**.

Multi-View Rear Camera Display Area

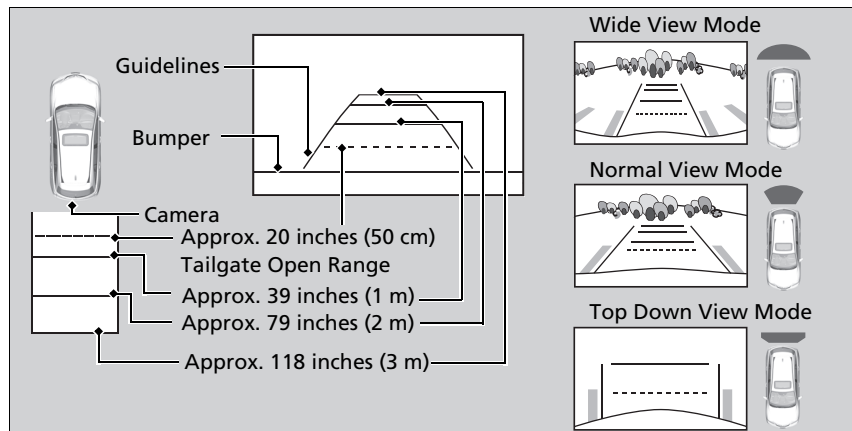

You can view three different camera angles on the rearview display. Press the selector knob to switch the angle.

If the last used viewing mode is Wide or Normal, the same mode is selected the next time you shift into **R**. If Top view was last used, Wide mode is selected.

About Your Multi-View Rear Camera

The rear camera view is restricted. You cannot see the corner ends of the bumper or what is underneath the bumper. Its unique lens also makes objects appear closer or farther than they actually are.

Visually confirm that it is safe to drive before backing up. Certain conditions (such as weather, lighting, and high temperatures) may also restrict the rear view. Do not rely on the rearview display which does not give you all information about conditions at the back of your vehicle.

If the camera lens is covered with dirt or moisture, use a soft, moist cloth to keep the lens clean and free of debris.

Fuel Information

■ Fuel recommendation

Unleaded premium gasoline, pump octane number 91 or higher

Use of lower octane gasoline can cause occasional metallic knocking noise in the engine and will result in decreased engine performance.

Use of gasoline with a pump octane less than 87 can lead to engine damage.

■ Top tier detergent gasoline

Because the level of detergency and additives in gasoline vary in the market, Acura endorses the use of "TOP TIER Detergent Gasoline" where available to help maintain the performance and reliability of your vehicle. TOP TIER Detergent Gasoline meets a new gasoline standard jointly established by leading automotive manufacturers to meet the needs of today's advanced engines.

Qualifying gasoline retailers will, in most cases, identify their gasoline as having met "TOP TIER Detergent Gasoline" standards at the retail location. This fuel is guaranteed to contain the proper level of detergent additives and be free of metallic additives. The proper level of detergent additives, and absence of harmful metallic additives in gasoline, help avoid build-up of deposits in your engine and emission control system.

For further important fuel-related information for your vehicle, or on information on gasoline that does not contain MMT, visit Acura Owners at owners.acura.com In Canada, visit www.acura.ca for additional information on gasoline. For more information on top tier gasoline, visit www.toptiergas.com.

■ Fuel tank capacity: 16 US gal (60.5 liters)

⌘ Fuel Information

NOTICE

We recommend quality gasoline containing detergent additives that help prevent fuel system and engine deposits. In addition, in order to maintain good performance, fuel economy, and emissions control, we strongly recommend the use of gasoline that does NOT contain harmful manganese-based fuel additives such as MMT, if such gasoline is available.

Use of gasoline with these additives may adversely affect performance, and cause the malfunction indicator lamp on your instrument panel to come on. If this happens, contact a dealer for service. Some gasoline today is blended with oxygenates such as ethanol. Your vehicle is designed to operate on oxygenated gasoline containing up to 15% ethanol by volume. Do not use gasoline containing methanol. If you notice any undesirable operating symptoms, try another service station or switch to another brand of gasoline.

How to Refuel

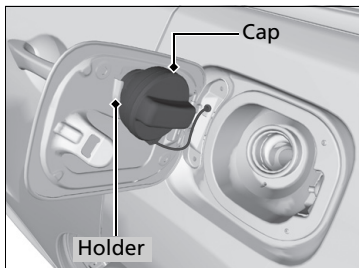
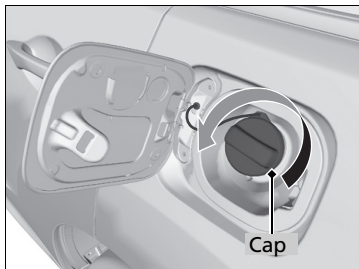
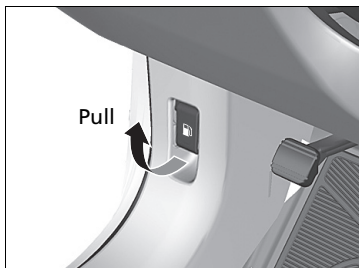

1. Stop your vehicle with the service station pump on the left side of the vehicle in the rear.
2. Turn off the engine.
3. Pull on the fuel fill door release handle under the lower left corner of the dashboard.
 - ▶ The fuel fill door opens.
4. Remove the fuel fill cap slowly. If you hear a release of air, wait until this stops, then turn the knob slowly to open the fuel fill cap.

5. Place the fuel fill cap in the holder.
6. Insert the filler nozzle fully.
 - ▶ When the tank is full, the filler nozzle will click off automatically. This leaves space in the fuel tank in case the fuel expands with a change in the temperature.
7. After filling, replace the fuel fill cap, tightening it until you hear it click at least once.
 - ▶ Shut the fuel fill door by hand.

▶▶ How to Refuel

⚠ WARNING

Gasoline is highly flammable and explosive. You can be burned or seriously injured when handling fuel.

- Stop the engine, and keep heat, sparks, and flame away.
- Handle fuel only outdoors.
- Wipe up spills immediately.

The filler nozzle automatically stops to leave space in the fuel tank so that fuel does not overflow as a result of changes in air temperature.

If the fuel filler nozzle keeps turning off when the tank is not full, there may be a problem with the pump's fuel vapor recovery system. Try filling at another pump. If this does not fix the problem, consult a dealer.

Do not continue to add fuel after the nozzle has automatically stopped. Additional fuel can exceed the full tank capacity.

Improving Fuel Economy and Reducing CO₂ Emissions

Achieving fuel economy and reducing CO₂ emissions is dependent on several factors, including driving conditions, load weight, idling time, driving habits, and vehicle condition. Depending on these and other factors, you may not achieve the rated fuel economy of this vehicle.

Maintenance and Fuel Economy

You can optimize your fuel economy with proper maintenance of your vehicle. Always maintain your vehicle in accordance with the messages displayed on the multi-information display.

- Use the recommended viscosity engine oil, displaying the API Certification Seal.
- Maintain the specified tire pressure.
- Do not load the vehicle with excess cargo.
- Keep your vehicle clean. A buildup of snow or mud on your vehicle's underside adds weight and increases wind resistance.

Improving Fuel Economy and Reducing CO₂ Emissions

Direct calculation is the recommended method to determine actual fuel consumed while driving.

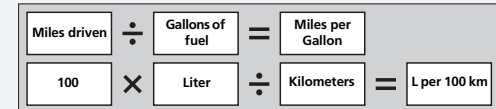

In Canada, posted fuel economy numbers are established following a simulated test. For more information on how this test is performed, please visit <http://oee.nrcan.gc.ca/>

Accessories

When installing accessories, check the following:

- Do not install accessories on the windshield. They can obstruct your view and delay your reaction to driving conditions.
- Do not install any accessories over areas marked SRS Airbag, on the sides or backs of the front seats, on front or side pillars, or near the side windows. Accessories installed in these areas may interfere with proper operation of the vehicle's airbags or may be propelled into you or another occupant if the airbags deploy.
- Be sure electronic accessories do not overload electrical circuits or interfere with proper operation of your vehicle.
 - ▣ **Fuses** P. 426
- Before installing any electronic accessory, have the installer contact a dealer for assistance. If possible, have a dealer inspect the final installation.

Modifications

Do not modify your vehicle or use non-Acura components that can affect its handling, stability, and reliability.

Overall vehicle performance can be affected. Always make sure all equipment is properly installed and maintained, and that it meets federal, state, province, territory, and local regulations.

Accessories and Modifications

WARNING

Improper accessories or modifications can affect your vehicle's handling, stability, and performance, and cause a crash in which you can be seriously hurt or killed.

Follow all instructions in this owner's manual regarding accessories and modifications.

Acura Genuine accessories are recommended to ensure proper operation on your vehicle.

Maintenance

This chapter discusses basic maintenance.



Before Performing Maintenance

Inspection and Maintenance	346
Safety When Performing Maintenance.....	347
Parts and Fluids Used in Maintenance Service	348

Maintenance Minder™

349

Maintenance Under the Hood

Maintenance Items Under the Hood.....	353
Opening the Hood	354
Recommended Engine Oil	355
Oil Check	356
Adding Engine Oil	357
Changing the Engine Oil and Oil Filter	358

Engine Coolant	360
Transmission Fluid	362
Brake Fluid	363
Refilling Window Washer Fluid.....	364
Replacing Light Bulbs	365
Checking and Maintaining Wiper Blades.....	372
Checking and Maintaining Tires Checking Tires	376
Tire and Loading Information Label.....	377
Tire Labeling	377
DOT Tire Quality Grading (U.S. Vehicles).....	379
Wear Indicators.....	381
Tire Service Life	381

Tire and Wheel Replacement	382
Tire Rotation	383
Winter Tires	384
Battery	385
Remote Transmitter Care Replacing the Button Battery	386
Climate Control System Maintenance	388
Cleaning Interior Care	389
Exterior Care.....	391

Inspection and Maintenance

For your safety, perform all listed inspections and maintenance to keep your vehicle in good condition. If you become aware of any abnormality (noise, smell, insufficient brake fluid, oil residue on the ground, etc.), have your vehicle inspected by a dealer. (Note, however, that service at a dealer is not mandatory to keep your warranties in effect.)

Types of Inspection and Maintenance

■ Daily inspections

Perform inspections before long distance trips, when washing the vehicle, or when refueling.

■ Periodic inspections

- Check the automatic transmission fluid level monthly.
 - **Automatic Transmission Fluid** P. 362
- Check the brake fluid level monthly.
 - **Checking the Brake Fluid** P. 363
- Check the tire pressure monthly. Examine the tread for wear and foreign objects.
 - **Checking and Maintaining Tires** P. 376
- Check the operation of the exterior lights monthly.
 - **Replacing Light Bulbs** P. 365
- Check the condition of the wiper blades at least every six months.
 - **Checking and Maintaining Wiper Blades** P. 372

» Inspection and Maintenance

U.S. models

Maintenance, replacement, or repair of emissions control devices and systems may be done by any automotive repair establishment or individuals using parts that are “certified” to EPA standards.

According to state and federal regulations, failure to perform maintenance on the maintenance main items marked with # will not void your emissions warranties. However, all maintenance services should be performed in accordance with the intervals indicated by the multi-information display.

➤ **Maintenance Service Items** P. 351

If you want to perform complex maintenance tasks that require more skills and tools, you can purchase a subscription to the Service Express website at www.techinfo.honda.com.

➤ **Authorized Manuals** P. 441

If you want to perform maintenance yourself, make sure that you have the necessary tools and skills first. After performing maintenance, update the records in the separate maintenance booklet.

Safety When Performing Maintenance

Some of the most important safety precautions are given here. However, we cannot warn you of every conceivable hazard that can arise in performing maintenance. Only you can decide whether or not you should perform a given task.

Maintenance Safety

- To reduce the possibility of fire or explosion, keep cigarettes, sparks, and flames away from the battery and all fuel related parts.
- Never leave rags, towels, or other flammable objects under the hood.
 - ▶ Heat from the engine and exhaust can ignite them causing a fire.
- To clean parts, use a commercially available degreaser or parts cleaner, not gasoline.
- Wear eye protection and protective clothing when working with the battery or compressed air.
- Engine exhaust contains carbon monoxide, which is poisonous and can kill you.
 - ▶ Only operate the engine if there is sufficient ventilation.

Vehicle Safety

- The vehicle must be in a stationary condition.
 - ▶ Make sure your vehicle is parked on level ground, the parking brake is set, and the engine is off.
- Be aware that hot parts can burn you.
 - ▶ Make sure to let the engine and exhaust system cool thoroughly before touching vehicle parts.
- Be aware that moving parts can injure you.
 - ▶ Do not start the engine unless instructed, and keep your hands and limbs away from moving parts.

⚠ Safety When Performing Maintenance

⚠ WARNING

Improperly maintaining this vehicle or failing to correct a problem before driving can cause a crash in which you can be seriously hurt or killed.

Always follow the inspection and maintenance recommendations according to the schedules in this owner's manual.

⚠ WARNING

Failure to properly follow maintenance instructions and precautions can cause you to be seriously hurt or killed.

Always follow the procedures and precautions in this owner's manual.

Parts and Fluids Used in Maintenance Service

The use of Acura genuine parts and fluids is recommended when maintaining and servicing your vehicle. Acura genuine parts are manufactured according to the same high quality standards used in Acura vehicles.

If the engine oil life is less than 15%, you will see the Maintenance Minder messages appear on the multi-information display every time you set the power mode to ON. The messages notify you when to change the engine oil, or when to bring your vehicle to a dealer for indicated maintenance services.

To Use Maintenance Minder™

■ Displaying the Engine Oil Life

1. Set the power mode to ON.
2. Press the  button repeatedly until the engine oil life appears on the multi-information display.

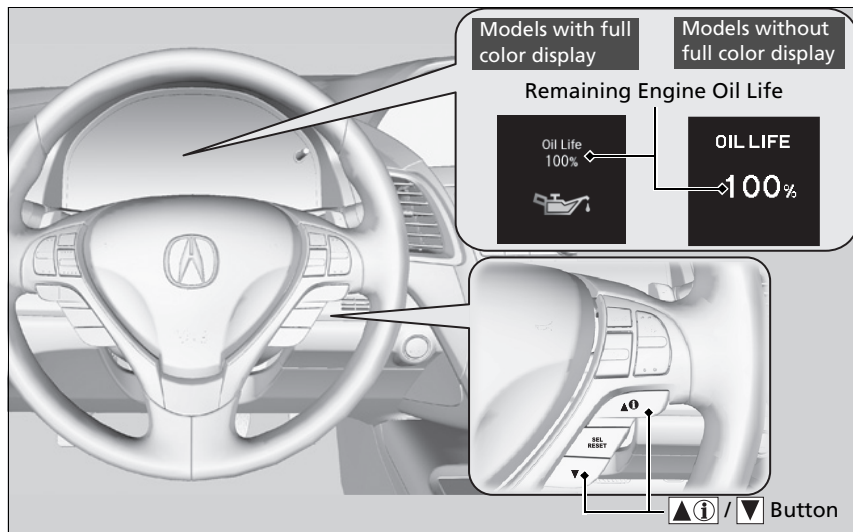

Continued

▣ Displaying the Engine Oil Life









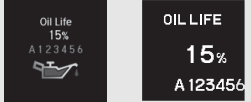

Based on the engine operating conditions, the remaining engine oil life is calculated and displayed as a percentage.

Displayed Engine Oil Life (%)	Calculated Engine Oil Life (%)
100	100 to 91
90	90 to 81
80	80 to 71
70	70 to 61
60	60 to 51
50	50 to 41
40	40 to 31
30	30 to 21
20	20 to 16
15	15 to 11
10	10 to 6
5	5 to 1
0	0

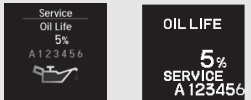
There is a list of maintenance main and sub items you can view on the multi-information display.

▣ **Maintenance Service Items** P. 351

Maintenance Minder Messages on the Multi-Information Display

Maintenance Message*1	Oil Life Display*1	Explanation	Information
<p>Maintenance Due Soon/ SERVICE DUE SOON</p> 	<p>15%</p> 	<p>The remaining engine oil life is 15 to 6 percent. Once you switch the display by pressing the /  (information) button, this message will go off.</p>	<p>The engine oil is approaching the end of its service life, and the maintenance items should be inspected and serviced soon.</p>
<p>Maintenance Due Now/ SERVICE DUE NOW</p> 	<p>5%</p> 	<p>The remaining engine oil life is 5 to 1 percent. Press the /  button to switch to another display.</p>	<p>The engine oil has almost reached the end of its service life, and the maintenance items should be inspected and serviced as soon as possible.</p>
<p>Maintenance Past Due/ SERVICE PAST DUE</p> 	<p>Negative Distance</p> 	<p>The remaining engine oil life has passed its service life, and a negative distance appears after driving over 10 miles (U.S. models) or 10 km (Canadian models). Press the /  button to switch to another display.</p>	<p>The engine oil life has passed. The maintenance items must be inspected and serviced immediately.</p>

*1: On the left: Models with full color display
On the right: Models without full color display

The system message indicator (i) comes on along with the Maintenance Minder message.

Maintenance Service Items

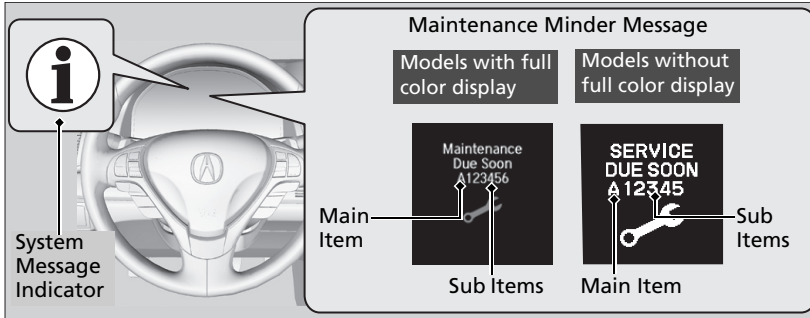

⊞ Maintenance Service Items

- Independent of the Maintenance Minder information, replace the brake fluid every 3 years.
- Inspect idle speed every 160,000 miles (256,000 km).
- Adjust the valves during services A, B, 1, 2, or 3 if they are noisy.

CODE	Maintenance Main Items
A	<ul style="list-style-type: none"> • Replace engine oil*¹
B	<ul style="list-style-type: none"> • Replace engine oil*¹ and oil filter • Inspect front and rear brakes • Check parking brake adjustment • Check expiration date for Temporary Tire Repair Kit bottle (if equipped) • Inspect tie rod ends, steering gearbox, and boots • Inspect suspension components • Inspect driveshaft boots • Inspect brake hoses and lines (Including ABS/VSA) • Inspect all fluid levels and condition of fluids • Inspect exhaust system[#] • Inspect fuel lines and connections[#]

*1: If message, **SERVICE DUE NOW** does not appear more than 12 months after the display is reset, change the engine oil every year.

#: See information on maintenance and emissions warranty.

*2: If you drive in dusty conditions, replace the air cleaner element every 15,000 miles (24,000 km).

* Not available on all models

CODE	Maintenance Sub Items
1	<ul style="list-style-type: none"> • Rotate tires
2	<ul style="list-style-type: none"> • Replace air cleaner element*² • Replace dust and pollen filter*³ • Inspect drive belt
3	<ul style="list-style-type: none"> • Replace transmission and transfer* fluid*⁴
4	<ul style="list-style-type: none"> • Replace spark plugs • Replace timing belt and inspect water pump*⁵ • Inspect valve clearance
5	<ul style="list-style-type: none"> • Replace engine coolant
6	<ul style="list-style-type: none"> • Replace rear differential fluid*

*3: If you drive primarily in urban areas that have high concentrations of soot in the air from industry and from diesel-powered vehicles, replace the dust and pollen filter every 15,000 miles (24,000 km).

*4: Driving in mountainous areas at very low vehicle speeds or trailer towing results in higher transmission and transfer temperatures. This requires transmission and transfer fluid changes more frequently than recommended by the Maintenance Minder. If you regularly drive your vehicle under these conditions, have the transmission fluid changed at 60,000 miles (100,000 km), then every 30,000 miles (48,000 km).

*5: If you drive regularly in very high temperatures (over 110 °F, 43 °C), in very low temperatures (under 20 °F, -29 °C), replace every 60,000 miles/100,000 km.

Continued

■ Resetting the Display

Reset the engine oil life display if you have performed the maintenance service.

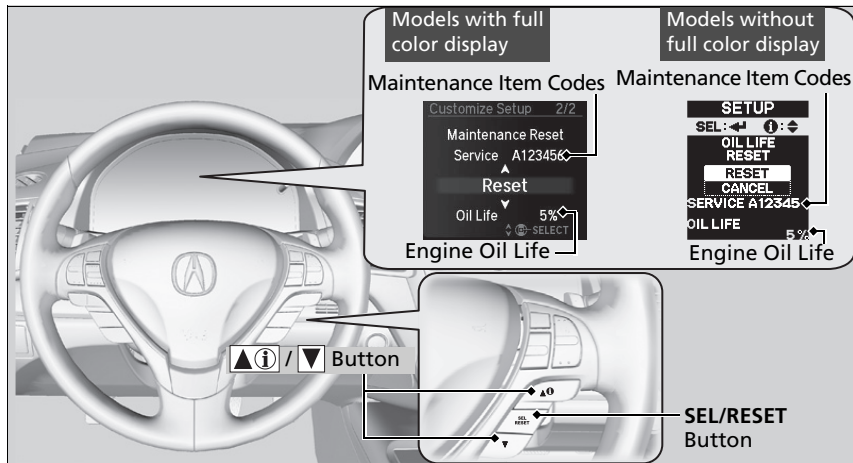

1. Set the power mode to ON.
 2. Select **VEHICLE SETTINGS/Vehicle Settings** using the **▲i / ▼** button, then press the **SEL/RESET** button.
 3. Select **MAINTENANCE INFO./Maintenance Info.** using the **▲i / ▼** button, then press the **SEL/RESET** button.
 4. Select **RESET** using the **▲i / ▼** button, then press the **SEL/RESET** button.
 - The service code will disappear and the engine oil life display will return to 100%.
- To cancel the oil life reset mode, select **CANCEL**, then press the **SEL/RESET** button.

►► Resetting the Display

NOTICE

Failure to reset the engine oil life after a maintenance service results in the system showing incorrect maintenance intervals, which can lead to serious mechanical problems.

The dealer will reset the engine oil life display after completing the required maintenance service. If someone other than a dealer performs maintenance service, reset the engine oil life display yourself.

Maintenance Items Under the Hood

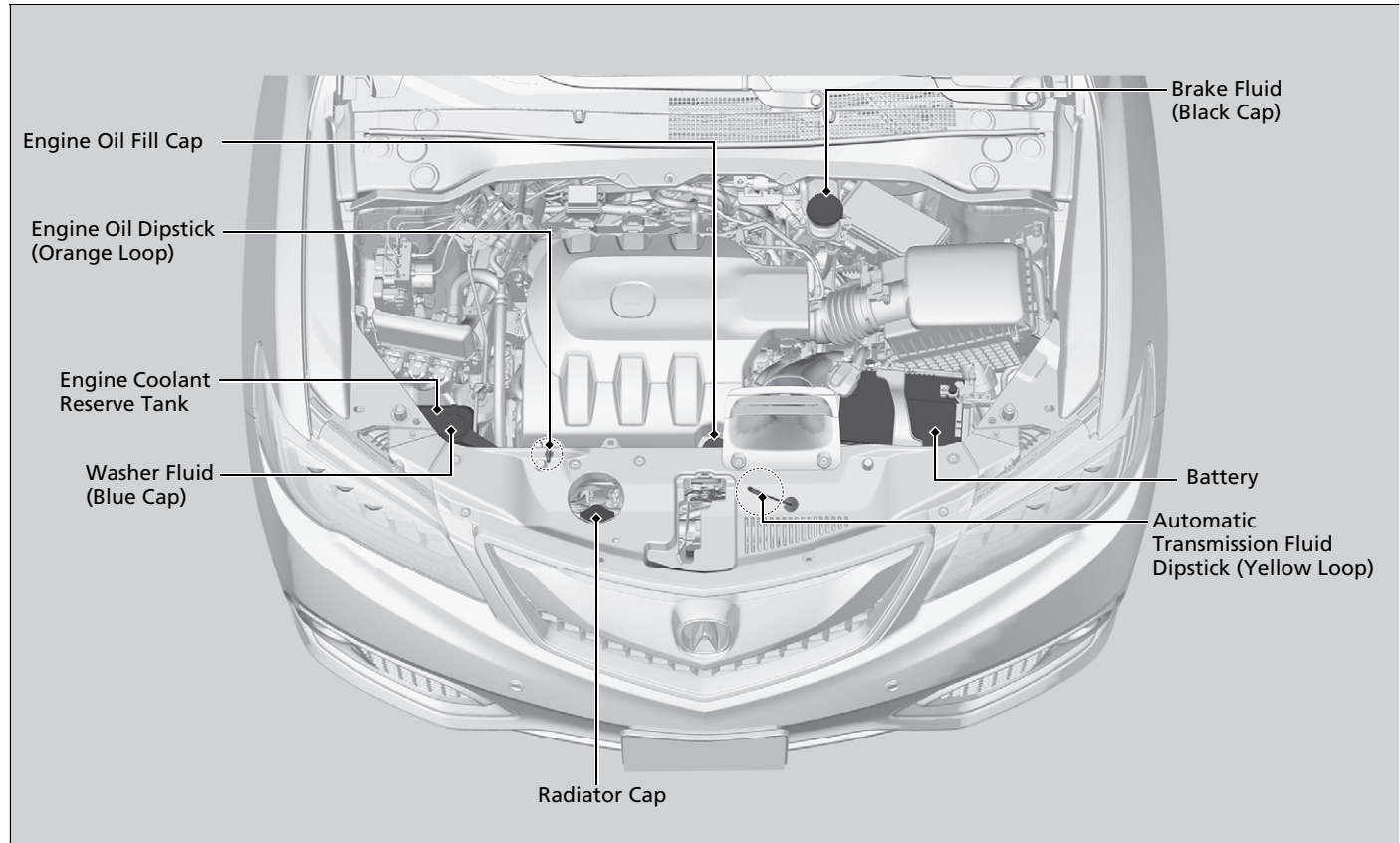

Opening the Hood

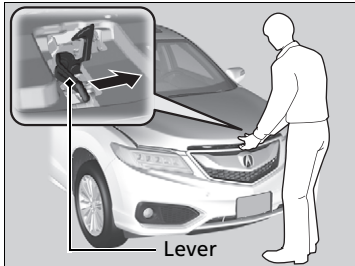
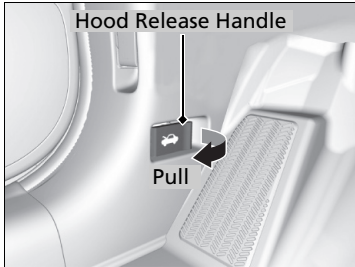

1. Park the vehicle on a level surface, and set the parking brake.
2. Pull the hood release handle under the lower left corner of the dashboard.
 - ▶ The hood will pop up slightly.
3. Slide the hood latch lever in the center of the hood to release the lock mechanism, and open the hood.
4. Lift the hood up most of the way.
 - ▶ The hydraulic supports will lift it up the rest of the way and hold it up.

When closing, lower it to approximately 12 inches (30 cm), then press down firmly with your hands.

▶▶ Opening the Hood

NOTICE

Do not open the hood when the wiper arms are raised. The hood will strike the wipers, and may damage either the hood or the wipers.

When closing the hood, check that the hood is securely latched.

If the hood latch lever moves stiffly, or if you can open the hood without lifting the lever, the latch mechanism should be cleaned and lubricated.

Recommended Engine Oil

- **Genuine Acura Motor Oil**
- **Premium-grade 0W-20 detergent oil with an API Certification Seal on the container.**



Oil is a major contributor to your engine's performance and longevity. If you drive the vehicle with insufficient or deteriorated oil, the engine may fail or be damaged.

This seal indicates the oil is energy conserving and that it meets the American Petroleum Institute's latest requirements.

Use a Genuine Acura Motor Oil or another commercial engine oil of suitable viscosity for the ambient temperature as shown.

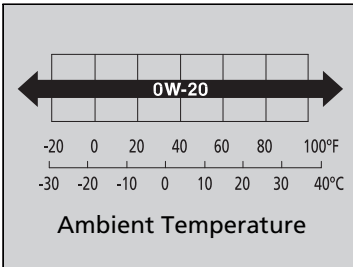

■ Synthetic oil

You may also use synthetic motor oil if it is labeled with the API Certification Seal and is the specified viscosity grade.

► Recommended Engine Oil

Engine Oil Additives

Your vehicle does not require oil additives. In fact, they may adversely affect the engine performance and durability.

Oil Check

We recommend that you check the engine oil level every time you refuel.

Park the vehicle on level ground.

Wait approximately three minutes after turning the engine off before you check the oil.

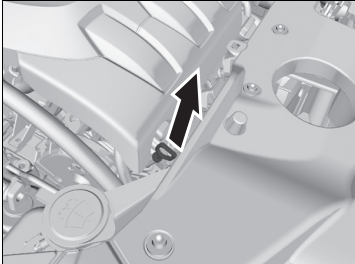

1. Remove the dipstick (orange loop).
2. Wipe the dipstick with a clean cloth or paper towel.
3. Insert the dipstick back all the way into its hole.

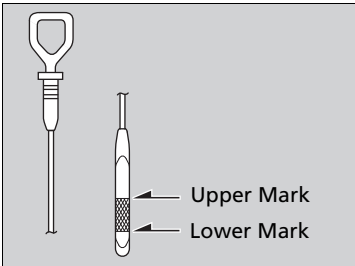

4. Remove the dipstick again, and check the level. It should be between the upper and lower marks. Add oil if necessary.

Oil Check

If the oil level is near or below the lower mark, slowly add oil being careful not to overfill.

Adding Engine Oil

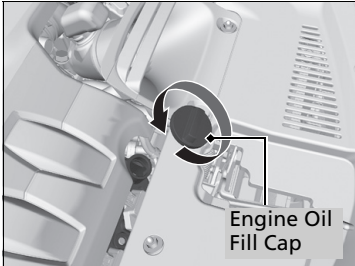

1. Unscrew and remove the engine oil fill cap.
2. Add oil slowly.
3. Reinstall the engine oil fill cap, and tighten it securely.
4. Wait for three minutes and recheck the engine oil dipstick.

⚠ Adding Engine Oil

If any oil spills, wipe it up immediately. Spilled oil may damage the engine compartment components.

NOTICE

Do not fill the engine oil above the upper mark. Overfilling the engine oil can result in leaks and engine damage.

Changing the Engine Oil and Oil Filter

You must change the engine oil and oil filter regularly in order to maintain the engine's lubrication. The engine may be damaged if they are not changed regularly.

Change the oil and filter in accordance with the maintenance message on the multi-information display.

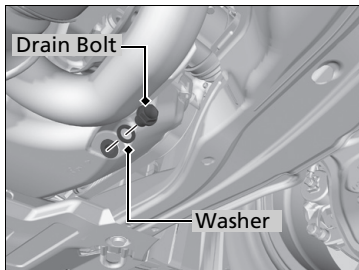

1. Run the engine until it reaches normal operating temperature, and then turn the engine off.
2. Open the hood and remove the engine oil fill cap.
3. Remove the drain bolt and washer from the bottom of the engine, and drain the oil into a suitable container.

►► Changing the Engine Oil and Oil Filter

NOTICE

You may damage the environment if you do not dispose of the oil in a suitable way. If you are changing the oil by yourself, appropriately dispose of the used oil. Put the oil in a sealed container and take it to a recycling center. Do not throw the oil away into a garbage can or onto the ground.

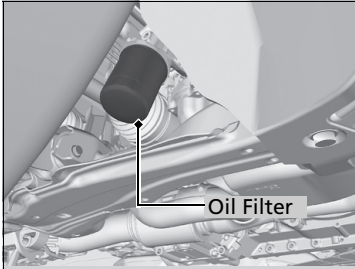

4. Remove the oil filter and dispose of the remaining oil.
5. Check that the filter gasket is not stuck to the engine contact surface.
 - If it is stuck, you must detach it.
6. Wipe away dirt and dust adhering to the contact surface of the engine block, and install a new oil filter.
 - Apply a light coat of new engine oil to the oil filter rubber seal.
7. Put a new washer on the drain bolt, then reinstall the drain bolt.
 - Tightening torque:
29 lbf·ft (39 N·m, 4.0 kgf·m)
8. Pour the recommended engine oil into the engine.
 - Engine oil change capacity (including filter):
4.5 US qt (4.3 L)
9. Reinstall the engine oil fill cap securely and start the engine.
10. Run the engine for a few minutes, and then check that there is no leak from the drain bolt or oil filter.
11. Stop the engine, wait for three minutes, and then check the oil level on the dipstick.
 - If necessary, add more engine oil.

✕ Changing the Engine Oil and Oil Filter

You will need a special wrench to replace the oil filter. You can buy this wrench from a dealer.

When installing the new oil filter, follow the instructions supplied with the oil filter.

Reinstall the engine oil fill cap. Start the engine. The low oil pressure indicator should go off within five seconds. If it does not, turn off the engine, and check your work.

Engine Coolant

Specified coolant: Acura Long Life Antifreeze/Coolant Type 2

This coolant is premixed with 50% antifreeze and 50% water. Do not add any straight antifreeze or water.

We recommend you check the engine coolant level every time you refuel. Check the reserve tank first. If it is completely empty, also check the coolant level in the radiator. Add the engine coolant accordingly.

Reserve Tank

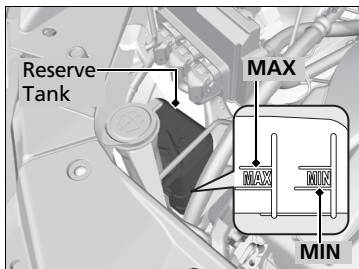

1. Check the amount of coolant in the reserve tank.

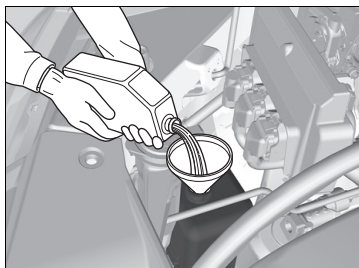

2. If the coolant level is below the **MIN** mark, add the specified coolant until it reaches the **MAX** mark.
3. Inspect the cooling system for leaks.

Engine Coolant

NOTICE

Genuine Acura engine coolant is a 50/50 mixture of antifreeze and water that can withstand freezing at temperatures as low as about -31°F (-35°C). If your vehicle is consistently subjected to temperatures below this, the concentration of antifreeze in the coolant should be increased. Consult a dealer for details.

If Acura antifreeze/coolant is not available, you may use another major brand non-silicate coolant as a temporary replacement. Check that it is a high quality coolant recommended for aluminum engines. Continued use of any non-Acura coolant can result in corrosion, causing the cooling system to malfunction or fail. Have the cooling system flushed and refilled with Acura antifreeze/coolant as soon as possible.

Do not add rust inhibitors or other additives to your vehicle's cooling system. They may not be compatible with the coolant or with the engine components.

Radiator

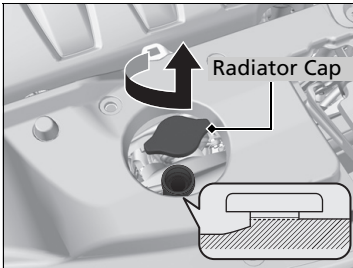

1. **Make sure the engine and radiator are cool.**
2. Turn the radiator cap counterclockwise and relieve any pressure in the coolant system. Do not push the cap down when turning.
3. Push down and turn the radiator cap counterclockwise to remove it.
4. The coolant level should be up to the base of the filler neck. Add coolant if it is low.
5. Put the radiator cap back on, and tighten it fully.
6. Pour coolant into the reserve tank until it reaches the **MAX** mark. Put the cap back on the reserve tank.

⌘ Radiator

⚠ WARNING

Removing the radiator cap while the engine is hot can cause the coolant to spray out, seriously scalding you.

Always let the engine and radiator cool down before removing the radiator cap.

NOTICE

Pour the fluid slowly and carefully so you do not spill any. Clean up any spills immediately; they can damage components in the engine compartment.

Transmission Fluid

Automatic Transmission Fluid

Specified fluid: Acura Automatic Transmission Fluid ATF DW-1

Check the fluid level when the engine is at normal operating temperature.

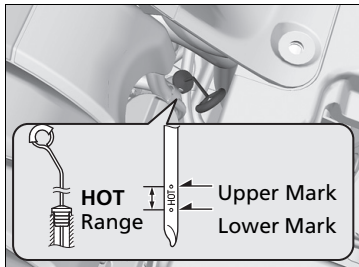

1. Park on level ground, and start the engine.
2. Wait until the radiator fan starts and then turn off the engine.
 - Perform step 3 after waiting for about 60 seconds (less than 90 seconds).
3. Remove the dipstick (yellow loop) from the transmission and wipe it with a clean cloth.
4. Insert the dipstick all the way back into the transmission securely, as shown in the image.
5. Remove the dipstick and check the fluid level.
 - It should be between the upper and lower marks in the **HOT** range.
6. If the level is below the lower mark, add fluid into the dipstick hole to bring it to the level between the upper and lower marks, and have your vehicle checked by a dealer immediately.

Automatic Transmission Fluid

NOTICE

Do not mix Acura Automatic Transmission Fluid ATF DW-1 with other transmission fluids.

Using a transmission fluid other than Acura ATF DW-1 may adversely affect the operation and durability of your vehicle's transmission, and damage the transmission.

Any damage caused by using a transmission fluid that is not equivalent to Acura ATF DW-1 is not covered by Acura's new vehicle warranty.

NOTICE

Pour the fluid slowly and carefully so you do not spill any. Clean up any spills immediately; they can damage components in the engine compartment.

Brake Fluid

Specified fluid: Acura Heavy Duty Brake Fluid DOT 3

Checking the Brake Fluid

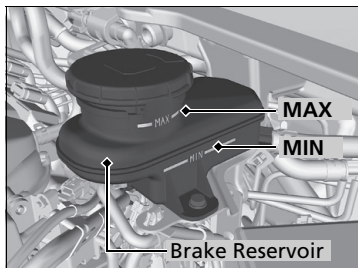

The fluid level should be between the **MIN** and **MAX** marks on the side of the reservoir.

Brake Fluid

NOTICE

Brake fluid marked DOT 5 is not compatible with your vehicle's braking system and can cause extensive damage.

If the specified brake fluid is not available, you should use only DOT 3 or DOT 4 fluid from a sealed container as a temporary replacement.

Using any non-Acura brake fluid can cause corrosion and decrease the longevity of the system. Have the brake system flushed and refilled with Acura Heavy Duty Brake Fluid DOT 3 as soon as possible.

If the brake fluid level is at or below the **MIN** mark, have a dealer inspect for leaks or worn brake pads as soon as possible.

Refilling Window Washer Fluid

Check the amount of window washer fluid using the **1/2** mark on the reservoir.
If the level is low, fill the washer reservoir.

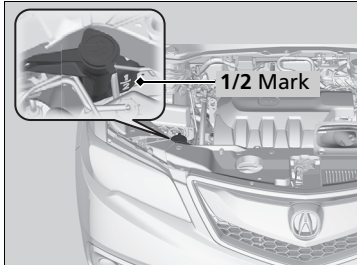

Models with washer level sensor

If the washer fluid is low, a message appears on the multi-information display.

Pour the washer fluid carefully. Do not overflow the reservoir.

▶▶ Refilling Window Washer Fluid

NOTICE

Do not use engine antifreeze or a vinegar/water solution in the windshield washer reservoir. Antifreeze can damage your vehicle's paint. A vinegar/water solution can damage the windshield washer pump.

Headlight Bulbs

Headlight bulbs are LED type. Have an authorized Acura dealer inspect and replace the light assembly

Fog Light Bulbs*

When replacing, use the following bulbs.

Fog Light: 55 W (H11)

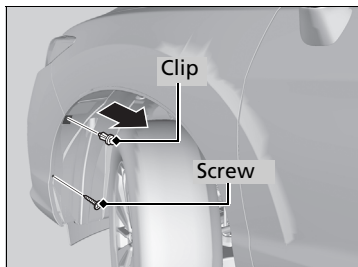

1. Turn the steering wheel all the way to the opposite side from the fog light being replaced.

Passenger side: Turn the steering wheel to the left.

Driver side: Turn the steering wheel to the right.

2. Remove the holding clip and screw, and pull the inner fender back.

Headlight Bulbs

NOTICE

The headlight aim is set by the factory, and does not need to be adjusted. However, if you regularly carry heavy items in the cargo area or tow a trailer, have the aiming readjusted at a dealer or by a qualified technician.

Fog Light Bulbs*

NOTICE

Halogen bulbs get very hot when lit. Oil, perspiration, or a scratch on the glass can cause the bulb to overheat and shatter.

The fog lights are halogen bulbs.

When replacing a bulb, handle it by its plastic case, and protect the glass from contact with your skin or hard objects. If you touch the glass, clean it with denatured alcohol and a clean cloth.

* Not available on all models

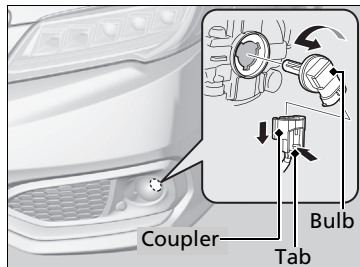

3. Push the tab to remove the coupler.
4. Rotate the old bulb to the left to remove.
5. Insert new bulb.

☒ Fog Light Bulbs*

Insert a flat-tip screwdriver, lift and remove the central pin to remove the clip.

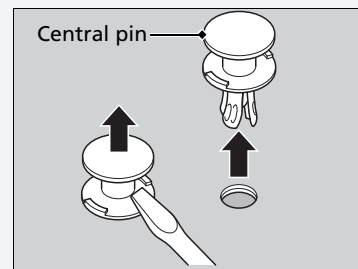

Insert the clip with the central pin raised, and push until it is flat.

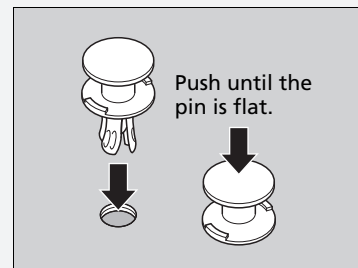

Side Turn Signal Light/Emergency Indicator Light Bulbs

Door mirror side turn light bulbs are LED type. Have an authorized Acura dealer inspect and replace the light assembly.

* Not available on all models

Front Turn Signal Light/Parking Light/Daytime Running Light and Front Side Marker Light Bulbs

When replacing, use the following bulbs.

Front Turn Signal Light/Parking Light/Daytime Running Light: LED type
Front Side Marker Light: 3CP

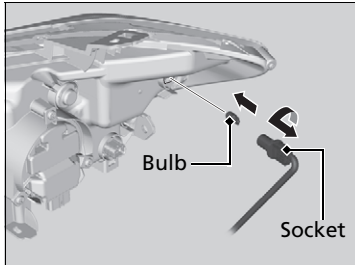

1. Turn the steering wheel all the way to the opposite side from the light being replaced.
Passenger side: Turn the steering wheel to the left.
Driver side: Turn the steering wheel to the right.
2. Remove the holding clips and screw, and pull the inner fender back.
▶ **Fog Light Bulbs*** P. 365
3. Turn the socket to the left and remove it.
4. Remove the old bulb and insert a new bulb.

▶ Front Turn Signal Light/Parking Light/Daytime Running Light and Front Side Marker Light Bulbs

Front turn signal light/parking light/daytime running light bulbs are LED type. Have an authorized Acura dealer inspect and replace the light assembly.

* Not available on all models

Brake Light/Taillight/Rear Side Marker Light and Rear Turn Signal Light Bulbs

When replacing, use the following bulbs.

Brake Light/Taillight/Rear Side Marker Light: LED type
Rear Turn Signal Light: 21 W (Amber)

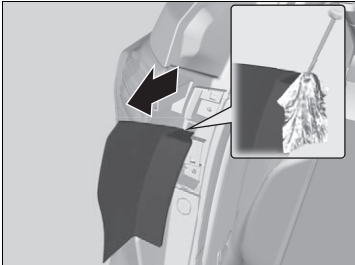

1. Remove the cover by prying on the edge using a flat-tip screwdriver.
 - ▶ Wrap the flat-tip screwdriver with a cloth to prevent scratches.

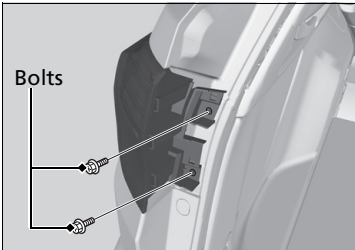

2. Use a Phillip-head screwdriver to remove the bolts.
3. Pull the light assembly out of the rear pillar.

▶ Brake Light/Taillight/Rear Side Marker Light and Rear Turn Signal Light Bulbs

Brake light/taillight/rear side marker light bulbs are LED type. Have an authorized Acura dealer inspect and replace the light assembly.

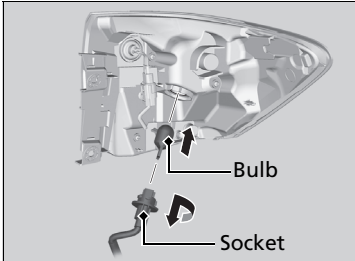

4. Turn the socket to the left and remove it.
Remove the old bulb.
5. Insert a new bulb.

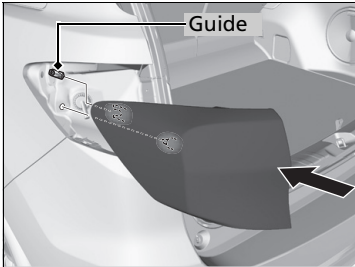

6. Reinstall the light assembly by sliding it on to the guide on the body.

Back-Up Light and Taillight Bulbs

When replacing, use the following bulbs.

Back-Up Light: 16W
Taillight: LED type



1. Remove the cover by prying on the edge using a flat-tip screwdriver.
 - ▶ Wrap the flat-tip screwdriver with a cloth to prevent scratches.

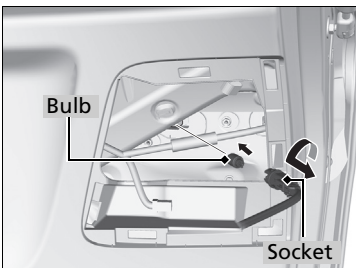

2. Turn the socket to the left and remove it. Remove the old bulb.
3. Insert a new bulb.

▶▶ Back-Up Light and Taillight Bulbs

Taillight bulbs are LED type. Have an authorized Acura dealer inspect and replace the light assembly.

Rear License Plate Light Bulb

When replacing, use the following bulb.

Rear License Plate Light: 5W



1. Remove the cover by prying on the edge using a flat-tip screwdriver.
 - ▶ Wrap the flat-tip screwdriver with a cloth to prevent scratches.

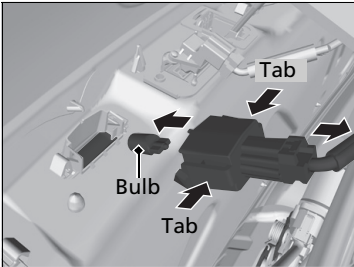

2. Push the tabs to remove the coupler.
3. Remove the old bulb.
4. Insert a new bulb.

High-Mount Brake Light Bulb

High-mount brake light bulbs are LED type. Have an authorized Acura dealer inspect and replace the light assembly.

Checking and Maintaining Wiper Blades

Checking Wiper Blades

If the wiper blade rubber has deteriorated, it will leave streaks and the hard surfaces of the blade may scratch the window glass.

Changing the Front Wiper Blade Rubber

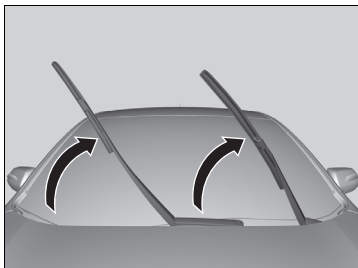

1. Lift the driver side wiper arm first, then the passenger side.

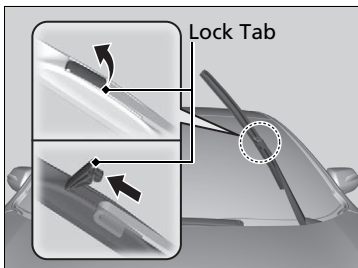

2. Place a cloth on the edge of the lock tab. Push the lock tab up with a flat-tip screw driver.
3. Slide the blade from the wiper arm.

» Changing the Front Wiper Blade Rubber

NOTICE

Avoid dropping the wiper arm; it may damage the windshield.

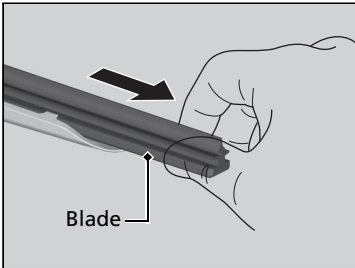

4. Slide the wiper blade out from its holder by pulling the tabbed end out.

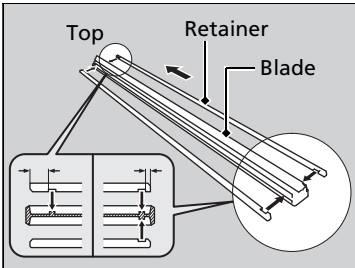

5. Remove the retainers from the rubber blade that has been removed, and mount to a new rubber blade.
 ▶ Correctly align the rubber protrusion and the retainer grooves.

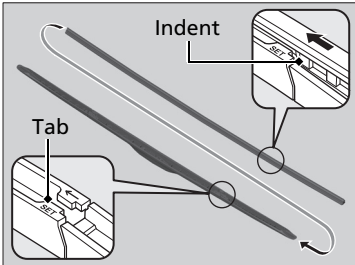

6. Slide the new wiper blade onto the holder from the bottom end.
 ▶ The tab on the holder should fit in the indent of the wiper blade.
7. Slide the wiper blade onto the wiper arm, then push down the lock tab.
8. Lower the passenger side wiper arm first, then the driver side.

Changing the Rear Wiper Blade Rubber



1. Raise the wiper arm off.

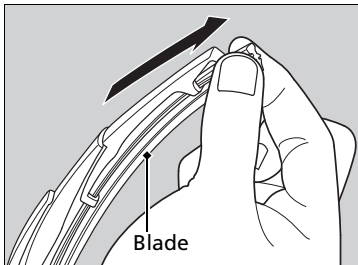

2. Slide the wiper blade out from the end with the indent.

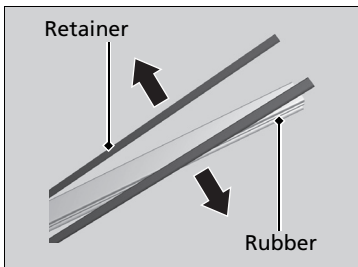

3. Remove the retainers from wiper blade and mount to a new rubber blade.

▶▶ Changing the Rear Wiper Blade Rubber

NOTICE

Avoid dropping the wiper arm; it may damage the windshield.

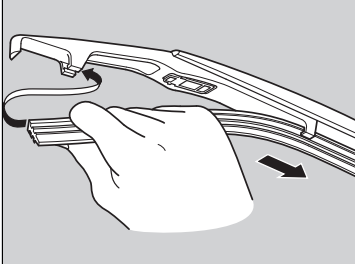

4. Slide the wiper blade onto the holder.
 - ▶ Make sure it is engaged correctly, then install the wiper blade assembly onto the wiper arm.

Checking Tires

To safely operate your vehicle, your tires must be of the proper type and size, in good condition with adequate tread, and properly inflated.

■ Inflation guidelines

Properly inflated tires provide the best combination of handling, tread life, and comfort. Refer to the driver's doorjamb label or specification's page for the specified pressure.

Underinflated tires wear unevenly, adversely affect handling and fuel economy, and are more likely to fail from overheating.

Overinflated tires make your vehicle ride harshly, are more prone to road hazards, and wear unevenly.

Every day before you drive, look at each of the tires. If one looks lower than the others, check the pressure with a tire gauge.

At least once a month and before long trips, use a gauge to measure the pressure in all tires, including the spare. Even tires in good condition can lose 1 to 2 psi (10 to 20 kPa, 0.1 to 0.2 kgf/cm²) per month.

■ Inspection guidelines

Every time you check inflation, also examine the tires and valve stems. Look for:

- Bumps or bulges on the side or in the tread. Replace the tire if you find any cuts, splits, or cracks in the side of the tire. Replace it if you see fabric or cord.
- Remove any foreign objects and inspect for air leaks.
- Uneven tread wear. Have a dealer check the wheel alignment.
- Excessive tread wear.

➔ **Wear Indicators** P. 381

- Cracks or other damage around valve stem.

🔍 Checking Tires

⚠️ WARNING

Using tires that are excessively worn or improperly inflated can cause a crash in which you can be seriously hurt or killed.

Follow all instructions in this owner's manual regarding tire inflation and maintenance.

Measure the air pressure when tires are cold. This means the vehicle has been parked for at least three hours, or driven less than 1 mile (1.6 km). If necessary, add or release air until the specified pressure is reached.

If checked when hot, tire pressure can be as much as 4–6 psi (30–40 kPa, 0.3–0.4 kgf/cm²) higher than if checked when cold.

Have a dealer check the tires if you feel a consistent vibration while driving. New tires and any that have been removed and reinstalled should be properly balanced.

Tire and Loading Information Label

The label attached to the driver's doorjamb provides necessary tire and loading information.

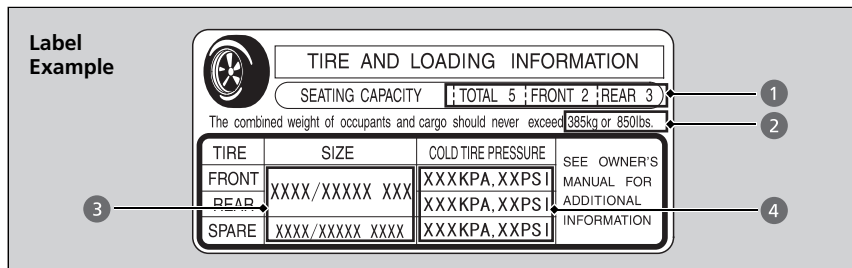

Tire and Loading Information Label

The tire and loading information label attached to the driver's doorjamb contains:

- 1 The number of people your vehicle can carry.
- 2 The total weight your vehicle can carry. Do not exceed this weight.
- 3 The original tire sizes for front, rear, and spare.
- 4 The proper cold tire pressure for front, rear, and spare.

Tire Labeling

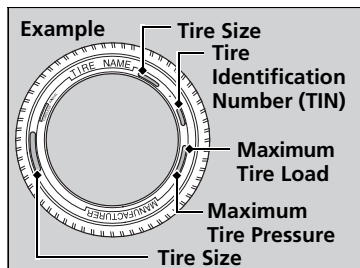

The tires that came on your vehicle have a number of markings. Those you should be aware of are described below.

Tire Sizes

Following is an example of tire size with an explanation of what each component means.

P235/60R18 102V

P: Vehicle type (P indicates passenger vehicle).

235: Tire width in millimeters.

60: Aspect ratio (the tire's section height as a percentage of its width).

R: Tire construction code (R indicates radial).

18: Rim diameter in inches.

102: Load index (a numerical code associated with the maximum load the tire can carry).

V: Speed symbol (an alphabetical code indicating the maximum speed rating).

Tire Sizes

Whenever tires are replaced, they should be replaced with tires of the same size.

■ Tire Identification Number (TIN)

The tire identification number (TIN) is a group of numbers and letters that look like the example in the side column. TIN is located on the sidewall of the tire.

■ Glossary of Tire Terminology

Cold Tire Pressure – The tire air pressure when the vehicle has been parked for at least three hours or driven less than 1 mile (1.6 km).

Load Rating – Means the maximum load that a tire is rated to carry for a given inflation pressure.

Maximum Inflation Pressure – The maximum tire air pressure that the tire can hold.

Maximum Load Rating – Means the load rating for a tire at the maximum permissible inflation pressure for that tire.

Recommended Inflation Pressure – The cold tire inflation pressure recommended by the manufacturer.

Treadwear Indicators (TWI) – Means the projections within the principal grooves designed to give a visual indication of the degrees of wear of the tread.

► Tire Identification Number (TIN)

DOT B97R FW6X 2209

DOT: This indicates that the tire meets all requirements of the U.S. Department of Transportation.

B97R: Manufacturer's identification mark.

FW6X: Tire type code.

22 09: Date of manufacture.

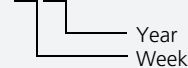

DOT Tire Quality Grading (U.S. Vehicles)

The tires on your vehicle meet all U.S. Federal Safety Requirements. All tires are also graded for treadwear, traction, and temperature performance according to Department of Transportation (DOT) standards. The following explains these gradings.

Uniform Tire Quality Grading

Quality grades can be found where applicable on the tire sidewall between tread shoulder and maximum section width.

Treadwear

The treadwear grade is a comparative rating based on the wear rate of the tire when tested under controlled conditions on a specified government test course. For example, a tire graded 150 would wear one and one-half (1 1/2) times as well on the government course as a tire graded 100. The relative performance of tires depends upon the actual conditions of their use, however, and may depart significantly from the norm due to variations in driving habits, service practices and differences in road characteristics and climate.

Uniform Tire Quality Grading

For example:
Treadwear 200
Traction AA
Temperature A

All passenger car tires must conform to Federal Safety Requirements in addition to these grades.

■ Traction

The traction grades, from highest to lowest, are AA, A, B, and C. Those grades represent the tire's ability to stop on wet pavement as measured under controlled conditions on specified government test surfaces of asphalt and concrete. A tire marked C may have poor traction performance.

■ Temperature

The temperature grades are A (the highest), B, and C, representing the tire's resistance to the generation of heat and its ability to dissipate heat when tested under controlled conditions on a specified indoor laboratory test wheel. Sustained high temperature can cause the material of the tire to degenerate and reduce tire life, and excessive temperature can lead to sudden tire failure. The grade C corresponds to a level of performance which all passenger car tires must meet under the Federal Motor Vehicle Safety Standard No. 109. Grades B and A represent higher levels of performance on the laboratory test wheel than the minimum required by law.

» Traction

Warning: The traction grade assigned to this tire is based on straight-ahead braking traction tests, and does not include acceleration, cornering, hydroplaning, or peak traction characteristics.

» Temperature

Warning: The temperature grade for this tire is established for a tire that is properly inflated and not overloaded. Excessive speed, underinflation, or excessive loading, either separately or in combination, can cause heat buildup and possible tire failure.

Wear Indicators

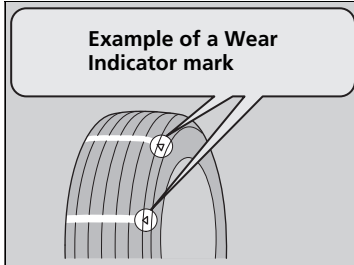

The groove where the wear indicator is located is 1/16 inch (1.6 mm) shallower than elsewhere on the tire. If the tread has worn so that the indicator is exposed, replace the tire.

Worn out tires have poor traction on wet roads.

Tire Service Life

The life of your tires is dependent on many factors, including driving habits, road conditions, vehicle loading, inflation pressure, maintenance history, speed, and environmental conditions (even when the tires are not in use).

In addition to regular inspections and inflation pressure maintenance, it is recommended that you have annual inspections performed once the tires reach five years old. All tires, including the spare, should be removed from service after 10 years from the date of manufacture, regardless of their condition or state of wear.

Tire and Wheel Replacement

Replace your tires with radials of the same size, load range, speed rating, and maximum cold tire pressure rating (as shown on the tire's sidewall). Using tires of a different size or construction can cause the ABS, vehicle stability assist (VSA®), hill start assist, and the All-Wheel Drive (AWD) with intelligent control system* to work incorrectly.

It is best to replace all four tires at the same time. If that isn't possible, replace the front or rear tires in pairs.

If you replace a wheel, only use TPMS specified wheels approved for your vehicle.

Make sure that the wheel's specifications match those of the original wheels.

▶▶ Tire and Wheel Replacement

WARNING

Installing improper tires on your vehicle can affect handling and stability. This can cause a crash in which you can be seriously hurt or killed.

Always use the size and type of tires recommended in this owner's manual.

Tire Rotation

Rotating tires according to the maintenance messages on the multi-information display helps to distribute wear more evenly and increase tire life.

■ Tires without rotation marks

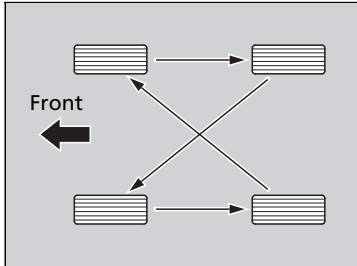

Rotate the tires as shown here.

■ Tires with rotation marks

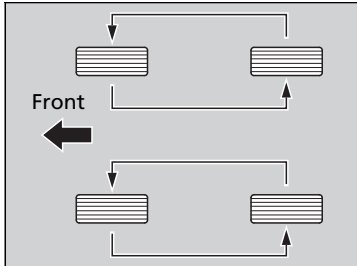

Rotate the tires as shown here.

☒ Tire Rotation

Tires with directional tread patterns should only be rotated front to back (not from one side to the other). Directional tires should be mounted with the rotation indication mark facing forward, as shown below.

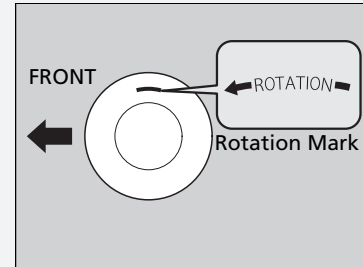

Winter Tires

If driving on snowy or frozen roads, mount all season marked “M+S” tires, snow tires, or tire chains; reduce speed; and maintain sufficient distance between vehicles when driving.

Be particularly careful when operating the steering wheel or brakes to prevent skidding.

Use tire chains, snow tires, or all season tires when necessary or according to the law.

When mounting, refer to the following points.

For winter tires:

- Select the size and load ranges that are the same as the original tires.
- Mount the tires to all four wheels.

For tire chains:

- Install them on the front tires only.
- Because your vehicle has limited tire clearance, we strongly recommend using the chains listed below:

Cable-type: SCC Radial Chain TC2212MM

- Follow the chain manufacturer’s instruction when installing. Mount them as tightly as you can.
- Check that the chains do not touch the brake lines or suspension.
- Drive slowly.

❧ Winter Tires

⚠ WARNING

Using the wrong chains, or not properly installing chains, can damage the brake lines and cause a crash in which you can be seriously injured or killed.

Follow all instructions in this owner’s manual regarding the selection and use of tire chains.

NOTICE

Traction devices that are the wrong size or improperly installed can damage your vehicle’s brake lines, suspension, body, and wheels. Stop driving if they are hitting any part of the vehicle.

When tire chains are mounted, follow the chain manufacturer’s instructions regarding vehicle operational limits.

If your vehicle is equipped with summer tires, be aware that these tires are not designed for winter driving conditions. For more information, contact a dealer.

Checking the Battery

Check the battery terminals for corrosion monthly.

If your vehicle's battery is disconnected or goes dead:

- The audio system is disabled.
 - **Reactivating the audio system** P. 190
- The clock resets.
 - **Setting the Clock** P. 120
- The navigation system* is disabled.
 - **Refer to navigation system manual**

Charging the Battery

Disconnect both battery cables to prevent damaging your vehicle's electrical system. Always disconnect the negative (-) cable first, and reconnect it last.

ⓘ Battery

⚠ WARNING

The battery gives off explosive hydrogen gas during normal operation.

A spark or flame can cause the battery to explode with enough force to kill or seriously hurt you.

When conducting any battery maintenance, wear protective clothing and a face shield, or have a skilled technician do it.

WARNING: Battery post, terminals, and related accessories contain lead and lead compounds.

Wash your hands after handling.

When you find corrosion, clean the battery terminals by applying a baking powder and water solution. Rinse the terminals with water. Cloth/towel dry the battery. Coat the terminals with grease to help prevent future corrosion.

When replacing the battery, the replacement must be of the same specifications.

Please consult a dealer for more information.

* Not available on all models

Replacing the Button Battery

Models without two-way keyless access remote

If the indicator does not come on when the button is pressed, replace the battery.

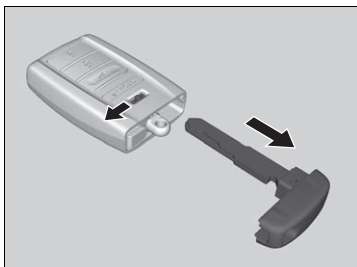

Battery type: CR2032

1. Remove the built-in key.
2. Remove the upper half by carefully prying on the edge with a coin.
 - ▶ Wrap a coin with a cloth to prevent scratching the transmitter.
3. Make sure to replace the battery with the correct polarity.

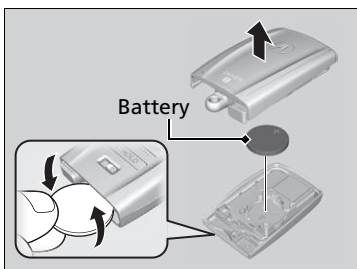

» Replacing the Button Battery

NOTICE

An improperly disposed of battery can damage the environment. Always confirm local regulations for battery disposal.

Replacement batteries are commercially available or at a dealer.

Models with two-way keyless access remote

If the indicator does not come on when the button is pressed, replace the battery.

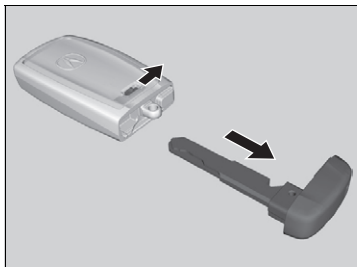

Battery type: CR2032

1. Remove the built-in key.
 - ▶ As a convenience, lightly place masking tape over the remote buttons to hold them in place.
2. Remove the upper half by carefully prying on the edge with a coin.
 - ▶ Wrap a coin with a cloth to prevent scratching the transmitter.
3. Press down on the center of the assembly and remove the battery.
 - ▶ When removing the button battery, be careful not to touch parts around it.
4. Make sure to replace the battery with the correct polarity.

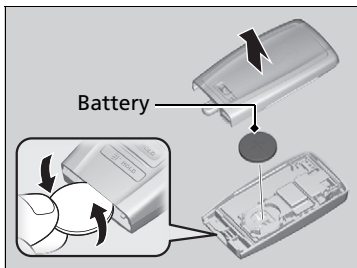

▶▶ Replacing the Button Battery

Models with two-way keyless access remote

NOTICE

The Remote transmitter is equipped with two batteries: A standard replaceable CR2032 coin button battery and an integral non-replaceable rechargeable battery. To prevent permanent damage to the rechargeable battery, replace the CR2032 battery every three to four years.

Dust and Pollen Filter

The climate control system is equipped with a dust and pollen filter that collects pollen, dust, and other debris in the air. The Maintenance Minder™ messages will let you know when to replace the filter.

We recommend that you replace the dust and pollen filter sooner when using your vehicle in areas with high concentrations of dust.

» Dust and Pollen Filter

If the airflow from the climate control system deteriorates noticeably, and the windows fog up easily, the filter may need to be replaced. Please contact a dealer for replacement.

Interior Care

Use a damp cloth with a mixture of mild detergent and warm water to remove dirt. Use a clean cloth to remove detergent residue.

Cleaning Seat Belts

Use a soft brush with a mixture of mild soap and warm water to clean the seat belts. Let the belts air dry. Wipe the openings of the seat belt anchors using a clean cloth.

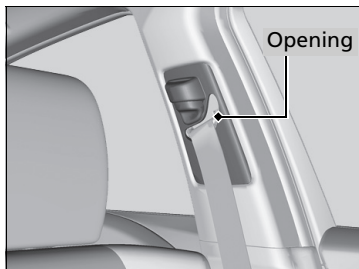

Cleaning the Window

Wipe using a glass cleaner.

Interior Care

Do not spill liquids inside the vehicle. Electrical devices and systems may malfunction if liquids are splashed on them.

Do not use silicone based sprays on electrical devices such as audio devices and switches. Doing so may cause the items to malfunction or a fire inside the vehicle.

If a silicone based spray is inadvertently used on electrical devices, consult a dealer.

Depending on their composition, chemicals and liquid aromatics may cause discoloration, wrinkles, and cracking to resin-based parts and textiles. Do not use alkali solvents or organic solvents such as benzene or gasoline.

After using chemicals, make sure to gently wipe them off using a dry cloth.

Do not place used cloths on top of resin based parts or textiles for long periods of time without washing.

Cleaning the Window

Wires are mounted to the inside of the rear window. Wipe along the same direction as the wires with a soft cloth so as not to damage them.

■ Floor Mats

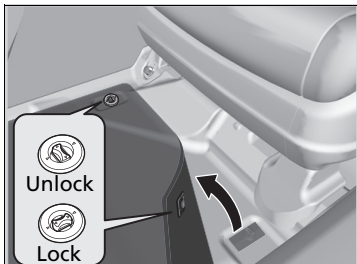

The front floor mats hook over the floor anchors, which keep the mats from sliding forward. To remove a mat for cleaning, turn the anchor knobs to the unlock position. When reinstalling the mat after cleaning, turn the knobs to the lock position.

Do not put additional floor mats on top of the anchored mat.

■ Maintaining Genuine Leather

Vacuum dirt and dust from the leather frequently. Pay close attention to the pleats and seams. Clean the leather with a soft cloth dampened with a 90% water and 10% neutral soap solution. Then buff it with a clean, dry cloth. Remove any dust or dirt on leather surfaces immediately.

▣ Floor Mats

If you use any floor mats that were not originally provided with your vehicle, make sure they are designed for your specific vehicle, fit correctly, and are securely anchored by the floor anchors. Position the rear seat floor mats properly. If they are not properly positioned, the floor mats can interfere with the front seat functions.

Exterior Care

Dust off the vehicle body after you drive.

Regularly inspect your vehicle for scratches on painted surfaces. A scratch on a painted surface can result in body rust. If you find a scratch, promptly repair it.

■ Washing the Vehicle

Wash the vehicle regularly. Wash more frequently when driving in the following conditions:

- If driving on roads with road salt.
- If driving in coastal areas.
- If tar, soot, bird droppings, insects, or tree sap are stuck to painted surfaces.

■ Using an Automated Car Wash

Fold in the door mirrors.

Make sure to follow the instructions indicated on the automated car wash.

■ Using High Pressure Cleaners

- Keep sufficient distance between the cleaning nozzle and the vehicle body.
- Take particular care around the windows. Standing too close may cause water to enter the vehicle interior.
- Do not spray high pressure water directly into the engine compartment. Instead, use low pressure water and a mild detergent.

▶▶ Washing the Vehicle

Do not spray water into the air intake vents. It can cause a malfunction.

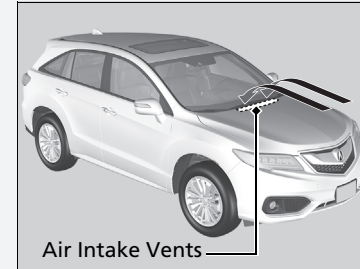

■ Applying Wax

A good coat of automotive body wax helps protect your vehicle's paint from the elements. Wax will wear off over time and expose your vehicle's paint to the elements, so reapply as necessary.

■ Maintaining the Bumpers and Other Resin Coated Parts

If you get gasoline, oil, engine coolant, or battery fluid on resin coated parts, they may be stained or the coating may peel. Promptly wipe it away using a soft cloth and clean water.

■ Cleaning the Window

Wipe using a glass cleaner.

■ Maintaining Aluminum Wheels

Aluminum is susceptible to deterioration caused by salt and other road contaminants. Use a sponge and mild detergent to wipe away promptly. Be careful not to use harsh chemicals (including some commercial wheel cleaners) or a stiff brush. They can damage the clear coat of the aluminum alloy wheels that helps keep the aluminum from corroding and tarnishing.

►► Applying Wax

NOTICE

Chemical solvents and strong cleaners can damage the paint, metal, and plastic on your vehicle. Wipe up spills immediately.

►► Maintaining the Bumpers and Other Resin Coated Parts

Ask a dealer about the correct coating material when you want to repair the painted surface of the parts made of resin.

■ Fogged Exterior Light Lenses

The inside lenses of exterior lights (headlights, brake lights, etc.) may fog temporarily if you have driven in the rain, or after the vehicle has been run through a car wash. Dew condensation also may build up inside the lenses when there is a significant enough difference between the ambient and inside lens temperatures (similar to vehicle windows fogging up in rainy conditions).

These conditions are natural processes, not structural design problems in the exterior lights.

Lens design characteristics may result in moisture developing on the light lens frame surfaces. This also is not a malfunction.

However, if you see large amounts water accumulation, or large water drops building up inside the lenses, have your vehicle inspected by a dealer.

Handling the Unexpected

This chapter explains how to handle unexpected troubles.



Tools

Types of Tools 396

If a Tire Goes Flat

Changing a Flat Tire* 397

Temporarily Repairing a Flat Tire* 403

Engine Does Not Start

Checking the Engine 414

If the Keyless Access Remote Battery is

Weak 415

Emergency Engine Stop 416

Jump Starting 417

Shift Lever Does Not Move 419

Overheating

How to Handle Overheating 420

Indicator, Coming On/Blinking

If the Low Oil Pressure Indicator Comes

On 422

If the Charging System Indicator Comes

On 422

If the Malfunction Indicator Lamp Comes

On or Blinks 423

If the Brake System Indicator (Red) Comes

On 424

If the Electric Power Steering (EPS) System

Indicator Comes On 424

If the Low Tire Pressure/TPMS Indicator

Comes On or Blinks 425

Fuses

Fuse Locations 426

Inspecting and Changing Fuses 428

Emergency Towing 429

When You Cannot Open the Tailgate 430

* Not available on all models

Types of Tools

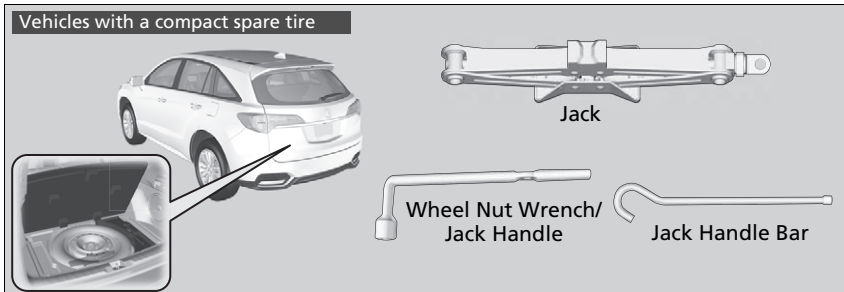

Types of Tools

The tools are stored in the luggage area.

Changing a Flat Tire *

If a tire goes flat while driving, grasp the steering wheel firmly, and brake gradually to reduce speed. Then, stop in a safe place. Replace the flat tire with a compact spare tire. Go to a dealer as soon as possible to have the full-size tire repaired or replaced.

1. Park the vehicle on firm, level, non-slippery surface and apply the parking brake.
2. Move the shift lever to **P**.
3. Turn on the hazard warning lights and set the power mode to VEHICLE OFF (LOCK).

✘ Changing a Flat Tire *

Periodically check the tire pressure of the compact spare. It should be set to the specified pressure.
Specified Pressure: 60 psi (420 kPa, 4.2 kgf/cm²)

When driving with the compact spare tire, keep the vehicle speed under 50 mph (80 km/h). Replace with a full-size tire as soon as possible.

The compact spare tire and wheel in your vehicle are specifically for this model. Do not use them with another vehicle. Do not use another type of compact spare tire or wheel with your vehicle.

Do not mount tire chains on a compact spare tire. If a chain-mounted front tire goes flat, remove one of the full-size rear tires and replace it with the compact spare tire. Remove the flat front tire and replace it with the full-size tire that was removed from the rear. Mount the tire chains on the front tire.

Do not use a puncture-repairing agent on a flat tire, as it can damage the tire pressure sensor.

* Not available on all models

■ Getting Ready to Replace the Flat Tire

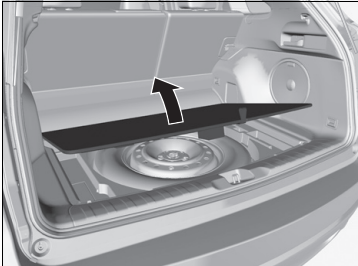

1. Open the cargo area floor lid.

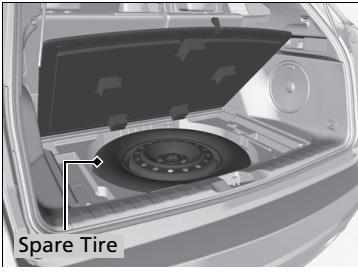

2. Take the wheel nut wrench and jack handle out of the cargo area.

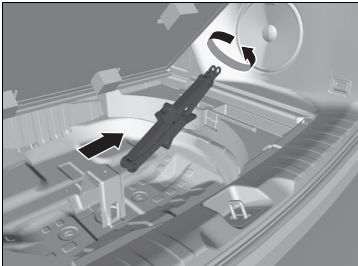

3. Unscrew the wing bolt, and remove the spacer cone. Then, remove the spare tire.
4. Take the jack out of the spare tire area.

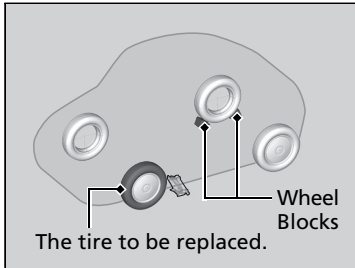

5. Place a wheel block or rock in front and rear of the wheel diagonal to the flat tire.

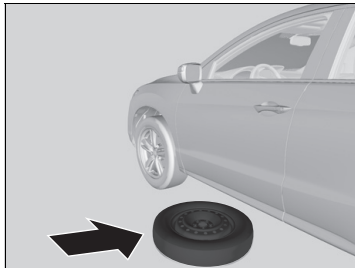

6. Place the compact spare tire (wheel side up) under the vehicle body, near the tire that needs to be replaced.



7. Loosen each wheel nut about one turn using the wheel nut wrench.

■ How to Set Up the Jack

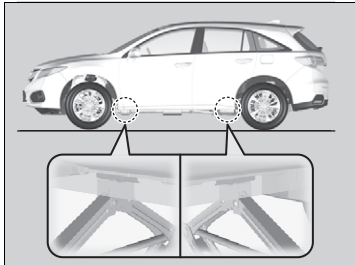

1. Place the jack under the jacking point closest to the tire to be changed.

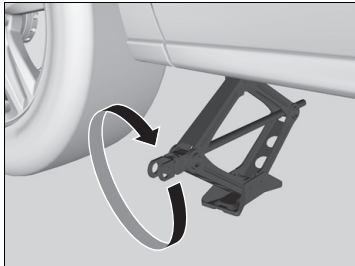

2. Turn the end bracket (as shown in the image) clockwise until the top of the jack contacts the jacking point.
▶ Make sure that the jacking point tab is resting in the jack notch.

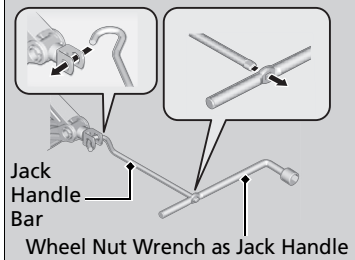

3. Raise the vehicle, using the jack handle bar and the jack handle, until the tire is off the ground.

▶▶ How to Set Up the Jack

⚠ WARNING

The vehicle can easily roll off the jack, seriously injuring anyone underneath.

Follow the directions for changing a tire exactly, and never get under the vehicle when it is supported only by the jack.

Do not use the jack with people or luggage in the vehicle.

Use the jack provided in your vehicle. Other jacks may not support the weight ("load") or may not fit the jacking point.

The following instructions must be followed to use the jack safely:

- Do not use while the engine is running.
- Use only where the ground is firm and level.
- Use only at the jacking points.
- Do not get in the vehicle while using the jack.
- Do not put anything on top of or underneath the jack.

Replacing the Flat Tire

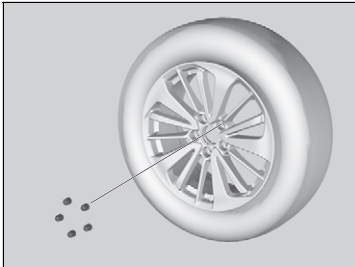

1. Remove the wheel nuts and flat tire.

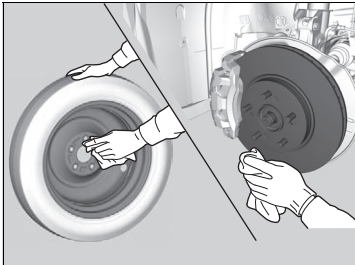

2. Wipe the mounting surfaces of the wheel with a clean cloth.

3. Mount the compact spare tire.

4. Screw the wheel nuts until they touch the lips around the mounting holes, then stop rotating.

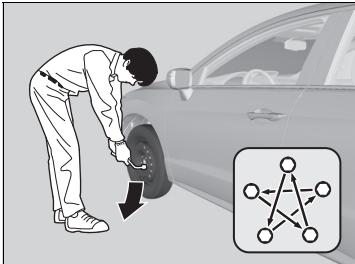

5. Lower the vehicle and remove the jack. Tighten the wheel nuts in the order indicated in the image. Go around, tightening the nuts, two to three times in this order.

Wheel nut torque:

80 lbf·ft (108 N·m, 11 kgf·m)

Replacing the Flat Tire

Do not over tighten the wheel nuts by applying extra torque using your foot or a pipe.

Continued

■ Storing the Flat Tire

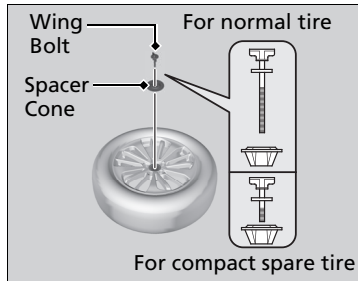

1. Store the jack in its holder. Turn the jack's end bracket to lock it in place.
2. Remove the center cap.
3. Place the flat tire face up in the spare tire well.
4. Remove the spacer cone from the wing bolt for the spare tire, and insert the wing bolt for the normal tire back on the bolt. Secure the flat tire with the wing bolt.
5. Securely store the wheel nut wrench and jack handle bar back in the cargo area.

■ TPMS and the Spare Tire

If you replace a flat tire with the spare tire, the low tire pressure/TPMS indicator comes on while you are driving. After driving for a few miles (kilometers), the indicator will start blinking for a short time and then stay on. **CHECK TPMS SYSTEM/Tire Pressure Monitor Problem** appears on the multi-information display, but this is normal.

If you replace the tire with a specified regular tire, the warning message on the multi-information display and the low tire pressure/TPMS indicator will go off after a few miles (kilometers).

▶▶ Storing the Flat Tire

⚠ WARNING

Loose items can fly around the interior in a crash and can seriously injure the occupants.
Store the wheel, jack, and tools securely before driving.

▶▶ TPMS and the Spare Tire

The system cannot monitor the pressure of the spare tire. Manually check the spare tire pressure to be sure that it is correct.

Use the TPMS specific wheels. Each is equipped with a tire pressure sensor mounted inside the tire behind the valve stem.

Temporarily Repairing a Flat Tire *

If the tire has a large cut or is otherwise severely damaged, you will need to have the vehicle towed. If the tire only has a small puncture, from a nail for instance, you can use the temporary tire repair kit so that you can drive to the nearest service station for a more permanent repair.

If a tire goes flat while driving, grasp the steering wheel firmly, and brake gradually to reduce speed. Then stop in a safe place.

1. Park the vehicle on a firm, level, and non-slippery surface and apply the parking brake.
2. Move the shift lever to **P**.
3. Turn on the hazard warning lights and set the power mode to VEHICLE OFF (LOCK).

Temporarily Repairing a Flat Tire*

The kit should not be used in the following situations. Instead, contact a dealer or a roadside assistant to have the vehicle towed.

- The tire sealant has expired.
- More than one tire is punctured.
- The puncture or cut is larger than 3/16 inch (4mm).
- The tire side wall is damaged or the puncture is outside the contact area.

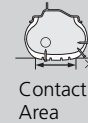

When the puncture is:	Kit Use
Smaller than 3/16 inch (4 mm)	Yes
Larger than 3/16 inch (4 mm)	No

- Damage has been caused by driving with the tire extremely under inflated.
- The tire bead is no longer seated.
- The rim is damaged.

Do not remove a nail or screw that punctured the tire. If you remove it from the tire, you may not be able to repair the puncture using the kit.

NOTICE

Do not use a puncture-repairing agent other than the one provided in the kit that came with your vehicle. If a different agent is used, you may permanently damage the tire pressure sensor.

■ Getting Ready to Temporarily Repair the Flat Tire

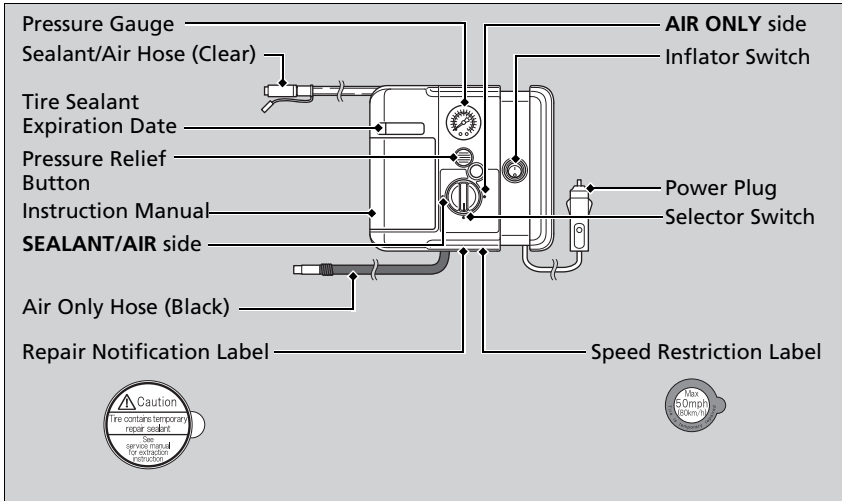

▣ Getting Ready to Temporarily Repair the Flat Tire

Repair notification label and speed restriction label are applied to the side of temporary tire repair kit.

When making a temporary repair, carefully read the instruction manual provided with the kit.

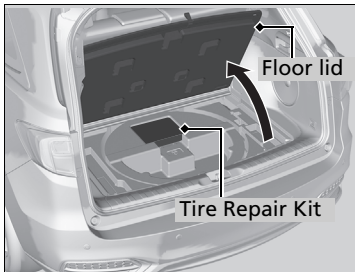

1. Open the cargo area floor lid.
2. Take the kit out of the tool box.
3. Place the kit face up, on flat ground near the flat tire, and away from traffic. Do not place the kit on its side.

Injecting Sealant and Air

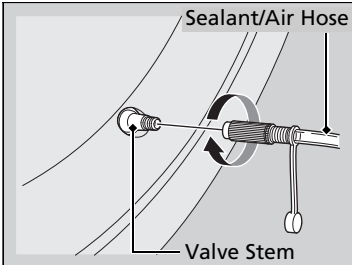
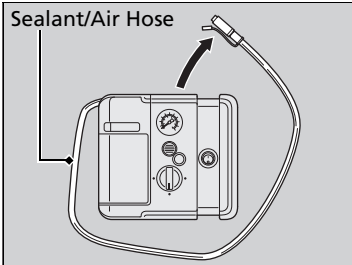
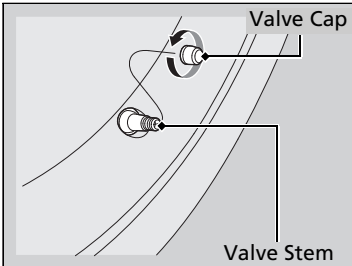

1. Remove the valve cap from the tire valve stem.

2. Remove the sealant/air hose from the packaging.

3. Attach the sealant/air hose onto the tire valve stem. Screw it until it is tight.

Injecting Sealant and Air

⚠ WARNING

Tire sealant contains substances that are harmful and can be fatal if swallowed.

If accidentally swallowed, do not induce vomiting. Drink plenty of water and get medical attention immediately.

For skin or eye contact, flush with cool water and get medical attention if necessary.

In cold temperatures, the sealant may not flow easily. In this situation, warm it up for five minutes before using.

The sealant can permanently stain clothing and other materials. Be careful during handling and wipe away any spills immediately.

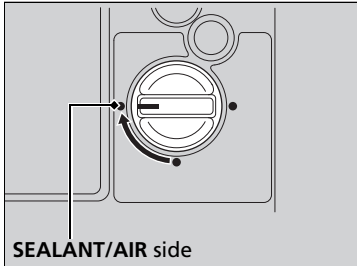
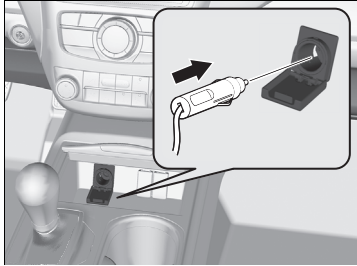

4. Plug in the compressor to the accessory power socket.

- ▶ Be careful not to pinch the cord in a door or window.
- ▶ Do not plug any other electronic devices into other accessory power sockets.

🔧 **Accessory Power Sockets** P. 176

5. Start the engine.

- ▶ Keep the engine running while injecting sealant and air.

🔧 **Carbon Monoxide Gas** P. 64

6. Turn the selector switch to **SEALANT/AIR**.

🔧 **Injecting Sealant and Air**

⚠️ WARNING

Running the engine with the vehicle in an enclosed or even partly enclosed area can cause a rapid build-up of toxic carbon monoxide.

Breathing this colorless, odorless gas can cause unconsciousness and even death.

Only run the engine to power the air compressor with the vehicle outdoors.

NOTICE

Do not operate the temporary tire repair kit compressor for more than 15 minutes. The compressor can overheat and become permanently damaged.

Until the sealant injection is complete, the pressure shown on the pressure gauge will appear higher than actual. After the sealant injection is complete the pressure will drop and then begin to rise again as the tire is inflated with air. This is normal. To accurately measure the air pressure using the gauge, turn the air compressor off only after the sealant injection is complete.

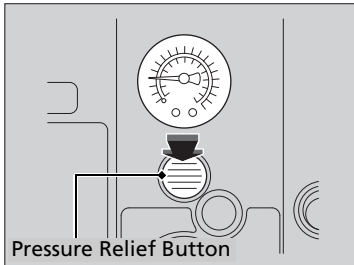
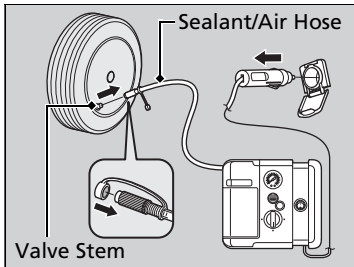
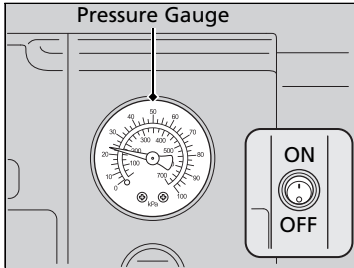

7. Press the inflator switch to turn on the compressor.
 - ▶ The compressor starts injecting sealant and air into the tire.
8. When the sealant injection is complete, continue to add air.
9. After the air pressure reaches front: 35 psi (240 kPa)/rear: 33 psi (230 kPa), turn off the kit.
 - ▶ To check the pressure, occasionally turn off the compressor and read the gauge.
10. Unplug the power plug from the accessory power socket.
11. Unscrew the sealant/air hose from the tire valve stem. Reinstall the valve cap.
12. Press the pressure relief button until the gauge returns to 0 psi (0 kPa).

✘ Injecting Sealant and Air

If the required air pressure is not reached within 15 minutes, the tire may be too severely damaged for the kit to provide the necessary seal and your vehicle will need to be towed.

See an Acura dealer for a replacement sealant bottle and proper disposal of an empty bottle.

Continued

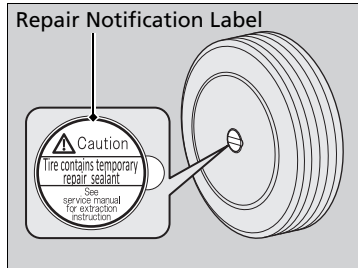

13. Apply the repair notification label to the flat surface of the wheel.
 - The wheel surface must be clean to ensure the label adheres properly.

■ Distributing the Sealant in the Tire

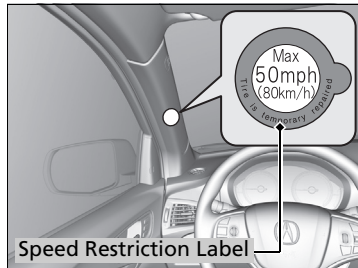

1. Apply the speed restriction label to the location as shown.
2. Drive the vehicle for about 10 minutes.
 - Do not exceed 50 mph (80 km/h).
3. Stop the vehicle in a safe place.

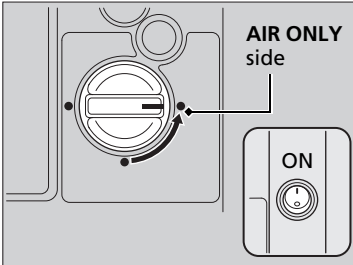
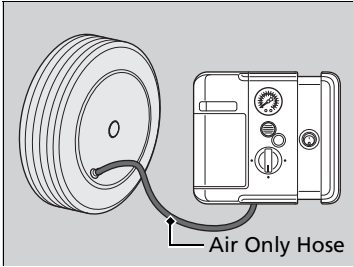

4. Recheck the air pressure using the air only hose on the compressor.

5. Turn the selector switch to **AIR ONLY**.

► Do not turn the air compressor on to check the pressure.

✘ **Inflating an Under-inflated Tire** P. 411

6. If the air pressure is

- Less than 19 psi (130 kPa):

Do not add air or continue driving. The leak is too severe. Call for help and have your vehicle towed.

✘ **Emergency Towing** P. 429

- Front: 35 psi (240 kPa)/rear: 33 psi (230 kPa) or more:

Continue driving for another 10 minutes or until you reach the nearest service station. Do not exceed 50 mph (80 km/h).

► If the air pressure does not go down after the 10 minute driving, you do not need to check the pressure any more.

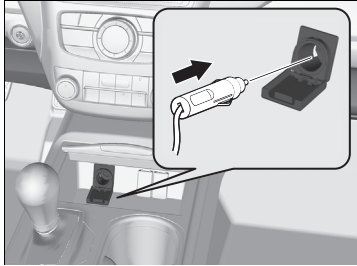

- Greater than 19 psi (130 kPa), but less than front: 35 psi (240 kPa)/rear: 33 psi (230 kPa):

Turn the air compressor on to inflate the tire until the tire pressure reaches front: 35 psi (240 kPa)/rear: 33 psi (230 kPa).

▶ **Inflating an Under-inflated Tire** P. 411

Then drive carefully for 10 more minutes or until you reach the nearest service station. Do not exceed 50 mph (80 km/h).

- ▶ You should repeat this procedure as long as the air pressure is within this range.

7. Press the pressure relief button until the gauge returns to 0 psi (0 kPa).
8. Repackage and properly stow the kit.

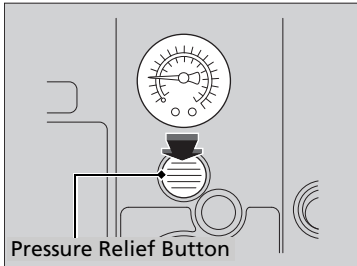

▶▶ Distributing the Sealant in the Tire

⚠ WARNING

Running the engine with the vehicle in an enclosed or even partly enclosed area can cause a rapid build-up of toxic carbon monoxide.

Breathing this colorless, odorless gas can cause unconsciousness and even death.

Only run the engine to power the air compressor with the vehicle outdoors.

■ Inflating an Under-inflated Tire

You can use the kit to inflate a non-punctured under-inflated tire.

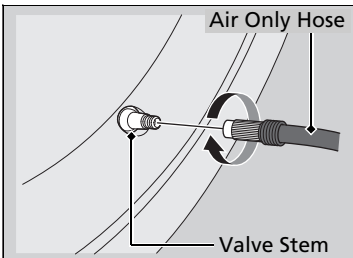
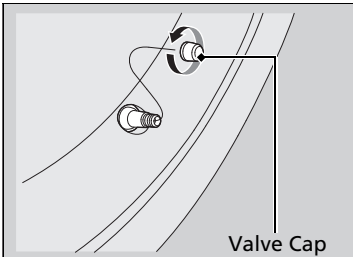
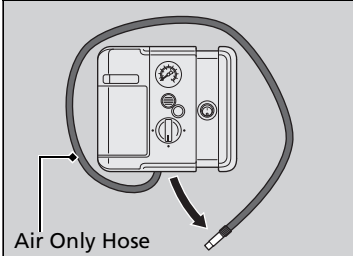

1. Open the cargo area floor lid.
 - ▶ **Getting Ready to Temporarily Repair the Flat Tire** P. 404
2. Remove the kit from the case.
3. Place the kit, face up, on flat ground near the flat tire, away from traffic. Do not place the kit on its side.
4. Remove the air only hose from the kit.
5. Remove the valve cap.
6. Attach the air only hose onto the tire valve stem. Screw it until it is tight.

▶▶ Inflating an Under-inflated Tire

NOTICE

Do not operate the temporary tire repair kit compressor for more than 15 minutes. The compressor can overheat and become permanently damaged.

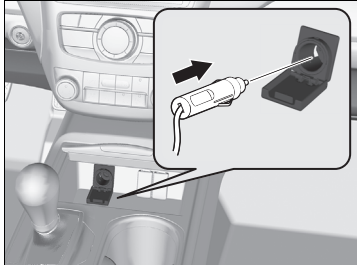

7. Plug in the kit to the accessory power socket.

- ▶ Be careful not to pinch the cord in a door or window.
- ▶ Do not plug any other electronic devices into other accessory power sockets.

🔧 **Accessory Power Sockets** P. 176

8. Start the engine.

- ▶ Keep the engine running while injecting air.

🔧 **Carbon Monoxide Gas** P. 64

9. Turn the selector switch to **AIR ONLY**.

10. Press the inflator switch to turn on the kit.

- ▶ The compressor starts to inject air into the tire.

11. Inflate the tire to the specified air pressure.

🔧 **Inflating an Under-inflated Tire**

⚠️ WARNING

Running the engine with the vehicle in an enclosed or even partly enclosed area can cause a rapid build-up of toxic carbon monoxide.

Breathing this colorless, odorless gas can cause unconsciousness and even death.

Only run the engine to power the air compressor with the vehicle outdoors.

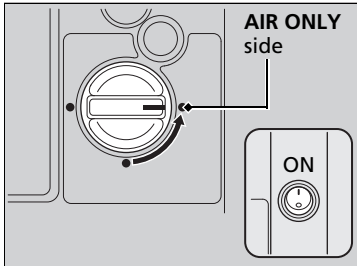

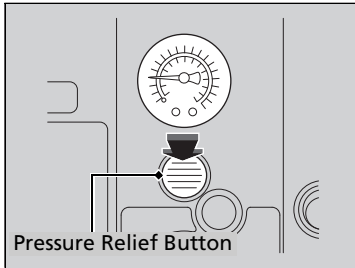

- 12.** Turn off the kit.
 - ▶ Check the pressure gauge on the air compressor.
 - ▶ If overinflated, press the pressure relief button.
- 13.** Unplug the kit from the accessory power socket.
- 14.** Unscrew the air only hose from the tire valve stem. Reinstall the valve cap.
- 15.** Press the pressure relief button until the gauge returns to 0 psi (0 kPa).
- 16.** Repackage and properly stow the kit.

Checking the Engine

If the engine does not start, check the starter.

☒ Checking the Engine

If you must start the vehicle immediately, use an assisting vehicle to jump start it.

☒ **Jump Starting** P. 417

Starter condition

Checklist

Starter doesn't turn or turns over slowly.

The battery may be dead. Check each of the items on the right and respond accordingly.

The starter turns over normally but the engine doesn't start.

There may be a problem with the fuse. Check each of the items on the right and respond accordingly.

Check for a message on the multi-information display.

- If the **TO START, HOLD REMOTE NEAR START BUTTON/To Start, Hold Remote Near Start Button** message appears
 - ☒ **If the Keyless Access Remote Battery is Weak** P. 415
 - ▶ Make sure the keyless access remote is in its operating range.
 - ☒ **ENGINE START/STOP Button** P. 146

Check brightness of the interior lights.

Turn on the interior lights and check the brightness.

- If the interior lights are dim or do not come on at all
 - ☒ **Battery** P. 385
- If the interior lights come on normally ☒ **Fuses** P. 426

Review the engine start procedure.

Follow its instructions, and try to start the engine again. ☒ **Starting the Engine** P. 270

Check the immobilizer system indicator.

When the immobilizer system indicator is blinking, the engine cannot be started.

☒ **Immobilizer System** P. 139

Check the fuel level.

There should be enough fuel in the tank. ☒ **Fuel Gauge** P. 95

Check the fuse.

Check all fuses, or have the vehicle checked by a dealer.

☒ **Inspecting and Changing Fuses** P. 428

If the problem continues:

☒ **Emergency Towing** P. 429

If the Keyless Access Remote Battery is Weak

If the beeper sounds, the **TO START, HOLD REMOTE NEAR START BUTTON/To Start, Hold Remote Near Start Button** message appears on the multi-information display, the indicator on the **ENGINE START/STOP** button flashes, and the engine won't start, start the engine as follows.

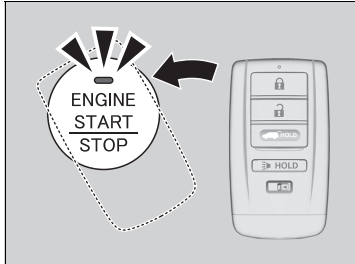

1. Touch the center of the **ENGINE START/STOP** button with the **A** logo on the keyless access remote while the indicator on the **ENGINE START/STOP** button is flashing. The buttons on the keyless access remote should be facing you.
 - ▶ The indicator flashes for about 30 seconds.

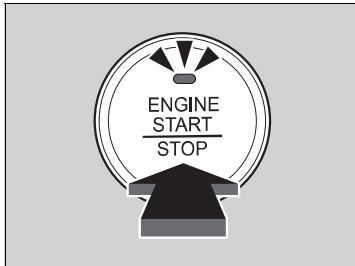

2. Depress the brake pedal and press the **ENGINE START/STOP** button within 10 seconds after the beeper sounds and the indicator changes from flashing to on.
 - ▶ If you don't depress the pedal, the mode will change to ACCESSORY.

Emergency Engine Stop

The **ENGINE START/STOP** button may be used to stop the engine due to an emergency situation even while driving. If you must stop the engine, do either of the following operations:

- Press and hold the **ENGINE START/STOP** button for two seconds.
- Firmly press the **ENGINE START/STOP** button twice.

The steering wheel will not lock. However, because turning off the engine disables the power assist the engine provides to the steering and braking systems, it will require significantly more physical effort and time to steer and slow the vehicle. Use both feet on the brake pedal to slow down the vehicle and stop immediately in a safe place.

The power mode is in ACCESSORY when the engine is stopped.

To change the mode to VEHICLE OFF, change the gear position to **P** after the vehicle comes to a complete stop. Then press the **ENGINE START/STOP** button twice without depressing the brake pedal.

Emergency Engine Stop

Do not press the button while driving unless it is absolutely necessary for the engine to be switched off.

Jump Starting Procedure

Turn off the power to electric devices, such as audio and lights. Turn off the engine, then open the hood.

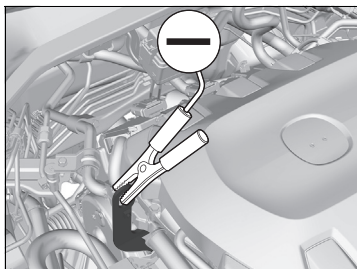
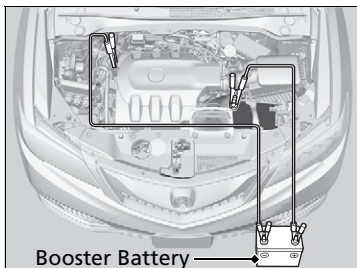

1. Connect the first jumper cable to your vehicle's battery \oplus terminal.
2. Connect the other end of the first jumper cable to the booster battery \oplus terminal.
▶ Use a 12-volt booster battery only.
3. Connect the second jumper cable to the booster battery \ominus terminal.
4. Connect the other end of the second jumper cable to the engine hanger as shown. Do not connect this jumper cable to any other part.
5. If your vehicle is connected to another vehicle, start the assisting vehicle's engine and increase its rpm slightly.
6. Attempt to start your vehicle's engine. If it turns over slowly, check that the jumper cables have good metal-to-metal contact.

Jump Starting

⚠ WARNING

A battery can explode if you do not follow the correct procedure, seriously injuring anyone nearby.

Keep all sparks, open flames, and smoking materials away from the battery.

Securely attach the jumper cables clips so that they do not come off when the engine vibrates. Also be careful not to tangle the jumper cables or allow the cable ends to touch each other while attaching or detaching the jumper cables.

Battery performance degrades in cold conditions and may prevent the engine from starting.

■ What to Do After the Engine Starts

Once your vehicle's engine has started, remove the jumper cables in the following order.

1. Disconnect the jumper cable from your vehicle's ground.
2. Disconnect the other end of the jumper cable from the assisting vehicle's \ominus terminal.
3. Disconnect the jumper cable from your vehicle's \oplus terminal.
4. Disconnect the other end of the jumper cable from the assisting vehicle's \oplus terminal.

Have your vehicle inspected by a nearby service station or a dealer.

Shift Lever Does Not Move

Follow the procedure below if you cannot move the shift lever out of the **P** position.

Releasing the Lock

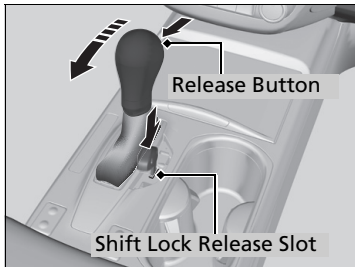
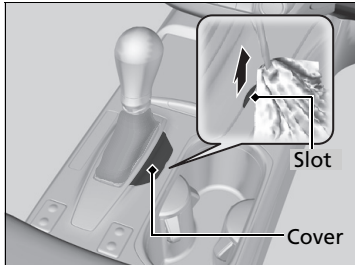

1. Set the parking brake.
2. Remove the built-in key from the keyless access remote.
3. Wrap a cloth around the tip of a small flat-tip screwdriver. Put it into the shift lock release slot as shown in the image, and remove the cover.
4. Insert the key into the shift lock release slot.
5. While pushing the key down, press the shift lever release button and place the shift lever into **N**.
 - ▶ The lock is now released. Have the shift lever checked by a dealer as soon as possible.

How to Handle Overheating

Overheating symptoms are as follows:

- The temperature gauge needle is at the **H** mark or the engine suddenly loses power.
- Steam or spray comes out of the engine compartment.

■ First thing to do

1. Immediately park the vehicle in a safe place.
2. Turn off all accessories and turn on the hazard warning lights.
 - ▶ **No steam or spray present:** Keep the engine running and open the hood.
 - ▶ **Steam or spray is present:** Turn off the engine and wait until it subsides. Then, open the hood.

» How to Handle Overheating

WARNING

Steam and spray from an overheated engine can seriously scald you.

Do not open the hood if steam is coming out.

NOTICE

Continuing to drive with the temperature gauge needle at the **H** mark may damage the engine.

■ Next thing to do

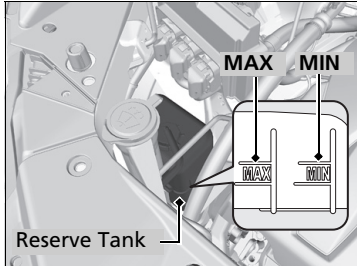

1. Check that the cooling fan is operating and stop the engine once the temperature gauge needle comes down.
 - ▶ If the cooling fan is not operating, immediately stop the engine.
2. Once the engine has cooled down, inspect the coolant level and check the cooling system components for leaks.
 - ▶ If the coolant level in the reserve tank is low, add coolant until it reaches the **MAX** mark.
 - ▶ If there is no coolant in the reserve tank, check that the radiator is cool. Cover the radiator cap with a heavy cloth and open the cap. If necessary, add coolant up to the base of the filler neck, and put the cap back on.

■ Last thing to do

Once the engine has cooled sufficiently, restart it and check the temperature gauge. If the temperature needle has gone down, resume driving. If it has not gone down, contact a dealer for repairs.

▶ How to Handle Overheating

⚠ WARNING

Removing the radiator cap while the engine is hot can cause the coolant to spray out, seriously scalding you.

Always let the engine and radiator cool down before removing the radiator cap.

If the coolant is leaking, contact a dealer for repairs.

Use water as an emergency/temporary measure only. Have a dealer flush the system with proper antifreeze as soon as possible.

If the Low Oil Pressure Indicator Comes On



■ Reasons for the indicator to come on

Comes on when the engine oil pressure is low.

■ What to do as soon as the indicator comes on

1. Immediately park the vehicle in a safe place.
2. If necessary, turn the hazard warning lights on.

■ What to do after parking the vehicle

1. Stop the engine and let it sit for about one minute.
2. Open the hood and check the oil level.
 - ▶ Add oil as necessary.
3. Start the engine and check the low oil pressure indicator.
 - ▶ **The indicator goes off:** Start driving again.
 - ▶ **The indicator does not go off within 10 seconds:** Stop the engine and contact a dealer for repairs immediately.

If the Charging System Indicator Comes On



■ Reasons for the indicator to come on

Comes on when the battery is not being charged.

■ What to do when the indicator comes on

Turn off the climate control system, rear defogger, and other electrical systems, and immediately contact a dealer for repairs.

▶▶ If the Low Oil Pressure Indicator Comes On

NOTICE

Running the engine with low oil pressure can cause serious mechanical damage almost immediately.

▶▶ If the Charging System Indicator Comes On

If you need to stop temporarily, do not turn off the engine. Restarting the engine may rapidly discharge the battery.

If the Malfunction Indicator Lamp Comes On or Blinks



■ Reasons for the indicator lamp to come on or blink

- Comes on when there is a problem with the engine emissions control system, or the fuel fill cap is missing, or loose.
- Blinks when engine misfiring is detected.

■ What to do when the indicator lamp comes on

Avoid high speeds and immediately get your vehicle inspected at a dealer.

■ What to do when the indicator lamp blinks

Park the vehicle in a safe place with no flammable items and wait at least ten minutes or more with the engine stopped until it cools.

■ Tighten Fuel Cap Message

■ The message appears on when:

An evaporative system leak is detected. This may be caused by the fuel fill cap being loose or not being installed.

■ What to do when the message appears:

1. Stop the engine.
2. Check that the fuel fill cap is fully installed.
 - ▶ If not, loosen the cap, and then retighten it until it clicks at least once.
3. Drive for several days of normal driving.
 - ▶ The message should go off.

■ When the malfunction indicator lamp comes on

Malfunction indicator lamp comes on if the system continues to detect a leak of gasoline vapor. If this happens, check the fuel fill cap using the procedures described above.

▶▶ If the Malfunction Indicator Lamp Comes On or Blinks

NOTICE

If you drive with the malfunction indicator lamp on, the emissions control system and the engine could be damaged.

If the malfunction indicator lamp blinks again when restarting the engine, drive to the nearest dealer at 31 mph (50 km/h) or less. Have your vehicle inspected.

If the Brake System Indicator (Red) Comes On

U.S.



Canada



■ Reasons for the indicator to come on

- The brake fluid is low.
- There is a malfunction in the brake system.

■ What to do when the indicator comes on while driving

Press the brake pedal lightly to check pedal pressure.

- If normal, check the brake fluid level the next time you stop.
- If abnormal, take immediate action. If necessary, downshift the transmission to slow the vehicle using engine braking.

▶▶ If the Brake System Indicator (Red) Comes On

Have your vehicle repaired immediately.

It is dangerous to drive with low brake fluid. If there is no resistance from the brake pedal, stop immediately in a safe place. If necessary downshift the gears.

If the brake system indicator and **ABS** indicator come on simultaneously, the electronic brake distribution system is not working. This can result in vehicle instability under sudden braking.

Have your vehicle inspected by a dealer immediately.

If the Electric Power Steering (EPS) System Indicator Comes On



■ Reasons for the indicator to come on

- Comes on when there is a problem with EPS system.
- If you depress the accelerator pedal repeatedly to increase the engine speed while the engine is idling, the indicator comes on, and sometimes the steering wheel becomes harder to operate.

■ What to do when the indicator comes on

Stop the vehicle in a safe place and restart the engine.

If the indicator comes on and stays on, immediately have your vehicle inspected by a dealer.

If the Low Tire Pressure/TPMS Indicator Comes On or Blinks



■ Reasons for the indicator to come on or blink

A tire pressure is significantly low. If there is a problem with the TPMS or the compact spare tire* is installed, the indicator blinks for about one minute, and then stays on.

■ What to do when the indicator comes on

Stop your vehicle in a safe place. Check the tire pressure and adjust the pressure to the specified level. The specified tire pressure is on a label on the driver side doorjamb.

■ What to do when the indicator blinks

Have the tire inspected by a dealer as soon as possible. If the compact spare tire* causes the indicator to blink, change the tire to a full-size tire. The indicator goes off after driving for a few miles (kilometers).

▶▶ If the Low Tire Pressure/TPMS Indicator Comes On or Blinks

NOTICE

Driving on an extremely underinflated tire can cause it to overheat. An overheated tire can fail. Always inflate your tires to the prescribed level.

* Not available on all models

Fuse Locations

If any electrical devices are not working, set the power mode to VEHICLE OFF (LOCK) and check to see if any applicable fuse is blown.

Fuse locations are shown on the fuse box cover. Locate the fuse in question by the fuse number and box cover number.

Engine Compartment Fuse Box

Located near the brake fluid reservoir. Push the tabs to open the box.

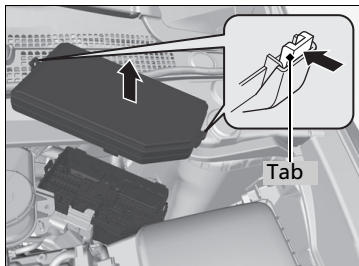

Circuit protected and fuse rating

	Circuit Protected	Amps
1	EPS	70 A
	Power Tailgate Motor	(40 A)
	ABS/VSA FSR	20 A
	ABS/VSA Motor	40 A
	E-DPS	(30 A)
	Main Fuse	120 A
2	–	50 A
	Fuse Box Main 1	60 A
	Fuse Box Main 2	60 A
	IG Main	50 A
	Headlight Washer*	(30 A)
	Sub Fan Motor	30 A
	Rear Defogger	40 A
	Main Fan Motor	30 A
	Headlight Main	30 A
	Blower	40 A
3	ST CUT1	40 A
	IG Main1	30 A
	Sub Fuse Main	(40 A)
4	IG Main2	30 A
	Rear Seat Heaters*	(20 A)
5	STR Diagnosis Fuse	7.5 A
6	Audio (ODMD)*	(15 A)
7	–	–
8	–	–

	Circuit Protected	Amps
9	–	–
10	–	–
11	Oil Level	7.5 A
12	Fog Lights*	(20 A)
13	Power Tailgate Closer	(20 A)
14	Hazard	10 A
15	IGP2	15 A
16	IG Coil	15 A
17	Stop	10 A
18	Horn	10 A
19	ACM	20 A
20	Right Headlight Low Beam	15 A
21	MG Clutch	7.5 A
22	DBW	15 A
23	Left Headlight Low Beam	15 A
24	DRL	(10 A)
25	FI Main	15 A
26	Trailer	(20 A)
27	Small	20 A
28	Interior Lights	7.5 A
29	Back Up	10 A

Interior Fuse Box

Located under the dashboard.

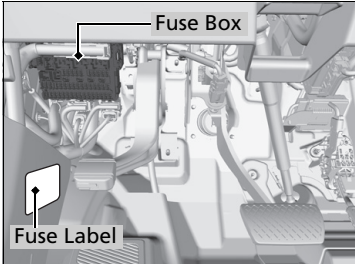

Fuse locations are shown on the label on the side panel.

Locate the fuse in question by the fuse number and label number.

■ Circuit protected and fuse rating

	Circuit Protected	Amps
1	–	–
2	ACG	15 A
3	ODS	7.5 A
4	Fuel Pump	15 A
5	Meter	7.5 A
6	Rear Wiper	10 A
7	VB SOL	10 A
8	Front Right Side Door Lock Motor (Unlock)	15 A

	Circuit Protected	Amps
9	Rear Left Side Door Lock Motor (Unlock)	15 A
10	Power Lumbar	7.5 A
11	Moonroof	20 A
12	Accessory Power Socket (Center Console)	20 A
13	Washer Main	15 A
14	Seat Heaters	20 A
15	Driver's Door Lock Motor (Unlock)	10 A
16	Driver's Power Seat Sliding	20 A
17	Driver's Power Seat Reclining	20 A
18	Passenger's Power Seat Sliding	20 A
19	ACC	7.5 A
20	ACC Key Lock	7.5 A
21	Daytime Running Lights	7.5 A
22	A/C	7.5 A
23	Option	10 A
24	ABS/VSA	7.5 A
25	IDAS	(10 A)
26	Audio Amp	20 A ^{*1} 30 A ^{*2}
27	Accessory Power Socket (Front)	20 A
28	–	–
29	SRS	10 A

	Circuit Protected	Amps
30	Driver's Door Lock Motor (Lock)	10 A
31	Smart	10 A
32	Front Right Side Door Lock Motor (Lock)	15 A
33	Rear Left Side Door Lock Motor (Lock)	15 A
34	Small Lights	7.5 A
35	Illumination	7.5 A
36	Rear Wiper Main	10 A
37	Passenger's Power Seat Reclining	20 A
38	Left Headlight High Beam	10 A
39	Right Headlight High Beam	10 A
40	–	–
41	Door Lock	20 A
42	Driver's Power Window	20 A
43	Rear Right Side Power Window	20 A
44	Front Right Side Power Window	20 A
45	Rear Left Side Power Window	20 A
46	Wiper	30 A

*1: Models without navigation system

*2: Models with navigation system

Inspecting and Changing Fuses

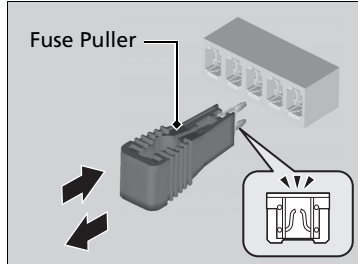
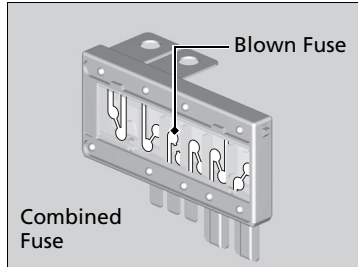

1. Set the power mode to VEHICLE OFF (LOCK). Turn headlights and all accessories off.
2. Remove the fuse box cover.
3. Check the large fuse in the engine compartment.
 - If the fuse is blown, use a Phillips-head screwdriver to remove the screw and replace it with a new one.
4. Inspect the small fuses in the engine compartment and the vehicle interior.
 - If there is a burned out fuse, remove it with the fuse puller and replace it with a new one.

► Inspecting and Changing Fuses

NOTICE

Replacing a fuse with one that has a higher rating greatly increases the chances of damaging the electrical system.

Replace fuse with a spare fuse of the same specified amperage

Confirm the specified amperage using the charts on P. 426 to P. 427.

There is a fuse puller on the back of the engine compartment fuse box cover.

Emergency Towing

Call a professional towing service if you need to tow your vehicle.

All models

■ Flat bed equipment

The operator loads your vehicle on the back of a truck.

This is the best way to transport your vehicle.

2WD models

■ Wheel lift equipment

The tow truck uses two pivoting arms that go under the front tires and lift them off the ground. The rear tires remain on the ground. **This is an acceptable way to tow your vehicle.**

» Emergency Towing

NOTICE

Trying to lift or tow your vehicle by the bumpers will cause serious damage. The bumpers are not designed to support the vehicle's weight.

NOTICE

Improper towing such as towing behind a motorhome or other motor vehicle can damage the transmission.

Never tow your vehicle with just a rope or chain. It is very dangerous since ropes or chains may shift from side to side or break.

When You Cannot Open the Tailgate

What to Do When Unable to Open the Tailgate

If you cannot open the tailgate, use the following procedure.

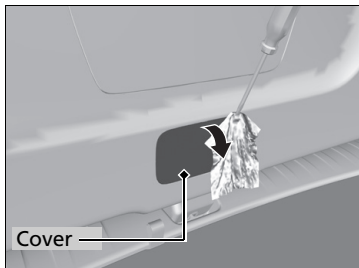

1. Use a flat-tip screwdriver and remove the cover on the inside of the tailgate.

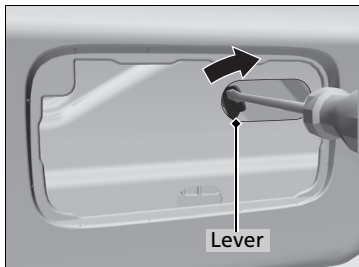

2. To open the tailgate, push the tailgate while sliding the lever to the right using a flat-tip screwdriver.
 - ▶ Do not use your finger to slide the lever.

What to Do When Unable to Open the Tailgate

What to do—following up

After taking these steps, contact a dealer to have the vehicle checked.

When you open the tailgate from inside, make sure there is enough space around the tailgate, and it does not hit anyone or any object.

Information

This chapter includes your vehicle's specifications, locations of identification numbers, and other information required by regulation.

Specifications	432
Identification Numbers	
Vehicle Identification Number (VIN), Engine Number and Transmission Number	434
Devices that Emit Radio Waves	435
Reporting Safety Defects	436
Emissions Testing	
Testing of Readiness Codes.....	437
Warranty Coverages	439
Authorized Manuals	441
Client Service Information	442

Specifications

■ Vehicle Specifications

Model	Acura RDX	
No. of Passengers:		
Front	2	
Rear	3	
Total	5	
Weights:		
Gross Vehicle Weight Rating	U.S.: 4,850 lbs (2,200 kg) ^{*1}	4,982 lbs (2,260 kg) ^{*2}
	Canada: 2,260 kg	
Gross Axle Weight Rating (Front)	U.S.: 2,557 lbs (1,160 kg) ^{*1}	2,623 lbs (1,190 kg) ^{*2}
	Canada: 1,190 kg	
Gross Axle Weight Rating (Rear)	U.S.: 2,293 lbs (1,040 kg) ^{*1}	2,381 lbs (1,080 kg) ^{*2}
	Canada: 1,080 kg	
Gross Combined Weight Rating	U.S.: 6,349 lbs (2,880 kg) ^{*1}	6,482 lbs (2,940 kg) ^{*2}
	Canada: 2,940 kg	

*1: 2WD models

*2: AWD models

■ Air Conditioning

Refrigerant Type	HFC-134a (R-134a)
Charge Quantity	15.2 – 16.9 oz (430 – 480 g)
Lubricant Type	ND-OIL8
Quantity	4.3 – 5.0 cu-in (70 – 82 cm ³)

■ Engine Specifications

Displacement	211.8 cu-in (3,471 cm ³)
Spark Plugs	NGK ILZKR7B11
	DENSO SXU22HCR11

■ Fuel

Type	Unleaded premium gasoline, Pump octane number of 91 or higher
Fuel Tank Capacity	16 US gal (60.5 ℓ)

■ Washer Fluid

Tank Capacity	U.S.: 2.6 US qt (2.5 ℓ)
	Canada: 5.1 US qt (4.85 ℓ)

■ Light Bulbs

Headlights (High Beams)	LED
Headlights (Low Beams)	LED
Fog Lights*	55W (H11)
Front Turn Signal/Parking Lights/Daytime running light	LED
Side Turn Signal Lights (on Door Mirrors)	LED
Front Side Marker Lights	3CP
Rear Side Marker/Brake/Taillights	LED
Back-Up Lights	16W
Rear Turn Signal Lights	21W (Amber)
High-Mount Brake Light	LED
Rear License Plate Light	5W
Cargo Area Lights	5W
Vanity Mirror Lights	1.4W
Interior Lights	
Map Lights	LED
Ceiling Light	8W
Door Courtesy Lights	2CP
Console Compartment Light	1.4W
Glove Box Light	1.4W
Center Pocket Light	LED

■ Brake Fluid

Specified	Acura Heavy Duty Brake Fluid DOT 3
-----------	------------------------------------

Automatic Transmission Fluid

Specified	Acura Automatic Transmission Fluid ATF DW-1	
Capacity	Change	3.3 US qt (3.1 ℓ)

Rear Differential Fluid*

Specified	Acura DPSF-II	
Capacity	Change	1.32 US qt (1.25 ℓ)

Transfer Assembly Fluid*

Specified	Acura Hypoid Gear Oil HGO-11	
Capacity	Change	0.43 US qt (0.41 ℓ)

Engine Oil

Recommended	·Genuine Acura Motor Oil 0W-20 ·API Premium-grade 0W-20 detergent oil	
Capacity	Change	4.2 US qt (4.0 ℓ)
	Change including filter	4.5 US qt (4.3 ℓ)

Engine Coolant

Specified	Acura Long Life Antifreeze/Coolant Type2	
Ratio	50/50 with distilled water	
Capacity	1.96 US gal (7.4 ℓ)	
	(change including the remaining 0.193 US gal (0.73 ℓ) in the reserve tank)	

Tire

Regular	Size	P235/60R18 102V	
	Pressure psi (kPa [kgf/cm ²])	Front	35 (240 [2.4])
		Rear	33 (230 [2.3])
Compact Spare*	Size	T165/90R17 105M	
	Pressure psi (kPa [kgf/cm ²])	60 (420 [4.2])	
Wheel Size	Regular	18 x 7 1/2J	
	Compact Spare*	17 x 4T	

* Not available on all models

Vehicle Identification Number (VIN), Engine Number and Transmission Number

Your vehicle has a 17-digit vehicle identification number (VIN) used to register your vehicle for warranty purposes, and for licensing and insuring your vehicle.

The locations of your vehicle's VIN, engine number and transmission number are shown as follows.

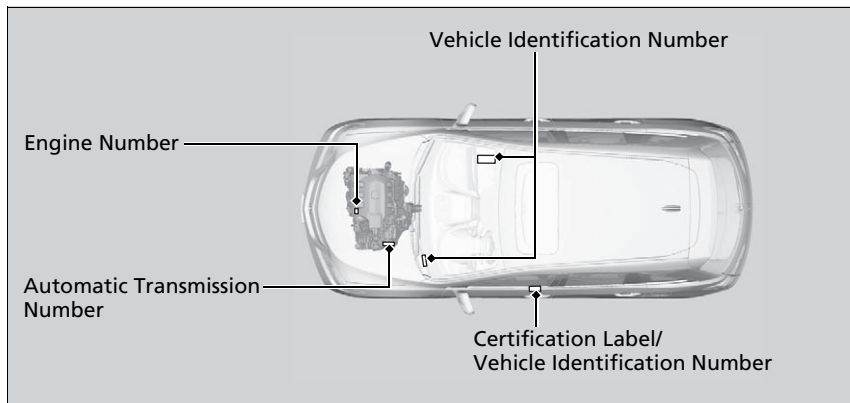

Vehicle Identification Number (VIN), Engine Number and Transmission Number

The interior vehicle identification number (VIN) is located under the cover.



Devices that Emit Radio Waves

The following products and systems on your vehicle emit radio waves when in operation.

AcuraLink*

Audio System

Blind spot information (BSI) System*

Bluetooth® Audio

Bluetooth® HandsFreeLink®

Collision Mitigation Braking System™*

HomeLink® Universal Transceiver

Immobilizer System

Remote Transmitter

Keyless Access System

Tire Pressure Monitoring System (TPMS)

Remote Engine Start with Vehicle Feedback*

Each of the above complies with the appropriate requirements or the required standards of FCC (Federal Communications Commission) and Industry Canada Standard, described below:

As required by the FCC:

This device complies with Part 15 of the FCC rules. Operation is subject to the following two conditions: (1) This device may not cause harmful interference, and (2) this device must accept any interference received, including interference that may cause undesired operation.

Changes or modifications not expressly approved by the party responsible for compliance could void the user's authority to operate the equipment.

This device complies with Industry Canada licence-exempt RSS standard(s). Operation is subject to the following two conditions: (1) this device may not cause interference, and (2) this device must accept any interference, including interference that may cause undesired operation of the device.

* Not available on all models

In the U.S.

If you believe that your vehicle has a defect which could cause a crash or could cause injury or death, you should immediately inform the National Highway Traffic Safety Administration (NHTSA) in addition to notifying American Honda Motor Co., Inc.

If NHTSA receives similar complaints, it may open an investigation, and if it finds that a safety defect exists in a group of vehicles, it may order a recall and remedy campaign. However, NHTSA cannot become involved in individual problems between you, your dealer, or American Honda Motor Co., Inc.

To contact NHTSA, you may call the Vehicle Safety Hotline toll-free at 1-888-327-4236 (TTY: 1-800-424-9153); go to <http://www.safercar.gov>; or write to: Administrator, NHTSA, 1200 New Jersey Avenue, SE., Washington, DC 20590. You can also obtain other information about motor vehicle safety from <http://www.safercar.gov>.

In Canada

If you believe that your vehicle has a defect which could cause a crash or could cause injury or death, you should immediately inform Honda Canada Inc. and you may also inform Transport Canada.

If Transport Canada receives similar complaints, it may open an investigation, and if it finds that a safety defect exists in a group of vehicles, it may lead to a recall and remedy campaign. However, Transport Canada cannot become involved in individual problems between you, your dealer, or Honda Canada Inc.

To contact Transport Canada's Defect Investigations and Recalls Division, you may call 1-800-333-0510. For more information on reporting safety defects or about motor vehicle safety, go to <http://www.tc.gc.ca/roadsafety>.

Testing of Readiness Codes

Your vehicle has readiness code as part of the onboard self diagnostic system. Some States use these codes for testing to verify whether your vehicle's emissions components are working properly. The codes may not be read properly if testing is performed just after the battery has gone dead or been disconnected.

To check if they are set, set the power mode to ON, without starting the engine. The malfunction indicator lamp will come on for several seconds. If it then goes off, the readiness codes are set. If it blinks five times, the readiness codes are not set.

If you are required to have your vehicle tested before the readiness codes are ready, prepare the vehicle for retesting by doing the following:

1. Fill the gas tank to approximately 3/4 full.
2. Park the vehicle and leave the engine off for 6 hours or more.
3. Make sure the ambient temperature is between 40°F and 95°F (4°C and 35°C).
4. Start the engine without touching the accelerator pedal, and let it idle for 20 seconds.
5. Keep the vehicle in **P**. Increase the engine speed to 2,000 rpm, and hold it there for about 3 minutes.
6. Let the engine idle with your foot off the accelerator for 20 seconds.

Testing of Readiness Codes

The readiness codes are erased when the battery is disconnected, and set again only after several days of driving under a variety of conditions.

If a testing facility determines that the readiness codes are not set, you may be requested to return at a later date to complete the test.

If the testing facility determines the readiness codes are still not set, see a dealer.

7. Select a nearby, lightly traveled major highway where you can maintain a speed of 50 to 60 mph (80 to 97 km/h) for at least 20 minutes. Drive on the highway in **D**. Do not use cruise control. When traffic allows, drive for 90 seconds without moving the accelerator pedal. (Vehicle speed may vary slightly; this is okay.) If you cannot do this for a continuous 90 seconds because of traffic conditions, drive for at least 30 seconds, then repeat it two more times (for a total of 90 seconds).
8. Drive in city or suburban traffic for at least 10 minutes. When traffic conditions allow, let the vehicle coast for several seconds without using the accelerator pedal or the brake pedal.
9. Park the vehicle and leave the engine off for 30 minutes.

■ U.S. Owners

Your new vehicle is covered by these warranties:

New Vehicle Limited Warranty – covers your new vehicle, except for the emissions control systems and accessories, against defects in materials and workmanship.

Emissions Control Systems Defects Warranty and Emissions Performance Warranty – these two warranties cover your vehicle's emissions control systems. Time, mileage, and coverage are conditional. Please read your warranty booklet for exact information.

Seat Belt Limited Warranty – a seat belt that fails to function properly is covered by a limited warranty. Please read your warranty booklet for details.

Rust Perforation Limited Warranty – all exterior body panels are covered for rust-through from the inside for the specified time period with no mileage limit.

Accessory Limited Warranty – Acura accessories are covered under this warranty. Time and mileage limits depend on the type of accessory and other factors. Please read your warranty booklet for details.

Replacement Parts Limited Warranty – covers all Acura replacement parts against defects in materials and workmanship.

Replacement Battery Limited Warranty – provides prorated coverage for a replacement battery purchased from a dealer.

Replacement Muffler Lifetime Limited Warranty – provides coverage for as long as the purchaser of the muffler owns the vehicle.

Restrictions and exclusions apply to all these warranties. Please read the Acura warranty information booklet that came with your vehicle for precise information on warranty coverages. Your vehicle's original tires are covered by their manufacturer. Tire warranty information is in a separate booklet.

■ **Canadian Owners**

Please refer to the warranty manual that came with your vehicle.

■ **EPA Contact Information**

An owner may obtain further information concerning emission warranties or report violations of the terms of the emission warranties by contacting:

U.S. Environmental Protection Agency
Office of Transportation and Air Quality
Compliance Division, Light-Duty Vehicle Group
Attn: Warranty Complaints
2000 Traverwood Drive
Ann Arbor, MI 48105
Email: complianceinfo@epa.gov

■ Service Express

For electronic copies of service publications, you can purchase a subscription to Service Express. Visit www.techinfo.honda.com for pricing and options.

■ For U.S. Owners

Manuals can be purchased from Helm Incorporated. You can order a manual by phone at (800) 782-4356 (credit card orders only), or online at www.helminc.com.

■ For Canadian Owners

Please contact a dealer to order any manuals that you may require.

Acura dealer personnel are trained professionals.

They should be able to answer all your questions. If you encounter a problem that your dealership does not solve to your satisfaction, please discuss it with the dealership's service manager or general manager. If you are dissatisfied with the decision made by the dealership's management, contact Acura Client Relations/Services.

U.S. Owners

American Honda Motor Co., Inc.
Acura Client Relations
Mail Stop 500-2N-7E
1919 Torrance Blvd.
Torrance, CA 90501-2746
Tel: (800) 382-2238

Canadian Owners

Honda Canada Inc.
Acura Client Services
180 Honda Boulevard
Markham, ON
L6C 0H9
Tel: 1-888-9-ACURA-9
Fax: 1-877-939-0909
E-Mail: acura_cr@ch.honda.com

In Puerto Rico and the U.S. Virgin Islands

Bella International
P.O. Box 190816
San Juan, PR 00919-0816
Tel: (787) 620-7546

Client Service Information

When you call or write, please give us the following information:

- Vehicle Identification Number
 - ▣ **Vehicle Identification Number (VIN), Engine Number and Transmission Number** P. 434
- Date of purchase
- Odometer reading of your vehicle
- Your name, address, and telephone number
- A detailed description of the problem
- Name of the dealer who sold the vehicle to you

- A**
- ABS (Anti-lock Brake System) 322
 - Accessories and Modifications 344
 - Accessory Power Sockets 176
 - AcuraWatch™ 18
 - Adaptive Cruise Control (ACC) 81, 286
 - Additives
 - Coolant 360
 - Engine Oil 355
 - Washer 364
 - Additives, Engine Oil 355
 - Adjusting
 - Armrest 170
 - Front Seats 164
 - Head Restraints 166
 - Mirrors 161
 - Rear Seats 169
 - Steering Wheel 160
 - Temperature 100
 - Air Conditioning System
 - (Climate Control System) 182
 - Changing the Mode 182
 - Defrosting the Windshield and Windows 183
 - Dust and Pollen Filter 388
 - Recirculation/Fresh Air Mode 182
 - Sensors 185
 - Synchronized Mode 184
 - Using Automatic Climate Control 182
 - Air Pressure 377, 433
 - Airbags 39
 - Advanced Airbags 45
 - After a Collision 42
 - Airbag Care 51
 - Front Airbags (SRS) 42
 - Indicator 49, 72
 - Passenger Airbag Off Indicator 50
 - Sensors 39
 - Side Airbags 46
 - Side Curtain Airbags 48
 - All-Wheel Drive (AWD) with Intelligent Control System 316
 - AM/FM Radio 200
 - Anti-lock Brake System (ABS) 322
 - Indicator 71
 - Armrest 170
 - Audio Remote Controls 191
 - Audio System 188
 - Adjusting the Sound 199
 - Auxiliary Input Jack 189
 - Error Messages 217
 - General Information 220
 - iPod® 207
 - MP3/WMA/AAC 212
 - Pandora® 210
 - Reactivating 190
 - Recommended CDs 221
 - Recommended Devices 223
 - Remote Controls 191
 - Security Code 190
 - Theft Protection 190
 - USB Flash Drives 223
 - USB Port 189
 - Audio/Information Screen 193
 - Authorized Manuals 441
 - Auto Door Locking/Unlocking 132
 - Customize 107, 114
 - Automatic Intermittent Wipers 154
 - Automatic Lighting 150
 - Automatic Transmission 276
 - Creeping 276
 - Fluid 362
 - Kickdown 276
 - Operating the Shift Lever 16, 278
 - Sequential Shift Mode 279
 - Shift Lever Does Not Move 419
 - Shifting 277
 - Auxiliary Input Jack 189
 - Average Fuel Economy 100
 - Average Speed 101
 - AWD 316
- B**
- Battery 385
 - Charging System Indicator 70, 422
 - Jump Starting 417
 - Maintenance (Checking the Battery) 385
 - Belts (Seat) 31
 - Beverage Holders 175
 - Blind spot information (BSI) System 313
 - Bluetooth® Audio 215

<i>Bluetooth</i> ® HandsFreeLink®	226	CD Player.....	204	Coat Hook	177
Booster Seats (For Children).....	63	Certification Label.....	434	Collision Mitigation Braking System™ (CMBS™)	324
Brake System	320	Changing Bulbs	365	Compact Spare Tire.....	397, 433
Anti-lock Brake System (ABS).....	322	Charging System Indicator.....	70, 422	Compass.....	255
Brake Assist System	323	Child Safety	52	Console Compartment.....	174
Fluid	363	Childproof Door Locks.....	131	Controls	119
Foot Brake.....	321	Child Seat	52	Coolant (Engine).....	360
Indicator.....	68, 424	Booster Seats	63	Adding to the Radiator	361
Parking Brake	320	Child Seat for Infants.....	54	Adding to the Reserve Tank	360
Brightness Control (Instrument Panel)	156	Child Seat for Small Children.....	55	Overheating.....	420
BSI (Blind spot information) System	313	Installing a Child Seat with a Lap/Shoulder Seat Belt	59	Creeping (Automatic Transmission)	276
Bulb Replacement	365	Larger Children	62	Cross Traffic Monitor	337
Back-Up Light and Taillight	370	Rear-facing Child Seat.....	54	Cruise Control	281
Brake Light/Taillight/Rear Side Marker Light and Rear Turn Signal Light Bulbs.....	368	Selecting a Child Seat.....	56	Indicator	78
Fog Lights.....	365	Childproof Door Locks	131	Cup Holders	175
Front Turn Signal Light/Parking Light/Daytime Running Light and Front Side Marker Light Bulbs	367	Cleaning the Exterior	391	Customized Features	102, 108
Headlights	365	Cleaning the Interior	389		
High-Mount Brake Light	371	Client Service Information	442		
Rear License Plate Light.....	371	Climate Control System	182		
Side Turn Signal Light/Emergency Indicator Light.....	366	Changing the Mode	182	D	
Bulb Specifications	432	Defrosting the Windshield and Windows.....	183	Daytime Running Lights	152
		Dust and Pollen Filter.....	388	Dead Battery	417
		Recirculation/Fresh Air Mode	182	Defrosting the Windshield and Windows	183
		Sensors	185	Detachable Anchor	36
		Synchronized Mode.....	184	Devices that Emit Radio Waves	435
		Using Automatic Climate Control.....	182	Dimming	
		Clock	120	Headlights	149
		CMBS™ (Collision Mitigation Braking System™)	324	Rearview Mirror	161
				Dipstick (Engine Oil)	356
				Directional Signals (Turn Signal)	149

C

Carbon Monoxide Gas.....	64
Cargo Hook.....	177
Carrying Cargo.....	259, 261

Display Button.....	193
Door Mirrors.....	162
Doors	121
Auto Door Locking.....	132
Auto Door Unlocking	132
Door and Tailgate Open Indicator	74
Door and Tailgate Open Message	89
Keys.....	121
Locking/Unlocking the Doors from the Inside.....	130
Locking/Unlocking the Doors from the Outside.....	125
Lockout Prevention System	128
DOT Tire Quality Grading	379
Driving	257
Automatic Transmission	276
Braking	320
Cruise Control	281
Off-Highway Driving Guidelines	268
Shifting Gear	277
Starting the Engine	270
Driving Position Memory System	158
Dust and Pollen Filter	388
E	
Elapsed Time	101
Electric Power Steering (EPS) System Indicator	74, 424
Electronic Stability Control (ESC)	311
Emergency	429

Emissions Testing (Readiness Codes)	437
Engine	434
Coolant	360
Jump Starting	417
Oil	355
Remote Engine Start	272
Starting	270
Engine Coolant	360
Adding to the Radiator	361
Adding to the Reserve Tank	360
Overheating	420
Temperature Gauge	95
Engine Oil	355
Adding	357
Checking.....	356
Displaying Oil Life	349
Low Oil Pressure Indicator.....	69, 422
Recommended Engine Oil.....	355
ENGINE START/STOP Button	146
EPS (Electric Power Steering) System	74, 424
Exhaust Gas Hazard (Carbon Monoxide)	64
Exterior Care (Cleaning)	391
Exterior Mirrors	162

F	
Features	187
Filters	
Dust and Pollen	388
Oil.....	358
Flat Tire	397, 403
Floor Mats	390
Fluids	
Automatic Transmission	362
Brake	363
Engine Coolant	360
Windshield Washer	364
Fog Light Indicator	76
Folding Down the Rear Seats	169
Foot Brake	321
Front Airbags (SRS)	42
Front Seats	164
Adjusting	164
Front Sensor Camera	284
Fuel	17, 341
Economy	343
Gauge.....	95
Instant Fuel Economy	100
Low Fuel Indicator.....	71
Range	101
Recommendation	341
Refueling.....	341
Fuel Economy	343
Fuel Fill Cap	17, 342
Message.....	423
Fuel Fill Door	17, 342

Fuses	426
Inspecting and Changing	428
Locations	426, 427

G

Gasoline (Fuel)

Economy	343
Gauge	95
Information	341
Low Fuel Indicator	71
Refueling	341

Gauges

Gear Shift Lever Positions

Automatic Transmission	277
------------------------------	-----

Glass (care)

Glove Box

H

Halogen Bulbs

Handling the Unexpected

HandsFreeLink® (HFL)

Automatic Import of Cellular Phonebook and Call History	242
Automatic Transferring	240
Caller's ID Information	240
HFL Buttons	226
HFL Menu	228
HFL Status Display	227
Making a Call	245

Options During a Call	249
Phone Setup	233
Receiving a Call	248
Speed Dial	243
Text Message	238, 250
To Clear the System	241
To Create a Security PIN	239

Hazard Warning Button

Head Restraints

Headlights

Automatic Operation	150
Dimming	149, 152
Operating	149

Heaters (Seat)

HFL (HandsFreeLink®)

High Beam Indicator

Hill Start Assist System

HomeLink® Universal Transceiver

I

Identification Numbers

Engine and Transmission	434
Vehicle Identification	434

Illumination Control

Knob	156
------------	-----

Immobilizer System

Indicator	76
-----------------	----

Indicators

Adaptive Cruise Control (ACC)	81, 287
All-Wheel Drive (AWD) with Intelligent Control System	72
Anti-lock Brake System (ABS)	71
Blind spot information (BSI) System	79
Brake System	68
Charging System	70, 422
Collision Mitigation Braking System™ (CMBS™)	82, 83
CRUISE CONTROL	78, 282
CRUISE MAIN	78, 281
Door and Tailgate Open	74
Electric Power Steering (EPS) System	74, 424
Fog Light	76
High Beam	75
Immobilizer System	76
Keyless Access System	78
Lane Departure Warning (LDW)	80
Lane Keeping Assist System (LKAS) ...	81, 305
Lights On	76
Low Fuel	71
Low Oil Pressure	69, 422
Low Tire Pressure/TPMS	75
Malfunction Indicator Lamp	69, 423
Parking Brake and Brake System	68, 424
Seat Belt Reminder	32, 71
Security System Alarm	77
Shift Lever Position	70
Supplemental Restraint System	49, 72

System Message	77
Transmission	70
Turn Signal	75
Vehicle Stability Assist (VSA®)	
System	73, 311
VSA® OFF	73, 312
Information	431
Instrument Panel	67
Brightness Control	156
Interior Lights	171
Interior Rearview Mirror	161
iPod®	207

J

Jack (Wheel Nut Wrench)	400
Jump Starting	417

K

Key Number Tag	123
Keyless Access System	125
Keyless Lockout Prevention	128
Keys	121
Lockout Prevention	128
Number Tag	123
Rear Door Won't Open	131
Remote Transmitter	127
Two-way Keyless Access	
Remote	121, 129, 272
Types and Functions	121

Kickdown (Automatic Transmission)	276
-----------------------------------------	-----

L

Lane Departure Warning (LDW)	299
Lane Keeping Assist System (LKAS)	303
Language (HFL)	227
LATCH (Child Seats)	57, 60
LDW (Lane Departure Warning)	299
Lights	149, 365
Automatic	150
Bulb Replacement	365
Daytime Running Lights	152
Fog Lights	152
High Beam Indicator	75
Interior	171
Light Switches	149
Lights On Indicator	76
Turn Signals and Hazard Warning	149
Load Limits	261
Locking/Unlocking	121
Auto Door Locking/Unlocking	132
Childproof Door Locks	131
From Inside	130
From Outside	125
Keys	121
Using a Key	128
Lockout Prevention System	128
Low Battery Charge	422
Low Fuel Indicator	71
Low Oil Pressure Indicator	69, 422

Lower Anchors	57, 60
Luggage (Maximum Load Limit)	261
Lumbar Support	164

M

Maintenance	345
Battery	385
Brake Fluid	363
Cleaning	389
Climate Control System	388
Coolant	360
Maintenance Minder™	349
Oil	356
Precautions	346
Radiator	361
Remote Transmitter	386, 387
Replacing Light Bulbs	365
Safety	347
Service Items	351
Tires	376
Transmission Fluid	362
Under the Hood	353
Malfunction Indicator Lamp	69, 423
Map Lights	171
Maximum Load Limit	261
Meters, Gauges	95

Mirrors.....	161
Adjusting.....	161
Door.....	162
Exterior.....	162
Interior Rearview.....	161
Modifications (and Accessories).....	344
Moonroof.....	145
MP3.....	204, 212
Multi-Information Display.....	96
Multi-View Rear Camera.....	340

N

Numbers (Identification).....	434
-------------------------------	-----

O

Odometer.....	99
Off-Highway Driving Guidelines.....	268
Oil (Engine).....	355
Adding.....	357
Checking.....	356
Displaying Oil Life.....	349
Low Oil Pressure Indicator.....	69, 422
Recommended Engine Oil.....	355, 433
Viscosity.....	355, 433
On Demand Multi-Use Display™.....	4
Opening/Closing.....	
Hood.....	354
Moonroof.....	145
Power Windows.....	142

Tailgate.....	133
Outside Temperature Display.....	100
Overheating.....	420

P

Paddle Shifters.....	
(Sequential Shift Mode).....	279
Pandora®.....	210
Panic Mode.....	141
Parking.....	332
Parking Brake.....	320
Parking Brake and Brake System.....	
Indicator.....	68, 424
Parking Sensor System.....	333
Passenger Airbag Off Indicator.....	50
Passing Indicators.....	149
Power Tailgate.....	135
Power Windows.....	142
Precautions While Driving.....	275
Driving Guidelines for Your Utility Vehicle.....	275
Rain.....	275
Pregnant Women.....	37
Puncture (Tire).....	397, 403

R

Radiator.....	361
Radio (AM/FM).....	200
Radio (SiriusXM®).....	202
Radio Data System (RDS).....	201
Range.....	101
RDS (Radio Data System).....	201
Readiness Codes (Emissions Testing).....	437
Rear Defogger/Heated Door Mirror.....	
Button.....	157
Rear Seat Heaters.....	181
Rear Seats (Folding Down).....	169
Rearview Mirror.....	161
Refueling.....	341
Fuel Gauge.....	95
Gasoline.....	341, 432
Low Fuel Indicator.....	71
Regulations.....	318, 379, 435
Remote Engine Start with Vehicle.....	
Feedback.....	272
Remote Transmitter.....	127
Replacement.....	
Battery.....	386, 387
Bulbs.....	365
Front Wiper Blade Rubber.....	372
Fuses.....	426, 427
Rear Wiper Blade Rubber.....	374
Tires.....	382
Reporting Safety Defects.....	436
Resetting a Trip Meter.....	100
Reverse Tilt Door Mirror.....	162

S

Safe Driving	25
Safety Check	30
Safety Labels	65
Safety Message	1
Seat Belts	31
Adjusting the Shoulder Anchor	35
Automatic Seat Belt Tensioners	33
Checking	38
Detachable Anchor	36
Fastening	34
Installing a Child Seat with a Lap/Shoulder Seat Belt	59
Pregnant Women	37
Reminder	32
Warning Indicator	32, 71
Seat Heaters	179
Seats	164
Adjusting	164
Front Seats	164
Lumbar Support	164
Rear Seats	169
Seat Heaters	179, 180, 181
Security System	139
Immobilizer System Indicator	76
Security System Alarm Indicator	77
SEL/RESET Button	96
Select Lever	16, 277
Operation	16, 278
Releasing	419
Won't Move	419
Selecting a Child Seat	56
Selector Knob (Audio)	192
Sequential Shift Mode	279
Setting the Clock	120
Shift Lever	16, 277
Shift Lever Position Indicator	70, 278
Shifting (Transmission)	277
Shoulder Anchor	35
Side Airbags	46
Side Curtain Airbags	48
SiriusXM® Radio	202
SMS Text Message	238, 250
Snow Tires	384
Spare Tire	397, 433
Spark Plugs	432
Specifications	432
Specified Fuel	341, 432
Speedometer	95
SRS Airbags (Airbags)	42
Starting the Engine	270
Does Not Start	414
Jump Starting	417
Remote Engine Start	272
Steering Wheel	160
Adjusting	160
Stopping	332
Summer Tires	384
Sunglasses Holder	178
Supplemental Restraint System (SRS)	42
Switches	
(Around the Steering Wheel)	4, 5, 146

Synchronized Mode	184
System Message Indicator	77

T

Tachometer	95
Tailgate	133
Unable to Open	430
Temperature	
Outside Temperature Display	100
Temperature Gauge	95
Temperature Sensor	100, 185
Temporary Tire Repair Kit	404
Text Message	238, 250
Time (Setting)	120
Tire Pressure Monitoring System (TPMS)	316
Indicator	75, 425
Tire Repair Kit	403
Tires	376
Air Pressure	377, 433
Checking and Maintaining	376
Inspection	376
Labeling	377
Puncture (Flat Tire)	397, 403
Regulations	379
Rotation	383
Spare Tire	397, 433
Summer	384
Temporary Tire Repair Kit	404
Tire Chains	384

Tire Repair Kit.....	403	Turn Signals	149	Warranties (Warranty Manual provided separately).....	439
Wear Indicators	381	Indicators (Instrument Panel)	75	Watts	432
Winter.....	384	Two-way Keyless Access		Wear Indicators (Tire).....	381
Tools	396	Remote.....	121, 129, 272	Wheel Nut Wrench (Jack Handle).....	400
Towing a Trailer	263	U		Window Washers	153
Equipment and Accessories.....	264	Unlocking the Doors	125	Adding/Refilling Fluid	364
Load Limits	263	Unlocking the Front Doors		Switch	153
Towing Your Vehicle	267	from the Inside	12, 130	Windows (Opening and Closing).....	142
Emergency.....	429	USB Adapter Cable.....	188	Windshield	153
TPMS		USB Flash Drives	223	Cleaning	392
(Tire Pressure Monitoring System).....	316	USB Port.....	189	Defrosting/Defogging	183
Indicator.....	75, 425	V		Washer Fluid.....	364
Transmission	277	Vanity Mirrors.....	7	Wiper Blades.....	372
Automatic	277	Vehicle Identification Number	434	Wipers and Washers	153
Fluid	362	Vehicle Stability Assist (VSA®).....	311	Winter Tires	384
Number	434	Off Button.....	312	Snow Tires.....	384
Sequential Shift Mode	279	Off Indicator.....	73	Tire Chains.....	384
Shift Lever Position Indicator	70, 278	System Indicator.....	73, 311	Wipers and Washers	153
Trip Meter	100	Viscosity (Oil)	355, 433	Automatic Intermittent Wipers.....	154
Troubleshooting	395	VSA® (Vehicle Stability Assist).....	311	Checking and Replacing Wiper Blades.....	372
Blown Fuse	426, 427	W		Front.....	153
Brake Pedal Vibrates	21	Wallpaper	196	Rear.....	155
Buzzer Sounds When Opening Door	22	Warning and Information Messages.....	84	WMA	204, 212
Emergency Towing	429	Warning Indicator On/Blinking	422	Worn Tires	376
Engine Won't Start	414	Warning Labels.....	65		
Noise When Braking	23				
Overheating.....	420				
Puncture/Flat Tire.....	397, 403				
Rear Door Won't Open	22, 131				
Select Lever Won't Move	419				
Warning Indicators	68				

